









S. 455.

A  
JOURNAL  
OF  
NATURAL PHILOSOPHY,  
*CHEMISTRY,*  
AND  
THE ARTS.

==  
VOL. XIX.  
==

*Illustrated with Engravings.*

---

---

BY WILLIAM NICHOLSON.

---

---

LONDON:

PRINTED BY W. STRATFORD, CROWN COURT, TEMPLE BAR, FOR

W. NICHOLSON,

CHARLOTTE STREET, BLOOMSBURY,

AND SOLD BY

J. STRATFORD, No. 112, HOLBORN-HILL.

---

1808.

# JOURNAL

OF THE

AMERICAN

PHYSICAL

AND

ASTRONOMICAL

PHYSICAL

AND

ASTRONOMICAL

1891



## PREFACE.

**T**HE Authors of Original Papers and Communications in the present Volume are, Mr. Charles Sylvester; J. S. Traill, M. D.; Mr. Richard Winter; Philommatos; A Chemist; J. G. C.; William Henry, M. D.; Thomas Thomson, M. D. F. R. S. E.; Mr. William Skrimshire, Jun.; John Gough Esq.; G. S. Gibbes, M. D.; N. R. D.; Joseph Reade, M. D.; Mr. Donovan; Mr. Barraud; Dytiscus; J. Garnett, Esq.; The Rev. T. Vince, Professor of Astronomy at Cambridge; and Frederick Stromeyer, M. D. Professor at Gottingen.

Of Foreign Works, M. La Lande; J. Carradori de Prato, M. D.; M. Decandolle; M. Trommsdorff; M. Bernhardt; M. Robiquet; M. Chevreul; M. C. A. Cadet; M. Vauquelin; M. Boullay; M. Hisinger; M. Berzelius; M. Thenard; Dr. Berger; Mr. Adolphus Ledhuy.

And of British Memoirs abridged or extracted, Mr. Davis; Humphry Davy, Esq. F. R. S. M. R. I. A.; William Hasledine Pepys, Esq.; Right Hon. Sir Joseph Banks, Bart, K. B. P. R. S. &c.; Thomas Andrew Knight, Esq. F. R. S.; Everard Home, Esq. F. R. S.; William Herschell, L. L. D. F. R. S.; William Allen, Esq. F. L. S.; John Jerome Schroeter, F. R. S.; Mr. Lewin Tugwell; Dr. Cogan; Mr. Robert Hallett; Brigade Major William Lambton; C. H. Parry, M. D.; T. Davis, Esq.; W. Matthews, Esq.; Dr. Anderson; Mr. Edward Martin; W. H. Wollaston, M. D.; and W. Roxburge, M. D.

The Engravings consist of 1. Guide to the Constellations; 2. Mr. Davis's Machine for Glaziers; 3. Mr. Davy's Experiments on Galvanism; 4. New Endiometer by W. H. Pepys, Esq.; 5. Experiments on inflected Light, by Mr. R. Winter; 6 and 7. Dr. Hershell on coloured concentric Rings; 8. Dr. Joseph Reade's Calorimeter; 9. Messrs. Allen and Pepys on Carbonic Acid, and the Diamond; 10. Mr. Barraud's Mercurial Pendulum; 11. Dr. Hershell on the Planet Vesta; 12. Mr. Tugwell's new Method of Roofing Houses; 13. Representation of a Mineral Bason in South Wales.

TABLE

# TABLE OF CONTENTS

## TO THIS NINETEENTH VOLUME.

JANUARY, 1808.

Engravings of the following Objects: 1. Guide to the Constellations; 2. Mr. Davis's Machine for Glaziers; 3. Mr. Davy's Experiments on Galvanism.	
I. An Account of the relative Situations of the different Stars, by which the principal Constellations may be distinguished. From la Lande's Astronomy, third Edition, Art. 743, &c.	Page 1
II. On the Advantages of Malleable Zinc, and the Purposes to which it may be applied. By Mr. Charles Sylvestre	11
III. Description of Mr. Davis's improved Machine for Painters and Glaziers	13
IV. Answer to some Observations of Mr. Dispan on the pretended Attraction of Surface between Oil and Water; by J. Carradori de Prato, M.D.	14
V. Abstract of an Essay on the Medicinal Properties of Plants compared with their external Form and natural Classifications: by Mr. Decandolle	17
VI. Analysis of the Siderite, or Lazulite; by Messrs. Trommsdorff and Bernhardt	20
VII. On the Preparation of pure Barytes; by Mr. Robiquet	23
VIII. Remark on the spontaneous Decomposition of the hidroguretted Sulphuret of Barytes: by Messrs. Robiquet and Chevreul	25
IX. Remark on a Property of Camphorated Water: by C. A. Cadet, Apothecary in ordinary to his Majesty	26
X. Report on a Memoir of Mr. Destouches, Apothecary at Paris; by Messrs. Vauquelin and Boullay. Read at the Parisian Society of Pharmacy, February 16, 1807	28
XI. Mineralogical Description and Chemical Analysis of a Stone, called Pyrophysalite: by Messrs. Hisinger and Berzelius	33
XII. On some Chemical Agencies of Electricity: by Humphrey Davy, Esq. F. R. S. M. R. I. A.	37
XIII. Memoir on the Analysis of the Sweat, the Acid it contains, and the Acids of the Urine and Milk; read to the National Institute by Mr. Thenard	63
XIV. Remarks on Orpiment and Realgar: by Mr. Thenard	74
Scientific News	78

FEBRUARY.

# CONTENTS.

FEBRUARY, 1808.

Engravings of the following Objects: 1. New Eudiometer, by W. H. Pepys, Esq.; 2. Experiments on inflected Light, by Mr. R. Winter: 3. Figures to illustrate the Formation of coloured concentric Rings, by Dr. W. Herschel.	
I. On Albinoes; by T. S. Traill, M. D.	81
II. Description of a new Eudiometer, accompanied with Experiments, elucidating its Application. By William Hasledine Pepys, Esq. Communicated by Charles Hatchett, Esq. F. R. S.	86
III. On the Revival of an obsolete Mode of managing Strawberries. By the Right Hon. Sir Joseph Banks, Bart, K. B. P. R. S. &c.	95
IV. On raising new and early Varieties of the Potato ( <i>Solanum Tuberosum</i> .) By Thomas Andrew Knight, Esq. F. R. S. &c.	97
V. An Account of two Children born with Cataracts in their Eyes, to show that their Sight was obscured in very different Degrees; with Experiments to determine the proportional Knowledge of Objects acquired by them immediately after the Cataracts were removed. By Everard Home, Esq. F. R. S.	99
VI. Experiments on various Species of Cinchona: by Mr. Vauquelin	106
VII. Experiments for investigating the Cause of the coloured concentric Rings, discovered by Sir Isaac Newton, between two Object-glasses laid upon one another. By William Herschel, LL.D. F. R. S.	121
VIII. A Method of finding the Specific Gravity of Light from Analogy; and the undulatory System defended by an Experiment on inflected Light. In a Letter from Mr. Richard Winter	143
IX. Account of an Accident from the sudden Deflagration of the Base of Potash. In a Letter from a Correspondent	146
X. Correction of some Misstatements in the Account of Mr. Davy's Decomposition of the fixed Alkalis. In a Letter from a Correspondent	147
XI. An Improvement in the Galvanic Trough, to prevent the Cement from being melted, when the Action is very powerful. Communicated by a Correspondent	148
XII. Experiments on the Fire-damp of Coal Mines, by William Henry, M. D.; including a Communication on the Subject from Thomas Thomson, M. D. F. R. S. E. Communicated by Dr. Henry	149
XIII. On the Phosphorescence of Bodies, from the Action of the Electric Explosion. In a Letter from Mr. William Skrimshire, Jun. to Mr. John Cuthbertson	153
XIV. Experiments on the Decomposition of the fixed Alkalis by Galvanism. In a Letter from Mr. Charles Sylvester	156
Scientific News	157

MARCH.

MARCH, 1808.

Engravings of the following Objects: 1. Figures to illustrate the Formation of coloured concentric Rings, by Dr. W. Herschel: 2. Dr. Joseph Reade's Calorimeter: 3. Messrs. Allen and Pepys on Carbonic Acid, and the Diamond.	
I. Remarks on Torpidity in Animals, in two Letters from John Gough, Esq.	161
II. On the Nonexistence of Oxygen and Hydrogen, as Bases of particular Gasses; the Action of Galvanism; and the compound Nature of the Matter of Heat. In a Letter from G. S. Gibbes, M. D.	170
III. Letter from N. R. D., containing some Remarks and Emendations of his Communication in the Number for January	173
IV. On the Advantages of grafting Walnut, Mulberry, and Chesnut Trees. By Thomas Andrew Knight, Esq. F. R. S. &c.	175
V. Experiments for investigating the Cause of the coloured concentric Rings, discovered by Sir Isaac Newton, between two Object-glasses laid upon one another. By William Herschel, L. L. D. F. R. S.	177
VI. Description of a newly-invented Calorimeter; with Experiments to prove, that an increased Capacity for Caloric accompanies an Increase of Temperature. By Joseph Reade, M. D.	197
VII. Experiments on the various Species of Cinchona; by M. Vauquelin	203
VIII. On the Quantity of Carbon in Carbonic Acid, and on the Nature of the Diamond. By William Allen, Esq. F. L. S. and William Hasledine Pepys, Esq. Communicated by Humphry Davy, Esq. Secretary R. S. M. R. I. A.	216
IX. Account of an extinct Volcano in Britain. Communicated by Mr. Donovan	237
Scientific News	240

APRIL, 1808.

Engravings of the following Objects: 1. Mr. Barraud's Mercurial Pendulum:	
2. Dr. Herschel on the Planet Vesta: 3. Mr. Tugwell's new Method of Roofing Houses.	
I. On the formation of the Bark of Trees. In a Letter from T. A. Knight, Esq. F. R. S. to the Right Honourable Sir Joseph Banks, K. B. P. R. S. &c	241
II. On the Economy of Bees. In a Letter from Thomas Andrew Knight, Esq. F. R. S. to the Right Honourable Sir Joseph Banks, Bart. K. B. P. R. S.	250
III. Description of a Mercurial Pendulum. Communicated by Mr. Barraud, of Cornhill, who has made several, and has been highly satisfied with their Performance in the Measure of Time	258
IV. Observations on the Nature of the new celestial Body discovered by Dr. Olbers, and of the Comet which was expected to appear last January in its Return from the Sun. By William Herschel, LL.D. F. R. S.	259
V. Observations and Measurements of the Planet Vesta. By John Jerome Schroeter, F. R. S.	264
VI. On a new Method of Slating, and constructing the Roofs of Houses: by Mr. Lewin Tugwell	266
VII. Heights of various Places in France, &c.; by Dr. Berger. Concluded from Vol. XVIII, p. 308	272
VIII. On the Cultivation of the Poppy. By T. Cogan, M. D.	282
IX. On the Use of Tobacco Water, in preserving Fruit Crops, by destroying Insects: and on the Use of the Striped or Ribband Grass. By Mr. Robert Hallett	298
X. A second Letter from Mr. Robert Hallett, on the Efficacy of Tobacco Water in destroying Insects, infesting Fruit Trees	301
XI. Remarks on a Pamphlet, lately published by the Rev. S. Vince, respecting the Cause of Gravitation. By a Correspondent.	304
XII. Farther Experiments and Observations on Potash and its Base. In a Letter from Mr. C. Sylvester	307
XIII. An Account of the Measurement of an Arc on the Meridian on the Coast of Coromandel, and the Length of a Degree deduced therefrom in the Latitude 12° 32', By Brigade Major William Lambton	309
Scientific News	317

## SUPPLEMENT TO VOL XIX.

Engraving of the following Object: Representation of a Mineral Basin in South Wales.	
I. Remarks on the total Eclipse of the Sun, June 16, 1806; with some new Methods of finding the Sun or Moon's Meridian Altitude, and the approximate Time, by Altitudes taken near the Time of Noon. In a Letter from J. Garnett, Esq. Editor of the American Nautical Almanack	321
II. An Inquiry into the Causes of the Decay of Wood, and the Means of preventing it. By C. H. Parry. M. D.	328
III. On the Blight in Wheat. By Mr. Thomas Davis, of Horningsham	338
IV. Answer to Remarks on a Pamphlet, lately published by the Rev. T. Vince, respecting the Cause of Gravitation. In a Letter from the Author	344
V. Observations on the Structure of the different Cavities, which constitute the Stomach of the Whale, compared with those of ruminating Animals, with a View to ascertain the Situation of the digestive Organ. By Everard Home, Esq. F. R. S.	348
VI. On Family Wine Making. By W. Mathews, Esq.	353
VII. Description of the Mineral Bason, in the Counties of Monmouth, Glamorgan, Brecon, Carmarthen, and Pembroke. By Mr. Edward Martin. Communicated by the Right Hon. C. F. Grenville, F. R. S.	361
VIII. On Fairy-Rings. By W. H. Wollaston, M. D. Sec. R. S.	367
IX. Account of a Musical Instrument, called an Organized Lyre, invented by Mr. Adolphus Lechuy, late Geometrical Surveyor of Forests, of Coucy-le-Chateau, in the Department of the Aisne	371
X. A Botanical and Economical Account of Bassia Butyracea, or the East India Butter Tree. By W. Roxburgh, M. D.	372
XI. Observations on Werner's Silex Schistosus Politorius, Polierschiefer, from Billin, in Bohemia	380
Scientific News	381



# Guide to the Constellations.

Fig. 2.  
Cassiopeia.

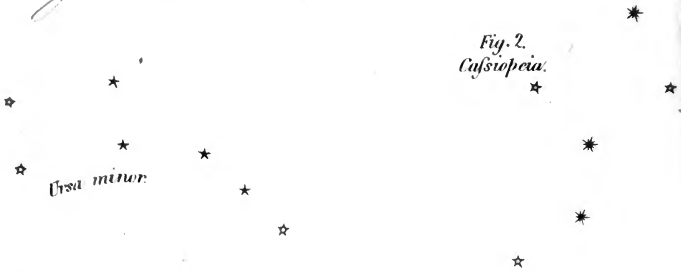

Ursa minor

Fig. 1.

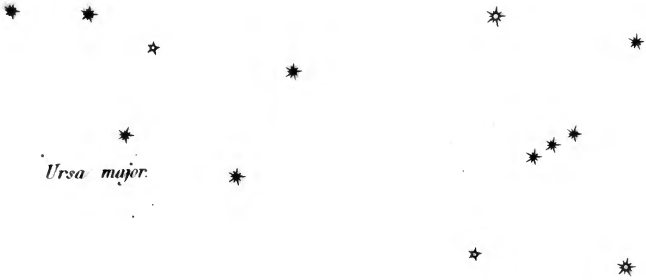

Ursa major.

Fig. 3.  
Orion

M. Davis's Machine for Glaziers.

Fig. 4.

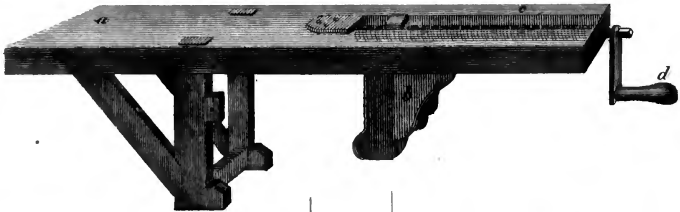

Fig. 6.

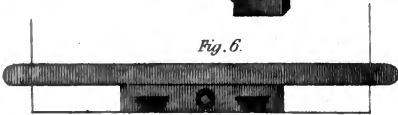
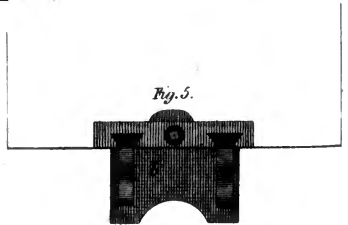

Fig. 5.





# JOURNAL

OF

NATURAL PHILOSOPHY, CHEMISTRY,

AND

THE ARTS.

---

---

JANUARY, 1808.

---

---

## ARTICLE I.

*An Account of the relative Situations of the different Stars, by which the principal Constellations may be distinguished. From LA LANDE'S Astronomy, third Edition, Art. 743, &c\*.*

THE great Bear is a constellation, which is always visible, it is easily known from the seven stars of which it consists (see Pl. I, Fig. 1). Four of them are in the body and three in the tail; and the two farthest from the tail  $\alpha$  and  $\zeta$  are called the pointers, because a line drawn from  $\zeta$  to  $\alpha$ , if produced, will pass on to the pole star, which is about as far from  $\alpha$  as  $\alpha$  is from  $\gamma$ . The convex side of the tail is turned toward the pole.

The constellations visible at all times. Ursa Major.

Cassiopeia is opposite to the great Bear, the polar star lying between them, so that if a line be drawn from  $\epsilon$  Ursa

Cassiopeia,

\* The following paper is a free translation of all that part of Mr. la Lande's work, which can be of most service to those, who have not the advantage of any astronomical instruments, by which they may measure angles, or take observations on the meridian. At the same time, however, that I endeavoured to render the meaning as precisely as I could, I thought myself at liberty to make any small alteration, which would more clearly point out the sense of the passage, or adapt it to the use of the English reader.

N. R. D.

Majoria

Majoris through the pole star, it will pass through the middle of Cassiopeia. This constellation consists of six or seven stars, which form a Y, or, as some describe it, a chair turned on its back. This description is by no means distinct, but there is little danger of any mistake; because several of these stars are of the second magnitude (Fig. 2).

Ursa Minor.

The little Bear is nearly of the same form as the great Bear, but the figures though parallel are reversed with respect to one another. The pole star is of the 3d magnitude at the extremity of the tail, the four next stars to it are only of the 4th magnitude; but the two last, which make up the square, are of the 3d, and are called the Guards. These last are in a line drawn through the centre of the great Bear, perpendicular to its longest side.

Arcturus.

Arcturus, a star of the first magnitude in Bootes, is distant  $31^{\circ}$  from the tail of the great Bear; and if a line be drawn through  $\zeta$  and  $\eta$ , the two stars at the extremity of the tail, it will point to Arcturus.

Lyra and Capella.

When the great Bear is on the meridian, Lyra and Capella, two stars of the first magnitude, are seen, one in the east, the other in the west, in a line drawn through the pole star, perpendicularly to that which joins the great Bear and Cassiopeia. Capella is to the east when the great Bear is under the pole; and then, if their altitude is the same, it is almost equal to that of the pole star.

Draco.

Draco is on the line drawn from  $\alpha$  Ursæ Majoris through the Guards of the little Bear, between which and Lyra may be observed the four stars in the shape of a lozenge, which form the head; the tail lies between the pole star and the body of the great Bear. The line through the Guards points to  $\eta$  Draconis, which is north of  $\theta$  and south of  $\zeta$  in the line, which is directed towards the pole of the ecliptic.

Cepheus.

This line produced a little farther towards  $\delta$  and  $\epsilon$  Draconis will pass between  $\beta$  and  $\alpha$  Cephei.

Cygnus.

The line drawn from the pole star to these two last mentioned stars in Cepheus will pass near to the tail of the Swan, which is a beautiful object, and never sinks below the horizon of London.

The constella-

Having now gone through those constellations, which are always

always above our horizon, we will next proceed to those, which are visible in a winter's evening.

tions visible in a winter's evening.

About 7 or 8 o'clock P. M. in the months of January and February, Orion is visible in the south. It consists of seven stars, four of which are at considerable distances from each other, and in the centre of them are three others of the 2d magnitude, which are much closer and in a straight line. This is a very remarkable constellation and may be easily recognised if compared with Fig. 3.

Orion.

The three bright stars in the belt of Orion point on one side to the Pleiades and on the other to Sirius. Sirius is the brightest of all the fixed stars, and is remarkable for its radiancy and brilliance: it lies on the south-east of Orion. The Pleiades are on the north-west of Orion, and form a group of small stars, which may be easily distinguished, as they lie a little above the line drawn through the three stars of the belt of Orion.

Pleiades and Sirius.

Aldebaran, or the Bull's eye, is a star of the first magnitude very near the Pleiades, and situated between them and  $\gamma$  the star in the western shoulder of Orion.

Aldebaran.

Procyon or Canis Minor is a star of the first magnitude, situated to the north of Sirius and the east of Orion: it makes nearly an equilateral triangle with Sirius and the belt of Orion.

Procyon.

The Twins are two stars of the second magnitude, situated about midway between Orion and the great Bear. They may also be distinguished by drawing a line from Rigel (which is  $\beta$  or that of the four outermost stars in Orion, which lies in the south-west) through  $\zeta$  the eastern star in the belt; since this will direct us to the heads of the Twins: and again if we draw a line from  $\zeta$  or  $\epsilon$  of Orion to  $\delta$  and  $\beta$  of the great Bear, it will pass over one of the paws of the Bear, and also by the heads of the Twins. This same line will cross the feet of the Twins, and will pass very near  $\alpha$ , the star in the eastern shoulder of Orion. The feet of the Twins are marked by four stars in a straight line perpendicular to the direction here given.

Gemini.

Rigel.

The line drawn from Rigel through  $\gamma$  in the western shoulder of Orion, will pass on the north through  $\zeta$  a star of the third magnitude, on the southern horn of Taurus: it

Taurus.

is about  $14^\circ$  from  $\gamma$  Orionis, or the same distance at which  $\gamma$  Orionis is from Rigel.  $\beta$ , the northern horn of the Bull, is also called the foot of Auriga, it is of the second magnitude, and in the line drawn from  $\alpha$  in the eastern shoulder of Orion through  $\zeta$  Tauri; the southern horn. The ecliptic passes between the two horns.

**Leo.** The Lion may be recognised by the same stars  $\alpha$  and  $\beta$  in the great Bear, which serve to point out the polar star. They are distant about  $45^\circ$  north of the Lion, which forms a large trapezium, in which there is a star of the first magnitude called Regulus, or Cor Leonis; it is in a line with Rigel and Procyon, but at the distance of  $37^\circ$  from the latter.  $\beta$  also, a star of the second magnitude in the Lion's tail, is a little on the south of a line drawn from Arcturus to Regulus: it is  $24^\circ$  to the east of Regulus, and makes an equilateral triangle with Spica Virginis and Arcturus.

**Regulus, or Cor Leonis.**

**Cancer.** Cancer is a constellation of small stars, which are distinguished with difficulty. The nebulous star in Cancer is less perceptible than the Pleiades, and we meet it nearly half way between the centre of Gemini and the Cor Leonis, or in the line which joins Procyon and the tail of the great Bear. From  $\epsilon$ , the middle star of the belt of Orion, there proceeds a train, which is called the Sword; it contains the Nebula. A line drawn through the Sword and the star  $\epsilon$  points towards  $\zeta$ , the southern horn of the Bull, and beyond it to the middle of Auriga.

**The Nebulous stars in Cancer and Orion.**

**Auriga.** Auriga forms an irregular pentagon, the most northern star of which is Capella: it is of the first magnitude, and may be found by drawing a line through  $\delta$  and  $\alpha$ , the two most northern stars in the body of the great Bear.

**Capella.**

**Aries.** Aries, the first of the twelve constellations in the Zodiac, consists principally of two stars of the first magnitude, situated near one another:  $\beta$ , the more western of the two, is accompanied by  $\gamma$ , of the 4th magnitude, which has been called the first star in Aries, because it was once the nearest star to the equinoctial point. This constellation is in the same line with Aldebaran and Procyon, from the former of which it is distant about  $35^\circ$ .

**Perseus.** The belt of Perseus consists of three stars, one of which is of the second magnitude. They form a curve with its

convex

convex side turned towards the great Bear. It might be sufficient to mention, that they lie in the line drawn from the pole star to the Pleiades; but they may also be found by producing a line through Gemini and Capella. The line drawn from the belt of Orion through Aldebaran passes through  $\beta$ , the head of Medusa, which Perseus holds in his hand: this star, which is also called Algol, is changeable.

The Swan is a very remarkable constellation: it forms a large cross, and contains a star of the second magnitude. A line drawn from Gemini through the polar star will meet the Swan at about an equal distance on the opposite side: at some seasons of the year they are both at the same time above the horizon. But we shall have another means of distinguishing this constellation, when we are acquainted with that of Pegasus.

The square of Pegasus is formed by four stars of the second magnitude: the most northern is the head of Andromeda. The line drawn from  $\alpha$  and  $\beta$  of the great Bear through the pole star will pass across the middle of these four stars. A line drawn from the belt of Orion through Aries will lead to the head of Andromeda: one drawn from the Pleiades through Aries will lead to  $\gamma$  in the wing of Pegasus: the other two stars are to the west; the northern is  $\beta$  and the southern  $\alpha$ .

The diagonal drawn through  $\gamma$  and  $\beta$  passes on north-west towards  $\alpha$  in the tail of the Swan: the other diagonal, drawn through  $\alpha$  and the head of Andromeda, points north-east to the belt of Perseus, having first passed  $\beta$  in the girdle, and  $\gamma$  near the foot of Andromeda: these two stars ( $\beta$  and  $\gamma$ ) are of the second magnitude, and divide the space between the head of Andromeda and the belt of Perseus into three equal parts. The line which connects them is at right angles to that which would join Aries and Cassiopeia.

The constellations visible in a summer's evening do not possess such strongly distinguishing characters as those, which we have just been describing: but a person who has made himself acquainted with those, which may be seen in winter,

The constellations visible in a summer's evening.

winter, will find that the knowledge of them will assist him very much in ascertaining the rest.

**Spica Virginis.** The middle star ( $\zeta$ ) in the tail of the great Bear is on the meridian over the pole star, about 9 o'clock in the latter end of May. Spica Virginis, a star of the first magnitude, will then appear on the meridian in the south at the altitude of about  $28^{\circ} 30'$ . The diagonal drawn through  $\alpha$  and  $\gamma$  in the great Bear will nearly pass through this star, although at the distance of  $68^{\circ}$ . Moreover Spica Virginis makes nearly an equilateral triangle with Arcturus and the Lion's tail, from which it is distant about  $35^{\circ}$ .

**Corvus.** At this time also the four principal stars in the Crow are a little to the right, below Spica Virginis. They form a trapezium, and are situated in the same line with Lyra and Spica Virginis.

**Hydra.** If from  $\delta$  and  $\gamma$ , the last stars in the square of the great Bear, a line be drawn through Regulus, it will meet, at the distance of  $22^{\circ}$  to the south, the star called Cor Hydræ. The head of the Hydra is to the south of Cancer, between Procyon and Regulus; but it is a little south of the line which joins them. This constellation extends from Canis Minor to the part of the heavens, which is situated below Spica Virginis and part of Libra. Between it and the Crow is the Cup.

**Crater.**

**Lyra.** Lyra, a star of the first magnitude, is one of the most brilliant in the whole heavens. The situation with respect to Arcturus and the pole star is such, as to make nearly a right angle to the east in Lyra.

**Corona Borealis.**

The Northern Crown is a small constellation, situated between Arcturus and Lyra: it is near Arcturus, and may be easily distinguished by the seven stars, of which it is composed; they are arranged in a semicircular form, and one of them ( $\alpha$ ) is of the second magnitude.  $\zeta$  and  $\eta$ , the two last stars in the tail of the great Bear, are in a line with the Crown.

**Aquila.**

The Eagle contains a very bright star of the second magnitude, which is in the south of the Lyre and the Swan. It is easily distinguished, because it is situated between  $\beta$  and  $\gamma$ , two stars of the third magnitude, which are very close and form a straight line with it.

The

The great circle, which passes through Regulus and Spica Scorpio. Virginis, is nearly the same with the ecliptic, and if it be produced to the eastward, it meets the Scorpion, a remarkable constellation on account of the four stars in its head, which form a large arch from N. to S. round Antares, or the Cor Scorpionis, which is placed as a centre to them. One of the four stars is of the 2d magnitude, and Antares is a bright star of the first magnitude.

The Balance contains two stars of the second magnitude, which form the two scales: the line which connects them is nearly perpendicular to that which may be drawn from Arc-turus to Antares, and they lie a little to the south of the middle of this line of direction. The southern scale is situated between Spica Virginis and Antares, and these three stars are all very nearly in the ecliptic. Spica Virginis is at the distance of  $21^{\circ}$ , and Antares at the distance of  $25^{\circ}$ , from the southern scale.

Sagittarius is a constellation, which follows the Scorpion, being a little to the east of it. It is in the line, which, passing through Spica Virginis and Antares, follows nearly the direction of the ecliptic: it contains several stars of the third magnitude, which form a large trapezium, two stars of which, together with two others, form a second trapezium, perpendicular as it were to the first. Sagittarius may be known by a line drawn through the middle of the Swan and Eagle: for it is  $35^{\circ}$  south of the Eagle, or nearly the same distance from it as the Eagle is from the Swan. Sagittarius may also be known by the diagonal drawn from the head of Andromeda to  $\alpha$  Pegasi, the same line, which produced towards the north points out the belt of Perseus.

The line drawn from Antares to the pole star passes through Ophiucus, or Serpentarius, and then through Hercules. It is rather difficult to know these constellations, and therefore they must be described more particularly. The line drawn from Antares to the Lyre passes near the head of Ophiucus, which is not far from that of Hercules, and lies to the south-east of it. They are marked by two stars of the second magnitude, and the line which connects them points to the Crown; it also passes through  $\gamma$  Herculis at the distance of  $13^{\circ}$  from the head of Hercules.  $\beta$  Herculis is at the distance

of

Ophiucus and Hercules. of  $3^\circ$  to the north-east of  $\gamma$ , the line drawn from it to  $\gamma$  points on the north to  $\epsilon$  Hercules, and on the south, or rather south-west, to  $\alpha$  Serpentis, which forms nearly an equilateral triangle with the head of Hercules and the Crown. The line drawn from the head of Ophiucus to the southern scale of the Balance passes through  $\delta$  and  $\epsilon$  Ophiuci, two stars of the third and fourth magnitudes, which are at the distance of only  $1^\circ 20'$  from one another, and in the line drawn perpendicular to that which was last described.  $\delta$  lies to the north-west of  $\epsilon$ , and these two stars point on the south-east towards  $\zeta$  in the western knee of Ophiucus, which is  $7\frac{1}{2}^\circ$  from  $\epsilon$ . This same direction will lead near to  $\eta$ , the star in the other knee of Ophiucus, which is about  $9\frac{1}{2}^\circ$  to the south east of  $\zeta$ . These same stars  $\delta$  and  $\epsilon$  point a little below  $\alpha$  Serpentis, and, if considered as one group, they would make nearly an equilateral triangle with  $\alpha$  Serpentis and  $\beta$  in the northern scale,  $4\frac{1}{2}^\circ$  north-west of  $\alpha$  Serpentis is  $\delta$ , and  $3^\circ$  south-east is  $\epsilon$  of the same constellation. The direction of these three stars is also towards  $\delta$  and  $\epsilon$  Ophiuci, which are  $11^\circ$  from  $\epsilon$  Serpentis.  $\beta$  and  $\gamma$ , the two stars in the eastern shoulder of Ophiucus, are in the line drawn from the head of Hercules to the head of Sagittarius: this line passes a little to the south-east of the head of Ophiucus.  $\beta$  is  $8^\circ$  and  $\gamma$   $11^\circ$  from the head of Ophiucus. A line drawn through them would pass between the two heads of Hercules and Ophiucus: the line connecting these two heads points to  $\theta$  at the extremity of the tail of the Serpent, which is  $22^\circ$  east of the head of Ophiucus. The line drawn from the most eastern stars in the Crown (which are on the side turned towards the Lyre) to  $\alpha$  Serpentis passes by the head of the Serpent, between  $\gamma$  and  $\beta$ , two stars of the third magnitude:  $\beta$  is the more western of the two. The western foot of Ophiucus lies between Antares and  $\beta$ , the northern star in the head of the Scorpion: the eastern leg is between Antares and  $\mu$  Sagittarii, which is the highest and most western star in the bow.

Capricorn.

Capricorn may be found by producing the line drawn from the Lyre to the Eagle: this line will pass through  $\alpha$  and  $\beta$  two stars of the third magnitude in the head of Capricorn. These stars are only  $2^\circ$  from one another. Farther



to the east by  $20^\circ$  are two other stars,  $\gamma$  and  $\delta$ , situated east and west about  $2^\circ$  asunder: they are in the tail of Capricorn.

Fomalhaut, or the mouth of the southern Fish, is a star of Fomalhaut the first magnitude, and is pointed out by a line drawn from Aquila to the tail of Capricorn. Fomalhaut lies about  $20^\circ$  to the south east of  $\delta$  Capricorni.

The Dolphin is a small constellation situated about  $15^\circ$  Delphinus east of the Eagle. It consists of a lozenge of four stars of the 3d magnitude. A line drawn from the Dolphin perpendicularly through the middle of  $\gamma$ ,  $\alpha$ , and  $\beta$ , the three stars in the Eagle, will pass through  $\theta$  in the extremity of the tail of the Serpent.

Aquarius is found by a line drawn from the Lyre through Aquarius the Dolphin, and carried on about  $30^\circ$ , which is as far beyond the Dolphin as the Dolphin is distant from the Lyre: Aquarius lies a little to the east of this line. A line drawn from the Dolphin to Fomalhaut will pass entirely across the constellation of Aquarius, and it will pass about midway between  $\alpha$  and  $\beta$ , two stars of the 3d magnitude, in the shoulders of Aquarius. They are the most remarkable stars in the whole constellation, and are about  $10^\circ$  distant from one another.

The Whale is a large constellation, situated on the south Cetus of Aries, and extending through a space, which is equal in length to the distance of the Pleiades from the four stars in Pegasus. A line drawn from the girdle of Andromeda, and passing between the two stars in Aries, will meet  $\alpha$ , a star in the mouth of the Whale, which is of the 3d magnitude, and  $25^\circ$  from the horns of Aries. A line drawn from Capella through the Pleiades will also pass south of  $\alpha$  Ceti. A line drawn from Aldebaran through the mouth of the Whale will pass through  $\beta$ , a star of the 2d magnitude in the tail:  $\beta$  is  $42^\circ$  west of  $\alpha$ , and very near the constellation of Aquarius. The square in Pegasus is alone sufficient to point out the Whale; for the line drawn through the two most southern of these stars passes between Aries and the knot of the Fishes, and will meet the head of the Whale: and the line drawn through the most eastern stars in the same square points to the tail. Between the head and the tail are situated  $\gamma$  and  $\delta$ , and between  $\delta$  and the tail is  $\sigma$ , a changeable star,

star, which is sometimes of the 2d magnitude, and sometimes quite invisible.  $\delta$  lies about half way between  $\alpha$  and  $\sigma$ .

**Pisces.**

The Fishes, which form the twelfth sign of the Zodiac, are not a very remarkable constellation. One of them lies on the south side of the square in Pegasus, under  $\alpha$  and  $\gamma$ ; the other is on the east of the square, and between the heads of Andromeda and of the Whale. The star  $\alpha$  in the knot of the string which joins the Fishes is of the 3d magnitude, and is the most remarkable star in the whole constellation: it is situated in the line which joins the head of Andromeda and  $\sigma$  the changeable star in the Whale; it is also in the line drawn from the feet of the Twins through Aldebaran and produced towards the west. This star ( $\alpha$  Piscium) is  $40^\circ$  west of Aldebaran, and makes a triangle with  $\alpha$  Ceti and  $\beta$  or  $\gamma$  Arietis, which is right angled at the star in the Fishes.

**Pole of the  
Ecliptic.**

We have now given an account of the principal constellations, from which the rest may easily be known with the assistance of a globe. But it may be necessary to add some directions for finding the pole of the Ecliptic, which is one of the most remarkable points in the heavens; and one, with which a person should be particularly acquainted, who wishes to become familiar with the heavenly bodies. It is situated in the constellation of Draco, in the same line with  $\gamma$  and  $\delta$ , the two stars in the great Bear, which are nearest to the tail; it makes almost an equilateral triangle with Lyra and  $\alpha$  Cygni; it is also in the line drawn from a point half way between the two eastern stars in the square of the great Bear, and produced through the middle of the guards of the little Bear  $3^\circ$  beyond  $\omega$  Draconis.  $\omega$  may be easily known, since it is nearly in the same line with the three stars of the same constellation, marked  $\theta$ ,  $\eta$  and  $\zeta$ , which are situated in the line drawn from Arcturus to Cepheus and Cassiopeia, that, passes between  $\delta$  and  $\epsilon$  Draconis on the opposite side of the pole of the Ecliptic.  $\delta$  and  $\epsilon$  are near to one another, and in a direction parallel to the tail of the little Bear, so as to point to the head of the Dragon. The middle star  $\eta$  is that, towards which the guards of the little Bear point. Lastly, the pole of the Ecliptic makes a right angled and isosceles triangle with the pole star and  $\beta$  Ursæ Minoris, which

which is the more northern of the guards; the right angle is at  $\beta$ .

The distances of some of the most remarkable fixed stars will give the reader a better idea of the magnitude of degrees, and are, therefore, added.

	°	'	"
Arcturus to $\eta$ Ursæ Majoris.....	30	29	0
The two outermost stars in the belt of			
Orion .....	2	44	0
The two stars in the shoulders of Orion	7	32	30
Capella to Castor ( $\alpha$ Geminorum) ..	30	0	0
Aldebaran to Sirius .....	45	53	20
———— to Capella .....	30	43	30
———— to the western shoulder of			
Orion .....	15	47	36
Sirius to Rigel ( $\beta$ Orionis) .....	23	40	0
Procyon to Regulus ( $\alpha$ Leonis) ....	37	20	0
———— to Rigel .....	38	27	30
Regulus to Spica Virginis .....	54	2	0
Arcturus to Spica Virginis .....	32	2	0
———— to Regulus.....	59	49	0
Spica Virginis to Antares .....	45	52	0
Antares to Arcturus .....	56	4	10
———— to Aquila .....	60	9	30
Lyra to Spica Virginis .....	87	46	0
———— to Aquila .....	34	9	0
———— to the tail of the Swan.....	23	52	0
The tail of the Lion ( $\beta$ ) to Spica Vir-			
ginis .....	35	2	10

N. R. D.

II.

*On the Advantages of Malleable Zinc, and the Purposes to which it may be applied. By Mr. CHARLES SYLVESTER.*

To Mr. NICHOLSON.

SIR,

AT the time I had some conversation with you on the subject of malleable zinc, I was not aware of all the advantages <sup>Of the uses of zinc.</sup> possessed

possessed by that metal, though I could fully speak to the facility with which it could be worked into vessels, and of its application to other purposes. I was still, for want of longer experience, not decided as to its changeability when exposed to the action of water and air.

Zinc might be supposed easily oxidable.

But it is not,

except superficially.

Less affected than copper by seawater.

Its superiority over lead or copper for various purposes.

General size of the sheets.

From the great affinity which zinc possesses for oxygen, it might be expected to oxidate with great avidity, and on that account be rendered useless in the situations above alluded to; but, to the astonishment of most theorists, the contrary proves to be the case. Many specimens of zinc, both in the state of sheets and wire, have been exposed in the open air, as well as in damp rooms, without undergoing any other change than that of colour. Indeed it appears, that a piece of polished zinc will lose its lustre, and assume a blue gray colour, when exposed in a damp room for the space of a few weeks. An oxide is formed upon the surface, which, though of an imperceptible thickness, is so exceedingly hard, and at the same time so insoluble, that it resists all the future attacks both of the air and of water. From numerous experiments I have ascertained, that copper is much more liable to waste than zinc in sea water, and even in strong solutions of muriate of soda. There cannot be therefore a doubt of its ready application to the sheathing of ships.

For the purposes of roofing houses, forming cisterns, pumps, pipes, &c., it possesses many advantages over lead and copper. In the first place it is equally durable with those metals, without possessing any of their deleterious effects. It is also capable of being lapped and soldered with the same facility as sheets of copper, lead, or tinned iron plates; and may be worked to advantage equally by the brazier, the plumber, and the tinman. Its little specific gravity, which is to that of lead as 7 to 11, compared with its greater strength, which is 15 times that of lead, gives it a decided advantage over that metal in point of price. Allowing the sheets of zinc to be only  $\frac{1}{7}$ th the thickness of lead, the zinc will come in at one third the price of that metal. Its advantage in a similar point of view over copper will not admit of a question.

The sheets are generally made 2 feet by 4, and can be rolled as thin as 6 ounces to the square foot.

Sheets

Sheets or wire of zinc may be purchased of Mr. Philip George of Bristol, or of Messrs. Harvy and Golden, 98, Houndsditch, London: Of whom may also be had, vessels and utensils of any form. They likewise undertake the roofing of houses, or sheathing vessels, with zinc.

By giving the above a place in your much esteemed Journal, you will much oblige

Your obedient servant,

CHARLES SYLVESTER.

P. S. I observed some time ago in your Journal, experiments by Mr. Davy on the subject of the production of the muriatic acid and fixed alkali by galvanism; in which some of my former experiments were alluded to. I do not think Mr. Davy is decisive on the subject, and have not a doubt of very soon confirming all that I have previously asserted.

Sheffield, Nov. 20, 1807.

### III.

#### *Description of Mr. DAVIS's improved Machine for Painters and Glaziers\*.*

THE frequent accidents which happen to painters and glaziers, from the unsteadiness of their machines, and the consequent misery brought upon their families, stimulated Mr. Joseph Davis, of the Crescent, Kingsland Road, to endeavour at their improvement. The result was the machine delineated in plate I, which may be made perfectly firm and secure, without occasioning any injury to the wainscoting or paint. In those cases however, where the bottoms of the windows are flush with the floor, as is usual in the best apartments of modern houses, neither the common machine, nor this with the improvement intended for general use, can be applied: but Mr. Davis has contrived an additional piece to be used on such occasions, which renders it equally secure.

Machine for preventing accidents to painters and glaziers.

\* From the Trans. of the Society of Arts for 1806, p. 138.

Fig.

Description of  
the painter's  
and glazier's  
machine.

Fig. 4, plate I, Represents the machine: the part *a* is similar to that used by glaziers, which is placed on the outside of the window. *b*, is an additional moving piece, which presses against the inside of the window frame, and is brought nearer to, or removed farther from it, by means of the male screw *c*, and its handle *d*.

Fig. 5, Shows the lower part of a window, and the manner in which the moving piece *b*, including a female screw, acts against the inside of the window frame.

Fig. 6, Shows a cross bar introduced in place of the moving piece last mentioned, which bar extends from one window side to the other, and explains how the machine may be used, where any injury might arise from screwing the moving piece in the centre of the recess of the window.

The general improvement consists in the use of a screw on that end of the frame which is within the house, and which keeps the machine steady and firm, instead of the two upright irons, which are put through holes made in the top plank of the machine, in the common mode, and which occasion the machine to be very unsteady in use, and liable to accident. There are two blocks marked *d, d*, in Fig. 4, which may be occasionally put in, or taken out, according as the stone work under the window may require.

#### IV.

*Answer to some Observations of Mr. Dispan on the pretended Attraction of Surface between Oil and Water: by J. CARADORI DE PRATO, M. D\*.*

Oil spreads on water from an attempt to preserve their level between two fluids of different gravities.

**M**R. Dispan, a celebrated professor of chemistry, imagines that the phenomenon of the spreading of oil on the surface of water arises simply from an effort of libration between two bodies of very different specific gravities, as oil and water are. "A drop of oil," says he, "falling on still water, is a sphere composed of extremely movable particles, disposed by its difference of gravity to yield the level to the water, and

\* Annales de Chimie, vol. LXII, p. 65, April, 1807.

consequently

consequently to apply itself to the whole surface in a very thin stratum. At the instant of its fall the drop of oil displaces a volume of water equal to its momentum. But presently, as the fluidity of the oil gives its particles the faculty of gliding one upon another, the reaction of the water having raised the drop, its particles, finding no obstacle, slide down on all sides with rapidity, till the whole is reduced to a very thin stratum. Thus in this fact there is nothing, that justifies the pretended affinity of surface between oil and water: on the contrary, instead of an application or reunion of surface, there is rather a division and a separation; since the drop of oil, which is spread upon the water, divides itself into an infinite number of others."

With all the respect due to the talents of the professor, it appears to me, that his explanation is strongly contradicted by the facts on which mine is founded. I have adduced several experiments, in two papers inserted in the Transactions of the Italian Society of Sciences, Vols. XI and XII, which show, that there is a *physical force*, by which the spreading of oil on water, and on other fluids, is determined. With these professor Dispan could not be acquainted, otherwise he would have refrained from giving his explanation of this phenomenon.

I would ask Mr. Dispan, how he accounts for the spreading of oil on water, when the drop is not let fall upon it, but cautiously applied, without making the least impression upon the water, so that no reaction is produced, that can overcome the affinity of aggregation of the oil. A drop so applied certainly spreads completely, and particularly if the water expose an extensive surface. It will be still more difficult for him to explain, how a drop of the milky juice of spurge, applied on water in the same manner, spreads over it in the twinkling of an eye, and covers it with a very thin pellicle; or even why a small quantity of wheat flour, or any other fecula, thrown on water, instead of falling to the bottom, spreads on its surface. There is no libration, no effort, no reaction of the water here. It appears to me, that these facts are much better explained by the principle I have established

This opposed by facts.

It is not necessary that the drop should fall, so as to cause reaction.

Juice of spurge spreads like oil.

Farinaceous powders to the same.

blished in the two papers abovementioned, than by the mechanical operation imagined by Mr. Dispan.

The oil collecting again into drops no argument.

I know well, that the drop of oil breaks, after it has spread upon the water, and that it collects into other very small drops: but this does not hinder the spreading of the oil from being occasioned by a force, which has compelled it to diffuse itself over the surface, and before acted for a moment.

That a subsequent drop does not spread, not owing to the resistance of the former, since it will not on a part free from oil.

But it is not true, that, if, after the spreading of the first drop, a second and a third be applied to the surface of the water, they do not spread like the first, because they find an obstacle to their movement, and to their gliding on the water, in the fragments of the drop of oil, which was before spread, and occupied its surface: for the phenomenon does not take place, though the drops be applied far from the space occupied by the diffusion of the first drop; and though the eye, assisted by a lens, have previously ascertained, that the surface of the water is free from every obstacle in the place to which the drop of oil is afterward applied.

Oil no obstacle to the spread of the juice of spurge, which impels it in a globule to one side;

I could prove to him likewise, that these obstacles are not sufficient to prevent the diffusion of fluids and other substances, that spread on water. Let a drop of oil spread over the surface of some water in a goblet, and when it has completely covered it, apply a drop of the juice of spurge; this fluid will diffuse itself over the surface with astonishing rapidity, though the surface is already occupied by the oil spread on it before, and, displacing the oil, will force it to accumulate in one or two drops against the side of the glass. It will be just the same, if, instead of the juice of spurge, a little flour be applied to the water; for this will equally spread over the surface of the water, and the oil will be obliged to unite into a single drop or globule, which will sink under the flour, that occupies the surface. What other reason for these phenomena can there be, than the force of adhesion between the surface of the water and these substances?

or of flour, which collects the oil in a globule under it.

Adhesion has some properties in common with chemical affinity.

Lastly I have to observe, that I never asserted there was any thing of chemical action in this phenomenon. I only said in my first paper on the attraction of surfaces, Vol. XI of the Italian Transactions, that the force which natural philosophers



sophers have distinguished by the name of adhesion has some properties in common with chemical attraction, such as the point of saturation, and elective affinity, and that hence it appeared to me, to be very properly termed attraction of surface.

I shall not hesitate however, to renounce the principle I have adopted, that of an attraction of surfaces, and retract the explanations of some interesting phenomena, which I have deduced from this principle, and given in the papers already mentioned, if convincing facts and just reasonings show me their incompetency.

V.

*Abstract of an Essay on the Medicinal Properties of Plants compared with their external Form and natural Classifications: by Mr. DECANDOLLE\*.*

NO branch of study deserves the name of science, till it is sufficiently advanced, to be able to determine facts a priori. The materia medica, which rests entirely on the basis of experience, has but three means of forming a judgment of the properties of substances; which are, their sensible qualities, their chemical composition, and their natural analogy. The object of Mr. Decandolle's work, which forms a quarto volume, is to ascertain how far the analogy of the forms of vegetables affords indications of their properties.

Indication of the virtues of drugs.

Camerarius first decidedly took up the affirmative side of this question in 1699. He was followed by Isenflam, Wilka, Gmelin, and more especially by Linneus and de Jussieu. On the other hand Vogel, Plaz, and Gleditsch wrote against it. Notwithstanding what has been written by these learned men, Mr. Decandolle has contrived to treat the question with some novelty, not only in consequence of the progress, that the study of natural affinities has made within these twenty or thirty years; but because, confining himself exclusively to no system, he has formed his deductions not from

Have plants similar in appearance similar virtues?

\* Annales de Chimie, Vol. LXI, p. 94, January, 1807.

a few solitary families, but from all that compose the vegetable kingdom.

Arguments for it.

He commences with establishing the general proofs, that the medicinal properties of plants are analogous to their external forms. In fact no one will question, that the properties of medicines depend on their physical constitution or chemical composition: but in organized bodies the nature of a production is determined by the form of the organs, since the same aliments, digested by different beings, afford different results; consequently the productions bear some relation to the forms. This reasoning is applicable to the vegetable kingdom, though its classification is not derived from the organs of nutrition, but from those of reproduction; for the natural classes deduced from one function necessarily agree with those deduced from another function.

Observations tending to confirm it.

These general inferences are confirmed by the observation, that herbivorous animals frequently avoid or seek all the plants of the same family: that those, which seem determined to feed only on a single plant, frequently submit to eat plants of the same genus, or of the same family: and that parasitic plants, particularly funguses, display the same preference for certain genera, or certain families. To this may be added, that several foreign drugs, which were formerly supposed to be the production of a single plant, have been found on inquiry to be furnished by several species of the same genus; and that with respect to indigenous simples it is no new thing, for species of the same genus to be substituted for each other. And we may observe, the narratives of travellers inform us, that plants of the same family are often employed for similar purposes in countries remote from each other.

Yet many exceptions.

Notwithstanding these assertions however, which the author supports by several examples, it cannot be denied, that vegetables very closely allied present very striking anomalies. In order to estimate the real weight of these, the author takes a review of the rules of comparison between forms and properties, and this is the part of his work that displays most novelty.

Resemblance in some families of plants

1. In the first place he observes, that, though we arrange species under genera, genera under families, and families under

der classes, in a uniform manner, the groups are far from being separated from each other in an equal degree. Thus in certain families plants differ from each other by slight modifications only, while in others they are distinguished by more important characteristics. The analogy between their properties may be presumed to be proportional to the analogy of their structure.

closer than others.

2. Secondly, it is contrary to the spirit of the method, to compare the properties of a given organ, or a given juice, with those of another organ, or another juice. This however is one of the most frequent causes, that have led to mistakes on the question. In this discussion the author introduces by the way some new views respecting the structure of bulbs, the body of which he proves to be in reality an abortive stalk, and not a root.

Similar organs only and similar juices should be compared.

3. The circumstances of the age of a plant, the season in which it is gathered, the soil in which it has grown, and the degree of light to which it has been exposed, are so many causes of error, that are to be avoided in the comparison.

Adventitious circumstances should be similar.

4. Unequal mixtures or unequal combinations of different principles are found in the organs or juices of certain families; and in these families several of the most apparent anomalies occur.

Principles sometimes unequally mixed or combined.

5. In the comparison of properties, we should pay attention to the difference that may exist in the mode of extracting and preparing a drug; for these circumstances frequently have as much influence on their properties as their intrinsic nature.

Modes of preparation alter properties.

6. We should exclude from the comparison the mechanical or accidental properties, that arise from circumstances independent of the true nature of substances.

Accidental qualities must be excluded.

7. Above all we should most scrupulously attend not to the result of the application of a medicine, but to its mode of acting; for medicines similar in reality act differently according to the organ to which they are applied, or the case in which they are administered, and the contrary.

Not the particular result but general mode of action to be regarded.

After laying down these principles the author takes a view of all the families, that compose the vegetable kingdom; and details the properties of all the plants that belong to them,

Mr D's work a complete view of the properties of vegetables.

Of 76 families analogy little violated in 46, and not at all in 23.

including not only those that are admitted into our European Pharmacopœias, but those that are employed medicinally by the inhabitants of any part of the globe. In this respect Mr. Decandolle's work gives a complete and methodical display of the properties of vegetables: and the result of this exhibition is, that, of seventy-six families, the properties of which are known, there are thirty-seven where the law of analogy is violated, twenty-three where it is completely preserved, and forty-six in which it is observable with a small number of exceptions.

## VI.

*Analysis of the Siderite, or Lazulite; by Messrs. TROMMSDORFF and BERNHARDI\*.*

Lazulite of Stiria.

THE lazulite was found at first near Waldbach, in Stiria, and afterward in the environs of Wienerisch-Neustadt. It is sufficiently known from the works of various mineralogists. Some time after a mineral was discovered in the country of Salzburg, which was called mollite; but baron Moll has given it the name of siderite, on account of its acknowledged identity with this fossil according to the researches of Mr. Mohs.

Analysed by Klaproth,

Though Klaproth found in the lazulite of Vorau silex, alumine, and iron, he could not ascertain their proportions, from the smallness of the quantity he had to examine. An analysis of the siderite by Heim gave 0.65 alumine, and 0.30 iron.

and by Heim.

Little analogous to feldtspar.

It is strange, that Messrs. Klaproth, Estner, and Mohs, should fancy there was a great analogy between the lazulite and feldtspar, as analysis shows this analogy to be very slight; and that between their crystallizations and contexture is equally so.

Its usual form.

The most usual form of the lazulite is a regular octaedron with truncated edges, passing to the regular rhomboidal

\* Annales de Chimie, Vol. LXII, p. 43, April, 1807. Abridged from Gehlen's Journal by Mr. Vogel.

dodecaedron

dodecaedron. The faces of the octaedron make an angle of  $109^{\circ} 28' 16''$ : those of the dodecaedron an angle of  $120^{\circ}$ : and the former cut these at an angle of  $144^{\circ} 44' 8''$ . Beside these several smaller faces were observed, which were not easy to determine, because the specimens were not very distinct.

It is not uncommon to meet with flattened quadrilateral prisms, the faces of which form angles of  $101^{\circ} 32'$  and  $78^{\circ} 28'$ ; angles that occur in several minerals, particularly in the calcareous spar. At the extremities of these prisms were faces in greater or less number, which we could not ascertain.

As to its contexture, we could not find it split decisively in any direction.

With respect to its crystallization it can be compared only with the spinelle, with which Mr. Haüy classes the ceylanite or pleonast. As analysis informs us too, that it resembles it in its constituent parts, we must consider them as similar.

The following is a comparative analysis of them.

	Of the spinelle by Vauquelin.	Of the spinelle by Klaproth.	Of the ceylanite by Collet-Descotils.	Of the siderite by Trommsdorff.	
Alumine .....	86.0	82.47	74.5	68	Comparative analysis.
Magnesia .....	8.5	8.78	8.25	12	
Silex .....			15.5	2	
Lime .....			0.75	2	
Oxide of iron ..			1.5	16	
Oxide of chrome	5.25	6.18		2.5	

We find that alumine united with magnesia must be considered as the essential part of the mineral.

As Mr. Bernhardt took upon himself to describe the characters of the lazulite, Mr. Trommsdorff attended more particularly to the analysis. He proceeded as follows.

A. A hundred grains of siderite strongly calcined in a covered crucible lost 5 grains of their weight. The fine blue colour had disappeared, and was changed to a yellowish white.

Its analysis.

Calcined.

B. The

Treated with  
soda.

B. The calcined mineral was easily ground, and did not scratch the agate mortar. One hundred grains were urged to a red heat with 400 of caustic soda; and after a pasty fusion there remained a mass, which, diffused in water, afforded a turbid solution void of colour. This was supersaturated with muriatic acid; evaporated and redissolved in boiling water; when silex was precipitated from it, which weighed 10 grains after calcination.

Silix precipi-  
tated.

C. The boiling liquor was precipitated by carbonate of soda.

No glutine or  
yttria.

D. The precipitate, containing neither glucine nor yttria, was boiled in a lixivium of caustic soda, which effected a partial solution. The spongy, insoluble, brownish red residuum was set apart.

Lixivium satu-  
rated with mu-  
riatic acid, and  
alumine separ-  
ated.

E. The soda lixivium (D) was supersaturated with muriatic acid, and the boiling liquor precipitated by carbonate of soda. The white precipitate, after sufficient elutriation, and being strongly calcined, left 66 grains of pure alumine.

Lime.

F. The reddish brown residuum (D) dissolved entirely in muriatic acid. The solution was concentrated, and the excess of muriatic acid saturated with ammonia. A little concentrated sulphuric acid was then poured in, which threw down a white precipitate. This was washed several times in cold water, and calcined, after which 6 grains of sulphate of lime, being equivalent to 2 grains of lime, remained.

Oxide of iron.

G. Into the liquor from which the lime had been precipitated prussiate of potash was poured, and the precipitate produced contained 2.5 grains of oxide of iron.

Magnesia.

H. The liquor decanted from the prussiate of potash was mixed with carbonate of soda, and kept some time boiling. A white substance fell down, which, after calcination, consisted of 18 grains of magnesia.

Its component  
parts.

One hundred grains of the calcined fossil therefore contained

Silex .....	10	(B)
Alumine .....	66	(E)
Magnesia .....	18	(H)
Lime.....	2	(F)
Oxide of Iron ..	2.5	(G.)
Loss .....	1.5	
	<hr/>	
	100	

The blue colour of the fossil appears to be owing to the degree of oxidation of the iron; and this is so much the more probable, as Mr. Ritter has announced the existence of a blue oxide of iron.

Blue colour  
owing to an  
oxide of iron.

It is true Mr. Guyton has discovered also a blue sulphuret of iron, to which he ascribes the colour of lapis lazuli: but in this case perhaps the sulphur may serve to produce this minimum of oxidation. Besides, direct experiments on the lazulite have convinced the author of this memoir, that it does not contain the least trace of sulphur or sulphuric acid.

Not a sulphu-  
ret as Guyton  
supposed.

## VII.

*On the Preparation of pure Barytes: by Mr. ROBIQUET\*.*

IN a note inserted in No. 183 of the *Annales de Chimie*, [see *Journal No. 76*, p. 66], on the decomposition of acetate of barytes by means of soda, Mr. d'Arcet points out as a more economical and certain process for procuring pure barytes, to decompose any barytic salt, particularly the muriate, by a caustic alkali. I conceive however, that the preference he gives to this process over that more generally employed, namely the decomposition of the nitrate by means of heat, is not well founded.

Mr. d'Arcet's  
process for ob-  
taining pure  
barytes not  
preferable to  
the common.

If we consider the subject in an economical view, we find in both cases a soluble barytic salt is first to be formed: that in the first case we cannot employ liquors sufficiently concentrated, to prevent any barytes from remaining in a state of solution: that whatever precaution we take in preparing the caustic alkali by means of lime, a portion will always become carbonated, were it only during the processes of filtration; consequently there will be so much to be deducted from the quantity of barytes that might have been obtained: that besides, as the liquor must be shaken during the precipitation, a certain portion will then become carbonated: that a loss is occasioned by the washing likewise: and lastly, that

Comparison of  
them.

Losses in his  
way.

\* *Annales de Chimie*, Vol. LXII, p. 61, April, 1807.

a great

a great deal more becomes carbonated by dissolving it afresh in boiling water. It is obvious, that all these deductions taken together will amount to a considerable sum, while in the decomposition of the nitrate we obtain the whole of the quantity it contained, which amounts to nearly half the weight of the dry salt; and that besides this process is neither difficult nor expensive, to those who know how to conduct it properly. The following are the precautions to be taken, to ensure its success.

None in the other.]

Process for decomposing the nitrate.

Let a covered crucible be nearly two thirds filled with dry and powdered nitrate of barytes, and placed in a common furnace, heated moderately so as to cause the salt to dissolve in its own water of crystallization. Increase the fire gradually, and with caution, on account of the considerable tumefaction that takes place toward the end. When the mass, which ought then to be of a cherry red, no longer emits any bubbles, cover the crucible with charcoal to the depth of an inch or two; fit on the furnace its dome, furnished with a plate iron chimney; let it heat thus for a quarter of an hour; and afterward withdraw the crucible from the fire, break it, and put the barytes into a close vessel as quickly as possible.

7lbs. produced  
3lbs 6oz. of  
pure barytes.

In this way I lately treated seven pounds of nitrate, which I divided into three common crucibles, and placed in the same furnace. The charcoal expended cost about 30s. [1s. 3d.]; the decomposition was completely effected in two hours; and I obtained 3lbs. 6oz. of perfectly pure barytes. But it is to be observed, that, if the barytes be kept too long in the fire after the nitrate is decomposed, it will become considerably carbonated: and if the quantity be at all too great, it is impossible, whatever heat we afterward employ, to deprive it completely of carbonic acid. This is the whole of the difficulty, which is completely removed, by acting as I have directed.

Necessary caution.

Advantages of this mode.

Thus I conceive it is in reality more economical, to extract the barytes from the nitrate by the help of fire, than to follow the process proposed by Mr. d'Arcet: for even supposing the barytes to be equal in quantity by both processes, which I have shown cannot be the case, the price of the potash I must have employed would have nearly doubled the



the expense. And as to the purity of the product, since the washing must be performed very sparingly, I do not see, that the process of Mr. d'Arcet deserves the preference in this respect: for it is probable, that the barytes thus obtained will retain a little of the salt of the mother water; and on the contrary, that obtained from the nitrate is extremely pure, at least if the precaution be taken, before it is decomposed, to calcine it slightly, and redissolve it, in order to separate a portion of iron proceeding from the sulphate employed.

## VIII.

*Remark on the spontaneous Decomposition of the hidroguretted Sulphuret of Barytes: by Messrs. ROBIQUET and CHEVREUL\*.*

**I**N the course of last month, Mr. Robiquet, in order to separate some crystals, that had formed in a phial half filled with hidroguretted sulphuret of barytes, turned it upside down, without uncorking it. Some days after, the weather having grown colder, the liquor afforded some tolerably large crystals, which were of a very different figure from those, that remained at the bottom of the phial. We have examined these two substances together, and the following are the results of our observations.

1. The first crystals were elongated prisms. On the application of sulphuric acid they gave out sulphurous acid gas, and at the same time let fall sulphur mixed with sulphate of barytes. Hence there could be no doubt, that they were sulphuretted sulphite of barytes.

2. The mother water, in which the second crystals had formed, was colourless and very limpid. It retained neither sulphur nor sulphurous acid; had all the characters of a simple solution of barytes in water; and the crystals comported themselves as the crystals of that earth. They dissolved in weak muriatic acid without effervescence, and in

\* Annales de Chimie, vol. LXII, p. 180, May, 1807.

water without leaving any residuum. The latter solution yielded a precipitate both with sulphuric and with carbonic acid.

Occasioned by the oxygen in the phial.

From these observations it was easy to explain the separation of the hidroguretted sulphuret of barytes into pure barytes and sulphuretted sulphite. The oxygen contained in the phial, being absorbed by the sulphuret, formed water and sulphurous acid: but the quantity of oxygen being insufficient, to convert all the sulphuret into sulphite, the consequence was, that the portion of sulphite which was formed sulphuretted itself at the expense of the undecomposed sulphuret, and left its base free. The sulphuretted sulphite, being less soluble than the barytes, of course crystallized first.

Hidroguretted sulphurets, absorbing oxygen gas, always form sulphites. Sulphite of barytes takes sulphur from barytes.

Hence we conclude, that the absorption of oxygen gas by hidroguretted sulphurets never produces immediately a sulphate, but a sulphite, notwithstanding the great affinity of the base for sulphuric acid; as Mr. Berthollet has explained in his Memoir on sulphuretted hidrogen: and that the affinity of sulphite of barytes for sulphur is greater, than that of barytes for the same substance.

## IX.

*Remark on a Property of Camphorated Water: by C. A. CADET, Apothecary in ordinary to his Majesty\*.*

Carbonic acid said to promote the solution of camphor in water.

**A** Surgeon at Madrid announced three years ago, that carbonic acid promoted the solution of camphor in water, and that this water had very decided medicinal properties in disorders of the bladder. Leaving to the physician to determine the value of the medicine, I have attempted merely to confirm the chemical fact.

Water alone dissolved  $\frac{1}{8}$  of aerated water only  $\frac{1}{100}$ .

For this purpose I made a solution of camphor in distilled water, and another in water saturated with carbonic acid after Mr. Paul's method, in order to compare the quantities of camphor dissolved. I weighed the camphor before and

\* Annales de Chimie, vol. LXII, p. 132, May, 1807.

after

after solution, and I found, that the distilled water had taken up sixteen grains per quart, and the carbonic acid only fifteen. As I had been obliged to filter the liquors and dry the filters, I imagined, that the undissolved camphor must have lost some of its weight by evaporation, and that the balance did not give me the precise quantity absorbed by the water. Accordingly I sought for a reagent, that should acquaint me with the presence of camphor in water.

Perhaps an error from evaporation in drying.

Potash I found would precipitate camphorated water, while neither soda nor ammonia rendered it at all turbid. But the potash must be pure and caustic. If it contain carbonic acid it no longer precipitates the camphor: and if, after it has been precipitated, the vessel be left exposed to the air, the liquid recovers its transparency by absorbing carbonic acid.

Pure potash precipitates camphor from water, but no other alkali does.

Here then we have a new method of distinguishing potash from soda. Camphorated water is in this respect a more certain test than the nitromuriate of platina, and more easily procured. The metallic salt however is more commodious, as it precipitates the carbonate of potash,

This a new test to distinguish potash from soda.

When employing caustic potash as a test of camphorated water impregnated with carbonic acid, I obtained no precipitate but by adding a great excess of alkali; and this precipitate did not appear to me more considerable, than that obtained in distilled water. I think therefore, that carbonic acid does not in any sensible degree promote the solution of camphor in water: and it follows at least from these experiments, that water does not impregnate itself with the aroma of the camphor solely, as some chemists have believed, but that it dissolves a sufficient proportion of this concrete volatile oil for the purposes of which it is employed.

Pure potash in excess precipitates it if carbonic acid be present.

If the camphor be reduced to a state of extreme division by trituration with a few drops of alcohol, the water will take up more than sixteen grains per quart: some chemists have dissolved as far as thirty grains.

If the camphor be divided by alcohol 1 qt. will take up 30 grains.

## X.

*Report on a Memoir of Mr. DESTOUCHES, Apothecary at Paris; by Messrs. VAUQUELIN and BOULLAY, Read at the Parisian Society of Pharmacy, Feb. 16, 1807\*.*

THE paper, on which these gentlemen were appointed to make a report, was entitled, a Memoir on the Tartrite of Lime contained in the Tartarous Acidule.

In preparing tartarised natron very little tartrite of lime found. Preparing Rochelle salt in quantity, Mr. Destouches was desirous of collecting the tartrite of lime, that separates from cream of tartar at the moment of its saturation, in order to turn it to account: but he was very much surprised not to obtain more than two pounds of precipitate at farthest from about three hundred of cream of tartar, that he had used, instead of ten times that quantity, which he had reason to expect from the observations of Mr. Vauquelin,

Repeated with the same effect. The same process repeated afforded Mr. Destouches but a very slight precipitate, which, confirming the former, induced him to make the following experiments.

Exp. 1. About 10 oz. of cream of tartar gave 1 dr. of tartrite of lime. 1st. To a boiling solution of eight ounces of crystallized carbonate of soda he added cream of tartar to the point of saturation, without any precipitate being produced: but after the solution had stood twenty-four hours, a number of silky crystals were deposited, which when separated weighed five drachms. These crystals, being mixed with an excess of acidulous tartrite of potash, were reduced to one drachm by washing with boiling water.

Exp. 2. Apparently but 18 grs. 2d. A fresh experiment, made with the cream of tartar employed in the operations in the large way, afforded but two drachms of precipitate, which were reduced to eighteen grains by washing with boiling water.

Tartarised natron promotes the solution of tartrite of lime by boiling, but it falls down on standing. Surprised by these results, Mr. Destouches conceived, that the tartrite of lime might be dissolved by the Rochelle salt, which prevented it from separating readily. In consequence he boiled a pound of Rochelle salt and two ounces of tartrite of lime in two quarts of water, when three drachms

\* Annales de Chimie, vol. LXII, p. 33. April, 18. 7.

of the calcareous salt were dissolved; but, after standing two days, the whole was deposited in a needly form, so as not to show an atom of lime on the addition of oxalate of ammonia.

Whence could arise this difference in the quantity of tartrite of lime in different parcels of cream of tartar, which, according to Mr. Destouches, was  $\frac{1}{80}$  in the first experiment, and  $\frac{1}{300}$  in the second?

To account for this fact, and ascertain whether, if the acidulous tartrite of potash contained little or no tartrite of lime, it might acquire some in the process of purification, the author boiled two ounces of tartrite of lime and eight of cream of tartar in eight quarts of water. In this process the latter retained  $\frac{1}{10}$  of its weight of the former.

Mr. Destouches farther satisfied himself of the proportion in which the tartrite of lime unites with boiling water.

Lastly, he concluded from his experiments:

1st, That the quantity of tartrite of lime in cream of tartar is liable to vary from the smallest quantity to seven per cent.

2dly, That tartrite of lime is soluble in six hundred parts of boiling water; and that it is susceptible of a regular crystallization by being dissolved in a soluble tartrite.

3dly, That, in making Rochelle salt, the solution should be suffered to cool, in order to deprive it of tartrite of lime.

4thly, That the carbonate of soda affords the most simple means of analysing cream of tartar with respect to tartrite of lime\*.

*Experiments and reflections by the commissioners.*

1. Six parcels of cream of tartar of the shops, bought at different places, were numbered. A hundred drachms of each, saturated hot with a solution of pure carbonate of soda, exhibited towards the end of the saturation a greater or less quantity of precipitate, which separated spontaneously, but only toward the end of the combination. The solutions, filtered separately, as soon as they were cooled, left on the filter a substance, part of which was crystalline, part pulverulent, in the following proportions.

Supertartrite of potash takes up  $\frac{1}{6}$  of tartrite of lime by boiling them together.

General conclusions.

The calcareous salt variable.

Soluble in 600 parts of boiling water.

In making tartarised natron the solution should be suffered to cool.

Carbonate of soda a test of lime in cream of tartar.

Experiments by Vauquelin and Boullay.

Six parcels of cream of tartar left different proportions of tartrite of lime.

Cream

\* See page 22.

	drach.	grs.		drach.	grs.
Cream of tartar, No. 1	—	3	No. 4	—	3 9
	2	— 3 36		5	— 3 16
	3	— 3 4		6	— 2 40

From 2.5 to 3.5 per cent.

More left in solution.

A larger proportion obtained by cold solution.

Tartarised nitrogen took up some in boiling.

Mr. Destouches deceived.

Analysed differently.

These different precipitates, which varied from two and half to three and half per cent, were composed of almost pure tartrate of lime, soluble, as Mr. Destouches observed, in about six hundred parts of boiling water. The solutions of the six sorts of Rochelle salt formed, being too dilute for crystallization, were left to stand for six days. They afforded fresh quantities of tartrate of lime, which we did not weigh, because the supernatant liquors still afforded a very sensible precipitate with oxalate of ammonia.

2. A similar quantity of the cream of tartar No. 6, which had afforded the least portion of tartrate of lime in the preceding experiment, was triturated cold with an excess of carbonate of soda and a little water. Being afterward diluted with a sufficient quantity of water to dissolve all the Rochelle salt formed, it left a residuum of a pulverulent, insipid matter, a little yellowish, which, when washed and dried, weighed four drachms and twenty grains. The solution of Rochelle salt formed in this operation was still precipitable by oxalate of ammonia, even after five or six days.

3. A pound of distilled water, boiled with four ounces of Rochelle salt, and a drachm of calcareous tartrate, dissolved about twenty grains of the latter, the greater part of which crystallized on cooling; but the liquor examined at the expiration of six days still afforded unequivocal signs of the presence of a salt with a calcareous basis.

This very great difference between our results and those announced by Mr. Destouches, the much greater proportion of tartrate of lime which we obtained, and the presence of this salt in the solutions and mother waters, clearly pointed out to us, that, deceived by appearances, he did not carry his researches far enough.

In consequence, without regarding the preparation of Rochelle salt, and to find precisely the quantity of tartrate of lime contained in the specimens of cream of tartar we had tried,

tried, we proceeded in the following manner. A thousand <sup>1000</sup>grs. grains of each parcel, heated alternately in a platina crucible, to dry them without producing any other alteration, lost equally eighteen grains. The heat being increased, till the complete extrication of the vapours, that announced the decomposition of the tartarous acid, was accomplished, a bulky coal remained, of the weight of four hundred and <sup>left 450 of coal,</sup> twenty-six or four hundred and thirty grains.

Each coally residuum was diffused in eight ounces of distilled water, saturated with muriatic acid, of which a slight excess was added, and then filtered. Into each of the liquors, containing the muriates of lime and potash, a solution of carbonate of soda was poured gradually, till no precipitate was formed by it. <sup>Dissolved in dilute muriatic acid, and precipitated by carbonate of soda.</sup>

The precipitates, being collected on dried filters of a known weight, were washed, and afterward exposed for twelve hours in a stove kept at a temperature of 40° or 45° R. [from <sup>Precipitated carbonate of lime from 32 to 42</sup>grs, 122° to 133° F.]. They were then carbonate of lime in the following proportions.

	grs.		grs.		grs.
No. 1	— 33	No. 3	— 32	No. 5	— 38
2	— 42	4	— 39	6	— 32

The weight of these carbonates of lime being known, it remained for us, in order to attain a complete solution of the question, to reduce them to pure lime, and to learn afterward in what proportion this same lime entered into the calcareous tartrite to form its basis. With this view we proceeded as follows.

1. A hundred grains of our calcareous carbonates strongly calcined left fifty-four of lime in a caustic state, mixed with a little oxide of iron in too small a proportion to be calculated. <sup>Carbonate of lime contains .54 of base,</sup>

2. A hundred grains of tartrite of lime, heated very strongly in the same manner, gave thirty-five grains of a residuum, that did not effervesce, and was found to be pure lime. <sup>Tartrite of lime contains .35.</sup>

The first of these two experiments demonstrates, that lime constitutes fifty-four hundredth parts of calcareous carbonate. The second, that the base of tartrite of lime forms <sup>thirty-</sup>

thirty-five hundredth parts of the whole. Consequently the specimens of cream of tartar, which were the object of our inquiries, contained the following quantities of lime;

	grs.		grs.		grs.	
Proportions of lime in the cream of tartar:	No. 1 — 17·82,	No. 3 — 17·28,	No. 5 — 20·52,			
	2 — 21·68,	4 — 21·06,	6 — 17·28:			

and therefore of tartrite of lime;

	grs.		grs.		grs.	
and hence of tartrite.	No. 1 — 50·91,	No. 3 — 49·37,	No. 5 — 58·63,			
	2 — 61·94,	4 — 60·17,	6 — 49·37.			

General infer-  
ences.

From all these facts we conclude:

Proportion of  
tartrite of lime  
from ·05 to ·07.

1st. That it is true, that the quantity of tartrite of lime varies in different parcels of cream of tartar to be met with in the shops: but that this variation does not exceed from five to seven per cent, at least in those we had an opportunity of examining.

Exists in the  
crude tartar.

2dly, That it is more natural to look for the source of this earthy salt in the crude tartar, which contains it ready formed, than to suppose it produced in the process of purifying it.

Carbonate of  
soda not a good  
test.

3dly, That the carbonate of soda does not appear by any means calculated for the analysis of cream of tartar with respect to tartrite of lime.

Tartarised na-  
tron retains a  
portion.

4thly, That in fact Rochelle salt promotes the solution of this calcareous salt with the assistance of heat; and it has the farther inconvenience of retaining a certain quantity a long time in solution.

Should be freed  
from it by cold  
solution.

5thly, That the Rochelle salt of the shops always contains more or less of this earthy salt, and that it ought to be redissolved in cold water, to obtain it perfectly pure.

6th, That the mode of analysis we employed appeared to us very proper, to make known precisely how much tartrite of lime is contained in the acidulous tartrite of potash.



## XI.

*Mineralogical Description and chemical Analysis of a Stone, called Pyrophysalite: by Messrs. HISINGER and BERZELIUS\*.*

**T**HE colour of this stone is white, or sometimes of a greenish white, and occasionally small superficial blue spots of fluat of lime may be observed on it.

It is found in masses, forming oblong nodules, most commonly of no determinate figure, but sometimes approaching an irregular rhomboid. Hence no exact measure of its angles can be taken: though apparently its lateral angles are about  $118^\circ$  and  $62^\circ$  reciprocally.

Its fracture is unequal, foliated and very shining in one direction only, which seems to be that formed by the inclination of  $90^\circ$  or  $100^\circ$  to the axis of the rhomboid. It may be cleft, though less decidedly, in two other directions nearly parallel to the sides of the rhomboid. If broken transversely, it has little or no lustre. The fragments are of an indeterminate form, angular, with sharp edges, on which it is a little translucent. They strike fire with steel, and are hard enough to scratch glass easily, but are scratched by quartz. It is difficult to reduce to powder. Specific gravity 3.451.

The powder of the purest fragments, projected into a hot spoon, emit a greenish phosphoric light, that is but of short duration.

Before the blowpipe without any addition it is nearly infusible: but if the heat be urged to a high degree, it renders it white, opaque, and its surface is surrounded by small bubbles, which issue from it hastily, and burst if the temperature be kept up. This is a very decided characteristic appearance, from which the substance has received its name.

With borax it fuses easily into a colourless transparent glass.

\* Annales de Chimie, vol LXVIII, p. 119, May, 1806.

- Attacked by soda. Soda attacks it with a little effervescence, and produces a porous mass.
- Where found. This stone was found by Mr. Gabn, at Finbo, near Fahlun, about three quarters of a league west of the town, on the road to Sundborn. The nodules are imbedded in a granite composed of white quartz, feldtspar, and silvery mica, the laminae of which are rhomboidal and in hexagonal prisms. The nodules are separated from the rock by thin scales of mica, covered by a talcous substance of a greenish yellow colour.
- Its difference from feldtspar. It differs from feldtspar, to which it appears to have most resemblance, in having but one determinate direction in which it can be split, while feldtspar has two. The specific gravity of feldtspar too is but 2.704, and besides it is much less difficult to fuse.
- Analysis. The following analysis was undertaken conjointly with Mr. Berzelius.
- Powdered. Two hundred grains of pyrophyssalite, reduced to fine powder in a mortar, acquired an increase of weight of four grains.
- Heated alone. *a.* These 204 grains, having been kept at a red heat in the fire for three hours, lost 1.5 grains.
- Treated with carbonate of potash, and muriatic acid. *b.* On adding 600 grains of carbonate of potash, and exposing the mixture to a red heat for three hours in a platina crucible, a colourless mass was obtained, perfectly soluble in muriatic acid. This solution being evaporated to dryness, and diffused in water with a very little muriatic acid, the silex was obtained, which, after having been washed and heated red hot for half an hour, weighed 66.25 grains.
- Silex. *c.* The solution in water was precipitated by carbonate of potash, which was added in excess, taking care to keep the liquor boiling during the process. The precipitate obtained was dissolved in caustic potash, except a small portion of a yellowish powder.
- Precipitated by carbonate of potash. *d.* To the liquor precipitated by carbonate of potash muriatic acid was added in excess, and caustic ammonia, without the liquor undergoing any change: a proof, that it contained neither glucine, zircon, nor yttria.
- Neither glucine, zircon, nor yttria. *e.* To the solution in caustic potash muriate of ammonia was added, and it was boiled till the ammonia was expelled in

in vapour. The alumine obtained by this process was carefully washed, and heated red hot. In this last operation, when the incandescence was carried to a high degree, the mass emitted fuming vapours; an unexpected phenomenon, that did not take place at a less elevated temperature. As we conceived these vapours to be muriate of ammonia, part of which might have remained in the mass, it was heated red hot in the fire full two hours longer. After this the alumine weighed 107.5 grains. In another experiment, when alumine had been exposed to a lower degree of heat, and for a quarter of an hour only, 116 grains were obtained, which were reduced to 107.5 by longer calcination. In these operations an aluminous salt was found to attach itself to the edges of the lid that covered the crucible, but the smallness of its quantity did not allow us to examine its nature. Another time, instead of exposing the alumine to heat, we dissolved it in sulphuric acid, and added a little potash; when the result was a crystallization of sulphate of alumine, which continued to the last drop. The sulphuric acid, in dissolving the alumine, left a residuum of 2 grains of silex.

the alkaline solution & boiled.

Alumine.

An aluminous salt.

Silex.

*f.* The yellow powder, which was not attacked by the caustic potash (c), was dissolved in nitromuriatic acid; being evaporated to dryness, and redissolved in water, a grain and half of silex were separated from it. By adding to the liquor succinate of ammonia, a precipitate of oxide of iron, weighing 1.75 grain, was obtained: and on adding caustic ammonia 1 grain of alumine was precipitated. The remaining liquor being boiled with carbonate of potash, some carbonate of lime was separated, which, after being heated red hot in the fire, weighed 1.75 grain. This portion of lime dissolved in weak sulphuric acid without effervescence forming with it sulphate of lime.

Yellow residuum.

Silex.

Oxide of iron.

Alumine.

Lime.

Thus, if we subtract the 4 grains of silex gained from the mortar in reducing the stone to powder, we find the proportions given by 100 parts of it to be

Component parts.

## ANALYSIS OF THE PYROPHYSALITE.

Alumine .....	53·25
Silex .....	32·88
Lime .....	0·88
Oxide of iron .....	0·88
	<hr/>
	87·89
Loss by calcination .....	0·75
Loss in the analysis .....	11·36
	<hr/>
	100

Loss appeared  
not to proceed  
from an alkali.

The last mentioned loss, which we experienced in several trials, led us to suspect the presence of an alkali. In consequence we heated the stone with nitrate of barytes, dissolved in sulphuric acid the mass obtained by this operation, and poured ammonia into the solution. The saline liquor being evaporated, and the salt heated red hot in a platina crucible, we imagined in what remained we discovered traces of a salt with an alkaline base, mixed with sulphate of lime, but the quantity of which was too small to ascertain its weight. It is even probable, that this salt may have been produced by the reagents. Thus it remained for us to examine, whether this stone did not contain an acid; as the fluoric for instance.

Examined for  
an acid.

In order to determine this, we saturated with muriatic acid the liquor that remained after the precipitation of the earthy substances in the preceding experiments, and then added muriate of lime. No precipitate however was obtained. We then determined to boil for an hour a portion of the stone, previously reduced to powder, in sulphuric acid. Employing a glass retort in this operation, we placed a vessel filled with lime-water, to receive the gasses, that should pass over during the solution. None however came over, except what was contained in the vessels, and the lime-water underwent no alteration. We saw however that the

It contains the  
fluoric.

upper part of the retort and part of the receiver had been corroded by fluoric acid. This acid therefore actually exists in the stone, though perhaps in small quantity, or strongly united with its base. Mr. J. G. Gahn observed a more considerable extrication of it, by treating with sulphuric acid the powder of this stone previously fused with an alkali. In

our

our experiment with nitrate of barytes, this change could scarcely be perceived. Hence we have still a suspicion, that the fluoric acid, which adheres strongly to alumine, may have carried off a portion of this earth with it at a high temperature, as was observed by Mr. Klaproth in his experiments on the topaz. In our experiments therefore there may have been a loss of both fluoric acid and alumine at the same time.

Perhaps carried off some alumine with it.

Finally we conceive the presence of fluoric acid will explain that striking emanation of bubbles, which is exhibited by this stone when exposed to the flame of the blowpipe: it appears, that part of the acid united to its earthy base produces a very fusible substance, while another is extricated in the forms of vapour. This supposition is strengthened by the observation of Mr. Gahn, that the topaz, particularly that of Brasil, when exposed to a very violent heat, emits bubbles similar to those produced on the pyrophyssalite. As the topaz contains alumine and silex, with a portion of fluoric acid, we conceive it ought to be placed in a mineralogical view between the topaz and the pycnite, which, according to Mr. Bucholz, contains 0.17 of fluoric acid\*.

This accounts for the bubbles.

Topaz emits the same.

Its place among minerals.

## XII.

*On some Chemical Agencies of Electricity, by HUMPHREY DAVY, Esq. F. R. S. M. R. I. A.*

*Concluded from Vol. XVIII, p. 339.*

*V. On the Passage of Acids, Alkalis, and other Substances through various attracting chemical Menstrua, by Means of Electricity.*

**A**S acid and alkaline substances, during the time of their electrical transfer, passed through water containing vegetable

Passage of various substances through at-

\* According to Vauquelin the pycnite, schorlite of Klaproth and others, schorliform beryl of some, contains but 0.06 of fluoric acid, 0.60 alumine, 0.80 silex, 0.02 lime, and 0.01 water. Haüy thinks, that the pyrophyssalite should be considered as a variety of the topaz. Ed.

colours

tracting chemical mixtures by means of electricity.

colours without affecting them, or apparently combining with them, it immediately became an object of inquiry, whether they would not likewise pass through chemical menstua, having stronger attractions for them; and it seemed reasonable to suppose, that the same power, which destroyed elective affinity in the vicinity of the metallic points, would likewise destroy it, or suspend its operation, throughout the whole of the circuit.

An arrangement was made, of the same vessels and apparatus employed in the experiment on the solution of muriate of soda and sulphate of silver, vol. XVIII, p. 338. Solution of sulphate of potash was placed in contact with the negatively electrified point, pure water was placed in contact with the positively electrified point, and a weak solution of ammonia was made the middle link of the conducting chain; so that no sulphuric acid could pass to the positive point in the distilled water, without passing through the solution of ammonia.

The power of 150 was used: in less than five minutes it was found, by means of litmus paper, that acid was collecting round the positive point; in half an hour, the result was sufficiently distinct for accurate examination.

The water was sour to the taste, and precipitated solution of nitrate of barytes.

Similar experiments were made with solution of lime, and weak solutions of potash and soda, and the results were analogous. With strong solutions of potash and soda a much longer time was required for the exhibition of the acid; but even with the most-saturated alkaline lixivium, it always appeared in a certain period.

Muriatic acid, from muriate of soda, and nitric acid from nitrate of potash, were transmitted through concentrated alkaline menstua, under similar circumstances.

When distilled water was placed in the negative part of the circuit, and a solution of sulphuric, muriatic, or nitric acid, in the middle, and any neutral salt with a base of lime, soda, potash, ammonia, or magnesia, in the positive part, the alkaline matter was transmitted through the acid matter to the negative surface, with similar circumstances to those occurring during the passage of the acid through the alkaline menstua;

strua; and the less concentrated the solution, the greater seemed to be the facility of transmission.

I tried in this way muriate of lime with sulphuric acid, nitrate of potash with muriatic acid, sulphate of soda with muriatic acid, and muriate of magnesia with sulphuric acid; I employed the power of 150; and in less than 48 hours, I gained in all these cases decided results; and magnesia came over like the rest.

Passage of various substances through attracting chemical mixtures by means of electricity.

Strontites and barytes passed, like the other alkaline substances, readily through muriatic and nitric acids; and, *vice versa*, these acids passed with facility through aqueous solutions of barytes and strontites; but in experiments in which it was attempted to pass sulphuric acid through the *same menstrua*, or to pass barytes or strontites through this acid, the results were very different.

When solution of sulphate of potash was in the negative part of the circuit, distilled water in the positive part, and saturated solution of barytes in the middle, no sensible quantity of sulphuric acid existed in the distilled water after 30 hours, the power of 150 being used; after four days, sulphuric acid appeared, but the quantity was extremely minute; much sulphate of barytes had formed in the intermediate vessel; the solution of barytes was so weak as barely to tinge litmus; and a thick film of carbonate of barytes had formed on the surface of the fluid. With solution of strontites the result was very analogous, but the sulphuric acid was sensible in three days.

When solution of muriate of barytes was made positive by the power of 150, concentrated sulphuric acid intermediate, and distilled water negative: no barytes appeared in the distilled water, when the experiment had been carried on for four days; but much oximuriatic acid had formed in the positive vessel, and much sulphate of barytes had been deposited in the sulphuric acid.

Such of the metallic oxides as were made subjects of experiment passed through acid solutions from the positive to the negative side, but the effect was much longer in taking place than in the instances of the transition of alkaline matter. When solution of green sulphate of iron was made positive,

solution

Passage of various substances through attracting chemical mixtures by means of electricity.

solution of muriatic acid intermediate, and water negative, in the usual arrangement, green oxide of iron began to appear in about ten hours upon the negative connecting amianthus, and in three days a considerable portion had been deposited in the tube. Analogous results were obtained with sulphate of copper, nitrate of lead, and nitromuriate of tin.

I made several experiments on the transition of alkaline and acid matter through different neutrosaline solutions, and the results were such as might well have been anticipated.

When solution of muriate of barytes was negative, solution of sulphate of potash intermediate, and pure water positive, the power being from 150, sulphuric acid appeared in about five minutes in the distilled water; and in two hours the muriatic acid was likewise very evident. When solution of sulphate of potash was positive, solution of muriate of barytes intermediate, and distilled water negative, the barytes appeared in the water in a few minutes; the potash from the more remote part of the chain was nearly an hour in accumulating, so as to be sensible.

When the solution of muriate of barytes was positive, the solution of sulphate of potash intermediate, and distilled water negative, the potash soon appeared in the distilled water; a copious precipitation of sulphate of barytes formed in the middle vessel; but after ten hours no barytes had passed into the water.

When solution of sulphate of silver was interposed between solution of muriate of barytes on the negative side, and pure water on the positive side, sulphuric acid alone passed into the distilled water; and there was a copious precipitation in the solution of sulphate of silver. This process was carried on for ten hours.

I tried several of these experiments of transition upon vegetable and animal substances with perfect success.

The saline matter exposed in contact with the metal, and that existing in the vegetable or animal substances, both underwent decomposition and transfer; and the time of the appearance of the different products at the extremities of the circuit was governed by the degree of their vicinity.

Thus, when a fresh leaf stalk of the polyanthus, about 2 inches



inches long, was made to connect a positively electrified tube containing solution of nitrate of strontites, and a negatively electrified tube containing pure water; the water soon became green, and gave indications of alkaline properties, and free nitric acid was rapidly separated in the positive tube. After ten minutes, the alkaline matter was examined; it consisted of potash and lime, and as yet no strontites had been carried into it: for the precipitate it gave with sulphuric acid readily dissolved in muriatic acid. In half an hour strontites, however, appeared; and in four hours it formed a very abundant ingredient of the solution.

Passage of various substances through attracting chemical mixtures by means of electricity.

A piece of muscular flesh of beef, of about 3 inches in length and half an inch in thickness, was treated in the same way as the medium of communication between muriate of barytes and distilled water. The first products were soda, ammonia, and lime; and after an hour and a quarter, the barytes was very evident. There was much free oximuriatic acid in the positively electrified tube, but no particle of muriatic acid had passed into the negative tube, either from the muriatic solution or from the muscular fibre.

#### VI. *Some general Observations on these Phænomena, and on the Mode of Decomposition and Transition.*

It will be a general expression of the facts that have been detailed, relating to the changes and transitions by electricity, in common philosophical language, to say, that hydrogen, the alkaline substances, the metals, and certain metallic oxides, are attracted by negatively electrified metallic surfaces, and repelled by positively electrified metallic surfaces; and contrariwise, that oxygen and acid substances are attracted by positively electrified metallic surfaces, and repelled by negatively electrified metallic surfaces; and these attractive and repulsive forces are sufficiently energetic, to destroy or suspend the usual operation of elective affinity.

General observations on the preceding phenomena.

It is very natural to suppose, that the repellent and attractive energies are communicated from one *particle to another particle* of the same kind, so as to establish a conducting chain in the fluid; and that the locomotion takes place in consequence;

General observations on the preceding phenomena.

consequence; and that this is really the case seems to be shown by many facts. Thus, in all the instances in which I examined alkaline solutions through which acids had been transmitted, I always found acid in them whenever any acid matter remained at the original source. In time, by the attractive power of the positive surface, the decomposition and transfer undoubtedly become complete; but this does not affect the conclusion.

In the cases of the separation of the constituents of water, and of solutions of neutral salts forming the whole of the chain, there may possibly be a succession of decompositions and recompositions throughout the fluid. And this idea is strengthened by the experiments on the attempt to pass barytes through sulphuric acid, and muriatic acid through solution of sulphate of silver, in which, as insoluble compounds are formed and carried out of the sphere of the electrical action, the power of transfer is destroyed. A similar conclusion might likewise be drawn from many other instances. Magnesia and the metallic oxides, as I have already mentioned, will pass along moist amianthus from the positive to the negative surface; but if the vessel of pure water be interposed, they do not reach the negative vessel, but sink to the bottom. These experiments I have very often made, and the results are perfectly conclusive; and in the case, page 39, in which sulphuric acid seemed to pass in small quantities through very weak solutions of strontites and barytes, I have no doubt but that it was carried through by means of a thin stratum of pure water, where the solution had been decomposed at the surface by carbonic acid; for in an experiment similar to these in which the film of carbonate of barytes was often removed and the fluid agitated, no particle of sulphuric acid appeared in the positive part of the chain.

It is easy to explain, from the general phenomena of decomposition and transfer, the mode in which *oxigen* and *hidrogen* are separately evolved from water. The oxigen of a portion of water is attracted by the positive surface, at the same time that the other constituent part, the hidrogen, is repelled by it; and the opposite process takes place at the negative surface; and in the middle or neutral point of the circuit,

circuit, whether there be a series of decompositions and recompositions, or whether the particles from the extreme points only are active, there must be a new combination of the repelled matter: and the case is analogous to that of two portions of muriate of soda separated by distilled water; muriatic acid is repelled from the negative side, and soda from the positive side, and muriate of soda is composed in the middle vessel.

General observations on the preceding phenomena.

These facts seem fully to invalidate the conjectures of M. Ritter, and some other philosophers, with regard to the elementary nature of water, and perfectly to confirm the great discovery of Mr. Cavendish.

M. Ritter conceived, that he had procured oxygen from water without hydrogen, by making sulphuric acid the medium of communication at the negative surface; but in this case, sulphur is deposited, and the oxygen from the acid, and the hydrogen from the water, are respectively repelled; and a new combination produced.

I have attempted some of the experiments of decomposition and transfer, by means of common electricity, making use of a powerful electrical machine of Mr. Nairne's construction, belonging to the Royal Institution, of which the cylinder is 15 inches in diameter, and 2 feet long.

With the same apparatus as that employed for decompositions by the Voltaic battery, no perceptible effect was produced by passing a strong current of electricity silently for four hours through solution of sulphate of potash.

But by employing fine platina points of  $\frac{1}{70}$  of an inch in diameter, cemented in glass tubes in the manner contrived by Dr. Wollaston\*, and bringing them near each other, in vessels containing from 3 to 4 grains of the solution, and connected by moist asbestos, potash appeared in less than two hours round the negatively electrified point, and sulphuric acid round the positive point.

In a similar experiment sulphuric acid was transferred through moist asbestos into water; so that there can be no

\* Phil. Trans. Vol. XCI, page 427.

doubt, that the principle of action is the same in common and the Voltaic electricity\*.

VII. *On the general Principles of the chemical Changes produced by Electricity.*

General principles of the chemical changes produced by electricity.

The experiments of Mr. Bennet had shown, that many bodies brought into contact and afterwards separated, exhibited *opposite* states of electricity; but it is to the investigations of Volta that a clear developement of the fact is owing; he has distinctly shown it in the case of copper and zinc, and other metallic combinations; and has supposed that it also takes place with regard to metals and fluids.

In a series of experiments made in 1801†, on the construction of electrical combinations by means of alternations of single metallic plates, and different strata of fluids, I observed, that, when acid and alkaline solutions were employed as elements of these instruments, the alkaline solutions always received the electricity from the metal, and the acid always transmitted it to the metal; thus, in an arrangement of which the elements were tin, water, and solution of potash, the circulation of the electricity was from the water to the

\* This had been shown, with regard to the decomposition of water, by Dr. Wollaston's important researches.—By carefully avoiding sparks, I have been able to obtain the two constituents in a separate state. In an experiment in which a fine platina point cemented in glass, and connected by a single wire with the positive conductor of this machine, was plunged in disilled water in an insulated state, and the electricity dissipated into the atmosphere by means of moistened filaments of cotton, oxygen gas, mixed with a little nitrogen gas, was produced; and when the same apparatus was applied to the negative conductor hydrogen gas was evolved, and a minute portion of oxygen and nitrogen gasses: but neither of the foreign products, the nitrogen gas in the one case and the nitrogen and oxygen gasses in the other, formed as much as  $\frac{1}{30}$  part of the volume of the gasses; and there is every reason to suppose, that they were derived from the extrication of common air, which had been dissolved in the water. This result, which, when I first obtained it in 1803, appeared very obscure, is now easily explained; the alternate products must have been evolved at the points of the dissipation of the electricity.

† See Phil. Trans. Vol. XCI, page 397.

tin, and from the tin to the solution of potash; but in an arrangement composed of weak nitric acid, water, and tin; the order was from the acid to the tin, and from the tin to the water.

General principles of the chemical changes produced by electricity.

These principles seem to bear an immediate relation to the general phænomena of decomposition and transference, which have been the subject of the preceding details.

In the simplest case of electrical action, the alkali which receives electricity from the metal would necessarily, on being separated from it, appear positive; whilst the acid under similar circumstances would be negative; and these bodies having respectively, with regard to the metals, that which may be called a positive and a negative electrical energy, in their repellent and attractive functions seem to be governed by laws the same as the common laws of electrical attraction and repulsion. The body possessing the positive energy being repelled by positively electrified surfaces, and attracted by negatively electrical surfaces; and the body possessing the negative energy following the contrary order.

I have made a number of experiments with the view of elucidating this idea, and of extending its application; and in all cases they have tended to confirm the analogy in a remarkable manner.

Well burned charcoal, water, and nitric acid; the same substance, water, and solution of soda; made respectively elements of different electrical combinations, became distinctly active when 20 alternations were put together: the positive energy being exhibited on the side of the alkali, and the negative on that of the acid. Arrangements of plates of zinc, pieces of moistened pasteboard, and moistened quicklime, to the number of 40 series, likewise formed a weak electrical pile, the effect of the lime being similar to that of an alkali, but the power was soon lost.

I endeavoured, by means of very delicate instruments, to ascertain the electrical states of single insulated acid and alkaline solutions, after their contact with metals; and for this purpose I employed at different times the condensing electrometer of Mr. Cuthbertson's construction, Mr. Cavallo's multiplier, and a very sensible electrical balance, on the principle of torsion, adopted by M. Coulomb; but the effects

General principles of the chemical changes produced by electricity.

effects were unsatisfactory, the circumstances of evaporation, and of chemical action, and the adherence of the solutions to the surfaces of the metals employed, in most cases, prevented any distinct result, or rendered the source of the electricity doubtful. I shall not enter into any details of these processes, or attempt to draw conclusions from capricious and uncertain appearances, which, as we shall immediately see, may be fully deduced from clear and distinct ones.

The alkaline and acid substances capable of existing in the dry and solid form, give by contact with the metals exceedingly sensible electricities, which require for their exhibition the gold leaf electrometer only with the small condensing plate.

When oxalic, succinic, benzoic, or boracic acid, perfectly dry, either in powder or crystals, was touched upon an extended surface with a plate of copper insulated by a glass handle, the copper was found positive, the acid negative. In favourable weather, and when the electrometer was in perfect condition, one contact of the metal was sufficient to produce a sensible charge; but seldom more than five or six were required. Other metals, zinc and tin for instance, were tried with the same effect. And the metal received the positive charge, apparently to the same extent, whether the acid was insulated upon glass, or connected with the ground.

The solid acid of phosphorus, which had been strongly ignited, and most carefully excluded from the contact of air, rendered the insulated plate of zinc positive by four contacts; but after exposure to the atmosphere for a few minutes it wholly lost this power.

When metallic plates were made to touch dry lime, strontites, or magnesia, the metal became negative; the effect was exceedingly distinct, a single contact upon a large surface being sufficient to communicate a considerable charge. For these experiments the earths were carefully prepared; they were in powder, and had been kept for several days in glass bottles before they were used: it is essential to the success of the process that they be of the temperature of the atmosphere. In some experiments which I made upon them when cooling, after having been ignited; they appeared strongly electrical,

electrical, and rendered the conductors brought in contact with them positive.

I made several experiments in a similar manner on the effects of the contact of potash and soda with the metals. Potash in no instance afforded a satisfactory result; its powerful attraction for water presents an obstacle probably unsurmountable to the success of any trials made in the free atmosphere. Soda, in the only case in which electricity was exhibited, affected the metal in the same way as lime, strontites, and magnesia. Upon this occasion the soda had been prepared with great care, exposed in a platina crucible for nearly an hour in a red heat, and suffered to cool in the crucible inverted over mercury: when cool it was immediately removed, and the contact made with a plate of zinc: the experiment was performed in the open air; the weather was peculiarly dry, the thermometer stood at 28° Fahrenheit, and the barometer at 30.2 inches: six contacts gave a charge to the condensing electrometer in the first trial; in the second ten were required to produce a similar effect; and after this, though two minutes only had elapsed, no further result could be obtained.

In the decomposition of sulphuric acid by Voltaic electricity the sulphur separates on the negative side. The experiments of various electricians prove, that, by the friction of sulphur and metals, the sulphur becomes positive and the metals negative; the same thing I find happens from the contact of an unexcited cake of sulphur and insulated metallic plates. Mr. Wilke has stated an exception to lead, as rendering sulphur negative by its friction. The results that I have obtained with lead, in trials very carefully made, are the same as those with other metals\*. Sulphur, by be-

\* As sulphur is a nonconductor, and easily excited by slight friction, or small changes in its temperature, some caution is required in drawing conclusions from the experiments in which it is employed. Sulphur, examined immediately after having been heated, gives a positive charge to conductors, agreeing in this respect with the alkaline substances; and a slight contact with the dry hand is sufficient to render it negative. In general likewise in experiments of contact care should be taken that the metallic plate is free from electricity: well polished plates of copper and zinc will, I find, receive a negative charge from being laid on a table of common mahogany.

General principles of the chemical changes produced by electricity.

ing rubbed or struck against newly polished lead, always became positive. Mr. Wilke perhaps was misled by using tarnished lead: sulphur, I find, rubbed against litharge, or lead the surface of which has been long exposed to air, becomes negative; and this exception being removed, all the facts on the subject are confirmations of the general principle\*.

On the general principle, oxygen and hydrogen ought to possess, with regard to the metals respectively, the negative and positive energy. This I have not been able to prove by direct experiments of contact; but the idea is confirmed by the agency of their compounds; thus I have found, that solution of sulphuretted hydrogen in water acts in the electrical apparatus composed of single plates and different strata of fluids, in the same manner as alkaline solutions; and that solution of oximuriatic acid is more powerful in similar arrangements than solutions of muriatic acid of a higher degree of concentration; and in both these cases, it is impossible to conceive the combined hydrogen and oxygen inactive. The inference likewise is fully warranted by the case of the solutions of alkaline hydrogenated sulphurets, which, consisting principally of alkali and sulphur together in union with water, exhibit the positive energy with regard to the metals in a very high degree. In the series of experiments on Voltaic arrangements constructed with single plates above-mentioned, I found the solutions of hydrogenated sulphurets in general much more active than alkaline solutions, and particularly active with copper, silver, and lead. And in an experiment that I made on a combination of copper, iron, and hydrogenated sulphuret of potash, in 1802, I found that the positive energy of the hydrogenated sul-

\* Concentrated solution of phosphoric acid, I find, is decomposed by Voltaic electricity: the phosphorus combines with the negatively electrified metal, and forms a phosphuret; at least this happened in the two cases that I tried with platina and copper. From all analogy it may be inferred, that the electrical energy of this inflammable substance with regard to metals is the same as that of sulphur. I tried some experiments of contact upon it, but without success. Its slow combustion in the atmosphere it is most likely was the cause of the failure: but even in gasses not containing free or loosely combined oxygen, its evaporation would probably interfere.

phuret



phurets with regard to the copper was sufficient to over-  
power that of the iron; so that the electricity did not circulate from the copper to the iron, and from the iron to the fluid, as in common cases, but from the copper to the hidroguretted sulphuret, and from the hidroguretted sulphuret to the iron.

General principles of the chemical changes produced by electricity.

All these details afford the strongest confirmation of the principle. It may be considered almost as a mere arrangement of facts; and with some extensions it seems capable of being generally applied.

Bodies possessing opposite electrical energies with regard to one and the same body, we might fairly conclude would likewise possess them with regard to each other. This I have found by experiment is the case with lime and oxalic acid. A dry piece of lime, made from a very pure compact secondary limestone, and of such a form as to present a large smooth surface, became positively electrical by repeated contacts with crystals of oxalic acid: and these crystals placed upon the top of a condensing electrometer, and repeatedly touched by the line, which after each contact was freed from its charge, rendered the gold leaves negatively electrical. The tendency of the mere contacts of the acid and alkali with the metal would be to produce opposite effects to those exhibited, so that their mutual agency must have been very energetic.

It will not certainly be a remote analogy to consider the other acid and alkaline substances generally, and oxygen and hydrogen as possessing similar electrical relations; and in the decompositions and changes presented by the effects of electricity, the different bodies naturally possessed of chemical affinities appear incapable of combining, or of remaining in combination, when placed in a state of electricity different from their natural order. Thus, as we have seen, the acids in the positive part of the circuit separate themselves from alkalis, oxygen from hydrogen, and so on; and metals on the negative side do not unite to oxygen, and acids do not remain in union with their oxides; and in this way the attractive and repellent agencies seem to be communicated from the metallic surfaces throughout the whole of the menstruum.

VIII. *On the relations between the electrical energies of bodies, and their chemical affinities.*

Relations between the electrical energies of bodies and their chemical affinities.

As the chemical attraction between two bodies seems to be destroyed by giving one of them an electrical state different from that which it naturally possesses; that is, by bringing it artificially into a state similar to the other, so it may be increased by exalting its natural energy. Thus, whilst zinc, one of the most oxidable of the metals, is incapable of combining with oxygen when negatively electrified in the circuit, even by a feeble power; silver, one of the least oxidable, easily unites to it when positively electrified; and the same thing might be said of other metals.

Amongst the substances that combine chemically, all those, the electrical energies of which are well known, exhibit opposite states; thus, copper and zinc, gold and quicksilver, sulphur and the metals, the acid and alkaline substances, afford opposite instances; and supposing perfect freedom of motion in their particles or elementary matter, they ought, according to the principles laid down, to attract each other in consequence of their electrical powers. In the present state of our knowledge, it would be useless to attempt to speculate on the remote cause of the electrical energy, or the reason why different bodies, after being brought into contact, should be found differently electrified; its relation to chemical affinity is, however, sufficiently evident. May it not be identical with it, and an essential property of matter?

The coated glass plates of Beccaria strongly adhere to each other when oppositely charged, and retain their charges on being separated. This fact affords a distinct analogy to the subject; different particles in combining must still be supposed to preserve their peculiar states of energy.

In the present early stage of the investigation, it would be improper to place unbounded confidence in this hypothesis; but it seems naturally to arise from the facts, and to coincide with the laws of affinity, so ably developed by modern chemists; and the general application of it may be easily made.

Supposing two bodies, the particles of which are in different

rent electrical states, and those states sufficiently exalted to give them an attractive force superior to the power of aggregation, a combination would take place which would be more or less intense according as the energies were more or less perfectly balanced; and the change of properties would be correspondently proportional.

Relations between the electrical energies of bodies and their chemical affinities.

This would be the simplest case of chemical union. But different substances have different degrees of the same electrical energy in relation to the same body: thus the different acids and alkalis are possessed of different energies with regard to the same metal; sulphuric acid, for instance, is more powerful with lead than muriatic acid, and solution of potash is more active with tin than solution of soda. Such bodies likewise may be in the same state or repellent with regard to each other, as apparently happens in the cases just mentioned; or they may be neutral; or they may be in opposite or attracting states, which last seems to be the condition of sulphur and alkalis that have the same kind of energy with regard to metals.

When two bodies repellent of each other act upon the same body with different degrees of the same electrical attracting energy, the combination would be determined by the degree; and the substance possessing the weakest energy would be repelled; and this principle would afford an expression of the causes of elective affinity, and the decompositions produced in consequence.

Or where the bodies having different degrees of the same energy, with regard to the third body, had likewise different energies with regard to each other, there might be such a balance of attractive and repellent powers as to produce a triple compound; and by the extension of this reasoning, complicated chemical union may be easily explained.

Numerical illustrations of these notions might be made without difficulty, and they might be applied to all cases of chemical action; but in the present state of the inquiry, a great extension of this hypothetical part of the subject would be premature.

The general idea will, however, afford an easy explanation of the influence of affinity by the masses of the acting substances, as elucidated by the experiments of M. Berthollet;

Relations between the electrical energies of bodies and their chemical affinities.

for the combined effect of many particles possessing a feeble electrical energy may be conceived equal or even superior to the effect of a few particles possessing a strong electrical energy: and the facts mentioned, page 38, confirm the supposition: for concentrated alkaline lixivia resist the transmission of acids by electricity much more powerfully than weak ones.

Allowing combination to depend upon the balance of the natural electrical energies of bodies, it is easy to conceive that a *measure* may be found of the artificial energies, as to intensity and quantity produced in the common electrical machine, or the Voltaic apparatus, capable of destroying this equilibrium; and such a measure would enable us to make a scale of electrical powers corresponding to degrees of affinity.

In the circuit of the Voltaic apparatus, completed by metallic wires and water, the strength of the opposite electricities diminishes from the points of contact of the wires towards the middle point in the water, which is necessarily neutral. In a body of water of considerable length it probably would not be difficult to assign the places in which the different neutral compounds yielded to, or resisted, decomposition. Sulphate of barytes, in all cases that I tried, required immediate contact with the wire: solution of sulphate of potash exhibited no marks of decomposition with the power of 150, when connected in a circuit of water ten inches in length, at four inches from the positive point; but when placed within two inches, its alkali was slowly repelled and its acid attracted\*.

Whenever

\* In this experiment, the water was contained in a circular glass basin two inches deep, the communication was made by pieces of amianthus of about the eighth of an inch in breadth. The saline solution filled a half ounce measure, and the distance between the solution and the water, at both points of communication, was a quarter of an inch. I mention these circumstances because the quantity of fluid and the extent of surface materially influence the result in trials of this kind. Water included in glass siphons forms a much less perfect conducting chain than when diffused upon the surface of fibrous nonconducting substances of much smaller volume than the diameter of the siphons. I attempted to employ siphons in some of my first experiments; but the very great inferiority

Whenever bodies brought by artificial means into a high state of opposite electricities are made to restore the equilibrium, heat and light are the common consequences. It is perhaps an additional circumstance in favour of the theory to state, that heat and light are always the result of all intense chemical action. And as in certain forms of the Voltaic battery, where large quantities of electricity of low intensity act, heat is produced without light; so in slow combinations there is an increase of temperature without luminous appearance.

Relations between the electrical energies of bodies and their chemical affinities.

The *effect of heat*, in producing combination, may be easily explained according to these ideas. It not only often gives more freedom of motion to the particles, but in a number of cases it seems to exalt the electrical energies of bodies; glass, the tourmalin, sulphur, all afford familiar instances of this last species of energy.

I heated together an insulated plate of copper and a plate of sulphur, and examined their electricities as their temperature became elevated: these electricities, scarcely sensible at 56° Fahrenheit to the condensing electrometer, became at 100° Fahrenheit capable of affecting the gold leaves without condensation; they increased in a still higher ratio as the sulphur approached towards its point of fusion. At a little above this point, as is well known from the experiments of the Dutch chemists, the two substances rapidly combine, and heat and light are evident.

Similar effects may be conceived to occur in the case of oxygen and hydrogen, which form water, a body apparently neutral in electrical energy to most other substances: and we may reasonably conclude that there is the same exaltation of power, in all cases of combustion. In general, when the different energies are strong and in perfect equilibrium, the combination ought to be quick, the heat and light intense, and the new compound in a neutral state. This would seem to be the case in the instance just quoted; and in the circumstances of the union of the strong alkalis and acids. But where one energy is feeble and the other strong,

inferiority of effect as compared with that of amianthus made me altogether relinquish the use of them.

Relations between the electrical energies of bodies and their chemical affinities.

all the effects must be less vivid; and the compound, instead of being neutral, ought to exhibit the excess of the stronger energy.

This last idea is confirmed by all the experiments which I have been able to make on the energies of the saline compounds with regard to the metals. Nitrate and sulphate of potash, muriate of lime, oximuriate of potash, though repeatedly touched upon a large surface by plates of copper and zinc, gave no electrical charge to them; subcarbonate of soda and borax, on the contrary, gave a slight negative charge, and alum and superphosphate of lime a feeble positive charge.

Should this principle on further inquiry be found to apply generally, the degree of the electrical energies of bodies, ascertained by means of sensible instruments, will afford new and useful indications of their composition.

#### IX. *On the mode of action on the pile of Volta, with experimental elucidations.*

Mode of action on Volta's pile, with experimental elucidations.

The great tendency of the attraction of the different chemical agents, by the positive and negative surfaces in the Voltaic apparatus, seems to be to restore the electrical equilibrium. In a Voltaic battery, composed of copper, zinc, and solution of muriate of soda, all circulation of the electricity ceases, the equilibrium is restored if copper be brought in contact with the zinc on both sides: and oxygen and acids, which are attracted by the positively electrified zinc, exert similar agencies to the copper, but probably in a slighter degree, and being capable of combination with the metal, they produce a momentary equilibrium only.

The electrical energies of the metals with regard to each other, or the substances dissolved in the water, in the Voltaic and other analogous instruments, seem to be the causes that disturb the equilibrium, and the chemical changes the causes that tend to restore the equilibrium; and the phenomena most probably depend on their joint agency.

In the Voltaic pile of zinc, copper, and solution of muriate of soda, in what has been called its condition of electrical tension, the communicating plates of copper and zinc are in opposite electrical states. And with regard to electricities of such

such very low intensity, water is an insulating body: every copper plate consequently produces by induction an increase of positive electricity upon the opposite zinc plate; and every zinc plate an increase of negative electricity on the opposite copper plate: and the intensity increases with the number, and the quantity with the extent of the series.

Mode of action on Volta's pile, with experimental elucidations.

When a communication is made between the two extreme points, the opposite electricities tend to annihilate each other; and if the fluid medium could be a substance incapable of decomposition, the equilibrium, there is every reason to believe, would be restored, and the motion of the electricity cease. But solution of muriate of soda being composed of two series of elements possessing opposite electrical energies, the oxygen and the acid are attracted by the zinc, and the hydrogen and the alkali by the copper. The balance of power is momentary only; for solution of zinc is formed, and the hydrogen disengaged. The negative energy of the copper and the positive energy of the zinc are consequently again exerted, enfeebled only by the opposing energy of the soda in contact with the copper, and the process of electromotion continues, as long as the chemical changes are capable of being carried on.

This theory in some measure reconciles the hypothetical principles of the action of the pile adopted by its illustrious inventor, with the opinions concerning the chemical origin of Galvanism, supported by the greater number of the British philosophers, and it is confirmed and strengthened by many facts and experiments.

Thus the Voltaic pile of 20 pairs of plates of copper and zinc exhibits no permanent electromotive power when the connecting fluid is water free from air\*; for this substance does not readily undergo chemical change, and the equilibrium seems to be capable of being permanently restored through it. Concentrated sulphuric acid, which is a much more perfect conductor, is equally inefficient, for it has little action upon zinc, and is itself decomposed only by a very strong power. Piles, containing as their fluid element ei-

\* The experiments proving this fact, and the other analogous facts in this page, may be seen detailed in Nicholson's Journal, 4to, Vol. IV, p. 333 and 394; and Phil. Mag. Vol. X, p. 40.

Mode of action  
on Volta's pile,  
with experi-  
mental eluci-  
dations.

ther pure water or sulphuric acid, will undoubtedly give single shocks, and this effect is connected with the restoration of the equilibrium disturbed by the energies of the metals; but when their extreme plates are connected there is no exhibition, as in usual cases of electromotion. Water containing loosely combined oxygen is more efficient than water containing common air, as it enables oxide of zinc to be formed more rapidly, and in larger quantities. Neutrosaline solutions, which are at first very active, lose their energy in proportion as their acid arranges itself on the side of the zinc, and their alkali on that of the copper; and I have found the powers of a combination, nearly destroyed from this cause, very much revived, merely by agitating the fluids in the cells and mixing their parts together. Diluted acids, which are themselves easily decomposed, or which assist the decomposition of water, are above all other substances powerful; for they dissolve the zinc, and furnish only a gaseous product to the negative surface, which is immediately disengaged.

There are other experiments connected with very striking results, which offer additional reasons for supposing the decomposition of the chemical menstrua essential to the continued electromotion in the pile.

As when an electrical discharge is produced by means of small metallic surfaces in the Voltaic battery, (the opposite states being exalted) *sensible* heat is the consequence, it occurred to me, that if the decomposition of the chemical agents was essential to the balance of the opposed electricities, the effect, in a saline solution, of this decomposition, and of the transfer of the alkali to the negative side, and of the acid to the positive side, ought, under favourable circumstances, to be connected with an increase of temperature.

I placed the gold cones, which have been so often mentioned, in the circuit of the battery with the power of 100, I filled them with distilled water, and connected them by a piece of moistened asbestos, about an inch in length and  $\frac{1}{6}$  of an inch diameter; I provided a small air thermometer capable of being immersed in the gold cones, expecting (if any) only a very slight change of temperature; I introduced  
a drop



a drop of solution of sulphate of potash into the positive cone: the decomposition instantly began: potash passed rapidly over into the negative cone, heat was immediately sensible; and in less than two minutes the water was in a state of ebullition.

Mode of action on Volta's pile, with experimental elucidations.

I tried the same thing with the solution of nitrate of ammonia, and in this instance the heat rose to such an intensity as to evaporate all the water in three or four minutes, with a kind of explosive noise; and at last actual inflammation took place, with the decomposition and dissipation of the greatest part of the salt\*.

That the increase of the conducting power of the water by the drop of saline solution had little or nothing to do with the effect, is evident from this circumstance. I introduced a quantity of strong lixivium of potash into the cones, and likewise concentrated sulphuric acid, separately, which are better conductors than solutions of the neutral salts; but there was very little sensible effect.

The same principles will apply to all the varieties of the electrical apparatus, whether containing double or single plates; and if the ideas developed in the preceding sections be correct, one property operating under different modifications is the universal cause of their activity.

#### X. On some general Illustrations and Applications of the foregoing Facts and Principles, and Conclusion.

The general ideas advanced in the preceding pages are evidently directly in contradiction to the opinion advanced by Fabroni, and which, in the early stage of the investigation, appeared extremely probable, namely, that chemical changes are the *primary* causes of the phenomena of Galvanism.

General illustrations and applications.

Before the experiments of M. Volta on the electricity excited by the mere contact of metals were published, I had to a certain extent adopted this opinion; but the new facts im-

\* In this process ammonia was rapidly given off from the surface of the negative cone, and nitrous acid from that of the positive cone, and a white vapour was produced by their combination in the atmosphere above the apparatus.

mediately

General illustrations and applications.

mediately proved, that another power must necessarily be concerned; for it was not possible to refer the electricity exhibited by the opposition of metallic surfaces to any chemical alterations, particularly as the effect is more distinct in a dry atmosphere, in which even the most oxidable metals do not change, than in a moist one, in which many metals undergo chemical alteration.

Other facts likewise soon occurred demonstrative of the same thing. In the Voltaic combination of diluted nitrous acid, zinc, and copper, as is well known, the side of the zinc exposed to the acid is positive. But in combinations of zinc, water, and diluted nitric acid, the surface exposed to the acid is negative; though if the *chemical* action of the acid on the zinc had been the cause of the effect, it ought to be the same in both cases.

In mere cases of chemical change likewise electricity is never exhibited. Iron burnt in oxygen gas, properly connected with a condensing electrometer, gives no charge to it during the process. Nitre and charcoal deflagrated in communication with the same instrument do not by their agencies in the slightest degree affect the gold leaves. Solid pure potash and sulphuric acid made to combine in an insulated platina crucible produce no electrical appearances. A solid amalgam of bismuth and a solid amalgam of lead become fluid when mixed together: the experiment, I find, is connected with a diminution of temperature, but with no exhibition of electrical effects. A thin plate of zinc, after being placed upon a surface of mercury, and separated by an insulating body, is found positive, the mercury is negative: the effects are exalted by heating the metals; but let them be kept in contact sufficiently long to amalgamate, and the compound gives no signs of electricity. I could mention a great number of other instances of *pure chemical* action in which I have used all the means in my power to ascertain the fact, and the result has been constantly the same. In cases of effervescence, indeed, particularly when accompanied by much heat, the metallic vessels employed become negative, but this is a phenomenon connected with *evaporation*, the change of state of a  
body

body independent of chemical change, and is to be referred to a different law\*.

General illustrations and applications.

I mentioned the glass plates of Beccaria as affording a parallel to the case of combination in consequence of the different electrical states of bodies. In Guyton de Morveau's experiments on cohesion, the different metals are said to have adhered to mercury with a force proportional to their chemical affinities. But the other metals have different electrical energies, or different degrees of the same electrical energy with regard to this body; and in all cases of contact of mercury with another metal, upon a large surface, they ought to adhere in consequence of the difference of their electrical states, and that with a force proportional to the exaltation of those states. Iron, which M. Guyton found slightly adhesive, I find exhibits little positive electricity after being laid upon a surface of mercury, and then separated. Tin, zinc, and copper, which adhere much more strongly, communicate higher charges to the condensing electrometer: I have had no instrument sufficiently exact to measure the differences: but it would seem, that the adhesion from the difference of electrical states must have operated in these experiments†, which being proportional to the electrical energies are, on the

\* The change of the capacities of bodies in consequence of the alteration in their volumes, or states of existence by heat, is a continually operating source of electrical effects: and as I have hinted, page 47, it often interferes with the results of experiments on the electrical energies of bodies as exhibited by contact. It is likewise probably one of the sources of the capricious results of experiments of friction, in which the same body, according as its texture is altered, or its temperature changed, assumes different states with regard to another body. Friction may be considered as a succession of contacts, and the natural energies of bodies would probably be accurately exhibited by it, if the unequal excitation of heat or its unequal communication to the different surfaces did not interfere by altering unequally their electrical capacities. Of the elements of flint glass, silix is slightly negative with regard to the metals, the soda is positive; and in contacts of glass with metals I find it exhibits the excess of the energy of the alkali: the case, as is well known, is the same in friction, the amalgam of the common machine is essential to its powerful excitation.

† Amalgamation undoubtedly must have interfered; but the general result seems to have been distinct.

hypothesis

General illustrations and applications.

hypothesis before stated, proportional to the chemical affinities. How far cohesion in general may be influenced or occasioned by this effect of the difference of the electrical energies of bodies is a curious question for investigation.

Many applications of the general facts and principles to the processes of chemistry, both in art and in nature, will readily suggest themselves to the philosophical inquirer.

They offer very easy methods of separating acid and alkaline matter, when they exist in combination, either together or separately, in minerals; and the electrical powers of decomposition may be easily employed in animal and vegetable analysis.

A piece of muscular fibre, of two inches long and half an inch in diameter, after being electrified by the power of 150 for five days, became perfectly dry and hard, and left on incineration no saline matter. Potash, soda, ammonia, lime, and oxide of iron were evolved from it on the negative side, and the three common mineral acids and the phosphoric acid were given out on the positive side.

A laurel leaf, treated in the same manner, appeared as if it had been exposed to a heat of 500° or 600° Fahrenheit, and was brown and parched. Green colouring matter, with resin, alkali, and lime, appeared in the negative vessel: and the positive vessel contained a clear fluid, which had the smell of peach blossoms; and which, when neutralized by potash, gave a blue-green precipitate to solution of sulphate of iron; so that it contained vegetable prussic acid.

A small plant of mint, in a state of healthy vegetation, was made the medium of connection in the battery, its extremities being in contact with pure water; the process was carried on for 10 minutes: potash and lime were found in the negatively electrified water, and acid matter in the positively electrified water, which occasioned a precipitate in solutions of muriate of barytes, nitrate of silver, and muriate of lime. This plant recovered after the process: but a similar one, that had been electrified for four hours with like results, faded and died\*.

The

\* Seeds, I find, when placed in pure water in the positive part of the circuit, germinate much more rapidly than under common circumstances;

but

The facts show, that the electrical powers of decomposition act even upon living vegetable matter; and there are some phenomena which seem to prove, that they operate likewise upon living animal systems. When the fingers, after having been carefully washed with pure water, are brought in contact with this fluid in the positive part of the circuit, acid matter is rapidly developed, having the characters of a mixture of muriatic, phosphoric, and sulphuric acids: and if a similar trial be made in the negative part, fixed alkaline matter is as quickly exhibited.

General illustrations and applications.

The acid and alkaline tastes produced upon the tongue, in Galvanic experiments, seem to depend upon the decomposition of the saline matter contained in the living animal substance, and perhaps in the saliva.

As acid and alkaline substances are capable of being separated from their combinations in living systems by electrical powers, there is every reason to believe, that by converse methods they may be likewise introduced into the animal economy, or made to pass through the animal organs: and the same thing may be supposed of metallic oxides; and these ideas ought to lead to some new investigations in medicine and physiology.

It is not improbable, that the electrical decomposition of the neutral salts in different cases may admit of economical uses. Well burned charcoal and plumbago, or charcoal and iron, might be made the exciting powers; and such an arrangement, if erected upon an extensive scale, neutrosaline matter being employed in every series, would, there is every reason to believe, produce large quantities of acids and alkalis with very little trouble or expense.

Ammonia, and acids capable of decomposition, undergo chemical change in the Voltaic circuit only when they are in very concentrated solution, and in other cases are merely carried to their particular points of rest. This fact may induce

but in the negative part of the circuit they do not germinate at all. Without supposing any peculiar effects from the different electricities, which however may operate, the phenomenon may be accounted for from the saturation of the water near the positive metallic surface with oxygen, and of that near the negative surface with hydrogen.

General illustrations and applications.

us to hope, that the new mode of analysis may lead us to the discovery of the *true* elements of bodies, if the materials acted on be employed in a certain state of concentration, and the electricity be sufficiently exalted. For if chemical union be of the nature which I have ventured to suppose, however strong the natural electrical energies of the elements of bodies may be, yet there is every probability of a limit to their strength: whereas the powers of our artificial instruments seem capable of indefinite increase.

Alterations of electrical equilibrium are continually taking place in nature; and it is probable that this influence, in its faculties of decomposition and transference, considerably interferes with the chemical alterations occurring in different parts of our system.

The electrical appearances which precede earthquakes and volcanic eruptions, and which have been described by the greater number of observers of these awful events, admit of very easy explanation on the principles that have been stated.

Beside the cases of sudden and violent change, there must be constant and tranquil alterations, in which electricity is concerned, produced in various parts of the interior strata of our globe.

Where pyritous strata and strata of coal-blende occur, where the pure metals or the sulphurets are found in contact with each other, or any conducting substances, and where different strata contain different saline menstrua, electricity must be continually manifested; and it is very probable, that many mineral formations have been materially influenced, or even occasioned by its agencies.

In an experiment that I made of electrifying a mixed solution of muriates of iron, of copper, of tin, and of cobalt, in a positive vessel, distilled water being in a negative vessel, all the four oxides passed along the asbestos, and into the negative tube, and a yellow metallic crust formed on the wire, and the oxides arranged themselves in a mixed state round the base of it.

In another experiment, in which carbonate of copper was diffused through water in a state of minute division, and a negative wire placed in a small perforated cube of zeolite in  
the

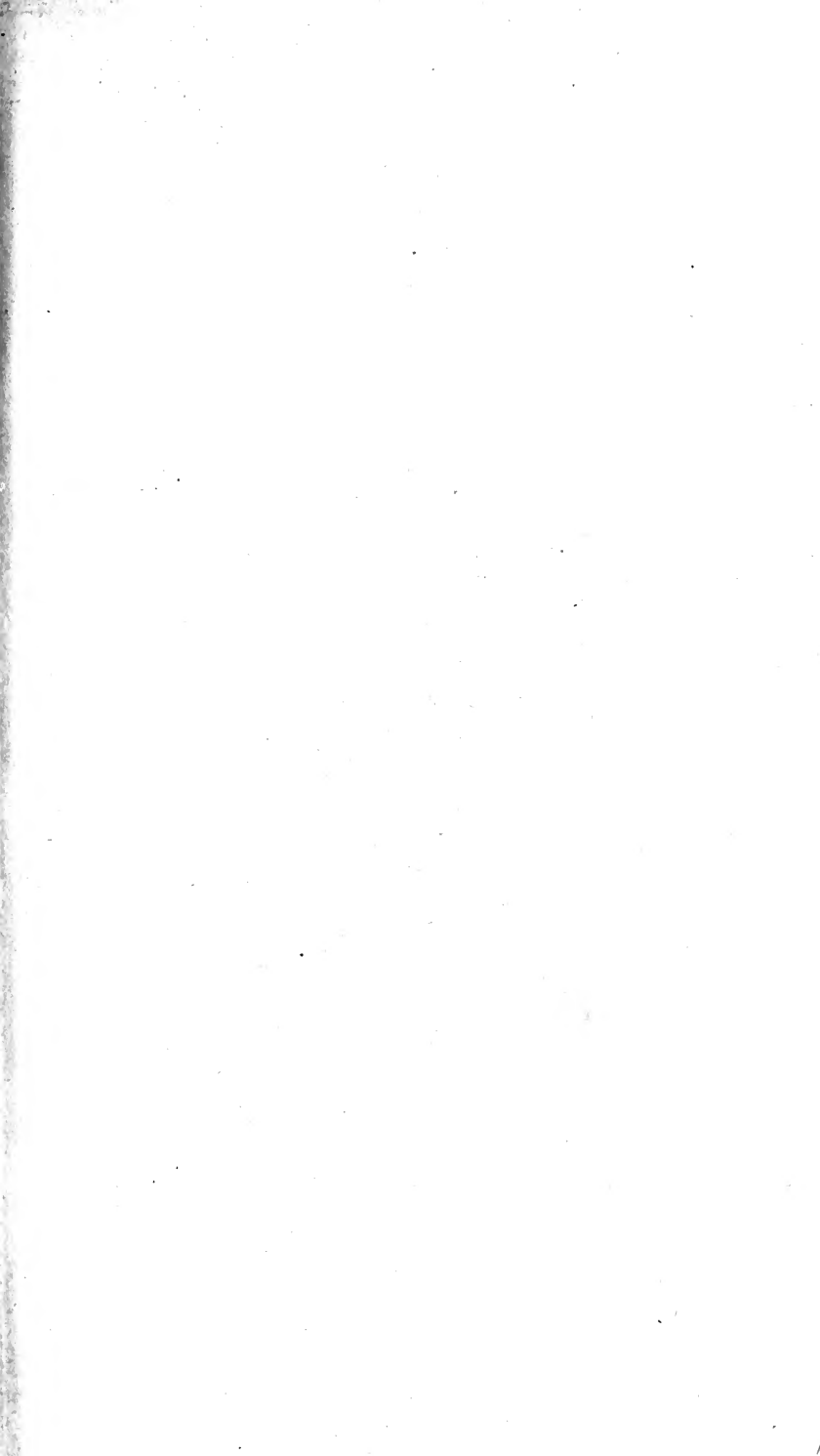

Mr Davy's Experiments on Galvanism.

Fig. 1.

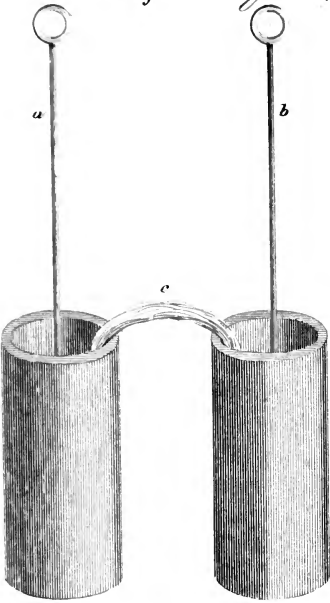

Fig. 2.

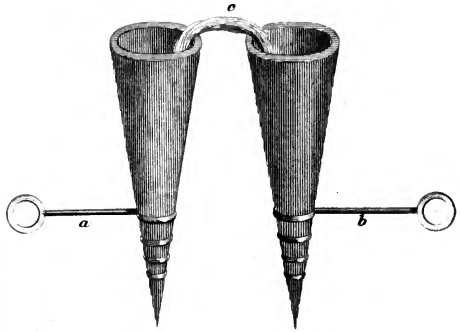

Fig. 3.

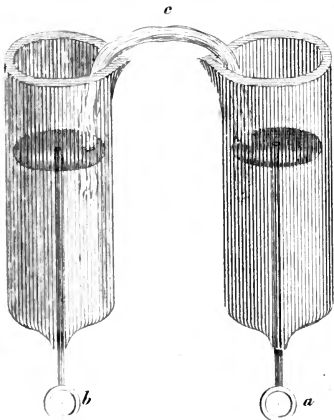
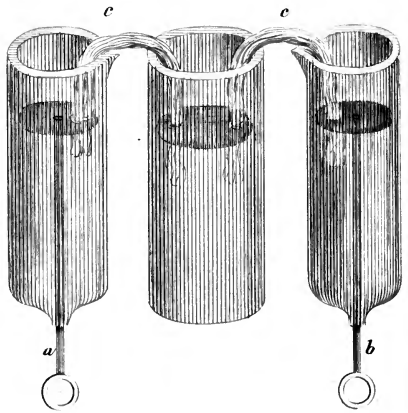

Fig. 4.





the water, green crystals collected round the cube; the particles not being capable of penetrating it.

General illustrations and applications.

By a multiplication of such instances the electrical power of transference may be easily conceived to apply to the explanation of some of the principal and most mysterious facts in geology.

And by imagining a scale of feeble powers, it would be easy to account for the association of the insoluble metallic and earthy compounds containing acids.

Natural electricity has hitherto been little investigated, except in the case of its evident and powerful concentration in the atmosphere.

Its slow and silent operations in every part of the surface will probably be found more immediately and importantly connected with the order and economy of nature; and investigations on this subject can hardly fail to enlighten our philosophical systems of the Earth; and may possibly place new powers within our reach.

#### *Explanation of the Figures.*

Pl. I. Fig. 1, Represents the agate cups, mentioned Vol. XVIII, p. 323.

Fig. 2, Represents the gold cones, page 325.

Fig. 3, Represents the glass tubes, and their attached apparatus, page 337.

Fig. 4, Represents the two glass tubes, with the intermediate vessel, page 338.

In all the figures A B denote the wires, rendered one positively, the other negatively electrical; and C the connecting pieces of moistened amianthus.

### XIII.

*Memoir on the Analysis of the Sweat, the Acid it contains, and the Acids of the Urine and Milk; read to the National Institute by Mr. THENARD\*.*

IF we examine the principal fluids of the animal economy, we find, that some are alkaline, and the others acid. To the

Animal fluids acid or alkaline.

\* Annales de Chimie, vol. LIX, p. 262, Sept. 1806.

first class belong the blood and bile: to the second, the urine, milk, and sweat.

Soda the only alkali.

What are the acids.

Hence arise naturally two questions; what are the alkalis, and what are the acids, proper to these fluids? The first has already been solved, as the researches of Cadet and Deyeux have proved, that we never meet with any alkali but soda in animal substances. The solution of the second however is but little advanced: even the data, that might lead to it, are for the most part inaccurate: and many of the results relating to some of these parts are too deficient in proof, to be placed in the rank of demonstrated truths. This is the question therefore, that will form the subject of the present memoir; and, that I may treat it in a manner suitable to the object I have in view, I shall first present as full an analysis of the sweat, as we have of urine and of milk.

### PART I. *Of the Sweat.*

Sweat.

That of an adult from 1320 grs. near 2 lbs. avoird., to 38400, near 5½ lbs. per day.

That from the lungs still more.

The first a secretion.

Its qualities.

The sweat is a fluid separated from the blood in the skin by exhalant vessels, with which its texture is traversed or filled. It is more or less copious in different individuals: and its quantity is perceptibly in the inverse ratio of that of the urine. All other circumstances being similar, much more is produced during digestion than during repose. The maximum of its production appears to be twenty-six grains and two thirds in a minute, the minimum nine grains, troy weight. It is much inferior however to the pulmonary transpiration: and there is likewise a great difference between their nature and manner of formation. The one is the product of a particular secretion, similar in some sort to that of the urine: the other, composed of a great deal of water and carbonic acid, is the product of a combustion gradually effected by the atmospheric air.

The sweat, in a healthy state, very sensibly reddens litmus, paper or infusion. In certain diseases, and particularly in putrid fevers, it is alkaline: yet its taste is always rather saline, and similar to that of salt; than acid. Though colourless, it stains linen. Its smell is peculiar, and insupportable when it is concentrated, which is the case in particular during distillation. But before I speak of the trials to which I subjected it, and for which I had occasion for a great quantity,

I thought to mention the method I adopted for procuring it.

I applied to persons who are in the habit of wearing flannel waistcoats next the skin. To avoid every source of error, the waistcoats, before they were put on, were first washed with soap; then rinsed in a stream of water, and afterward in diluted muriatic acid several times; and lastly they were immersed and wrung out of a large tub of water. The persons who were so obliging as to submit to the experiment, went into the bath before they began it, and were particularly careful to rub every part of the body well. The sweat that was collected uninterruptedly in the flannel during the course of ten days I separated by means of hot distilled water; and this I boiled down to the consistence of a sirup in a retort, to the neck of which a receiver was adapted. The product of this distillation emitted a nauseous smell, which diminished as the liquor cooled. It caused no alteration in sirup of violets, but it evidently reddened infusion of litmus. Left for some time exposed to the air, it retained the transparency it had at first, and underwent no remarkable change, unless with respect to its smell, which entirely vanished: in a close vessel probably it would have putrified, like the product of the distillation of all other animal fluids.

The residuum was not very copious, and evidently void of smell; though pretty strongly acid, the agreeable taste of sea salt predominated in it, yet with this taste something acrid and pungent was perceptible; it was slightly deliquescent, requiring some days to resolve into a liquid; and it was completely soluble in water. Lime, barytes, ammonia, the acidulous oxalate of potash, the carbonates of potash and soda, most acids, and acetate of lead, gave no precipitate with this solution, and disengaged nothing from it. Nut-galls occasioned a slight precipitate in it, but the nitrate of silver rendered it very turbid.

Calcined by itself it was decomposed, emitting vapours that had nothing of the fetid smell of animal matter, and was converted into a black substance, that was composed simply of a great deal of common salt, charcoal, and scarcely perceptible quantities of lime and oxide of iron.

Finally, when subjected to calcination after the acid has been

saturation with potash. been saturated with potash, this base was obtained in the state of carbonate, beside the preceding matters, in the black substance remaining.

Contains common salt, very little phosphate of lime, oxide of iron, & animal matter, and an acid. These trials already convinced me, that sweat contains muriate of soda, traces of phosphate of lime and oxide of iron, very little animal matter, no sulphate, no soluble phosphate, and in addition an acid, the nature of which I already suspected.

This probably the acetous. In fact this acid, combined with a base, giving rise to a carbonate by its calcination, must belong to the vegetable or animal kingdom; and as besides it was volatile, and formed soluble salts with the different salifiable bases, it became very probable that it was the acetous acid.

Yet it might be a new acid. Led by this reasoning to suppose the existence of acetous acid in sweat, I still required positive experiments, to convince myself of it: for though the properties I have mentioned belong only to the acetous, of all the known acids, yet they might equally belong to an unknown acid. Thus azote is far from being sufficiently characterised by the properties with which we usually content ourselves as denoting its presence; namely, its being without smell, without colour, and without action on blue colours or solution of lime; all negative properties, and far from being as characteristic as those, which, being founded on combinations, may be termed positive. Farther, to give certainty, there must be a combination of these positive properties, unless some one, which happens in certain instances, be so decisive, as to suffice of itself.

Positive proof to be sought where practicable.

The acid obtained separate.

Thus, though every thing apparently tended to show me, that the acid of sweat was the acetous, it was necessary for me to obtain it separate, and combine it with different substances, before I would pronounce definitively on its nature. This I effected easily, by distilling with another acid the residuum, which a certain quantity of sweat collected in a flannel waistcoat slightly alkaline afforded by evaporation. In this distillation I preferred the phosphoric acid; on one hand, because it is fixed; and on the other, because as it is very difficult to decompose, it acts less on organic matters than many others. I farther took every precaution, to condense the product of distillation in the receiver. This product strongly reddened

Its properties.

reddened infusion of litmus: its taste was that of a weak acid: its smell that of vinegar: combined with potash it formed a salt, which by evaporation was reduced to little shining scales, micaceous as it were, acrid, and very deliquescent: on the addition of sulphuric or phosphoric acid this salt evolved a strong smell of acetic acid; and, poured into a solution of nitrate of mercury, it precipitated crystalline scales, similar to acetite of mercury.

This acid therefore was the acetous, and consequently human sweat is formed of a great deal of water: free acetous acid; muriate of soda; an atom of phosphate of lime and oxide of iron; and an inappreciable quantity of animal matter, which approaches much nearer to gelatine than to any other substance.

This acid the acetous.

The animal matter resembled gelatine.

## PART. II. *Of the acids of urine.*

These acids are, 1st, the uric acid, which frequently gives rise to the stone in the bladder: 2dly, the benzoic acid, which exists very rarely in that of adults or old persons, and is more frequent in that of infants: 3dly, we are obliged to admit another acid, since the urine strongly and constantly reddens tincture of litmus, an action which cannot be ascribed either to the uric acid, that does not alter its colour, or to the benzoic acid, that is found in the urine only under certain circumstances, which are not yet well known.

Urine contains lithic acid, sometimes benzoic, and a third.

What is this new acid? This is the second question that I shall attempt to discuss. At present it is generally supposed to be the phosphoric acid. This opinion is grounded on the presence of a pretty large quantity of phosphate of lime in urine, which, being itself insoluble when neutral, becomes very soluble and even deliquescent, when it is with an excess of acid: and at the same time it is strengthened by the consideration, that beside the phosphates of lime, soda, ammonia, and magnesia, we find nothing in urine but the sulphates of potash and soda, and muriates of soda and ammonia, neither of which salts is decomposed by the acidulous phosphate of lime: their acids therefore, that is the sulphuric and muriatic, cannot exist in the urine, since, as is well known, they would convert the phosphate of lime into acidulous phosphate of lime. If then the phosphoric acid be

What is this acid?

Supposed to be phosphoric.

not the solvent of the phosphate of lime in urine, it must undoubtedly be some other weak acid, and probably an acid of the nature of the vegetable and animal acids.

This probably  
a mistake.

Nothing in fact proves, that this is not the case. I will venture to say farther, that this hypothesis appears to me more admissible than the former: for, to admit the acidulous phosphate of lime in urine, we must suppose, that a portion of one of the phosphates of the blood is decomposed in the kidneys, when it reaches them: that the phosphoric acid is free, or at least constitutes an acidulous phosphate with the phosphate of lime, though present with the soda of the blood, and with the base of the phosphate decomposed, both of which appear not to enter into any new combination at the time, and which are taken up with the residuum of the secretion by the venous system, to be returned into the circulation.

In the living  
body chemical  
action may be  
restrained.

It is true it may be said, that bodies under the influence of life act in a different manner from what they do when deprived of it; and that consequently decompositions may take place in the animal economy contrary to all that we are acquainted with. But, beside that this answer, though accurate, proves little in favour of the case in question, it may be employed in a certain degree to retort the argument, as thus: we have no avowed instance of salts being decomposed in the animal economy so that their alkali and acid remain present together without combining, while on the other hand it is demonstrated, that animal substances, particularly those that exist in the blood, as the fibrine and albumen, are transformed into some other in passing through this or that organ; thus in the mammary glands they are converted into sugar of milk, and the caseous, butyraceous, and extractive matters; and in the kidneys they form uree, uric acid, and sometimes benzoic acid. Now if they constantly form one of these acids, and sometimes the other likewise, it is possible they may form a third, which combines with the phosphate of lime, and holds it in solution. Such were the reflections that have led me to examine the acid of urine; and I shall proceed to relate the experiments, that I have made to discover its nature.

After having employed several means, which I shall pass over,

over, as they were without success, at least directly, I evaporated almost to dryness, in a water-bath, that I might not decompose the uree, about twenty quarts of fresh urine. The residuum powerfully reddened infusion of litmus; and I treated it cold, at several times, with a great deal of alcohol at 36° of strength.

Urine evaporated continued an acid.

I thus dissolved the greater part of the acid; but I could not effect its complete solution, whatever quantity of alcohol I employed, and even by the assistance of a small degree of heat. Having mixed all the liquors, I concentrated them by evaporation at a low temperature. I then examined the matter, which I had afresh reduced to a sirupy consistence. First I diluted a portion with water, and added to it lime-water and ammonia. No precipitate took place, or at least it was so slight, that it did not appear till long after the mixture was made. Another portion I calcined. The residuum was not only not acid; but, even treated with water, the calcareous salts and lime-water, added to the solution, gave no indication of an atom of phosphate. That which was not dissolved, and which contained a great deal of coal when completely incinerated, merely left a few traces of phosphate of lime.

This separate in great part.

Examined.

Hence it should seem, that urine contains, beside the uric acid, an acid with at least a binary radical. I strongly suspected, that it was the acetous; because I had already found this acid in other animal fluids, it exists in almost all vegetables, and it is formed in almost all the decompositions, that organized bodies undergo. In consequence into the portion I had left containing the acid I poured barytes-water. Having then evaporated the mixture to dryness, still with a gentle heat, I treated it afresh with alcohol, which dissolved the whole, except a yellowish powder, that was true acetate of barytes. Thus from this experiment we may infer, that there is acetous acid in urine; though it does not prove, that there is no phosphoric acid, since urine evaporated by a water-bath, and treated with a great deal of alcohol, always leaves a slightly acid residuum, and this acid, it may be said, is the phosphoric.

It has at least a binary radical.

Barytes added,

formed acetate of barytes.

To demonstrate, that this acid is not really the phosphoric, I could not have recourse to calcination; for the residuum, containing phosphate of ammonia, could not have

Attempt to prove, that it contains no

failed

free phosphoric acid.

failed to yield phosphoric acid: I was under the necessity therefore of adopting the synthetical method. Accordingly after having saturated by means of potash the extract of some urine, that I had evaporated to dryness with the precautions already described, I poured in a little vinegar, treated it with alcohol, and obtained the same results as I have already related; that is to say, the portion, that was not dissolved after repeated affusions of alcohol, was acid. This proof, I am aware, may still be questioned: for, if the phosphoric acid existed in the urine, it would be partly retained by the salts present in it, in the same manner as the acetous, and would become insoluble in alcohol. But if it be considered, that the existence of the acetous acid in urine appears certain\*; that nothing demonstrates the presence of the phosphoric; that the greater part of the free acid of the urine evaporated to the consistence of a sirup dissolves in alcohol; and that all this acid, thus dissolved, is the acetous: lastly, if we recollect, that the residuum is slightly acid; and that, if saturated with potash, afterward acidulated with vinegar, and treated afresh with alcohol, it remains equally acid: all these circumstances compared together, I conceive, will acquire such a degree of certainty, as absolutely to convince us, that it is the acetous acid alone in urine which dissolves the phosphate of lime, and which alone too most commonly imparts to it the property of reddening infusion of litmus.

Farther proof that it is the acetous only.

But, to render this last conclusion still more evident, I ought to demonstrate, more directly than has hitherto been done, that the benzoic acid is not in fact a constant principle of urine. For this, instead of employing sublimation with or without an excess of another acid, when the urine is reduced to a sirupy consistence; a method always inaccurate, since the benzoic acid combined with ammonia is car-

\* I believe, that, in the evaporation of the urine in a water bath, a little uree is decomposed, and that ammonia, and perhaps a little acetous acid is formed. Supposing this to be the case, it still remains very probable, that the acid of urine is the acetous acid, and not any other; for in favour of this opinion I might not only adduce the reasons that have been, or that will be given, but even the tendency the uree would have in this case to be converted into acetous acid.

ried



ried off more or less with the water that rises in vapour; I added lime before I began the evaporation, and treated the extract with alcohol.

It is true by this method we dissolve, beside the benzoate of lime, some uree, muriate of ammonia, and soda, and acetous acid: but if the alcoholic solution be converted into a concentrated aqueous solution, the acids added afterward will soon manifest the presence of benzoic acid, if there be ever so little in the solution.

Thus, when we would analyse urine, the benzoic acid should be first sought for, either by this or some analogous process. If by this we discover no trace of it in the liquid, which is most commonly the case, we may conclude, that it does not contain any sensible quantity of it: then, after having evaporated another portion of the urine in a water-bath, and thus ascertained the quantity of water that enters into its composition, the residuum must be treated repeatedly with alcohol at 36°: thus we shall dissolve the uree, the muriate of ammonia, some muriate of soda, and the greater part of the acetous acid.

Mode of analysing urine.

The mixture of these different substances should be divided into three portions. From the first the acetous acid is to be separated by the means pointed out. From the second the uree is to be extracted by concentrated nitric acid, from which again it is to be separated by the carbonate of potash and alcohol\*. Lastly, from the third part the quantity of sal ammoniac and muriate of soda is to be ascertained by sublimation. In this sublimation the uree is destroyed, the acetous acid is volatilized, the muriate of soda remains behind, and is to be weighed: the sal ammoniac sublimes, and is to be collected; and as it is always mixed with black matters, and may besides contain a little carbonate of ammonia, it is to be purified by dissolving it in water and evaporating the solution.

The matters contained in urine, that are soluble in alcohol,

Soluble mat-

\* Pure uree does not crystallize: it is only when combined with certain salts, which frequently happens, that it forms crystals. I believe, but I am not certain, that it renders several salts soluble in alcohol, which when alone are insoluble in it. This might easily be verified with muriate of barytes.

Uree does not crystallize without the addition of some salt.

hol,

ters contained  
in urine.

hol, are five; namely, acetous acid, benzoic acid, muriate of ammonia, muriate of soda in part, and uree. Those that are insoluble in it are more numerous, as at least eight may be reckoned; namely, four phosphates, two sulphates, muriate of soda, and uric acid. On treating with water these eight substances insoluble in alcohol, we dissolve the phosphates of soda and ammonia, a very little phosphate of magnesia, the muriate of soda, the sulphates of potash and soda, which are known by their crystallization, and which may be separated from one another in a certain degree by solutions of platina. We may judge that phosphate of magnesia is present by means of potash, which will precipitate a small quantity of this earth.

The substances insoluble in water then are the phosphate of lime, some phosphate of magnesia combined with phosphate of ammonia, and uric acid, which may be separated in the usual way. This method however differs very little from those that have been given by other chemists; and I describe it here in a concise manner, because it is intimately connected with my subject.

### PART III. *Of the acid of milk.*

Milk quite  
fresh contains  
a free acid.

Milk as soon as it comes from the mammary glands reddens litmus paper: it contains therefore a free acid. When I discovered this fact near eighteen months ago, I endeavoured in vain to obtain it pure, in order to examine its properties: and all my endeavours since that time, to attain the same object, have been equally fruitless.

Probably the  
acetous.

Though every thing leads us to believe, that it is the acetous acid, yet it is the same with respect to it, as with respect to the acids of sweat and urine: to pronounce decidedly on its nature, it was necessary to separate it, and combine it afterward with salifiable bases. This at length I effected, by pursuing a method analogous to that, which enabled me to obtain the acid of urine. 1st, I evaporated the milk to dryness: 2dly, I treated the residuum with barytes water, to saturate the acid: 3dly, I evaporated to dryness again: 4thly, I treated it with alcohol, to dissolve in part the extractive matter, and particularly to collect the caseous substance, so that none should remain suspended in the water:

This proved,

5thly,

5thly, I macerated in water what was not dissolved by the alcohol, filtered the liquor, concentrated it by evaporation, and distilled it with phosphoric acid. By these means I collected in the receiver a fluid, which possessed all the properties of acetous acid.

It follows then, from the various experiments I have described, 1st, that urine probably contains no free phosphoric acid: but that there is to be found in it, as well as in the milk and sweat, acetous acid. 2dly, That the sweat contains, beside this, a great deal of water, some muriate of soda, a small quantity of animal matter, and some traces of oxide of iron and phosphate of lime.

It is probable, that the acetous acid exists in several other substances. Several observations lead me to believe, that it would be found in cantharides: the analogy of the bomic and formic acids with vinegar have already been suspected: and I would almost venture, to generalize this idea, and say, that it exists in almost all animals, as in the sap of almost all vegetables: at least we may affirm, that of all the acids its formation costs nature least; its principles having such a tendency to unite, that we can scarcely ever disturb the equilibrium of the molecules of organized substances, without producing more or less of it. If the decomposition be rapid, acetous acid is formed; if slow, it is formed still: witness the distillation of vegetable and animal substances, their treatment by nitric and by oxygenized muriatic acid, their spontaneous decomposition, and their transformation into vegetable mould or adipocire.

In cases of indigestion it is known, that the food becomes acid, and this too is owing to acetous acid. In several circumstances however, its production has not yet been thoroughly appreciated: it remains to be seen, whether it exist in the milk of all kinds of animals; whether it be found in the sweat of all, and whether the sweat of different animals be identical; and lastly, whether it be not in the state of acetate in such urine as is alkaline. This is an inquiry which I propose to undertake, and the results of which I shall submit to the judgment of the Institute, if they prove worthy its attention.

General conclusions.

Acetous acid probably exists in several other substances,

perhaps in most animals.

Most easily formed.

Formed in indigestion.

Farther inquiries intended.

## XIV.

*Remarks on Orpiment and Realgar: by Mr. THENARD\*.*

Orpiment and  
realgar,

said to be the  
same sulphuret  
of arsenic mo-  
dified by heat;

then sulphuret-  
ted oxides, dif-  
fering in their  
proportions;

and lastly  
sulphurets of  
different ox-  
ides.

Arguments for  
the first opi-  
nion.

**O**RPIMENT and realgar are two ores of arsenic suffi-  
ciently abundant. The first is almost always in the form of  
laminæ of a pure yellow colour; and the second is as gene-  
rally a red mass more or less brown. Bucquet asserted, that  
these compounds were formed of oxide of arsenic, and sul-  
phur, in the same proportions, and ascribed their difference  
of colour to the different degree of heat employed in pre-  
paring them. Bergman likewise admitted the oxide of ar-  
senic, as well as sulphur, in both; but he imagined they  
differed in colour because they contained different propor-  
tions. These opinions, supported by some experiments that  
were capable of deceiving, prevented chemists for some time  
from forming a decided opinion: that of the Swedish che-  
mist however prevailed, and since the creation of the new  
theory, and the reform of chemical language, orpiment and  
realgar are described in chemical treatises under the names  
of yellow sulphuret of oxide of arsenic, and red sulphuret-  
ted oxide of arsenic. Nevertheless some have lately thought,  
that these two substances differed less with respect to their  
proportions of sulphur, than those of their oxygen.

Thus it has been successively supposed, 1st, that orpiment  
and realgar were homogeneous compounds containing burned  
arsenic: 2dly, that they were oxides more or less sulphuret-  
ted: and 3dly, that they were oxides more or less oxidized, as  
well as more or less sulphuretted.

The partisans of the first opinion ground it on the fact,  
that by heating equal quantities of arsenious acid and sul-  
phur in a less or greater degree the product is sometimes or-  
piment, at others realgar: therefore say they, if their colour  
differ, it is owing to the heat, which occasions a different ar-  
rangement of their particles.

\* *Annales de Chimie*, vol. LIX, p. 284, Sept. 1806. This paper was  
read to the Philomatic Society about a year ago.

Those

Those of the second refer to the analysis of orpiment and realgar in the humid way. As they obtained from the latter much more oxide of arsenic, and less sulphur, than from the former, their conclusion appeared to them just. For the second.

Those of the third argue from analogy. They imagine, that, when a metallic solution is precipitated by a hidrosulphuret, the sulphuretted oxide that is formed is always of the colour of the oxide it contained. For the third.

It is easy to perceive, that none of these reasonings are free from objection: and hence I have imagined it would not be useless, to subject both orpiment and realgar to a fresh examination, in order to find with precision how they differ from each other. All liable to objection.

But before I speak of the experiments however, which I have made with them, I ought to quote what prof. Proust says of orpiment in the *Journal de Physique*, vol. XLIX, pp. 411, 412: particularly as I am perfectly of his opinion respecting the nature of this compound. Proust says, that, in preparing orpiment,

“ Things happen differently,” says Mr. Proust, “ when, instead of applying potash to the sulphuret of antimony, we add it to the ore of arsenic: the sulphuretted hidrogen, that is formed while the arsenic becomes oxidized, does not adhere to this oxide, on precipitating it with an acid, as happens to that of antimony. The hidrogen acts a very different part during this precipitation: it is employed in disoxidizing the arsenic, in order that it may attach itself as a metal to the sulphur, and produce the yellow sulphuret, which we call orpiment: for the hidrosulphuret of arsenic, and the sulphuretted oxide, are two combinations that apparently do not exist. If we dissolve white arsenic in thoroughly saturated hidrosulphuret of potash, and afterward add an acid, orpiment is precipitated without the least disengagement of gas, without the slightest smell: but on the one hand the sulphuretted hidrogen is no longer to be found, and on the other the arsenic in the orpiment is in the metallic state: in this precipitation therefore water is formed. The pure regulus of arsenic is not soluble in the arsenical hidrosulphuret.” the oxide of arsenic is decomposed by the hidrogen, and the arsenic unites in the metallic state with the sulphur.

If I might be permitted to make one observation on this passage in Mr. Proust's paper, I would say, that, it seems His experiments scarcely  
to

prove the absence of oxygen.

to me, the experiments adduced by this learned chemist are not altogether sufficient to prove the nonexistence of oxygen in orpiment: for we may account for the result, whether we admit the existence of sulphuretted hydrogen in this compound, or that of an oxide less oxidized than the white oxide of arsenic. Mr. Proust has said nothing of realgar.

Both sulphurets of arsenic decomposed on the open fire, and sublimed in close vessels.

Both orpiment and realgar, if reduced to powder, and projected on burning coals, melt, swell up, and emit sulphurous acid: but all these phenomena are more obvious with realgar. Heated in close vessels the fusion and tumefaction are the same, and they are sublimed without changing their nature, consequently without giving out any sulphurous acid.

Realgar contains most arsenic.

Sulphur fused with realgar converts it into orpiment; while arsenic fused with orpiment converts it into realgar.

Acids that attack them.

The sulphuric, nitric, nitrous, and oxygenized muriatic acid, are, as is well known, the only ones that attack orpiment and realgar.

Sulphuric.

Sulphuric acid acts perceptibly with greater power on orpiment than on realgar. In both cases sulphurous acid is formed, and likewise arsenious acid; but more sulphurous acid, and less arsenious, are produced with the orpiment.

Nitric.

Nitric acid is decomposed by both these substances, even without the assistance of heat: and orpiment affords with it more sulphur, and less arsenious acid, than realgar.

Oxygenized muriatic and nitro-muriatic.

With oxygenized muriatic acid, and with the nitro-muriatic, the same results are obtained as with the nitric.

Alkalis.

The alkalis, particularly potash and soda, easily dissolve both, even cold. Hydroguretted sulphuret of potash and arsenite of potash are formed: since on pouring lime-water into the solution a pretty copious white precipitate is obtained, which, treated with carbonate of potash, affords a liquor, that yields, on adding a sufficient quantity of muriatic acid, and evaporating to a proper point, a great deal of arsenious acid.

Orpiment contains most sulphur, and neither probably any oxygen.

All these experiments show, that more sulphur is contained in orpiment than in realgar, and some of them lead us to suspect, that no oxygen is present in either. The following will

will serve farther to establish the former fact, and will place the latter in a stronger light.

It is very certain, that, if arsenic were in the state of oxide in these compounds, they might easily be formed by employing arsenious acid and sulphur. But on heating these substances together in a retort, &c., we obtain for a long time nothing but sulphurous acid: it is not till this gas nearly ceases to come over, that orpiment or realgar is formed. It may be said indeed, that arsenic is less oxidized in these sulphurets, than in arsenious acid. But the existence of such oxides has never been proved. When arsenious acid is reduced by any method whatever, even by means of hydrogen gas, nothing is ever obtained but arsenious acid and arsenic, suspend the process at what period of it you please: and probably, if there were any fixed intermediate degrees of oxidation, they would be detected by proceeding in this way. Be this as it may, by combining sulphur with arsenic in different proportions in close vessels, we obtain at pleasure orpiment or realgar.

These sulphurets cannot be formed by arsenious acid & sulphur, till the oxygen is given out.

No intermediate state of oxidation.

Three parts of sulphur and four of arsenic form orpiment: one of sulphur and three of arsenic form realgar. Realgar enters into fusion at a very low temperature, and continues fluid long after the retort is withdrawn from the fire. Orpiment requires a somewhat higher heat to fuse it. Both rise by sublimation, and adhere to the neck of the retort. The orpiment is transparent, and of a hyacinth colour, so that at first it might be taken for a sort of realgar: but native orpiment itself assumes this colour on being melted; and both, that is the native orpiment after its beautiful colour has been thus changed, and the artificial, become of a very pure and lively yellow by pulverization. It is not the same with the orpiment produced in the humid way. The colour of this is similar to that of native orpiment that has never been exposed to heat: and it is in every respect similar to it, whether it be the product of a mixture of arsenious acid and sulphuretted hydrogen, or of a soluble arsenite, hydrosulphuret, and an acid.

Distinguishing properties of the two sulphurets.

Thus it appears demonstrated, that yellow orpiment in shining scales, and even endued with a sort of elasticity, is formed in some fluids; while realgar is produced by arsenic

Orpiment sometimes may be mistaken for realgar.

Neither contains oxygen.

Orpiment 4 parts arsenic and 3 sulphur.

Realgar 3 arsenic and 1 sulphur.

But sulphur & arsenic combine in various intermediate proportions.

and sulphur melted together: and that, since orpiment assumes a hyacinth colour on fusion, similar compounds may possibly exist in nature, and have been mistaken for realgar.

However this may be, it is established beyond a doubt, that both orpiment and realgar contain no oxygen: they are sulphurets of arsenic more or less sulphuretted. In orpiment the arsenic is to the sulphur in the proportion of four to three; in realgar, in that of three to one. If more than three parts of sulphur be combined with four of arsenic, a yellow compound is obtained, the colour of which is not very lively, and approaches more or less to that of sulphur: in like manner, if less than one part of sulphur be united with three of arsenic, a compound of a browner colour than common realgar is formed: and as sulphur and arsenic are capable of combining together in a great number of different proportions, the shades that sulphuret of arsenic may present to us must be very numerous.

## SCIENTIFIC NEWS.

### *Decomposition of the Alkalies.*

The alkalis decomposed.

into oxygen and an inflammable base.

Properties of the base of potash.

THE suggestions of Mr. Davy, in his observations on the agencies of electricity, which we have already given in this number, see p. 62, have been in some measure verified by that ingenious and learned gentleman, and produced very surprising results. Moistened potash and soda, exposed on a plate of platina to the action of the galvanic circle, have been decomposed into oxygen and a base, that in some of its properties resembles metals. Thus we find oxygen has no more claim to be considered as the generator of acids, than as that of alkalis, for it appears to make a part of ammonia likewise. The base too is highly inflammable, and forms an amalgam with mercury: but it is so far from having the specific gravity of metals, that it is lighter than most fluids. The base of potash has a specific gravity of 0.6 only: at the freezing



freezing point it is hard, brittle, and when broken exhibits facets, as if crystallized, when examined by the microscope: at  $40^{\circ}$  it is scarcely distinguishable from a small globule of quicksilver, at  $60^{\circ}$  is quite fluid, and at  $100^{\circ}$  evaporates. It is extremely greedy of oxygen, absorbing it rapidly from the atmosphere, and resuming the alkaline state. Yet if amalgamated with twice its bulk of quicksilver, and applied in the circuit of a powerful battery to iron, silver, gold, or platina, these metals are immediately dissolved, and converted into oxides, while the alkali is regenerated. Glass is dissolved by it in the same manner as the metals. A globule placed on a piece of ice burnt with a bright flame and intense heat, and potash was found in the water from the melted ice. In this case, as well as when a globule was thrown into water, a considerable quantity of hydrogen was rapidly evolved. When a globule was placed on a piece of moist turmeric paper, it appeared instantly to acquire intense heat, but moved so rapidly in quest of the moisture, that the paper was no where burned; but a deep red stain, that marked its course, proved the regeneration of the alkali.

The base of soda is somewhat heavier than that of potash, Base of soda. its specific gravity being 0.7. It remains solid in a temperature not exceeding  $150^{\circ}$ , but at  $180^{\circ}$  it is perfectly fluid.

From a considerable number of experiments potash ap- Proportions of appears to consist of 85 parts base and 15 oxygen, and soda of oxygen in the 80 parts base and 20 oxygen. It would seem too, that am- alkalis. monia contains 20 per cent of oxygen; but this proportion was deducted from more complicated calculations, and less direct experiments.

On examining strontia and barytes, oxygen was educed Strontia and from both of them. barytes.

---

### *Economical and medicinal uses of chinese radish oil.*

ABOUT fifteen years ago Mr. de Grandi, member of the Chinese radish Patriotic Society of Milan, introduced and established the introduced into cultivation Italy.

cultivation of a species of radish, the *raphanus sinensis*. The culture of this plant has been attended with such success, as to merit attention.

Yields an excellent oil for the table, or lamps.

The Chinese radish yields a large quantity of oil; and experiments lately made at Venice show, that this oil is preferable to any other kind known, not only for culinary purposes, and giving light, but in medicine.

Useful in medicine, and keeps extraordinarily well.

From the experiments made by Dr. Francis di Oliviero, it is extremely useful in rheumatic and pulmonary affections; it is not liable to spoil by keeping like other oils; and it has been employed with much success in convulsive coughs.

Culture.

The plant is not injured by the strongest frosts; it is sown in September, and in May or June the seed is gathered, which is very abundant.

---

#### *Simple process for salting and smoking meat.*

Process for making excellent hung beef in 48 hours.

In Franconia a method of salting and smoking meat is employed, that requires only eight and forty hours. The following is the process. A quantity of saltpetre, equal to the common salt that would be required for the meat in the usual way, is dissolved in water. Into this the meat to be smoked is put, and kept over a slow fire for a few hours, till all the water is evaporated. It is then hung up in a thick smoke for four and twenty hours, when it will be found equal in flavour to the best Hamburg smoked meat, that has been kept several weeks in salt, as red interiorly, and as firm.

---

#### *To Correspondents.*

I am sorry to inform my correspondent at Whitby, that his letter was unfortunately lost by the carelessness of the messenger employed to convey it to me from the publisher. If he has retained a copy of it therefore, I would request the favour of him, to transmit it to me.

Dr. Traill's letter will appear in our next number.

A  
JOURNAL  
OF  
NATURAL PHILOSOPHY, CHEMISTRY,  
AND  
THE ARTS.

---

---

FEBRUARY, 1808.

---

---

ARTICLE I.

*On Albinos: by T. S. TRAILL, M. D.*

To Mr. NICHOLSON.

THE following account of a poor family in this town is transmitted for insertion in your Journal, if deemed singular enough to entitle it to a place in that valuable miscellany. The history was noted down a few days ago in my house from the words of the mother, who brought with her two of her children, who in all respects resembles the *Albinos* of Chamouni, so well described by de Saussure in his *Voyage Dans les Alpes*.

Robert Edmond and his wife Anne are both natives of Anglesey in North Wales. He has blue eyes and hair almost black; her eyes are blue, and her hair of a light brown. Neither of them have remarkably fair skins. They have been married fourteen years. Their first child, a girl, had blue eyes and brown hair. The second, a boy, (now before me) has the characteristics of an *albino*: viz. very fair skin, flaxen hair, and rose-coloured eyes. The third and fourth children were twins, and both boys; one of them has blue eyes and dark brown hair; the other was an *albino*. The former is still alive: the albino lived nine months, though a very puny

puny child. The fifth child, a girl, had blue eyes and brown hair. The sixth, and last now here, is a perfect albino.

The oldest described.

The oldest of these albinos is now nine years of age, of a delicate constitution, slender, but well formed both in person and in features; his appetite has always been bad; he frequently complains of a dull pain in his forehead; his skin is exceedingly fair; his hair flaxen and soft; his cheeks have very little of the rose in them. The iris and pupil of his eyes are of a bright rose-red colour, reflecting in some situations an opaline tinge. He cannot endure the strong light of the sun. When desired to look up, his eyelids are in constant motion, and he is incapable of fixing the eye steadily on any object, as is observed in those labouring under some kinds of slight ophthalmia, but in him it is unaccompanied by tears. His mother says, that his tears never flow in the coldest weather, but when vexed they are shed abundantly. The white of the eye is generally bloodshot. He says he sees better by candle than by daylight; especially at present, when the reflection from the snow on the ground is extremely offensive to him. He goes to school, but generally retires to the darkest part of it to read his lesson, because this is most agreeable to his eyes. In my room, which has a northern aspect, he can only distinguish some of the letters in the pages of the Edinburgh Review; but, if the light is not permitted to fall full on the book, he is able to read most of them. He holds the book very near his eye. His disposition is very gentle; he is not deficient in intellect. His whole appearance is so remarkable, that some years ago a person attempted to steal him, and would have succeeded in dragging him away, had not his cries brought a person to his assistance.

The younger.

The youngest child is now nine months old; is a very stout, lively, noisy, and healthy boy. In other respects he perfectly resembles his brother.

Approach to it in a relation.

The mother says, that one of her *cousins* has a very fair skin, flaxen hair, and very weak light blue eyes.

Supposed want of the black mucus in the eye.

Professor Blumenbach of Gottingen, in a curious memoir read before the Royal Society of that city, endeavoured to prove, that the red colour of the eyes of the albinos of Chamouni was owing to the want of *pigmentum nigrum* within the

the

the eye. About the same time, Buzzi of Milan had an opportunity of dissecting an albino, and proved, that the *pigmentum nigrum* of the choroid coat, and also that portion of it which lies behind the iris, and is called uvea by anatomists, were wanting; thus demonstrating what Blumenbach had supposed. This deficiency was observed before by Blumenbach in some white dogs, owls, and in white rabbits. Buzzi discovered, that the layer of the skin called *rete mucosum* was also wanting, and to this he with great probability attributes the peculiar fairness of the skin; the colouring matter of the negro, and of the hair of animals, being lodged in this membrane.

Proved by dissection.

Wanting in some white animals too. Rete mucosum absent.

It is well known, that from the tawny natives of Asia, Africa, and America, albinos sometimes spring, who are said to be capable of propagating a race like themselves, when they intermarry. Whether this be the case with the albinos of Europe is unknown; for, as far as I have been able to learn, not one of them was a female. There are on record eight instances of European albinos, beside the three now noticed. Two of these are described by Saussure, four by Buzzi, one by Helvetius, and one by Maupertuis, all of whom were males. The parents of the two young men of Chamouni had female children of the usual appearance. The woman of Milan had seven sons, three of whom were albinos. Mrs. Edmond's girls were all of the usual appearance, but all her boys were albinos. Among these eleven cases not one albino girl has been found. This at least proves, that males are more subject than females to this singular structure.

Albinos from tawny parents continue their race.

European albinos generally males.

From the perpetuation of this variety of the human species in Java, Guinea, and other places, as well as from the account Mrs. Edmond gives of her cousin, it would seem to be hereditary.

This variety becomes hereditary.

The causes which produce it are like those which produce defects of limbs, or of various viscera, wholly concealed from our curiosity. Buzzi relates, that the woman of Milan, when pregnant with the albinos, always had an immoderate longing for milk, which she used to excess; but never felt that desire while pregnant with her other children; and he seems to ascribe this longing to some *internal heat or disease*.

Its cause unknown.

Not connected  
with a moun-  
tainous region.

Mrs. Edmond neither experienced any sensation, which could lead her to distinguish between each kind of foetus; nor was her general health sensibly affected in one case more than in the other. The story of the milk, so much resembles those invented by our own good ladies to explain *navi materni*, or those singular marks which are sometimes observable on the bodies of children, that I am not disposed to pay much attention to it. With regard to the supposed internal disease, which Buzzi imagines destroyed the *rete mucosum* of the albino foetus, it is difficult to conceive any disease of the mother capable of producing so extensive an effect on one of Mrs. Edmond's children, while its twin brother was altogether free from any mark of the existence of such malady. Beside this, the regular alternation of the albinos with her other children does not favour the notion of their peculiarities arising from disease on the system of the mother. De Saussure very properly rejects the idea of this conformation being produced by the air of mountainous regions. The three albinos I have just described were born near the sea, on the extensive plains of Lancashire, and the birthplace of the parents is the flat island of Anglesey. Where facts are so few, and the causes seemingly so remote from human investigation, it is better to rest satisfied with having observed them, than to waste time on useless hypothesis.

THOMAS STEWART TRAILL.

Liverpool, Dec. 9, 1807.

#### ANNOTATION.

Instance of an  
English albi-  
ness.

Dr. Traill justly remarks the singularity, that of all the cases of European albinos on record not one should be a male. Most of my London readers, however, will be aware, that a female of this description has been exhibited in the metropolis for some years, and is at present at the rooms in Spring Gardens. She answers exactly to the full and accurate description of the boy given above. Her hair, I think, which she suffers to grow very long, has more of a silky appearance than that of the two male albinos exhibited

here

here about twenty years ago, at least to the best of my recollection, and more of the yellow tinge of raw silk. She does not see better in the dark than other people, but on the contrary not so well as most. She is a native of Essex, and I apprehend between twenty and thirty years old; perfectly well shaped, about the middle size, and says she has always been very healthy, which her appearance does not any way contradict. In her understanding she seems by no means deficient.

She informs me, that her mother's first child, a girl, is also an albiness like herself; that she was the third child; and that the fifth, a boy, is an albino. The two intermediate children had nothing remarkable. Her mother had never any peculiar longing, ailment, or fright, she added, during either of her pregnancies. A second instance.

Another instance of a female in my own knowledge is the eldest daughter of a respectable tradesman in London, about three and twenty, who has a brother an albino, about ten years younger than herself. She was the first child of her parents, the boy the last, and none of the intermediate children had any thing peculiar in their appearance. A third.

I am farther informed, that two albinesses, both young, are now exhibiting about the country with their brother, who is an albino. They are said to be natives of Ireland, but I have not been able to get any certain information respecting them. Two more.

I likewise remember an albiness, perhaps eight or nine years old, being introduced one evening to the society at Guy's Hospital about twenty years ago; and had supposed it might be the same person as is now to be seen at Spring Gardens: but she assures me, that neither she nor her sister had ever been shown at Guy's, or any other place, till she began to be exhibited in public a few years ago. Thus there would appear to have been no less than six females of this description born in the United Kingdom within these thirty years: and if none have been noticed by writers, it is probably to be ascribed to the greater care, with which women endeavour to conceal any thing they would consider as a personal blemish, or to shun the view of strangers, when A sixth.  
marked

marked by any thing singular. In confirmation of this it may be added, that the young lady I have mentioned conceals her peculiarity as much as possible by wearing a wig that falls down over her eyebrows, and a bonnet as large as fashion will allow.

## II.

*Description of a new Eudiometer, accompanied with Experiments, elucidating its Application. By WILLIAM HASLEDINE PEPYS, Esq. Communicated by CHARLES HATCHETT, Esq. F. R. S\*.*

Atmospheric air of great importance in various natural and artificial processes.

THE important part which atmospheric air performs, in maintaining the principle of life in animals, in combustion of every description, the acidification, and oxidation of a great variety of substances, and in numerous other processes both of nature and art, gives a high degree of interest to every thing calculated to extend our knowledge of its nature and properties.

Many other aeriform fluids.

The evidence furnished by modern chemistry, of the existence of many other aeriform substances, increases this interest, especially when it is considered that, owing to their possessing some of the most obvious properties of atmospheric air, as transparency, elasticity, and a power of great expansion, on being exposed to an increase of temperature, they were with very few exceptions, till lately, confounded either with common air, or not even suspected to exist.

Frequently evolved when little expected.

When to these considerations we add the facility, with which some products, especially the gaseous, are evolved, in circumstances under which, in the present state of our knowledge, we should hardly look for them; the power they possess of decomposing each other, and, by an interchange and new arrangement of principles, of producing compounds, possessing properties altogether different from those of the ingredients supposed to be present; and the facilities which every new detection of unsuspected principles

\* From the Philosophical Trans. for 1807, Part II, p. 247.

affords,



affords, toward the discovery of others, and consequently the composition, or analysis of bodies before held to be simple, it will not appear a matter of surprise, that the subject of eudiometry should have obtained a considerable degree of attention from modern philosophers. Hence eudiometry claims much attention.

This would be an improper place to enumerate all that has been done, or proposed, by different men of eminence, towards the production of something like a perfect system on this important subject; yet some allusion to their labours appears to be indispensable, and will be the means of preventing some circumlocution in our farther progress. What has been done on the subject.

Hales\* appears to be the first who observed absorption to take place in common air, on mixing it with air obtained from a mixture of *Walton pyrites* and *spirit of nitre*; and that in this process from being clear they became "a reddish turbid fume." Hales.

Dr. Priestley, as he informs us in his *Observations on different kinds of Air*†, was much struck with this experiment, but never expected to have the satisfaction of seeing this remarkable appearance, supposing it to be peculiar to the *Walton pyrites*, till encouraged by a suggestion of Mr. Cavendish, that probably the red appearance of the mixture depended upon the spirit of nitre only, he tried solutions of the different metals in that acid, and, catching the air which was generated, obtained what he wished. To the air thus produced he gave the name of *nitrous air*; and, from its possessing the properties of absorbing that portion of atmospheric air which he calls *dephlogisticated*, first proposed its being used as a test for ascertaining the purity of air. His method of proceeding was ingenious and simple; known quantities of the air to be tried, and of nitrous gas, being mixed, were admitted, after the diminution of volume occasioned by their union, into a graduated tube, which he denominated a *eudiometer*. Priestley. The first eudiometer.

It was with the test of nitrous gas, that Mr. Cavendish‡ made his masterly analysis of the air at Kensington and London; and by many laborious processes and comparative Cavendish's analysis of common air.

\* Statical Essays, Vol. I, p. 224; Vol. II, p. 280.

† Phil. Trans. for 1783, † Phil. Trans. for 1772, p. 210.

trials obtained results, the accuracy of which has been more distinctly perceived, the more the science of chemistry has advanced.

Phosphorus  
and sulphuret  
of potash em-  
ployed.

The slow combustion of phosphorus, which unites with the oxygen to form an acid, and the decomposition of the fluid sulphuret of potash, are certain methods of separating combinations consisting of oxygen and azote: but the decomposition is effected so slowly, by the action of these substances, that it became a desirable object, to discover some means for accelerating the process. This was supposed to have been effected by Guyton, who proposed heating the sulphuret of potash; in doing this, sulphuretted hydrogen gas however is frequently evolved, which, mixing with the residual gas, increases its quantity, and renders the result fallacious.

Guyton.

Davy.

Sulphate of  
iron impregna-  
ted with ni-  
trous gas.

The green sulphate of iron impregnated with nitrous gas, first discovered by Dr. Priestley, and recently used by Mr. Davy for eudiometrical purposes, from its possessing the property of absorbing oxygen gas from the atmosphere, is much to be preferred to the method with nitrous gas, as the green sulphate of iron does not combine with the other gasses, with which the nitrous gas is commonly found to be contaminated, and more certain results are obtained.

A correct and  
commodious  
apparatus still  
wanting.

Having had occasion to repeat many of the experiments of others, and to make some new ones, I soon found what every one, who has been engaged on the same subject, must have experienced; that an apparatus more commodious than has yet been proposed, and at the same time capable of giving correct results, with the greatest minuteness, was still a desideratum in eudiometry. To detail the various ideas, that presented themselves on the subject, would be an unnecessary encroachment on the time of this Society: but as I at last succeeded in contriving an instrument, possessing the above properties in a very eminent degree, I flatter myself I shall not be thought intrusive, in offering a description of it.

Description of  
that invented  
by the author.

This apparatus, which is of easy construction, and extremely portable, consists of a glass measure M, pl. III, fig. 1, graduated into hundred parts; a small gum elastic bottle B, fig. 4, capable of containing about twice the quantity of the measure, and furnished with a perforated glass stopper,

S,

# New Eudiometer by W. H. Peppys Esq.<sup>r</sup>

Fig. 3.

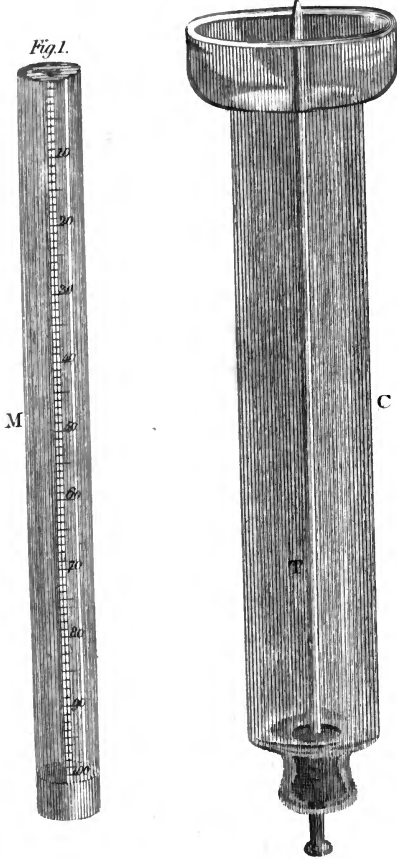
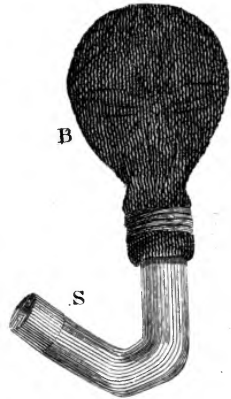

Fig. 2.



Fig. 4.



Undulation of Light

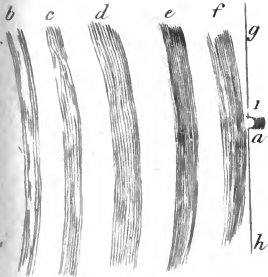
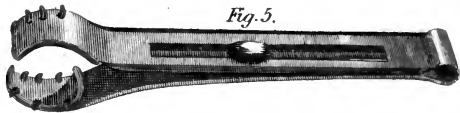
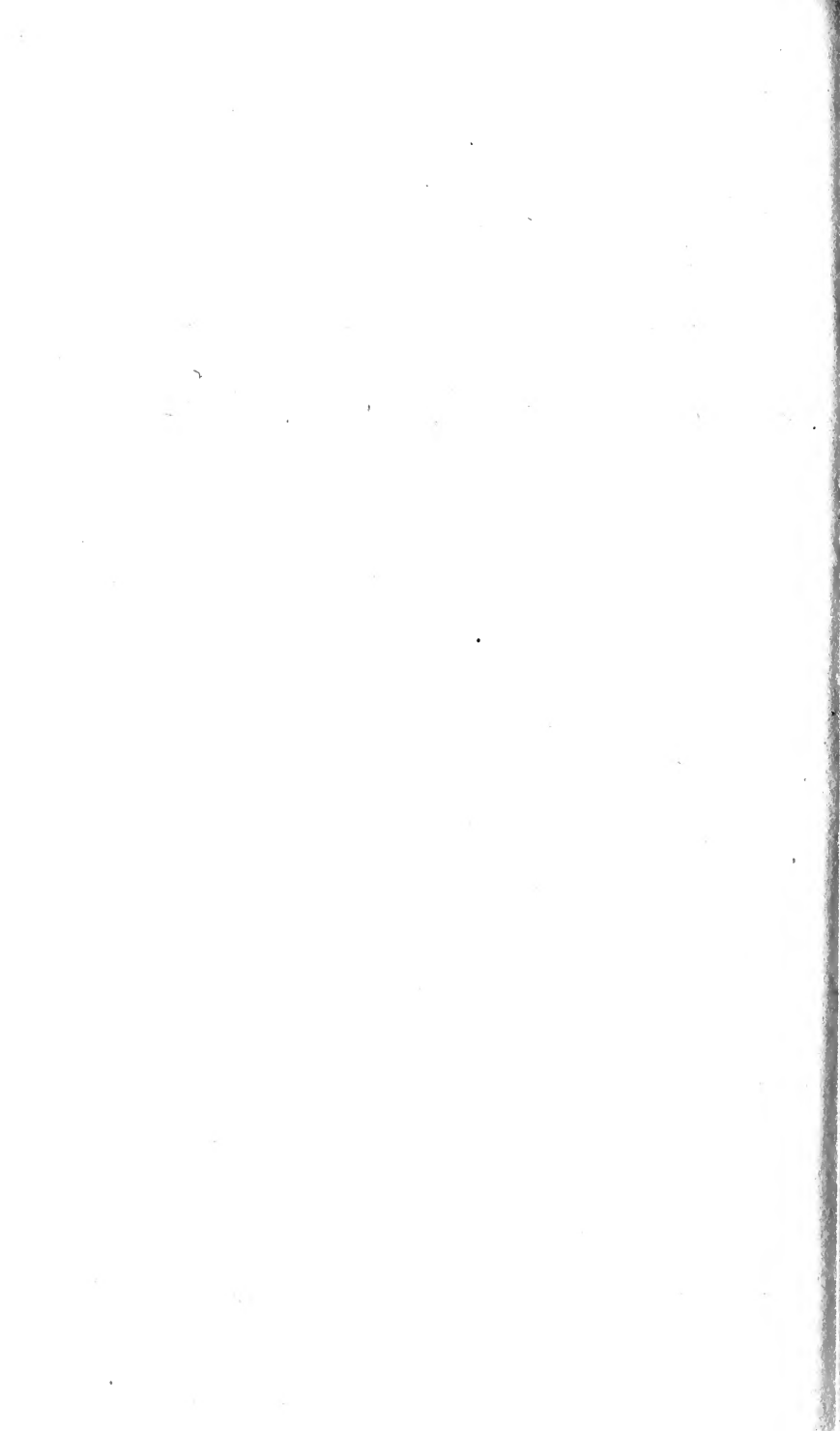

Fig. 6.

Fig. 5.





S, which is well secured in the neck of it, by means of waxed thread wound tight round it: and a glass tube, T, fig. 3, also graduated, but into tenths of the former divisions, or into thousandth parts of the measure.

The glass stopper, made fast in the neck of the gum elastic bottle, as above mentioned, has its exterior end ground with emery, exactly to fit the mouth of the measure. To the lower end of the graduated tube T is cemented a small steel cock, which is secured into the neck of a very small gum elastic bottle, fig. 2, by means of waxed thread. The other end of the tube is conical, so as to present a very small orifice.

Beside this, the apparatus is furnished with a kind of movable cistern C, in which the tube can be slid easily up and down, and yet in such a manner, that the water or other liquid in the cistern may not pass. This is easily accomplished by means of a cork fitted into its mouth, with a perforation through its axis to receive the tube. The cistern, when in use, is to be filled with water, or mercury, as the experiment may require, and becomes a secondary cistern for the measure, as will be more clearly understood, by the following description of the method of performing experiments with this instrument.

The measure is filled with the air, or gas, over mercury in the usual manner; and the elastic bottle is charged with the solution, intended to be employed as the reagent: the orifice of the stopper is then inserted into the mouth of the measure, in the mercury, and pressed home to its place. Manner of using it.

The bottle and measure, being thus united, are to be firmly held at the joint. Upon pressing the former, a portion of the fluid is injected into the latter, and the gas suffers a degree of compression, by which the action of the affinity, between it and the fluid, is accelerated. On taking off the pressure, the bottle, by its elasticity, endeavours to obtain its original form, and receives back the fluid. This process should be continued as long as any absorption is observed to take place. When absorption ceases, the bottle is to be separated from the measure under mercury, and the quicksilver which remains in the measure being brought to the

the level of that in the cistern, the quantity of absorption is then to be determined, which is done as follows :

Method of ascertaining the absorption.

Suppose atmospheric air has been the subject of the experiment, and consequently a large residuum left: first note the hundredth parts: and then, to obtain a knowledge of the fractional parts, remove the measure into the small cistern, in which the graduated tube filled with mercury is placed; slide the tube above the surface of the fluid in the measure, and, opening the stop-cock, suffer the mercury to descend, till it has drawn the fluid in the measure to a regular division; then stop the cock, and register the hundredth parts on the measure, and the thousandth parts on the graduated tube; the united quantities give the sum of the residual gas. Observe well in registering the thousandth parts, that the fluids are exactly on a level, on the outside and the inside of the measure; this may be easily effected, by pouring out a portion of the liquid of the small cistern, or adding thereto.

When the residuum is very small.

If instead of atmospheric air, a gas is tried, which so far as it is uncontaminated can be nearly wholly absorbed by the reagents employed, the process becomes exceedingly simple; for if the residuum is under a hundredth part of the measure, it may be transferred completely into the graduated tube, and its quantity at once ascertained.

Advantage of the bent tube.

The stopper S would have injected the fluid with greater velocity had it been straight; but it would not then have been so convenient in the analysis of compound gasses, where both mercury and hot solutions are occasionally employed; as the mercury would have so compressed the fluid in the bottle, in introducing it under that metal, as to have thrown out a portion of its contents, and also have robbed the hot solutions of the temperature, which was necessary to their perfect action.

Mode of reducing the measure to a proper size,

As to the size of the measure M, I have generally preferred the cubic inch divided into hundredth parts. This is easily effected by taking a stout glass tube about half an inch calibre, sealing one end, then weighing 3422 grains of mercury, equal to 252 grains of distilled water at temperature 50° Fahrenheit. This is introduced into the tube; the extra length is cut off with a sharp-edged file, care being taken to leave a sufficient portion to grind the perforated stopper S into its mouth.

The

The divisions are obtained by a small measure, made from a glass tube sealed at the end, and cut off exactly to the hundredth part of a cubic inch, equal to 34.2 grains of mercury, which, being ground flat, is stopped by a piece of plate-glass, and the divisions marked by the diamond, upon the introduction of each hundredth part of mercury into the measure M. and graduating it.

The tube T is divided into tenths of the measure M, or thousandth parts of a cubic inch. This is done by measuring one hundredth part of a cubic inch into the tube, and dividing it into ten parts, marking the divisions with fluoric acid, or black enamel. Mode of graduating the tube.

To prove the accuracy of the instrument, I shall proceed to relate a few experiments made with it.

The elastic bottle being filled with the solution of sulphate of iron impregnated with nitrous gas, and the measure with atmospheric air, they were united, and by gentle injection  $\frac{2}{1000}$  were absorbed. Experiments to prove its accuracy.

If the experiment is made hastily, the impregnated solution loses a portion of its nitrous gas, which must be again absorbed by a solution of green sulphate of iron.

For ascertaining the purity of nitrous gas, the bottle may be charged with the solution of green sulphate or muriate of iron.

For carbonic acid gas, with lime or barytic water.

For oxygen gas\*, with the solution of green sulphate of iron impregnated with nitrous gas.

For sulphuretted hydrogen gas, a solution of nitrate of silver was put into the elastic bottle, and sulphuretted hydrogen gas† into the graduated measure. Upon the first injection, the solution took a black flocculent appearance, and a considerable portion of the gas was absorbed. After repeating the process as before mentioned, the residuum was  $\frac{5}{1000}$ .

The instrument may be likewise generally applied to the analysis of mixed gasses. Mixed gasses may be analysed by it.

I have been able completely to separate the carbonic acid gas from the sulphuretted hydrogen, by a solution of the ni-

\* Obtained from oximuriate of potash by heat.

† Obtained from sulphuret of potash by diluted muriatic acid, and collected and preserved with the greatest care.

trate of silver, or of mercury employed hot. The carbonic acid gas is expanded in this process, but on standing over mercury it returns to its original volume. The sulphuretted hydrogen, in this instance, is taken up by the metallic nitrate.

Carbonic acid gas decomposes acetite of lead.

It should be here observed, that the acetite of lead must not be used, as the carbonic acid gas, even at a high temperature, decomposes it, forming carbonate of lead.

Why the solutions should be used hot.

The propriety of using the solutions hot will be seen, when we recollect, that the carbonic acid gas is soluble in the water of solution at the common temperature of all these compounds.

Nitrous gas and carbonic acid gas.

Nitrous gas, and carbonic acid gas, may be separated by means of the hot solution of the green sulphate of iron. To effect this, heat a solution on a glass capsule over a spirit lamp until ebullition. Having filled the measure with the compound gas, charge the elastic bottle with the hot solution, and unite them. The nitrous gas in two or three injections will be absorbed, changing the colour of the solution, while the carbonic acid gas will be a little rarefied, but no absorption of it will take place.

Gasses absorbed by alcohol,

Previous to these experiments on the compound gasses, I had tried several on the carbonic acid, sulphuretted hydrogen, and nitrous gasses in their unmixed states. One hundred parts of pure alcohol at the common temperature will absorb 70 parts in volume of carbonic acid, and the same quantity of sulphuretted hydrogen. Alcohol impregnated with the latter precipitates the solutions of the nitrates of lead, silver, and mercury, of a dark brown colour. Nitric acid of the specific gravity 1.4, and also of 1.25, absorbs carbonic acid gas, without any apparent change in the nitric acid. Sulphuretted hydrogen gas is also absorbed by nitric acid, which occasions a slight milky cloud or precipitate therein.

by nitric acid,

and by nitrates.

The solutions of nitrates of barytes, strontian, and lime, absorb carbonic acid gas equal to half their volume, without any apparent alteration.

Solutions of nitrates of barytes, strontian, and lime, also absorb sulphuretted hydrogen gas, equal to  $\frac{6}{10}$  of their volume, with a slight change of colour; the solutions thus impregnated precipitate solutions of nitrate of mercury and



of silver, and acetite of lead, of a dark brown colour, and would be useful as chemical reagents.

Carbonic acid gas, as I have before stated, decomposes solutions of the acetite of lead, hot or cold, forming a precipitate of carbonate of lead.

Carbonic acid gas is absorbed by the solution of the green sulphate of iron, under the temperature of 100° Fahrenheit: but this is only the action of the water of solution. If the temperature be near boiling, or above 180° Fahrenheit, the solution increases the volume of the gas without the slightest absorption; after carbonic acid gas has in this way been treated with the hot solutions, it is still soluble in water at the common temperature, or in aqueous solutions of lime, or alkali.

Carbonic acid gas absorbed only by the water in solution of sulphate of iron.

Nitrous gas is absorbed by solution of sulphuret of potash, with a separation or formation of sulphur. Upon injecting the solution the sides of the measure take a milky appearance, which on the second injection is washed down, insoluble in the liquor. About 80 parts from 100 of gas are absorbed.

Nitrous gas.

Nitrous gas is also absorbed by nitrate of copper in solution, without any peculiar alteration.

In these experiments, great care must be taken not to increase the temperature of the gas by the hand. To prevent this I use a pair of small circular-mouthed forceps, lined with cloth, which firmly grasp the measure, fig. 5; and if the experiments should in any way be delayed, a corresponding manometer will always be sufficient to correct the error occasioned by change of atmospheric temperature and pressure.

Forceps used to prevent increase of temperature from the hand.

To ascertain the quantity of carbonic acid gas, contained in oxygen gas (of a known purity,) after combustion, or decomposition of carbonaceous substances, lime water will be found sufficient.

Examination of oxygen for carbonic acid after combustion,

If it is required to know the purity of the oxygen gas, after the carbonic acid gas has been absorbed, the best method, and the least liable to error, is to withdraw the residual oxygen gas, by means of the small graduated tube before described.

and for other gasses.

To do this, remove the measure into the small cistern of mercury;

mercury; press the quicksilver out of the small bottle by the fingers and thumb, and let the tube rise a sufficient height within the measure, that the bottle extending itself shall withdraw the whole of the gas from the measure, taking care that the cock be stopped as soon as it has completed it, and also to prevent the solution from entering the tube.

If the opening of the tube is small, it may then be drawn down into the mercury, without the possibility of any portion of the gas escaping, while the measure is dried or cleaned, or a fresh one filled with mercury supplied to receive it.

Convenience  
of this mode of  
transferring  
gasses.

This way of transferring will be found very advantageous, particularly in the separation of gasses liable to be absorbed under certain temperatures; and also where a new series of reagents is to be employed, as from the depositions of former solutions on the glass measure a source of considerable error would arise.

Farther in-  
structions for  
using the ap-  
paratus.

The residual oxygen gas being thus transferred into a clean dry measure, the processes before described for examining oxygen gas may be then used; or the quantity of carbonic acid gas (for examination) being found by lime water, another measure of the gas may be tried, first with the green sulphate of iron impregnated with nitrous gas, and then with the green sulphate in solution only: these will take up both the carbonic acid gas, and the oxygen gas, leaving only such residual gas as the oxygen might have originally contained.

Transferring is not here necessary, as the two solutions may be used one after the other, taking care to use the solution of green sulphate last.

Where it is not requisite to transfer the gas into a dried or clean measure, previous to the use of another solution, as in the instance I have just mentioned, a quantity of the first solution may be withdrawn, by simply filling the elastic bottle with mercury, then joining it to the measure, and by inclining the measure, the mercury by its gravity will displace the former solution.

If at any time the gas should get drawn into the elastic bottle, it may be very easily returned into the measure, by inclining sometimes the bottle, and sometimes the measure. The only error that could arise from this is, an increase of temperature in the gas, which may be rectified, by plunging the

the

the whole apparatus into mercury, or water, of the standard temperature.

The advantages of this construction of the eudiometer will be readily perceived by all those, who are in the habit of making chemical experiments. The portion of gas to be examined is completely under command; it may be agitated without the least fear of the intrusion of any atmospheric air, and the process thereby very materially shortened. The gum elastic is a substance so little acted upon by chemical agents, that a great variety may be employed; and above all, we can very conveniently use hot solutions, which will be found an important auxiliary in the examination of some compound gasses.

Advantages of this eudiometer.

Simple as this instrument may appear, it is calculated to extend our knowledge of the different kinds of air, by the precision and accuracy which it enables us to obtain, and which solely constitute the value of every experiment. A degree of confidence is inspired from knowing, that we can depend upon our results; and hence much valuable time, which would have been wasted in uncertain, if not useless investigations, may be directly applied to the advancement of science.

### III.

*On the Revival of an Obsolete Mode of managing Strawberries. By the Right Hon. Sir JOSEPH BANKS, Bart. K. B. P. R. S. &c.\**

THE custom of laying straw under strawberry plants, when their fruit begins to swell, is probably very old in this country: the name of the fruit bears testimony in favour of this conjecture, for the plant has no relation to straw in any other way, and no other European language applies the idea of straw in any shape to the name of the berry, or to the plant that bears it.

Straw formerly laid under strawberry plants in this country.

Hence the name.

When Sir Joseph Banks came to Spring Grove, in 1779, Practised with.

\* From the Transactions of the Horticultural Society, Vol. I, Part I, p. 54.

In these 30 years.

he found this practice in the garden: John Smith, the gardener, well known among his brethren as a man of more than ordinary abilities in the profession, had used it there many years; he learned it soon after he came to London from Scotland; probably at the Neat Houses, where he first worked among the market gardeners, it is therefore clearly an old practice, though now almost obsolete.

Attended with various advantages.

Its use in preserving a crop is very extensive: it shades the roots from the sun; prevents the waste of moisture by evaporation, and consequently, in dry times, when watering is necessary, makes a less quantity of water suffice than would be used if the sun could act immediately on the surface of the mould; besides, it keeps the leaning fruit from resting on the earth, and gives the whole an air of neatness as well as an effect of real cleanliness, which should never be wanting in a gentleman's garden.

Expense of the practice

The strawberry beds in that garden at Spring Grove, which has been measured for the purpose of ascertaining the expense incurred by this method of management, are about 75 feet long, and five feet wide, each containing three rows of plants, and of course requiring four rows of straw to be laid under them. The whole consists of 600 feet of beds, or 1800 feet of strawberry plants, of different sorts, in rows. The strawing of these beds consumed this year, 1806, the long straw of 26 trusses, for the short straw being as good for litter as the long straw, but less applicable to this use, is taken out; if we allow then, on the original 26 trusses, six for the short straw taken out and applied to other uses, 20 trusses will remain, which cost this year 10*d.* a truss, or 16*s.* 8*d.* being one penny for every nine feet of strawberries in rows.

a mere trifle.

The straw makes manure:

From this original expenditure the value of the manure made by the straw when taken from the beds must be deducted, as the whole of it goes undiminished to the dung-hill as soon as the crop is over. The cost of this practice therefore cannot be considered as heavy; in the present year not a single shower fell at Spring Grove, from the time the straw was laid down till the crop of scarlets was nearly finished, at the end of June. The expense of strawing was therefore many times repaid by the saving made in the labour

and much labour and water

bour

hour of watering, and the profit of this saving was immediately brought to account in increase of other crops, by the use of water spared from the strawberries; and besides, the berries themselves were, under this management, as fair and nearly as large as in ordinary years, but the general complaint of the gardeners this year was, that the scarlets did not reach half their natural size, and of course required twice as many to fill a pottle as would do it in a good year.

In wet years the straw is of less importance in this point of view, but in years moderately wet, the use of straw sometimes makes watering wholly unnecessary, when gardeners who do not straw are under the necessity of resorting to it; and we all know if watering is once begun, it cannot be left off till rain enough has fallen to give the ground a thorough soaking.

Even in wet years the straw does considerable service, heavy rains never fail to dash up abundance of mould, and fix it upon the berries, this is entirely prevented, as well as the dirtiness of those berries that lean down upon the earth, so that the whole crop is kept pure and clean: no earthy taste will be observed in eating the fruit that has been strawed, and the cream which is sometimes soiled when mixed with strawberries, by the dirt that adheres to them, especially in the early part of the season, will retain to the last drop that unsullied red and white, which give almost as much satisfaction to the eye while we are eating it, as the taste of that most excellent mixture does to the palate.

---

#### IV.

*On raising new and early Varieties of the Potato (Solanum Tuberosum).* By THOMAS ANDREW KNIGHT, Esq. F. R. S. &c\*.

THE potato contributes to afford food to so large a portion of the inhabitants of this country, that every improvement in its culture becomes an object of national impor-

\* From the Trans. of the Horticultural Society, vol I, p. I, p. 57.

tance; and thence I am induced to hope, that the following communication may not be unacceptable to the Horticultural Society.

Early potatoes  
without blossoms.

Every Person, who has cultivated early varieties of this plant, must have observed, that they never afford seeds, nor even blossoms; and that the only method of propagating them is by dividing their tuberous roots: and experience has sufficiently proved, that every variety, when it has been long propagated, loses gradually some of those good qualities, which it possessed in the earlier stages of its existence, Dr. Hunter, in his *Georgical Essays*, I think has limited the duration of a variety, in a state of perfection, to about fourteen years: and probably, taking varieties in the aggregate, and as the plant is generally cultivated, he is nearly accurate. A good new variety of an early potato is therefore considered a valuable acquisition by the person, who has the good fortune to have raised it; and as an early variety, according to any mode of culture at present practised, can only be obtained by accident from seeds of late kinds, one is not very frequently produced: but by the method I have to communicate, seeds are readily obtained from the earliest and best varieties; and the seeds of these, in successive generations, may, not improbably, ultimately afford much earlier and better varieties, than have yet existed.

Degenerate  
from continued  
propagation by  
roots.

Varieties continue in  
perfection about  
14 years.

Early potatoes  
fail to seed,  
from soon  
forming tubers

I suspected the cause of the constant failure of the early potato to produce seeds, to be the preternaturally early formation of the tuberous root; which draws off, for its support, that portion of the sap, which, in other plants of the same species, affords nutriment to the blossoms and seeds; and experiment soon satisfied me, that my conjectures were perfectly well founded.

I took several methods of placing the plants to grow, in such a situation, as enabled me readily to prevent the formation of tuberous roots; but the following appearing the best, it is unnecessary to trouble the Society with an account of any other.

Method of preventing this.

Having fixed strong stakes in the ground, I raised the mould in a heap round the bases of them; and in contact with the stakes, on their south sides, I planted the potatoes from which I wished to obtain seeds. When the young plants

plants were about four inches high, they were secured to the stakes with shreds and nails, and the mould was then washed away, by a strong current of water, from the bases of their stems, so that the fibrous roots only of the plants entered into the soil. The fibrous roots of this plant are perfectly distinct organs from the runners, which give existence, and subsequently convey nutriment, to the tuberous roots; and as the runners spring from the stems only of the plants, which are, in the mode of culture I have described, placed wholly out of the soil, the formation of tuberous roots is easily prevented; and whenever this is done, numerous blossoms will soon appear, and almost every blossom will afford fruit and seeds. It appears not improbable, that by introducing the farina of the small, and very early varieties into the blossoms of those of larger size, and somewhat later habits, moderately early varieties, adapted to field culture, and winter use, might be obtained; and the value of these to the farmer in the colder parts of the kingdom, whose crop of potatoes is succeeded by one of wheat, would be very great. I have not yet made any experiment of this kind; but I am prepared to do it in the present spring.

The proper root distinct from the runners.

Moderately early varieties perhaps obtainable by mixture.

---



---

## V.

*An Account of two Children born with Cataracts in their Eyes, to show that their Sight was obscured in very different Degrees; with Experiments to determine the proportional Knowledge of Objects acquired by them immediately after the Cataracts were removed. By EVERARD HOME, Esq. F.R.S\*.*

**M**R. Cheselden's observations on this subject, recorded in the Phil. Trans. for the year 1728, pointed out two material facts; that vision alone gives no idea of the figure of objects, or their distance from the eye, since a very intelligent

Cheselden's observations.

\* Phil. Trans. for 1806, Part I, p. 83.

boy, 13 years of age, upon recovering his sight was unable to distinguish the outline of any thing placed before him, and thought that every object touched his eye.

Ware's in opposition to them.

Mr. Ware's cases, which have also a place in the *Phil. Trans.* for 1801, and are compared with that of Mr. Cheselden, appear to lead to a different conclusion. The following observations are laid before the Society with a view to explain this circumstance.

Boy born blind.

CASE 1. William Stiff, twelve years of age, was admitted into St. George's Hospital under my care, on the 17th of July, 1806, with cataracts in his eyes, which, according to the account of his mother, existed at the time of birth. From earliest infancy he never stretched out his hand to catch at any thing, nor were his eyes directed to objects placed before him, but rolled about in a very unusual manner, although in other respects he was a lively child. The eyes were not examined till he was six months old, and at that time the cataracts were as distinct as when he was received into the hospital.

Distinguished light, & could discern the sun or a candle.

Previous to an operation being performed, the following circumstances were ascertained respecting his vision. He could distinguish light from darkness, and the light of the sun from that of a fire or candle: he said it was redder, and more pleasant to look at, but lightning made a still stronger impression on his eyes. All these different lights he called red. The sun appeared to him the size of his hat. The candle flame was larger than his finger, and smaller than his arm. When he looked at the sun he said it appeared to touch his eye. When a lighted candle was placed before him both his eyes were directed towards it, and moved together. When it was at any nearer distance than 12 inches, he said it touched his eyes. When moved further off he said it did not touch them; and at 22 inches it became invisible.

One of the cataract extracted at 12 years of age.

On the 21st of July the operation of extracting the crystalline lens was performed on the left eye. The capsule of the lens was so very strong as to require some force to penetrate it. When wounded, the contents, which were fluid, rushed out with great violence. Light became very distressing to his eye, and gave him pain. After allowing the eyelids



lids to remain closed for a few minutes, and then opening them, the pupil appeared clear, but he could not bear exposure to light. On my asking him what he had seen, he said, "your head, which seemed to touch my eye:" but he could not tell its shape. He went to bed, and took an opiate draught: the pain in his eye lasted about an hour, after which he fell asleep. The whole of that day the light was distressing to his eye, so that he could not bear the least exposure to it.

Effects of the operation.

On the 22d the eye-lids were opened to examine the eye. The light was less offensive. He said he saw my head, which touched his eye. There was so much inflammation on the eye-ball, that a leech was applied to the temple, and the common means for removing inflammation were used.

On the 23d the eye was less inflamed, and he could bear a weak light. The pupil was of an irregular figure, and the wounded cornea had not united with a smooth surface. He said he could see several gentlemen round him, but could not describe their figure. My face, while I was looking at his eye, he said was round and red.

On the 25th the inflammation had subsided, but on the 27th returned, and continued notwithstanding different means were employed for its removal, till the 1st of August, when it was almost entirely gone. On the 4th the eye was apparently so well, that an attempt was made in the presence of Mr. Cavendish and Dr. Wollaston to ascertain its powers of vision; but it was so weak, that it became necessary to shade the glare of light by hanging a white cloth before the window. The least exertion fatigued the eye, and the cicatrix on the cornea, to which the iris had become attached, drew it down so as considerably to diminish the pupil. From these circumstances nothing could be satisfactorily made out respecting the boy's vision. On the 11th a second attempt was made in the presence of Mr. Cavendish, but the pupil continued so contracted and irregular, and the eye so imperfect in its powers, that it became necessary a second time to postpone any experiments.

On the 16th of September the right eye was couched. This operation was preferred after what had happened to the other eye, in the hope that there would not be the same degree

The other eye couched.

gree

gree of inflammation, and as the former cataract was fluid, there was every reason to believe that couching would in this instance be most efficacious.

Effects of this operation.

The operation gave pain, and the light was so distressing to his eye, that the lids were closed as soon as it was over, and he was put to bed. The consequent inflammation was not severe, but as soon as the fluid cataract, which had been diffused through the aqueous humour, was absorbed, the capsule of the lens was found to be opaque, and the sight consequently imperfect. The eyes were not examined with respect to their vision till the 13th of October, during which period the boy remained quiet in the hospital. On that day the upper part of the pupil of the left eye had in some measure recovered its natural state, and had become transparent, but the cicatrix in the cornea was more extensively opaque than before. The light now was not distressing to either eye, and when strong, he could readily discern a white, red, or yellow colour, particularly when bright and shining. The sun and other objects did not now seem to touch his eyes as before, they appeared to be at a short distance from him. The eye, which had been couched, had the most distinct vision of the two, but in both it was imperfect. The distance at which he saw best was five inches.

When the object was of a bright colour, and illuminated by a strong light, he could make out that it was flat and broad; and when one corner of a square substance was pointed out to him, he saw it, and could find out the other, which was at the end of the same side, but could not do this under less favourable circumstances. When the four corners of a white card were pointed out, and he had examined them, he seemed to know them, but when the opposite surface of the same card, which was yellow, was placed before him, he could not tell whether it had corners or not, so that he had not acquired any correct knowledge of them, since he could not apply it to the next coloured surface, whose form was exactly the same, with that, the outline of which the eye had just been taught to trace.

Another boy born blind.

CASE II. John Falter, seven years of age, was admitted into St. George's Hospital on the 1st of October, 1806, under

der's care, with cataracts in both eyes, which according to the accounts of his relations had existed from his birth.

After he was received into the hospital, the following circumstances were ascertained respecting his vision. The pupils contracted considerably when a lighted candle was placed before him, and dilated as soon as it was withdrawn. He was capable of distinguishing colours with tolerable accuracy, particularly the more bright and vivid ones. Distinguished light & colours

On the 6th of October the left eye was couched. This operation was preferred to extraction, from a belief, that the cataracts were not solid, and as the injury done to the capsule by the operation would be less, there was not the same chance of inflammation, the disposition for which had been so strong in the former case. As the eye was not irritable, and was likely to be but little disturbed by this operation, every thing was previously got ready for ascertaining his knowledge of objects, as soon as the operation was over, should the circumstances prove favourable. The operation was attended with success, and gave very little pain. One eye couched at 7 years old. The eye was allowed ten minutes to recover itself: a round piece of card of a yellow colour, one inch in diameter, was then placed about six inches from it. He said immediately, that it was yellow, and on being asked its shape said, "Let me touch it, and I will tell you." Being told that he must not touch it, after looking for some time, he said it was round. A square blue card, nearly the same size, being put before him, he said it was blue and round. A triangular piece he also called round. The different colours of the objects placed before him he instantly decided on with great correctness, but had no idea of their form. He moved his eye to different distances, and seemed to see best at 6 or 7 inches. His focal distance has been since ascertained to be 7 inches. He was asked whether the object seemed to touch his eye, he said "No;" but when desired to say at what distance it was, he could not tell. These experiments were made in the theatre of the hospital, in which the operation was performed, before the surgeons and all the students. He was highly delighted with the pleasure of seeing, and said it was "so pretty," even when no object was before him, only the light upon his eye. The eye was covered, Effects of the operation. and

Sense of vision  
after the oper-  
ation.

and he was put to bed, and told to keep himself quiet, but upon the house-surgeon going to him half an hour afterwards, his eye was found uncovered, and he was looking at his bed curtains, which were close drawn. The bandage was replaced, but so delighted was the boy with seeing, that he again immediately removed it. This circumstance distressed the house-surgeon, who had been directed to prevent him from looking at any thing till the next day, when the experiment was to be repeated. Finding that he could not enforce his instructions, he thought it most advisable to repeat the experiment about two hours after the operation. At first the boy called the different cards round; but upon being shown a square, and asked if he could find any corners to it, he was very desirous of touching it. This being refused, he examined it for some time, and said at last that he had found a corner, and then readily counted the four corners of the square; and afterwards when a triangle was shown him, he counted the corners in the same way; but in doing so his eye went along the edge from corner to corner, naming them as he went along.

Next day, when I saw him, he told me he had seen "the soldiers with their fifes and pretty things." The guards in the morning had marched past the hospital with their band; on hearing the music he had got out of bed, and gone to the window to look at them. Seeing the bright barrels of the musquets, he must in his mind have connected them with the sounds which he heard, and mistaken them for musical instruments. On examining the eye 24 hours after the operation, the pupil was found to be clear. A pair of scissors was shown him, and he said it was a knife. On being told he was wrong, he could not make them out; but the moment he touched them he said they were scissors, and seemed delighted with the discovery. On being shown a guinea at the distance of 15 inches from his eye, he said it was a seven shilling piece, but placing it about 5 inches from his eye, he knew it to be a guinea; and made the same mistake, as often as the experiment was repeated.

From this time he was constantly improving himself by looking at, and examining with his hands, every thing within his reach, but he frequently forgot what he had learnt.

On

On the 10th I saw him again, and I told him his eye was so well, that he might go about as he pleased without leaving the room. He immediately went to the window, and called out, "What is that moving?" I asked him what he thought it was? He said, "A dog drawing a wheelbarrow. There is one, two, three dogs drawing another. How very pretty!" These proved to be carts and horses on the road, which he saw from a two pair of stairs window.

Sense of vision after the operation.

On the 19th, the different coloured pieces of card were separately placed before his eye, and so little had he gained in thirteen days, that he could not without counting their corners one by one tell their shape. This he did with great facility, running his eye quickly along the outline, so that it was evident he was still learning, just as a child learns to read. He had got so far as to know the angles, when they were placed before him, and to count the number belonging to any one object.

The reason of his making so slow a progress was, that these figures had never been subjected to examination by touch, and were unlike any thing he was accustomed to see.

He had got so much the habit of assisting his eyes with his hands, that nothing but holding them could keep them from the object.

On the 26th the experiments were again repeated on the couched eye, to ascertain the degree of improvement which had been made. It was now found that the boy, on looking at any one of the cards in a good light, could tell the form nearly as readily as the colour.

From these two cases the following conclusions may be drawn :

That, where the eye, before the cataract is removed, has only been capable of discerning light, without being able to distinguish colours, objects after its removal will seem to touch the eye, and there will be no knowledge of their outline; which confirms the observations made by Mr. Cheselden :

General conclusions.

That where the eye has previously distinguished colours, there must also be an imperfect knowledge of distances, but not of outline, which however will afterwards be very soon acquired, as happened in Mr. Ware's cases. This is proved

proved by the history of the first boy in the present Paper, who before the operation had no knowledge of colours or distances, but after it, when his eye had only arrived at the same state; that the second boy's was in before the operation, he had learnt that the objects were at a distance, and of different colours: that when a child has acquired a new sense, nothing but great pain or absolute coercion will prevent him from making use of it.

Cataracts in children generally soft, and couching preferable to extraction.

In a practical view, these cases confirm every thing, that has been stated by Mr. Pott and Mr. Ware, in proof of cataracts in children being generally soft, and in favour of couching, as being the operation best adapted for removing them. They also lead us to a conclusion of no small importance, which has not before been adverted to; that, when the cataract has assumed a fluid form, the capsule, which is naturally a thin transparent membrane, has to resist the pressure of this fluid, which like every other diseased accumulation is liable to increase, and distend it, and therefore the capsule is rendered thicker and more opaque in its substance, like the coats of encysted tumours in general.

The earlier the operation is performed the better.

As such a change is liable to take place, the earlier the operation is performed in all children, who have cataracts completely formed, the greater is their chance of having distinct vision after the operation. It is unnecessary to point out the advantages to be derived from its being done at a more early age, independent of those respecting the operation itself.

## VI.

*Experiments on various Species of Cinchona: by Mr. VAUQUELIN\*.*

Several kinds of Peruvian bark in the shops.

The three chief.

The common:

SEVERAL different kinds of cinchona are met with in the shops, but the chief and most in use are the following three. First that formerly called by the vague name of Peruvian bark, and which appears to be taken from the cinchona officinalis L. This is externally of a gray colour, and inter-

Abridged from the *Annales de Chimie*, vol. LIX, p. 113, Aug. 1806.

nally

nally of a pale red; thin, and convoluted from the contraction of the inner surface; smooth and as it were resinous in its fracture, but sometimes slightly fibrous; and of an astringent and bitter taste. Its powder is fawn coloured, mingled with a tinge of gray.

The second, known by the name of red bark, and sometimes erroneously called in France quinquina pitton, is of a much deeper colour; commonly very thick; little if at all convoluted; fibrous, and not at all resinous in its fracture; with an astringent and very slightly bitter taste.

The third, or yellow bark, which is of most recent date, must not be confounded with the Angustura bark, as is sometimes done by the French druggists. This is of a pale yellow colour; of a more bitter but less astringent taste than either of the preceding; partly woody, partly resinous in its fracture; and a little convoluted, according as it is more or less thick.

It would be of important service to the physician, as well as to the merchant, if there were any sure and simple methods of distinguishing the good kinds of cinchona from such as are bad or damaged: but hitherto we have nothing to guide us except their appearance, which may be fallacious, and our judgment from which must depend on our individual skill and practice. Mr. Seguin indeed has said, that the aqueous infusion of the good kinds possesses exclusively the property of precipitating infusion of tan, and that of the bad of precipitating animal gelatine; but this is an error, for there are several species of true cinchona, that do not precipitate tannin, and yet cure fever\*.

No ready method of distinguishing their goodness,

Seguin mistaken.

I have compared the physical and chemical properties of the infusions of every kind of cinchona to be found in the shops, to which I have added that of some other vegetable substances, apparently analogous with cinchona, and which are said to have cured fever. The infusions were prepared with the same quantity of water, the same quantity of bark, at an equal temperature, and for an equal time, so that no difference could arise from the mode of preparation.

\* Our readers will recollect, that Seguin fancied he had discovered the febrifuge principle in cinchona to be nothing more or less than gelatine. See Journal, Vol. VI, p. 136.

SPEC. 1. *Yellow bark.*

Infusion of  
yellow bark.

122 grammes, or near 4 oz troy, of this bark, infused for twenty-four hours in two litres [a little more than 2 wine quarts] of water at 12° [54.6° F.], imparted to it a yellow colour, and a very bitter and slightly astringent taste.

Tested with va-  
rious reagents.

This infusion occasioned a very copious flocculent precipitate in a solution of isinglass.

In a solution of sulphate of iron it produced a green colour resembling that of bile, and some time after a precipitate of the same colour fell down.

The solution of antimoniated tartrate of potash was precipitated by it of a yellowish white.

The oxalate of ammonia threw down from it a precipitate, which was oxalate of lime.

Lastly it very evidently reddened tincture of litmus.

This infusion, when completely precipitated by a solution of isinglass, and filtered, was deprived of colour, and scarcely at all astringent, but it retained its bitterness. In this state mixed with a solution of sulphate of iron, it turned it green as before, except that the colour inclined more to a yellow. It still precipitated the solution of emetic tartar, with this difference, that the precipitate was whiter. This cannot be ascribed to an excess of the isinglass, for a solution of isinglass occasions no change in that of emetic tartar.

Another portion of the infusion, being completely precipitated by emetic tartar and filtered, still rendered the solutions of isinglass and sulphate of iron turbid, but much less than before. The precipitate formed by the emetic tartar was turned slightly green by the addition of a few drops of sulphate of iron.

Principle that  
precipitates  
tartarised anti-  
mony different  
from that  
which precipi-  
tates gelatine.

It would appear from these experiments, that the principle which precipitates emetic tartar, isinglass, and sulphate of iron, is the same: and that, if the liquor still retain the property of precipitating isinglass and sulphate of iron, it is because it retains some portions of the combination of this principle with antimony. This supposition however is not reconcilable with the very copious precipitation of isinglass by certain kinds of cinchona, that do not precipitate emetic tartar. The principle that precipitates isinglass therefore  
must



must be different from that which decomposes tartarised antimony.

The bark left after this infusion being boiled in water, the decoction had almost exactly the same effects on the reagents above enumerated: the only difference between them was, that the decoction became turbid on cooling, furnished a smaller quantity of precipitate, and this separated from the liquor more speedily. Residuum de-  
cocted.

I have to add, that both of them threw down from the solution of sulphate of copper a reddish yellow precipitate, and from that of acetate of lead a yellowish white. With other  
reagents.

### SPEC. 2. *Santa Fe bark.*

This bark, which is lately introduced, has been found to possess the febrifuge power by able physicians. It is gray on the outside, red within, thick, little convoluted, with an astringent and slightly bitter taste. Its infusion is much redder than that of the yellow bark. Tried in the same manner it produced the following effects. Santa Fe bark.

With the solution of isinglass it gives a very copious reddish flocculent precipitate. This effect, which has never yet been mentioned by any person to my knowledge, is worthy of remark. Its action with  
reagents.

It occasioned no change in solution of emetic tartar, in which it differs from the yellow bark.

It throws down a fine deep green precipitate from solution of sulphate of iron; perceptibly reddens tincture of litmus; is precipitated by oxalate of ammonia, but the oxalate of lime it thus yields is much less than that from the yellow bark.

It precipitates acetate of lead and sulphate of copper of a reddish brown.

The principle which precipitates emetic tartar appears to be wanting in this bark: and a farther proof of its differing in some respects from the yellow bark is, that their infusions on mixture become turbid. Its difference  
from yellow  
bark.

The decoction of this species produced the same effects with reagents as its infusion: but it is observable, that it does not grow turbid on cooling. Decoction.

SPEC.

SPEC. 3. *Gray bark, called superfine.*

Gray bark. The infusion of this species is nearly colourless. Its taste is bitter and astringent.

Its action with reagents. It forms a very copious white precipitate with isinglass, a red with infusion of tan, a copious and white with emetic tartar, and a very fine emerald green with sulphate of iron. It produces no change in infusion of yellow bark.

SPEC. 4. *Cinnamon gray bark.*

Cinnamon gray. The infusion is of a deep red, and has a bitter astringent taste.

Its action with reagents. It precipitates solution of isinglass of a brown fawn colour, gives a green colour with sulphate of iron, but does not precipitate emetic tartar.

It occasions no change in the infusion of the gray bark, but it produces a brown precipitate with that of the yellow bark, and does not precipitate the infusion of tan.

Gelatine and tartarised antimony precipitated by different principles. These vegetable infusions, after having precipitated each other as completely as possible, act no longer on emetic tartar: whence it follows, that the principle in the infusion of yellow bark which precipitates this salt combines with something in the infusion of cinnamon gray bark and tan. But these infusions, thus precipitated, still throw down an abundant precipitate from solution of isinglass, whence it follows, that these two substances are precipitated by different principles.

Precipitate from spec. 1 and 4. The precipitate formed by mixing the infusions of the 1st and 4th species dries easily, swells up when heated, gives out a smoke devoid of acrimony, and having some analogy to that of animal substances; and leaves a light spongy coal.

SPEC. 5. *Red bark, called pitton in the shops.*

Red bark. This is erroneously named, for the true pitton bark has different characters, as will be seen farther on.

Its infusion has a light orange red colour, and an astringent bitter taste.

Its action with reagents. It forms a copious reddish precipitate with isinglass, yellowish white with emetic tartar, brown with the infusion of the

the cinnamon gray bark, green with sulphate of iron. On the other metallic solutions it acts like other species of cinchona.

SPEC. 6. *Gray bark.*

This, which I had from Mr. Bouillon Lagrange, was very thin and convoluted; and apparently from twigs or very young trees of the Loxa bark, which will be mentioned further on. Gray bark.

The infusion of this species had the red colour of Malaga wine, and an astringent bitter taste. It gave a copious white precipitate with isinglass, reddish yellow with infusion of tan, gray with infusion of yellow bark, yellowish white and flocculent with emetic tartar, green with sulphate of iron, white with acetate of lead. It did not precipitate sulphate of copper, or infusion of Santa Fe bark. It must possess the febrifuge property in a high degree. Its action with reagents.  
Highly febrifuge.

SPEC. 7. *Flat gray bark\*.*

The infusion of this bark has the colour of Malaga wine, and a flat taste, without any astringency or bitterness. Flat gray bark.

From the infusion of yellow bark it throws down a copious, brown, flocculent precipitate. To the solution of sulphate of iron it gives a fine green colour, and in a few minutes a precipitate of the same colour is thrown down. Neither tartarised antimony, isinglass, nor cinnamon gray bark produces any change in its infusion. Its action with reagents.

These appearances indicate, that it is not a true cinchona; or, if it belong to the genus, at least it has not its chemical properties; whence we may presume, that it does not possess the same medicinal virtues. Not a cinchona.

SPEC. 8. *Yellow [white] bark, cinchona pubescens of Vahl.*

A hundred grammes of this bark in fine powder macerated four and twenty hours in distilled water afforded a transparent liquor of a golden yellow colour, very bitter, and frothing White bark.

\* This appears to be the white cinchona of Santa Fe brought over by Mr. von Humboldt, which will be noticed further on.

when shaken. With reagents it exhibited the following appearances.

Its action with reagents.

Tincture of galls formed in it a copious precipitate, which an excess of the tincture redissolved, and the addition of water again threw down. This shows, that the matter separated by the tannin is not purely animal.

From the solutions of tartarised antimony and nitrate of mercury it threw down a yellowish white precipitate. To that of sulphate of iron it gave a decided green colour, but nothing fell down. Solution of isinglass produced no change in it. It did not redden infusion of litmus.

Deposite from it.

During evaporation this infusion deposited a rosecoloured substance on the sides of the dish; and being reduced to the consistence of a sirup, it deposited farther on cooling a fresh quantity of a chesnut-brown substance. The filtered liquor was still coloured, and contained the salt peculiar to cinchonas, which will be noticed hereafter.

The brown substance, washed with a small quantity of cold water, is soluble in warm water and in alcohol; but very sparingly in cold water. Its taste is very bitter.

In the aqueous solution of this sediment nutgalls form a copious precipitate. Tartarised antimony and nitrate of mercury produce the same effects in this solution as in the infusion of the bark itself. Sulphate of iron is turned green by it. Oxigenized muriatic acid loses its smell when poured into the solution, and presently forms a flocculent precipitate. Isinglass has no effect on it: it is not changed by sulphuric or acetic acid: and when diluted with caustic potash it gives out no smell of ammonia.

Two hundred and twenty-five grammes [3475 grs.] of this substance, weighed when dry, afforded on distillation a great deal of water, a perceptible quantity of ammonia, and a purple oil, which loses this colour on being dissolved in alcohol, but resumes it as the menstruum evaporates by being left exposed to the air.

They left in the retort 11 decig. [17 grs.] of coal, which yielded by incineration 1 dec. [1.54 grs.] of ashes soluble with effervescence in muriatic acid, and the solution of which yielded lime and iron.

It is evident from what has been seen, that it is this coloured, bitter substance, which, in the maceration of the cinchona in question, produces with reagents all the phenomena mentioned above. This substance seems to be a medium, in its nature and properties, between vegetable and animal substances. Probably it is the efficacious principle in the cure of intermittent fevers. The liquor separated from this substance was treated with alcohol, which took up the colouring matter; and this proved to be nothing but a portion of the same substance, that the water had retained. The portion insoluble in alcohol was of the consistence of a thick mucilage, and had scarcely any taste or colour. It dissolved in large quantity in water; and the solution yielded by spontaneous evaporation slightly coloured and lamellated crystals of a salt, which will be farther noticed in the sequel.

This a mean between animal and vegetable matter.

Probably the febrifuge principle.

Salt of bark.

The same portion of cinchona, when it had been macerated for the seventh time, still giving a precipitate with galls, I conceived, that the cold water had been incapable of dissolving the whole of the principle, by which this effect was produced. In consequence I boiled the residuum of the cinchona, and the liquor thus obtained exhibited the same phenomena as the infusion, except that it did not precipitate the solution of tartarised antimony, probably because it was too much diluted with water.

Residuum decocted.

This bark therefore is not the same as species 1, though they are both called by the same name.

SPEC. 9. Common bark, cinchona officinalis.

Eighty-four grammes [1297 grs.] of this bark, treated like the preceding, afforded a paler coloured liquor, and more mucilaginous, though equally bitter. This infusion slightly reddened that of litmus. With other reagents it exhibited similar phenomena to the cinchona pubescens.

Common bark of the shops.

Its action with reagents.

All the liquors obtained by maceration when evaporated afforded a sediment, the properties of which so much resembled those of the same substance from the cinchona pubescens, that I conceived they might be mixed together: but the supernatant liquor, containing the salt essential to cinchona, was evaporated separately, and set to crystallize by sponta-

neous evaporation, after the colouring matter had been separated by alcohol, and in a few days crystals were produced from it.

Thus we have two species of cinchona, which do not precipitate isinglass, and which are consequently destitute of the principle, that produces this effect in other species. According to Mr. Seguin they are to be classed among the best sorts.

After several washings with cold water, as galls still occasioned a precipitate, the residuum was treated with hot water, which acquired a pretty deep colour. This was less bitter than the liquor obtained by maceration, and still more mucilaginous than the decoction of the cinchona pubescens. It formed a precipitate with galls and nitrate of mercury, and turned green with sulphate of iron; but neither tartarised antimony nor isinglass occasioned any change in it.

This species therefore is not the same with that examined above by the name of *gray*, and called *superfine*.

SPEC. 10. *Large-leaved bark, cinchona magnifolia.*

Large-leaved bark.

A hundred grammes of this bark in fine powder, macerated for twenty-four hours, yielded a solution that did not pass the filter easily. It was of a ruby red colour, little mucilaginous, slightly bitter, and very decidedly astringent.

Its action with reagents.

This infusion did not redden that of litmus: neither galls nor tartarised antimony afforded any precipitate with it: with solution of isinglass it gave a copious precipitate: sulphate of iron gave it the green hue of oxide of chrome, which muriatic acid converted into a dirty green. With the infusions of the eighth and ninth species it gave a precipitate.

The water in which it was steeped cold a second time did not precipitate isinglass.

The several waters in which it had been macerated were evaporated to the consistence of an extract, and treated with hot alcohol, which acquired from it a very fine colour. This alcoholic solution diluted with water, and tested with the reagents employed with the first water in which it had been macerated, exhibited the same results. The matter therefore, that produced the effects above enumerated, is soluble in alcohol.

The

The part not soluble in alcohol was of an ochre red, and blackened by exposure to the air. It was redissolvable in water; and its solution precipitated neither isinglass nor galls; but it precipitated tartarised antimony and nitrate of mercury, and turned sulphate of iron green.

Portion not soluble in alcohol.

Ten grammes [ $154\frac{1}{2}$  grs.] of this substance insoluble in alcohol being distilled afforded ammonia, and a coal that weighed 41 cent. [ $6\frac{1}{2}$  grs.]

*A bark sold me without any name\*.*

A hundred grammes of this bark macerated for twenty-four hours did not give the water so deep a colour as the preceding species, and its astringency was less, but it was more bitter.

Another species analogous to the preceding.

It perceptibly reddened infusion of litmus; precipitated neither with galls nor tartarised antimony; but formed a precipitate with isinglass and nitrate of mercury, and turned sulphate of iron green.

This species exhibited all the characters in general of the preceding, and should be placed in the same class.

The decoction of the residuum showed no difference from the infusion.

#### SPEC. 11. *True pitton bark.*

This species, which was given me by Mr. Solomé, an eminent apothecary in Paris, greatly resembles in colour, form, and bitterness the cinchona of St. Domingo, which was analysed by Mr. Fourcroy about fifteen years ago.

Pitton bark.

A hundred grammes of this bark, treated like the other, imparted to the water a red colour like that of venous blood. Its taste is more bitter and disagreeable than that of the others. Tincture of galls, tartarised antimony, nitrate of mercury, and sulphate of iron, produced copious precipitates with this infusion of cinchona. Isinglass produced no change in it. It was precipitated by oxygenised muriatic acid, but by no other.

Its action with reagents.

The infusion left by evaporation a residuum, which partly dissolved in alcohol, communicating to it a fine red colour.

\* It had all the characters of the cinchona magnifolia [grandifolia].

The portion not soluble in alcohol had a gray colour and earthy appearance. It yielded ammonia on distillation. The portion dissolved exhibited the same phenomena as the infusion from which it was obtained.

**CINCHONA OF DIFFERENT KINDS BROUGHT FROM AMERICA  
BY MESSRS. VON HUMBOLDT AND BONPLAND.**

**SPEC. 12.** *Bark of Loxa, taken from branches of the second year, and used by the apothecary to the king of Spain.*

Loxa bark.

This is externally gray, internally yellow, thin, convoluted, and bitter and astringent to the taste.

Its action with reagents.

Eight grammes of this bark, infused for twenty-four hours in 150 grammes of water at 15° [59° F], yielded a reddish yellow liquor not very deeply coloured, having a slightly mouldy smell, and a bitter taste. It precipitated galls, tartarised antimony, and acetate of lead of a yellowish white, iron of a blueish green, oxalate of ammonia white, and isinglass in large, white, glutinous flocks. The precipitates formed by tartarised antimony and isinglass redissolved in an excess of the hot infusion.

Highly febrifuge.

From these properties this cinchona must have great febrifuge virtue.

**SPEC. 13.** *White bark of Santa Fe.*

White bark of Santa Fe.

This bark has a rusty yellow colour externally, which is deeper within. It is flat and thick. Its fracture is granulated nearly like that of beech bark. Its taste is neither bitter nor astringent like that of the other barks.

Its action with reagents.

Eight grammes macerated for twenty-four hours in 150 grammes of water imparted to it a deeper yellow colour than the Loxa barks. This infusion precipitated neither galls, tartarised antimony, nor isinglass; it turned solution of iron green; and precipitated acetate of lead of a brownish yellow.

Not a cinchona.

From these properties this bark appears not to be a true cinchona.

**SPEC. 14.** *Orange-coloured bark of Santa Fe.*

Orange coloured bark of Santa Fe.

This bark is of a cinnamon yellow colour, without any epidermis, thick, and very fibrous in its fracture. The thin-

nest



nest pieces are convoluted, the thickest flat. It is not at all astringent.

Its infusion, made as above, is scarcely coloured; has a decidedly bitter taste; forms a copious white precipitate with tartarised antimony; precipitates tannin, but not isinglass; turns iron slightly green; and does not render the infusion of Loxa bark turbid. This species of cinchona differs from that of Loxa, and cannot have very striking febrifuge properties.

Its action with reagents.

Of little virtue.

SPEC. 15. *Common peruvian bark.*

This bark is gray externally, and of an ochre red within; its surface is wrinkled; it is convoluted, and of various thicknesses according to the difference of the pieces; its taste is bitter and astringent.

Common bark.

Eight grammes, macerated for twenty-four hours in 150 grammes of water, gave it a light yellow colour, and a bitter and astringent taste. This infusion precipitated tartarised antimony, isinglass, and tannin of a yellowish white, and sulphate of iron green. It reddened litmus paper.

Its action with reagents.

This bark appears to be the same with the gray, called superfine, spec. 3. From the properties it exhibited it must be excellent in fevers, &c.

An excellent febrifuge.

SPEC. 16. *Red bark of Santa Fe.*

This does not appear to differ in any sensible degree from that mentioned above by the name of Santa Fe bark, spec. 2.

Red bark of Santa Fe.

Eight grammes, macerated as above, gave an infusion of the red colour of Malaga wine, with an astringent taste, and but little bitterness. It precipitated isinglass brown; gave no precipitate with tannin or tartarised antimony; turned sulphate of iron green; and slightly reddened litmus paper. These chemical properties are equally apparent in the Santa Fe bark described above.

Its action with reagents.

SPEC. 17. *Yellow bark of Cuença, from branches of four or six years old.*

This bark is gray exteriorly, covered with a white lichen of a brown yellow interiorly, having a fibrous fracture, and scarcely any taste. Its infusion is neither bitter nor astringent.

Yellow bark of Cuença.

gent. It precipitates neither tartarised antimony, isinglass, nor tannin; merely turns sulphate of iron green; but precipitates acetate of lead.

Not febrifuge. It can have no febrifuge virtue.

*Table of the effects produced by the species of cinchona brought from America by Messrs. von Humboldt and Bonpland with the reagents mentioned.*

SPECIES.	ISINGLASS.	TANNIN.	IRON.	TART. ANTIM.	OBSERVATIONS.
1 Common gray peruvian bark.	Copious precipitate.	The same.	A green colour.	Copious precipitate.	A bitter, astringent taste. Reddens litmus.
2 Red bark of Santa Fe.	Copious precipitate.	None.	A green colour.	None.	Red colour of Malaga wine: little bitterness, but astringent to the taste.
3 Yellow bark of Cuença.	None.	None.	Greened.	None.	Neither bitter nor astringent. Precipitates acetate of lead.
4 King of Spains Loxa bark.	Copious precipitate.	The same.	Green.	Copious precipitate.	Reddish colour, not deep. Mouldy smell. Bitter.
5 White bark of Santa Fe.	None.	None.	Greened.	None.	Pretty deep yellow colour. Neither bitter nor astringent. Precipitates acetate of lead.
6 Yellow bark of Santa Fe.	None.	Copious precipitate.	Greened.	Copious precipitate.	Taste decidedly bitter, slightly astringent. Infusion light coloured.

Table of the properties of the barks brought over by von Humboldt.

To gain some additional light respecting the nature of the principles contained in cinchona, I instituted a comparative examination of several other vegetable substances, that appear to have some analogy with it, and the composition of which is a little better known; such as galls, oak bark, Angustura bark, and some others. Other substances compared with cinchona.

### *Nutgalls.*

The infusion of this substance copiously precipitated isinglass white; iron, blue; tartarised antimony, yellowish white; infusion of yellow bark, in dirty white flocks; copper, brown yellow; and lead, yellowish white. Galls.

It did not precipitate infusion of Santa Fe bark, or of tan.

The infusion of nutgalls therefore, like that of yellow bark, contains the principle that precipitates isinglass with that which precipitates tartarised antimony; and in this respect they resemble each other. But they differ with regard to the principle that acts on tan and on iron, since their metal is precipitated green by cinchona, and blue by galls. They differ too in another point, since they mutually precipitate each other.

### *Tan.*

The infusion of this substance, made with the same care and in the same proportions as those of the cinchona bark, precipitated solution of isinglass yellowish; iron blue; copper, brown: but it occasioned no change in solution of Santa Fe bark, or solution of tartarised antimony. It reddened infusion of litmus, and was precipitated by oxalate of ammonia. Oak bark.

Hence we see, that oak bark does not contain the substance that precipitates tartarised antimony, as nutgalls, yellow bark, and some other barks do; and in this respect it differs from them, though they agree in precipitating isinglass.

### *Cherry-tree bark.*

This bark, which has sometimes been fraudulently substituted for that of cinchona, has nothing in common with it Bark of the cherry-tree.

it except the property of forming a green precipitate with solution of sulphate of iron. It occasions no change in isinglass, tartarised antimony, or decoction of oak bark. Its possessing any febrifuge property therefore is very questionable.

*Centauria and Germander.*

Centaurea and  
chamadrys. These two plants afforded me the same results as cherry-tree bark: their efficacy in fever therefore is equally doubtful.

*White willow bark.*

Bark of the  
white willow. This bark, to which febrifuge virtues have formerly been ascribed, possesses in fact some of the chemical properties of certain species of cinchona, namely those of precipitating isinglass, and throwing down sulphate of iron green, and acetate of copper brownish. The white willow bark, therefore, as it unites the bitter and astringent tastes, may possibly be a febrifuge.

*Angustura bark.*

Angustura  
bark. The infusion of this bark does not precipitate isinglass: but it forms a copious precipitate with infusion of nutgalls, and with that of yellow bark, though it merely renders infusion of Santa Fe bark slightly turbid.

It precipitates iron, tartarised antimony, copper, lead, and infusion of tan, all yellow.

This bark, we see, differs from several of the species of cinchona, and from the other substances submitted to the comparative examination, in not precipitating animal gelatine. It wants too the astringent taste, but on the other hand is extremely bitter. There is reason to believe too, that the principle, which in this precipitates the metallic solutions, is not altogether the same with that in the cinchonas; at least the colour of the precipitates it gives is very different. From these properties however the Angustura bark may possibly be a febrifuge.

*(To be concluded in the next number.)*

*Experiments*

## VII.

*Experiments for investigating the Cause of the coloured concentric Rings, discovered by Sir ISAAC NEWTON, between two Object-glasses laid upon one another. By WILLIAM HERSCHEL, LL.D. F.R.S\*.*

THE account given by Sir I. Newton of the coloured arcs and rings, which he discovered by laying two prisms or object-glasses upon each other, is highly interesting. He very justly remarks, that these phenomena are “of difficult consideration,” but that “they may conduce to farther discoveries for completing the theory of light, especially as to the constitution of the parts of natural bodies on which their colours or transparency depend†.”

With regard to the explanation of the appearance of these coloured rings, which is given by Sir I. Newton, I must confess, that it has never been satisfactory to me. He accounts for the production of the rings, by ascribing to the rays of light certain fits of easy reflection and easy transmission alternately returning and taking place with each ray at certain stated intervals‡. But this, without mentioning particular objections, seems to be an hypothesis, which cannot be easily reconciled with the minuteness and extreme velocity of the particles, of which these rays, according to the Newtonian theory, are composed.

The great beauty of the coloured rings, and the pleasing appearances arising from the different degrees of pressure of the two surfaces of the glasses against each other when they are formed, and especially the importance of the subject, have often excited my desire of inquiring farther into the cause of such interesting phenomena; and with a view to examine them properly I obtained, in the year 1792, the two object-glasses of Huygens, in the possession of the Royal Society, one of 122, and the other of 170 feet focal length, and began a series of experiments with them, which, though

\* From the Phil. Trans. for 1807, Part III, p. 180.

† Newton's Optics, 4th ed. p. 169.

‡ Ibid. p. 256.

many

His experiments led to new conclusions, and discriminations.

Minute detail necessary.

Term modification.

One set of rings made visible by different methods.

1st method. Double convex lens on a plane of glass.

many times interrupted by astronomical pursuits, has often been taken up again, and has lately been carried to a very considerable extent. The conclusions that may be drawn from them, though they may not perfectly account for all the phænomena of the rings, are yet sufficiently well supported, and of such a nature as to point out several modifications of light that have been totally overlooked, and others that have never been properly discriminated. It will, therefore, be the aim of this paper to arrange and distinguish the various modifications of light in a clear and perspicuous order, and afterwards to give my sentiments upon the cause of the formation of the concentric rings. The avowed intricacy of the subject\*, however, requires, in the first place, a minute detail of experiments, and afterwards a very gradual developement of the consequences to be deduced from them.

As the word modification will frequently be used, it may not be amiss to say, that when applied to light, it is intended to stand for a general expression of all the changes that are made in its colours, direction, or motion: thus, by the modification of reflection, light is thrown back; by that of refraction, it is bent from its former course; by the modification of dispersion, it is divided into colours, and so of the rest.

### I. *Of different Methods to make one set of concentric Rings visible.*

In the beginning of my experiments I followed the Newtonian example, and, having laid the two object-glasses of Huygens upon one another, I soon perceived the concentric rings. It is almost needless to say, that I found all the Newtonian observations of these rings completely verified; but as his experiments seemed to be too much confined for drawing general conclusions, I endeavoured to extend them: and by way of rendering the methods I point out very clear, I have given one easy particular instance of each, with the addition of a generalization of it, as follows:

*First Method.* On a table placed before a window I laid down a slip of glass, the sides of which were perfectly plain, parallel, and highly polished. Upon this I laid a double

\* Newton's Optics, 4th ed. p. 288; end of Obs. 12.

convex lens of 26 inches focal length, and found that this arrangement gave me a set of beautiful concentric rings.

I viewed them with a double convex eye lens of  $2\frac{1}{2}$  inches focus mounted upon an adjustable stand, by which simple apparatus I could examine them with great ease; and as it was not material to my present purpose by what obliquity of incidence of light I saw the rings, I received the rays from the window most conveniently when they fell upon the lens in an angle of about 30 degrees from the perpendicular, the eye being placed on the opposite side at an equal angle of elevation to receive the reflected rays.

*Generalization.* Instead of a plain slip of glass, the plain side of a plano-concave, or plano-convex lens of any focal length whatsoever may be used: and when the convex side of any lens is laid upon it, whatever may be the figure of the other surface, whether plain, concave, or convex, and whatever may be its focal length, a set of concentric rings will always be obtained. I have seen rings with lenses of all varieties of focus, from 170 feet down to one quarter of an inch. Even a common watch glass laid upon the same plain surface will give them.

To insure success, it is necessary, that the glasses should be perfectly well cleaned from any adhering dust or soil, especially about the point of contact; and in laying them upon each other a little pressure should be used, accompanied at first with a little side motion, after which they must be left at rest.

If the surface of the incumbent lens, especially when it is of a very short focal length, is free from all imperfection and highly polished, the adjustment of the focus of the above mentioned eye-glass, which I always use for viewing the rings, is rather troublesome, in which case a small spot of ink made upon the lens will serve as an object for a sufficient adjustment to find the rings.

*Second Method.* Instead of the slip of glass, I laid down a well polished plain metalline mirror; and placing upon it the same 26-inch double convex lens, I saw again a complete set of concentric rings.

It is singular that, in this case, the rings reflected from a bright metalline surface will appear fainter than when the

Generaliza-  
tion,

Necessary pra-  
cautions,

2d method.  
Double con-  
vex lens on a  
metalline mir-  
ror.

same

same lens is laid on a surface of glass reflecting but little light; this may however be accounted for by the brilliancy of the metalline ground, on which these faint rings are seen, the contrast of which will offuscate their feeble appearance.

Generaliza-  
tion.

*Generalization.* On the same metalline surface every variety of lenses may be laid, whatever be the figure of their upper surface, whether plain, concave, or convex, and whatever be their focal lengths, provided the lowest surface remains convex, and concentric rings will always be obtained; but for the reason mentioned in the preceding paragraph, very small lenses should not be used, till the experimentalist has been familiarized with the method of seeing these rings, after which lenses of two inches focus, and gradually less, may be tried.

3d method.  
Double convex  
lens on a pla-  
no convex.

*Third Method.* Hitherto we have only used a plain surface, upon which many sorts of glasses have been placed; in order therefore to obtain a still greater variety, I have laid down a plano-convex lens of 15 inches focal length, and upon the convex surface of it I placed the 26-inch double convex lens, which produced a complete set of rings.

4th. The same  
on convex me-  
tal.

*Fourth Method.* The same lens, placed upon a convex metalline mirror of about 15 inches focal length, gave also a complete set of rings.

Generaliza-  
tion.

*Generalization.* These two cases admit of a much greater variety than the first and second methods; for here the incumbent glass may have not only one, but both its surfaces of any figure whatsoever; whether plain, concave, or convex; provided the radius of concavity, when concave lenses are laid upon the convex surface of glass or metal, is greater than that of the convexity on which they are laid.

The figure of the lowest surface of the subjacent substance, when it is glass, may also be plain, concave, or convex; and the curvature of its upper surface, as well as of the mirror, may be such as to give them any focal length, provided the radius of their convexities is less than that of the concavity of an incumbent lens; in all which cases complete sets of concentric rings will be obtained.

5th. Double  
convex lens in  
a double con-  
cave glass.

*Fifth Method.* Into the concavity of a double concave glass of 8 inches focal length I placed a 7-inch double convex lens, and saw a very beautiful set of rings.

*Sixth*



*Sixth Method.* Upon a 7 feet concave metalline mirror I placed the double convex 26-inch lens, and had a very fine set of rings.

*Generalization.* With these two last methods, whatever may be the radius of the concavity of the subjacent surface, provided it be greater than that of the convexity of the incumbent glass; and whatever may be the figure of the upper surface of the lenses, that are placed upon the former, there will be produced concentric rings. The figure of the lowest surface of the subjacent glass may also be varied at pleasure, and still concentric rings will be obtained.

6th. Lens in concave metal.

## II. *Of seeing Rings by Transmission.*

The great variety of the different combinations of these differently figured glasses and mirrors will still admit of farther addition, by using a different way of viewing the rings. Hitherto the arrangement of the apparatus has been such, as to make them visible only by reflection, which is evident, because all the experiments that have been pointed out may be made by the light of a candle placed so, that the angle of incidence and of reflection towards the eye of the observer may be equal. But Sir I. Newton has given us also an observation, where he saw these rings by transmission, in consequence of which I have again multiplied and varied the method of producing them that way, as follows:

Rings by transmission.

*First Method.* On a slip of plain glass highly polished on both sides place the same double convex lens of 26-inches, which had already been used when the rings were seen by reflection. Take them both up together and hold them against the light of a window, in which position the concentric rings will be seen with great ease by transmitted light. But as the use of an eye-glass will not be convenient in this situation, it will be necessary to put on a pair of spectacles with glasses of 5, 6, or 7 inches focus, to magnify the rings in order to see them more readily.

1st method. Double convex lens on plain glass.

*Second Method.* It would be easy to construct an apparatus for viewing the rings by transmission fitted with a proper eye-glass; but other methods of effecting the same purpose are preferable. Thus, if the two glasses that are to give the rings be laid upon a hollow stand, a candle placed at a pro-

2d. The same with the light from a candle below.

per

per angle and distance under them will show the rings conveniently by transmitted light, while the observer and the apparatus remain in the same situation as if they were to be seen by reflection.

3d. Daylight reflected upward from a mirror.

*Third Method.* A still more eligible way is to use daylight received upon a plain metalline mirror reflecting it upwards to the glasses placed over it, as practised in the construction of the common double microscope; but I forbear entering into a farther detail of this last and most useful way of seeing rings by transmission, as I shall soon have occasion to say more on the same subject.

Generalization.

*Generalization.* Every combination of glasses, that has been explained in the first, third, and fifth methods of seeing rings by reflection, will also give them by transmission, when exposed to the light in any of the three ways that have now been pointed out. When these are added to the former, it will be allowed, that we have an extensive variety of arrangements for every desirable purpose of making experiments upon rings, as far as single sets of them are concerned.

### III. *Of Shadows.*

Of shadows.

When two or more sets of rings are to be seen, it will require some artificial means, not only to examine them critically, but even to perceive them; and here the shadow of some slender opaque body will be of eminent service. To cast shadows of a proper size and upon places where they are wanted, a pointed penknife may be used as follows.

Point of a penknife

When a plain slip of glass or convex lens is laid down, and the point of a penknife is brought over either of them, it will cast two shadows, one of which may be seen on the first surface of the glass or lens, and the other on the lowest.

gives two shadows from a plain or convex glass:

three from two glasses,

and in some cases four.

When two slips of glass are laid upon each other, or a convex lens upon one slip, so that both are in contact, the penknife will give three shadows; but if the convex lens should be of a very short focus, or the slips of glass be a little separated, four of them may be perceived; for in that case there will be one formed on the lowest surface of the incumbent glass or lens; but in my distinction of shadows this will not be noticed. Of the three shadows thus formed the second will

will be darker than the first, but the third will be faint. When a piece of looking glass is substituted for the lowest slip, the third shadow will be the strongest.

Three slips of glass in contact, or two slips with a lens upon them, or also a looking glass, a slip and a lens put together, will give four shadows, one from each upper surface and one from the bottom of the lowest of them. Four from three glasses.

In all these cases a metalline mirror may be laid under the same arrangement without adding to the number of shadows, its effect being only to render them more intense and distinct. Metallic mirror renders them plainer.

The shadows may be distinguished by the following method. When the point of the penknife is made to touch the surface of the uppermost glass or lens, it will touch the point of its own shadow, which may thus at any time be easily ascertained: and this in all cases I call the first shadow; that which is next to it, the second; after which follows the third, and so on. Method of distinguishing the shadows.

In receding from the point, the shadows will mix together, and thus become more intense; but which, or how many of them are united together, may always be known by the points of the shadows. Mixture of the shadows.

When a shadow is to be thrown upon any required place, hold the penknife nearly half an inch above the glasses, and advance its edge foremost gradually towards the incident light. The front should be held a little downwards to keep the light from the underside of the penknife, and the shadows to be used should be obtained from a narrow part of it. Precautions,

With this preparatory information it will be easy to point out the use that is to be made of the shadows when they are wanted.

#### IV. *Of two sets of Rings.*

I shall now proceed to describe a somewhat more complicated way of observation, by which two complete sets of concentric rings may be seen at once. The new or additional set will furnish us with an opportunity of examining rings in situations where they have never been seen before, which will be of eminent service for investigating the cause of their origin, and with the assistance of the shadows to be formed, Two sets of rings.

formed, as has been explained, we shall not find it difficult to see them in these situations.

**1st method.** *First Method.* Upon a well polished piece of good looking glass lay down a double convex lens of about 20 inches focus. When the eye-glass has been adjusted as equal for seeing one set of rings, make the shadow of the penknife in the order which has been described, pass over the lens; then as it sometimes happens in this arrangement that no rings are easily to be seen, the shadow will, in its passage over the surface, show where they are situated. When a set of them is perceived, which is generally the primary one, bring the third shadow of the penknife over it, in which situation it will be seen to the greatest advantage.

**Secondary set of rings.** Then, if at the same time a secondary set of rings has not yet been discovered, it will certainly be perceived when the second shadow of the penknife is brought upon the primary set. As soon as it has been found out, the compound shadow, consisting of all the three shadows united, may then be thrown upon this secondary set, in order to view it at leisure and in perfection. But this compound shadow should be taken no farther from the point than is necessary to cover it; nor should the third shadow touch the primary set. The two sets are so near together, that many of the rings of one set intersect some of the other.

**Viewed alternately with the primary.** When a sight of the secondary set has been once obtained, it will be very easy to view it alternately with the primary one by a slight motion of the penknife, so as to make the third shadow of it go from one set to the other.

**The rings made visible by setting them in motion.** Besides the use of the shadows, there is another way to make rings visible when they cannot be easily perceived, which is to take hold of the lens with both hands, to press it alternately a little more with one than with the other; a tilting motion, given to the lens in this manner, will move the two sets of rings from side to side; and as it is well known that a faint object in motion may be sooner perceived than when it is at rest, both sets of rings will by these means be generally detected together.

**The light should be oblique.** It will also contribute much to facilitate the method of seeing two sets of rings, if we receive the light in a more oblique angle of incidence, such as 40, 50, or even 60 degrees

grees. This will increase the distance between the centres of the primary and secondary sets, and at the same time occasion a more copious reflection of light.

Instead of a common looking-glass a convex glass mirror may be used, on which may be placed either a plain, a concave, or a convex surface of any lens or glass, and two sets of rings will be obtained. With glasses of other forms.

In the same manner, by laying upon a concave glass mirror a convex lens, we shall also have two sets of rings.

The generalizations that have been mentioned when one set of rings was proposed to be obtained may be easily applied with proper regulations, according to the circumstances of the case, not only to the method by glass mirrors already mentioned, but likewise to all those that follow hereafter, and need not be particularized for the future. In the choice of the surfaces to be joined, we have only to select such as will form a central contact, the focal length of the lenses and the figure of the upper surface being variable at pleasure. Generalization.

*Second Method.* On a plain metalline mirror I laid a parallel slip of glass, and placed upon it the convex surface of a 17-inch plano-convex lens, by which means two sets of rings were produced. 2d. Lens on glass and metal.

Upon the same mirror the plain side of the plano-convex glass may be laid instead of the plain slip, and any plain, convex, or concave surface, being placed upon the convexity of the subjacent lens, will give two sets of rings.

The plain side of a plano-concave glass may also be placed upon the same mirror, and into the concavity may be laid any lens that will make a central contact with it, by which arrangement two sets of rings will be obtained.

*Third Method.* Upon a small well polished slip of glass place another slip of the same size, and upon them lay a 39-inch double convex lens. This will produce two sets of rings; one of them reflected from the upper surface of the first slip of glass, and the other from that of the second. 3d. Lens on two slips of glass.

Instead of the uppermost plain slip of glass we may place upon the lowest slip the plain side of a plano-convex or plano-concave lens, and the same variety which has been explained in the third method, by using any incumbent lens that

will make a central contact, either with the convexity or concavity of the subjacent glass, will always produce two sets of rings.

4th. Lens on glass on black paper.

*Fourth Method.* A more refined but rather more difficult way of seeing two sets of rings is to lay a plain slip of glass on a piece of black paper, and when a convex lens is placed upon the slip, there may be perceived, but not without particular attention, not only the first set, which has already been pointed out as reflected from the first surface of the slip, but also a faint secondary set from the lowest surface of the same slip of glass.

It will be less difficult to see two sets of rings by a reflection from both surfaces of the same glass, if we use, for instance, a double concave of 8 inches focus with a double convex of  $7\frac{1}{2}$  inches placed upon it. For, as it is well known that glass will reflect more light from the farthest surface when air rather than a denser medium is in contact with it, the hollow space of the 8-inch concave will give a pretty strong reflection of the secondary set.

5th. Two primary and independent sets of rings.

*Fifth Method.* The use that is intended to be made of two sets of rings requires, that one of them should be dependent upon the other: this is a circumstance that will be explained hereafter, but the following instance, where two independent sets of rings are given, will partly anticipate the subject. When a double convex lens of 50 inches is laid down with a slip of glass placed upon it, and another double convex one of 26 inches is then placed upon the slip, we get two sets of rings of different sizes; the large rings are from the 50-inch glass, the small rings from the 26-inch one. They are to be seen with great ease, because they are each of them primary.

These may be crossed and varied.

By tilting the incumbent lens, or the slip of glass, these two sets of rings may be made to cross each other in any direction; the small set may be laid upon the large one, or either of them may be separately removed towards any part of the glass. This will be sufficient to show, that they have no connection with each other. The phenomena of the motions, and of the various colours and sizes assumed by these rings, when different pressures and tiltings of the glasses are used, will afford some entertainment. With the assistance of the

shadow

shadow of the penknife the secondary set belonging to the rings from the 26-inch lens will be added to the other two sets; but in tilting the glasses this set will never leave its primary one, while that from the 50-inch lens may be made to go any where across the other two.

### V. Of three sets of Rings.

To see three sets of concentric rings at once is attended with some difficulty, but by the assistance of the methods of tilting the glasses, and making use of the multiplied shadows of a penknife, we may see them very well, when there is a sufficient illumination of bright daylight.

*First Method.* A 26 inch double convex lens placed upon three slips of plain glass will give three sets of rings. The slips of glass should be nearly 2 tenths of an inch thick, otherwise the different sets will not be sufficiently separated. When all the glasses are in full contact, the first and second sets may be seen with a little pressure and a small motion, and, if circumstances are favourable, the third, which is the faintest, will also appear. If it cannot be seen, some of the compound shadows of the penknife must be thrown upon it; for in this case there will be five shadows visible, several of which will fall together, and give different intensity to their mixture.

*Second Method.* When a single slip of glass, with a 34-inch lens upon it, is placed upon a piece of good looking glass, three sets of rings may be seen: the first and third sets are pretty bright, and will be perceived by only pressing the lens a little upon the slip of glass; after which it will be easy to find the second set with the assistance of the proper shadow. In this case four shadows will be seen; and when the third shadow is upon the first set, the fourth will be over the second set and render it visible.

*Third Method.* When two slips of glass are laid upon a plain metalline mirror, then a 26-inch lens placed upon the slips will produce three sets of rings; but it is not very easy to perceive them. By a tilting motion the third set will generally appear like a small white circle, which at a proper distance will follow the movement of the first set. As soon as the first and third sets are in view, the third shadow of the penknife

knife may be brought over the first set, by which means the fourth shadow will come upon the second set, and in this position of the apparatus it will become visible.

4th. Lens on a slip of glass forming an angle with metal. *Fourth Method.* On a plain metalline mirror lay one slip of glass, but with a small piece of wood at one end under it, so that it may be kept about one tenth of an inch from the mirror, and form an inclined plane. A 26-inch lens laid upon the slip of glass will give three sets of rings. Two of them will easily be seen; and when the shadow of the penknife is held between them the third set will also be perceived. There is but one shadow visible in this arrangement, which is the third; the first and second shadows being lost in the bright reflection from the mirror.

5th. A convex lens on a concave and slip of glass. *Fifth Method.* I placed a  $6\frac{1}{4}$ -inch double convex upon an 8-inch double concave, and laid both together upon a plain slip of glass. This arrangement gave three sets of rings. They may be seen without the assistance of shadows, by using only pressure and tilting. The first had a black and the other two had white centres.

## VI. *Of four sets of Rings.*

Four sets of rings.

The difficulty of seeing many sets of rings increases with their number, yet by a proper attention to the directions that are given four sets of concentric rings may be seen.

1st. Lens on a glass forming an angle with a mirror.

*First Method.* Let a slip of glass, with a 26-inch lens laid upon it, be placed upon a piece of looking glass. Under one end of the slip, a small piece of wood one tenth of an inch thick must be put, to keep it from touching the looking glass. This arrangement will give us four sets of rings. The first, third, and fourth may easily be seen, but the second set will require some management. Of the three shadows, which this apparatus gives, the second and third must be brought between the first and fourth sets of rings, in which situation the second set of rings will become visible.

2d. Plano-convex lens on three slips of glass & metal.

*Second Method.* When three slips of glass are laid upon a metalline mirror, and a plano-convex lens of about 17 inches focus is placed with its convex side upon them, four sets of rings may be seen; but this experiment requires a very bright day, and very clean, highly polished slips of plain



plain glass. Nor can it be successful unless all the foregoing methods of seeing multiplied sets of rings are become familiar and easy.

I have seen occasionally, not only four and five, but even <sup>5 or 6 sets of</sup> six sets of concentric rings, from a very simple arrangement <sup>rings.</sup> of glasses: they arise from reiterated internal reflections; but it will not be necessary to carry this account of seeing multiplied sets of rings to a greater length.

### VII. *Of the Size of the Rings.*

The diameter of the concentric rings depends upon the <sup>Size of the</sup> radius of the curvature of the surfaces between which they <sup>rings.</sup> are formed. Curvatures of a short radius, *cæteris paribus*, give smaller rings than those of a longer; but Sir I. Newton having already treated on this part of the subject at large, it will not be necessary to enter farther into it.

I should however remark, that, when two curves are con- <sup>Inversely as the</sup> cerned, it is the application of them to each other, that will <sup>angle of con-</sup> determine the size of the rings, so that large ones may be <sup>tact.</sup> produced from curvatures of a very short radius. A double convex lens of  $2\frac{1}{4}$ -inches focus, for instance, when it is laid upon a double concave which is but little more in focal length, gives rings that are larger than those from a lens of 26 inches laid upon a plain slip of glass.

### VIII. *Of Contact.*

The size of the rings is considerably affected by pressure. <sup>Pressing the</sup> They grow larger when the two surfaces that form them are <sup>surfaces to-</sup> pressed closer together, and diminish when the pressure is <sup>gether enlarges</sup> gradually removed. The smallest ring of a set may be in- <sup>the rings.</sup> creased by this means to double and treble its former diameter; but as the common or natural pressure of glasses laid upon any flat or curved surface is occasioned by their weight, the variations of pressure will not be very considerable, when they are left to assume their own distance or contact. To produce that situation, however, which is generally called contact, it will always be necessary, to give a little motion backwards and forwards to the incumbent lens or glass, accompanied with some moderate pressure, after which it may be left to settle properly by its own weight.

IX. *Of measuring Rings.*

The rings difficult to measure absolutely.

It may be supposed from what has been said concerning the kind of contact, which is required for glasses to produce rings, that an attempt to take absolute measures must be liable to great inaccuracy. This was fully proved to me, when I wanted to ascertain, in the year 1792, whether a lens laid upon a metalline surface would give rings of an equal diameter with those it gave when placed on glass. The measures differed so much, that I was at first deceived; but on proper consideration it appeared, that the Huygenian object glass, of 122 feet focus, which I used for the experiment, could not so easily be brought to the same contact on metal as on glass; nor can we ever be well assured, that an equal distance between the two surfaces in both cases has been actually obtained. The colour of the central point, as will be shown hereafter, may serve as a direction; but even that cannot be easily made equal in both cases. By taking a sufficient number of measures of any given ring of a set, when a glass of a sufficient focal length is used, we may however determine its diameter to about the 25th or 30th part of its dimension.

But their proportions in the same set more easily measured.

Relative measures, for ascertaining the proportion of the different rings in the same set to each other, may be more accurately taken, for in that case the contact with them all will remain the same, if we do not disturb the glasses during the time of measuring.

X. *Of the Number of Rings.*

Number of rings.

When there is a sufficient illumination, many concentric rings in every set will be perceived; in the primary set we see generally 8, 9, or 10, very conveniently. By holding the eye in the most favourable situation I have often counted near 20, and the number of them is generally lost, when they grow too narrow and minute to be perceived, so that we can never be said fairly to have counted them to their full extent. In the second set I have seen as many as in the first, and they are full as bright. The third set, when it is seen by a metalline mirror under two slips, will be brighter than the second, and almost as bright as the first: I have easily counted 7, 8, and 9 rings.

XI. *Of the Effect of Pressure on the Colour of the Rings.*

When a double convex object glass of 14 or 15 feet focus is laid on a plain slip of glass, the first colours that make their faintest appearance will be red surrounded by green; the smallest pressure will turn the centre into green surrounded by red: an additional pressure will give a red centre again, and so on till there have been so many successive alterations, as to give us six or seven times a red centre, after which the greatest pressure will only produce a very large black one surrounded by white.

Their colours affected by pressure.

When the rings are seen by transmission, the colours are in the same manner subject to a gradual alternate change occasioned by pressure, but when that is carried to its full extent, the centre of the rings will be a large white spot surrounded by black.

The succession and addition of the other prismatic colours, after the first or second change, in both cases is extremely beautiful; but as the experiment may be so easily made, a description, which certainly would fall short of an actual view of these phenomena, will not be necessary.

When the rings are produced by curves of a very short radius, and the incumbent lens is in full contact with the slip of glass, they will be alternately black and white; but by lessening the contact, I have seen, even with a double convex lens of no more than two tenths of an inch focus, the centre of the rings white, red, green, yellow, and black, at pleasure. In this case I used an eye-glass of one inch focus; but as it requires much practice to manage such small glasses, the experiment may be more conveniently made by placing a double convex lens of 2 inches focus on a plain slip of glass, and viewing the rings by an eye-glass of  $2\frac{1}{2}$  inches; then having first brought the lens into full contact, the rings will be only black and white, but by gently lifting up or tilting the lens, the centre of the rings will assume various colours at pleasure.

XII. *Of diluting and concentrating the Colours.*

Lifting up or tilting a lens being subject to great uncertainty, a surer way of acting upon the colours of the rings is

Method of diluting or concentrating

by

concentrating the colours.

by dilution and concentration. After having seen that very small lenses give only black and white when in full contact, we may gradually take others of a longer focus. With a double convex lens of four inches the outward rings will begin to assume a faint red colour. With 5, 6, and 7, this appearance will increase; and proceeding with lenses of a larger focus, when we come to about 16, 18, or 20 inches, green rings will gradually make their appearance.

This and other colours come on much sooner if the centre of the lens is not kept in a black contact, which in these experiments must be attended to.

A lens of 26 inches not only shows black, white, red, and green rings, but the central black begins already to be diluted so as to incline to violet, indigo, or blue. With one of 34, the white about the dark centre begins to be diluted, and shows a kind of gray inclining to yellow. With 42 and 48, yellow rings begin to become visible. With 55 and 59, blue rings show themselves very plainly. With a focal length of 9 and 11 feet, orange may be distinguished from the yellow and indigo from the blue. With 14 feet, some violet becomes visible. When the 122-foot Huygenian glass is laid on a plain slip, and well settled upon it, the central colour is then sufficiently diluted, to show that the dark spot, which in small lenses, when concentrated, had the appearance of black, is now drawn out into violet, indigo, and blue, with a little admixture of green; and that the white ring, which used to be about the central spot, is turned partly green with a surrounding yellow, orange, and red-coloured space or ring; by which means we seem to have a fair analysis of our former compound black and white centre.

Analysis of the black & white centre.

A light brown seen.

One of my slips of glass, which is probably a little concave, gave the rings still larger, when the 122 feet glass was firmly pressed against it. I used a little side motion at the same time, and brought the glasses into such contact, that they adhered sufficiently to be lifted up together. With this adhesion I perceived a colour surrounding a dark centre, which I have never seen in any prismatic spectrum. It is a kind of light brown, resembling the colour of a certain sort of Spanish snuff. The 170 feet object-glass showed the same colour also very clearly.

XIII. *Of the order of the Colours.*

The arrangement of the colours in each compound ring or alternation, seen by reflection, is, that the most refrangible rays are nearest the centre; and the same order takes place when seen by transmission. We have already shown, that, when a full dilution of the colours was obtained, their arrangement was violet, indigo, blue, green, yellow, orange, and red; and the same order will hold good, when the colours are gradually concentrated again; for though some of them should vanish before others, those that remain will always be found to agree with the same arrangement.

The most refrangible rays nearest the centre

If the rings should chance to be red and green alternately, a doubt might arise, which of them is nearest the centre; but by the method of dilution, a little pressure, or some small increase of the focal length of the incumbent lens, there will be introduced an orange tint between them, which will immediately ascertain the order of the colours.

In the second set of rings the same order is still preserved as in the first; and the same arrangement takes place in the third set as well as in the fourth. In all of them the most refrangible rays produce the smallest rings.

XIV. *Of the alternate Colour and Size of the Rings belonging to the primary and dependent Sets.*

When two sets of rings are seen at once, and the colour of the centre of the primary set is black, that of the secondary will be white; if the former is white, the latter will be black. The same alternation will take place if the colour of the centre of the primary set should be red or orange; for then the centre of the secondary one will be green; or if the former happens to be green, the latter will be red or orange. At the same time there will be a similar alternation in the size of the rings; for the white rings in one set will be of the diameter of the black in the other; or the orange rings of the former will be of equal magnitude with the green of the latter.

Alternation of the dependent sets in colour and size.

When three sets of rings are to be seen, the second and third sets will be alike in colour and size, but alternate in both particulars with the primary set.

The

The same thing will happen when four sets are visible; for all the sets that are formed from the primary one will resemble each other, but will be alternate in the colour and dimensions of their rings with those of the primary set.

XV. *Of the sudden Change of the Size and Colour of the Rings in different Sets.*

The size and colour of the rings in different sets may be suddenly changed.

When two sets of rings are viewed, which are dependent upon each other, the colour of their centres, and of all the rings in each set, may be made to undergo a sudden change by the approach of the shadow of the point of a penknife or other opaque slender body. To view this phenomenon properly, let a 16-inch double convex lens be laid upon a piece of looking glass, and when the contact between them has been made to give the primary set with a black centre, that of the secondary will be white. To keep the lens in this contact, a pretty heavy plate of lead with a circular hole in it of nearly the diameter of the lens should be laid upon it. The margin of the hole must be tapering, that no obstruction may be made to either the incident or reflected light. When this is properly arranged, bring the third shadow of the penknife upon the primary set, which is that towards the light. The real colours of this and the secondary set will then be seen to the greatest advantage. When the third shadow is advanced till it covers the second set, the second shadow will at the same time fall upon the first set, and the colour of the centres, and of all the rings in both sets, will undergo a sudden transformation from black to white and white to black.

The alternation of the colour is accompanied with a change of size, for as the white rings before the change were of a different diameter from the black ones, these latter, having now assumed a black colour, will be of a different size from the former black ones.

When the weight is taken from the lens, the black contact will be changed into some other. In the present experiment it happened, that the primary set got an orange coloured centre, and the secondary a green one. The same way of proceeding with the direction of the shadow being then pursued, the orange centre was instantly changed to a green



Dr. Herschel on coloured concentric Rings.

Fig. 1.

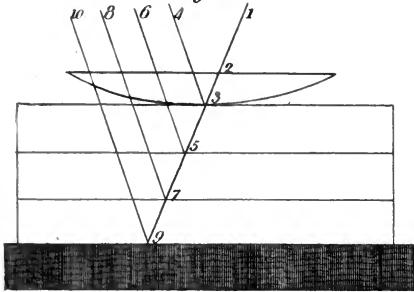

Fig. 2.

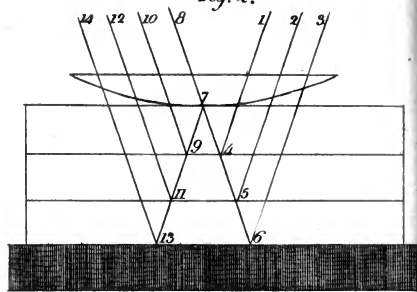

Fig. 3.

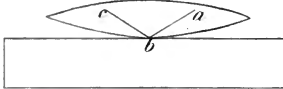

Fig. 4.



Fig. 5.

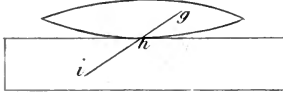

Fig. 6.

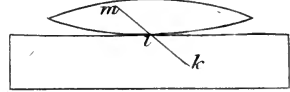

Fig. 7.

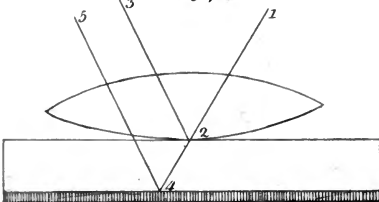
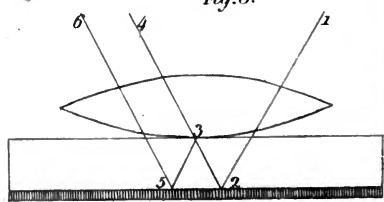

Fig. 8.





green one, while at the same moment the green centre was turned into orange. With a different contact I have had the primary set with a blue centre and the secondary with a deep yellow one; and by bringing the second and third shadows alternately over the primary set, the blue centre was changed to a yellow, and the yellow centre to a blue one; and all the rings of both sets had their share in the transformation of colour and size.

If there are three sets of rings, and the primary set has a black centre, the other two will have a white one; and when the lowest shadow is made to fall on the third set, the central colour of all the three sets will be suddenly changed, the first from black to white, the other two from white to black.

A full explanation of these changes, which at first sight have the appearance of a magical delusion, will be found in a future article.

#### XVI. *Of the Course of the Rays by which different Sets of Rings are seen.*

In order to determine the course of the rays, which give the rings both by reflection and by transmission, we should begin from the place whence the light proceeds that forms them. In Pl. IV, fig. 1, we have a plano-convex lens laid upon three slips of glass, under which a metalline mirror is placed. An incident ray 1, 2, is transmitted, through the first and second surface of the lens, and comes to the point of contact at 3. Here the rings are formed, and are both reflected and transmitted: they are reflected from the upper surface of the first slip, and pass from 3 to the eye at 4: they are also transmitted through the first slip of glass from 3 to 5; and at 5 they are again both reflected and transmitted; reflected from 5 to 6, and transmitted from 5 to 7; from 7 they are reflected to 8, and transmitted to 9; and lastly they are reflected from 9 to 10. And thus four complete sets of rings will be seen at 4, 6, 8, and 10.

Determination  
of the course of  
the rays.

The most convenient way of viewing the same rings by transmission is that, which has been mentioned in the second article of this paper, when light is conveyed upwards by reflection. In figure 2, consisting of the same arrangement of glasses as before, the light by which the rings are to be

seen

seen comes either from 1, 2, or 3, or from all these places together, and being reflected at 4, 5, and 6, rises up by transmission to the point of contact at 7, where the rings are formed. Here they are both transmitted up to the eye at 8, and reflected down to 9; from 9 they are reflected up to 10 and transmitted down to 11; from 11 they are reflected to 12 and transmitted to 13; and lastly, from 13 they are reflected to 14; so, that again four sets of rings will be seen at 8, 10, 12, and 14.

This being a theoretical way of conceiving how the rays of light may produce the effects, it will be required to show by experiments, that this is the actual progress of the rays, and that all the sets of rings we perceive are really reflected or transmitted in the manner that has been pointed out; but as we have so many reflections and transmissions before us, it will be necessary to confine these expressions to one particular signification when they are applied to a set of rings.

What is meant  
by reflected

and transmit-  
ted.

When the centre of the rings is seen at the point of contact, it is a primary set; and I call it reflected, when the rays which come to that point and form the rings undergo an immediate reflection. But I call it transmitted, when the rays, after having formed the rings about the point of contact, are immediately transmitted.

Thus in figure 3 and 4 the rays  $abc$ ,  $def$ , give reflected sets of rings; and the rays  $ghi$ ,  $klm$ , in figure 5 and 6, give transmitted sets.

In this denomination, no account is taken of the course of the rays before they come to  $a$ ,  $d$ ,  $g$ ,  $k$ ; nor of what becomes of them after their arrival at  $c$ ,  $f$ ,  $i$ ,  $m$ : they may either come to those places or go from them by one or more transmissions or reflections, as the case may require; but our denomination will relate only to their course immediately after the formation of the rings between the glasses.

The secondary and other dependent sets will also be called reflected or transmitted by the same definition: and as a set of these rings formed originally by reflection may come to the eye by one or more subsequent transmissions; or being formed by transmission, may at least be seen by a reflection from some interposed surface, these subsequent transmissions

or reflections are to be regarded only as convenient ways to get a good sight of them.

With this definition in view, and with the assistance of a principle which has already been proved by experiments, we may explain some very intricate phenomena; and the satisfactory manner of accounting for them will establish the truth of the theory relating to the course of rays that has been described.

The principal to which I refer is, that, when the pressure is such as to give a black centre to a set of rings seen by reflection, the centre of the same set, with the same pressure of the glasses, seen by transmission will be white\*.

I have only mentioned black and white, but any other alternate colours, which the rings or centres of the two sets may assume, are included in the same predicament.

### XVII. *Why two connected Sets of Rings are of alternate Colours..*

It has already been shown, when two sets of rings are seen, that their colours are alternate, and that the approach of the shadow of a penknife will cause a sudden change of them to take place. I shall now prove, that this is a very obvious consequence of the course of rays that has been proposed. Let figure 7 and 8 represent the arrangement given in a preceding article, where a 16-inch lens was laid upon a looking glass, and gave two sets of rings with centres of different colours: but let figure 7 give them by one set of rays, and figure 8 by another. Then, if the incident rays come in the direction which is represented in figure 7, it is evident that we see the primary set with its centre at 2 by reflection, and the secondary one at 4 by transmission. Hence it follows, in consequence of the admitted principle, that if the contact is such as to give us the primary set with a black centre, the secondary set must have a white one; and thus the reason of the alternation is explained.

Why two connected sets are of alternate colours.

But if the rays come as represented in figure 8, we see the primary set by transmission, and the secondary one by reflection; therefore, with an equal pressure of the glasses, the

\* See Article XI, of this Paper, p. 135.

primary

primary centre must now be white, and the secondary one black.

Without being well acquainted with this double course of rays, we shall be liable to frequent mistakes in our estimation of the colour of the centres of two sets of rings; for by a certain position of the light, or of the eye, we may see one set by one light, and the other set by the other.

**XVIII. *Of the Cause of the sudden Change of Colours.***

Cause of the sudden change of colour.

Having thus accounted for the alternation of the central colours, we may easily conceive, that the interposition of the penknife must have an instantaneous effect upon them. When it stops the rays of figure 7, which will happen when its second shadow falls upon the primary set, the rings will then be seen by the rays 1, 2, 3, 4, and 1, 2, 3, 5, 6, of figure 8. When it stops the rays of figure 8, which must happen when the third shadow falls upon the primary set, we then see both sets by the rays 1, 2, 3, and 1, 2, 4, 5, of figure 7. When the penknife is quite removed, both sets of rays will come to the point of contact, and in some respects interfere with each other; but the strongest of the two, which is generally the direct light of figure 7, will prevail. This affords a complete explanation of all the observed phenomena: by the rays of figure 7 the centres will be black and white; by those of figure 8 they will be white and black; and by both we shall not see the first set so well as when the third shadow, being upon it, has taken away the rays of figure 8: indeed we can hardly see the secondary set at all, till the shadow of the penknife has covered either the rays of figure 7 or of figure 8.

Both the centres and rings may be changed partially.

As soon as we are a little practised in the management of the rays, by knowing their course, we may change the colour so gradually as to have half the centre white, while the other half shall still remain black; and the same may be done with green and orange, or blue and yellow centres. The rings of both sets will also participate in the gradual change; and thus what has been said of the course of rays in the 16th article will again be confirmed.

*To be concluded in our next.*

## VIII.

*A Method of finding the specific Gravity of Light from Analogy; and the undulatory System defended by an Experiment on inflected Light. In a Letter from Mr. RICHARD WINTER.*

To Mr. NICHOLSON,

DEAR SIR,

Whitby, Jan. 8th, 1803,

THE undulatory system of light had until within very lately become exploded by the extraordinary abilities of Newton, and his great exertions in favour of the emanative system; but no name, however great, should prevent inquiry after truth and extension of science, so naturally allied to the civilization and happiness of mankind. It is, I believe, generally allowed, that few discoveries have been made by pursuing a beaten path; it is on this account that so few improvements have been made in the theory of light since the time of Sir Isaac Newton. Dr. Young's experiments, and reasoning from facts, in favour of the undulatory motion of light, are deserving of impartial attention.

Undulatory system of light beginning again to claim attention.

The great influence of light on vegetables and animals is ascertained, from the want of colour in both when deprived thereof; and the vigour, odour, and density of tropical plants, and the ferocity of animals indigenous to those climates. Its consequences in the arts and manufactures are very considerable, in its various combinations with the elementary bodies. Its effect also upon man is acknowledged and felt by all nations, so as to contribute a principal characteristic (viz. that of colour).

Light has great influence on vegetables and animals;

in arts and manufactures; on man;

The physical phenomena arising therefrom display a wide field for the investigation of the natural philosopher, in the production and change of colours—the formation of the rainbow, parhelia, haloes, &c.

and on natural phenomena.

It has baffled the ingenuity of man to determine its density by mechanical means. Michell attempted to find its momentum

Its density not easy to ascertain

momentum

tain mechani-  
cally.

momentum upon a balance, but the transmission through different glasses will vary, as the lenses may happen either to differ in density or transparency; and consequently will give different results. You also advanced (Introduction to Natural Philosophy) some ingenious arguments to decide its amazing subtlety, founded upon undoubted principles.

May perhaps  
be deduced  
analogically.

The following analogy will appear perhaps hypothetical; however, such as it is I will submit it to the candid and discriminating, to determine whether the conclusions are substantial or premature.

Undulations of  
mediums as  
their gravities.

The resistance of fluids is as their densities reciprocally; therefore it may be presumed, that the undulations of different mediums will bear the same proportion to one another, as their specific gravities.

Velocity of  
those of light.

It has been demonstrated by the accurate observations and discoveries of Dr. Bradley on the aberration of light, that this medium is conveyed from the sun to the earth, or in other words, an undulation of light reaches the earth from the sun, in the space of 8' 7.5" of time. Taking the mean apparent diameter of the sun at 32' 1.5", and his mean horizontal parallax at 8.79", as determined by Dr. Maskelyne, and the semidiameter of the earth at 3964 miles, we shall find the sun's real diameter to be 873,489 miles, and his distance from the earth equal to 93,334,047 miles: therefore the velocity of light will be determined thus,  $\frac{93334047}{8' 7.5''} =$

191,434 miles in one second of time, or 1,010,771,520 feet.

Undulations of  
air and water  
compared.

According to Hales (Statics, Vol. II, p. 331) the velocity of undulating air is to the velocity of undulating water as 865 to 1, or as their specific gravities. The motion of sound is found to be 1130 feet in one second (Young's Syllabus of a Course of Lectures, 1802): then, as the velocity of sound is to the velocity of light, so is the specific gravity of air to the specific gravity of light, according to the following formula;  $\frac{1010771520}{1130} = 894,588$  times lighter than at-

Hence light  
894588 times  
lighter than  
air.

mospheric air; or it will require 1553 cubic feet of light to weigh one grain. If we compare them with water, taken as unity

unity, we shall find them expressed as follows at a mean temperature.

SPECIFIC GRAVITIES.

Water.....	1·00000000000
Air .....	0·00120000000
Light .....	0·00000000013

If this be the real density of light, it will appear, that all former attempts to appreciate its specific gravity by mechanical means must have been fruitless, as the quantity thrown by a lens, however large, upon a balance of the most delicate construction, must be exceedingly minute; yet it may have very considerable effects when exerted upon the body of the planets. May not the diurnal motion of the planets be the effect of its momentum? Hence incapable of being weighed directly.

It appears to me, that the experiment on inflected light, mentioned in Newton's optics, performed by passing the light through an aperture of a window shutter into a darkened room, is much better explained, by allowing an undulatory than a radiating motion of light. Inflection of light better explained by undulation than radiation.

It is the nature of all fluids to undulate in circular arcs when moved by any impulse.

Let *a* represent an aperture into a darkened room, equal to  $\frac{1}{4}$  part of an inch in diameter, *b, c, d, e, f*; waves of light, moving in succession against the solid object *g h*, which we will suppose the side of a house: here the light, meeting with an opaque substance, will be reflected every where, except at the aperture *a*, which will then become the centre of motion. The undulating light, having passed the aperture, will dilate in the concentric arcs 1, 2, 3, 4, &c., till they arrive at *i*, on the opposite side of the room; and the greater the distance between *a* and *i*, the greater will be the diameter of the shadow of the aperture; all obstacles placed in this lucid stream will have their shadows augmented in diameter, when received upon the wall, in proportion to their distance therefrom. Phenomena of light admitted through a small aperture.

If the attraction of the sides of the aperture and window shutter was the cause of this enlargement of the shadow, the obstacle, when interposed in the lucid stream within the room, would also attract the light, and the diameter of its shadow, Not owing to its being attracted by the sides of the aperture.

shadow, instead of being augmented (as it really appears to be), would be diminished.

I am very respectfully,

Your obedient servant,

RICHARD WINTER.

It gives me great pleasure to observe, that you have undertaken to publish an Encyclopedia upon a limited scale. It will be peculiarly adapted to the interest of the artizan, the mechanic, the manufacturer, and to the most numerous class of society.

There is one article which would be useful to your country readers, I mean a Monthly Meteorological Register inserted in the Journal, of the Barometer, Thermometer, Winds, &c. at London, in order to enable them to compare them with observations made in the country; perhaps this may be inconsistent with your plan, which is generally approved.

---

As it is my wish to gratify all my readers, in whatever tends to promote the interests of science, I shall take measures to comply with the request of my correspondent, by inserting, as soon as conveniently can be done, a meteorological register, from a hand that may be relied on with confidence for its accuracy. W. N.

---

## IX.

*Account of an Accident from the sudden Deflagration of the Base of Potash. In a Letter from a Correspondent.*

SIR,

To Mr. NICHOLSON,

Caution  
against acci-  
dents in de-  
composing the  
alkalis.

AS the late brilliant discoveries by Mr. Davy, of the decomposition of the fixed alkalis, will probably induce many to repeat his experiments, I take the liberty of suggesting to them, through the medium of your Journal, the *caution of using glasses* to defend the eyes during the operation. The flat glasses, commonly called *goggles*, are best adapted to the purpose.

For want of this precaution, I yesterday met with an accident, from which I have suffered much pain, and might even have been totally deprived of sight by it. A considerable



able quantity of potash being decomposed in the galvanic circle, a sudden deflagration of the metallary base ensued, by which several particles of the caustic alkali were thrown into my eyes.

Potash being decomposed, its base suddenly deflagrated, and several particles thrown into the operator's eyes.

To prevent the like accident happening to others, who may be engaged in similar experiments, is my motive for sending you this. Whether it is worth your notice or not, you will judge.

I remain, SIR,

Your obedient servant,

Tunbridge, Jan. 22, 1808.

PHILOMMATOS.

P. S. I lose no time in making the communication, but my eyes are still so weak, I can scarcely see to write.

### X.

*Correction of some Misstatements in the Account of Mr. Davy's Decomposition of the fixed Alkalis. In a Letter from a Correspondent.*

To Mr. NICHOLSON.

SIR,

London, Jan. 24, 1808.

THE extensive circulation of your excellent Journal both at home and abroad makes it more desirable, that it should not be the means of propagating any incorrect statements of scientific facts; and such statements are given in the account of Mr. Davy's important discovery of the decomposition of the fixed alkalis.

Misstatements in the account of the decomposition of the fixed alkalis.

I was present at the reading of his lecture. I paid the greatest attention to it. I feel that your well known love of philosophical justice will induce you, to give a place in your publication to what I am convinced were the real accounts of the author.

It is stated in your Journal, that the basis of potash is volatile at 100°. Mr. Davy's account was, that it is volatile at a heat a little below redness. It is likewise said, that the amalgam of the basis of potash and quicksilver, when applied in the circle of a galvanic battery, dissolved iron, silver, gold, and platina. Mr. Davy merely mentioned, that it dissolved these metals; he said nothing, that I can recollect, of the galvanic battery.

Basis of potash volatile a little below a red heat.

Its amalgam dissolves metals.

It decomposes glass

by combining with its alkali into an oxide with less oxygen than potash.

Spec. grav. of the base of soda 0.9.

Glass, it is said in your Journal, is dissolved by the basis of potash in the same manner as the metals. The real statement with regard to glass was, that the basis of potash decomposed it by combining with its alkali, and by forming a red oxide of a less degree of oxygenation than potash, which oxide was likewise procured by other means.

It is stated, that the specific gravity of the basis of soda is to that of water as 7 to 10. Mr. Davy said, as 9 to 10.

I am, SIR, with great respect,

Your obedient humble servant,

A CHEMIST.

## XI.

*An Improvement in the Galvanic Trough, to prevent the Cement from being melted, when the Action is very powerful. Communicated by a Correspondent.*

SIR,

To Mr. NICHOLSON.

Cement of the galvanic trough liable to be melted by the heat evolved.

This may be remedied by making the partitions of glass.

This battery may be excited to great intensity.

THE superiority of galvanic batteries constructed on the principle of Volta's *couroime des tasses*, as recommended by Mr. Wilkinson, is, I believe, fully established. One inconvenience however attends it: the action of the acid on the zinc plates being greatly increased, the quantity of caloric evolved is so considerable, as frequently to melt the cement with which the *wooden* partitions of the troughs are covered. To remedy this inconvenience, I have had recourse to glass partitions, and find them answer my expectations completely. It is better to make them so much larger than the metallic plates, as to leave a space of about half an inch (it should not I think be less) between the sides and bottom of the trough, and metallic plates. Common crown glass is perfectly adapted to the purpose: its thickness, of course, must be proportioned to the size required; and the *top edge* should be ground smooth. A battery constructed on this plan may be excited to great intensity, without injuring the cement at all.

I have the honour to be, SIR,

Your obedient servant, J. G. C.

Tunbridge, Jan. 24, 1808.

## XII.

*Experiments on the Fire-damp of Coal Mines, by WILLIAM HENRY, M. D.; including a Communication on the Subject from THOMAS THOMSON, M. D. F.R.S.E. Communicated by Dr. Henry.*

ABOUT the close of 1806, I received, from the Rev. William Turner of Newcastle on Tyne, two bladders filled with the fire-damp, which had been procured from a coal mine in the neighbourhood of that town. It was caught by luting a common funnel over the mouth of a *blower* \*, and tying a compressed bladder to the pipe of the funnel, after the gas had issued from it for some time. My experiments were made on the gas, about seven days after its being first collected. At that time, the bladders were perfectly dry, and showed no signs of putrefaction.

The general results of these experiments (as stated in a memoir which was read in January 1807, before the Medical Society of Edinburgh) are the following. The gas was found, by the test of nitric oxide, used in Mr. Dalton's method †, to contain about  $\frac{2}{3}$  its bulk of common air. It had a disagreeable smell. When set on fire as it issued from the orifice of a small pipe, it burned with a dark blue flame; and a long conical glass vessel, held over the flame, was soon bedewed with moisture. Mixed with common air, it did not detonate on the approach of a lighted taper, at least in any proportion that was tried. The utmost effect was a deep blue flame, which spread quickly through the vessel, but was not accompanied with any noise. With oxygen gas, however, it exploded, and gave a loud report. On agitation with limewater it lost about  $\frac{1}{6}$  of its bulk. The nicest tests did not discover any admixture of sulphuretted hydrogen. One hundred parts by measure appeared, therefore, to consist of

\* *Blowers* are holes or crevices in the coal or in the accompanying strata, from which the fire-damp issues, sometimes with considerable force.

† Phil. Journ. XVI, 247; or Henry's Epitome, chap. xii, sect. 2.

Component parts.	63·34 atmospherical air
	1·66 carbonic acid
	35· inflammable gas
	<hr/>
	100· 0

The inflam. gas was carburetted hydrogen.

The nature of the inflammable gas was next ascertained by detonation with oxygen gas. Reducing the results to a general average, and excluding the common air, the really inflammable part of the gas required for combustion about twice its bulk of oxygen; and gave its own volume of carbonic acid. Hence the inflammable portion of the gas was *carburetted hydrogen*. From the experiments of Mr. Dalton on the gas from stagnant water, and my own obtained by distilling pit-coal\*, the fire-damp appears to differ very little from both those gasses.

Fire-damp less adulterated was examined by Dr. Thomson.

It was desirable, however, to repeat the analysis of fire-damp, less adulterated with common air; and for this purpose a quantity was collected (as it issued through water on the floor of the mine) in an inverted bottle, which was well corked and tied over with bladder. Happening to pass through Newcastle last spring, I carried this gas with me to Edinburgh; and, having no opportunity of making experiments upon it there, my friend Dr. Thomson was so good as to undertake its analysis, and to furnish me with the following results.

Detail of the experiments and result.

From the action of nitrous gas and of lime-water, the gas appeared by Dr. Thomson's experiments, to contain, in 100 measures,

63 inflammable gas
6·5 oxygen
25·5 azote
5· carbonic acid
<hr/>
100·0

\* The gas obtained by the destructive distillation of coal I have found to contain a variable proportion of sulphuretted hydrogen, and to differ somewhat from the composition which I have stated in the 11th vol. of this Journal. The correction of those results I reserve for another occasion.

The following TABLE shows the result of its combustion, performed by detonating it over water. The oxygen gas contained  $77\frac{1}{2}$  pure oxygen, and  $22\frac{1}{2}$  azotic gas per cent.

Experiment.	Measures of Fire-damp.	Measures of Oxygen.	Residue after combustion.	Ditto after Lime-water.	Nitrous Gas add. to residue.	Residue of Nit. Gas & Fire-d.
1	20	30	27	22	17	38
2	20	35	24	14	13	25.5
3	20	40	27	15.5	20	25
4	10	30	24	18	30	27
5	10	50	43	36	45	21
6	10.	40	33	27	40	28.5

The results of the foregoing experiments are explained as follows.

## COMPOSITION OF THE RESIDUE.

In Experiment.	Real infl. Gas used.	Pure oxygen used.	Azote.	Residue.	Carbonic acid Gas.	Azote.	Oxygen.	Infl. Gas un- consumed.
1	12.6	24.55	11.85	27	5	11.85	0.37	9.78
2	12.6	28.43	12.97	24	10	12.97	0.55	0.48
3	12.6	32.30	14.10	27	11.5	14.10	0.40	0.
4	6.3	23.90	9.30	24	6	9.30	7.70	1.
5	6.3	39.40	13.80	43	7	13.80	22.	0.20
6	6.3	31.65	11.55	33	6	11.55	14.17	1.28

It appears, therefore, that, when the gas was entirely consumed, 12.6 measures of the really inflammable part gave 11.5 measures of carbonic acid, and required for saturation about 32 measures of oxygen. The average results are the following, excluding the first experiment in which the combustion was far from being perfect.

	Over water.	Over mercury.
Measures of oxygen required for saturating		
100 measures of fire-damp.....	269.4	246.
Measures of carbonic acid produced.....	98.4	90.6

The second column contains the average results of two experiments, which Dr. Thomson made over mercury; but on these he places less reliance than on the foregoing series. The general issue of his experiments agrees with that of mine; and the difference is chiefly in the quantity of oxygen consumed by the combustion of the fire-damp, which appeared to me not to exceed twice its volume.

The fire-damp is not produced from decomposed pyrites, nor from water decomposed by coal; but probably from coal distilled by the heat of pyrites.

I know not whether the result of the foregoing experiments will be considered as affording any insight into the nature of the process, by which the fire-damp is generated in coal mines. The entire absence of sulphuretted hydrogen gas shows, that it is not the immediate product of the decomposition of water by beds of pyrites; for in that case, the evolved hydrogen would undoubtedly have dissolved a portion of sulphur. Neither can it arise from the decomposition of water by coal; for, besides that coal has no action on water at a moderate temperature, this origin is contradicted by the smallness of the proportion of carbonic acid which is present in the fire-damp. The most probable supposition is, perhaps, that it is disengaged from coal by a kind of natural distillation. The heat required for this purpose may be communicated by contiguous beds of pyrites; and may be excited in them by the occasional influx of water. In confirmation of this opinion it may be observed, that the fire-damp is generated most abundantly after long and heavy rains. The freedom, also, of some coal mines from this destructive gas, indicates the operation of a partial cause.

It

It is to be regretted, that the analysis of the fire-damp affords no encouragement to expect, that it can ever be destroyed in coal mines by any chemical process, as has lately been proposed. The only feasible method of preventing the dreadful consequences of its combustion is, to enforce the steady execution of a well planned system of ventilation, not only in the part of the mine actually in work, but in the old workings or *waste*. Every accident which has happened may, I have been informed, be traced either to an error in the method of ventilation, or to neglect of its enforcement. The most important object, therefore, appears to be, the improvement of the mode of ventilating coal mines; and especially the superseding, by proper mechanical contrivances, the necessity of those attentions which are at present required on the part of the workmen. The peculiar expediency of changing the air of a mine, after an accidental explosion, before venturing into it, is apparent from the foregoing experiments, which show, that, after every such combustion, a large quantity of that gas must have been generated, which is known to miners under the name of *choak damp*.

Hence the only method of opposing the destructive effects of fire-damp is to ventilate well.

Manchester, Jan. 10, 1808.

### XIII.

*On the Phosphorescence of Bodies, from the Action of the Electric Explosion. In a Letter from Mr. WILLIAM SKRIMSHIRE, Jun. to Mr. JOHN CUTHBERTSON.*

DEAR SIR,

Wisbech, Jan. 5, 1808.

I Have lately resumed my Electrical Experiments, and having gone through the inflammables, as also the metals, metallic ores, and oxides, I take the liberty of sending them to you. Respecting the phosphoric appearance of bodies, these few experiments are no otherwise interesting, than as forming additional links in the chain of facts, which I have formerly stated, and which it is my intention to extend throughout the animal and vegetable kingdoms. But

Continuation of electrical experiments.

as

as they discover to us a whole class of bodies devoid of the least phosphorescency, after exposure to electric light, they may be deemed of some importance, especially as being one step towards leading us to a theory of this phenomenon. I trust you will be kind enough to send them to Mr. Nicholson, to be inserted in his extremely useful Journal.

### *Combustibles.*

Habitudes of bodies as to the electric spark and the production of phosphorescence.

Sulphur.

Phosphorus.

Charcoal.

Coke.

Cannel coal.

Peat.

Bitumen.

Sulphur. 1st, Roll brimstone gives no spark, and is scarcely at all luminous by the shock. 2d, Flowers of sulphur are not phosphoric. 3d, A native specimen pure gave no spark, and was very slightly luminous by the shock. 4th, A native specimen mixed with carbonate of lime gave no spark, but was more luminous than the preceding specimens.

Phosphorus inflames both by the spark and shock.

Charcoal. Some kinds afford very good sparks, are phosphorescent upon the surface, and when the rods rest upon them the dust is dispersed by the explosion, in the forms of a luminous cloud. But other pieces, which were tried, did not become phosphoric by exposure to the electric light.

Coke gives a good spark, but is not luminous by the shock.

Cannel coal and common Sunderland coal give sparks beautifully variegated in minute spangles radiated upon its surface, but they are not phosphoric. Welsh coal gives similar sparks, but not so beautiful as the above; and is not luminous by the shock.

Peat, hard and dry, affords a very good spark, but is scarcely luminous.

Soft, porous, very light peat, termed in this neighbourhood Ramsay turf, is not luminous except in the track of the discharge, and even then it is extremely evanescent.

Charred peat affords a very good spark, and is slightly luminous.

Bitumen, hard and brittle, of a dark brown colour, from Derbyshire, gives no sparks; but the fluid spreads uniformly and silently over its whole surface, to pass from the conductor to the knob of the discharger held above it, with an appearance similar to the electric light in an exhausted receiver. It is luminous by the shock, as is also the elastic bitumen from the same country.

Jet



Jet and asphaltum, instead of a spark, afford the same appearance of electric light as bitumen does; but they are not luminous by the explosion. Jet. Asphaltum.

Amber gives no spark, but is phosphorescent, especially that kind termed fat amber. Amber.

Plumbago gives good sparks, and is not phosphoric; but when mixed with clay, and manufactured into crucibles, it affords good sparks, which are flame-coloured and purple upon the surface, and becomes luminous when the shock is taken *above* its surface. Plumbago.

### *Metals, their Ores and Oxides.*

As the metals are excellent conductors of electricity, it is well known that they all afford good sparks; but I have not been able to perceive any material difference in the colour of the electric light, from different metals, unless the metal has been formed into exceeding thin leaves, or otherwise minutely divided, and the spark be sufficiently strong to produce oxidation.

Not one of the metals is phosphoric by exposure to the light of an electric explosion, if its surface be clean and bright. The metals are not phosphoric.

This is the only class of natural bodies, which I have yet found uniformly to remain dark after exposure to the electric light. Some of their ores and oxides, such as the red and yellow arsenic, hæmatites, pyrites which is found in chalk, oxide of zinc, and oxide of antimony are very slightly luminous; whilst others, for instance cinnabar, black sulphuret of mercury or ethiops mineral of the shops, mundic, galena, blend, and the sulphurets of antimony, minium, litharge, and some other oxides, as readily absorb, and as obstinately retain within their substance, the electric light to which they are exposed, as even the metals themselves. In short I have not met with a single brilliant phosphoric appearance in any of the metals, ores, or oxides, which I have had the opportunity of subjecting to experiment. These observations entirely coincide with the results of experiments on solar phosphori by Beccari, who tried every means that his inventive genius could suggest, to render the metals phosphoric, but without success. However it is not surprising, that there should be a tolerably exact agreement between the observations These experiments agree with those of Beccari on solar phosphori.

tions

tions of Beccari on solar phosphori, and those facts, which are stated in my letters. For as I think there can be no doubt but the phosphoric appearance of bodies in the dark, after exposure to the light of the sun, and the phosphorescency of those substances that have been exposed to the light of an electric explosion, proceed from the same cause, they must necessarily be subject to similar laws.

But this subject will claim our attention more particularly hereafter, when I shall have occasion to speak of the nature and cause of this phosphoric phenomenon.

I remain, Your's, &c.

WILLIAM SKRIMSHIRE, JUN.

#### XIV.

*Experiments on the Decomposition of the fixed Alkalis by Galvanism. In a Letter from Mr. CHARLES SYLVESTER.*

To Mr. NICHOLSON.

DEAR SIR,

Farther experiments on the decomposition of alkalis.

BEING on a visit, for a few days, with my friend, Mr. Oakes, Jun. of Derby, we have together made some experiments, in prosecution of the inquiry instituted by Mr. Davy, relative to the decomposition of the fixed alkalis by the galvanic influence; the result of whose research has been recently communicated to the Royal Society.

Potash exposed to the action of a surface of 1400 inches.

In the first experiment, we used a pair of troughs, exposing a surface of 1400 square inches, and placed the potash, which was perfectly pure and white, on a plate of platina; but did not moisten it, as is said to have been the case in Mr. Davy's experiments, the deliquescence of the alkali precluding the necessity of such precaution. As soon as the platina wire was brought into contact with the potash, from the opposite end of the battery, a considerable quantity of gas was evolved; arising most probably from a decomposition of the water. The alkali, in consequence, assumed a blackish colour, which continued to be produced so long as the action was maintained, sparks being frequently emitted; which latter effect has only been observed to take place with charcoal and the metals.

Gas evolved.

The alkali blackened and emitted sparks.

Exposed to the

A second experiment was made, with the addition of another

ther pair of troughs of the same size as the first; and to remedy the inconvenience occasioned by the deliquescence of the potash in the former attempt, a glass tube was employed, having a platina wire, coiled into a spiral form, sealed into one of its ends. The alkali was placed in the tube, surrounded by the spiral wire, and another wire, passing through a cock which occupied the other end of the tube, was, by sliding freely up and down, made to touch the potash at intervals. The wires being connected with the battery, and the alkali slightly moistened, a considerable portion of gas was evolved, which from time to time exploded by the sparks produced: the temperature of the mass was materially increased, and the black matter, which was deposited on solution of the alkali in water, appeared in greater quantity than before. Small portions of this black substance sticking to the end of the wire, on being brought into contact with water, suddenly detonated accompanied with a vivid flash; an effect which was also produced on pouring distilled water into the tube.

action of 2800 inches, and deliquescence prevented by enclosing in a tube.

Appearance as before.

Temperature increased.

Black matter detonated on the contact of water.

The detonations caused by the black matter coming into contact with water, we ascertained from experiment, could not be produced by potash in any state of dryness; hence it would appear, that some substance has been created during the galvanic process, possessed of properties very different from those of the materials employed.

Potash does not produce this effect in any state.

Farther inquiry promised.

It is our intention however, to resume these experiments assisted by greater galvanic power, the result of which I shall transmit to you.

I am, Sir, Your obedient servant,

Derby, 20th Jan. 1808.

CHA. SYLVESTER.

### SCIENTIFIC NEWS.

#### *Discovery of a complete Mammoth.*

THE bones that have been discovered in different parts of the northern hemisphere sufficiently prove the existence of some large animal, or animals, now unknown; and some writers have even given a particular description of the quadruped generally called a mammoth, though it would seem merely from the report of tradition among the uncultivated

Mammoth found in a perfect state.

tivated nations of the north. Lately however one has been found, not alive indeed, but complete, and in a state of perfect preservation, on the borders of the frozen ocean. The following is the account, that has been received of-it from Petersburg.

Account of its  
discovery.

Schoumachoff, a Tungoose chief, about the end of august 1799, when the fishing in the river Lena was over, repaired according to annual custom to the seaside. Leaving his family in their huts, he coasted along the shore in quest of mammoth's tusks, and one day perceived in the midst of a rock of ice a large shapeless block, not at all resembling the logs of drift wood commonly found there. He climbed the rock, and examined it all round, but could not make out what it was. The next year, visiting the same spot, he found there the carcase of a seacow (*trichecus rosmarus*); and observed, not only that the mass he had seen the year before was free from ice, but that there were two similar pieces by the side of it. These afterward turned out to be the feet of the mammoth. In 1801, the side of the animal and one of its tusks appearing very distinctly, he acquainted his wife and some of his friends with what he had found. This however gave them great alarm, for the old men said, that they had been told by their forefathers a similar monster was once before seen in those parts, and the whole family of the person who discovered it soon became extinct. At this Schoumachoff was so much alarmed, that he fell sick. On his recovery however he could not relinquish the expectation of the profit he might make of the tusks; and directed his servants to conceal the circumstance carefully, and endeavour to keep away all strangers by some pretext or other. It was not till the fifth year, that the ice had melted sufficiently to disengage the mammoth, when it fell over on its side upon a bank of sand. Schoumachoff then cut off the tusks, which he bartered for goods to the value of 50 rubles [£11. 5s.] with a Russian merchant. Being satisfied with this, the carcase was left to be devoured by the bears, wolves, and foxes, except what the Yakouts in the neighbourhood cut off to feed their dogs. Previous to this indeed he had a rude drawing made of it, which represents it with pointed ears, very small eyes, horse's hoofs, and a bristly mane

Tradition of  
another.

Its flesh eaten  
by dogs and  
wild beasts.

Drawing of it.

mane

mane extending along the whole of its back. In this it has the appearance of something between a pig and an elephant.

In 1806, Mr. Mich. Adams, of Petersburg, being at Yakoutsk, fortunately heard of this circumstance, and repaired to the spot. When he arrived there, the skeleton, nearly stripped of its flesh, was entire, one of the forefeet excepted. The vertebræ, from the head to the os coccygis, one of the shoulderblades, the pelvis, and the remaining three extremities, were still held firmly together by the ligaments of the joints, and by strips of skin and flesh. The head was covered with a dry skin. One of the ears, well preserved, was furnished with a tuft of bristles. These parts could not avoid receiving some injury during their removal to Petersburg, a distance of 11000 wersts [6875 miles]: the eyes however are preserved, and the pupil of the left eye is still distinguishable. The tip of the under lip was eaten away; and the upper being destroyed, the teeth were exposed. The brain, which was still within the cranium, appeared dry. The parts least damaged were one of the forefeet and one of the hind: these were still covered with skin, and had the sole attached to them.

According to the Tungoose chief the animal was so corpulent and well fed, that its belly hung down below the knee joints. It was a male, with a long mane, but had neither tail nor trunk. From the structure of the os coccygis however, Mr. Adams is persuaded, that it had a short thick tail: and from the smallness of its snout, and the size of its tusks, he conceives it could not have been able to feed without the assistance of a proboscis; but Schoumachoff persisted in the assertion, that he never saw any appearance of a trunk, and it does not appear probable, that even his rude draughtsman would have omitted such a striking feature. The skin, three fourths of which are in possession of Mr. Adams, the part that lay on the ground having been preserved, was of a deep gray colour, and covered with reddish hair and black bristles. These, from the dampness of the ground, had lost some part of their elasticity. More than a pound [40 lbs.] weight of them, that had been trodden into the ground by the bears, was collected, many of them an archine [2 feet 4 in.] long. What remained of the skin was so heavy, that ten persons

Description of  
it.

persons found great difficulty in carrying it to the seaside, in order to stretch it on logs of wood. The head weighs  $11\frac{1}{2}$  pouds [460 lbs.]; the two horns, each of which is  $1\frac{1}{2}$  toise [ $9\frac{1}{2}$  feet] long, weigh 10 pouds [400 lbs.]; and the entire animal measured  $4\frac{1}{2}$  archines [ $10\frac{1}{2}$  feet] high, by 7 [ $16\frac{1}{2}$  feet] long. Mr. Adams has seen tusks of the mammoth so curved as to form three fourths of a circle; and one at Yakoutsk  $2\frac{1}{2}$  toises [15 feet 9 in.] long, an archine [2 feet 4 in.] thick near the root, and weighing 7 pouds [280 lbs.]. They are curved in the direction opposite to those of the elephant, bending toward the body of the animal; and the point is always more or less worn on the outside, so that the right tusk is easily distinguishable from the left. He adds, that he found a great quantity of amber on the shores.

Amber.

We understand he wishes to dispose of the skeleton, and means to employ the money in a journey toward the north pole, and particularly in visiting what is called the island of Ljachow, or Sichow, which, from the information he has received, he believes to be part of the continent of North America.

---

#### *St. Thomas's and Guy's Hospitals.*

The Spring Course of Lectures at these adjoining Hospitals, will commence the beginning of February: viz. at

St. THOMAS'S,

Anatomy and the Operations of Surgery, by Mr. Cline, and Mr. Cooper.

Principles and Practice of Surgery, by Mr. Cooper.

GUY'S,

Practice of Medicine, by Dr. Babington and Dr. Curry.

Chemistry, by Dr. Babington, Dr. Marcet, and Mr. Allen.

Experimental Philosophy, by Mr. Allen.

Theory of Medicine, and Materia Medica, by Dr. Curry and Dr. Cholmeley.

Midwifery, and Diseases of Women and Children, by Dr. Haighton.

Physiology, or Laws of the Animal Economy, by Dr. Haighton.

Structure and Diseases of the Teeth, by Mr. Fox.

*N. B.* These several Lectures are so arranged, that no two of them interfere in the hours of attendance; and the whole are calculated to form a *Complete Course of Medical and Chirurgical Instructions*.—Terms and other Particulars may be learnt from Mr. Stocker, Apothecary to Guy's Hospital.

---

*The communications from J. Gough, Esq., Dr. Gibbes, and N. R. P. will be given in our next.*

A

# JOURNAL

OF

NATURAL PHILOSOPHY, CHEMISTRY,

AND

THE ARTS.

---

---

MARCH, 1808.

---

---

## ARTICLE I.

*Remarks on Torpidity in Animals, in two Letters from JOHN GOUGH, Esq.*

SIR,

Middleshaw, 16 Jan. 1808.

YOU have given, in your XVIIIth volume, page 254, an excellent memoir by Mr. du Pont de Nemours, on a kind of death, that may be presumed to be only apparent. This ingenious philosopher suggests several practical observations which merit the attention both of the benevolent and the curious, because they promise to promote the interests of humanity as well as of science. This writer, however, adopts one opinion, which perhaps is supported by the authority of antiquity, rather than facts and the known habits of animals.

Mr. du Pont's memoir valuable.

Mr. du Pont agrees in opinion, perhaps with the majority of naturalists, respecting the nature of torpidity; for he refers it, partly to the benumbing effects of the cold which prevails in winter; and partly to a high degree of corpulence, which is generally contracted in autumn, from an unrestrained indulgence in the abundance and delicacies of that season. He moreover supposes, that animals do not submit to this long suspension of the vital functions in obedience to

The prevailing explanation of torpidity stated.

the dictates of necessity; on the contrary, he imagines them to court a lethargic habit, in consequence of certain pleasing sensations, which are known to precede the first moments of sleep.

**Objections to the preceding hypothesis.** The preceding hypothesis is commonly supposed to assign the true causes of torpidity; but the doctrine is liable to certain objections. I will state these in the first place, and afterwards endeavour to substantiate them by facts, which are new, or but imperfectly understood. My objections are contained in the four following propositions.

**Objection 1st.** First, Animals do not submit to torpidity upon choice, but from necessity; and when cold happens to be the immediate cause, they fly from it, if possible.

**Objection 2d.** Second, Certain animals apparently support a voluntary suspension of their functions in summer as well as winter, when food is withheld from them; this is probably intended to preserve life by diminishing the action of the system.

**Objection 3d.** Third, A quadruped noted for its lethargic disposition in winter may be so far strengthened by a generous diet, as to retain the full use of its faculties during the time of a severe frost: from which we may infer, that an emaciated habit of body is the predisposing cause of torpidity, in opposition to the common opinion, which assigns this office to corpulence.

**Objection 4th.** Fourth, The united action of hunger and a low temperature has produced a kind of apparent death in a human being, who was restored to life by stimulating remedies, after laying several days without sense and motion.

The first objection exemplified by the hearth cricket. The hearth cricket (*gryllus domesticus*) affords a proof of the first objection. Those who have attended to the manners of this familiar insect will know, that it passes the hottest part of summer in sunny situations, concealed in the crevices of walls and heaps of rubbish. It quits its summer abode about the end of August, and fixes its residence by the fireside of the kitchen or cottage, where it multiplies its species, and is as merry at Christmas as other insects are in the Dog-days. Thus do the comforts of a warm hearth afford the cricket a safe refuge, not from death, but from temporary torpidity; which it can support for a long time, when deprived by accident of artificial warmth. I came to the



the knowledge of this fact, by planting a colony of these insects in a kitchen, where a constant fire is kept through the summer, but which is discontinued from November to June, with the exception of a day once in six or eight weeks. The crickets were brought from a distance, and let go in this room in the beginning of September 1806; here they increased considerably in the course of two months, but were not heard or seen after the fire was removed. Their disappearance led me to conclude, that the cold had killed them; but in this I was mistaken: for a brisk fire being kept up for a whole day in the winter, the warmth of it invited my colony from their hiding-place, but not before the evening; after which they continued to skip about and chirp the greater part of the following day, when they again disappeared, being compelled by the returning cold to take refuge in their former retreats. They left the chimney corner on the 28th of May, 1807, after a fit of very hot weather, and revisited their winter residence on the 31st of August. Here they spent the autumn merely, and lie torpid at present in the crevices of the chimney, with the exception of those days, on which they are recalled to a temporary existence by the comforts of a fire.

Crickets are commonly supposed to be exempted by nature from the hardships of torpidity; but the preceding narrative proves the exemption to be conditional in these insects; and those who take the liberty to argue from analogy will feel an inclination, to attribute the same accommodating faculty to other animals, some of which are nearly connected with the welfare of society. In reality, the supposition is strongly favoured by facts: for we have frequent instances in this part of the nation, of sheep living three or four weeks under drifts of snow, where they can procure little or no food; and a ewe was recovered alive from a drift at Ennerdale in Cumberland, on Christmas-day last, after remaining under it five weeks in a space not exceeding one yard in diameter. If the same or any other sheep were confined half the time in a moderately warm room, with but one square yard of grass, no doubt could be entertained respecting the event of the experiment.

Sheep can live long under snow.

Much has been said respecting the torpidity of those birds A remark on which

birds of pas-  
sage.

which are seen in summer only ; but though the opinion has had its advocates as long ago as Pliny, it has never been proved, and perhaps it never will. For since the cricket avoids the cold when it can, and the woodcock, as well as the snipe, retires from the north at the end of autumn with the same intention ; it is highly probable, that the swallow, with many more periodical birds, quits this country, and flies to warmer regions on the approach of winter ; while the bat, the dormouse, and hedgehog, are obliged to abide the rigours of the season, benumbed by the frost and debilitated by hunger. But it is time to return from this digression, and to come to the second objection, the proof of which is contained in the following experiment.

The second  
objection ex-  
emplified by  
two kinds of  
snails.

I took several specimens of the garden snail, *helix hortensis*, and shut them up in a perforated wafer box ; which secluded them from food and water, but not from air. A number of the *helix zonaria* was treated in the same manner ; and a few of this species were put into a bottle, which was corked, to cut off all communication with the atmosphere, as well as food and water. Those snails did not live long which were deprived of air ; but the specimens of both species did not die which were confined in the perforated boxes. On the contrary they retired into their shell, closing the apertures of them with thin membranes ; here they remained dead to all appearance, as long as I kept them dry. But this death was nothing more than apparent ; for I restored my prisoners to life in succession, by dropping them into a glass containing water of the temperature of 70° or 72° : after leaving them four or five hours in this situation, I constantly found them alive, and sticking to a plate which covered the vessel. A large garden snail supported this severe confinement nearly three years, being apparently dead all the time ; after which it revived upon being put into water, like the rest of its fellow captives.

This wonderful faculty however is not possessed by snails of every description ; this I discovered, by treating an aquatic species, the *helix putris*, in the manner described above. The preceding experiment was made in consequence of a short memoir which I met with some years ago, in a volume of the Philosophical Transactions of an older date. The

writer

writer of this paper had observed accidentally, that some snails, which had been long confined in a drawer, were found to be alive after being immersed in water: the fact appeared very singular to me, and I was desirous to ascertain the accuracy of it more correctly by a direct experiment.

The proof of the second objection being now finished, I am obliged by want of room to defer the remaining two to a future opportunity.

JOHN GOUGH.

*Middleshaw, 5th Feb. 1808,*

SIR,

I Had the honour of presenting the following memoir to the Society of Nat. Hist. Edinburgh, in October, 1798; since which time it has come to my knowledge, that this learned body is not in the habit of publishing its papers; and as the essay promises to establish the third and fourth objections offered in my last letter to the received theory of torpidity, I have transmitted it to your valuable Journal.

And remain, &c.

JOHN GOUGH.

*On the changes produced in the habits of animals by difference of diet and other causes, together with the history of a domesticated dormouse.*

The remarks contained in the present essay are not the result of experiments instituted either to confirm or contradict any notion; but were collected from observations made on the general economy of the little quadruped under consideration. Introductory remark.

Having procured two dormice, *mures avellanarii*, in January, 1792, which were caught in the woods but a few days before they came into my hands, I confined them in a cage furnished with a thermometer, and placed in a chamber where no fire was kept. In this situation they were supplied regularly with water and food, consisting of hazel-nuts and biscuit. The weather in February being warm for the sea- Manners of a pair of dormice recently caught.

son at the beginning and end of the month, and frosty from the 16th to the 25th, I had an opportunity to observe, that, whenever the thermometer, which was attached to the cage, fell to 42°, the dormice became inactive; and remained apparently insensible as long as the heat of that part of the chamber did not exceed the temperature here specified: but as oft as the mercury reached 47°, they became very susceptible of external impressions, and awaked in the evenings, when they repaired to their stock of provisions, of which they consumed not a little. The same dry food was injudiciously persisted in through the succeeding summer; in consequence of which they grew sickly, and died before the winter commenced: so that I had not a second opportunity to attend to the economy of this couple during the cold season.

The pair killed by improper treatment.

A third dormouse more judiciously treated.

About the middle of April, 1793, I obtained a third dormouse fresh from the woods: former experience taught me to manage this in a manner more congenial to its constitution; for in addition to the nuts and biscuit, it was constantly supplied with green hazel-buds or raisins in spring; with ripe fruits, particularly cherries and pears, in summer; and with apples and raisins in winter. This generous diet not only preserved the creature in health and high condition, but appeared to fortify it against the benumbing effects of cold, which it supported the following winter much better than the other couple had done formerly: for it never slept more than 48 hours, and that but seldom, without visiting the cup which contained its provisions.

Proof of the third objection.

I now began to suspect the torpidity of the dormouse in a wild state, to be nothing but a custom imposed by necessity on a constitution, which nature has intended to retain life during the cold season of winter, with but little food and an imperfect degree of respiration, as well as a languid or perhaps a partial action of the sanguiferous system. The preceding supposition can alone reconcile the difference of manners observable in the dormice I had in 1792, and that which has been described above: for as soon as the necessity of sleeping was removed, the propensity to become torpid with cold disappeared in a great measure. The uncommonly severe weather which ushered in the next year, viz.

1795,

1795, confirmed the foregoing opinion apparently beyond exception: for a constant use of a generous and plentiful diet had by this time completely conquered the torpid habit, which the animal in all probability contracted in its native habitation from hunger, or more properly from a state of inactivity voluntarily imposed on itself, with a view to husband its stock of nuts, which would be frequently too soon exhausted but for this precaution. Notwithstanding the hard frost of January, it braved the cold with wonderful fortitude, or if the expression be thought less exceptionable, with wonderful indifference; for it awaked every evening, when it consumed in the course of the night a quantity of food amounting to 100 or 120 grains, and frequently gnawed the ice which covered the water in the cage: it even undertook, in the coldest part of the month, to repair its nest, which happened to receive an injury, and perfected the task in one night.

Many instances are recorded of animals being compelled by strong circumstances to relinquish their characteristic manners, in order to act a part contrary in several important points to the uniform conduct of their species. Linnæus has preserved the memory of a tame fieldfare, *turdus pilaris*, belonging to a vintner in Stockholm, which learned to drink wine, and became bald in consequence of this strange beverage. I also knew a mastiff, which was equally fond of ale, and never failed to get drunk when an opportunity offered. The hyæna lives on the roots of fritillary, in the unfrequented parts of Africa; but in the vicinities of populous cities it changes into a disgusting glutton, feeding on filth and carrion. May not the nasty ways of the domestic hog be considered as so many new habits introduced by similar causes in lieu of the cleaner manners of the wild animal? The pied flycatcher, *muscipala atricapilla*, lives on soft seeds and insects in this country; but its food is very different in Norway, especially during winter, when it repairs to the habitations of men, where it subsists on flesh dried in the smoke. Signior Spallanzani converted a pigeon, which is granivorous, into a carnivorous bird, by inducing it in the first place to eat fresh meat, and afterward to give a preference to putrid animal substances. In reality, the

Instances of  
animals chang-  
ing their habits

facts

facts which prove how little philosophers know of the principle of accommodation, that regulates the animal economy according to prevailing circumstances, are already numerous, and observation bids fair to multiply them.

The diminished action of the brain the cause of torpidity.

I have shown in the present essay, that a quadruped remarkable for its torpidity may be rendered active at all seasons by a plentiful and generous diet: perhaps a contrary regimen properly managed might incline an animal, no less remarkable for its activity, to become torpid at times. The preceding suggestion will not appear absurd to those, who view torpidity in the light it is here represented, I mean as a periodical custom of prolonging sleep to an unusual length, the respiration becoming at the same time slow and feeble, and the heat of the body diminishing of consequence. Some singular anomalies in the history of man himself may be said to answer in part to the foregoing description, and to indicate an incipient propensity to become torpid under certain circumstances. There are instances of great insensibility arising from the operation of causes on the system, which have an evident tendency to destroy the vital power; or which, to speak more properly, incapacitate the brain to generate this power in sufficient quantity, to supply the various demands of the voluntary and involuntary functions: the little that is produced being expended on those operations of the economy, which are absolutely necessary for the continuance of life. Dr. Plot relates the case of a poor girl eight years old, who, being beaten by a severe stepmother, and then sent hungry with some refreshments to her father in the fields, could not refrain from eating part of them; reflecting afterwards on the probable consequences of her conduct, she proceeded no further on her way, but retired to a neighbouring wood, and there fell into a profound sleep, being oppressed with fear and sorrow: in this state she remained for seven days, and, when discovered, showed no symptoms of life, beside the softness of her flesh, and flexibility of her joints. Dan. Ludovicus, from whom Dr. Plot borrows this relation, happened to be present, and succeeded in his attempts to recover this poor creature. He first washed a glutinous phlegm from her face with warm water, and cleared her mouth and nostrils from

Proof of objection 4th.

from a viscid substance that obstructed them: a few spoonfuls of brandy were then administered; after the second she was heard to groan, after the third she opened her eyes, and so came at length to herself by degrees (History of Staffordshire, chap. viii, sect. 36). The same author has also preserved another instance of a sleeper in the circle of his own acquaintance. This is the history of Mary Foster, of Admaston; but her singular case is too imperfectly stated, to ascertain any thing more than the fact and cause of it. She remained in a profound sleep for fourteen days and nights, after an equal period of fear and anxiety, occasioned by the woman falling casually into a well; and the accident seems to have produced in her a disposition to torpor: for two years afterwards she slept two nights and a day at Uttoxeter, but the reason of this relapse is omitted. The annals of medicine furnish without doubt many more examples of a like nature; but the few which I have specified appear sufficient to prove, that torpidity is a mere habit, and not a constitutional principle of the animal economy.

*Supplementary remarks.*

I was unacquainted, at the date of the preceding essay, with an experiment made by Mr. Pallas, and mentioned by Mr. Cox, in his Travels through Russia. This celebrated Russian naturalist conquered the torpid habit in a marmot, by confining it through winter to a warm stove, and giving it a plentiful supply of food. If my recollection be correct, the species of Mr. Pallas's marmot is overlooked by Mr. Cox, but the omission is of little moment, seeing the fact has been ascertained by a philosopher of high reputation.

The natural history of the earless marmot, *arctomys citellus*, also establishes the general proposition, viz. that torpidity is a habit, and not a necessary propensity. These animals imitate the manners of the hearth cricket; for those that burrow in the fields fall asleep about the end of September, and appear again with the first symptoms of spring; but when the same quadruped finds its way into a granary, it remains active all winter.

The preceding observations agree very well with the substance of the present essay, and my last on the same subject: General remark.

ject: but the experiment, made on the dormouse, appears to throw a light on the nature of torpidity; which perhaps, as far as I know, can not be derived from any other fact in natural history: for according to it, a liberal use of nutritious food will in time enable this little animal to support a degree of cold much severer than that which benumbs the same creature when wild and habituated to a meager diet. This is a solitary instance of the surprising effects produced on the constitution by regimen; from which we may infer, that the torpidity of the dormouse arises from the united operations of cold and hunger; but future observations must determine how far other torpid animals are influenced by diet, before we can pronounce the preceding explanation of torpidity to be general.

## II.

*On the Nonexistence of Oxygen and Hydrogen, as Bases of particular Gasses; the Action of Galvanism; and the compound Nature of the Matter of Heat. In a Letter from G. S. GIBBES, M. D.*

To Mr. NICHOLSON,

SIR,

Bath, Jan. 13, 1808.

Objections to the theory of Lavoisier.

YOU have already done me the honour of publishing in your excellent Journal some opinions, which I maintain, respecting the nonexistence of oxygen and hydrogen; and the consequent failure of the Lavoisierian theory of chemistry in explaining the phenomena, which are presented in that science. I now take the liberty of sending some farther observations on the same subject, which lead me to conclude, that my former opinions were well founded, and that the generally received doctrine of the decomposition of water is not consistent with fact. I contend, that in no one experiment have we the least evidence, that the ponderable parts of oxygen and hydrogen air are substances differing from each other, or in any respect peculiar substances; or that water is a compound resulting from the union of these two substances.

Theory of the composition of water not founded on fact.

If



If this position can be proved, the Lavoisierian theory will lose its fundamental support, and the whole superstructure falls to the ground.

It is asserted, that the phenomena of galvanism, like electricity, are owing to the presence or absence of one and the same fluid, which constitute the positive and negative sides.

Phenomena of galvanism produced by one fluid.

If two bodies, acting upon a third produce different effects, the bodies themselves must be different.

This contradicted by facts.

A different power is conducted into the water by the two ends of the galvanic battery; for, as the two pieces of platina remain unaltered, the effect on the water in the galvanic experiment must be produced by two different powers, to which the pieces of platina merely act as conductors. The simple fact is then, that the one platina wire produces, when placed in water, one particular air; and the other platina wire, placed under similar circumstances, a different one: the two powers therefore, conducted by the platina wires, must be different.

Bodies in assuming an aeriform state require the union of different other bodies to constitute those characters which distinguish them; therefore these two different airs must have received from the two platina wires two different powers, to enable them, since water is concerned in the production of both, to assume two different aeriform states. The two airs, so formed, have certainly distinguishing characters; for the one supports combustion, and the other is a combustible body.

The same substance converted into different gasses, by the addition of different substances.

Water then is by the union of these two galvanic powers transformed into two aeriform bodies, in which reside all the requisite circumstances of inflammation and combustion. Upon this combustion water is reproduced, and the two galvanic powers form fire; fire therefore is composed of the two galvanic powers.

Fire a compound of the two galvanic powers.

Water then and one power of the pile produces oxygen air; and water and the other power, hydrogen air: and combustion is always produced by the union of these two powers. The positive end of the galvanic battery then we assert, produces in every instance that effect on bodies which oxygen is asserted to do; and is not the basis or ponderable part of the

Water with one of these forms oxygen, with the other hydrogen.

air,

air, but the expansible power, which causes water to assume that peculiar acriform state. The same reasoning holds good with respect to the galvanic property of the negative end of the pile, as in the instance of metallic calces being reducible to their metallic state; and we account for this by saying, that the oxidated or positive state of the metal is destroyed by its being saturated with the hidrogenous or negative power of the pile. In short, bodies are burnt by the power or principle which comes from one end of the pile, and unburnt by the power or principle which comes from the other end of the pile.

**Metallic calces reduced by one power saturating the other.** Metals are combustible bodies, and in becoming oxides they are burnt. Metals not easily burnt are rendered more combustible by being connected with the negative end of the pile. Thus copper, which is easier converted into an oxide than silver, will in ordinary cases take the acid from a solution of silver in nitrous acid, and the silver will be deposited in its metallic form; but if silver be rendered more combustible by being connected with the pile, it will then supersede the copper in its attraction for the acid, and the copper will be deposited in its metallic form. The above proves, that a real and distinct power is communicated to the silver by the pile.

**Bodies burnt by one and unburnt by the other.** Metals rendered more combustible by the negative end of the pile: and thus their affinities changed.

**Neutral salts decomposed by galvanism.** Mr. Davy has shown, that neutral salts are decomposed by the powers of the pile; that the acids appear on the positive side, and the bases on the negative; and that, when muriatic salts are decomposed, the oxygenated muriatic acid appears on the positive side. The galvanic apparatus resolves the matter of heat into its two constituent principles, which principles, being thereby freed from their affinity with each other, are at liberty to enter into new combinations; these combinations of the one, as with water in oxygen air, in acids, metallic oxides, &c.; and of the other in combustible bodies of all kinds, I shall attempt to illustrate by experiments, which I shall take the liberty of transmitting to you in a future letter.

**Galvanic apparatus decomposes the matter of heat into its two principles.**

**Experiments promised.**

I am, Sir,

Yours, &c.

G. S. GIBBES.

## III.

*Letter from N. R. D., containing some Remarks and Emendations of his Communication in the Number for January.*

To Mr. NICHOLSON.

SIR,

I Take the liberty of sending you a few remarks on the translation from Lalande, which you did me the favour of inserting in the last number of your Journal. My only reason for sending it originally to you was, the hopes of being useful, and the same motive induces me to point out the corrections which have occurred to me. Corrections & additions to the paper on the Constellations in our 81st number.

In p. 3 I have given a somewhat different description from Lalande of the means by which we may find the constellation of Gemini; because I think that in general it is much more clear to the beginner, when the object to be found is situate between two others, with which he is already acquainted. I therefore ventured to alter the arrangement of my author's directions, while I preserved the substance of it: but it might have marked the line still more strongly, if I had added with him, that it passes nearly through  $\epsilon$  and  $\zeta$  the two stars in the tail of the great Bear which are nearest the body.

P. 5, l. 18. Lalande describes the head of Andromeda as the "most northern" star in the square of Pegasus, and so it really is; but its declination so little exceeds that of  $\beta$  Pegasus, that it would have been much more clear to have called it the "N. E." star. Head of Andromeda.

P. 8, line 6 from bottom. The "leg" of Ophiucus is substituted for the "foot," in consequence of my having used Dr. Bevis's Uranographia Britannica. The eastern foot is there placed in  $10^\circ$  or  $11^\circ$  of south declination. I had not, when I wrote, the opportunity of consulting Flamsteed's Atlas Cœlestis, or I should have made no alteration. This circumstance will account for my having omitted the notice of the two feet being on the ecliptic. Ophiucus.

P. 9, l. 12 from bottom. A line drawn from Capella  $\alpha$  Ceti through the Pleiades will also "pass south of  $\alpha$  Ceti." It should have been said, as it is in the French, that it will point

point to  $\alpha$  Ceti. The alteration was suggested by looking, through mistake, at the Hyades near Aldebaran, instead of the Pleiades.

$\alpha$  Piscium.

P. 10. The direction for finding  $\alpha$  Piscium was altered from the wish before mentioned, of giving two known objects on opposite sides of that which was to be pointed out; and the proximity of  $\sigma$  Ceti made it very useful for this purpose. I still think, that this description is better than Lalande's, when  $\sigma$  is brilliant; but as that star is sometimes invisible, the original should likewise have been added, which says, that  $\alpha$  Piscium will be found in the line drawn from  $\gamma$ , the foot of Andromeda, through the head of Aries.

P. 10, l. 13 from bottom. "Les deux precedentes" are rendered "the two eastern" stars in the body of the great Bear. This translation is only accurate when the constellation is under the pole. The stars should therefore have been described as those which are "farthest from the tail."

The above remarks may induce your readers to think, that I have taken greater liberty with my original than I have even given notice of in the short note at p. I: and as it is a bold measure for an anonymous writer, to venture on correcting what has been printed by an author of established fame like Lalande, it may be right to mention a few of the instances which occur in the text, to prove that some revision was necessary. In § 770, Aquila is described as being "au milieu de la Lyre et du Cygne;" there can be no doubt, that this ought to be "au midi de la Lyre et du Cygne." § 774. The tail of the Serpent is said to be "vers l'occident," with respect to Ophiucus, when it certainly is towards the east. § 779. Aquarius is said to be as far from the Dolphin as the Dolphin is from the Eagle; but no one acquainted with the heavens will blame me, for substituting the Lyre in this place instead of the Eagle.—I took considerable pains in comparing the translation with the globe and the Celestial Atlas, and I hope therefore, that it will be found in some parts more accurate even than the original, especially when the following additions are made and errata corrected. I sincerely regret, that there should be any occasion for correction, and I can only apologise by  
 stating,

Errors in Lalande.

stating, that the copy was written out under a most unusual press of business, which scarcely allowed me to finish it in time to send it to you as soon as I had promised.

Jan. 15, 1808.

N. R. D.

In p. 2, l. 18, *for* points to *read* points nearly to.—p. 4, l. 6, after *horus* *add* which are  $8^{\circ}$  apart.—*ib*, l. 32, *for* first *read* third.—p. 7, l. 25, *after* and *add* of the.—p. 8, l. 6, *for* through *read* near: l. 23, *for* south-east *read* south-west: l. 27, *after*  $\delta$  *add* a changeable star.—p. 9, l. 13 from bott. *for* 3d *read* 2d.—p. 10, l. 7, *for* the Whale *read* Aries.—p. 11, l. 19, *for*  $32^{\circ} 2'$  *read*  $33^{\circ} 2'$ .

#### IV.

*On the Advantages of Grafting Walnut, Mulberry, and Chesnut Trees.* By THOMAS ANDREW KNIGHT, Esq.  
F. R. S. &c.\*

**I**N the course of very extensive experience in the propagation of apple and pear trees, I found that the detached parts of the bearing branches of old trees of those species, when employed as grafts, never formed what could with propriety be called young trees: the stocks appeared to afford nutriment only; and the new plants retained, in all instances, the character and habits of the bearing branches of which they once formed parts; and generally produced fruit the second or third year after the grafts had been inserted†.

Grafts of bearing branches do not form young trees.

I was therefore induced to hope, that the effects of time might be anticipated in the culture of several fruits, the trees of which remain unproductive during many years after they are planted: and that parts of the bearing branches of those, detached

Applied to the speedy production of certain fruits.

\* From the Trans. of the Horticultural Society. Vol I, p 60.

† Columella appears to have known, that a cutting of a bearing branch did not form a young tree; for speaking of cuttings of the vine (*semina*) he says, “*optima habentur a lumbis; secunda ab humeris; tertia summa iu vite lecta, quæ celerime comprehendunt, et sunt feraciora, sed et ouam celerime senescunt.*” *De Arboribus, chap. 3.*

detached from the old trees, and employed as grafts, would still retain the character and habits of bearing branches.

Experiment  
with the wal-  
nut.

Having therefore planted in the spring of 1799 some walnut trees, of two years old, in garden pots, I raised them up to the bearing branches of an old walnut tree, by placing them on the top of poles placed in the earth; and I grafted them, by approach, with parts of the bearing branches of the old tree. A union took place during the summer, and in the autumn the grafts were detached from the parent stock. The plants thus obtained were planted in a nursery, and, without any peculiar care or management, produced both male and female blossoms in the third succeeding spring, and have since afforded blossoms every season. The frost has, however, rendered their blossoms, as well as those of other trees in their vicinity, wholly unproductive during the last three years, and in the spring of 1805, almost wholly destroyed the wood of the preceding year. A similar experiment was made in the same year, but under many disadvantages, on the mulberry tree. I had not any young plants of this tree, and therefore could only make the experiment with scions of one year old; and of these I had only two, which had sprung from the roots of a young tree, in the preceding year. These were planted in pots, and raised to the bearing branches of an old tree, in the manner I have already described in speaking of the walnut tree. One of these scions died; the other, which had but very few roots, succeeded; and the young grafted tree bore fruit the third year, and has continued annually productive. In the last spring I introduced it into my vinery, where its fruit ripened, in the greatest state of perfection, in the beginning of the present month, [January, 1807].

With the mul-  
berry.

Grafting by ap-  
proach best for  
them.

Both the walnut and mulberry tree succeed so ill when grafted, unless by approach, that I can scarcely recommend attempts to propagate them in any other way; but when they succeed by other modes of grafting, nearly the same advantages will probably be obtained: the habit of the bearing branch is, however, least disturbed by grafting by approach.

Spanish ches-  
nut succeeds  
any way.

The Spanish chesnut succeeds readily when grafted in almost any of the usual ways, and when the grafts are taken from

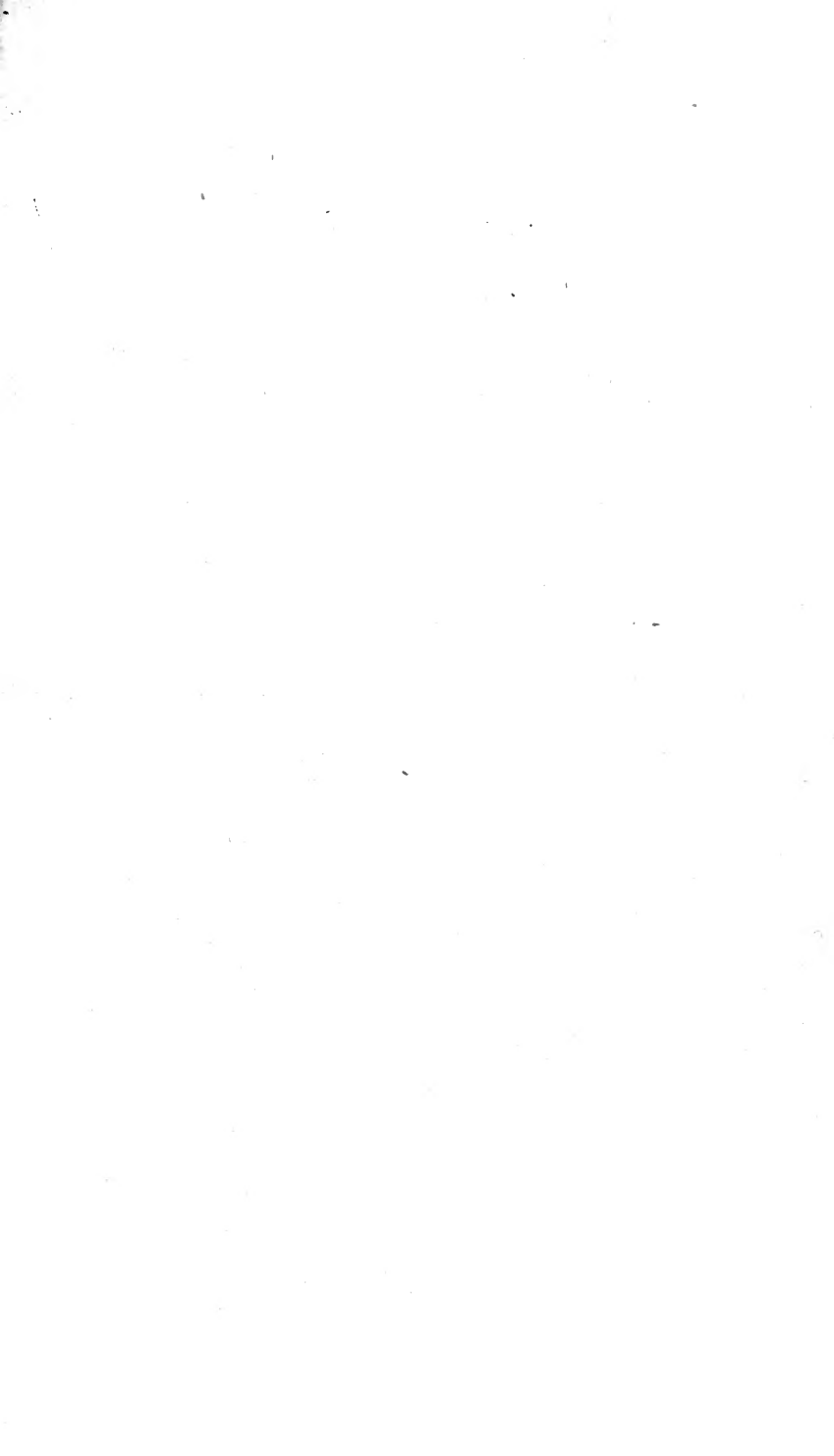

*D<sup>r</sup> Herschel on coloured concentric Rings.*

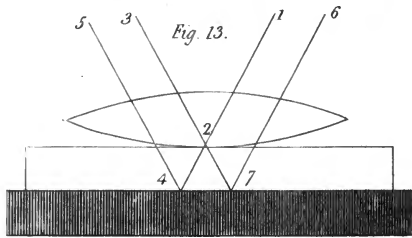
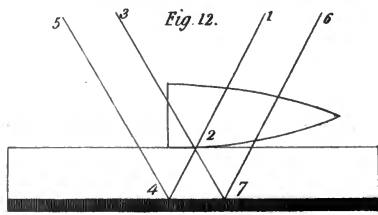
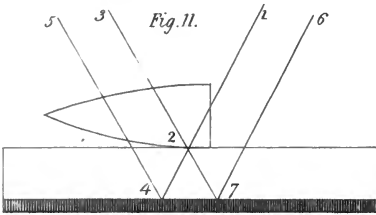
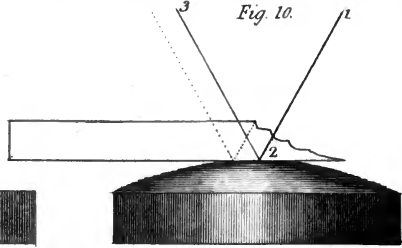
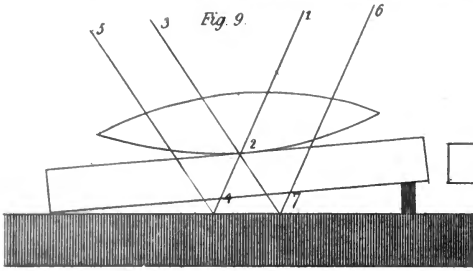

Fig. 3.

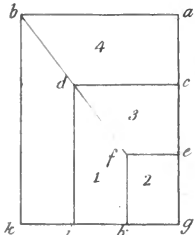
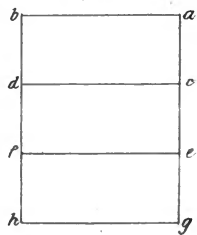
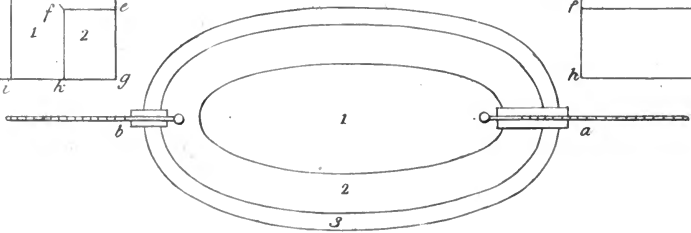

Fig. 2.



*D<sup>r</sup> Joseph Read's Calorimeter.*

Fig. 1.





from bearing branches, the young trees afford blossoms in the succeeding year: and I am much inclined to think, from experiments I have made on this tree, that by selecting those varieties which ripen their fruit early in the autumn, and by propagating with grafts or buds from young and vigorous trees of that kind, which have just attained the age necessary to enable them to bear fruit, it might be cultivated with much advantage in this country, both for its fruit and timber.

Valuable both for its fruit and timber.

I have tried similar experiments on many other species of trees, and always with the same result; and I entertain no doubt, that the effects of time might be thus anticipated in the culture of any fruit, which is not produced till the seedling trees acquire a considerable age. For I am thoroughly confident, from very extensive and long experience, that the graft derives nutriment only, and not growth, from the young stock in which it is inserted; and that with the life of the parent stock the graft retains its habits and its constitution.

Tried on many other trees, and thus their maturity anticipated.

---

## V.

*Experiments for investigating the Cause of the coloured concentric Rings, discovered by Sir ISAAC NEWTON, between two Object-glasses laid upon one another. By WILLIAM HERSCHEL, L. L. D. F. R. S.*

(Concluded from p. 142.)

XIX. *Of the Place where the different Sets of Rings are to be seen.*

BY an application of the same course of the rays, we may now also determine the situation of the place, where the different sets of rings are seen: for, according to what has been said in the foregoing article, the situation of the primary set should be between the lens and the surface of the looking-glass: and the place of the secondary one at the metalline coating of the lowest surface. To try whether this be actually as represented, let us substitute a metalline mirror

Place where the different sets of rings are seen.

with a slip of glass laid upon it in the room of the piece of looking-glass; and let there be interposed a short bit of wood, one tenth of an inch thick, between the slip of glass and the mirror, so as to keep up that end of the slip which is towards the light. This arrangement is represented in Pl. V, fig. 9, where both sets of rays are delineated. Then if we interpose a narrow tapering strip of card, discoloured with japan ink, between the slip of glass and the mirror, so as to cover it at 7, we do not only still perceive the primary set, but see it better than before: which proves, that, being situated above the slip of glass, the card below cannot cover it. If on the contrary we insert the strip of card far enough, that it may at the same time cover the mirror both at 4 and at 7, we shall lose the secondary set, which proves, that its situation was on the face of the mirror.

Eye-glass requires a different adjustment for each set.

When several sets of rings are to be perceived by the same eye-glass, and they are placed at different distances, a particular adjustment of it will be required for each set, in order to see it well defined. This will be very sensible when we attempt to see three or four sets, each of them situated lower than the preceding; for without a previous adjustment to the distance of the set intended to be viewed, we shall be seldom successful; and this is therefore a corroborating proof of the situation, that has been assigned to different sets of rings.

### XX. *Of the Connection between different Sets of Rings.*

Connexion between different sets.

It will now be easy to explain in what manner different sets of rings are connected, and why they have been called primary and dependent. When the incident rays come to the point of contact, and form a set of rings, I call it the primary one: when this is formed, some of the rays are continued by transmission or reflection, but modified so as to convey an image of the primary set with opposite colours forward through any number of successive transmissions or reflections; whenever this image comes to the eye, a set of rings will again be seen, which is a dependent one. Many proofs of the dependency of the second, third, and fourth sets of rings upon their primary one may be given; I shall only mention a few.

Proofs that all

When two sets of rings are seen by a lens placed upon a looking-

looking-glass, the centre of the secondary set will always remain in the same plane with the incident and reflected rays passing through the centre of the primary one. If the point of contact is changed by tilting, the secondary set will follow the motion of the primary set; and if the looking-glass is turned about, the secondary will be made to describe a circle upon that part of the looking-glass, which surrounds the primary one as a centre. If there is a defect in the centre or in the rings of the primary set, there will be exactly the same defect in the secondary one; and if the rays that cause the primary set are eclipsed, both sets will be lost together. If the colour of the primary one is changed, that of the secondary will also undergo its alternate change, and the same thing will hold good of all the dependent rings, when three or four sets of them are seen, that have the same primary one.

the other sets depend on the primary one.

The dependency of all the sets on their primary one may also be perceived, when we change the obliquity of the incident light; for the centres of the rings will recede from one another when that is increased, and draw together when we lessen it, which may go so far, that by an incidence nearly perpendicular we shall bring the dependent sets of rings almost under the primary one.

### XXI. *To account for the Appearance of several Sets of Rings with the same coloured Centres.*

It has often happened, that the colour of the centres of different sets was not what the theory of the alternation of the central colours would have induced me to expect: I have seen two, three, and even four sets of rings, all of which had a white centre. We are however now sufficiently prepared, to account for every appearance relating to the colour of rings and their centres.

Why several sets have the same coloured centre.

Let an arrangement of glasses be as in figure 9. When this is laid down so as to receive an illumination of day light, which should not be strong, nor should it be very oblique, the reflection from the mirror will then exceed that from the surface of glass; therefore the primary set will be seen by the rays 6, 7, coming to the mirror at 7, and going through the point of contact in the direction 7, 2, 3, which proves it to be

a set that is seen by transmission, and it will therefore have a white centre. The rays 1, 2, 4, passing through the point of contact, will also form a transmitted set with a white centre, which will be seen when the reflection from 4 to 5 conveys it to the eye. But these two sets have no connection with each other; and as primary sets are independent of all other sets, I have only to prove, that this secondary set belongs not to the primary one which is seen, but to another invisible one. This may be done as follows.

Introduce the black strip of card, that has been mentioned before, till it covers the mirror at 7; this will take away the strong reflection of light, which overpowers the feeble illumination of the rays 1, 2, 3; and the real hitherto eclipsed primary set, belonging to the secondary one with a white centre, will instantly make its appearance with a black one. We may alternately withdraw and introduce again the strip of card, and the centre of the primary set will be as often changed from one colour to its opposite; but the secondary set, not being dependent on the rays 6, 7, will not be in the least affected by the change.

If the contact should have been such as to give both sets with orange centres, the introduction of the strip of card will prove, that the set which is primary to the other has really a green centre.

Another way of destroying the illusion is to expose the same arrangement to a brighter light, and at the same time to increase the obliquity of the angle of incidence; this will give a sufficient reflection from the surface of the glass to be no longer subject to the former deceptive appearance; for now the centre of the primary set will be black, as it ought to be.

## XXII. *Of the reflecting Surfaces.*

Situation of the surfaces that reflect the rings.

The rays of light, that form rings between glasses, must undergo certain modifications by some of the surfaces through which they pass, or from which they are reflected; and to find out the nature of these modifications, it will be necessary to examine which surfaces are efficient. As we see rings by reflection, and also by transmission, I shall begin with the most simple, and show experimentally the situation

of

of the surface that reflects, not only the primary but also the secondary sets of rings.

Upon a slip of glass, the lowest surface of which was deprived of its polish by emery, I laid an object-glass of 21 feet focal length, and saw a very complete set of rings. I then put the same glass upon a plain metalline mirror, and saw likewise a set of them. They were consequently not reflected from the lowest surface of the subjacent glass or metal.

It will easily be understood, that, were we to lay the same object-glass upon a slip of glass emiered on both sides, or upon an unpolished metal, no rings would be seen. It is therefore neither from the first surface of the incumbent object-glass, nor from its lowest, that they are reflected; for if they could be formed without the modification of reflection from the upper surface of a subjacent glass or metal, they would still be seen when laid on rough surfaces; and consequently, the efficient reflecting surface, by which we see primary sets of rings, is that which is immediately under the point of contact.

The reflecting surface that under the point of contact.

To see a secondary set of rings by reflection, is only an inversion of the method of seeing a primary one. For instance, when a lens is laid upon a looking glass, the course of the rays represented in figure 8, pl. IV, will show, that the rays, 1, 2, 3, 5, 6, by which a secondary set is seen, are reflected about the point of contact at 3, and that the lowest surface of the incumbent lens is therefore the efficient reflecting one; and thus it is proved, that in either case of seeing reflected rings, one of the surfaces that are joined at the point of contact contributes to their formation by a certain modification of reflection.

### XXIII. *Of the transmitting Surfaces.*

It would seem to be almost self-evident, that, when a set of rings is seen by transmission, the light which occasions them must come through all the four surfaces of the two glasses which are employed; and yet it may be shown, that this is not necessary. We may, for instance, convey light into the body of the subjacent glass through its first surface, and let it be reflected within the glass at a proper angle, so that it

Transmitting surfaces.

it may come up through the point of contact, and reach the eye, having been transmitted through no more than three surfaces. To prove this I used a small box, blackened on the inside, and covered with a piece of black pastboard, which had a hole of about half an inch in the middle. Over this hole I laid a slip of glass with a 56-inch lens upon it; and viewed a set of rings given by this arrangement very obliquely, that the reflection from the slip of glass might be copious. Then guarding the point of contact between the lens and the slip of glass from the direct incident light, I saw the rings, after the colour of their centre had been changed, by means of an internal reflection from the lowest surface of the slip of glass; by which it rose up through the point of contact, and formed the primary set of rings, without having been transmitted through the lowest surface of the subjacent glass. The number of transmitting surfaces is therefore by this experiment reduced to three; but I shall soon have an opportunity of showing, that so many are not required for the purpose of forming the rings.

#### XXIV. *Of the Action of the first Surface.*

Action of the upper surface.

We have already shown, that two sets of rings may be seen by using a lens laid upon a slip of glass; in which case, therefore, whether we see the rings by reflection or by transmission, no more than four surfaces can be essential to their formation. In the following experiments for investigating the action of these surfaces I have preferred metalline reflection, when glass was not required, that the apparatus might be more simple.

This not affected by a strong scratch,

Upon a plain metalline mirror I laid a double convex lens, having a strong emery scratch on its upper surface. When I saw the rings through the scratch, they appeared to have a black mark across them. By tilting the lens, I brought the centre of the rings upon the projection of the scratch, so that the incident light was obliged to come through the scratch to the rings, and the black mark was again visible upon them, but much stronger than before. In neither of the situations were the rings disfigured. The stronger mark was owing to the interception of the incident light, but when the rings had received

received their full illumination, the mark was weaker, because in the latter case the rings themselves were probably complete, but in the former deficient.

I placed a lens that had a very scabrous polish on one side, scabrousness, but was highly polished on the other, upon a metalline mirror. The defective side being uppermost, I did not find that its scabrousness had any distorting effect upon the rings.

I splintered off the edge of a plain slip of glass; it broke as or irregularity. it usually does with a waving, striated, curved slope coming to an edge. The splintered part was placed upon a convex metalline mirror of 2 inches focus, as in Pl. V, fig. 10. The irregularity of the striated surface, through which the incident ray 1, 2, was made to pass, had very little effect upon the form of the rings; the striæ appearing only like fine dark lines, with hardly any visible distortion; but when, by tilting, the returning ray, 2, 3, was also brought over the striated surface, the rings were much disfigured. This experiment therefore seems to prove, that a very regular refraction of light by the first surface is not necessary; for though the rings were much disfigured, when the returning light came through the splintered defect, this is no more than what must happen to the appearance of every object, which is seen through a distorting medium.

I laid the convex side of a plano-convex lens of 2·8-inch Altering the angle of incidence had no effect. focus with a diameter of 1·5 upon a plain mirror, and when I saw a set of rings, I tilted the lens so as to bring the point of contact to the very edge of the lens, both towards the light and from the light, which, on account of the large diameter of the lens, gave a great variety in the angle of incidence to the rays which formed the rings; but no difference in their size or appearance could be perceived. This seems to prove, that no modification of the first surface in which the angle of incidence is concerned, such as refraction and dispersion, has any share in the production of the rings, and that it acts merely by the intromission of light; and though even this is not without being influenced by a change of the angle, it can only produce a small difference in the brightness of the rings.

A more forcible argument, that leads to the same conclusion, Farther proof.  
sion,

sion, is as follows: Laying down three 54-inch double convex lenses, I placed upon the first the plain side of a plano-convex lens of  $\frac{5}{8}$  inch focus; upon the second, a plain slip of glass; and upon the third, the plain side of a plano-concave lens also  $\frac{5}{8}$  inch focus. I had before tried the same experiment with glasses of a greater focal length, but selected these to strengthen the argument. Then, as nothing could be more different than the refraction of the upper surfaces of these glasses, I examined the three sets of rings that were formed by these three combinations, and found them so perfectly alike, that it was not possible to perceive any difference in the size and colour. This shows, that the first surface of the incumbent glasses merely acts as an inlet to the rays that afterward form the rings.

The first surface simply an inlet to the rays.

Surface roughened with emery.

To confirm the idea, that the mere admission of light would be sufficient, I used a slip of glass polished on one side but roughened with emery on the other; this being laid upon a 21-foot object-glass, I saw a set of rings through the rough surface; and though they appeared hazy, they were otherwise complete in figure and colour. The slip of glass, when laid in the same manner upon the letters of a book, made them appear equally hazy; so that the rings were probably as sharply formed as the letters.

Having now already great reason to believe, that no modification, that can be given by the first surface to the incident rays of light, is essential to the formation of the rings, I made the following decisive experiment.

Experimentum crucis.

Upon a small piece of looking-glass I laid half a double convex lens of 16 inches focus, with the fracture exposed to the light, as represented in figure 11. Under the edge of the perfect part of the lens was put a small lump of wax, soft enough to allow a gentle pressure to bring the point of contact towards the fractured edge, and to keep it there. In this arrangement it has already been shown, that there are two different ways of seeing two sets of rings: by the rays 1, 2, 3, we see a primary set; and by 1, 2, 4, 5, the secondary set belonging to it: by the rays 6, 7, 2, 3, we see a different primary set; and by 6, 7, 2, 4, 5, we see its secondary one. That this theory is well founded has already been proved; but



but if we should have a doubt remaining, the interposition of any small opaque object upon the looking glass near the fracture will instantly stop the latter two sets of rings, and show the alternate colours of the two sets, that will then be seen by the rays 1, 2, 3, and 1, 2, 4, 5. Remove in the next place the stop from the looking-glass, and bring the second shadow of the penknife over the primary set, and there will then only remain the two sets of rings formed by incident rays which come from 6, and which have never passed through the upper surface of the lens. Now, as both sets of rings in this case are completely formed by rays transmitted upwards from the coated part of the looking-glass without passing through the first surface of the incumbent lens, the proof that the modifying power of that surface is not required to the formation of the rings, is established.

It can hardly be supposed, that the first surface of the lens should have any concern in the formation of the rings, when the rays are reflected from the looking-glass towards the eye; but the same experiment, that has proved that this surface was not required to be used with incident rays, will show, that we may do without it when they are on their return. We need only invert the fractured lens, as in figure 12, when either 1, 2, 4, 5, or 6, 7, 2, 4, 5, will convey the image of the rings, after their formation, to the eye, without passing through any part of the lens.

The upper surface not necessary for the returning ray.

#### XXV. *Of the Action of the second Surface.*

As rings are formed when two glasses are laid upon each other, it is but reasonable to expect, that the two surfaces at least which are placed together should have an immediate effect upon them; and so much the more, as it has been ascertained, that the first surface assists only by permitting light to pass into the body of the glass. Some of the experiments, that have been instituted for examining the action of the first surface, will equally serve for investigating that of the second.

Action of the second surface.

The lens already used with a strong emery scratch being again placed on the mirror, but with the injured side downwards, I found that the rings, when brought under the scratch, were

Scratched.

were

were not distorted; they had only a black mark of the same shape as the scratch across them.

Scabrous.

The lens with a scabrous side was also placed again upon the mirror, but with the highly polished side upwards. In this position the scabrousness of the lowest surface occasioned great irregularity among the rings, which were indented and broken wherever the little polished holes that make up a scabrous surface came near them; and if by gently lifting the lens a strong contact was prevented, the colours of the rings were likewise extremely disfigured and changed.

Is the distortion occasioned by the rings being seen through an irregular medium?

As we have now seen that a polished defect upon the second surface will affect the figure of the rings that are under it, it will remain to be determined, whether such defects do really distort them by some modification they give to the rays of light in their passage through them, or whether they only represent the rings as deformed, because we see them through a distorted medium. For although the scabrousness did not sensibly affect the figure of the rings when it was on the first surface, we may suppose the little polished holes to have a much stronger effect in distorting the appearance of the rings when they are close to them. The following experiment will entirely clear up this point.

Effect of a polished line.

Over the middle of a 22-inch double convex lens I drew a strong line with a diamond, and gave it a polish afterward, that it might occasion an irregular refraction. This being prepared, I laid a slip of glass upon a plain metalline mirror, and placed the lens with the polished line downwards upon the slip of glass. This arrangement has been shown to give two sets of rings. When I examined the primary set, a strong disfiguring of the rings was visible; they had the appearance of having been forced asunder, or swelled out, so as to be much broader one way than another. The rings of the secondary set had exactly the same defects, which, being strongly marked, could not be mistaken. The centres of the two sets, as usual, were of opposite colours, the first being black, the second white; and all those defects, that were of one colour in the first set, were of the opposite colour in the second. When, by the usual method, I changed the colours of the centres of the rings, making that of the primary white and

The primary set much disfigured; and likewise the secondary.

and of the secondary black, the defects in both sets were still exactly alike, and as before; except that they had also undergone the like transformation of colour, each having assumed its opposite. It remains now only to show, that this experiment is decisive; for by the established course of the rays we saw the secondary set of rings when it had a white centre by the transmitted rays marked 1, 2, 4, 5, in figure 13; and when it had a black one, by the reflected rays 6, 7, 2, 4, 5, of the same figure; but in neither of these two cases did the rays come through the defective part of the lens in their return to the eye.

This experiment proves more than we might at first be aware of; for it does not only establish, that the second surface, when properly combined with a third surface, has a modifying power, whereby it can interrupt the regularity of the rings, but also one whereby it contributes to their formation; for, if it can give an irregular figure to them by transmitting its irregularly modified rays, it follows, that when these rays are regularly modified it will be the cause of the regular figure of the rings. Nay, it proves more; for if it modifies the figure of the rings by transmission, it modifies them no less by reflection; which may be seen by following the course of the rays 6, 7, 2, 4, 5; for as they do not pass through the defective place of the lens, they can only receive their modification from it by reflection. This opens a field of view to us, that leads to the cause of all these intricate phenomena, of which in a second part of this paper I shall avail myself.

This proves it to be concerned in the formation of the rings.

Hence we may be led to the cause of the phenomena.

### XXVI. *Of the Action of the third Surface.*

When a double convex lens is laid upon a plain metalline mirror, that happens to have an emery scratch in its surface, we see it as a black line under the rings that are formed over them. This shows, that, when a defect from want of polish has not a power to reflect light in an irregular manner, it cannot distort the rings that are formed upon it.

Action of the 3d surface.

When I laid a good 21-foot object glass upon a plain slip that had some defects in its surface, the rings, in every part of the object glass that was brought over them, were always disfigured; which proves, that a reflection from a defective third

Defects in this capable of distorting the rings,

third surface has a power of forming distorted rings, and that consequently a reflection from one that is perfect must have a power of forming rings without distortion, when it is combined with a proper second surface.

both of the primary and secondary sets.

When the defective slip of glass, with a perfect lens upon it, was placed upon a metalline mirror, I saw the secondary set affected by distortions of the rings that were perfectly like those in the primary set; which proves, that a polished defect in the third surface will give modifications to the rays that form the rings by transmission as well as by reflection.

XXVII. *The Colour of the reflecting and transmitting Surfaces is of no consequence.*

The colour of the surfaces of no consequence.

I laid seven 54-inch double convex lenses upon seven coloured pieces of plain glass. The colours of the glasses were those which are given by a prism, namely, violet, indigo, blue, green, yellow, orange, and red. The rings reflected from each of these glasses were in every respect alike; at least so far that I could have a black, a white, a red, an orange, a yellow, a green, or a blue centre with every one of them, according to the degree of pressure I used. The lenses being very transparent, it may be admitted, that the colours of the glasses seen through them would in some degree mix with the colours of the rings; but the action of the cause that gives the rings was not in the least affected by that circumstance.

I saw the rings also by direct transmission through all the coloured glasses except a dark red, which stopped so much light, that I could not perceive them. The colour of the glasses, in this way, coming directly to the eye, gave a strong tinge to the centres of the rings, so that instead of a pure white I had a blueish white, a greenish white, and so of the rest; but the form of the rings was no less perfect on that account.

XXVIII. *Of the Action of the fourth Surface.*

Action of the 4th surface.

We have already seen, that a set of rings may be completely formed by reflection from a third surface, without the introduction of a fourth; this, at all events, must prove, that

that such a surface is not essential to the formation of rings, but as not only in direct transmission, but also when two sets of rings are to be seen, one of which may be formed by transmission, this fourth surface must be introduced; I have ascertained by the following experiments how far the same has any share in the formation of rings.

In direct transmission, where the light comes from below, the fourth surface will take the part which is acted by the first, when rings are seen reflected from a metalline mirror. Its office therefore will be merely to afford an entrance to the rays of light into the substance of the subjacent glass; but when that light is admitted through the first, second, and third surfaces, the fourth takes the office of a reflector, and sends it back towards the point of contact. It will not be required to examine this reflection, since the light thus turned back again is, with respect to the point of contact, in the same situation in which it was after its entrance through the first surface, when it proceeded to the same point; but when two sets of rings are to be formed by rays, either coming through this point directly towards the fourth surface, or by reflection from the same point towards the place where the secondary rings are to be seen, it will then be necessary to examine, whether this surface has any share in their formation, or whether these rings, being already completely formed, are only reflected by it to the eye. With a view to this, I selected a certain polished defect in the surface of a piece of coach-glass, and when a 26-inch lens was laid upon it, the rings of the set it produced were much distorted. The lens was then put upon a perfect slip of glass, and both together were then laid upon the defective place of the coach-glass. The rings of the secondary set reflected by it were nevertheless as perfect as those of the primary set. It occurred to me, that these rings might possibly be reflected from the lowest surface of the perfect slip of glass, especially as by lifting it up from the coach-glass I still continued to see both sets. To clear up this point, therefore, I took away the slip, and turning the defective place of the coach-glass downwards, produced a set of perfect rings between the lens and the upper surface of the coach-glass, and brought it into such a situation, that a secondary set must

Experiment  
with a polished  
defect in this  
surface.

be

be reflected from the defective place of the lowest surface. This being obtained, the rings of this set were again as well formed, and as free from distortions, as those of the primary set.

Refraction of the 4th surface has little or no effect.

Upon a plain metalline mirror I laid down two lenses, one a plano-convex, the other a plano-concave, both of 2.9 inches focus, and having the plain side upwards. When two 21-inch double convex glasses were laid upon them, the secondary sets of both the combinations were of equal size, and perfectly like their primary sets; which proves, that the refraction of the fourth surface is either not at all concerned, or at least has so little an effect in altering the size of the rings that it cannot be perceived.

The result of the foregoing experiments, relating to the action of the several surfaces, is,

General results.

I. That only two of them are essential to the formation of concentric rings.

II. That these two must be of a certain regular construction, and so as to form a central contact.

III. That the rays from one side, or the other, must either pass through the point of contact, or through one of the surfaces about the same point to the other to be reflected from it.

IV. And that in all these cases a set of rings will be formed, having their common centre in the place where the two surfaces touch each other.

### XXIX. *Considerations that relate to the Cause of the formation of concentric Rings.*

Inquiry concerning the cause of the rings.

It is perfectly evident, that the phenomena of concentric rings must have an adequate cause, either in the very nature or motion of the rays of light, or in the modifications that are given to them by the two essential surfaces that act upon them at the time of the formation of the rings.

This seems to reduce the cause we are looking for to an alternative, that may be determined; for if it can be shown, that a disposition of the rays of light to be alternately reflected and transmitted cannot account for the phenomena, which this hypothesis is to explain, a proposition of accounting for them by modifications that may be proved, even on

the

the very principles of Sir. I. Newton, to have an existence, will find a ready admittance. I propose, therefore, now to give some arguments, which will remove an obstacle to the investigation of the real cause of the formation of the concentric rings; for after the very plausible supposition of the alternate fits, which agrees so wonderfully well with a number of facts that have been related, it will hardly be attempted, if these should be set aside, to ascribe some other inherent property to the rays of light, whereby we might account for them; and thus we shall be at liberty to turn our thoughts to a cause, that may be found in the modifications arising from the action of those surfaces, which have been proved to be the only essential ones in the formation of rings.

XXX. *Concentric Rings cannot be formed by an alternate Reflection and Transmission of the Rays of Light.*

One of the most simple methods of obtaining a set of concentric rings is, to lay a convex lens on a plain metalline mirror; but in this case we can have no transmission of rays, and therefore we cannot have an alternate reflection and transmission of them. If to get over this objection it should be said, that, instead of transmission, we ought to substitute absorption; since those rays, which in glass would have been transmitted, will be absorbed by the metal, we may admit the elusion: it ought however to have been made a part of the hypothesis.

They cannot be formed by alternate reflection and transmission of rays.

XXXI. *Alternate Fits of easy Reflection and easy Transmission, if they exist, do not exert themselves according to various Thicknesses of thin Plates of Air.*

In the following experiment, I placed a plain well polished piece of glass 5·6 inches long, and 2·3 thick, upon a plain metalline mirror of the same length with the glass; and in order to keep the mirror and glass at a distance from each other, I laid between them, at one end, a narrow strip of such paper as we commonly put between prints. The thickness of that which I used was the 640th part of an inch; for 128 folds of it laid together would hardly make up two tenths. Upon the glass I put a 39-inch double convex

If fits of easy reflection and transmission exist, they do not exert themselves according to various thicknesses of thin plates of air.

lens;

lens; and having exposed this combination to a proper light, I saw two complete sets of coloured rings.

In this arrangement, the rays which convey the secondary set of rings to the eye must pass through a thin wedge of air, and if these rays are endowed with permanent fits of easy reflection, and easy transmission, or absorption, their exertion, according to Sir I. Newton, should be repeated at every different thickness of the plate of air, which amounts to the  $\frac{1}{32}$  part of an inch, of which he says, "*Hæc est crassitudo aeris in primo annulo obscuro radiis ad perpendicularum incidentibus exhibito, qua parte is annulus obscurissimus est.*" The length of the thin wedge of air, reckoned from the line of contact, to the beginning of the interposed strip of paper, is 5·2 inches, from which we calculate, that it will have the above mentioned thickness at  $\frac{1}{27}$  of an inch from the contact; and therefore at  $\frac{1}{34}$ ,  $\frac{3}{34}$ ,  $\frac{5}{34}$ ,  $\frac{7}{34}$ ,  $\frac{9}{34}$ ,  $\frac{11}{34}$ , &c. we shall have the thickness of air between the mirror and glass equal to  $\frac{1}{78000}$ ,  $\frac{3}{78000}$ ,  $\frac{5}{78000}$ ,  $\frac{7}{78000}$ , &c.; of which the same author says, that they give "*crassitudines aeris in omnibus annulis lucidis, qua parte illi lucidissime sunt.*" Hence it follows, that, according to the above hypothesis, the rings of the secondary set, which extended over a space of ·14 of an inch, should suffer more than seven interruptions of shape and colour in the direction of the wedge of air.

occurred at least 7 times,

without producing the effect.

In order to ascertain, whether such an effect had any existence, I viewed the secondary set of rings upon every part of the glass-plate, by moving the convex lens from one end of it gradually to the other; and my attention being particularly directed to the 3d, 4th, and 5th rings, which were extremely distinct, I saw them retain their shape and colour all the time without the smallest alteration.

The same experiment was repeated with a piece of plain glass instead of the metalline mirror, in order to give room for the fits of easy transmission, if they existed, to exert themselves; but the result was still the same; and the constancy of the brightness and colours of the rings of the secondary set plainly proved, that the rays of light were not affected by the thickness of the plate of air through which they passed.



XXXII. *Alternate Fits of easy Reflection and easy Transmission, if they exist, do not exert themselves according to various Thicknesses of thin Plates of Glass.*

I selected a well polished plate of coach glass 17 inches long, and about 9 broad. Its thickness at one end was 33, and at the other 31 two hundredths of an inch; so that in its whole length it differed  $\frac{1}{100}$  of an inch in thickness. By measuring many other parts of the plate I found, that it was very regularly tapering from one end to the other. This plate, with a double convex lens of 55 inches laid upon it, being placed upon a small metalline mirror, and properly exposed to the light, gave me the usual two sets of rings. In the secondary set, which was the object of my attention, I counted twelve rings, and estimated the central space between them to be about  $1\frac{1}{2}$  times as broad as the space taken up by the 12 rings on either side; the whole of the space taken up may therefore be reckoned equal to the breadth of 40 rings of a mean size: for the 12 rings, as usual, were gradually contracted in breadth as they receded from the centre, and, by a measure of the whole space thus taken up, I found, that the breadth of a ring of a mean size was about the 308th part of an inch.

No fits exert themselves according to various thicknesses of plates of glass.

Now, according to Sir I. Newton's calculation of the action of the fits of easy reflection and easy transmission in thick glass plates, an alternation from a reflecting to a transmitting fit requires a difference of  $\frac{1}{137784}$  part of an inch in thickness\*; and by calculation this difference took place in the glass plate that was used at every 80th part of an inch of its whole length; the 12 rings, as well as the central colour of the secondary set, should consequently have been broken by the exertion of the fits at every 80th part of an inch; and from the space over which these rings extended, which was about  $\cdot 13$  inch, we find that there must have been more than ten such interruptions or breaks in a set of which the 308th part was plainly to be distinguished. But when I drew the glass plate gently over the small mirror, keeping

\* Newton's Optics, p 277.

the secondary set of rings in view, I found their shape and colour always completely well formed.

This experiment was also repeated with a small plain glass instead of the metalline mirror put under the large plate. In this manner it still gave the same result, with no other difference but that only six rings could be distinctly seen in the secondary set, on account of the inferior reflection of the sub-jacent glass.

**XXXIII.** *Coloured Rings may be completely formed without the Assistance of any thin or thick Plates, either of Glass or of Air.*

The rings may be formed without thick or thin plates of glass or air.

The experiment I am now to relate was at first intended to be reserved for the second part of this paper, because it properly belongs to the subject of the flexion of the rays of light, which is not at present under consideration; but as it particularly opposes the admission of alternate fits of easy reflection and easy transmission of these rays in their passage through plates of air or glass, by proving, that their assistance in the formation of rings is not required, and also throws light upon a subject, that has at different times been considered by some of our most acute experimentalists, I have used it at present, though only in one of the various arrangements, in which I shall have occasion to recur to it hereafter.

Experiment of Sir I. Newton,

Sir I. Newton placed a concave glass mirror at double its focal length from a chart, and observed, that the reflection of a beam of light admitted into a dark room, when thrown upon this mirror, gave "four or five concentric irises or "rings of colours like rainbows\*." He accounts for them by alternate fits of easy reflection and easy transmission exerted in their passage through the glass plate of the concave mirror †.

of the duke of Chaulnes,

The Duke de Chaulnes concluded from his own experiments of the same phenomena, "that these coloured rings depended upon "the first surface of the mirror, and that the "second surface, or that which reflects them after they had "passed the first, only served to collect them and throw them

\* Newton's Optics, p. 265.

† Ibid, p. 277.

" upon

“ upon the pasteboard, in a quantity sufficient to make them  
“ visible \*.”

Mr. Brougham, after having considered what the two au- of Brougham,  
thors I have mentioned had done, says, “ that upon the whole  
“ there appears every reason to believe, that the rings are  
“ formed by the first surface out of the light, which, after  
“ reflection from the second surface, is scattered, and passes  
“ on to the chart †.”

My own experiment is as follows. I placed a highly po- of the author.  
lished 7 feet mirror, but of metal instead of glass, that I  
might not have two surfaces, at the distance of 14 feet from  
a white screen, and through a hole in the middle of it one  
tenth of an inch in diameter I admitted a beam of the sun  
into my dark room, directed so as to fall perpendicularly on  
the mirror. In this arrangement the whole screen remained  
perfectly free from light, because the focus of all the rays,  
which came to the mirror, was by reflection thrown back  
into the hole, through which they entered. When all was  
duly prepared, I made an assistant strew some hair-powder  
with a puff into the beam of light, while I kept my attention  
fixed upon the screen. As soon as the hair-powder reached  
the beam of light, the screen was suddenly covered with  
the most beautiful arrangement of concentric circles, dis-  
playing all the brilliant colours of the rainbow. A great  
variety in the size of the rings was obtained by making the  
assistant strew the powder into the beam at a greater dis-  
tance from the mirror; for the rings contract by an increase  
of the distance, and dilate on a nearer approach of the pow-  
der.

This experiment is so simple, and points out the general  
causes of the rings, which are here produced, in so plain a  
manner, that we may confidently say they arise from the  
flection of the rays of light on the particles of the floating  
powder, modified by the curvature of the reflecting surface  
of the mirror.

Here we have no interposed plate of glass of a given  
thickness between one surface and another, that might pro-

\* Priestley's History, &c. on the Colours of thin Plates, p. 515.

† Phil. Trans. for 1796, p. 216.

duce the colours by reflecting some rays of light and transmitting others; and if we were inclined to look upon the distance of the particles of the floating powder from the mirror as plates of air, it would not be possible to assign any certain thickness to them, since these particles may be spread in the beam of light over a considerable space, and perhaps none of them will be exactly at the same distance from the mirror.

I shall not enter into a further analysis of this experiment, as the only purpose for which it is given in this place is to show, that the principle of thin or thick plates, either of air or glass, on which the rays might alternately exert their fits of easy reflection and easy transmission, must be given up, and that the fits themselves of course cannot be shown to have any existence.

#### XXXIV. *Conclusion.*

Newton's theory of the size and interstices of bodies, founded on fits of easy reflection and transmission of light, unsupported by fact.

It will hardly be necessary to say, that all the theory relating to the size of the parts of natural bodies and their interstices, which Sir I. Newton has founded upon the existence of fits of easy reflection and easy transmission, exerted differently, according to the different thickness of the thin plates of which he supposes the parts of natural bodies to consist, will remain unsupported; for if the above mentioned fits have no existence, the whole foundation, on which the theory of the size of such parts is placed, will be taken away; and we shall consequently have to look out for a more firm basis, on which a similar edifice may be placed. That there is such a one we cannot doubt; and what I have already said will lead us to look for it in the modifying power, which the two surfaces, that have been proved to be essential to the formation of rings, exert upon the rays of light. The Second Part of this Paper, therefore, will enter into an examination of the various modifications, that light receives in its approach to, entrance into, or passage by, differently disposed surfaces or bodies; in order to discover, if possible, which of them may be the immediate cause of the coloured rings that are formed between glasses.

## VI.

*Description of a newly invented Calorimeter; with Experiments to prove, that an increased Capacity for Caloric accompanies an Increase of Temperature.* By JOSEPH READE, M. D.

SIR,

Edinburgh, Jan. 22, 1808.

I Beg leave to communicate, through the medium of your very interesting and scientific Journal, the invention of a calorimeter, free from those inaccuracies incident to the apparatus of Messrs. Lavoisier and Laplace, in which it was impossible to guard against errors arising from capillary attraction, from the process of freezing and thawing proceeding at the same period, and likewise from the influence of a current of atmospheric air. In this communication I will confine myself to a summary description of the apparatus, and of a discovery deduced from it, which must influence in a most important manner, if proved, the investigations of caloric; that, contrary to received opinion, water increases in capacity from the thermometric range of 32 to 212, in a just rate for every degree of temperature communicated.

Defects of the apparatus of Lavoisier and Laplace.

Capacity of water for caloric increases uniformly with its temperature.

*Description of the Calorimeter, which is to be formed of thin sheets of Brass or Tin.*

The innermost compartment No. 1, Pl. V, fig. 1, designed for the fluid to be subjected to experiment, is to be stopped with a thermometric cork, *a*, or, what is better, a thermometer surrounded with chamois leather, and made to fit accurately the aperture. The second compartment, No. 2, holds a quantity of water, and is likewise to be stopped by a thermometric cork, *b*, made air-tight by sealing wax, as this water is not to be removed from the compartment during the course of the experiments.

The calorimeter described.

The external compartment, 3, is designed to act as an imperfect conductor of caloric, and is to have a coating of

list

list or flannel between the sheets of brass, which, combined with the confined air, renders the instrument extremely accurate, a minute elapsing before the thermometer fell 1 degree at 150°. Therefore in experiments scarcely requiring that time, there can be no abstraction of any consequence by the atmosphere.

Method of finding the comparative specific heat of two fluids,

When we wish to estimate the specific caloric of two fluids, suppose oil and water, we bring the calorimeter to the precise temperature of 32°, 40°, 50°, or any other we desire, indicated by the two thermometers. We then fill the interior compartment, No. 1, with water at 212°, and immediately stop it with the thermometric cork, *a*. After agitating the apparatus for about the space of 1½ minute in a horizontal position, the thermometers indicate the rise experienced by the water at 50° in the second compartment, and the number of degrees lost by the water at 212° in the interior. Suppose the calorimeter be raised from 50° to 80°, we take that number as the specific caloric of water. We then pour the water from the interior compartment, and again reduce the temperature of the apparatus to 50°, which is speedily accomplished, by pouring cold water into the innermost compartment, until the thermometers are reduced to the desired point. We are next to fill the interior compartment with oil at 212°; and if, after agitation, on examining the two thermometers, we find the temperature raised, suppose to 60°, we easily find the specific caloric of oil compared with water. Thus taking water as the standard, in a short time all fluids may be examined. By substituting an iron cage, solids may be subjected to experiment; so likewise may fluids, which act chemically on metals, by enclosing them in a glass vessel.

Solids and corrosive fluids may likewise be examined.

The author engaged in a series of experiments.

I am at present engaged in a series of experiments, which I hope soon to be enabled to lay before the public. Here the reader is to take notice, that I have only used ideal numbers, more clearly to illustrate the mode of operating with the apparatus, and by no means indicative of the real specific caloric of oil and water. I will end this part of my communication by remarking, that in this instrument the inaccuracies arising from abstraction of caloric by the atmosphere and vessel are obviated, which was impossible by means

means of mixture; for in pouring the hot liquid into the interior chamber, the pipe of the kettle may enter it, so as entirely to prevent the abstraction of heat, and the vessel must act in a similar manner on both fluids.

Inaccuracies obviated by this apparatus.

It is one of the most important questions in chemistry, to determine, whether or not the capacities of fluids are permanent from  $32^{\circ}$  to  $212^{\circ}$ : or in other words, whether 10 degrees of caloric, added to water at  $32^{\circ}$ , will produce the same elevation of temperature, as 10 degrees thrown into the same quantity at  $200^{\circ}$ . Most chemists are of opinion, that water changes its capacity at two points only, in passing from the solid to the fluid, and from the fluid to the aeriform state; and consequently, that there is a permanency of capacity between the thermometric range of the freezing and boiling points. Drs. Crawford, Black, Irvine, de Luc, &c. thought they decidedly proved this to be the fact, by a number of experiments; for on mixing equal quantities of water at different temperatures, they found nearly a mean produced. "The air of the room," says Dr. Crawford, "being  $61.5^{\circ}$ , a quantity of water, weighing 13lbs.  $10\frac{1}{2}$ oz. was heated in a slight tinned iron vessel, that had a cover of the same metal closely adapted to it, a thermometer being inserted in the centre of the cover by means of a cork. When the water was raised to the desired temperature, it was gently agitated, that every part of it might be brought to the same heat. The thermometer immersed in it pointing precisely to  $120.6^{\circ}$ , an equal quantity of cold water at  $50.9^{\circ}$ , the parts of which were also brought by agitation to a common temperature, was mixed with the warm, by pouring it into the tinned vessel in which the latter was contained. When the mixture was reduced, by agitating it with a wooden rod to a mean heat, its temperature at the end of one minute was  $89.8^{\circ}$ . Allowing therefore  $.066^{\circ}$  for the heat lost in the first minute, we have  $89.866^{\circ}$  for the true temperature of the mixture. If the thermometer at the moment of immersion had indicated the exact arithmetical mean it would have stood at  $89.8.^*$ "

Whether the capacities of fluids be permanent from the freezing to the boiling point a problem to be solved.

The affirmative generally believed.

Dr. Crawford's experiment.

I will not here enter into the many difficulties and sources of inaccuracy attendant on this method by mixture, but

Remark.

\* Crawford on Animal Heat.

merely

merely observe, that when we consider the quantity of caloric unavoidably carried off, the coming so near an exact mean at the end of one minute is very surprising.

Dr. Crawford mistaken, and his data erroneous.

I will now endeavour to demonstrate by direct experiments, that an increase of capacity does invariably take place in a just ratio to the increase of temperature; and in the second place, that a mean, or an approximation to it, may result as well from a gradual increase of capacity, as from a permanency: consequently, that Dr. Crawford's experiments and mathematical propositions are founded on false data.

*Experiment which proves the progressive Increase of Capacity.*

Experiment to prove this.

The calorimeter being at the precise temperature of  $48^{\circ}$ , which was also that of the room, I filled the interior compartment, No. 1, with water from a boiling kettle at  $212^{\circ}$ , and having closed it as before represented with a thermometric cork, I agitated the apparatus well for about the space of  $1\frac{1}{4}$  minute, in a horizontal position, when the two thermometers indicated  $97^{\circ}$ . Therefore the water at  $212^{\circ}$  had lost  $115^{\circ}$ , which, being communicated to the water at  $48^{\circ}$  in the second compartment, had raised its temperature 49 degrees. Having taken down these numbers, I poured out the water from the interior compartment, and brought the calorimeter to the exact temperature of  $150^{\circ}$ , and again filled the interior compartment with water from the kettle at  $212^{\circ}$ ; when, after brisk agitation as before, I found the temperature to be  $166^{\circ}$ . Therefore in this experiment the water at  $212^{\circ}$  had lost 46 degrees, which, being communicated to the water in the second compartment at  $150^{\circ}$ , raised its temperature but 16 degrees; whereas if equal increments of caloric produced equal increments of temperature, or in other words if the capacity were permanent, it should have raised it  $19\frac{6}{115}$ , which is easily demonstrated by the following calculation.

If 115 degrees raise water 49 degrees, what should 46 raise it?—Answer,  $19\frac{6}{115}$ .

Here it is obvious, that the difference between 16 and  $19\frac{6}{115}$ , is the difference between the capacity of water at  $48^{\circ}$  and



and the same quantity of water at  $150^{\circ}$ , in the proportions used in the calorimeter. Or that upwards of 3 degrees became latent, according to Dr. Black; or, what is more simple and philosophical, went to supply the increased capacity.

Having performed this and a number of other experiments at different temperatures, with similar results; and also having repeated them before a most accurate and scientific experimenter, for whose opinions I have the highest respect; and having found them all to coincide, I may justly infer, *that capacities are not permanent from the freezing to the boiling point.*

The result confirmed by farther experiments.

I now proceed to show, that a mean, or an approximation to it, may be produced by a gradual increase of capacity.

Mean may be produced if the capacity increase regularly.

If I mix water at  $100^{\circ}$  with water at  $50^{\circ}$  in equal proportions, a mean of  $75^{\circ}$  may result. Here 25 degrees with a larger capacity are lost by the water at  $100^{\circ}$ , which go not only to supply the 25 degrees gained by the water at  $50^{\circ}$ , but also to fill up that increased capacity, which the water at  $50^{\circ}$  experienced, to bring its capacity from the freezing point up to an equality of  $75^{\circ}$ ; and we may easily conceive, that they may so nicely balance, as even to produce a mean. Dr. Crawford entirely forgot this increased capacity gained by the water at  $50^{\circ}$ . This may be more clearly demonstrated by two diagrams, the one representing Dr. Crawford's theory, the other mine.

Suppose  $a$  and  $g$  in the parallelogram, Pl. V, fig. 2, to represent the thermometric range,  $ab$  are equal to  $cd$ , and  $cd$  to  $ef$ , and  $ef$  to  $gh$ ; therefore, if these are equal to one another, and represent the capacities, the capacities are also equal. This may be all very true; but as similar effects may arise from different causes, I will endeavour to show, how a mean may be produced by a progressive increase of capacity.

Dr. Crawford's theory.

The proof defective.

Suppose  $ag$ , fig. 3, to represent the thermometric range from  $32^{\circ}$  to  $100^{\circ}$ ; No. 4 the capacity of  $100^{\circ}$ , No. 3 that of  $75^{\circ}$ , and No. 2 that of  $50^{\circ}$ , although  $ab$  is not equal to  $cd$ , nor  $cd$  to  $ef$ , but if we produce from  $gh$  to  $i$ ,  $gi$  is equal to  $cd$ , and if we produce  $gi$  to  $k$ ,  $gk$  is equal to  $ab$ . To demonstrate this in another point of view,

The author's theory.

if

if we add water at  $100^{\circ}$ , represented by space 4, to water at  $50^{\circ}$ , represented by space 2; 25 degrees taken from space 4 of large capacity, not only go to fill up space 3, representing  $75^{\circ}$ , but also to fill up space 1, the increased capacity gained by  $50^{\circ}$  in rising from the freezing point.

Although geometrical figures are no evidence of the truth of a chemical doctrine, and should be avoided unless tending to illustrate the subject, yet I thought it necessary to call them to my aid; the more especially as Dr. Crawford has dwelt on them at great length\*.

Other fluids obey a similar law.

From these experiments we may analogically infer, that similar laws regulate other fluids in a greater or less degree; and that neither the mercurial, nor any other thermometer, is a faithful index of the quantity of caloric. Thus if the capacity of water increase, it does not bespeak the quantity of caloric thrown in at different temperatures. But, as this is a most important investigation, I will defer the discussion of it to a more voluminous detail; for, should my experiments undergo the ordeal of critical investigation, and be established as facts, the thermometer must be regulated according to the increasing capacity of the fluid, before we can determine the exact quantity of caloric communicated, and there must also be some other method adopted for proving the regularity of mercurial expansion.

The apparatus lost more caloric at a low than at a high temperature.

I will conclude by remarking, that the apparatus abstracted more caloric in rising from  $48^{\circ}$  to  $97^{\circ}$ , than from  $150^{\circ}$  to  $166^{\circ}$ , and therefore, in that respect, there can be no source of fallacy.

Sir, I beg leave to remain,

Your very obedient servant,

JOSEPH READE, M. D.

Dimensions of the calorimeter used.

P. S. The calorimeter I used held in the interior compartment, No. 1, 6 oz. of water, and in the second  $10\frac{1}{2}$  oz. consequently, if equal quantities were used, the increase would be much more.

VII.

\* The simple statement of the argument is, that, if the capacities answering to any successive number of degrees of the thermometer be supposed to increase by the augmentation or addition of any constant quantity,

## VII.

*Experiments on the various Species of Cinchona: by Mr. VAUQUELIN.*

(Concluded from page 120.)

*Appearances exhibited on a more minute examination by the infusion and decoction of different species of cinchona, that precipitate neither infusion of tan nor tartarised antimony.*

Barks that precipitate neither tan nor emetic tartar.

**T**HESE sorts of bark impart to cold water a red colour, frequently a yellowish red, sometimes a brown red. Water thus loaded with the soluble part of these barks froths on agitation like wort. Its taste is bitter, and more or less astringent, this differing in the different sorts.

Macerated in water.

Left to stand in an open vessel, or in a close one if not full, it soon grows mouldy, and is covered with a greenish pellicle.

Some of them are perceptibly reddened by infusion of litmus, which announces the presence of a free acid.

Some of them acid.

Alcohol, mixed with these infusions in the proportion of two parts to one, precipitates a grayish substance, which grows black on desiccation. The fluid is left more clear, and of a purer red. This indicates the presence of mucous matter.

Precipitated by alcohol.

In those infusions which have an acid a small quantity of caustic alkali forms a red precipitate inclining to violet: but a large quantity of the reagent redissolves this precipitate, and renders the colour of the infusion more intense.

By alkali.

Subjected to evaporation they become higher coloured; and, after being thus boiled down, they let fall on cooling a very bitter brown substance, which dissolves readily in alcohol, particularly with the assistance of heat, and is precipitated from it by water, if the solution be sufficiently satu-

Evaporated, form a deposit on cooling.

quantity; the series of capacities will be in arithmetical progression, and the half sum of any two terms equidistant from the same middle (degree or) term will be equal; and the result might therefore be mistaken to indicate an equality of the capacities. N.

rated

rated. Water itself redissolves this substance, though it has been separated from it by evaporation; but it requires a larger quantity, than when it is accompanied with the other principles of cinchona, which seems to show, that these principles promote the solution in water.

This not rendered insoluble by oxygen.

If the infusions of bark be allowed to cool several times, before they are evaporated to dryness, at each cooling they let fall a matter similar to that just mentioned. It was formerly supposed, that this substance was rendered insoluble by combining with oxygen, but the effect appears rather to be owing to the insufficiency of the water.

In this the bitterness resides.

It is this sort of resinous matter, that gives to bark and its infusions their bitter taste: for if these sediments be separated as they form, and the infusion thus boiled down be afterward made up to its former quantity by the addition of water, it will no longer possess the same degree of bitterness. The whole of this matter however cannot thus be separated from water; for the other principles of the cinchona always retain a pretty large quantity in solution.

It is best precipitated by alcohol.

But if, after having proceeded as I have just mentioned, the infusions of cinchona reduced to the state of soft extract be treated with alcohol, the greater part of the *resiniform* matter will be separated; and nothing will remain but a brown viscous substance, that has scarcely any bitterness, is perfectly soluble in water, and does not precipitate from it on cooling.

Two different principles in bark,

These experiments teach us, that in the infusions of these species of cinchona there are at least two very distinct substances: one bitter and astringent, soluble in alcohol, and but little soluble in water; the other on the contrary wholly insoluble in alcohol, very soluble in water, and having a sweet and mucilaginous taste.

in which most of its virtue resides.

These substances being unquestionably those, which operate most efficaciously in the diseases in which cinchona is employed, I conceive it will not be superfluous to give an account of their properties somewhat more at large. I shall begin with that which is soluble in alcohol. 1. This substance, in the dry state, has a brown red colour, and a very bitter taste. 2. Cold water dissolves only one portion of it,

Properties of that which is soluble in alcohol.

another

another remaining in a flocculent form and of a reddish colour: but if the mixture be heated, this dissolves too, and the result is a clear liquor, of a very deep red, which grows turbid on cooling, but lets fall very little sediment.

What is remarkable in the manner in which this substance comports itself with water is, that, if we employ but a small quantity of this fluid, it dissolves entirely, and produces a clear liquor: if after this more water be added, it grows turbid; and again it becomes clear on the addition of a still greater quantity of this fluid.

It would seem from this, that there is some other substance present with it, which promotes its solution when concentrated, and loses this property by being diluted in water.

This is the matter, that renders the decoction or infusion of cinchona turbid, by separating as it cools; as it does the water in which it is macerated, if this be evaporated to a certain point. It is the same as has been called in pharmacy resin of bark: but its solution in water grows mouldy in a few days, and produces fungi, like a solution of gum; which proves it not to be a true resin, for it is well known, that resins never grow mouldy.

The aqueous solution of this substance, recently prepared, and in a somewhat concentrated state, produced the following effects with the different reagents I shall mention. 1. With ammonia it coagulated into a whitish, thick matter, which grew brown in the open air, and hardened considerably a little while after: but it softens by heat, and assumes the ductility and silky lustre of turpentine when kneaded between the hands.

2. It produced nearly the same appearances with the alkaline carbonates.

3. The common acids produced no sensible change in it. Oxigenized muriatic acid turned it yellow, without producing any precipitation; but if ammonia were then added, a light, flocculent, grayish white precipitate was formed.

4. The solution of animal gelatine does not precipitate it: yet the infusion of these species of cinchona precipitates the solution of animal glue; the principle that produces this effect therefore must be altered during the evaporation.

5. The

chaly beates, 5. The muriate of iron, or any other ferruginous salt, produces in it a deep green colour, and soon after a precipitate of the same tint.

emetic tartar, 6. The antimoniated tartrite of potash occasions no precipitation in it. This substance therefore is not the same as that, which in the infusions of certain species of cinchona precipitates this metallic salt.

and litmus. 7. Lastly it very perceptibly reddens infusion of litmus.

Scarcely soluble in water freed from acid; The acidity of this substance, and the precipitation occasioned by alkalis in its concentrated solution, led me to suspect, that its solubility was in part owing to the presence of the free acid that accompanies it: and this appeared to me to be confirmed by the circumstance, that, when once separated by an alkali, washed, and dried, it was no longer soluble in water but in an infinitely small proportion.

unless an acid be added to the water. To acquire a greater degree of certainty upon this subject, I put some into water acidulated with various acids; and I found in fact, that it dissolved in them readily, and that its solutions resumed a bitter taste, similar to that it had before it was precipitated by an alkali.

Seems to retain some of the alkali that threw it down. I remarked, that this substance, when precipitated, retained a part of the alkali employed to throw it down: at least the following experiment seemed to prove this. After its solution had been precipitated by ammonia, and washed in a large quantity of water, I mixed with it caustic potash, which immediately produced a very evident smell of ammonia; and this was not the case, before it had been precipitated by that alkali.

It is evident therefore, that this substance combines with a portion of the ammonia, which is employed to precipitate it from its solution; unless the acid, which naturally accompanies it, forms with this alkali an insoluble salt, that mixes with the resinous matter, a circumstance that appears not very probable.

Neutralizes both acids and alkalis. It seems from these properties, that this substance acts the part sometimes of an acid, at others of an alkali, since it combines with both these, and in part neutralizes their properties.

Soluble in excess of alkali. If, after having precipitated this matter by alkalis, an excess of

of

of these reagents be added, it is redissolved, and the solution has a brown red colour.

The solubility of this substance in alcohol is singularly increased by heat. When the menstruum is saturated with it, it has a red colour, and an extremely bitter taste. Water throws down from it a copious precipitate of a fine red slightly inclining to rose-colour. The alcoholic solution, exposed to the air in an open vessel, crystallizes in a needly form like a salt.

Heat greatly increases its solubility in alcohol.

The alcoholic solution precipitated by water still retains a portion of this substance, which continues to give it a rose-colour inclining to deep orange [*nacarat*], and a perceptibly bitter taste. It deposits this in scales of a brown red by spontaneous evaporation.

Tincture precipitated by water.

That principle of the cinchona, which is insoluble in alcohol, being dissolved in water, filtered, and left to spontaneous evaporation in a warm place, thickens like a kind of sirup, and crystallizes in laminæ, sometimes hexaedral, at others rhomboidal, at others square, and slightly tinged with a reddish brown. A portion of a thick fluid always remains, which never crystallizes completely, and which must be separated by decantation.

Principle insoluble in alcohol.

Yields a salt.

By repeated solution and crystallization this salt may be obtained white and pure. Of its properties I shall speak hereafter. As to the matter that does not crystallize, but remains in the form of a mother water, it exhibited all the characters of a mucilaginous matter, still retaining a small portion of the salt I have just mentioned, which it is impossible to separate from it entirely by crystallization.

Which may be purified.

The remainder mucilaginous.

*Action of acids on the residuums of cinchona exhausted by water.*

The barks in question, after being exhausted by water, and even by alcohol, still yield something to acids. They all act nearly in the same manner: that is to say, their effect is confined to simple solution, without occasioning any perceptible change in the nature of the principles of the cinchona.

Action of acids after water.

I must observe however, that, if the bark have been reduced to fine powder, and subjected to the repeated action of a large

Dissolve the part soluble in alcohol.

large quantity of alcohol assisted by heat; little is left to be done by the acids. The matter taken from the bark by acids is according to all appearance the same, as that which dissolves in alcohol, as I shall show farther on.

**Nitric acid.** Nitric acid acquires from it a red, inclining to rose-colour, and sometimes to a deep orange [*nacarat*]: but these tints vary greatly in their intensity according to the strength of the acid; the stronger this is, the more they incline to yellow. The nitric acid loses much of its acidity by this combination, at least as far as we can judge from the taste: it is true it dissolves at the same time a certain quantity of lime, which is detected by oxalate of ammonia, and this contributes to its neutralization.

**Action of carbonates on the solution:** If saturated carbonate of potash be poured into this nitric solution, a fine red precipitate is formed: but if the common carbonate be employed, and added in excess, the colour of the precipitate becomes violet, purple, or blue. Thus alkalis have the property of blueing that colour of these barks, which is naturally red.

**and of solutions of metals.** Metallic solutions likewise form in it precipitates of various colours, and more or less abundant, according as the nitric acid contains more or less vegetable matter: but, if the excess of acid be saturated, the metallic salts then produce in it very copious precipitates, and the liquor is deprived of colour.

1. Solution of muriate of tin produces in it a rose-coloured or carnation precipitate.

2. That of sulphate of iron, a grayish precipitate.

3. That of copper a chesnut brown.

4. Sulphate of titanium, assisted with a little carbonate of soda, formed with the nitric solution of cinchona an orange red precipitate, pretty analogous in colour to that produced by solutions of this metal with galls.

5. Alum occasioned no change in the acid solution of cinchona: but aided by a little alkali it carries down with it the colouring part, and the liquor is rendered colourless.

**Might be employed as a dye.** In the countries where these cinchonas grow, a very fine and permanent chesnut red for wool and cotton might be obtained from their bark. Soap turns it to a rose colour.

**Sulphuric and muriatic acids.** The sulphuric and muriatic acids, diluted with water, and poured



poured on the residuums of these cinchonas, dissolve the resiniform substance, and saturate themselves with it like the nitric acid. The colour they thus acquire inclines less to yellow than that of the nitric acid: it is always of a more decided red.

The precipitates formed in these solutions by alkaline carbonates are likewise of a purer red; and an excess of these alkaline salts gives the precipitate a more evident blue.

Action of carbonates on these solutions.

The residuums of the cinchonas appear to contain a large quantity of lime: at least a great deal of sulphate of lime is produced by spontaneous evaporation in the sulphuric acid in which they have been macerated.

Lime in the residuums.

From the action of acids on the resiniform matter of these species of cinchona, if it should at any future time be demonstrated, that this substance is the only febrifuge principle in them, it is evident, that the art of physic may derive from these barks much more advantage in the cure of intermittent and low fevers, by adding to them acids or wine. In fact, as has been seen above, water extracts from cinchona, particularly when it is merely bruised, but a very small quantity of resiniform matter, and even the greater part of this is precipitated by cooling. Now by this means it is certain, that from a large quantity of cinchona we extract but a very small part of the febrifuge principle\*; which too, being diffused through a large body of water, unquestionably cannot produce all the effect, of which it would be capable in a more concentrated state.

Remarks on the action of acids.

It has long been known, that the effect of the essential salt of cinchona in fever is by no means proportional to that of the quantity of bark from which it has been extracted: which proves, that something useful in the cure of this disease is left in the magma.

Its essential salt.

According to my way of thinking, the method hitherto pursued for preparing the essential salt of bark is the reverse of what it ought to be. When an infusion of cinchona is made,

Hitherto extracted by a bad process.

\* Mr. Vauquelin has forgotten his *if*, in the first sentence of this paragraph. It has not yet been proved, that this is the febrifuge principle: and indeed he himself had before ranked the principle soluble in water with it in this respect. Tr.

it is evaporated to a certain point, left to grow cool that it may deposit a sediment, this resiniform sediment is separated from the liquor, and the evaporation and refrigeration are repeated, till the liquor no longer becomes turbid, and has only a pale yellow colour. It is then dried on plates by the heat of a stove. By operating thus a very small quantity of resiniform matter only remains in the water, with a gum, and a salt with a calcareous basis, the efficacy of which in the cure of fever is very questionable.

*Comparative examination of the resin of these cinchonas with other known vegetable substances.*

Is the matter soluble in alcohol a resin? Is there in the vegetable kingdom any immediate principle, with which this can be classed? Is it to be placed among the resins, as has hitherto been done? It is true that chemists and apothecaries formerly arranged together so many substances under this genus, that, if we looked to some of its properties only, we might also rank this among them: but if we apply the name of resin only to those substances, which are absolutely entitled to it, those of cinchona and many other vegetables must be separated from the resins properly so called.

No: If the resiniform matter of these cinchonas resemble resins by its solubility in alcohol, it differs from them by its solubility in water, acids, and alkalis, and particularly by its property of precipitating metallic salts, and fixing in cloth. I believe then it may be considered as a peculiar vegetable principle, the properties of which have not hitherto been well understood by chemists. This principle is not the same in every species of cinchona: it differs in those that precipitate infusion of tan and tartarised antimony, and in those that precipitate isinglass only.

Perhaps similar to what gives bitterness. It is probably a principle extremely analogous to it, that most commonly imparts a bitter taste to vegetables.

*Recapitulation of the properties of cinchonas.*

General properties of barks. 1. The different species of bark may be divided into three classes with respect to their chemical properties.

In the first may be comprised those, that precipitate tannin, and do not precipitate animal glue. Three classes of them.

In the second, those that precipitate animal glue, and do not precipitate tannin.

In the third, those that precipitate both tannin and animal glue, and also tartarised antimony.

2. We may conjecture with sufficient probability, that every vegetable substance, which does not possess at least one of the properties above mentioned, will not be a febrifuge; and it is probable too, that the more these properties unite in a cinchona, or in any other substance, the more striking will be its febrifuge effects. Indication of febrifuge properties.

3. The property of precipitating tannin not being common to all the cinchonas, it is not from this exclusively, that they derive their febrifuge virtue; for there are several that do not precipitate it, and yet cure intermittent fevers.

4. It appears however, that the principle which precipitates infusion of oak bark and nutgalls is febrifuge, for the species that produce this effect are generally allowed to be the best for medicinal use.

5. On the other hand, since cinchonas which precipitate neither infusion of tan nor nutgalls are febrifuge, we must conclude, that the principle, by which these precipitations are produced, is not the only one in cinchona, that cures fever. These not confined to one principle.

6. The principle that precipitates infusion of tan and nutgalls has a brown colour, and a bitter taste; it is less soluble in water than in alcohol; it precipitates likewise tartarised antimony, but not isinglass. It has some analogy with resinous substances; though it affords ammonia by distillation. Principle that precipitates tan.

7. It is apparently with the tannin of oak bark and nutgalls, that this principle combines to form the precipitates it occasions in the infusions of these substances: yet, as this principle exists in some species of cinchona, that precipitate isinglass at the same time, it remains questionable, whether it actually combine with the tannin of the infusion of oak bark, or whether the principle, that in other species of cinchona precipitates isinglass, be real tannin. Doubts.

8. But one or the other of these suppositions must necessarily be true, since the infusions of these two sorts of cinchona mutually precipitate each other.

Principle that precipitates gellanine.

9. The principle, which in some species of cinchona precipitates isinglass, has a bitter and astringent taste: it is more soluble in water than that, which in other species precipitates infusion of tan: it is likewise soluble in alcohol: and it does not precipitate tartarised antimony.

10. It appears, that the substance which precipitates infusion of tan is the same, as that which decomposes antimoniated tartrate of potash.

Knowledge of the febrifuge principle a desideratum.

We see from all these doubts, that much remains yet to be done, before we shall attain an accurate knowledge of the principle or principles in cinchona, from which it derives its efficacy in the cure of fevers. It is to be hoped, that time and assiduity will accomplish the solution of this important question.

#### *Analysis of the salt of cinchona.*

Salt of cinchona.

Mr. Deschamps, jun., a druggist at Lyons, is the first to my knowledge, who announced the presence of a peculiar salt in cinchona, which must not be confounded with the essential salt of la Garaye, for this contains at the same time both resin and mucilage: but as Mr. Deschamps has described only some of the physical properties of this salt, I thought it necessary to analyse it, in order to discover the nature and proportions of its principles. I have already said how this salt may be obtained and purified: here therefore I shall confine myself to an account of its properties.

Its characters.

1. This salt is white; crystallizes in square laminæ, which are sometimes rhomboidal, or truncated at their solid angles; and these laminæ frequently unite in clusters.

2. It has scarcely any taste, and is flexible between the teeth.

3. It requires about five parts of water at 10° [50° F.] for its solution.

4. On burning coals it swells up like tartar, and emits a similar smell; and leaves a grayish substance, which dissolves in

in acids with effervescence, and is nothing but a mixture of carbonate of lime and charcoal.

5. Its solution does not alter the colour of litmus. In alcohol it is completely insoluble.

6. The fixed alkalis, whether caustic or carbonated, decompose it, and precipitate lime from it, either pure or in the state of carbonate.

7. It is not decomposed by ammonia; which proves, that its acid has a stronger affinity for lime.

8. Both sulphuric and oxalic acids form a precipitate in its solution, if it be in a tolerably concentrated state; the result being sulphate or oxalate of lime.

9. It produces no apparent alteration in solution of acetate of lead, or of nitrate of silver.

10. Concentrated sulphuric acid, poured on this salt reduced to powder, blackens it slightly; but it does not emit any of the pungent vapour evolved from acetates.

11. A remarkable circumstance is, that the infusion of tan, and of some species of cinchona, that of Santa Fe for instance, occasions a yellow flocculent precipitate in the solution of this salt.

The various phenomena produced by these experiments indicating, that this salt consisted of a vegetable acid and lime, in order to decompose it, and obtain the acid separate, I employed oxalic acid, which is well known to render lime most insoluble by combining with it. With this view I proceeded in the following manner.

I dissolved 100 parts of this salt in as much water as was requisite. Into this solution I poured a solution of oxalic acid, from a quantity of a known weight, at different times, till no precipitate was formed. About twenty-two parts were necessary, to precipitate the whole of the lime, yet I obtained but twenty-seven parts of dry precipitate.

This proves, that the oxalic acid employed retained about half its weight of water of crystallization; and that the salt of cinchona contained but a small quantity of lime, for in twenty-seven parts of oxalate of lime there are but fifteen of this earth at most.

After having thus separated the lime from this salt by means of oxalic acid, I allowed the supernatant liquor to evaporate

A compound of lime and some acid.

Analysis of it.

The acid crystallized suddenly on agitation.

evaporate spontaneously; and it was thus reduced to the state of a very thick sirup, without affording any sign of crystallization, after it had stood above a week. Having stirred it however with a piece of glass, in order to take out a portion which I intended for another experiment, I was surprised to find the fluid crystallized a few instants after into a hard mass, formed of a great quantity of laminae, diverging from several very distinct centres of crystallization.

It was slightly tinged of a brown colour: its taste was extremely acid and a little bitter, because the salt of cinchona I had employed had not been perfectly purified.

I shall now proceed to the properties I observed in this acid, on which however I cannot enlarge very minutely, as I had but a moderate quantity of the salt at my disposal. I believe however, that I have examined it sufficiently, to be convinced of its being a peculiar acid hitherto unknown.

Its properties.

In its state of crystallization it has a very acid taste, and is a little bitter\*, as I have said above.

It keeps perfectly well in the open air, being neither deliquescent nor efflorescent.

On burning

On burning coals it melts very quickly, boils, grows black, emits pungent white vapours, and leaves but a very light coaly residuum.

With the earths and alkalis it forms soluble and crystallizable salts.

It does not precipitate nitrate of silver, mercury, or lead, as most other vegetable acids do.

It is a new vegetable acid, differing from

There appears no doubt, that this acid is new to us; for, on reviewing the characters of all the other vegetable acids known, neither of them unites in it all the properties of this.

the oxalic,

In fact oxalic acid forms an insoluble salt with lime, and besides decomposes the compound formed of this earth and acid of cinchona.

citric, and tartarous,

The citric and tartarous acids form likewise insoluble salts with lime, and decompose acetate of lead.

malic,

The malic acid does not crystallize, and precipitates acetate of lead.

\* Mr. Vauquelin has just been ascribing this bitterness to the impurity of the salt he employed, consequently it is not a character of the acid. Tr.

The benzoic acid is but little soluble in cold water, and is volatilized without being decomposed.

The gallic acid too is but little soluble in cold water, and gallic, blackens solution of iron.

It is analogous to the acetous acid in the solubility of its acetous combinations; but the acetous acid does not crystallize, and is volatilized without alteration.

I say nothing of the camphoric, suberic, or succinic acids, and others, for they bear no analogy to it.

Let us then conclude, that this acid is really different from all those hitherto known, and give it the name of *kinic* acid, from the word *quinquina*, till, becoming more ultimately acquainted with its nature and combination, we can frame a better.

It is to this acid united with lime, according to the report of Mr. Deschamps, that the physicians of Lyons ascribe the febrifuge virtue of cinchona. They assert, that no intermittent fever can resist two doses of this salt of thirty-six grains each.

The kinic acid combined with lime said to be the febrifuge substance.

If this assertion were proved, we might pretty easily conceive how a drachm of this salt cures an intermittent fever, for this quantity is as much as can be obtained from at least five or six ounces of common gray bark.

I cannot directly contradict this result, announced by persons of credibility and well informed; yet I think I have sufficient reason, to entertain some doubts of its accuracy. In the first place, before it can deserve complete confidence, it must have been tried a great number of times, and with uniform success: for it too often happens, that effects are ascribed to medicines, which in fact are owing entirely to nature. In the art of physic, more than in any other branch of natural philosophy, causes are so complicated, that it is difficult to trace with certainty what belongs properly to each.

This questionable, for different reasons.

On the other hand physicians have learned by long experience, that the infusions and extract of bark prepared after the manner of la Garaye are far from producing equal effects in fever with the quantity of bark from which they are prepared, if this were administered in its natural state: yet these preparations contain the salt in question.

It is known too, that spirituous tinctures of bark, in which

in which the salt of Mr. Deschamps does not exist, since it is insoluble in such menstruums, cure intermittent fevers.

Besides, there are cinchonas, which contain but extremely small quantities of this salt, and vegetables in which none of it is found, that likewise cure fevers. It is not then without reason, as is obvious, that I express my doubts on this head: and if it have sometimes happened, that this salt has cured fever, we may suspect, that it had not been perfectly freed from the bitter principle, which it strongly retains.

Desirable that it should be tried.

It is desirable however, that this question should be resolved by experiment as soon as possible: for, if the results of experience be conformable to those of the physicians of Lyons, it would certainly be a very useful discovery for mankind.

### VIII.

*On the Quantity of Carbon in Carbonic Acid, and on the Nature of the Diamond.* By WILLIAM ALLEN, Esq. F. L. S. and WILLIAM HASLEDINE PEPYS, Esq. Communicated by HUMPHRY DAVY, Esq., Secretary R. S. M. R. I. A.\*

Quantity of carbon in carbonic acid not ascertained, and experiments on the diamond objectionable.

THE estimates of the quantity of real carbon in carbonic acid differing very widely, and the experiments of Guyton de Morveau upon the combustion of the diamond, detailed in the 31st volume of the *Annales de Chimie*, being liable to some objections, from the manner in which the operations were conducted; we determined to institute a set of experiments, in order, if possible, to settle the question.

Lavoisier, from the result of experiments apparently conducted with much accuracy, concluded, that every hundred parts by weight of carbonic acid consisted of 28 carbon and 72 oxygen. This was in a great degree confirmed by the

\* Philos. Trans. for 1807, Part II, p. 267.



very valuable researches of Smithson Tennant, Esq., on the nature of the diamond, an account of which is printed in the Transactions of this Society for the year 1797, and which were made previously to the experiments of Guyton; but notwithstanding this, the result of Guyton's experiment, which only allowed 17.88 per cent of carbon to carbonic acid, has been adopted in all the systems of chemistry to the present time.

In researches of this nature, the results are much influenced by slight variations in the quality of the gas; but having had repeated experience of the accuracy of the eudiometer described in No. XII, of this volume\*, we were enabled to proceed in this respect with great confidence.

Our object was, to consume certain known quantities of diamond and other carbonaceous substances in oxygen gas, and we at first determined to employ the sun's rays, by means of a powerful lens; but considering the uncertainty of a favourable opportunity in this country, and at the season in which our experiments were made, we resolved to employ the apparatus represented by the drawing.

Attempt to ascertain the facts.

#### *Description of the apparatus.*

This consisted of two mercurial gasometers, Pl. VI, fig. 1 and 2, each capable of containing from 70 to 80 cubic inches of gas. The internal cylinder C C is of cast iron, and solid, except the perforation through its middle; the external cylinder is also of cast iron; and the glass receiver slides up and down in the space between them, which is filled with mercury: not more than 16 pounds are required for each, and the small bath B, fig. 1.

Apparatus described.

To the top of each receiver a graduated scale or register, H, is screwed, showing the number of cubic inches of gas, measuring from the upper edge of the external iron cylinder. The level of the mercury is ascertained by a small glass gauge. The registers were graduated by throwing up one cubic inch of gas at a time.

The gasometers stand upon mahogany stools, perforated for a socket, to which, according to the nature of the expe-

\* See our last Number, page 86.

riment, a small receiver R, or the triple socket T S, or any other combination, may be united.

P represents the platina tube with its furnace; the ends of the tube are mounted with female screws of brass, to one of which the accommodating screw socket A S was joined.

T is a double section of the platina tray, which contained the substances to be heated. During their combustion, it was made to slide easily within the platina tube P. The accommodating socket and platina tray are drawn considerably larger in proportion than the instrument.

By means of the triple socket and the cocks, the gas was made to pass freely over the substances in combustion, from one gasometer to the other; and by shutting off the communication with the platina tube, while that with the small receiver was open, any portion of gas in the gasometer, fig. 1, might be transferred into eudiometers or measures standing in the mercury bath M, for examination.

In order to discover whether the several sockets were airtight, after the apparatus was put together, the communication with the gasometer, fig. 1, was closed, and the other communications opened; the receiver of the gasometer, fig. 2, being raised, drew up a column of mercury in the small receiver R, equal to 2 inches: the communication with the gasometer was then closed, and the column was supported without alteration. This was always tried previous to, and after every experiment. As the joints would bear this degree of exhaustion, we were confident they would resist a much greater pressure than we had any occasion to employ. The glass tubes G G, which connected the platina tube with the gasometers, enabled us to observe any flash arising from the combustion of hydrogen which might be contained in the substances subjected to experiment. In order to avoid prolixity, we shall generally state the method which was invariably followed.

Oxygen gas injured by keeping.

Manner in

We soon found that oxygen gas, even when secured in bottles with ground glass stoppers, was not always to be depended upon, but was sensibly deteriorated by keeping; and therefore in all our experiments we made the gas within an hour or two of the time of using it, and always from the hyperoxygenised muriate of potash. Its degree of purity was constantly

constantly ascertained by the eudiometer before every experiment, and was generally determined in about 10 minutes. The solution employed was that recommended by Professor Davy; namely, the solution of green sulphate of iron saturated with nitrous gas\*; and whenever the diminution had arrived at its maximum, and the gas began to increase in volume, we substituted a simple solution of the green sulphate of iron for that saturated with nitrous gas, and always had the most satisfactory results: for the simple sulphate absorbs any nitrous gas which may have escaped from the saturated solution, and the residuum in this case enables us to ascertain exactly the quantity of oxygen contained in the gas.

which its purity was ascertained.

We determined to make our first experiment with charcoal, and as Morozzo and Rouppe had ascertained the absorbing properties of this substance, and as our results must obviously be influenced by it, our attention was directed to this point. The following quantities of different kinds of wood, sawed into slips  $\frac{1}{8}$  of an inch were weighed.

Woods charcoal.

White Fir.....	300	grains	Their weight.
Lignum Vitæ ....	800		
Box .....	400		
Beech .....	500		
English Oak.....	250		
Mahogany .....	200		

These slips were put into small crucibles, and completely covered with dry sand. Heat was very gradually applied at first, until the volatile parts were dissipated; they were then kept about 40 minutes in a white heat. On being collected and weighed, while still warm, the charcoal from each was as follows:

In small crucibles under dry sand.

Fir .....	51.5	grs. equal to	18.17	per cent.	Weight of charcoal produced.
Lignum Vitæ	138	.....	17.25		
Box.....	81	.....	20.25		
Beech.....	75	.....	15		
Oak .....	43.5	.....	17.40		
Mahogany ..	31.5	.....	15.75		

\* This solution absorbs oxygen much more rapidly in warm weather than in cold.

These

Gain by a week's exposure to air.

These being exposed to the air during one week, increased in weight thus:

Fir .....	13	per cent.
Lignum Vitæ ..	9.6	
Box .....	14	
Beech .....	16.3	
Oak .....	16.5	
Mahogany .....	18	

This probably by absorption of water.

Certain quantities being *confined* in common air increased very little in weight, and all in the same proportion; we are therefore much inclined to think, that *this* increase is owing to an absorption of water from the air; and we repeatedly found, that the greatest increase of weight took place in the first hour or two after exposure, and arrived at its *maximum* in less than 24 hours, as the following experiment, selected from several others, will prove.

Experiment with willow charcoal.

Forty grains of charcoal from willow wood, which had been put into a bottle with a ground glass stopper *immediately* after they were removed from the fire, were exposed in the scale of a delicate balance, in a room where the thermometer was 62° Fahrenheit, barometer 30.26.

	Grains.	Total Increase.	Time.
6 o'clock P. M.	40		
½ past .....	40.7	+ .7	
7 .....	41.3	+ .6 = 1.3	1 hour.
½ past .....	41.6	+ .3 = 1.6	1½ hours.
8 .....	41.8	+ .2 = 1.8	2 hours.

The pieces were now spread out on paper after every weighing, to expose them more completely.

½ past 8 .....	42.5	+ .7 = 2.5	2½ hours.
9 .....	42.8	+ .3 = 2.8	3 hours.
½ past .....	43.1	+ .3 = 3.1	3½ hours.
10 .....	43.3	+ .2 = 3.3	4 hours.
½ past .....	43.4	+ .1 = 3.4	4½ hours.

Here it was left all night.

10 A. M. ....	45	+ 1.6 = 5	16 hours.
4 P. M. ....	45		

6 P. M.

	Grains,	Total increase.	Time.
6 P. M. ....	44·5 — ·5 =	4·5	24 hours.
9 .....	44·4 — ·1 =	4·4	27 hours.

Next day.

$\frac{1}{2}$ past 8 A. M.	44·9 + ·5 =	4·9	38 $\frac{1}{2}$ hours.
$\frac{1}{2}$ past 1 P. M.	44·7 — ·2 =	4·7	43 $\frac{1}{2}$ hours.
10 .....	44·5 — ·2 =	4·5	52 hours.

Hence charcoal seems to act as an hygrometer: its greatest increase was 5 grains on 40, or 12 $\frac{1}{2}$  per cent. And in order to ascertain to what the increase of weight was owing, we put 27·25 grains of charcoal, which had been thus exposed, into a small bottle and tube connected with a receiver standing in the mercury bath, the whole of the vessels being also filled with mercury, in order to exclude common air. Heat applied by an Argand's lamp produced gas equal to about *half the bulk of the charcoal*; but as soon as the temperature of the mercury rose to 214° Fahrenheit, elastic fluid streamed from every piece of charcoal, which *quickly condensed*, and 1 $\frac{1}{2}$  inch of the tube was occupied with water. This proved that our suspicion of the increase of weight being principally attributable to water, was well founded.

Seems to act as an hygrometer.

Water expelled from it.

The result of these, and other experiments, plainly pointed out the precautions which were necessary, in order to obtain an accurate result with charcoal; for if we had weighed 4 grains of the charcoal a few hours after it was made, we should only in fact have had 3·5 grains of real charcoal, and our calculations would have been erroneous. To avoid this source of error, we subjected our charcoal to a red heat *immediately* before using it, and also weighed it as speedily as possible; in fact, while it was still warm. It may be proper to state, that our weights were such as we could thoroughly depend upon.

Hence certain precautions necessary.

The volume of gas being so much influenced by temperature and pressure, these were noted during every experiment; and thermometer 60° Fahrenheit, barometer 30°, were assumed as the standard. Gay Lussac remarks, that from 32° to 212° Fahrenheit, dry air expands 0·00208, or  $\frac{1}{480}$  part of its bulk for every degree of the thermometer. Dalton makes it 0·00207, or  $\frac{1}{483}$  part; we therefore divided the

The volume of gas much influenced by temperature and pressure.

the whole quantity of gas by 480, and multiplied the quotient by the degrees of difference under 60°.

It being of great consequence in these experiments to know the *exact* weight of a given quantity of oxygen and carbonic acid gasses, we resolved to examine for ourselves, whether the statements already given were quite correct, and accordingly made carbonic acid over mercury from Carrara marble and diluted sulphuric acid, which, being tried with lime water in Pepys's eudiometer, was all absorbed in 3 minutes, except 1 part in 100. We used two charges of lime water, though one would have been sufficient.

A glass globe, being exhausted by an excellent airpump, was exactly balanced on a beam sensible to a minute portion of a grain: then being screwed upon one of the glass receivers of the mercurial gasometer previously filled with carbonic acid gas, 21 cubic inches entered. The globe was now increased in weight by 10·2 grains, In order to be certain, we repeated the experiment, with exactly the same results. The 21 cubic inches were to be brought to the mean temperature and pressure, as the thermometer stood at 44° Fahrenheit, the barometer 29·86.

21	480) 21·00 (0·043	60°
·68 add for temp.	16	44
21·68	0·688 add for temp.	16 diff.

Correction for pressure.

$$30 : 29·86 :: 21·68 : 21·58$$

The volume therefore at mean temperature and pressure would have been 21·58 cubic inches.

$$21·58 : 10·2 :: 100 : 47·26$$

Consequently 100 cubic inches of carbonic acid gas at mean temperature and pressure weigh 47·26 grains.

We next tried oxygen gas from the hyperoxygenised muriate of potash made over mercury, and which by the eudiometer left only a residuum of 2 parts in 100. The glass globe, exhausted as before, and weighed, was screwed on to the glass receiver of the mercurial gasometer containing oxygen, and 21 cubic inches entered, by which it increased

in weight 7.3 grains. This experiment was repeated with exactly the same result. The thermometer and barometer remaining the same, we take the volume as before corrected.

21.58 cubic inches.

21.58 : 7.3 :: 100 : 33.82

Then 100 cubic inches of oxygen gas at mean temperature and pressure weigh 33.82 grains. After these experiments, we examined Davy's researches on nitrous oxide, and had the satisfaction to find, that his estimate, both of carbonic acid and oxygen gasses, agreed almost exactly with ours.

The next point was to ascertain whether limewater would take the whole of the carbonic acid gas from a mixture with oxygen, or common air; we therefore mixed a known quantity of carbonic acid gas with a certain quantity of common air, and on trying it with our eudiometer and limewater, the whole of the carbonic acid gas was in a short time absorbed. We also found, that, though the solution of green sulphate saturated with nitrous gas would not take up the whole of the carbonic acid gas, yet the simple green sulphate, merely by its water of solution, absorbed it very readily.

100 cub. inches  
weigh 33.82  
grs.

Whole of car-  
bonic acid gas  
absorbed from  
common air by  
limewater

or green sul-  
phate of iron.

It may be proper to notice here, that though we repeatedly tried the oxygen procured from hyperoxygenised muriate of potash by the eudiometer and limewater, it never gave the least trace of carbonic acid.

Gas from hyp.  
mur. of potash  
contained no  
trace of carbo-  
nic acid.

#### *Experiment with Charcoal from Box-wood.*

The thermometer being at 42° Fahrenheit, barometer at 30.2, we kept some box-wood charcoal red hot for a considerable time under sand, and weighed 4 grains as expeditiously as possible; this, being put into the platina tray, was pushed to the middle of the platina tube; the oxygen (made from hyperoxygenised muriate of potash over mercury) was contained in gasometer No. 1; No. 2 was empty. Every thing being adjusted and found perfectly air-tight, the communication with the small receiver R was closed, and the common air contained in the tubes and sockets, amounting only to 2.84 cubic inches, was driven out by a pressure of oxygen from gasometer No. 1. When several cubic inches had

Experiment  
with box wood  
charcoal.

had passed into gasometer No. 2, the gas was let out by opening the cock at the top of its glass receiver, and pressing it down; the cock being then closed, the gasometer No. 2 was completely empty, and the whole of the gas from No. 1 was driven through the tubes into No. 2, and back again. The common air having been previously withdrawn from the small receiver R, we tried the purity of our oxygen by the eudiometer in the manner before described, and found a residuum of 3 parts in 100: we then disengaged as much gas as reduced the quantity to 47 cubic inches by the register or scale; to this must be added the contents of the tubes and sockets 2.84 cubic inches, making the total quantity of oxygen employed 49.84 cubic inches.

Correction for temperature.

49.84	430)49.84(0.103	60°
1.85 for temp.	18	42
51.69	1.854 add for temp.	18 diff.

Correction for pressure.

$$30 : 30.2 :: 51.69 : 52.03.$$

The volume, therefore, at mean pressure and temperature, would have been 52.03 cubic inches.

Burned in the platina tube with oxygen gas.

We now lighted a fire in the small black lead furnace under the platina tube, and, as soon as it became red hot, opened the cocks, and passed the gas from No. 1 to No. 2, when the charcoal entered into vivid combustion, and heated the platina tube white hot. The operation was repeated many times during 6 or 7 minutes, by pressing alternately upon the glasses of the gasometers. Not the least flash of light was observable in the glass connecting tubes G G, nor the smallest appearance of moisture. The furnace being removed, the tube was now cooled by the application of wet cloths; and when all was reduced to the temperature of the room, we pressed upon the glass of gasometer No. 2, so as to force all the gas into No. 1. The cock below being closed, we tried the tubes, &c. and found them perfectly air-tight. We next unscrewed the tube and took out the platina tray; but it only contained a light white ash, somewhat resembling the

No flash of light or appearance of moisture.



the shape of the pieces of charcoal, and weighing only .02 of a grain. On observing the register of No. 1, it indicated exactly the quantity of gas that we began with, so that although 3.98 grains of charcoal had been dissolved, the volume of gas was *unaltered* by it; a circumstance which had been remarked before by Lavoisier. The small receiver R was now nearly full of mercury; the communication with the gasometer being opened, the large glass receiver was gently pressed upon, until several cubic inches were forced through the receiver R, and tube K, in order to clear the latter of common air. This being done, on trying our gas with the eudiometer and limewater, 56 parts were absorbed out of 100. These of course were carbonic acid gas; the test for oxygen absorbed 41, and a residuum of 3 was left, which was exactly what we began with. This is a striking proof, that nothing but carbonic acid was produced in the experiment.

Left .02 gr. of white ashes.

The volume of gas unaltered.

Nothing produced but carbonic acid gas

$$100 : 56 :: 52.03 : 29.13.$$

Then 29.13 cubic inches of carbonic acid gas were produced.

$$100 : 47.26 :: 29.13 : 13.76.$$

These 29.13 cubic inches of carbonic acid gas would therefore weigh 13.76 grains.

The charcoal weighed 4 grains.

The residual white ash 0.02

Charcoal consumed . . . 3.98 grains.

Then if 13.76 grains, the weight of the carbonic acid produced, contain 3.98 of charcoal, 100 grains must contain 28.92.

$$13.76 : 3.98 :: 100 : 28.92.$$

Then, according to this experiment, 100 grains of carbonic acid gas contain 28.92 charcoal.

The gas before the experiment consisted of

Oxygen 50.47 cubic inches.

Azote . . . 1.56

52.03

After the experiment,

Carbonic acid 29.13 cubic inches.

Oxygen . . . . 21.34

Azote . . . . . 1.56

---

52.03

---

Now as the volume of gas was unaltered, it will be fair to consider the quantity of oxygen gas consumed as equal to the carbonic acid produced, or 29.13 cubic inches.

Then, if 100 cubic inches of oxygen weigh 33.82 grains, 29.13 cubic inches will weigh 9.85 grains.

100 : 33.82 :: 29.13 : 9.85.

The weight of oxygen consumed was therefore 9.85 grains.

Charcoal consumed . . . . . 3.98

Carbonic acid from this statement . . 13.83 grains.

Ditto by calculations on carb. acid gas 13.76

---

.07

---

13.83 : 3.98 :: 100 : 28.77.

Thus, calculating by the oxygen consumed, 100 grains of carbonic acid gas contain 28.77 charcoal.

#### First Experiment on Diamond.

Exp. 1. On diamond.

Thermometer 56° Fahrenheit, barometer 30.20.

Our oxygen was made as in the former experiment; it contained no carbonic acid; and, on being tried with the impregnated green sulphate, left a residuum of 3 parts in 100.

3.95 grs Brazil diamond burned as the charcoal.

Having selected nine of the clearest and most transparent Brazil diamonds, we found they weighed 3.95 grains. These were ranged in the platina tray, which was placed in the tube, and the whole apparatus, adjusted as before, was perfectly airtight. The quantity of oxygen was 49.84 cubic inches, as in the last experiment. The same precautions were used to secure accuracy in the results as in the former experiment; and it would only be an unnecessary intrusion on the time of the Society to repeat them. The platina tube was heated red hot, and kept so for ten minutes: during this time the gas was repeatedly

peatedly passed from one gasometer to the other; the tube did not become white hot, as in the experiment with charcoal, because in this case the combustion went on more slowly. When every thing was cooled to the temperature of the room, the gas was all passed into No. 1, by pressing down the receiver of No. 2, and the volume was precisely the same as when we began the experiment. On drawing out the tray, we observed that some of the diamonds were reduced to a minute speck, and all of them resembled opake white enamel: there was no discoloration in the tray, nor any residual ash whatever; the unconsumed parts weighed 1.46 grains; the original weight

The combustion less vivid.

Residuum an opake white enamel.

2.49 grs. consumed.

was 3.95  
1.46

consequently 2.49 grains were consumed.

We could not perceive any dullness on the surface of the mercury in the gasometers, or any appearance of moisture.

No moisture appeared.

On introducing limewater to 100 parts of the gas, in the eudiometer, a dense white precipitate was formed, and 36 parts absorbed; the test for oxygen absorbed 60, and a residuum of 4 was left.

Residual gas increased .01.

Correction for temperature.

60° 480) 49.84 (0.103 49.84  
56 4 .41 add for temp.

4 difference 4.12 50.25

Correction for pressure.

30 : 30.20 :: 50.25 : 50.58.

The quantity of oxygen at the mean was 50.58 cubic inches.

100 : 36 :: 50.58 : 18.20 cubic inches.

The quantity of carbonic acid gas produced was 18.20 cubic inches.

18.2 cub. inch. carbonic acid produced,

100 : 47.26 :: 18.20 :: 8.60 grains.

8.60 : 2.49 :: 100 : 28.95.

Then 100 grains of carbonic acid gas contain 28.95 of diamond.

containing .2895 by wt. of diamond.

100 : 83.82 : : 18.20 : 6.15 grains of oxygen consumed  
 2.49 grains of diamond.  

---

 8.64  
 Calculation by carbonic acid 8.60  

---

 .04 difference.

$$8.64 : 2.49 :: 100 : 28.81.$$

Thus, if we calculate upon the oxygen consumed, 100 grains of carbonic acid gas contain 28.81 of diamond.

*Second Experiment on Diamond.*

Exp. 2. Thermometer 48° Fahrenheit, barometer 30.08. Oxygen gas, made as usual, left a residuum of 3 parts in 100.

4.01 grs. of diamonds  
 Entirely consumed.

Eleven small diamonds, weighing 4.01 grains, were put into the tray. We began with 49.84 cubic inches of oxygen; and every thing being properly adjusted, kept the platina tube red-hot for a quarter of an hour, and during this time the gas was passed from one gasometer to the other, as in the former experiments. When the tubes, &c. were cooled down to the temperature of the room, all the gas was transferred to gasometer No. 1, and the volume was exactly the same as before the experiment. On examining the tray, all the diamonds were entirely consumed and not a vestige left.

Lime water absorbed 57.5 parts from 100  
 The test for oxygen 39.5  
 Residuum ..... 3

---

100

Correction for temperature.

60°	0.103	49.84
48	12	1.23
12 diff.	1.236 add for temp.	51.07

Correction for pressure.

$$30 : 30.08 :: 51.07 : 51.20.$$

The volume of gas at the mean was therefore 51.20 cubic inches.

$$100 : 57.50 :: 51.20 : 29.44.$$

Then 29.44 cubic inches of carbonic acid gas were produced. Produced  
29.44 cub. in.  
of carbonic acid  
gas

$$100 : 47.26 :: 29.44 : 13.91.$$

$$13.91 : 4.01 :: 100 : 28.82.$$

Then, according to this experiment, 100 grains of carbonic acid contain 28.82 diamond. containing  
.2882 of dia-  
mond,

Calculation by Oxygen.

$$100 : 33.82 :: 29.44 : 9.95 \text{ grains of oxygen consumed}$$

$$4.01 \text{ of diamond}$$

---

$$13.96$$

Calculation by carbonic acid 13.91

---

$$.05 \text{ diff.}$$

$$13.96 : 4.01 :: 100 : 28.72.$$

Then, calculating by the weight of oxygen employed, 100 grains of carbonic acid contain 28.72 diamond. or, from oxygen consumed  
.2872.

The precipitate in lime water from the gas produced in the combustion of diamond appeared to us denser than that from the combustion of charcoal. Appeared to  
occasion a denser  
precipitate  
in limewater,  
than that from  
charcoal.

In order to see how far the weight of the precipitate of carbonate of lime would agree with the results of the foregoing experiments, we drew off 20.5 cubic inches of the gas, which had been thus altered by the combustion of diamond in the last experiment, by the register H, and received it in bottles over mercury; then admitting lime water, we obtained a copious precipitate of carbonate of lime, which, being dried at the temperature of 212° Fahrenheit, weighed 12 grains.

But as the 20.5 cubic inches require the same corrections to bring them to the mean temperature and pressure; we say, as the actual volume of all the gas is to its correction, so is the quantity drawn off to that which it would have been at the mean:

$$49.84 : 51.20 :: 20.50 : 21.06, \text{ the volume after the corrections were made.}$$

They,

Then, to find how much carbonic acid was contained in these 21.06 cubic inches, we state it thus: As the total quantity of gas after the experiment is to the total weight of carbonic acid gas found by calculation, so is the quantity of gas experimented upon to the weight of carbonic acid gas which it ought to have contained,

$$51.20 : 13.91 :: 21.06 : 5.72 \text{ grains.}$$

Every 100 grains of precipitated carbonate of lime contain 44 grains of carbonic acid; 12 grains were procured in our experiment.  $100 : 44 :: 12 : 5.28$

The weight of the precipitate agreed nearly with the foregoing results. Therefore the carbonic acid contained in our precipitate of 12 grains weighed 5.28; by calculation it should have weighed 5.72; this is as near as we had a right to expect from the difficulty of collecting the precipitate.

### Stone Coal.

Experiment with Welch stone coal.

Upon the suggestion of our mutual friend Professor Davy, we next examined the results of the combustion of stone coal and plumbago; thermometer  $57^{\circ}$  Fahrenheit, barometer 29.65.

The stone coal from Wales, employed by maltsters, is well known to contain little or no maltha, or mineral pitch, and to burn without flame.

4 grs. charred and then burned.

A portion of this coal was placed under sand in a crucible, and exposed to a strong heat for one hour; 4 grains of it thus prepared were put into the tray: our oxygen left a residuum of 5 parts in 100, and we began with 49.84 cubic inches as usual. The tray being placed in the platina tube was heated to redness for about 10 minutes. When the gas was first passed, we thought we saw a flash in the glass tubes. On suffering the whole to cool, the quantity of gas still remained the same, and the tray being drawn out contained only .5 of a grain unconsumed. From the gas thus

$\frac{1}{2}$  gr. residuum, charged with 3.5 grains of coal,

Residual gas increased .03.

Lime water absorbed 53 parts from 100.

The tests for oxygen 39

Residuum . . . . . 8 or an increase of 3.

---

100

---

Correction

Correction for temperature.

60°	0·103	49·84
57	3	30
<hr/>		<hr/>

3 diff. 0·309 add for temp. 50·14

Correction for pressure,

30 : 29·65 :: 50·14 : 49·55.

The quantity of oxygen at the mean was therefore 49·55 cubic inches.

100 : 53 :: 49·55 : 26·26.

Consequently 26·26 cubic inches of carbonic acid gas were produced. 26·26 cubic inch carbonic acid gas produced,

100 : 47·26 :: 26·26 : 12·41 grains.

12·41 : 3·50 :: 100 : 28·20.

Then, according to this experiment, 100 grains of carbonic acid gas contain 28·20 of coal. containing 28·20 of coal,

Calculation by oxygen.

100 : 33·82 :: 26·26 : 8·88 grains of oxygen consumed.

3·50 coal

---

12·38

---

Calculation by carbonic acid 12·41

by oxygen 12·38

difference 

---

·03

---

Here, contrary to what happened in other experiments, the calculation by carbonic acid rather exceeds that by oxygen : or, from oxygen consumed; 28·27.

12·38 : 3·50 :: 100 : 28·27.

Calculating therefore by oxygen, 100 grains of carbonic acid contain 28·27 of coal.

*Experiment with Plumbago.*

Thermometer 44° Fahrenheit, barometer 29·94.

Exp. with plumbago. 4 grs.

Four grains of plumbago, from a very fine specimen being longing

longing to Dr. Babington, were put into the tray. Our oxygen left a residuum of 2 parts in 100, and we began with 49.84 cubic inches. The tray, with its contents, being placed in the platina tube, was heated to redness for a quarter of an hour, and the gas made to pass over it several times. When all was cool, the original quantity was neither increased nor diminished, and on withdrawing the tray we found only .2 of a grain of oxide of iron; so that this specimen of plumbago contains only 5 per cent oxide of iron.

left .2 gr. of oxide of iron.

The gas being now examined,

Lime water absorbed 55 parts from 100

The tests for oxygen 42

Residuum . . . . . 30 for an increase of 1 per cent.

Residual gas increased .01.

—  
100  
—

Correction for temperature.

60°	0.103		49.84
44°	16		1.64
	—		—
16 diff.	1.648	add for temp.	51.48
	—		—

Correction for pressure.

30 : 29.94 :: 51.48 : 51.37.

The quantity of oxygen at the mean would be 51.37 cubic inches.

100 : 55 :: 51.37 : 28.25.

28.25 cubic inches of carbonic acid gas produced, containing .2846 of carbon.

Therefore 28.25 cubic inches of carbonic acid gas were produced.

100 : 47.26, :: 28.25 : 13.35 grains.

13.35 : 3.8 :: 100 : 28.46.

Then, according to this experiment, 100 grains of carbonic acid contain 28.46 of the carbonaceous part of the plumbago.

Calculation by oxygen.

100 : 33.82 :: 28.25 : 9.55 grains of oxygen  
consumed 3.80 plumbago.

—  
13.35  
—

Calculation by carbonic acid 13.35



*First Experiment on animal Charcoal.*

Thermometer 60° Fahrenheit, barometer 30.23.

Muscular fibre distilled in a coated glass retort left a black shining coal, 4 grains of which were put into the tray. Our oxygen left a residuum of 2 parts in 100. The tray and its contents being placed in the platina tube, was heated to redness for 8 minutes. The first time the gas was passed, a lambent flame filled the whole length of the glass tube, and the gas became turbid or milky. It was passed frequently through the heated tube, but we observed no repetition of the flashes. Hence we conjecture that if the diamond had contained hydrogen, we should probably have had a similar appearance. After the experiment all the apparatus was, as usual, perfectly tight, and the volume of gas unaltered. On examining the platina tray a minute portion of charcoal remained, and a quantity of saline matter adhered to it so firmly, that it became difficult to ascertain the quantity of carbon consumed, and we forebore to make the calculation; we however examined the gas.

Exp. 1. On animal charcoal, 4 grains from muscular fibre.  
Lambent flame.  
Gas rendered turbid.

Saline matter left.

Lime water absorbed 40 parts from 100

The tests for oxygen 54

Residuum . . . . . 6 or an increase of 4 per ct.

Residual gas increased .04.

---

100

---

*Second Experiment on animal Charcoal.*

Thermometer 59° Fahrenheit, barometer 29.45.

Some of the animal charcoal of the last experiment was heated to redness under sand for one hour. Four grains were placed in the platina tray; and as we were so much embarrassed in the last experiment with the saline matter which adhered to the tray, we exactly balanced it with its contents. Our oxygen, made as usual, left a residuum of 2 parts in 100, and we began with 49.84 cubic inches. When every thing was adjusted, and the platina tube red hot, on passing the oxygen, flashes resembling lightning ran along the glass tube; and this was repeated 5 or 6 times. The whole of the gas became very cloudy, exhibiting a turbid milky

Exp. 2 On animal charcoal, 4 grs.

Flashes of light.

Gas turbid.

milky

milky appearance. The tube was rendered white hot by the combustion of the carbonaceous matter in oxygen. The fire was kept up about 8 minutes, and the gas passed several times. When all was cool, we could observe no alteration in the volume of gas by the register. The tray contained a mixture of salts; and being weighed, was lighter by 3·2 grains. This loss was not wholly carbon, for it is well known that animal substance contains a variety of salts, as phosphates, muriates, &c. some of which, though not volatile in a low red heat, might be decomposed and dissipated in the intense white heat produced by the combustion of the carbonaceous matter in oxygen; and we accordingly found the internal parts of the gasometers and tubes very slightly covered with a sort of efflorescence. On examining the gas after the experiment,

Residuum ·8  
grs.

Slight efflores-  
cence on the  
interior of the  
apparatus.

Lime water absorbed 41 parts from 100  
The tests for oxygen 55  
Residuum ..... 4 or an increase of 2.

Residual gas  
increased ·02.

100

Correction for temperature.

60°	49·84
59	·10 add for temp.
1 diff, or 0·103	49·94

Correction for pressure.

30 : 29·45 :: 49·94 : 49·02.

The quantity of oxygen at the mean would therefore be 49·02 cubic inches.

100 : 41 :: 49·02 : 20·09

Carbonic acid  
gas produced  
20·09 cub in.

The carbonic acid gas produced was therefore 20·09 cubic inches.

100 : 47·26 :: 20·09 : 9·49

and this carbonic acid weighed 9·49 grains.

Now the coal in the tray had lost 3·2 grains; but as the whole of this was not carbon, but part of it volatile saline matter,

matter, &c. we shall endeavour to estimate the carbon by the experiment on plumbago. When 13.35 grains of carbonic acid contained 3.80 grains of carbon,

$$13.35 : 3.80 :: 9.49 : 2.70.$$

The quantity of carbonic acid produced in this experiment, therefore, contained 2.70 grains of carbon. Containing 2.7  
grs of carbon.

Loss 3.20

Carbon 2.70

Leaves          .50 for volatile saline matter, &c.

So that, this being granted, the present experiment agrees with the foregoing. Matter volatilized .5 grs.

In two of our first experiments with box-wood charcoal, the calculations gave us in one case 29.75 parts of carbon in 100 of carbonic acid, and the other 30.68; but we were not then fully aware of the absorption of water by charcoal, which rendered the quantity of real carbon employed less than indicated by the weight. Also in another experiment, in which 4 grains of diamond were consumed, the calculation gave us 29.96 per cent of diamond in carbonic acid; but apprehending, that a slight degree of inaccuracy had crept into this experiment, we have not detailed it with the rest; but we have thought it right to give a simple statement of matters of fact; in no one instance have we endeavoured to strain or accommodate these to suit any particular theory, being fully aware, that every experiment, carefully made and faithfully recorded, will remain an immutable truth to the end of time, while hypotheses are constantly varying, and even the most beautiful theories are liable to change. In some experiments quantity of carbon apparently greater.

The experiments above related give us the following results.

	By carbonic acid.	By oxygen.	
Box-wood charcoal . . .	28.92	28.77	Table of results.
1st expt. diamond . . . .	28.95	28.81	
2d expt. diamond . . . .	28.82	28.72	
Stone coal . . . . .	28.20	28.27	
Plumbago . . . . .	28.46	28.46	
	5)143.35	5)143.03	
mean	28.67	28.60	

Hence,

100 grs. carbonic acid contain 28·6 of carbon.

Hence we conclude, that 100 grains of carbonic acid contain 28·60 of carbon, which does not greatly differ from the results of the experiments of Smithson Tennant, Esq. on the nature of diamond. See Phil. Trans. 1797.

Mr. Tennant's experiments

This gentleman made his experiment in the following manner. A quarter of an ounce of nitrate of potash was rendered somewhat alkaline by exposure to heat, in order that it might more readily absorb carbonic acid; it was then put into a gold tube with  $2\frac{1}{2}$  grains of diamond, and being subjected to heat, the diamond was converted into carbonic acid, by uniting with the oxygen contained in the nitric acid. The carbonic acid thus produced combined with the potash, and on pouring a solution of muriate of lime into a solution of this salt, he obtained a precipitate of carbonate of lime, this, being decomposed by muriatic acid, gave as much carbonic acid gas as occupied the space of 10·1 ounces of water. The thermometer was at 55° Fahrenheit, the barometer 29·80. In a second experiment he procured a larger quantity, or equal to 10·3 ounces of water.

gave 27 or 27·8.

If we therefore consider an ounce of water as consisting of 480 grains, and a cubic inch of water equal to 253 grains, and then make the proper corrections for temperature and pressure, one of his experiments will give about 27 per cent, the other about 27·80 for the carbon in carbonic acid, which is somewhat less than our estimate; but the difference may easily be accounted for, from the different methods employed.

Guyton's experiments not to be depended on.

The experiments of Guyton, as detailed in the *Annales de Chimie*, vol. XXXI, page 76, are liable to very strong objections; but at the same time the candid manner, in which he has related every circumstance, merits considerable praise. It is impossible, however, not to observe, that the quantity of gas before and after the experiment could not, from the construction of his apparatus, be very rigorously ascertained. We object also to nitrous gas as a test for oxygen; and as it is acknowledged, that the wooden support included in the oxygen gas took fire, the product of carbonic acid must have been influenced by it; so that, if no chance of error had existed in estimating the carbonic acid gas from the residuum after barytic water had absorbed a part, still the result would not have been satisfactory.

The

The experiments which we have had the honour of laying before this Society prove several important points: General conclusions.

1st. That the estimate given by Lavoisier, of 28 parts of carbon in every 100 parts of carbonic acid, is very nearly correct; the mean of our experiments makes it 28.60. Lavoisier's estimate nearly correct.

2dly. That the diamond is pure carbon; for had it contained any notable proportion of hidrogen, it must have been discovered, either by detonating with the oxigen, as in the case of animal charcoal, or by diminishing the quantity of oxigen gas. Diamond pure carbon.

3dly. That well burnt charcoal contains no sensible quantity of hidrogen; but if exposed to the air for a few hours it absorbs moisture, which renders the results uncertain. Fresh charcoal contains no hidrogen.

4thly. That charcoal can no longer be considered as an oxide of carbon, because, *when properly prepared*, it requires quite as much oxigen for its combustion as the diamond. This is also the case with stone coal and plumbago. Charcoal not oxide.

5thly. It appears that diamond and all carbonaceous substances (as far as our present methods of analysis are capable of demonstrating their nature) differ principally from each other in the state of aggregation of their particles. Berthollet has well remarked, that in proportion as this is stronger, decomposition is more difficult: and hence the variety of temperatures required for the combustion of different inflammable substances. Carbonaceous substances differ only in their aggregation.

## IX.

*Account of an extinct Volcano in Britain. Communicated by*  
Mr. DONOVAN.

MR. Donovan announces some particulars of an extraordinary nature to the scientific world respecting one of the Cambrian mountains; which, from the result of attentive observation, and indubitable evidence, he endeavours to demonstrate must have been at some remote period a volcano of Cader Idris formerly a volcano.

of

of immense magnitude. The mountain alluded to is Cader Idris, situate in the county of Merioneth, which in point of size is esteemed the most considerable in the principality of Wales, Snowdon alone excepted.

First noticed by Mr. Donovan seven years ago.

The remarkable appearance of this stupendous mountain attracted the attention of Mr. Donovan about seven years ago. He was then led to consider from a variety of circumstances, that the original form of the mountain must have undergone very material alteration, occasioned as he conceived by the powerful effects of the volcanic explosion; but his remarks were not sufficiently precise to authorise the assertion. Since that period he has examined the mountain in a less cursory manner, more especially in the summer of 1807, when he was at full leisure to devote some time to this interesting subject of inquiry, and his observations in the latter instance tend entirely to confirm the idea first suggested. In support of this opinion Mr. Donovan has now added to his museum abundant examples of different kinds of lava, pumice, and other volcanic matters of the most unequivocal character, collected by himself from the sides and base of the mountain; and also a suite of the remarkable and singularly formed columnar crystals of basalt, that are scattered in profusion about the loftiest summit, and cliffs surrounding the crater.

Proofs in volcanic productions collected there in 1807.

Appearance of the crater.

The general aspect of this crater is exactly that of mount Vesuvius, except that one of its sides is broken down, by which means the abyss of this funnel-shaped excavation is more completely disclosed than in the Vesuvian mountain; and it this side of Cader Idris which affords the most illustrative examples of porous stones, these forming immense beds on the declivities a few inches only in many instances below the surface of the earth. A number of these porous stones lately found in this spot by Mr. Donovan exhibit evident marks of strong ignition and vitrification, some are reduced to the state of slags, while others have all the cellular appearance and lightness of pumice.

The crater formed by an explosive power.

Without entering upon any discussion as to the relative merits of the neptunian and vulcanian theories, it must be admitted, that the agency of water might have contributed materially to affect those changes in the primitive form of the

Cader

Cader Idris mountain, which have evidently taken place. But with respect to the crater itself, this appears very clearly to have derived its origin from the violence of an explosion upwards, in which a very considerable portion of the highest eminence was torn from its native bed of rocks, and thrown to a considerable height over the other parts of the mountain. In confirmation of this suggestion it should be mentioned, that the summit of the mountain is covered with an immense wreck of the stones, ejected as it is presumed from the crater at the time of this explosion; it would be difficult otherwise to account for the vast profusion of those stones scattered in all directions about the loftiest elevations, and which, from the confused manner in which they are dispersed, must have been thrown into their present situation by no small violence. Myriads of these stones have borne a regular crystallized form, though from their great bulk and weight they have for the most part suffered material injury in the general convulsion. The usual length of these crystals is from three to six or ten feet in length: some measure even fifteen or twenty, and one in particular, which Mr. Donovan has seen, was twenty-two feet three inches long. They are however slender in proportion to the length.

Proofs of this,

Columnar stones from 3 to 22 feet long.

The substance of these crystals is of the basalt kind, and corresponds very nearly with some varieties of the "*lave porphyre*" of Etna described by Dolomieu, and Faujas de St. Fond; and in the form of its crystals agrees with others of the *basaltes prismatique* of the last author. In the neptunian theory it is not indeed admitted as a basalt, but as a porphyry argil. It is the *porphir-schiefer* of Werner, and porphyry slate, or clinkstone porphyry of Jamieson.

Basaltes.

The suite of these stupendous crystals, which Mr. Donovan collected from the summit of Cader Idris last summer, and has lately added to his museum, consists of a small triangular column about eighteen inches in length; a tetrahedral column of much superior size; an interesting portion of a pentagonal column, and another of the same figure about four feet in length, and having the termination of the crystal complete. The latter is estimated at about five hundred weight, but this is still exceeded by another of a somewhat compressed hexagonal figure with an oblique termination.

Specimens of it in Mr Donovan's museum.

The

The whole of these are very perfect, and extremely well defined.

*Lambeth, Feb. 22d, 1808.*

---

### SCIENTIFIC NEWS.

#### *New mode of preparing Calomel.*

THE object of this process, invented by Mr. Joseph Jewel, is to produce a calomel, that shall always be in the state of an impalpable powder. In the common mode this is effected by grinding, or trituration, which is liable to be negligently performed: and Mr. Jewel, to prevent all danger of this, endeavours to obtain it in a powder uniformly fine, by a particular manipulation in the last sublimation of the calomel, which he describes as follows.

I take calomel or mercurius dulcis, broken into small pieces, and put it into an earthen crucible of the form of a long bowl, so as to fill about one half thereof. I place the crucible on its side in a furnace provided with an opening, through which the mouth of the crucible projects about an inch. I then join to the mouth of the crucible an earthen ware receiver, having an opening at its side, to receive the open end of the crucible. This receiver is about half filled with water. I lute the joint with a mixture of sand and pipe clay. The receiver has a cover, which cover has a side continued upwards for containing water, with a chimney or tube in it, to allow the escape of steam from the water below. I then apply a fire around the crucible, sufficient to raise the calomel in vapours, and forced it through the mouth of the crucible into the receiver; where, by the water while cold, or assisted by the steam when it becomes hot, it is instantly condensed into an impalpable powder, possessing all the qualities of calomel in its most perfect state. The calomel, when thus prepared, is purer, whiter, and more attenuated, than that obtained by grinding. It is proper to wash the product over with water, before it is dried, to rid it of any coarser particles, which may form about the mouth of the crucible.



Wells, Allen & Phillips on Carburetted Steel & the Diamond?

Nicholson's Patent Journal, Vol. XXV, Pl. II, p. 240.

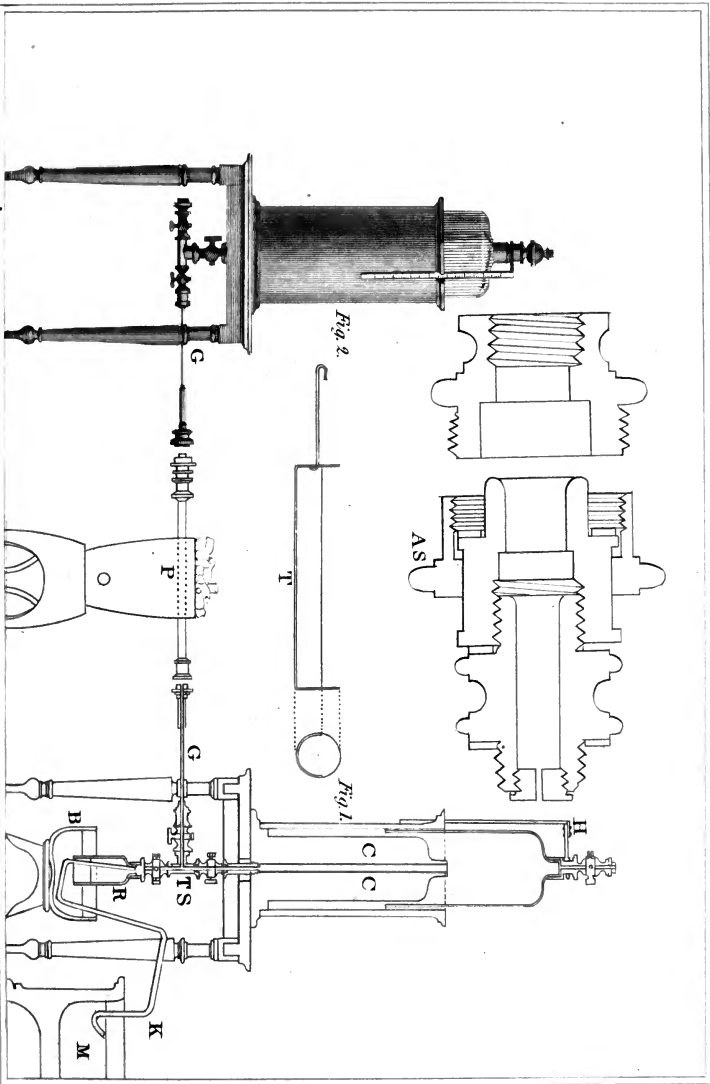



A  
JOURNAL  
OF  
NATURAL PHILOSOPHY, CHEMISTRY,  
AND  
THE ARTS.

---

---

APRIL, 1808.

---

---

ARTICLE I.

*On the formation of the Bark of Trees. In a Letter from T. A. KNIGHT, Esq. F. R. S. to the Right Honourable Sir JOSEPH BANKS, K. B. P. R. S. &c\*.*

MY DEAR SIR,

AN extraordinary diversity of opinion appears to have prevailed among naturalists, respecting the production and subsequent state of the bark of trees. Various opinions respecting the production of bark.

According to the theory of Malpighi, the cortical substance, which is annually generated, derives its origin from the older bark; and the interior part of this new substance is annually transmuted into alburnum or sap wood; whilst the exterior part, becoming dry and lifeless, forms the exterior covering or cortex.

The opinions of Grew do not appear to differ much from those of Malpighi; but he conceives the interior bark to consist of two distinct substances, one of which becomes albur-

\* Philos. Tras. for 1806, Part I, p. 103. Sir Godfrey Copley's gold medal for 1806 was adjudged to Mr. Knight for his various papers on vegetation printed in the Phil. Trans.

num, whilst the other remains in the state of bark: he, however, supposes the insertments in the wood, the "utriculi" of Malpighi, and the "tissu cellulaire" of du Hamel, to have originally existed in the bark.

Hales on the contrary contends, that the bark derives its existence from the alburnum, and that it does not undergo any subsequent transformation.

The discoveries of du Hamel have thrown much light on the subject; but his experiments do not afford any conclusive result, and some of them may be adduced in support of either of the preceding hypotheses: and a modern writer (Mirbel\*) has endeavoured to combine and reconcile, in some degree, the apparently discordant theories of Malpighi and Hales. He contends with Hales, that the alburnum gives existence to the new layer of bark; but that this bark subsequently changes into alburnum, though not precisely in the manner described by Malpighi.

So much difference of opinion, amongst men so capable of observing, sufficiently evinces the difficulty of the subject they endeavoured to investigate: and in a course of experiments, which has occupied more than twenty years, I have scarcely felt myself prepared, till the present time, even to give an opinion respecting the manner in which the cortical substance is generated in the ordinary course of its growth; or reproduced, when that, which previously existed, has been taken off.

Bark of some trees reproduced,

Du Hamel has shown, that the bark of some species of trees is readily reproduced, when the decorticated surface of the alburnum is secluded from the air; and I have repeated similar experiments on the apple, the sycamore, and other trees, with the same result; I have also often observed a similar reproduction of bark on the surface of the alburnum of the *wych elm* (*ulmus montana*) in *shady situations*, when no covering whatever was applied. A glareous fluid, as du Hamel has stated, exudes from the surface of the alburnum: this fluid appears to change into a pulpous unorganized mass, which subsequently becomes organized and cellular; and the

apparently from the alburnum.

\* *Traité d'Anatomie et de Physiologie végétale.*

matter, which enters into the composition of this cellular substance, is evidently derived from the alburnum.

These facts are therefore extremely favourable to the theory of Hales; but other facts may be adduced, which are scarcely consistent with that theory.

The internal surface of pieces of bark, when detached from contact with the alburnum, provided they remain united to the tree at their upper ends, much more readily generate a new bark, than the alburnum does under similar circumstances: a similar fluid exudes from the surfaces of both, and the same phenomena are observable in both cases. The cellular substance, however, which is thus generated, though it presents every external appearance of a perfect bark, is internally very imperfectly organized; and the vessels which contain the true sap in the bark are still wanting; and I have found, that these may be made, by appropriate management, to traverse the new cellular substance in almost any direction. When I cut off all communication above, and on one side, between the old bark and that substance, I observed, that the vessels proceeded across it, from the old bark on the other side, taking always in a greater or less degree an inclination downwards; and when the cellular substance remained united to the bark at its upper end only, the vessels descended nearly perpendicularly down it; but they did not readily ascend into it, *when it was connected with the bark at its lower extremity only*; the result of similar experiments, when made on different species of trees, was, however, subject to some variations.

Pieces of bark of the walnut-tree, which were two inches broad, and four long, having been detached from contact with the alburnum, except at their upper ends, and covered with a plaster composed of bees-wax and turpentine, in some instances, and with clay only in others, readily generated the cellular substance of a new bark; and between that and the old detached bark, very nearly as much alburnum was deposited as in other parts of the tree, where the bark retained its natural position: which, I think, affords very decisive evidence of the descent of the sap through the bark. Similar pieces of bark, under the same mode of treatment,

Internal surface of the bark itself generates it more readily.

Course of the new vessels variable.

Experiment on the walnut.

The sap descends through the bark.

but united to the tree at their lower ends only, did not long remain alive, except at their lower extremities; and there a very little alburnum only was generated. Other pieces of bark of the same dimensions, which were laterally united to the tree, continued alive almost to their extremities: and a considerable portion of alburnum was generated, particularly near their lower edges; the sap appearing in its passage across the bark to have been given a considerable inclination downwards: probably owing to an arrangement in the organization of the bark, that I have noticed in a former memoir\*, which renders it better calculated to transmit the sap towards the roots than in any other direction.

Bark reproduced from the alburnum of the sycamore and apple.

I have in very few instances been able to make the walnut-tree reproduce its bark from the alburnum, though under the same management I rarely failed to succeed with the sycamore and apple tree. Pieces of the bark of the apple-tree will also live, and generate a small portion of alburnum, though only attached to the tree at their lower extremities; probably owing to a small part of the true sap being carried upwards by capillary attraction, when the proper action of the cortical vessels is necessarily suspended.

The preceding experiments, and the authority of du Hamel, having perfectly satisfied me, that both the alburnum and the bark of trees are capable of generating a new bark, or at least of transmitting a fluid capable of generating a cellular substance, to which the bark in its more perfectly organized state owes its existence, my attention was directed to discover the sources from which this fluid is derived.

Both bark and alburnum consist of tubes and cellular substance.

Both the bark and the alburnum of trees are composed principally of two substances; one of which consists of long tubes, and the other is cellular; and the cellular substance of the bark is in contact with the similar substance in the alburnum, and through these I have long suspected the true sap to pass from the vessels of the bark to those of the alburnum†. The intricate mixture of the cellular and vascular substances long baffled my endeavours to discover from which

\* Philosophical Transactions of 1804, or Philosophical Journal, vol. X, p. 289.

† Phil. Trans. 1805, p. 14, or Philos. Journal, vol. XIII, p. 352.

of them, in the preceding cases, the sap, and consequently the new bark, proceeded; but I was ultimately successful.

The cellular substance, both in the alburnum and bark of old pollard oaks, often exists in masses of near a line in width, and this organization was peculiarly favourable to my purpose. I therefore repeated on the trunks of trees of this kind experiments similar to those above mentioned, which were made on the walnut-tree.

Experiments  
on pollard  
oaks.

Apparently owing to the small quantity of sap, which the old pollard trees contained, their bark was very imperfectly reproduced; but I observed a fluid to ouze from the cellular substance, both of the bark and alburnum; and on the surface of these substances alone, in many instances, the new bark was reproduced in small detached pieces.

I have endeavoured to prove in former communications\*, that the true sap of trees acquires those properties which distinguish it from the fluid recently absorbed, by circulating through the leaf; and that it descends down the bark, where part of it is employed in generating the new substances annually added to the tree; and that the remainder, not thus expended, passes into the alburnum, and there joins the ascending current of sap. The cellular substance, both of the bark and alburnum, has been proved, in the preceding experiments, to be capable of affording the sap a passage through it; and therefore it appears not very improbable, that it executes an office similar to that of the anastomosing vessels of the animal economy, when the cellular surfaces of the bark and alburnum are in contact with each other; and, when detached, it may be inferred, that the passing fluid will exude from both surfaces: because almost all the vessels of trees appear to be capable of an inverted action in giving motion to the fluids which they carry.

Absorbed fluid  
converted into  
sap by circula-  
tion in the leaf,  
and then de-  
scends down  
the bark, to  
form new sub-  
stance.

As the power of generating a new bark appeared in the preceding cases to exist alike in the sap of the bark and of the alburnum, I was anxious to discover how far the fluid, which ascends through the central vessels of the succulent annual shoot, is endued with similar powers. Having there-

Sap ascending  
in annual  
shoots can ge-  
nerate new  
bark.

\* Phil. Trans. 1801, 1805, and 1806.

fore made two circular incisions through the bark, round the stems of several annual shoots of the vine, as early in the summer as the alburnum within them had acquired sufficient maturity to perform its office of carrying up the sap, I took off the bark between these incisions; and I abraded the surface of the alburnum to prevent a reproduction of it. The alburnum in the decorticated spaces soon became externally dry and lifeless; and several incisions were then made longitudinally through it. The incisions commenced a little above, and extended below the decorticated spaces, so that, if the sap of the central vessels generated a cellular substance (as I concluded it would), that substance might come into contact and form a union with the substance of the same kind emitted by the bark above and below.

The experiment succeeded perfectly, and the cellular substances generated by the central vessels, and the bark, soon united, and a perfect vascular bark was subsequently formed beneath the alburnum, and appeared perfectly to execute the office of that which had been taken off; the medulla appeared to be wholly inactive.

Cortical vessels from regenerated buds spread in various directions.

I have already observed, that the vessels, which were generated in the cellular substance on the surface of the alburnum of the sycamore and the apple-tree, traversed that substance in almost every direction; and the same thing appears to occur beneath the old bark, when united to the alburnum. For having attentively examined, through every part of the spring and summer, the formation of the internal bark, and alburnous layer beneath it, round the bases of regenerated buds, which I had made to spring from smooth spaces on the roots and stems of trees, I found every appearance perfectly consistent with the preceding observations. A single shoot only was suffered to spring from each root and stem, and from the base of this, in every instance, the cortical vessels dispersed themselves in different directions. Some descended perpendicularly downwards, whilst others diverged on each side, round the alburnum, with more or less inclination downwards, and met on the opposite side of it. The same pulposus and cellular substance appeared to cover the surfaces of the bark and alburnum, when in contact with each



each other, as when detached; and through this substance the ramifications of the vessels of the new bark extended themselves, appearing to receive their direction from the fluid sap, which descended from the bark of the young shoots, and not to be, in any degree, influenced in their course by the direction taken by the cortical and alburnous vessels of the preceding year.

Whenever the vessels of the bark, which proceeded from different points, met each other, an interwoven texture was produced, and the alburnum beneath acquired a similar organization; and the same thing occurs, and is productive of very important effects, in the ordinary course of the growth of trees. The bark of the principal stem, and of every lateral branch, contains very numerous vessels, which are charged with the descending true sap; and at the juncture of the lateral branch with the stem, these vessels meet each other. A kind of pedestal of alburnum, the texture of which is much interwoven, is in consequence formed round the base of the lateral branch; which thus becomes firmly united to the tree. This pedestal, though apparently a part of the branch, derives a large portion of the matter, annually added to it, from the cortical vessels of the principal stem; and thence, in the event of the death of the lateral branch, it always continues to live. But it not unfrequently happens, that a lateral branch forms a very acute angle with the principal stem, and, in this case, the bark between them becomes compressed and inactive; no pedestal is in consequence formed, and the attachment of such a branch to the stem becomes extremely feeble and insecure\*. Instead of

Cortical vessels meeting form an interwoven texture.

Junction of lateral branches.

Weak when forming a very acute angle.

\* The advantages, which may be obtained by pruning timber trees judiciously, appear to be very little known. I have endeavoured to ascertain the practicability of giving to trees such forms as will render their timber more advantageously convertible to naval or other purposes. The success of the experiments, on small trees, has been complete, and the results perfectly consistent, in every case, with the theory I have endeavoured to support in former memoirs; and I am confident, that by appropriate management, the trunks and branches of growing trees may be moulded into the various forms best adapted to the use of the ship-builder; and that the growth of the trees may at the same time be rendered considerably more rapid, without any expense or temporary loss to the proprietor.

Advantages of properly pruning and training timber trees.

the reproduced buds of the preceding experiment, buds were inserted in the foregoing summer, or attached by grafting in the spring; and, when these succeeded, though they were in many instances taken from trees of different species, and even of different genera, no sensible difference existed in the vessels, which appeared to diverge into the bark of the stock, from these buds and from those reproduced in the preceding experiments.

**Theory.**

It appears, therefore, probable, that a pulposus organizable mass first derives its matter either from the bark, or the alburnum; and that this matter subsequently forms the new layer of bark; for, if the vessels had proceeded, as radicles\*, from the inserted buds or grafts, such vessels would have been in some degree different from the natural vessels of the bark of the stocks; and it does not appear probable, even without referring to the preceding facts, that vessels should be extended, in a few days, by parts successively added to their extremities, from the leaves to the extremities of the roots; which are, in many instances, more than two hundred feet distant from each other. I am, therefore, inclined to believe, that, as the preceding facts seem to indicate, the matter, which composes the new bark, acquires an organization calculated to transmit the true sap towards the roots, as that fluid progressively descends from the leaves in the spring; but whether the matter, which enters into the composition of the new bark, be derived from the bark or the alburnum, in the ordinary course of the growth of the tree, it will be extremely difficult to ascertain.

**Bark sometimes exists previous to the alburnum.**

It is, however, no difficult task to prove, that the bark does not, in all cases, spring from the alburnum; for many cases may be adduced, in which it is always generated previously to the existence of the alburnum beneath it; but none, I believe in which the external surface of the alburnum exists previously to the bark in contact with it, except when the cortical substance has been taken off, as in the preceding experiments. In the radicle of germinating seeds, the cortical vessels elongate, and new portions of bark are succes-

\* Darwin's Phytologia.

sively added to their points, many days before any alburnous substance is generated in them; and in the succulent annual shoot the formation of the bark long precedes that of the alburnum. In the radicle the sap appears also evidently to descend\* through the cortical vessels†, and in the succulent annual shoot it as evidently passes up through the central vessels†, which surround the medulla. In both cases a cellular substance, similar to that which was generated in the preceding experiments, is first formed, and this cellular substance in the same manner subsequently becomes vascular; whence it appears, that the true sap, or blood of the plant, produces similar effects, and passes through similar stages of organization, when it flows from different sources, and that the power of generating a new bark, properly speaking, belongs neither to the bark nor alburnum, but to a fluid, which pervades alike the vessels of both.

I shall, therefore, not attempt to decide on the merits of the theory of Malpighi, or of Hales, respecting the reproduction of the interior bark; but I cannot by any means admit the hypothesis of Malpighi and other naturalists, relative to the trasmutation of bark into alburnum; and I propose to state my reasons for rejecting that hypothesis, in the next communication I have the honour to address to you.

Bark not transmuted into alburnum.

I am, my dear Sir,

Your most obliged obedient Servant,

Elton, Dec. 18, 1806.

T. A. KNIGHT.

\* Phil. Trans. 1805 and 1806, or Philos. Journal, vol. XIII and XVI.

† I wish it to be understood, that I exclude in these remarks, and in those contained in my former Memoirs, all trees of the palm kind, with the organization of which I am almost wholly unacquainted.

† Phil. Trans. 1805. Mirbel has called the tubes, which I call the central vessels, the "tissu tubulaire" of the medulla.

II.

## II.

*On the Economy of Bees. In a Letter from THOMAS ANDREW KNIGHT, Esq. F.R.S. to the Right Honourable Sir JOSEPH BANKS, Bart. K.B. P.R.S.\**

MY DEAR SIR,

**I**N the prosecution of those experiments on trees, accounts of which you have so often done me the honour to present to the Royal Society, my residence has necessarily been almost wholly confined to the same spot; and I have thence been induced to pay considerable attention to the economy of bees, amongst other objects; and as some interesting circumstances in the habit of these singular insects appear to have come under my observation, and to have escaped the notice of former writers, I take the liberty to communicate my observations to you.

Friendly intercourse takes place between bees of different swarms.

It is, I believe, generally supposed, that each hive, or swarm, of these insects remains at all times wholly unconnected with other colonies in the vicinity; and that the bee never distinguishes a stranger from an enemy. The circumstances which I shall proceed to state will, however, tend to prove, that these opinions are not well founded, and that a friendly intercourse not unfrequently takes place between different colonies, and is productive of very important consequences in their political economy.

Evening visits between two hives.

Passing through one of my orchards rather late in the evening in the month of August, in the year 1801, I observed, that several bees passed me in a direct line from the hives in my own garden to those in the garden of a cottager, which was about a hundred yards distant from it. As it was considerably later in the evening than the time when bees usually cease to labour, I concluded, that something more than ordinary was going forward. Going first to my own garden, and then to that of the cottager, I found a very considerable degree of bustle and agitation to prevail in one hive in each: every bee, as it arrived, seemed to be stopped

\* Philos. Trans. for 1807, Part II, p. 234.

and questioned, at the mouth of each hive; but I could not discover any thing like actual resistance, or hostility, to take place; though I was much inclined to believe the intercourse between the hives to be hostile and predatory. The same kind of intercourse continued, in a greater or less degree; during eight succeeding days, and though I watched them very closely, nothing occurred to induce me to suppose, that their intercourse was not of an amicable kind. On the tenth morning, however, their friendship ended, as sudden and violent friendships often do, in a quarrel; and they fought most furiously; and after this there was no more visiting.

Ended in a quarrel.

Two years subsequent to this period I observed the same kind of intercourse to take place between two hives of my own bees, which were situate about two hundred yards distant from each other: they passed from each hive to the other just as they did in the preceding instance, and a similar degree of agitation was observable. In this instance, however, their friendship appeared to be of much shorter duration, for they fought most desperately on the fifth day; and then, as in the last mentioned case, all further visiting ceased.

Similar intercourse between two other hives.

Quarrelled on the fifth day.

I have some reason to believe, that the kind of intercourse I have described, which I have often seen, and which is by no means uncommon, not unfrequently ends in a junction of the two swarms; for one instance came under my observation, many years ago, in which the labouring bees, under circumstances perfectly similar to those I have described, wholly disappeared, leaving the drones in peaceable possession of the hive, but without any thing to live upon. I have also reasons for believing, that whenever a junction of two swarms, with their property, is agreed upon, that which proposes to remove, immediately, or soon afterward, unites with the other swarm, and returns to the deserted hive during the day only to carry off the honey: for having examined at night a hive from which I suspected the bees to be migrating, I found it without a single inhabitant. I was led to make the examination by information I had received from a very accurate observer, that all the bees would then be absent. A very considerable quantity of honey was in this instance

Sometimes two swarms form a junction.

stance

stance left in the hive without any guards to defend it; but I conclude, that the bees would have returned for it, had it remained till the next day. Whenever the bees quit their habitation in this way, I have always observed some fighting to take place; but I conceived it to be between the bees of the adjoining hives, and those which were removing; the former being attracted by the scent of the honey, which the latter were carrying off.

Bees settling in hollow trees, appear to send out scouts to examine them, after an individual has informed them of a proper place.

On the farm which I occupy, there were formerly many old decayed trees, the cavities of which were frequently occupied by swarms of bees; and when these were destroyed, a board was generally fitted to the aperture, which had been made to extract the honey; and the cavity was thus prepared for the reception of another swarm, in the succeeding season. Whenever a swarm came, I constantly observed, that about fourteen days previous to their arrival, a small number of bees, varying from twenty to fifty, were every day employed in examining, and apparently in keeping possession of the cavity; for if molested, they showed evident signs of displeasure, though they never employed their stings in defending their proposed habitation. Their examination was not confined to the cavity, but extended to the external parts of the tree above; and every dead knot particularly arrested their attention, as if they had been apprehensive of being injured by moisture, which this might admit into the cavity below; and they apparently did not leave any part of the bark near the cavity unexamined. A part of the colony, which purposed to emigrate, appeared in this case to have been delegated to search for a proper habitation; and the individual who succeeded must have apparently had some means of conveying information of his success to others; for it cannot be supposed, that fifty bees should each accidentally meet at, and fix upon, the same cavity, at a mile distant from their hive, which I have frequently observed them to do, in a wood where several trees were adapted for their reception; and indeed I observed, that they almost uniformly selected that cavity, which I thought best adapted to their use.

It not unfrequently happened, that swarms of my own bees took possession of these cavities, and such swarms were  
in

in several instances followed from my garden to the trees: and they were observed to deviate very little from the direct line between the one point and the other; which seems to indicate, that those bees, which had formerly acted as purveyors, now became guides.

Two instances came under my own observation, in which a swarm was received into a cavity, of which another swarm had previous possession. In the first instance I arrived with the swarm, and I could not discover, that the least opposition was made to their entrance: in the second instance, observing the direction that the swarm took, I used all the expedition I could to arrive first at the tree, to which I supposed they were going, whilst a servant followed them; and a descent of ground being in my favour, and the wind against them, I succeeded in arriving at the tree some seconds before them; and I am perfectly confident, that not the least resistance was opposed to their entrance.

Swarms admitted amicably into hollows already occupied.

Now it does not appear probable, that animals so much attached to their property as bees are, so jealous of all approach towards it, and so ready to sacrifice their lives in defence of it, should suffer a colony of strangers, with whose intentions they were unacquainted, to take possession, without making some effort to defend it: nor does it seem much more probable, that the same animals, which spent so much time in examining their future habitation, in the cases I have mentioned, should have attempted in this case to enter without knowing whether there was space sufficient to contain them, and without any examination at all. I must therefore infer, that some previous intercourse had taken place between the two swarms, and that those in the possession of the cavities were not unacquainted with the intentions of their guests; though the formation of any thing like an agreement between the different parties be scarcely consistent with the limitations generally supposed to be fixed by nature to the instinctive powers of the brute creation.

A previous communication between them must have taken place.

Brutes have evidently language; but it is a language of passion only, and not of ideas. They express to each other sentiments of love, of fear, and of anger; but they appear to be wholly incapable of transmitting to each other any ideas

Brutes have language to express passions only:

ideas they have received from the impression of external objects. They convey to other animals of their species, on the approach of an enemy, a sentiment of danger; but they appear wholly incapable of communicating what the enemy is, or the kind of danger apprehended. A language of more extensive use seems, from the preceding circumstances, to have been given to bees; and if it be not, in some degree, a language of ideas, it appears to be something very similar.

but bees must communicate ideas.

A colony of bees settles soon after quitting the hive.

This merely to collect the party together.

Choose the best place that offers,

and relinquish an intended settlement in a hollow tree, when a hive is offered them.

This preference arises from-habit.

When a swarm of bees issues from the parent hive, they generally soon settle on some neighbouring bush or tree; and as in this situation they are generally not at all defended from rain or cold, it is often inferred, that they are less amply gifted with those instinctive powers, that direct to self-preservation, than many other animals. But their object in settling soon after they leave the hive is apparently nothing more than to collect their numbers; and they have generally, I believe always, another place to which they intend subsequently to go: and if the situation they select be not perfectly adapted to secure them from injuries, it is probably, in almost all instances, the best they can discover. For I have very often observed, that, when one of my hives was nearly ready to swarm, one of the hollow trees I have mentioned (and generally that best adapted for the accommodation of a swarm) was every day occupied by a small number of bees; but that after the swarm had issued from that hive, and had taken possession of another, the tree was wholly deserted; whence I inferred, that the swarm, which would have taken possession of the cavity of that tree, had relinquished their intended migration, when a hive was offered them at home. And I am much disposed to doubt, whether it be not rather habit, produced by domestication, during many successive generations, than any thing inherent in the nature of bees, which induces them to accept a hive, when offered them, in preference to the situation they have previously chosen: for I have noticed the disposition to migrate to exist in a much greater degree in some families of bees than in others; and the offspring of domesticated animals inherit, in a very remarkable manner, the acquired habits of their parents. In all animals this is observable:

but



but in the dog it exists to a wonderful extent; and the offspring appears to inherit not only the passions and propensities, but even the resentments, of the family from which it springs. I ascertained by repeated experiment, that a terrier, whose parents had been in the habit of fighting with polecats, will instantly show every mark of anger, when he first perceives the scent of that animal; though the animal itself be wholly concealed from his sight. A young spaniel brought up with the terriers showed no marks whatever of emotion at the scent of the polecat; but it pursued a woodcock, the first time it saw one, with clamour and exultation: and a young pointer, which I am certain had never seen a partridge, stood trembling with anxiety, its eyes fixed, and its muscles rigid, when conducted into the midst of a covey of those birds. Yet each of these dogs is a mere variety of the same species; and to that species none of these habits are given by nature. The peculiarities of character can therefore be traced to no other source than the acquired habits of the parents, which are inherited by the offspring, and become what I shall call instinctive hereditary propensities. These propensities, or modifications of the natural instinctive powers of animals, are capable of endless variation and change; and hence their habits soon become adapted to different countries and different states of domestication, the acquired habits of the parents being transferred hereditarily to the offspring. Bees, like other animals, are probably susceptible of these changes of habit, and thence, when accustomed through many generations to the hive, in a country which does not afford hollow trees, or other habitations adapted to their purpose, they may become more dependent on man, and rely on his care wholly for a habitation; but in situations where the cavities of trees present to them the means of providing for themselves, I have found, that they will discover such trees in the closest recesses of the woods, and at an extraordinary distance from their hives; and that they will keep possession of such cavities in the manner I have stated: and I am confident that, under such circumstances, a swarm never issues from the parent hive, without having previously selected some such place to retire to.

Remarkable effects of hereditary habit in dogs.

These habits altered and modified by circumstances,

Bees never migrate till they have selected a habitation.

It

Bees not only carry farina on their thighs, but other matters.

It has been remarked by Mr. John Hunter, that the matter which bees carry on their thighs is the farina of plants, with which they feed their young, and not the substance with which they make their combs; and his statement is, I believe, perfectly correct: but I have observed, that they will also carry other things on their thighs. I frequently covered the decorticated parts of trees, on which I was making experi-

A compound of wax and turpentine taken thus by them,

and used as a cement.

The bee very patient as an individual.

Wasps similar in their habits.

ments, with a cement composed of bees-wax and turpentine; and in the autumn I have frequently observed a great number of bees employed in carrying off this substance. They detached it from the tree with their forceps, and the little portion thus obtained was then transferred by the first to the second leg, by which it was deposited on the thigh of the third: the farina of plants is collected and transferred in the same manner. This mixture of wax and turpentine did not, however, appear to have been employed in the formation of combs; but only to attach the hive to the board on which it was placed, and probably to exclude other insects, and air during winter. Whilst the bees were employed in the collection of this substance, I had many opportunities of observing the peaceful and patient disposition of them as individuals, which Mr. Hunter has also, in some measure noticed. When one bee had collected its load, and was just prepared to take flight, another often came behind it, and despoiled it of all it had collected. A second, and even a third, load was collected and lost in the same manner, and still the patient insect pursued its labour, without betraying any symptoms of impatience or resentment. When, however, the hive is approached, the bee appears often to be the most irritable of all animals; but a circumstance I have observed amongst another species of insects, whose habits are in many respects similar to those of bees, induces me to believe, that the readiness of the bees, to attack those who approach their hives, does not in any degree spring either from the sense of injury or apprehensions of the individual, who makes the attack. If a nest of wasps be approached without alarming its inhabitants, and all communication be suddenly cut off between those out of the nest, and those within it, no provocation will induce the former to defend their nest, or themselves.

But

But if one escape from within, it comes with a very different temper, and appears commissioned to avenge public wrongs, and prepared to sacrifice its life in the execution of its orders. Not so when apparently sent out to fight.

I discovered the circumstance, that wasps thus excluded from their nest would neither defend it nor themselves, at a very early period of my life; and I profited so often, by the discovery, as a schoolboy, that I am quite certain of the fact I state; and I do not entertain any doubt, though I speak from experiments less accurately made, that the actions of bees, under similar circumstances, would be the same\*.

Mr. Hunter conceived bees wax to be an animal substance, which exuded between the scales of the belly of the insect; but I am strongly disposed to believe, that it is collected from plants, and merely deposited between the scales of the belly of the bee, for the joint purposes of being carried with convenience, and giving it the temperature necessary for being moulded into combs: and I am led to this conclusion, not only by the circumstance of wax being found in the vegetable world, but also by having often observed bees employed in detaching something from the bases of the leaves of plants with their forceps, which they did not deposit on their thighs, Mr. Hunter mistaken in supposing bees wax an animal substance.

\* A curious circumstance, relative to wasps, attracted the notice of some of my friends last year, and has not, I believe, been satisfactorily accounted for. A greater number of female wasps were observed in different parts of the kingdom, in the spring and early part of the summer of that year, than at almost any former period; yet scarcely any nests, or labouring wasps, were seen in the following autumn; the cause of which I believe I can explain. Attending to some peach trees in my garden, late in the autumn of the year 1805, on which I had been making experiments, I noticed, during many successive days, a vast number of female wasps, which appeared to have been attracted there by the shelter and warmth of a south wall; but I did not observe any males. At length, during a warm gleam in the middle of one of the days, a single male appeared, and selected a female close to me; and this was the only male I saw in that season. The male wasp, which is readily distinguishable from the female and labourer, by his long antennæ and shining wings, and by a blacker and more slender body, is rarely seen out of the nest, except in very warm days, like the drone bee; and the nests of wasps, though very abundant in the year 1805, were not formed till remarkably late in the season; and thence I conclude, that the males had not acquired maturity till the weather had ceased to be warm, and that the females, in consequence, retired to their long winter sleep without having had any intercourse with them. Abundance of female wasps in 1786. This account for.

as they do (I believe invariably) the farina of plants. I have also frequently observed the combs of very late swarms to be remarkably thin, and white, and brittle; which are circumstances very favourable to the conclusion, that the wax is a vegetable substance, for it would probably be less abundant during autumn than in summer; and that portion which had remained on the plants till late in the season would hence become more colourless by exposure to light, as well as more dry and brittle than when it first exuded; but were it an animal substance, there does not appear any reason, why it should be more dry and brittle, or less abundant, in the autumn, than in the spring and summer. The conclusions of Mr. Hunter are, however, always drawn with so much caution, and he united so much skill and science with the greatest degree of industry, that it is not without much hesitation and diffidence, that I venture to put my opinion in opposition to his authority.

*Elton, May 4, 1807.*

T. A. KNIGHT.

### III.

*Description of a Mercurial Pendulum. Communicated by Mr. BARRAUD, of Cornhill, who has made several, and has been highly satisfied with their performance in the Measure of Time.*

Description of  
a mercurial  
pendulum.

THE whole length of the pendulum rod, from the rivet that joins the spring to its top, to the end of the screw at L, fig. 1, Pl. VII, is  $33\frac{9}{16}$  inches, (say 34 inches). The side pieces of the frame M M are of steel, as thick as the rod, that is  $\frac{1}{8}$  of an inch, and not less. The top of the frame H consists of two pieces of steel, each  $\frac{1}{8}$  of an inch thick, shaped as in the drawing, and screwed over the ends of the side pieces M M. The inside height of the frame, from E to A, is  $8\frac{9}{16}$  inches, and the inside width between the pieces M M about  $2\frac{1}{2}$  inches, so that the cylinder stands  $\frac{1}{8}$  of an inch clear of them. The bottom piece N is  $\frac{1}{2}$  an inch thick from

M. Barraud's  
Mercurial  
Pendulum.

Fig. 1.

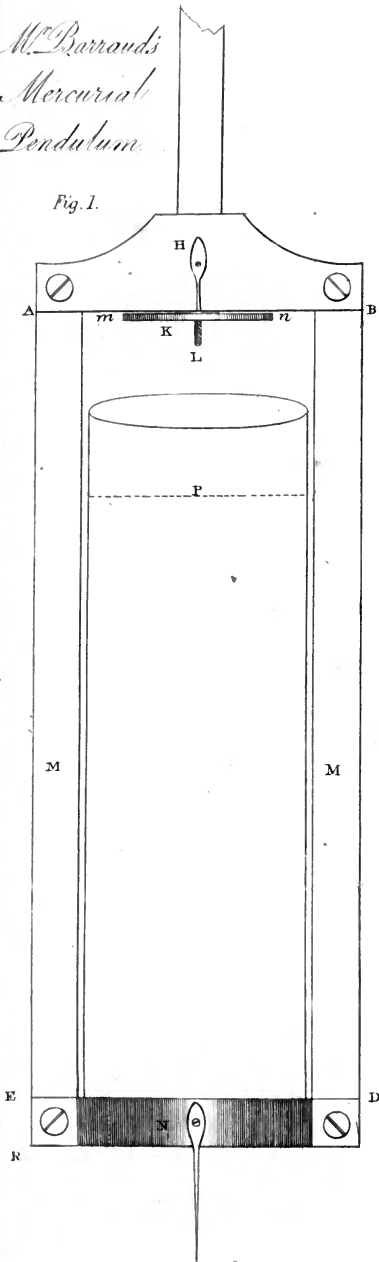

Fig. 4.



Fig. 6.



*Dr. Herschel on the Planet Vesta.*

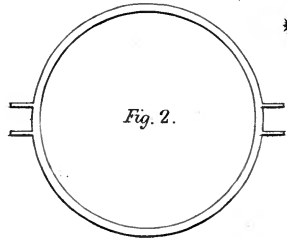

Fig. 2.

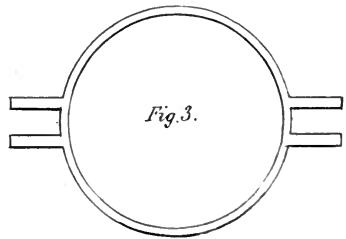

Fig. 3.



from E to R, and hollowed down to  $\frac{1}{8}$  of an inch, so as to fit the bottom of the cylinder. Description of  
a mercurial  
pendulum.

L is the bottom of the rod, and one inch of the end of it is made into a screw, that has forty threads in an inch. The nut K is  $\frac{1}{2}$  of an inch deep, and the diameter of its circle from *m* to *n* is  $1\frac{6}{8}$  inch, having the upper edge divided into 28 equal parts, and figured 0, 1, 2, 3, or at each 7th division. Each of these divisions is very nearly equal to 1" in 24 hours.

The quantity of quicksilver required is between 10 and 11 lbs. It should fill the glass cylinder up to P, being 6.4 inches from the bottom of the glass, measured internally. Fig. 2 is the cover of the glass cylinder, and fig. 3 the bottom of the frame, that supports the cylinder, both viewed vertically.

If with this pendulum the clock be found to go right with the thermometer at 30°, and loses 1" in 24 hours with the thermometer at 90°, it will be remedied by adding 10 oz. of quicksilver; and if the reverse by taking out that quantity.

The rod should be  $\frac{1}{8}$  of an inch thick, and  $\frac{3}{8}$  of an inch wide. The spring should be an inch long, and pretty stiff.

#### IV.

*Observations on the Nature of the new celestial Body discovered by Dr. OLBERS, and of the Comet which was expected to appear last January in its return from the Sun. By WILLIAM HERSCHEL, L. L. D. F. R. S.\**

THE late discovery of an additional body belonging to the solar system by Dr. Olbers having been communicated to me the 20th of April, an event of such consequence engaged my immediate attention. In the evening of the same day I tried to discover its situation by the information I had obtained of its motion; but the brightness of the moon, which was near the full, and at no great distance from the object for which I looked, would not permit a star of even the 5th magnitude to be seen; and it was not till the 24th, that a tolerable view

Account of  
the new planet  
received April  
20th, 1807.

\* Philos. Trans. for 1807, P. II, p. 260.

could be obtained of that space of the heavens, in which our new wanderer was pursuing its hitherto unknown path.

Looked for.

As soon as I found that small stars might be perceived, I made several delineations of certain telescopic constellations, the first of which was as represented in fig. 4, Pl. VII, and I fixed upon the star A, as most likely, from its expected situation and brightness, to be the one I was looking for. The stars in this figure, as well as in all the other delineations I had made, were carefully examined with several magnifying powers, that in case any one of them should hereafter appear to have been the lately discovered object, I might not lose the opportunity of an early acquaintance with its condition. An observation of the star marked A, in particular, was made with a very distinct magnifying power of 460, and says, that it had nothing in its appearance that differed from what we see in other stars of the same size; indeed Dr. Olbers, by mentioning in the communication which I received, that with such magnifying powers as he could use, it was not to be distinguished from a fixed star\*, had already prepared me to expect the newly discovered heavenly body to be a valuable addition to our increasing catalogue of asteroids.

Presumed to  
be an asteroid.

The 25th of April I looked over my delineations of the preceding evening, and found no material difference in the situation of the stars I had marked for examination; and in addition to them new asterisms were prepared, but on account of the retarded motion of the new star, which was drawing towards a period of its retrogradation, the small change of its situation was not sufficiently marked, to be readily perceived the next day when these asterisms were again examined, which it is well known can only be done with night-glasses of a very low magnifying power.

A long interruption of bad weather would not permit any regular examination of the situation of small stars; and it was only when I had obtained a more precise information from the Astronomer Royal, who, by means of fixed instru-

\* Der neue planet zeigt sich als ein stern zwischen der 5ten und 6ten grösse, und ist im fernrohr, wenigsten mit den vergrösserungen die ich anwenden kann, von einen fixstern nicht zu unterscheiden.

ments,



ments, was already in possession of the place and rate of motion of the new star, that I could direct my telescope with greater accuracy by an application of higher magnifying powers. My observations on the nature of this second new star discovered by Dr. Olbers are as follow.

April 24. This day, as we have already seen, the new celestial object was examined with a high power; and since a magnifier of 460 would not show it to be different from the stars of an equal apparent brightness; its diameter must be extremely small, and we may reasonably expect it to be an asteroid. Observations of it.

May 21. With a double eye-piece magnifying only 75 times, the supposed asteroid *A* makes a right-angled triangle with two small stars *a b*. See fig. 5.

With a very distinct magnifier of 460 there is no appearance of any planetary disk.

May 22. The new star has moved away from *a b*, and is now situated as in fig. 6. The star *A* of fig. 4 is no longer in the place where I observed it the 24th of April, and was therefore the asteroid. I examined it now with gradually increased magnifying powers, and the air being remarkably clear, I saw it very distinctly with 460, 577, and 636. On comparing its appearance with these powers alternately to that of equal stars, among which was the 463d of Bode's Catalogue of the stars in the Lion of the 7th magnitude, I could not find any difference in the visible size of their disks.

By the estimations of the distances of double stars, contained in the first and second classes of the catalogues I have given of them, it will be seen, that I have always considered every star as having a visible, though spurious, disk or diameter; and in a late paper I have entered at large into the method of detecting real disks from spurious ones; it may therefore be supposed that I proceeded now with Vesta (which name I understand Dr. Olbers has given the asteroid), as I did before in the investigation of the magnitudes of Ceres, Pallas, and Juno.

The same telescopes, the same comparative views, by which the smallness of the latter three had been proved, Similar to Ceres, Pallas, and Juno.  
convinced

convinced me now, that I had before me a similar fourth celestial body.

Described.

The disk of the asteroid which I saw was clear, well defined, and free from nebulosity. At the first view I was inclined to believe it a real one; and the Georgian planet being conveniently situate, so that a telescope might without loss of time be turned alternately either to this or to the asteroid, I found that the disk of the latter, if it were real, would be about one sixth of the former, when viewed with a magnifying power of 460. The spurious nature of the asteroidal disk, however, was soon manifested by an increase of the magnifying power, which would not proportionally increase its diameter as it increased that of the planet; and a real disk of the asteroid still remains unseen with a power of 636.

Farther observations.

May 23. The new star has advanced, and its motion is direct; its situation with respect to the two small stars *a b*, is given in fig. 7.

Its apparent disk with a magnifier of 460 is about 5 or 6 tenths of a second; but this is evidently a spurious appearance, because higher powers destroy the proportion it bears to a real disk when equally magnified. The air is not sufficiently pure this evening to use large telescopes.

May 24. With a magnifying power of 577 I compared the appearance of the Georgian planet to that of the asteroid, and with this power the diameter of the visible disk of the latter was about one 9th or 10th part of the former. The apparent disk of the small star near  $\beta$  Leonis, which has been mentioned before, had an equal comparative magnitude, and probably the disks of the asteroid and of the star it resembles are equally spurious.

The 20 feet reflector, with many different magnifying powers, gave still the same result; and being already convinced of the impossibility, in the present situation of the asteroid, which is above two months past the opposition, to obtain a better view of its diameter, I used this instrument chiefly to ascertain, whether any nebulosity or atmosphere might be seen about it. For this purpose the valuable quantity of light collected by an aperture of  $18\frac{1}{2}$  inches directly received by an eye-glass of the front view without a second reflection,

reflection, proved of eminent use, and gave me the diameter of this asteroid intirely free from all nebulous or atmospheric appearances.

The result of these observations is, that we now are in possession of a formerly unknown species of celestial bodies, which, by their smallness and considerable deviation from the path in which the planets move, are in no danger of disturbing, or being disturbed by them; and the great success that has already attended the pursuit of the celebrated discoverers of Ceres, Pallas, Juno, and Vesta, will induce us to hope, that some further light may soon be thrown upon this new and most interesting branch of astronomy.

*Observations of the expected Comet.*

The comet which has been seen descending to the sun, and from the motion of which it was concluded, that we should probably see it again on its return from the perihelion, was expected to make its reappearance about the middle of last January, near the southern parts of the constellation of the whale. Reappearance  
of a comet ex-  
pected.

January 27. Towards the evening, on my return from Bath, where I had been a few days, I gave my sister Carolina the place where this comet might be looked for, and between flying clouds, the same evening about 6<sup>h</sup> 49', she saw it just long enough to make a short sketch of its situation. Seen by Miss  
Herschel.

January 31. Clouds having obscured the sky till this time, I obtained a transitory view of the comet, and perceived that it was within a few degrees of the place which had been assigned to it; the unfavourable state of the atmosphere, however, would not permit the use of any instrument proper for examining it minutely.

There will be no occasion for my giving a more particular account of its place, than that it was very near the electrometer of the constellation, which in Mr. Bode's maps is called *machina electrica*; the only intention I had in looking for it being to make a few observations upon its physical condition.

February 1. The comet had moved but very little from the place where it was last night; and as the air was pretty clear, Described.

clear, I used a 10-foot reflector with a low power to examine it. There was no visible nucleus, nor did the light which is called the coma increase suddenly towards the centre, but was of an irregular round form, and with this low power extended to about 5, 6, or 7 minutes in diameter. When I magnified 169 times it was considerably reduced in size, which plainly indicated, that a farther increase of magnifying power would be of no service for discovering a nucleus. On account of cloudy weather I never had an opportunity of seeing the comet afterwards.

Compared  
with others.

When I compare these observations with my former ones of 15 other telescopic comets, I find, that, out of the 16 which I have examined, 14 have been without any visible solid body in their centre, and that the other two had a very ill defined small central light, which perhaps might be called a nucleus, but did not deserve the name of a disk.

## V.

### *Observations and Measurements of the Planet Vesta. By*

JOHN JEROME SCHROETER, F. R. S.\*

Planet Vesta  
has no disk  
with a power  
of 300,

and an intense  
radiating light,  
like a star of  
the 6th magni-  
tude.

The same with  
other tele-  
scopes.

AT our very first observations with magnifying powers of 150 and 300 applied to the excellent new 15-foot reflector, we found the planet Vesta *without any appearance of a disk*, merely as a point like a fixed star with an intense, radiating light, and exactly of the same appearance as that of any fixed star of the sixth magnitude. In the same manner we both afterwards saw this planet several times with our naked eyes, when the sky was clear, and when it was surrounded by smaller invisible stars, which precluded all possibility of mistaking it for another. This proves how very like the intense light of this planet is to that of a fixed star.

As the observations and measurements of Ceres, Pallas, and Juno, were made with the same eye-glasses, but with the 13-foot reflector, we soon after compared the planet Vesta with the same glasses of 136 and 288 times magnify-

\* From the Philos. Trans. for 1807, Part II, p. 245.

ing power in the 13-foot reflector. In both these telescopes its image was, *without the least difference*, that of a fixed star of the 6th magnitude with an intense radiating light; so that this new planet may with the greatest propriety be called an *asteroid*.

An asteroid.

April 26th in the evening at 9 o'clock, true time, I succeeded in effecting the measurement of Vesta, with the same power of 288, by means of the 13-foot reflector, with which that of Ceres, Pallas, and Juno had been made; and when viewed by this reflector it also appeared exactly in the same manner. Of several illuminated disks, of 2.0 to 0.5 decimal lines, which I had before made use of for measuring the satellites of Saturn and Jupiter, the smallest disk only of 0.5 lines could be used for this purpose; by it the rounded nucleus of the planet Vesta, when the disk was at the distance of 611.0 lines from the eye, appeared *at most* of the same size, and I must even estimate its diameter as  $\frac{1}{3}$  smaller. If therefore, we attend, not to the full magnitude of the projection, but the estimation just mentioned, it follows by calculation that the *apparent diameter of the planet Vesta* is *only 0.488 of a second*, and consequently only *half* of what I have found to be the apparent diameter of the *fourth satellite of Saturn*.

Measured.

Its apparent diameter only 0.488", or half that of the 4th satellite of Saturn.

This extraordinary smallness, with such an intense, radiant and unsteady light of a fixed star, is the more remarkable, as, according to the preliminary calculations of Dr. Gauss, there can be no doubt that this planet is found in the same region between Mars and Jupiter, in which Ceres, Pallas, and Juno, perform their revolutions round the sun; that, in close union with them, it has the same cosmological origin; and that as a planet of such smallness and of so very intense light, it is comparatively *near to the earth*. This remarkable circumstance will no doubt be productive of important cosmological observations, as soon as the elements of the new planet have been sufficiently determined, and its distance from the Earth ascertained by calculation.

It is between Mars and Jupiter.

Lilienthal, May 12, 1807.

## VI.

*On a new Method of Slating, and constructing the Roofs of Houses: by Mr. LEWIN TUGWELL\*.*

Principles of Mr. Tugwell's method of roofing.

THE leading principles of Mr. Tugwell's plan are, to save slate and timber, thus diminishing the expense of a roof; and at the same time to render it secure against the admission of wind or water. The saving of slate is effected by lowering the pitch of the roof. This likewise diminishes the length of the rafters, which at the same time are placed farther asunder than usual; and besides this the boarding, usually placed under slates to keep out the wet, is dispensed with entirely. An additional advantage he observes is connected with his roof. It possesses such superior strength, as to be capable of sustaining, if necessary, partitions, and floors connected with them, even down to the ceilings of the modern enlarged dining rooms, if they be appropriately constructed and suspended from it; thus superseding the necessity of the otherwise expensive and complicated construction of spliced beams, ceiling joists, &c., saving timber and workmanship in these also; and finally, by thus combining in a frame the roof, partitions, and floors of a building, of rendering the whole much more firm and compact, than any mode hitherto used.

His new mode described.

The peculiarities of the mode, and as such necessary to be pointed out, cannot be described, and consist in,

1st. A diminution in its elevation, seen in the beam-rafters A A, Pl. VIII, fig. 1, giving an angle of only twelve degrees from the horizon, whereby both its timbers and slates will be lessened in quantity in a ratio generally as of three to four.

2dly. The increased distance of these rafters, as at B B, fig. 2, one from another, *i. e.* to two feet. And as, in the modes hitherto used, they are generally at not more than 15 inches asunder, a farther saving will therein be found of

\* Abridged from the Letters and Papers of the Bath and West of England Society, vol. XI.







more than one in three, or as in the proportion of 18 to 11; and which, together with the diminution in their length above-mentioned, while they combine in a system of far greater strength and duration, will incur a saving in the slating as aforesaid of about a fourth part, and in the raftering of considerably more than half.

New mode of  
slating de-  
scribed.

C C, figs. 1, 2, Wall-plates in substance considerably increased; viz. to six inches square.

D D D, figs. 1, 2, Foot-beams, firmly inserted in the wall-plates, by means of dove-tailed joints, at six feet distance from each other; one of which joints is seen at fig. 8, laid open, to display the operation of the wedge; as, should it inadvertently be driven in on the inside of the plate, and where floors, partitions, &c. as before hinted, on any occasion, are to be suspended on the roof-timbers, it would necessarily draw, and derange the whole of the superstructure\*.

E E E, figs. 1, 2, First-piece, of peculiar shape and strength, being two inches thick, and nine deep.

F F, figs. 1, 2, Purloins, or side-pieces, let in, and spiked to the queen-posts, at right angles with the rafters, and at equal distances from their extremities.

G G, fig. 2, Plate-rafters, let into the wall-plates at their lower ends, screwed at their centres to the purloins, and firmly fastened by an appropriate joint (see fig. 3) to the first pieces. Thus in these is more distinctly seen the peculiar and singular stability of the system. As each of the foot-beams, together with its sustained and sustaining rafters, king and queen posts, &c., forms an arch, or rather a series of arches, of such permanency as not to be subdued, while their parts remain uncrushed, the wall-plates C C, fastened

\* Should it at any time be foreseen that a more than ordinary weight will be found in floors, partitions, &c., thus suspended on the roof-timbers, it will be only necessary to enlarge the size of the latter, and they may therein be adapted to any scale required. If, however, there should be a probability that an alteration in the upper chambers may at some future period take place, and wherein a removal of the partitions may become necessary, although it would be far from being impracticable, the method may, notwithstanding, all things considered, perhaps not be found the most eligible.

New mode of  
slating de-  
scribed.

to them by dove-tailed joints as aforesaid, constitute, for these intervenient rafters, abutments as immovable as those of the beam-rafters themselves; and which, like those, being firmly fastened to the purloins F F, at their centres, and to the first-pieces at their upper ends; while these first-pieces remain unbent in an upward direction, and the wall-plates are found immovable outwards, they form, each pair of them, as permanent an arch as the beam-rafters themselves; and thus aiding the latter, they altogether constitute, as aforesaid, a frame of such singular and uniform strength and stability, as undoubtedly to be capable of sustaining at least any weight that it may ever be necessary to lay on it.

H H H, figs. 1, 2, Deal laths, each an inch thick, and two inches wide, their lower half rabbited for receiving the upper ends of the slates, in depth equal to the thickness of the latter.

I I, figs. 1, 2, Slates, nailed nearly at their centres to the upper parts of the laths, the nails clenched, and the slates cemented on both sides to each other with putty, or any other matter proper for uniting them; and thereby effectually excluding rain, wind, driving snow, and all aerial humidity.

K K, fig. 2, Ceiling-joists inserted in the foot-beams after the usual manner.

L, fig. 2, A portable stage or scaffold for the slater to work on between the rafters, for keeping at all times under his thumb a new and appropriate set of simple implements, (as usefully employed by rational beings in all other matters) and occasionally, as the work proceeds, to be drawn backward on the ceiling-joists.

M, fig. 1, The slater seated between the rafters on his stage, with his work before him, and immediately under his eye.

N, fig. 7, A discharging saw, that, being of proper temper, and having a series of teeth about three inches down on each side from its point, is occasionally introduced by a hammer at its heel, and thus removes putty, nails, &c. from a broken slate; when a new one, supplying its place, will, with a little putty under its lower edge to cement it, become quite as effectual, if not as firm, as the original one. Probably,

bably, the putty having been thus removed by the teeth of the saw up to the nail, a similar instrument, with however finer teeth, would more properly apply for cutting off the latter, when the first might again proceed to the entire separation of the slate.

New mode of  
slating de-  
scribed.

O, fig. 4, A pallet of thin permanent board, that, being put into a mould for the purpose, receives on its upper surface putty, mortar, or any other proper cement; and which, being spread over it with a moistened wooden spatula, or striker, obtains a uniform thickness (a quarter of an inch more or less), governed by the depth of the mould, in the manner of forming bricks: this is afterward divided into half-inch slivers, and applied on the joints of the slates; as seen at P, fig. 2.

Q, fig. 5, The mould, of the same breadth on the inside as the pallet; and which, having an edge rising on three of its sides more than the thickness of the pallet, gives that of the cake of cement.

R, fig. 6, A two-edged knife, for dividing and applying the above slivers of mortar, putty, &c.

S, figs. 1 and 2, a small set or head of iron, about three pounds weight, to be taken with the left hand, at the driving of the nails, and pressed hard against their points, thus giving them an effectual clinching, and at the same time receiving the impulse of the hammer, so as to prevent all jarring, disjunction, and derangement. Still farther to guard against this, and to avoid the absurd practice of splitting the laths with almost every nail that is driven through them, an appropriate brad-awl, T, fig. 2, with a T head and chisel point, to cut its way across the grain, should be used to make a passage for the nail, previous to driving it.

While the pressure of every kind of slating on the timbers of a roof is found in all its parts equal, and the power of such timbers for sustaining it is, by the modes hitherto used, very partially applied, and chiefly found in those that have their lower ends set in its foot-beams; an idea of a peculiar uniformity and consequent stability in the general system here recommended, as well as separately in that of fastening down its slates, will, I humbly conceive, impress itself on every mind open to conviction.

General defect  
of roofs.

Was

Slates should  
be cut at the  
quarries.

Was the value of these slates duly estimated, howsoever plenteous and inexhaustible at their quarries, they might there, by means of various patterns, saws, drills, rasps, and other proper machinery, while moist and soft, be formed into differently sized parallelograms, with the greatest facility, accuracy, and dispatch; and every slate being made thereby to retain the utmost regular size its rough dimensions would admit of, much unnecessary waste would be avoided, and being afterwards regularly classed and denominated by the number of inches in their lengths and breadths respectively, (as nine fifteens, ten eighteens, &c. instead of the burlesque terms of *ladies*, *countesses*, and *duchesses*) they might with much less expense be conveyed to their respective destinations; and when, whatever the class preferred, they would be also much more conveniently and effectively applied, than if of various shapes and sizes. Millstones, grindstones, and indeed all others, if raised at a distance from their respective destinations, are prudently divested of all superfluous matter and weight at their quarries; and, but for its claim to exemption from all that is rational, there is no cause why the same economy may not be used in the removal of slate.

Thatching  
should be dis-  
carded.

From considerations of the great scarcity, and high price of timber in general, and consequent necessity for our regarding the most frugal use of that article; also, the immense waste of that ground-work of all our wealth and support, manure for our lands, that has, through all ages, from time immemorial prevailed in the use of thatch; and finally, from the certain and very great danger of the latter being destroyed by fire; the obvious absurdity of using it at all, wherever a better material may be obtained, one might naturally suppose would evince the propriety of an almost universal recourse to light thin slates, as a most eligible material for roofing in general.

Danger of fires  
instanced.

I recollect no less than six fires having taken place in my native village, from its cottages having been covered with *thatch*. One of them was occasioned by sparks from a forge; another by those from an oven; and three, if not four, were generally supposed to have proceeded from the hands of incendiaries. It is observable, that during the whole

whole period of the above only one fire has happened there under a roof formed of slate: and that in the building of all houses since, that article has judiciously obtained a preference.

With a view to general reformation in the matter, we may observe, that from the universal predilection, during about thirty years past, for that very beautiful and quick growing plant, the Lombardy poplar, wisely fostered in all crowded places, and particularly the metropolis, among other good purposes, for the purification of the atmosphere, its fine straight timbers begin now necessarily to be taken down and brought to market, so that in a short time we may expect an abundant supply; and although, being of a very light and soft texture, no particular use has yet been assigned them, there cannot be a doubt of their being ere long very generally used, at least for inferior buildings; the precautions being regarded of felling them always in winter, and when sawn, washing out their saccharine juices, by laying their scantlings awhile under water; and also giving them (together with their plank, boards, &c.) extra size, in proportion to their want of density. The Scotch fir likewise, from the scarcity and dearth of all other timber, and particularly foreign deals, begins now to be universally employed. And were the genius and peculiar properties of our immense tracts of waste lands thought worth attending to, it cannot be supposed, but that many of them, composed of light, pervious, blowing sands, and fit for little else, (such as about Basingstoke in Hampshire, and indeed to be found elsewhere in too many parts of the kingdom) might be rendered abundantly productive of this article; and which also, when felled and sawn, being properly washed, would be found very generally useful in better erections. Whenever their long horizontal roots may without obstruction extend themselves, howsoever infertile, in the common acceptation, the soil, their growth is generally more rapid than in land more rich; but at the same time more close and impervious\*. Nor, it is to be hoped, will the idea be  
thought

Lombardy  
poplar.

Cautions re-  
specting it.

Scotch firs.

\* There are now lying on the Quay in this town, brought down by the Kennet and Avon Canal, many fine trees of larch, with others of  
Scotch

thought visionary, that were a sufficiency of these articles thus easily and quickly procured, they might afterwards, by means of our already numerous and constantly increasing canals, and other improved modes of conveyance, together with a proper accompaniment of blue slate, or at least the factitious red pantiles, be transmitted to every town and village in the kingdom; whence the produce of perhaps richer lands might be remitted in return, and in some degree commensurate to the expense.

Much also might be done by appropriate and judicious planning; some houses containing by far more room, and particularly *useful* room, than others under the same or a less quantity of roofing.

Instance in proof of the adequacy of the method.

The danger of the slates being broken; and the insufficiency of the putty or cement, to keep the joints weather-tight, have been objected to Mr. Tugwell's plan. In answer to this he points out a house thus covered in upward of three years ago, which has remained during that time impervious to wind, wet, or dampness of any kind from the air.

## VII.

*Heights of various Places in France, &c.; by Dr. BERGER.  
Concluded from Vol. XVIII, p. 308.*

### SECT. IV.

*Brief description of some mountains in the department of  
Mont-Blanc.*

Valley des  
Bornes.

THE valley des Bornes, the bottom of which is scarcely higher than the plain of the lake of Geneva, and which is

Method of  
treating knotty  
plants.

Scotch and spruce fir, more than forty feet in length, although of less than forty years growth; they, several of them, square two feet at bottom, and nearly one at the top; many of the larch, approaching nearer to parallelisms, are straight, and free from knots; and the lower lengths of even the Scotch fir cut very good board; while their tops serve well to coarse roof timbers; but as the knots in these dispose their scantlings to warp in drying, care should be taken to soak them immediately from the saw-pit; and in about six weeks after, judiciously to stack them from the pool, placing the most knotty always at the bottom of the pile, whereby much of such warping would generally be prevented.

separated

separated from it only by the mountains Salève, Sion, and Vouache, has for its limits to the south a chain of mountains in the same line as mount Brison, and the direction of which is parallel to that of the central chain. The course of the Arve, and the low mountains that skirt the western shore of the lake of Annecy, are its boundaries to the north-east and south-west.

Mr. Saussure has described only the mountains on the north of this valley. The chain on the south, taken together, is at least 15 miles long. Its greatest height, like that of the Jura, is to the south-west. One mountain there, la Tournette, rises 940 toises above its base. The precipices of this chain look from the Alps, that is to say, the strata slope toward them. The limestone that composes them is compact, including great numbers of imbedded flints, and not unfrequently we meet with calcareous rocks, the tops of which are completely capped with silex.

Southern chain.  
La Tournette.  
Silex interspersed in limestone.

Though the mountains that form this chain are all connected together, except that the continuity is occasionally interrupted by a transverse valley, they have almost as many different names, as there are parishes at their feet. The strata are much more regular in the north-east part of the chains, than in the south-west. Thus the mountains of St. Laurence display horizontal banks, much resembling those of mount Salève; while at Villaz and Dingy, where the principal branch of the chain has a perceptible inflexion to the south, the strata lose their uniform horizontality, and this more and more as we approach Tournette, where we see some completely broken, others arched or raised upon themselves; a character, as already observed, announcing the vicinity of a transition chain. The back of this chain toward the Alps falls into the valley of little Bornand, at the bottom of which flows the river Borne. Over this river is a bridge more than sixty feet high.

Variation in the strata.

The two principal summits of this chain are Pormonaz and Tournette. Pormonaz is nearly in the middle of the chain, and rises 540 toises above its base. The first part of the ascent is through a very thick wood, from which, after a journey of two hours and half, you enter into rich pastures, bounded on all sides, except to the north-east, by

Pormonaz.  
Thick wood.  
Pastures.

cliffs more than 180 toises high. In these meadows, which form a natural amphitheatre, are huts, where you may spend the night on occasion, and whence there is a pleasant view of part of lake Annecy and the surrounding country. From this station you gain the summit of the mountain in an hour and three quarters. Nothing can be more dreary than the top of mount Pormonaz. Figure to yourself a vast flat of limestone rock, perfectly bare and destitute of vegetation, intersected by clefts in every direction, like the table-land of mount Plattet, and you will have a just idea of it. Here and there at the bottom of these clefts are seen the dry trunks of some lifeless firs, the brown colour of which forms a striking contrast with the whiteness of the rocks amidst which they are found.

Extensive bare flat.

Flints.

In no part of the chain did I find nodules and caps of flints so abundant. The analysis of one of these nodules gave me 0.87 of siliceous earth: yet when reduced to powder an acid excited a slight effervescence in it, from a small quantity of calcareous earth, either forming a constituent part of it, or from which the surface could not be completely freed.

Tournette.

From the summit of Pormonaz Tournette appears to advantage. It is seen directly south, and exceeding in height most of the mountains around it as much as Mont Blanc surpasses the summits in its vicinity.

Ascent to it.

Tournette may be ascended by the way of Talloires, but more easily by that of Thônes, a small but very ancient town, now the chief place of a circle, which is seated at its east foot. This town is built in a very narrow valley, which on this account enjoys a warmer temperature than the larger vale, as is evident from the plants it produces.

Thônes.

Clefts.

From Thônes you proceed along the bottom of this valley for half an hour, then cross a branch of the Sière on a wooden bridge, and reach the hamlet of Clefts. Thence the road continues through a wood of beech and firs, not very thick, to about one third the height of the mountain. At this place are a few summer huts. The first time I

Recent glacier.

ascended Tournette, which was in 1799, I found on the 12th of August, some distance above these huts, a cake of frozen snow, several feet thick at bottom, the only place where



where its thickness could be estimated, and extending up the acclivity of the mountain quite to its summit. The preceding winter having been severe, so much snow had fallen, that the heat of summer had not been able to melt it, a circumstance unheard of before, for the oldest inhabitants could not recollect, that the snow had ever remained longer than the end of June. I conceived this mass of frozen snow might prove the nucleus of a glacier of the second order\*: and in fact the following year, when I returned thither in July, I found the snow, far from having diminished, had rather increased, so that the recent production of a glacier on this mountain appeared to me very probable.

On approaching the summit the stone assumes a fissile character, which it had not below; and we meet with dodecaedral calcareous spar finely crystallized, and several fragments of gritstone, of which there is a stratum 116 toises above the level of the sea. I did not perceive any nodules of silex, which are so common on mount Pormonaz. The loftiest point of Tournette is a very remarkable rock. It is nearly circular, 94 feet high, and 145 in diameter, standing alone on a point of the ridge that forms the summit, and cut perpendicularly nearly alike, on every side. There is no getting to the top of it, but my means of steps cut in the rock on the north-east. It is no doubt from this rock, standing there like a sentry-box, and seen from all the surrounding country, that the mountain received its name. The prospect from it is very extensive and interesting. To the east it takes in the centre of the grand chain, and all the secondary ones attached to it in succession: to the south-east the mountains Tarenteuse and Maurienne: to the south-west those of the department of the Isère: the chain of Jura to the north-north-west: and the lake of Geneva to

\* Mr. Saussure first distinguished the glaciers into two kinds. The first are included in the bottoms of the high valleys, almost all in a transverse direction, that terminate at bottom in the low longitudinal valleys, while at top they form grand *culs-de-sac* surrounded by inaccessible rocks. Such are those that terminate in the valley of Chamouni. Those of the second kind are not included in valleys, but spread over the slopes of lofty summits.

the north. Beneath your feet you have a bird's eye view of the lake of Annecy, and the fine plains around it: and westerly, toward the Lyonnais, the view extends very far, as there is nothing to interrupt it.

Another road. The road by way of Annecy and Talloires is much more laborious. The ascent from Talloires is very steep, and not free from danger. In the neighbourhood of that town is a fine vineyard, formerly belonging to a convent of Benedictines there; and the road to it from Menthon is shaded by Chesnuts and walnuts. The mountain itself is very rich in plants, whichever way you ascend it.

The following table exhibits the heights of the different places that have been mentioned, in fathoms and thousandth parts above the level of the sea, as calculated from the height of the barometer, both according to the formula of Deluc and that of Trembley, with the mean temperature by Fahrenheit's thermometer, and the time when the observations were made.

The heights of some of the principal points, as given by Deluc, Pictet, and Saussure, are also added.

## TABLE of Heights above the Sea, in Toises and Thousandth Parts.

*Department of the Lemán Lake.*

PLACES.	Time of the observation.	Mean Tem. by Fah.	Height acc. to the cal. of Deluc.	of Trembley.
Village of le Coin, foot of mount Salève.....	25 June, 1802, 5,30' P. M. . .	69.7°	328.333	331.833
Summit of the little Salève*.....	21 June, 1801, 1 P. M. . .	67.8°	459.833	466.500
Barn of the 13 trees†.....	10 A. M. . .	59.3°	591.833	601.500
Summit of mount Salève‡.....	25 June, 1802, 2 P. M. . .	70.5°	697.166	710.666
Lussinge' at the foot of mount Voirons.....	30 Sept. 1801, 7 A. M. . .	52.8°	346.166	368.500
South summit of Voirons.....	1,50' P. M. . .	63.3°	714.166	727.500
Northern summit, called Ca vary §.....	4,15' P. M. . .	56.75°	741.333	752.166
Notre Dame d'Abondance.....	16 Sept. 1799, 8 A. M. . .	47.4°	443.833	449.333
Boundary cross between France and le Valais.....	2 P. M. . .	65.8°	709.333	723.166
Huts of la Chiazre    on the Môle.....	28 June, 1801, 2,15' P. M. . .	71°	614.166	625.333

\* According to Mr. Deluc, Rech. sur les Mod. de l'Atmos. 445 toises.

§ According to Mr. Saussure, 707 toises.

† 1 lb. 601 toises.

‡ According to Pictet, 611.666.

‡ 1 lb. 700 toises.

Huts

PLACES.

	Time of the observation.	Mean heat.	Accord. to Deluc.	Accord. to Trembley.
Huts of la Tour *	28 June, 1801, 8 A. M. ..	60.5°	730.363	743.666
— Aisle †	9 Aug. 1799, 5 A. M. ....	64.1°	769.333	784.000
Summit of the mountain ‡	— 11 A. M. ....	67.2°	937.833	957.666
	28 June, 1801, 10,30' A.M.	61.6°	943.666	962.666
	— noon .....	61.7°	941.833	961.833
Mean of the three obs.	.....	....	941.110	960.386
Bonneville §	8 Aug. 1799, noon .....	81°	225.166	225.833
Samoin, in the vale of Taninge	24 July, 1801, noon .....	71.1°	352.333	356.166
Sixt	— 7,30' P. M.	71°	385.166	386.333
	25 July, 1801, 12,15' .....	65.3°	383.833	380.500
Mean of the two obs.	.....	....	384.499	387.416
Mount Brison ¶	24 July, 1800, 7 P. M. ..	62.9°	940.833	972.833
Defile of Encrenaz, on mount Vergi	16 Aug. 1799, 11 A. M. ...	64°	1019.000	1040.500
Lake Beni, or Saxonnex	17 Aug. 1799, 1 P. M. ..	62.3°	729.333	743.000
Another defile of mount Vergi	25 July, 1800, 2 P. M. ..	73.6°	1180.833	1208.333

\* According to Saussure, 717.666.

† Deluc, 947.666 Pictet, 940.333.

‡ Deluc, 25 Aug. 1765, 374.666: and 24, 25, 26 Aug. 1770, 374.833.

† Deluc, 780.666. Pictet, 765.666.

§ Saussure, 226.666.

¶ Pictet, 943.

Lake

PLACES.	Time of the observation.	Mean heat.	Accord. to Deluc.	Accord. to Trembley.
Lake Lessy	15 Aug. 1799, 6 A. M.	61° 1'	865·500	884·166
Chartreuse of Reposoir	5 P. M.	69° 4'	530·833	539·833
	26 July, 1800, 9 A. M.	65°	526·500	535·166
	22 July, 1801, 5 A. M.	53° 6'	523·500	531·333
Mean of the three obs.		.....	526·944	535·444
Summit of Point-de-Château	26 July, 1800, 4 P. M.	65° 5'	1258·833	1296·833
	23 July, 1801, 9 A. M.	60°	1259·666	1282·500
	11 A. M.	63° 3'	1262·000	1287·500
Mean of the three obs.		.....	1260·166	1288·944
Huts of Meiri	22 July, 1801, 7 P. M.	60° 8'	880·183	896·833
Nancy-sur-Closes	27 July, 1800, 8 A. M.	61° 7'	461·166	467·833
Lake of Chéde	21 Aug. 1801, 2, 15' P. M.	78° 1'	402·333	498·000
Huts of Villy	18 Aug. 1801, 8 P. M.	53° 4'	947·266	964·666
Defile of Charlenton	19 Aug. 1801, 8 A. M.	53° 7'	1270·500	1296·166
Summit of Buet	9, 45' A. M.	55° 4'	1562·666	1596·000
	11, 20' A. M.	54° 9'	1585·166	1619·000
Mean of the two obs.		.....	1573·916	1607·500
According to Mr. Pictet	July, 1778	66° 8'	1580·000	1616·833
According to Mr. Deluc		.....	1559·166	

According

PLACES.	Time of the observation.	Mean heat.	Accord. to Deluc.	Accord. to Trembley.
Valorcine .....	13 Aug. 1801, 9,15' A. M.	59.3°	622.333	632.833
Town of Prieuré .....	20 Aug. 1801, 1,20' P. M.	75.6°	543.000	552.500
According to Mr. Saussure .....		....	524.666	
and from a mean of 85 barom. obs. ....		73.9°	525.000	534.666
——— Mr. Saussure, jun. ....	2 Aug. 1787, noon .....	78.1°	527.666	537.166
	————— 2 P. M. ..	80.7°	531.666	544.500
Summit of mount Bréven .....	18 Aug. 1801, 12,30' .....	57.6°	1283.166	1309.323
Hut of Phinpra .....	————— 10 A. M. ..	59°	1052.000	1073.333
Huts of Arcluvé .....	————— 4 P. M. ..	61.8°	956.000	975.333
——— Balme .....	12 Aug. 1801, 3 P. M. ..	70.9°	1019.000	1041.333
<i>Department of Mount Blanc.</i>				
Villaz .....	11 Aug. 1799, 7 A. M. ..	61.7°	381.166	385.833
Summit of Pormonaz .....	————— 3 P. M. ..	66.2°	919.500	938.666
	23 July, 1800, noon .....	59.8°	922.833	941.166
Mean of the two obs. ....		....	921.166	939.916
Huts on Villaz .....	11 Aug. 1799, 10 A. M. ..	65.5°	728.333	742.500
	22 July, 1800, 7 P. M. ..	59.3°	741.333	754.000
	23 July, 1800, 8,30' A. M.	58.1°	741.833	755.333
				Mean

PLACES.	Time of the observation.	Mean heat.	Accord. to Deluc.	Accord. to Trembley.
Mean of the three obs. ....	.....	....	733·833	750·611
Lake of Annecy* .....	20 July, 1800, 6 A. M. ..	59·7°	229·000	229·666
Talloires, according to Mr. Pictet .....	10 Sept. 1790, 8,15' P. M.	64·6°	238·500	239 233
Summit of la Tournette .....	13 Aug. 1799, 10 A. M. ..	60·7°	1183·333	1208·500
.....	21 July, 1800, 3 P. M. ..	64·5°	1199·666	1226·000
According to Mr. Pictet .....	17 Sept. 1790, 8,52' A. M.	61·9°	1182·000	1207·333
.....	————— 10,40' A. M.	66·4°	1190·166	1212·666
Mean of the four obs. ....	.....	....	1190·211	1213·624
Hut of Cassay .....	21 July, 1800, 11 A. M. ..	60·6°	903·333	921·183
According to Mr. Pictet .....	17 Sept. 1790, 6,10' A. M.	57·7°	882·000	899·000
Mean of the two obs. ....	.....	....	892·666	910·641
Huts on Thônes .....	12 Aug. 1799, 7 P. M. ..	60°	809·666	825·166
.....	21 July, 1800, 7,45' P. M.	58·1°	813·833	829·000
.....	22 July, 1800, 5 A. M. ..	48·9°	821·666	835·333
Mean of the three obs. ....	.....	....	815·055	829·833
Huts of l'Eau, according to Mr. Pictet .....	17 Sept. 1790, 2,25' P. M.	74·7°	712·833	727·333

\* According to a mean between Saussure and Pictet, 222·666.

## VIII.

*On the Cultivation of the Poppy.* By T. COGAN, M. D\*.

GENTLEMEN,

ALTHOUGH the ardour with which the British nation pursues whatever promises to be of public utility, is perhaps unequalled by any other, and certainly exceeded by none; yet there is one subject which has hitherto been permitted to escape our attention, and in which several nations upon the continent can not only boast of their superior policy, but are already enjoying considerable advantages from it; I mean *the cultivation of the poppy to a great extent for the benefit of its oil, as an article of food*, and for other useful purposes.

Cultivation of the poppy neglected.

Objection to it.

It will doubtless be remarked, that we ought not to ascribe the neglect of it as an article of food to *inattention* altogether, but to a superior caution, as the narcotic quality of the poppy renders it totally unfit to be taken inwardly. This, it is allowed, is, in appearance, a very formidable objection; and as it respects the lives of multitudes, it ought not to be treated with levity: the objection itself, and the argument from analogy on which it is founded, ought to be completely confuted, before the article can be recommended to the community in this novel point of view.

Answer to this objection.

We might observe that the objection is solely founded upon very slight and imperfect analogy. It *assumes*, that, because some parts of a plant are noxious, the whole must be equally noxious. But this assumption may be confuted in numberless instances. Daily experience testifies, that different parts of plants possess not only different, but *opposite* qualities. Oranges and lemons, which are used in profusion, possess juices that are both palatable and refrigerating; but these are enclosed in a rind, the essential oil of which is extremely acrid and stimulating: and it is well known that the bland and nutritive tapioca is the produce of a tree the roots of which are highly poisonous. In this case, therefore, the ar-

\* Papers of the Bath and West of England Society, vol. X, p. 331.



gument from analogy may be considered as a very proper motive for *caution*; but if it advances farther, it degenerates into a pernicious *prejudice*.

There have been, however, many incidental circumstances which have had a partial influence in removing these prejudices. It is well known, that compounders of medicine have made a very liberal use of the seeds of poppies, as substitutes for the oil of sweet almonds, without the least detriment to the patient. They have sometimes imputed to it *additional virtues*, from its being supposed to possess narcotic properties. But that they have erred in their hypothesis is plain, from the practice of many individuals, who have made the seeds of poppies a common article of food\*.

The oil has been used freely without injury,

and the seeds also.

But it will be the principal object of the following paper to inform the inhabitants of this country, through the medium of your publication, that the above objection has been repeatedly advanced and repeatedly confuted; that experiments, first made with a degree of caution, have finally removed prejudices long and inveterate; and that the white poppy (*papaver hortense semine albo*) is cultivated to a very great extent in *France, Brabant, and Germany*, and more recently in *Holland*, chiefly to extract the oil from its seeds; which is found not only to be salubrious, but to be peculiarly delicate in its flavour. It is now become a considerable article of commerce: the oil of a superior quality, for the use of the table, and the inferior for manufactories and various other purposes. It is produced not only with considerable profit to the cultivator, but also to the merchant and consumer.

Cultivated extensively abroad for its oil.

As it is natural to imagine, that the prejudices against the common use of poppy oil for culinary purposes will be very general, since they are apparently sanctioned by prudent caution, it is not expected that the most positive assertions, founded upon the experience of strangers on the continent, would be sufficient to remove them. But a circumstantial narrative of a contest which has already taken place; and the final triumph of experience over the opposition founded

Prejudices against it.

Successfully combated.

\* See Prosper Alpinus, lib. iv, cap. i. Geofrey Mat. Med. tom. ii, p. 715. Lewis's *Materia Medica*, Article *Papaver Album*.

on analogous reasoning; and a particular statement of the advantages which have accrued to the cultivator, merchant, and consumer, may perhaps attract the attention of some agriculturists in our own country, who may thus be encouraged to make similar experiments: and as the issue must be the same, they will be able to produce absolute demonstration, that the oil is totally destitute of the noxious qualities, that have been ascribed to it; and finally convince the public, that it may become a cheap and useful substitute for the olive oil, and a very beneficial article of commerce.

Rise and progress of its cultivation.

For this purpose I shall state to the agriculturist a succinct account of the rise and progress of the cultivation of the poppy, in order to express the oil from the seed; the manner of cultivating it, and the emoluments which have been received by the cultivator, from authentic documents in the Dutch and German languages which are in my possession.

Oil of poppies.

In the year 1798, the Society established at Amsterdam for the encouragement of agriculture, being informed that the oil of poppies was cultivated in several parts of *France*, *Flanders*, and *Brabant*, thought it an object of sufficient importance to make more particular inquiry; and they learned from indubitable authority, not only that it was generally used in the place of olive oil, but that several thousand casks of it were exported annually, a large quantity of which was imported into *Holland*, and sold under the name of olive oil, or mixed with it in considerable abundance; and they appealed to several merchants who were members of the Society for the truth of this assertion, without being contradicted.

Made in large quantities and sold as olive oil.

These facts induced the Society to propose three premiums, consisting of a *silver medal* and *ten ducats* each, which were divided into the three following classes.

Premiums proposed by a Society at Amsterdam.

The *first* to the husbandman who should sow not less than half an acre of a *clayey* soil with poppy seed; the *second* on a sandy ground; and the *third* on turf or peat land.

They also offered to the person who shall have cultivated the largest quantity of ground, on the two first species of soil, in the most masterly and advantageous manner, a *gold medal*, value *fifty ducats*, or that sum in money, in lieu of the above premiums.

The

The candidates were to give an accurate statement of the quantity of seed sown per acre; the time of sowing, and of gathering the poppies; the quality of the soil; the manner of procedure in every part of the process; the quantity of oil produced, and the total of the expenses.

In consequence of the above proposals, in the year following (1799) Mr. P. Haak became a claimant; sent in satisfactory specimens of the oil produced, accompanied with testimonies from two respectable physicians, that upon experiments made, it fully appeared that the use of the oil was not in the least prejudicial to the human constitution; and that the oil-cakes were very wholesome and nutritive food for cattle.

Claimant for them.

The Committee appointed to receive this report not only expressed their entire satisfaction at the attestations of the physicians, but they laid before the Society at large an account of the proceedings which had taken place in France, upon the interesting question concerning the noxious or salubrious qualities of the poppy oil, in the following *Narrative*.

So early as in the beginning of the seventeenth century, the oil of poppies was produced in such large quantities, that it gave rise to great and lasting contentions, which rose to such a height, that the government was desired to interfere, and appease the contending parties; either by authorising the use of this oil, or totally to prohibit the consumption, according as experiments should decide whether it contained the noxious qualities ascribed to it, or not.

Proceedings in France to ascertain the good or bad qualities of poppy oil.

The opposers urged the objections already stated: they asserted, that as the capsulum or poppy-head contained juices highly narcotic, this must also be the case with its seeds; that the frequent use of the oil extracted from them exposed the consumer to all the dangerous consequences arising from the too liberal use of opiates; and that they would finally obtund the faculties of the soul; that the oil was of a drying quality, for that it was upon this account it became peculiarly useful to painters: they therefore implored government to confine its uses to this object.

Arguments against it.

The *advocates* maintained that no proofs existed of these pernicious effects; but on the contrary, experience testified

Answered by facts.

that

Used by the  
ancient Ro-  
mans.

that the seeds were peculiarly nutritive both to men and cat-  
tle; they asserted that the ancient Romans, concerning whose  
mental powers there could be no doubt, were accustomed to  
mix the oil and meal of the poppy seed with honey, and  
have it served up as a second course at their tables; and that  
it was on account of its nutritious qualities so well known to  
the Romans, that *Virgil* gives it the title of *rescum, food*, by  
way of preeminence; and that the peculiar qualities of this  
oil rendered it a desirable object of cultivation; and that taste  
was delicate and pleasant, somewhat resembling that of the  
hazel nut; that it continued in a fluid state, exposed to a  
much greater degree of cold than was required to congeal  
the olive oil; that it contained a larger quantity of *fixed air*,  
which preserved it a longer time from being rancid; that in  
these particulars it not only approached to the finest *oil of  
Provence*, but it mitigated the disagreeable taste which that  
oil acquired by length of time; and that the poppy oil de-  
cidedly deserved a preference to every other oil expressed  
from seeds, whether nut, almond, or beech; which, tho' they  
yielded large quantities, soon became rancid: and as there  
was no appearance of its being pernicious in the more exten-  
sive use of it, so valuable a product ought not to be confined  
within the narrow bounds of the painter's use.

Corrects the  
rancidity of  
olive oil.

Consequence  
of a scarcity  
of olive oil.

Things were in this state, without any prospect of accom-  
modation between the parties, when the severe winter of 1709  
overtook the combatants. This damaged the *olive, nut, and  
almond* trees to such a degree, that there was a great scarcity  
of their oils; and they were obliged to have recourse to the  
substitutes, beech and rape, &c. But it was soon perceived,  
that these were far inferior to the oil extracted from the red,  
white, or brown poppy, which had a much nearer resemblance  
to the small portion of the olive oil which the winter had  
spared. This was consequently mixed with the olive oil in  
the proportion of  $\frac{1}{4}$ ,  $\frac{1}{3}$ ,  $\frac{1}{2}$ , without the least opposition. But  
when it was attempted to sell the poppy oil in its pure and  
unmixed state, the opposition became so violent, that the  
Lieutenant-General of the police of Paris resolved, in the  
year 1717, to order the medical faculty of that city to make  
the

the strictest examination concerning this subject, and deliver in their report.

The faculty appointed *forty* of the most celebrated practitioners in medicine as a committee of inquiry, who were witnesses to various experiments accurately made, and whose report was expressed in the following terms: "*cum sensuissant doctores, nihil narcotici, aut sanitati inimici in se continere, ipsius usum tolerandum esse existimarunt;*" that is, they were of opinion, that as there is nothing narcotic or prejudicial to health contained in the oil, the use of it might be permitted.

But this decision was unsatisfactory; and popular clamours determined the court of justice to pass a decree in the year 1718, whereby the sale of poppy oil, whether mixed or unmixed, was prohibited, under a fine of three thousand livres for the first offence. Notwithstanding this prohibition, the sale of the article was clandestinely encouraged and gradually increased until the year 1735, when the court issued a severer decree, enjoining it upon superintendants appointed, to mix a certain quantity of the *extract of turpentine* to every cask containing 100 lbs. of this oil; of which not less than two thousand casks were consumed in *Paris* alone. This attempt to render the use of it impracticable, had no other influence than to annihilate the public sale of the article, but the secret demand for it increased: till at length, in the year 1773, a society of agriculture undertook to examine with the closest attention all that had been alleged, either by writing or otherwise, for or against the general use of this oil. Experiments were repeated in the presence of the most distinguished chymists, with the same result, and the Society presented a petition to the Minister of Police, setting forth the great advantages that would accrue both to commerce and agriculture, by reversing the prohibition.

This petition was put into the hands of persons who vended various kinds of drugs, and who had, as a body, opposed the subject of it, with orders to state all their objections to the *medical faculty*; by these means the faculty became masters of every thing that was urged in the debate. They again made several experiments in the year 1776, and finally confirmed the decree of the faculty issued in 1717, declaring that

Report of a committee of physicians in its favour.

Popular clamours against it.

Final determination in its favour.

that the oil of poppies was not injurious to health, that it did not contain a narcotic power, and that it might be recommended to general use with the utmost safety. The medical faculty at *Lisle* had also made a similar declaration in the year 1773. From that time to the present the cultivation of the poppy has not met with any formidable opposition; and has increased to such a degree both in France and Brabant, that they have been able to export a considerable surplus, to the great advantage of the husbandman, as well as the merchant: and in seasons of scarcity it has been found of the most essential service, in all cases where the use of oils was required. In the northern parts of France, it was used by soap-boilers, as a substitute for other oils, which were extremely dear: and in *Brabant* the oil-cakes are constantly used as food for cattle with obvious benefit.

Oil used by  
soap-boilers.

Oil cakes for  
cattle.

These facts being established, the Committee of Agriculture in Amsterdam proposed the premiums above-mentioned, in order to ascertain whether the experiments made would authorize the cultivation of the article upon a large scale; whether the soil and climate of Holland were beneficial to its growth; whether the quantity or quality of the oil would be similar to the product of France and Brabant; whether the profits would indemnify the husbandman for giving it the preference to other crops; whether the oils could be afforded cheaper than those in common use; and to what purposes either in the arts or manufactories it might be applied.

Deeming it possible, that the narrative of a contest which subsisted the greater part of a century, and in which the advocates for the internal use of the poppy oil were uniformly triumphant, may have some influence in destroying our own prejudices and apprehensions, respecting the pernicious quality of this oil, I shall now proceed to state, in as concise a manner as perspicuity will permit, the most interesting particulars respecting its culture; selected from various foreign publications upon the subject.

Particulars of  
culture.

Soil.

*Soil.* The poppy may be cultivated with success on various kinds of soil. It has been tried on a rich black soil, peat-ground, and sandy heaths, and been productive. Those lands in which the wild poppy abounds the most, are obviously

ously most congenial to its nature. The richer the soil, and the clearer from weeds, the larger will be the crop. It is not so advisable, however, to manure for the poppy, as for the Management. crop preceding it, as it is more exposed to injury by weeds. Hence it succeeds the best after carrots, cabbage, potatoes, &c. The land was generally prepared by the spade, as in planting potatoes; and the finer it is worked the greater the advantage. But when it is cultivated to a great extent, they use the plough. The seed has generally been sown broadcast, the plants thinned, and weeded afterwards, as in the culture of turnips; but in drills it is sown about six or eight inches distant in the rows, which has been strongly recommended; experiments upon a small scale having manifested a superiority in this mode.

*The Kind and Quantity of Seed.* Although the white What kind best. poppy has been chiefly used in *France* and *Brabant*, under the supposition that it produced the finest oil, yet it has been found that various other kinds will answer the purpose as well. It is even asserted that the blue poppy, while it yields the largest quantity of seed, is in no respect inferior in the quality of the oil. Admiral *Kingsbergen*, whose private virtues render him no less a favourite with his countrymen, than his skill and courage as a naval officer, instituted an experiment with different kinds of seeds in the same soil, and he could not perceive any difference in the quality of the oil, while the seeds of the blue poppy yielded considerably more.

The quantity of seed generally used in the broad-cast has Quantity of seed. been after the rate of 2 lbs. to an English acre. In drills a less proportion has been used.

*Time of sowing.* This is from the middle of March to the middle of April. If it be sown much earlier, it is more likely to be choked by weeds; if later, the harvest will be thrown deep into the autumn; and unless the weather be unusually favourable, the seeds will not ripen kindly. Seed time.

*Weeding.* As soon as the plants appear about two inches above the ground, they must be carefully weeded and thinned, Weeding necessary. till they stand about seven or eight inches from each other. The weeding to be repeated as often as it shall appear necessary.

Method of harvesting.

*Harvest.* In the beginning, middle, or end of August, according as the time of sowing has been earlier or later, and the season propitious, the seeds are ripe for gathering the poppy heads. Several methods have been recommended to harvest the crop. At first, the heads or balls were broken off from their stems, gathered together in large quantities, and deposited in a barn, or any other convenient place, in large heaps, in order to dry them. This method was not only tedious but injurious; some of the balls becoming musty, communicated a disagreeable taste to the seeds, and consequently to the oil. Mr. *Poske*, of Zell, in the electorate of Hanover, prefers the following method. He draws the entire plants out of the ground; binds a sufficient number of them at each extremity, and places them against each other in the manner of *wheat-sheaves*; and lets the whole remain in the field for eight or ten days, until they are perfectly dry. It was customary to cut open the capsulum with a knife; he prefers hacking it in two or three places with a *bill-hook*, and asserts that one person may in this manner do more work than ten times the number of hands in the former manner; and that the seeds are more easily evacuated from their cells. But the most convenient and expeditious method is to cut off the poppy heads, as they stand in the field: the reapers having an apron before them, tied up at the corners. In this they collect as large a number as is convenient, and empty them into bushel baskets placed upon a cloth; by which a considerable quantity of seed is saved. The heads are afterwards put into corn sacks, in a competent number to be trodden by men or children in *sabots*, or to be bruised by a mallet or flail: by these means the heads are confined from flying from the stroke, and the seeds preserved from being scattered, and afterwards passed through a sieve of a proper size.

Extraction of the oil.

In extracting the oil, it is of the utmost importance that the mill, press, and bags be perfectly clean and pure. New bags are necessary, as those used for linseed, rape, or any other seed, will communicate an unpleasant taste to the oil. It is advisable to extract the oil as soon after the harvest as possible, as the seeds will yield a larger quantity than if deferred till the spring.

The



The first oil is destined for the use of families. This is <sup>Two kinds of it.</sup> *cold-drawn*, as any degree of warmth injures the flavour. After as much is extracted in this manner as possible, a considerable quantity of an inferior quality is obtained by heating the cakes, and pressing them a second time.

The oil expressed must remain for the space of five or six <sup>Management of it.</sup> weeks before it is used, that it may deposit in a sediment a kind of milky substance that is mixed with it. It must then be poured into another vessel; and this should not be perfectly closed at first, but the opening be covered with a linen cloth, or a pricked bladder, that certain exhalations may pass. Nor should the oil be immediately used after the process is finished, as it continues to improve for a considerable length of time.

That which is first expressed is of a pale colour; is peculiarly bland and soft, has a flavour approaching to that of the almond oil. It is used for sallads and other domestic purposes, either alone or mixed with olive oil. Should the latter be stale or rancid, it will be considerably improved by a mixture of recent poppy oil. It is not asserted that this <sup>The best oil.</sup> oil may be placed in competition with *Provence* or *Italian* oils of prime quality; but that it is superior to the olive oils <sup>Superior to the common olive oil of the shops.</sup> sold in shops, being often used to improve their quality. May I not add, that the inhabitants of this country are somewhat prepared for the culinary use of this oil, by being already accustomed to its taste, though without their knowledge. For since it has long been imported into Holland, and used without suspicion, we cannot suppose that the merchants of this commercial nation are totally strangers to the commodity\*.

The

\* We are told by Mr. C. A. Fisher, in his *Letters written during a Journey to Montpellier, in the year 1804*, "that the oil of *Provence*, which, on account of its purity, mildness, and fine flavour, is famous all over Europe, is exported to *Italy* in large quantities, and was formerly exported to many distant countries. But since the hard winters of 1789, and the following years, so many olive trees have been frozen, and during the Révolution so few planted, that *Aix* (which was the principal seat of its traffic) has now entirely lost its first and most lucrative branch of commerce.

Inferior useful for lamps, and other purposes.

The second-drawn oils are of a deeper colour, and are applicable to all the purposes of the more common oils. This may even be used as lamp oil; and it is alleged, that it does not give off so large a quantity of smোক, and emits a brighter flame.

Cakes equal to linseed for cattle.

The oil-cakes are peculiarly serviceable for feeding and fattening of cattle: being deemed equal to linseed cakes.

Stems make fodder or manure.

All cattle are very fond of it, and eat it with eagerness. This is the constant use of it in Brabant. The stems are sometimes used for fodder, containing a considerable quantity of nutritive oils; or mixed with stable dung and other manures, they enrich their quality.

Profit of this culture.

*Expenses, produce, and profits.* Concerning these articles it will be necessary to be particular, though it is somewhat difficult from a difference in the current coins, measures, &c. I shall state the result of experiments made on three hundred roeden†, about one acre, of a sandy soil, and three hundred roeden of a heavy peat, made by a claimant named S. N. Van Eys. The peat land being low and humid, he was obliged to make deep trenches between the beds. The harvest on this soil was later, the poppy heads were not so dry when gathered, and they shrunk considerably in drying. There was so small a difference in the quantity of seed from these different soils, that no important preference could be given. The sand ground yielded in this instance rather less than the peat land. As the quality of the seeds appeared perfectly similar, he mixed the whole produce together, when he sent them to the oil mills.

Produce of seed.

The produce of the sand ground rather exceeded 13 sacks, that of the *veen* or peat land, was about 12 sacks: together they made 25 sacks, 1 bushel of seed. These yielded oil in the following proportions:—

Two inferences may be drawn from the above information. Our best oils, though imported from *Italy*, are probably of the growth of *Provence*; and it is still more probable that the inferior sorts could not be afforded, even at the present price, without a large mixture of the *poppy oil*.

† The English statute acre is 160 square perches; and the Dutch morge, consisting of 600 roeden, is equal to 300 square perches: so that the difference between a Dutch morge and two acres, is as 300 to 320, the former being only 20 perches less than two acres.

23 sacks

	Mingles*.	Cakes.	
23 sacks which were pressed <i>cold</i> gave ..	271	834	Of oil and cakes.
2 sacks <i>warmed</i> .....	29	56	
834 cakes <i>warmed</i> and pressed gave .....	73		
	<hr/>	<hr/>	
Total oil .....	373	890	
Cakes diminished in a second pressure to			
726 .....	minus,	108	
		<hr/>	
Total of cakes .....		782	

Mr. Van Eys remarks that poppy oil of a very inferior quality is sold retail at one guilder, or 1s. 10d. per mingle or quart, and that mixed with olive oil at a much higher price. However he estimates the cold-drawn at 16d. only, and the second sort at 14d. per mingle. The cakes are valued at 10 guilders, or 19s. per 100. His receipts stand thus:—

271 Mingles, (cold drawn)	}	F. 216	16
at 16d. ....			
102 ditto, (warm) at 14d. ....		71	8
782 Cakes at 10 f. per 100 ....		78	4
		<hr/>	
Total ..	F. 366	8	.. £33 0 8

STATEMENT OF EXPENSES.

Expenses.

To digging, &c. 600 roeden,	}	F. 52	10
at 1½d. per r. ....			
Seed, sowing, weeding, &c. ....		42	19
Harvesting, beating out seed,	}	F. 48	3
&c. ....			
Pressing out the oil, bags, &c.		63	8
		<hr/>	
Total ..	F. 207	0	.. £18 14 0

Receipts .....	F. 366	8	0	.. £33	0	8	
Expenses .....	207	0	0	..	18	14	0
		<hr/>	<hr/>				

Total of Profit .....

This degree of profit upon nearly two acres does not at first appear to be encouraging: particularly if we take into

\* A Mingle is about two pints.

consideration rent of land, taxes, &c., which are not mentioned in the statement. Mr. Van Eys has remarked, that the expenses attendant upon pressing out the oil, in this first essay, were considerably greater than would be experienced in the usual course of business. We may also notice, that the preparation of the ground by manual labour created a difference in the expense, that would prove an equivalent at least to the value of land and contingent charges. But what is of much greater moment is the very low price of the oil, as stated in the above account. That of an inferior quality being valued at somewhat less than 5s per gallon; and the superior at less than 5s. 6d.; whereas common lamp oil is with us sold for 6s. per gallon, and sallad oil of no extraordinary quality at 2s. 6d. or 3s. per pint, or 1l. or 4s. per gallon.

It clearly appears from these facts, that 1s. 6d. per pint, or 12s. per gallon for the prime article *wholesale*, and at least 4s. per gallon for the inferior sort, would be an advantageous price for the purchaser, who would be able to retail it considerably under the current prices of these articles.

Estimate to the  
English farmer.

According to this estimate, the receipts upon 271 mingelen or quarts of the *cold*-drawn would amount to about 40l.; upon 102 quarts of the inferior, to 5l.; and upon 782 cakes, at 1l. per 100, to 7l. 10s.; total 52l. 10s. for one *morge*, which would be after the ratio of 26l. 5s. per acre. The expenses not exceeding 10l. per acre, would yield a clear profit of 1l. 16l.

Should the oil of superior quality answer the description given of it, and be more palatable than the olive oil in common use, 12s. per gallon would perhaps be too low an estimate for our national character. For observation authorizes me to assert it as a serious fact, that nothing has a greater tendency with us to depreciate articles of nutrition, especially if they approach to luxuries, than to render them too cheap. And although we complain universally, that such articles are extravagantly dear, we almost as universally suspect or despise whatever may be purchased at a very reasonable price. But as retailers are both able and willing to obviate this objection, the above statement for the *vendor in wholesale* may be permitted to remain.

But

But there is another important point of view in which this subject may be considered. Successful attempts have lately been made to procure *opium* from the poppy, in no respect inferior to that imported from the East\*; and it is asserted, that although it may be afforded at a very inferior price, the product would afford ample profit to the cultivator. As the opium issues from the *rind*, and the seeds have been proved not to partake of its narcotic properties, an important inquiry presents itself, *whether the poppy may not be cultivated with a view to both articles?* This can only be determined by solving another question, *will the incisions made in the green and unripe capsulum, and the exudation of its juices, prove injurious to the seeds in this advanced state of its growth?* The argument from analogy, which is the only mode until we can obtain facts, appears to favour the negative of the question; not only as there is no immediate correspondence in the qualities of these two parts of the same vegetable, but as many experiments have proved, that by checking the growth, or weakening the vegetative powers of one part of a plant, they are increased and improved in another.

Desirous of obtaining some information concerning this interesting subject, I sowed, in the year 1804, about half a lug of garden ground with the white poppy seed; and when the heads were advanced to a sufficient state of maturity, I scarified the external surface of one portion of them with a penknife, suffering the others to remain entire; and though the exudations were very considerable, there was no perceptible difference in the colour, taste, or size of the seeds; excepting where the incisions passed through the whole integument, which frequently happened from the imperfection of the instrument, and my inexpertness. The seeds which lay nearest to the openings were discoloured by the admission of external air; but the taste of the seed was not injured.

This little experiment served to convince me, that the seeds of the poppy are peculiarly grateful to birds, rats, and mice. The first dexterously made large holes in the lower surface of

Farther advance in the opium to be obtained.

Experiments.

Rats, mice, and birds fond of the seeds.

\* See Transactions of the Society instituted at London, for the Encouragement of Arts, &c. on the mode and advantages attending the cultivation of Opium.—Vols. 14, 15, 16, 18.

the ball, through which the seed fell to the ground; and they thus materially injured a considerable portion of my crop while it was standing; nor were the latter less destructive, when the poppy heads were spread upon the floor of the summer-house in order to dry them. I was however indemnified for this loss, by observing that not a single instance of mortality presented itself to evince the noxious quality of the seed.

If future experiments should prove, that both objects may be pursued by the same culture, scarcely any plan can be devised, which would prove equally profitable to the cultivator, and more beneficial to the community.

General reflections.

I am not so sanguine, gentlemen, as to expect that any person upon reading the above account will immediately resolve to cultivate the poppy to a great extent, as an article of profit. There is often a long repose between the acquisition of knowledge, and the application of it to practical purposes; and in this case I allow that many difficulties are to be surmounted, before the open and avowed consumption of this oil would be sufficiently extensive, to make the production of it an object of sufficient magnitude. But the increasing demand for oils of all sorts in our extensive manufactories, and by the daily improvements in our provincial towns, the immense sums expended in the importation of foreign oils, and most probably of this very oil under a false name, and the daily increase of their price, render a power in reserve most desirable. The time may arrive when the scarcity of oils for domestic use may increase to an alarming degree; in this case the general reluctance to the use of those which are now deemed of an inferior quality may in great measure subside, and we may perhaps rejoice at being supplied at a cheaper rate with that very oil, which passes smoothly among us under the fictitious character of *genuine oil of olives*. I shall at least enjoy the satisfaction of putting it in the power of the public to assist themselves at some future period; and take encouragement respecting the success of my endeavours from the nature of this very plant, which is frequently known to lie for years in the soil in a state perfectly inert, until some favourable circumstances may have promoted a  
vigorous

vigorous vegetation, to the surprise and alarm of the farmer, who has uniformly mistaken it for a *weed*.

N. B. It may be objected, that in the above estimate of the profits, mention is not made of the duties which may hereafter be imposed by government, and become considerable deductions. But this objection has no reference to our first essays. The duties will not become an object until the product of poppy oils shall sensibly diminish the importation of foreign oils; and in that case the wisdom of government will doubtless prevent their rising so high, as to operate as a discouragement to a culture, which would turn the balance of the oil trade in our favour; and should we be able to extend this culture so far as to export the article, a very moderate duty upon both home consumption and exportation may prove more than equivalent to the duties at present collected.

Since writing the above, I am informed by a person who deals largely in foreign oils, that letters from Leghorn announce an alarming deficiency in the last year's product; that the quantity is very small, and of a very inferior quality. This information should operate as an additional motive to the attempt recommended. The injury induced upon olive trees by inclement weather is frequently to such an extent, that it can only be repaired by the slow growth of new plantations. This circumstance gives an astonishing advantage to a substitute, of which, by its being an annual product, the deficiency of the most unfavourable year cannot be equally extensive, and would probably be supplied by the increased abundance of the year ensuing.

Advantage  
from being an  
annual.

## IX.

*On the Use of Tobacco Water, in preserving Fruit Crops, by destroying Insects; and on the Use of the Striped or Rib-band Grass. By Mr. ROBERT HALLETT\*.*

SIR,

Arminster, April 13, 1802.

**B**EING much engaged in mercantile concerns, and having but little time for other pursuits, I have not an opportunity, though extremely fond of my garden, of bestowing the attention to it I could wish; but having made a few experiments with a view of improving the state and bearing of my fruit trees, in which I have succeeded beyond my highest expectations, I hope, as my intention is to benefit the public, I shall be pardoned for troubling you with the present communication of them.

Popular notion of the decline of wall-fruit trees.

The old gardeners with us have long entertained an idea, that our climate has suffered a change particularly inimical to the successful cultivation of Wall Fruit Trees. To this circumstance they attribute the blight, which annually disappoints their hopes, and consider the evil beyond the reach of their skill to remedy.

Common disease of these trees.

The disease to which I have paid regard, is that which affects the trees in the early part of the season, curls up their leaves, often destroys the young shoot, and not unfrequently reduces the tree to a state of weakness, from which it is seldom to be recovered. I have, however, for some years past, successfully combated this baneful complaint, with a preparation easily to be obtained, attended with little expense, and yet certain in its effect.

Tobacco destructive to insects.

The efficacy of tobacco in destroying insects has no doubt been long known, and which I was well aware of. But as the expense attending its use, either for fumigating my trees, or washing them with an infusion, was considerable, and was perhaps the obstacle to its being generally resorted to, I endeavoured to find out the best method of obtaining

\* Papers of the Bath and West of England Society, Vol. X, p. 199.



it in quantities at a cheap and easy rate, of applying it with the least possible waste, and of preparing it so as to be used with safety. On considering the subject, it struck me that the tobacco water used by shepherds, having the power of curing the scab in sheep, might answer my purpose; and having a tobacco and snuff manufacturer very near us, I applied to him, and had the pleasure of finding, that in pressing his tobacco he obtained large quantities of it, which he threw away as useless, except some little which he sold to shepherds. This liquor was exceedingly strong; and, after various trials, I found, that a quarter of a pint, or indeed less if it was tolerably thick, would impregnate a gallon of water with sufficient power to destroy every insect or reptile that felt its influence; and that two gallons of it, when diluted, were enough to wash all my trees, which are about fifty, three times over, and to preserve them throughout the season in the finest health and vigour.

Water of tobacco & snuff manufacturers.

My method of using it has been thus: as soon in the spring as I observe a leaf on any of my trees begin to curl, or be in the least diseased, I prepare my tobacco water as I have before mentioned, viz. to something more than a wine-glass full, or nearly to a quarter of a pint of the liquor, I add a gallon of water; and mix it well together. I then sprinkle the whole of my trees over with this preparation, with a brush such as the plasterers use in moistening their walls, or sometimes by pouring it from a very small watering pot with fine holes; beginning at the top of the tree, and laying it on very gently to prevent waste, which would be considerable, if done with violence or thrown from an engine. Some time after, either in one, two, or three weeks, as I find it necessary, I repeat the sprinkling; and before the fruit gets to a size to be stained by it, I go over them again; and have always found three times sufficient to secure them from the depredations of the insect, which generally preys on the leaves before the shoots are much advanced in strength. I have now practised this antidote for some years; and having during that time taken every opportunity of communicating the knowledge of it, I have at this time the satisfaction of seeing it in such general use around me, that I find our tobacco manufacturer has such a demand for the liquor,

Method of using it.

Destroys insects on all shrubs and vegetables.

Perhaps applicable in hop grounds.

Ribbon grass very prolific.

Excellent food for cattle.

Produce great.

liquor, that he sells it at 1s. 6d. a gallon. It may, however, no doubt, be obtained at a very cheap rate in Bristol, and other places, where much tobacco is manufactured. I would further add, that I have not confined my experiments of its use wholly to fruit trees. Every vegetable and shrub which I have applied it to have been relieved by it, and restored to health, though ever so much injured by the insect tribe. I have no doubt but it would effectually destroy the red spider; and that it may be used with salutary advantage in numerous other instances. And as it is a remedy so cheap, and attainable in any quantity that may be desired, I hope it will prove, on being generally known, beneficial to the public. How far it may be practicable to use it in hop-grounds, or in other extensive views, I cannot say. But I should imagine, as one watering only has a most powerful efficacy; and as the labour of one man would in a day go far in the application of it, that considerable benefit may be derived from it wherever the insect preys.

I cannot dismiss my pen without mentioning a few words respecting another experiment, which my situation prevents my following up to the extent I could wish. I shall therefore briefly state, that observing from time to time the immense produce of an ornamental grass, which I had much of in my garden, and which is distinguished in Miller's Dictionary by the name of Striped or Ribbon Grass; it occurred to me, that Nature in her bounty did not bestow such a prolific quality on this beautiful grass, but for some wiser purpose than merely to gratify the eye. I therefore examined it attentively, and found it to be very succulent, and possessing much sweetness; and on offering it to my horses and cows, that they fed on it very eagerly. I had by me a calf just weaned, which I kept wholly by it for a month; and notwithstanding it had so recently been taken from its mother, this grass supported it admirably, and I had the pleasure of seeing it thrive beyond my most sanguine expectations. I ascertained in the course of the year, that I could cut it three or four times, and that its produce was always prodigious. It takes a very deep root, produces an early spring crop, and, I believe, is an excellent summer food for cattle: in the winter it disappears. I should imagine

gine it may be raised from seed; but I have found it to be easily propagated by dividing the roots into smaller plants, and disposing of them at distances of from four to six inches. In moist ground it spreads rapidly, and soon forms a thick mass of food exceeding any other kind I ever witnessed. Its durability is such, that what I have in my garden, which has been there to my knowledge these twenty years, is as thriving, and yields as much as ever.

Method of raising it.

Very durable.

I had need apologize for trespassing so long on your patience; and shall be happy if these remarks be in any degree found beneficial.

I am, with great respect, Sir,

Your most obedient servant,

ROBERT HALLETT.

[It is presumed the destroying of insects, by sprinkling with tobacco water, is not new, though not generally practised; it may therefore be a public service to recommend the method. But as tobacco is comparatively a dear article, and the fluid above mentioned not easily procured in many situations, it might be a public advantage of no small importance, if our ingenious correspondents would turn their attention to the different tribes of vegetables, with a view to finding among our most pungent and bitter plants, or by a cheap and easy mixture of them, a substitute for foreign tobacco, for such uses. The idea is not without promise.

Perhaps some indigenous plant may be substituted for tobacco.

And further experiments on the striped grass are undoubtedly worthy of being made, in small enclosures near the farmer's or gentleman's house.—EDITOR.]

## X.

*A Second Letter from Mr. ROBERT HALLETT, on the Efficacy of Tobacco Water in destroying Insects infesting Fruit Trees.*

SIR,

*Axminster, Jan. 14, 1804.*

AS you requested in your favour of the 28th ult., that I would communicate to you any further discoveries that might have occurred to me in the use of the tobacco water for destroying

stroying insects on fruit trees, I trouble you with the result of my experiments last year, as it will strongly tend to confirm my representation to you on the subject, in the spring of 1802.

Experiments with tobacco water on fruit trees.

Being from home in the early part of last season, when my trees were putting forth their shoots, I was prevented the opportunity of applying the tobacco water as usual, and found on my return several large peach and nectarine trees, against a west wall in my garden, so wholly diseased, that not a leaf was to be found on them, but which was curled up and full of insects. The trees were then well covered with fruit of nearly the size of a hazel nut; but being destitute of leaves to shelter them, I despaired of saving any, and was apprehensive of losing even the trees. I immediately prepared some tobacco water, of more strength than usual, and applied it by sprinkling it very forcibly from a brush, and in two or three days I could perceive the insects were nearly all killed. I then renewed the application; and in about a week after I had the diseased leaves picked off, and repeated the wash, and found it to be thoroughly effectual. The trees completely recovered, put forth the finest shoots possible, and ripened an immense quantity of fruit in the highest perfection.

Ten years experience of its efficacy.

I have now used it about ten years, and am more than ever satisfied, that nothing can more effectually destroy every insect, that ravages on the leaves of trees and plants of all descriptions. And I conceive its benefits may be invaluable, if applied, as I observed in my former paper, to exterminate in hop plantations those insects, which are so destructive to the plants.

Has been mixed with other things.

It being, as I have mentioned above, about ten years since I resorted to the tobacco water, and recommended it, its use has been gradually extending through this part of the country; and I observe, that some have mixed it with other things, and having found benefit from it, have considered their composition as an important discovery: but I am certain it has been several years longer in use by myself and my particular friends near me, than by any other person; and that it requires not any additional ingredient to render its good effects obvious, whenever properly applied. But I find,

find, that as the demand increases, the tobacconists weaken what they send out; and care must therefore be taken, that it be sufficiently strong when used, which may be known by its giving the water a tolerably brown colour. I have found sometimes a wine-glass full sufficient for a gallon of water; at other times, what I have procured has been so much diluted by the tobacconist, that it has required a pint to give a proper strength to that quantity. I was last summer greatly annoyed by the red spider on those trees that had a direct south aspect. The minuteness of the insect, and being so securely sheltered underneath the leaf, prevented several of my applications from taking a due effect; but on watering my trees with an engine for about ten successive evenings, very forcibly, and immediately after being so watered giving them whilst wet a sprinkling of tobacco water, about three of those evenings, the trees recovered and ripened their fruit very finely.

It ought to be sufficiently strong.

Red spider.

I hope next summer to have it in my power to inform you of the result of an experiment I am now making, with respect to transplanting apple trees from an orchard near me, that is about to be converted to some other purpose. Having purchased as many of the trees as I was desirous of removing, I have newly planted out about forty of them, several of which bare each a hogshead of cider last year, and have done it in many previous seasons. As I have paid great attention to the preservation of them, I have little doubt of success. But as it cannot yet be ascertained, I shall defer enlarging upon the subject till I have the pleasure of addressing you again. In the mean time I remain with great respect,

Apple trees transplanted.

Your most obedient servant,

ROBERT HALLETT.

## XI.

*Remarks on a Pamphlet, lately published by the Reverend S. VINCE, respecting the Cause of Gravitation. By a Correspondent.*

To Mr. NICHOLSON.

SIR,

Mr. Vince's pamphlet on the cause of gravitation.

IT is not long since I first saw Mr. Vince's pamphlet respecting Sir Isaac Newton's conjectures on the cause of gravitation; some parts of it appear to me so erroneous and so injudicious, that I think it right to take the first opportunity of expressing the disapprobation, which the author seems to deserve.

Cannot be the pressure of a medium varying in density as some power of the distance.

After having shown, that the established laws of gravitation cannot be derived from the pressure of a medium, of which the density varies simply as any given power of the distance, Mr. Vince proceeds in these words (P. 21), "It may be supposed, that if the above assumed law of density of the fluid will not answer the required conditions, yet some other law of density, which is compounded of different powers of the distance, may be made to agree with the law of gravity. Let us therefore represent the density of the medium by  $P a^m + Q a^q + R a^s + \&c.$ —Hence, according to the foregoing reasoning (taking only the two first terms of the series), the law of force tending to the sun is  $P \times \frac{2m-mn}{3e} \times a^{\frac{2m-mn}{2}} - 1 + Q \times a^{\frac{2q-qn}{3e}} \times a^{\frac{2q-qn}{2}} - 1 + R, \&c.$  Now these, being different powers of the distance  $a$ , *the whole can never constitute a power which varies*

His mistake pointed out.

as  $\frac{1}{a^2}$ ." On this point the Professor's whole demonstration rests, and it is difficult to imagine how he could have committed so palpable a blunder. We have only to put  $m = 0$ , and  $R = 0$ , in order to show the fallacy of his reasoning: the force will then be respresented according to the expression here laid down, by  $Q \times \frac{2q-qn}{3e} \times \frac{2q-qn}{2} - 1$ , and  $\frac{2q-qn}{2} - 1$  may become  $= -2$  on many suppositions, while

the

the density is expressed by two terms of the first series. But in fact there appears to be another mistake in Mr. Vince's calculations, for instead of  $2m$  and  $2q$ , he ought to have written  $3m$  and  $3q$ ; Mr. Vince says, "let the density be as  $d^m$ , then — the distance of the particles is as  $\frac{1}{d^m}$ ," (p. 17):

Newton on the contrary, says, "particularum distantiarum erunt ut cuborum latera  $AB$ ,  $a b$ , et mediorum densitates reciproce ut spatia continentia  $AB$  cub. et  $ab$  cub." II. 23.

So that if the density be expressed by  $P - \frac{Q}{a}$ ,  $n$  being  $-1$ , which is the power of the distance of the particles of an elastic medium expressing their repulsive force, the law of the derivative force will be represented by  $\frac{2Q}{3e a^2}$ .

These errors in the work of a Professor of Astronomy and Experimental Philosophy, and a Professor in the University of Cambridge, afford no very flattering specimens of the mathematical attainments of this country: and I am sorry to say, that they have been passed unnoticed by one of the most respectable of our reviews, in which a copious account of the essay is inserted. "If the salt has lost its savour, wherewith shall it be salted?" Et quis custodiat ipsos Custodes?

Mr. Vince has thought proper to complain, in his prefatory statement, of the conduct of the Council of the Royal Society, and in particular of that of its President, in declining to publish his essay in the Philosophical Transactions. He says, that it was presented by the Astronomer Royal to the Society, "when the President and one of the Secretaries requested, that the author would withdraw it, and present it again in the November following, as the paper appeared a proper subject for the Bakerian Lecture. It was accordingly withdrawn, and offered again at the time when it was requested to be presented. The paper was then read, and appointed to be the Bakerian Lecture. But before it went into the Committee which is expressly appointed to examine and determine what papers shall be printed, the author was informed, that it was doubtful whether his paper would be published. The circumstances attending this in-

formation led him to suspect, that it would not appear in the Transactions of the Society, and in this he was not disappointed."

The Society  
vindicated.

In the whole of this important history there appears to me nothing whatever, that an impartial person could deem a just cause of offence. The author had more than once before been appointed to give a Bakerian Lecture; and when he offered this paper to the Society, "the President and one of the Secretaries" probably thought it a compliment due to his established reputation, to suggest to him, that it might serve for a Bakerian Lecture, without having gone farther than the title of his paper. He accordingly accepted the compliment and the fee. The paper having been partially read, as all mathematical papers must be, it is natural to suppose, that it was submitted to the examination of some one or more individuals, previously to its being discussed by the Committee of papers, since mathematical demonstrations cannot easily be examined by any large body of persons, however select; and as the opinion of such individuals might easily be expected to influence the determination of the Committee, it is not difficult to imagine, that it might be known beforehand, "that it was doubtful whether the paper would be published," although it may be questioned, whether or no the person who gave the hint acted with perfect discretion.

Farther re-  
marks.

After these remarks on the mathematical parts of Mr. Vince's paper, and this attempt to explain the conduct of the Council of the Royal Society, it will scarcely be necessary to make any comment on the unjust and illiberal insinuation conveyed by the observation, that "Sir J. Pringle, the late *worthy* and *learned* President of the Royal Society, executed the duties of his high office with *great impartiality* and *honour*." Nor shall I enlarge at present on any other objections which might be made to Mr. Vince's essay: what he says respecting the interference of the ethereal atmospheres of the different planets is totally foreign to the question; and some others of his remarks, which are perhaps better founded, have already been stated by Professor Robison, and by other authors: but these are imperfections  
which



which might easily be forgiven, if they were the only errors that have been committed in the essay.

I am, SIR,

Your obedient humble servant,

3 March, 1808.

DYTISCUS.

See *errata* at the foot of the last page.

## XII.

*Farther Experiments and Observations on Potash and its Base.*

*In a Letter from Mr. C. SYLVESTER.*

To Mr. NICHOLSON,

DEAR SIR,

Derby, March 28th, 1808.

IN your Journal for February of this year, I communicated an account of some experiments, made, in company with my friend Mr. James Oakes, with a view to produce the metallic base of the alkalis, discovered by Professor Davy. In consequence of our not having sufficient galvanic power at that time, we did not succeed in separating the globules of metal from the potash, although we produced a substance, which detonated with a bright flash, when presented to water. We have however since repeated the experiments, with increased power, and have completely succeeded in producing the metal, detached from the alkali, in which it is imbedded. The result of these additional experiments I should, according to promise, have communicated for insertion in the succeeding number of your Journal; but, observing, both in your, and other periodical works, that the same result had been obtained by others, I conceived any farther detail unnecessary: as however, we have paid attention to the production of the black matter alluded to in my last, which appearance has not been observed by any other experimentalist, I have thought proper to make a few additional remarks.

Detonating substance produced from potash.

Completely separated from it.

Black matter accompanying it.

After repeating the experiments several times, we ascertained the curious fact, that the black matter was formed at the copper end only.

Did not appear  
to be carbon.

the wire coming from the copper end of the apparatus only. Suspecting from its blackness, that it might be carbon, we collected and dried a portion of it, which was subjected to the test of nitre in a platina spoon; we did not, however, observe the slightest indication of the presence of that inflammable body; but, since the quantity operated upon was very small, no *absolute* conclusion can be drawn from the experiment.

Cannot be an  
oxide of the  
base.

That it cannot be an oxide of the alkaline base containing less oxygen than constitutes alkalinity, appears from its remaining permanent in water, for several weeks after the experiment; a circumstance, which could not take place with any substance having so great an affinity for oxygen: It is equally evident, that it cannot be an oxide with more oxygen, because it is formed at the copper end of the battery. Is it any foreign matter, derived from the vegetable, whence the potash has been obtained?

Alkali formed  
by incineration  
of vegetables:  
but in what  
state does it  
exist in them?

It is a well ascertained fact, I believe, that vegetables furnish a greater quantity of alkali by incineration, than is to be found in their composition previous to the process. It would, therefore seem, that alkali is formed during the combustion, and that all of it does not exist in the vegetable in the state of alkali: nor does it exist in the state of its base, since this substance would be incompatible with the presence of the vegetable fluids. In what form, then, does it exist?

Alkalis com-  
pounds, and  
earths perhaps  
the same.

In consequence of the numerous confirmations of Mr. Davy's discovery, we may with some confidence conclude, that the alkalis ought no longer to be considered as simple bodies, and it is exceedingly probable, that the earths are also compounds of oxygen, united to certain inflammable bases; a circumstance long ago suspected by Lavoisier, and others. The nomenclature and systematic arrangement of chemistry therefore must undergo an alteration, particularly that part of the former, which embraces oxygen and its compounds; since we find that substance to be as well the principle of alkalinity, as of acidity. Under the new arrangement all ponderable matter will most likely be divided into two classes of simple bodies, namely, oxygen and inflammable

Chemical no-  
menclature and  
system require  
a change.

New arrange-  
ment.

flammable bodies; from which will result the following classes of compounds, first, all those formed by the union of inflammable bases, and secondly, the simple and compound oxides. The simple oxides will include all oxides, properly so called, the acids, the alkalis, and the earths; under the compound oxides will be comprised the various genera of neutral salts.

I am, Sir,

Your most obedient humble Servant,

CHARLES SYLVESTER.

A spontaneous explosion of the alkaline base, mentioned by your Correspondent, page 146 of the present volume, occurred to us; the effect of which fractured the glass tube in which the experiment was made.

Erratum. Vol. XIX, page 157, line 7, for "cock," read, "cork."

### XIII.

*An Account of the Measurement of an Arc on the Meridian on the Coast of Coromandel, and the Length of a Degree deduced therefrom in the Latitude  $12^{\circ} 32'$ . By Brigadier Major WILLIAM LAMBTON\*.*

IN a former paper which I had the honour to communicate to the Asiatic Society, I gave a short sketch of an intended plan for establishing a series of connecting points commencing from the Coromandel Coast, and extending across the Peninsula; but that paper was only meant to convey a general idea of the principles on which the work was to be conducted; a more circumstantial and scientific account, it was thought, would be more to the purpose, when I had the means of putting the plan in execution, and detailing the particulars. Since that time I have received a most complete apparatus, which has enabled me to proceed on the

Plan for measuring an arc in India.

\* Abridged from the Asiatic Researches, vol. VIII.

scale I originally proposed, and what is here offered is the beginning of that work, being the measurement of an arc on the meridian, from which is deduced the length of a degree for the latitude  $12^{\circ} 32'$ , which is nearly the middle of the arc.

*An account of the base line.*

The place of  
the base.

Some time had been taken up in examining the country best suited for this measurement, and at length a tract was found near St. Thomas's Mount, extremely well adapted for the purpose, being an entire flat, without any impediment for near eight miles, commencing at the race ground, and extending southerly. This being determined on, and the necessary preparations made, it was begun on the 10th of April, and completed on the 22d of May, 1802.

Instruments  
employed.

I had expected a small transit instrument from England, for the purpose of fixing objects in the alignment, and for taking elevations and depressions at the same time; but that instrument not having arrived, I thought it unnecessary to wait, particularly as the ground was so free from ascents and descents; I therefore used the same apparatus as I had formerly done, viz. the transit circular instrument, and the levelling telescope fixed on a tripod with an elevating screw in the centre. In all horizontal directions, this telescope fully answers the purpose, and as there has been no deviation from the level to exceed  $26' 30''$ , excepting in one single chain, and those cases but very few, I feel entirely satisfied as to the accuracy of the whole measurement.

The chain.

The chain which was made use of is the one I formerly had; and I was fortunate enough to receive another from England, made also by the late Mr. Ramsden, and this having been measured off by the standard in London, when the temperature was  $50^{\circ}$  by Fahrenheit's thermometer, it afforded me an advantage of correcting for the effects of expansion, a circumstance in which I was by no means satisfied in the former measurement. In order, therefore, to have a standard at all times to refer to, I have reserved the new chain for this purpose, and used the old one only as a measuring chain, by which means I can always determine the correction for the wear.

There

There were only four angles of depression, and two of elevation, taken in the whole length of the base; the rest were all horizontal measurements, and many of them consist of a great number of feet before it became necessary either to sink or elevate the coffers; when that was done, great care was taken to mark the termination of the preceding measurement; and for that purpose a small tripod was used in the shape of a T, with three iron feet to run into the ground, the straight side of which T was placed in the line. Another small T was made with its top also parallel to the line, and fixed upon the large one so as to slide to the right or left, and upon that again was a long piece of brass made to slide out at right-angles to the top of the T; in the middle of this brass a mark was made, which was brought to a plumb line let fall from the arrow, and the height from the brass to the arrow was noted down; when the succeeding chain was laid, which was to commence the new level or hypotenuse, the arrow was then brought so, that a plumb line, freely suspended, would coincide with the mark on the brass slider. The height of that chain above the brass was likewise taken; by comparing these two heights the elevation or depression of the new commencement was determined; and these differences noted in the seventh and eighth columns of the table. The differences of the two aggregates contained in these columns, when applied to the ascents and descents, will therefore show how much one extremity of the base is above the other. The height of the chain at the commencement and termination of the whole was of course taken from the ground.

All the other particulars respecting this measurement are nearly the same as that in the Mysore country, a full account of which has been published in a former volume of the Asiatic Researches. Some little alterations have been made in the coffers; that is, they were all of the same length, and the whole together about ninety-six feet, so as to give room for the pickets with the brass register heads. Their sides continued to the ends, and their depth on each side was the same, for the purpose of being turned every day, that they might not fall into a curve by their own weight and that of the chain. I also used tripods with elevating screws

Coffers.

in

in the centre, for supporting the coffers, making no other use of pickets than for the drawing and weight posts, and for carrying the register heads. The top of each stand or tripod was a thick circular piece of wood, fixed firmly to the end of the elevating screw, and a slip of board was fastened across the circular top, screwed into the centre, and allowed to turn round. When the ends of two coffers were placed on the top piece, this slip of board was admitted into the under part of each, and prevented their sliding off, a precaution that was very necessary on account of the high winds.

Commence-  
ment of the  
base.

The point of commencement of the base was had by dropping a plummet from the arrow of the chain suspended by a silken thread. A long but small bamboo picket had been driven into the ground, till its top was level with the surface, and the cavity of the bamboo was such as just to receive the plummet, and when the first chain was in the coffers, drawn out by the weight at the opposite end, it was adjusted by the finger screw at the drawing post in such a manner, that the plummet might hang suspended over the cavity of the bamboo, while the thread was applied to the arrow. This was done within the observatory tent, that the plumb line might hang freely without being disturbed by the wind. The bamboo picket was preserved with great care during the time I was observing for the latitude, and was then protected under the frame of the zenith sector. When the tent was removed, a large bamboo flag-staff was erected, the cavity of which covered the picket, and in this state it remained until the measurement was completed.

Termination of  
the base.

At the termination of the base, being the end of a chain, one of the large hooped pickets was driven into the ground till its top was on a level with the coffers and under the arrow of the chain. The opposite end being adjusted by the finger screw, the arrow at the leading end was nearly the centre of the picket. A mark was made, and a small round headed nail was driven in till it was level with the surface. The chain was again applied, and the arrow cut the centre of the nail. The picket had been driven upwards of two feet and a half into very hard clay.

The extremi-

But that these extremities may be preserved, in case they

may hereafter be referred to, I erected small masses of hewn stone eight feet square at the bottom and four at the top, the axis of these masses being made to pass through the points of commencement and termination, and in order that this might be correctly done, the following method was used.

I marked out the foundation of the building, so that the picket might be as nearly in the centre of it as possible. The earth was dug about a foot deep, reserving a space round the centre untouched. After the foundation was brought to a level with the surface, the first tier of stones was laid, being one foot in height. The inner part was then filled up with stones and mortar, taking particular care at the same time, that the centre was not touched. The next tier of stones was then laid, which was six feet square and one foot high. This also was filled in with great care, and some cement and bricks put gradually round the picket. After that the last tier was laid, which was four feet square, and also one foot high. When these stones were firmly fixed, small silken threads were drawn across each other in the diagonals of the square. A plummet (pointed) was then suspended from the point of intersection of these threads, and they were so moved, that the point of the plummet coincided with the centre of the nail in the picket. The position of these threads being determined, marks were inserted in the stone. The cavity was then filled up, and a square thick stone was fixed in the middle of the mass, having a circular place of about four inches diameter, sunk half an inch deep, and the centre of which was marked by a point. This point, by moving the stone and again applying the silken threads, was brought to coincide with the point of intersection, and then it was firmly fixed and pointed.

Structure of  
the truncated  
pyramid at the  
end,

Precisely the same kind of building was erected at the beginning of the base, but, in place of having a picket in the centre, four large hooped ones were driven into the ground, forming a square of about ten feet, the small bamboo picket being intended as the centre. Silken threads were then drawn across from the diagonal pickets, and so moved, that the plummet first used, suspended from the point of intersection of the threads, might drop into the cavity

and of that at  
the beginning  
of the base.

vity

vity of the bamboo. That being adjusted, lines were drawn on the tops of the pickets where the threads had been extended. The building was then erected, and the centre both of the second and last tier was marked by the intersection of those threads, when applied to the marks on the pickets.

Such has been the mode of defining the extremities of the line. The buildings are well built of stone and some brick, and will remain for years, if not injured by acts of violence. They are intended to receive an instrument on the top, and the points are points of reference, if it should ever be thought necessary to have recourse to them.

*Expansion of the chains, and their comparative lengths.*

Comparison of the chain used with a new standard.

As I wished to be satisfied with respect to the expansion of each of the chains, and their comparative lengths, I made a course of experiments for both purposes. I had accordingly the coffers arranged near the ground, that the drawing and weight posts might be driven deep and firmly fixed. Both the chains were then put into the coffers, and the comparisons made as follows :

April 10, at 6 P. M. the temperature by a mean of five thermometers was  $85^{\circ}6$ .

Three comparisons were made, and the old chain exceeded the new one, nine divisions of the micrometer screw.

April 10, at 6 A. M. the temperature by a mean of five thermometers was  $79^{\circ}$ .

Four comparisons were made, and the old chain exceeded the new one nine divisions. Therefore at the commencement, the old chain exceeded the new one in length, nine divisions of the micrometer.

May 23. After the base was completed, the temperature by a mean of five thermometers, was  $86^{\circ}$ .

By a mean of five comparisons,  
the old chain exceeded the  
new one ..... 10.65 divisions.

24. The temperature by a mean of five thermometers was  $84^{\circ}$ .

And



And a mean of six comparisons	gave the excess of the old chain above the new one. . . .	11.08 ditto.
25. The temperature was 87°.		
And a mean of two comparisons,	gave . . . . .	11.00 ditto.
		10.86 ditto.

Hence it appears, that, at the conclusion of the base, the old chain was longer than the new one 11 divisions of the micrometer very nearly, so that it had increased, from being in use, 2 divisions, or  $\frac{2}{100}$  of an inch.

These experiments were made with great attention, and when either chain was stretched out by the weight, it was carefully brought into a line in the coffers.

As I had reserved the new chain for a standard, and knowing the temperature at which it had been measured off in London, I considered it an object to determine its rate of expansion and contraction compared with the thermometers which had been in use in measuring the base, since these were but common ones, and might probably differ from those made use of by General Roy and others, who had determined the expansion of metals by the pyrometer; and I was farther induced to do this, from seeing the great variation among them, when the degree of heat became above one hundred, which it generally was in the coffers every day before I left off. To avoid those irregularities arising from the expansions being checked by the resistance from the pressure on the coffers, I chose the times of sunrise, and from one to two o'clock, P. M. for making the observations. Sunrise in India is generally the coolest time of the twenty-four hours, and the chain had during the night, on account of the uniform state of temperature, full time to free itself from any resistance. At the hottest part of the day likewise there is a considerable time when the thermometers are nearly stationary, which will afford time for the resistance in the coffers to be overcome; and it is necessary to pay particular attention to this circumstance, for the chain will be perceived to lengthen often for nearly half an hour after the thermometers are at their highest.

Rate of expansion.

Time allowed to obviate effects of friction.

I had

I had made a great many experiments prior to the measurement, but found great irregularity, partly from not attending sufficiently to the above circumstance, and partly from the unsteadiness of the drawing post, notwithstanding it was driven deep into very hard ground, and secured, as I thought, by having large stones pressed close on each side of it. To remedy this latter inconvenience, I had a staple driven into a brick wall, into which the iron was fixed with the adjusting screw for the chain, after which I perceived a perfect coincidence with the arrow and mark on the brass head, except what arose from the trifling expansion and contraction of the iron which held the chain. I then began a new course of experiments on both the chains, and the results were as follows.

*Experiments for determining the expansion of the new Chain.*

Expansion of  
the standard  
chain.

1802.	TIME.	Mean of 5 Thermome- ters.	Change of Tempera- ture	No. divi- sions.	Total ex- pansion and con- traction.	Total due to 1°.	Remarks.
Month.							
June 4.	2 P. M.	116.4			<i>Inches</i>	<i>Inches</i>	
5.	☉ rise.	83	33.4	51	.245157	.00734	Weather clear and windy during the whole of these experi- ments.
	2 P. M.	123.8	40.8	64	.307648	.00754	
6.	☉ rise.	82.5	41.3	64	.307648	.00744	
14.	☉ rise.	80	39.1	60	.288420	.00737	
	2 P. M.	119.1	37.7	57	.273999	.00727	
15.	☉ rise.	81.4	40.5	63	.302841	.00747	
	2 P. M.	121.9	42.2	66	.317262	.00752	
16.	☉ rise.	79.7			Mean	.00752	

*Experiments*

*Experiments for determining the expansion of the old Chain.*

.1802. Month.	TIME.	Mean of 5 Thermometers	Change of Temperature.	No. divisions	Total expansion and contraction.	Total due to 1°.	Remarks.	Expansion of the measuring chain.
June 8.	☉ rise.	83·5						Expansion of the measuring chain.
	2 P. M.	110·3	26·8	42	·201894	·00749	Cloudy weather and high winds du- ring the whole of these ex- periments.	
9.	☉ rise.	85·2	25·1	40	·192280	·00766		
	1 P. M.	110	24·8	39	·187473	·00755		
12.	☉ rise.	80·2						
	2 P. M.	108·1	27·9	42	·201894	·00724		
13.	☉ rise.	83·3	24·8	38	·182666	·00736		
	2 P. M.	111·3	28	42	·201894	·00721		
14.	☉ rise.	80	31·3	46	·221122	·00706		
Mean						·00737		

It appears from these results, that the expansion due to 1° of the thermometer is less than what has been allowed by experiments made in England; but this might arise from the thermometers, as they were such as could be purchased in the shops, and therefore most probably not of the best kind. Great care, however, was taken to watch the moment when they stood the highest, and though they varied from one another considerably at that time, yet that variation was generally the same in equal temperatures.

Expansion less  
than allowed  
in England.

*(To be concluded in our next.)*

SCIENTIFIC NEWS.

*Wernerian Natural History Society.*

A Society has been established at Edinburgh for the cultivation of the different branches of natural history. It has been denominated the *Wernerian Natural History Society*, in honour of Werner. The following gentlemen have been elected office bearers.

Wernerian  
Natural History  
Society at  
Edinburgh.

PRESIDENT,

## PRESIDENT,

Robert Jameson, *Esq. F. R. S. Prof. Nat. Hist. Edin.*

## VICE PRESIDENTS,

Wm. Wright, *M. D. F. R. S.* | John Barclay, *M. D. F. R. S.*  
 Rev. T. Macnight, *F. R. S.* | Tho. Thompson, *M. D. F. R. S.*

Patrick Walker, *Esq. Treasurer.*

Pat. Neil, *Esq. Secretary.*

Council,—nine in number, viz. The above office bearers, with Charles Anderson, *Esq. F. R. C. S.*; and Lieut. Col. Fullerton, of Bartonholm. Sir Joseph Banks, *President of the Royal Society of London*; Richard Kirwan, *Esq. President of the Royal Irish Academy*; and Professor Werner of Freyberg, were elected honorary members. The following foreign members have been elected. Professor Karsten, Berlin; Professor Klaproth, Berlin; Mr. Von Humboldt, Berlin; Mr. Von Buch, Berlin; Mr. F. Mohs, of Stiria; Mr. Herder, Mr. Friesleben, and Mr. Meuder, of Saxony.

Two orders of veins of minerals.

At the last meeting of the Wernerian Natural History Society, Professor Jameson read a description of contemporaneous or enclosed veins. He divided veins into two classes. The first class comprehends *true veins*, the second *contemporaneous or enclosed veins*.

True veins characterized.

True veins, he remarked, excepting when the strata or beds are of uncommon thickness, traverse many different strata or beds; and, although we do not always observe them open at the surface of the earth, they invariably open at the surface of the formation or series of formations they traverse; thus the outgoings or openings of certain metalliferous veins, that traverse clay, slate, and mica slate, are sometimes covered by the second porphyry formation.

Contemporaneous or enclosed veins.

Contemporaneous or enclosed veins are in general confined to individual beds or strata, and are completely enclosed in them, or in other words wedge out in every direction in the bed or stratum in which they are contained. After detailing the various characters of true and contemporaneous veins, the Professor next described the contemporaneous veins

veins that occur in different great rock-formations, beginning with granite, and ending with the newest flætz trap formation. He next explained the mode of formation of these veins. When describing the contemporaneous veins, that occur in gneiss, he remarked, that certain varieties of venigenous gneiss bear a striking resemblance to granite, and hence have been frequently confounded with it. This led him to point out the characters by which true granite veins are distinguished from veins of granitic gneiss.

As connected with this part of the subject he examined the facts, on which the Huttonian theory of granite is founded; and proved by a detail of his examination of the appearances described by Dr. Hutton, Professor Playfair, and others, that the supposed granite veins, shooting from subjacent granite into superincumbent rocks, are merely veins of granitic gneiss accidentally in contact with granite.

Remark on the Huttonian theory.

Professor Jameson has just published the third volume of his System of Mineralogy, under the title *Elements of Geognosy*. The contents of this valuable work are as follows. Chap. I, Description of the surface of the earth; chap. 2, Effects of water on the surface of the earth; chap. 3, Internal structure of the earth; chap. 4, General account of the different formations in regard to their succession and stratification, and this illustrated by a short description of the Hartz and Saxon Erzebirge; chap. 5, Theory of the diminution of the waters of the globe—Description of overlaying formations—An investigation of the original contents of the waters of the globe, during the different periods of the earth's formation. The division of rocks into five classes; chap. 6, class 1, Primitive rocks; chap. 7, class 2, Transition rocks, chap. 8, class 3, Flætz rocks; chap. 9, class 4, Alluvial rocks; chap. 10, class 5, Volcanic rocks; chap. 11, Mineral repositories; chap. 12, Relative age of metals, and general inferences. These are followed by a table of 32 pages, containing the relative antiquity and geognostic relations of simple minerals: also an extensive table of the most

Professor Jameson's Elements of Geognosy, or 3d vol. of his System of Mineralogy.

most remarkable heights of mountains, hills, and lakes in different parts of the world, and a table of volcanoes. The volume is concluded with a series of notes explanatory of passages in the text, and referring to the Huttonian theory of the earth.

### TO CORRESPONDENTS.

*It would be highly gratifying to the author of this Journal, to publish a complete Index of the whole to the present time; and there is no motive for hesitation, but the probability, that the heavy expense attending it might not be indemnified in the actual sale. It is, however, under consideration.*

*The Meteorological Journal will appear in the first number of the next volume; and every attention that circumstances can admit will be paid to the suggestions received in the favour from an anonymous correspondent.*

*The error of a word which he notices, is of the press, and we trust that errors of this description are not very frequent with us.*

*The letter from Mr. Garnett, of New York, was received too late for insertion this month, but will appear in our next number. His favours will be always acceptable. The enclosure to the Astronomer Royal was immediately forwarded.*

### ERRATA.

Page 304, l. 10 from bottom, read

$$P \times \frac{2m-mn}{3e} \times a^{\frac{2m-mn}{2}-1} + Q \times \frac{2q-qn}{3e} \times a^{\frac{2q-qn}{2}-1} + R, \&c.$$

l. 7 from bot. for  $\frac{1}{a^2}$  read  $a^{\frac{1}{2}}$

line 2 from bot. read  $Q \times \frac{2q-qn}{3e} \times a^{\frac{2q-qn}{2}-1}$

A

# JOURNAL

OF

NATURAL PHILOSOPHY, CHEMISTRY,

AND

THE ARTS.

---

SUPPLEMENT TO VOL. XIX.

---

## ARTICLE I.

*Remarks on the total Eclipse of the Sun, June 16, 1806; with some new Methods of finding the Sun or Moon's Meridian Altitude, and the approximate Time, by Altitudes taken near the Time of Noon. In a Letter from J. GARNETT, Esq. Editor of the American Nautical Almanac.*

To Mr. NICHOLSON.

SIR,

I AM a constant reader of your valuable Journal, but have only lately received your No. 75, in which, from the proceedings of the French Institute, you have copied Mr. Ferrer's observation of the total eclipse of the sun at Kinderhook. As I assisted him in the observation, I beg leave to remark a considerable error, made by you or the French Institute, which places Kinderhook upward of 7<sup>h</sup> to the eastward of Paris, instead of upward of 5<sup>h</sup> to the westward.

	h.	m.	s.
You mark the time of the conjunction	11	45	33 *
whereas it was, apparent time	-	23	25 33.2,

as you will perceive by the printed calculation enclosed.

Before

\* I copied this time from the *Magazin Encyclopédique*, and on referring to the *Journal de Physique*, where there is likewise a brief

VOL. XIX.—SUPPLEMENT.      Y

Limb of the moon illuminated before the end of the eclipse.

Before the end of the total eclipse, the west limb of the moon began to be illuminated, and the light increased so rapidly, that I at last mistook it for the sun's egress, and called the time to Mr. Ferrer: but he saw the error, and still kept his eye to the glass, when the first solar ray nearly blinded him.

Whence this? Whence could proceed this illumination? from a lunar or solar atmosphere?

American Nautical Almanac.

In the American Nautical Almanac, which I have published here since 1803, I have given the moon's declination for every six hours, instead of twelve; which I did before I knew it was done in France, and for the same reason.

I am, with the greatest esteem,

Sir,

Your obedient Servant

JOHN GARNETT.

*New York, North America.*

*February, 6, 1808.*

brief notice of it, I find the time set down  $11^h 25' 33''$ . This is evidently according to the popular, not astronomical notation of time; and in a work intended for the general reader, as well as the astronomer, it was perhaps preferable. It appears however to have occasioned the error of the French reporter of the proceedings of the National Institute.





**ELEMENTS of the TOTAL SOLAR ECLIPSE, of June 16th, 1806, as observed at Kinderhook south landing, on the Hudson River, in latitude 42° 23' 3" N.; and longitude 73° 48' 37.5" W. from Greenwich.**

Elements of the total solar eclipse, of June 16, 1806.

	First.		Second.		Third.		Fourth.	
	h.	m. s.	h.	m. s.	h.	m. s.	h.	m. s.
Mean times of observations -	21	49 37	23	8 2,	23	12 39	0	33 45.
Apparent times	21	49 31,1	23	7 55,4	23	12 32,4	0	33 37,7
Longitude by estim. West -	4	55 15						
Time at Greenwich	2	44 46,1	4	3 10,4	4	7 47,4	5	28 52,7
Sun's R. Ascen. N. Alman. -	5	36 48,6	5	37 2,1	5	37 3,1	5	37 17,1
R. Ascen. Med. Cæl. $a+b$ (-24h)	3	26 19,7	4	44 57,5	4	49 35,5	6	10 54,8
The same in degrees -	51°	34' 55"	71°	14' 22"	72°	23' 52"	92°	43' 42"
Altitude of Nonagesimal -	67	20 24	70	18 4	70	24 51	71	13 55
Longitude of Nonagesimal -	60	5 1,5	75	20 39	76	14 50	92	8 2
Moon's tr. long. * N. Al.—1' 5", 3	83	45 50,2	84	33 46,5	84	36 36	85	26 13,1
Sun's tr. long. * N. Al.—5", 3	84	40 46,0	84	43 53,1	84	44 4,1	84	47 17,7
Moon's tr. long.—Sun's true long.	—	54 55,8	—	10 6,6	—	7 28,1	+	38 55,4
Moon's tr. dist. from Nonagesimal	23	40 48,7	9	13 7,5	8	21 46	—	6 41 48,9
Moon's Hor. Par.—Sun's Hor. Par.	0	60 0,8	0	60 2,3	0	60 2,4	0	60 3,9
Moon's Parallax in Longitude	+	22 34,5	+	9 12,29	+	8 21,79	—	6 44,59
Moon's app. dist. from Nonages.	24	3 23,2	9	22 19,79	8	30 7,79	6	35 4,31
Moon's ap. long.—Sun's ap. long.	—	32 21,3	—	0 54,31	+	0 53,69	+	32 10,81
Moon's tr. lat. N. Alm. North	0	24 56,35	0	20 30,66	0	20 14,98	0	15 39,67
Moon's Parallax in Latitude	—	23 5,49	—	20 13,99	—	20 7,44	—	19 23,17
Moon's Appar. dif. Latit. N. A.	Nor.	1 50,86	N.	0 16,67	N.	0 7,54	Sou.	3 43,5
Moon's aug. sem.—2",977 infl.	0	16 38,373	0	16 40,253	0	16 40,283	0	16 40,803
Sun's sem. N. A.—1,623 irrad.	0	15 44,457						
Moon's relat. vel. in 12h. from Sun	6	51 23,8	6	51 45,3	6	51 46,7	6	52 8,4
Moon's do. between obs. and conj.	6	51 37	6	51 47,8	6	51 48,4	6	51 59,3

\* These are the supposed errors in the tables of the Sun's and Moon's longitude, deduced from the observations with the estimate longitude of Kinderhook; but a corresponding observation at Greenwich will be more accurate: allowing for these, the time of the true conjunction at Greenwich by the Nautical Almanac will be 4h. 20m. 50.5s, when the relative velocity in twelve hours was 6° 51' 50.14".



N. B. The number of seconds in table XVIII may be found independent of the table, thus; add the constant log. 0.29303, the log. cosine of latitude by account, and log. cosine of declination together; and subtract the log. sine of the *difference* or *sum* of the latit. and declin. according as they are of the *same* or *different* names; the remainder will be the logarithm of the number of seconds in table XVIII.

Method of finding the meridian altitude and approximate time from two altitudes.

If to this log. be added twice the log. of any number of minutes less than 30 minutes, the sum will be the logarithm of a number of seconds; which added to the altitude, taken at that number of minutes from noon, will give the *meridian altitude*, the same as above.

### REMARKS.

1. If the number of seconds that the sun or moon's declination changes in one minute, be divided by twice the number of seconds found from table XVIII, the quotient in minutes will be the *Correction of Noon*, from equal altitudes, for any less interval of time than twenty minutes.

2. This *correction* is also the time, in minutes, between the sun and moon's *greatest altitude* and *meridian altitude*.

3. And if *this correction* be multiplied into half the number of seconds that the declination varies in one minute, the product will be the *difference*, in seconds, between the sun or moon's *greatest* and *meridian altitude*, which, respecting the moon, is sometimes considerable; therefore as the altitude found by this problem  $H+A$  is strictly the *greatest*, not the *meridian altitude*, and the time  $F$  and  $G$  is the time before and after the *greatest altitude*: this product should be applied as a correction to reduce the moon's altitude when thus found, to her true meridian altitude, when that is required.

See also Remark 2 on the page next but one.

**PROBLEM II.**

From three altitudes taken at equal intervals

Given Three Altitudes of the Sun's Limb, taken near Noon, at equal Intervals of Time, to find the Meridian Altitude.

Example.—Suppose that three altitudes of the sun's lower limb were taken at 15 minutes interval near noon: as follows.

Time by watch h. m.	Altitudes. ° ' "	Differences. ' "	Sum or differ. ' "
11 56	A   59 55 0	B ∞ A   a   3 40	b ± a = E 22 20
12 11	B   59 58 40	C ∞ B   b   18 40	(When B is the greatest altit. +, otherwise - ∞)
12 26	C   59 40 0	C ∞ A   D   15 0	

Then 2E : ½D :: ½D : correction of altitude B for meridian altitude.

And 2E : ½D :: double interval : time from noon of alt. B (before noon when A is less than C) which may be worked by the pen, Gunter's scale, or thus, by prop. logarithms.

2 E	44 40	P. L.	e	.6053	(When A is less than C, B is before noon.)
½ D	7' 30"	P. L.	d	1.3802	
d - e	-	-	f	.7749	
f + d = G	1 16	P. L.		2.1551	B + G = Meridian Altitude 59° 59' 56" (of sun's lower limb.)
double int.	30m.	P. L.	h	.7781	
f + h = I	5m. 2s.	P. L.		1.5330	I = Time after noon of alt. B, 5m. 2s.

**PROBLEM**

PROBLEM III.

Given Three Altitudes of the Sun's Limb, taken near Noon, at unequal intervals of Time; to find the Meridian Altitude.

Example.—Supposing the following altitudes and the intervals 29m. and 42m.

Interv.	Altitudes.	Diff.	Int.			D
m.	A 54°	7	$128\frac{1}{2} \div 29$	a	$\frac{c}{p+q}$	d 8.5060
p 29	B 56	$15\frac{1}{2}$	$90\frac{1}{2} \div 42$	b		
q 42	C 57	46	$1\frac{1}{2}$	$b \pm a$	$D \times p$	E 0.928
1§ If B is greatest +, otherwise ∞.						F 5.359
2§ When B or C is greatest +, or otherwise ∞.						G 2.680
H=minutes bef. noon of alt. A=1h. 23,6m.				$g - d$		H 83,6m.
A + I = Meridian Altitude 57° 51'				$h + g$		I 224'
						log. g 0.4281
						log. h 1.9221
						log. i 2.3502

REMARKS.

1. When E exceeds a; A and B are on different sides of noon, and it is always to be preferred to have an altitude on each side of noon.
2. The nearer the sun passes the zenith, the nearer should the observations be taken to noon: generally the greatest horary angle should not exceed half the meridional zenith distance; but the differences between the observed altitudes should be sensibly greater than the errors which may be committed in the observations, and the intervals of time may be from 10 to 30 minutes.
3. Without logs.  $G \div D = H$ ; and  $H \times G = I$ . If the altitudes are taken to exact minutes of time, as in all these examples, it will make the operation more easy.
4. To prove the operation, if  $D \times q$  be put for E, and  $b \pm E$  for F (which is the same as making C the first term) the merid. alt. will be  $C \pm I$ , the same as before, if rightly done; In the second example, I would be found 5' the correction of altitude C.

and from three altitudes taken at unequal intervals.

## II.

*An Inquiry into the Causes of the Decay of Wood, and the Means of preventing it. By C. H. PARRY, M. D.\**

Highly important to preserve wood from decay.

**T**HE power of wood in different forms to supply luxury, to promote science, and to guard and prolong human life, has made the means of preserving it from decay highly interesting to mankind. With this view various premiums have been offered by this and other æconomical societies. The object of the following discussion is to suggest the best means of prevention, chiefly by inquiring into the nature and sources of the evil against which it is intended to guard.

Two causes that destroy it.

Wood, when killed by being separated from its root, is subject to gradual destruction from two causes,—rotting, and the depredations of insects.

Two kinds of rot;

Of the rot there are two supposed kinds, as they affect wood, first, in the open air, or secondly, under cover.

wet,

The first is that which in the terms of our premium, Class VII, No. 3, is said to occur to “barn and other outside doors, weather-boarding, gates, stiles, and implements of husbandry:” To which, if there were any need of this minute specification, might have been added posts, rails, paling, water-shoots, and various other objects.

and dry,

The second is well known under the name of the dry-rot, the cause and prevention of which are the subjects of a premium by the Society of Arts in London.

Dead matter subject to decomposition,

Animal and vegetable substances possess certain common properties and movements, which constitute what is called life. When that state ceases, and these properties and motions no longer exist, the bodies become subject to the chemical and mechanical laws of all other matter.

only under certain circumstances. Fish and other animal matter

When perfectly dry, and in certain degrees of temperature, both seem to be scarcely capable of spontaneous decay. On this principle vast quantities of salmon are annually conveyed in a frozen state to London from the north

\* From Papers of the Bath and West of England Society, vol. XI, p. 236.

of England and Scotland; and the inhabitants of the still preserved by  
 more northern regions constantly preserve their food, by frost and ex-  
 freezing, unchanged through the longest winters. The ge- clusion of moi-  
 sture.  
 latinous and other soluble parts of animal substances, when  
 extracted by boiling, and kept in a soft moist state, very  
 readily putrefy. But if the same matter be dried by a  
 gentle heat, and secluded from moisture and air by being  
 kept in bottles or metallic cases, it will remain very long  
 without decay. This is the theory of that well-known and  
 useful substance, portable soup. In the burning climate of  
 Africa, when it is intended to preserve a dead animal for  
 food, all that is necessary is to cut the muscular parts into  
 thin strips, from which, in a few hours, the heat of the sun  
 exhales all moisture, reducing them to a substance like  
 leather or horn, which proves to be unsusceptible of future  
 decay from putrefaction. So also entire human bodies, bu-  
 ried in the arid sands of those countries, have often been  
 found converted by exhalation and absorption of their na-  
 tural moisture into a dry hard sort of mummy, incapable of  
 any farther change from the agency of those causes, to  
 which, in such situations, they are exposed.

Similar causes produce the same effects on wood. Even Timber long  
 under less rigid circumstances of this kind, as in the roofs preserved in  
 and other timber of large buildings, it continues for an large buildings,  
 astonishing length of time unchanged; witness the timber  
 of that noble edifice Westminster Hall, built by Richard II  
 in 1397; and the more extraordinary instance quoted by  
 Dr. Darwin, in his ingenious work the Phytologia, of the  
 gates of the old St. Peter's church in Rome, which were  
 said to have continued without rotting from the time of the  
 emperor Constantine to that of pope Eugene IV, a period  
 of eleven hundred years. On the other hand, wood will  
 remain for ages with little change, when continually im-  
 mersed in water, or even when deeply buried in the earth; under water,  
 as in the piles and buttresses of bridges, and in various mo- and in earth.  
 rasses. These latter facts seem to show, that, if the access of  
 atmospherical air is not necessary to the decay of wood, it  
 is, at least, highly conducive to it.

In posts fixed in the ground and exposed to the weather, Decays soonest  
 we constantly find that part soonest decay, which is just at the surface  
 of the ground,  
 above

or where moisture may lodge.

above or within the ground. So also where there is an accidental hole in an exposed surface, or any artificial cavity, as in a mortice and tenon, or the part where pales nearly touch the rails on which they are nailed, there the wood universally begins first to moulder away. The same thing happens with regard to horizontal rails themselves, which, when made of the same materials, rot much sooner than the pales which they support. These facts are very easily explained. They clearly show, that the great cause of decay is the constant action of water aided by air, which most affects those points, where it is most retained, but has less operation, where, as in the perpendicular pales, it chiefly runs off by its own gravity, so that the little which remains is easily and quickly abstracted by the cooperating power of the sun and wind.

This owing to putrefaction.

The change which I am describing is the consequence of putrefactive fermentation; a chemical operation, in which the component parts of the wood form new combinations among themselves, and with the water which is essential to the process. The precise nature of these new compounds has not been ascertained; but, so far as they are known, they consist of certain gasses, or species of air, which fly off, and leave behind a powder, consisting chiefly of carbon or charcoal, and the earth which entered into the original composition of the wood.

Water acts mechanically also.

Beside this chemical change depending on water, that substance tends to destroy wood exposed to the open air by a mechanical operation. Every farmer is acquainted with the power of winter in mouldering down the earth of his fallows. It is equally well known, that porous freestone splits and shivers during severe winters. These effects are produced by frost, which, acting on the water in the pores or interstices of these substances, expands it by conversion into ice, and thus bursts the minute cells in which it was contained. There can be no doubt, that a similar operation takes place to a certain extent in exposed wood, and thus in some degree promotes its destruction.

Water and air the chief instruments,

It appears, then, that the contact of water and air are the chief causes of the decay of wood. If, therefore, any means can be devised, by which the access of moisture and  
air



air can be prevented, the wood is so far secure against decay. This principle may be illustrated by supposing a cylinder of dry wood to be placed in a glass tube or case, which it exactly fills, and the two ends of which are, as it is called, hermetically sealed, that is, entirely closed by uniting the melted sides of each end of the tube. Who will doubt that such a piece of wood might remain in the open air a thousand years unchanged? Or let us take a still more apposite illustration of this fact; that of amber, a native bitumen, or resin, in which a variety of small flies, filaments of vegetables, and others of the most fragile substances are seen imbedded, having been preserved from decay much longer probably than a thousand years, and with no apparent tendency to change for ten times that period. Let us see then if we cannot, by the exclusion of moisture and air, find means of virtually placing our timber in a case of glass or amber.

therefore to be excluded.

Thus amber preserves insects, &c.

With this view, various expedients have been employed, of which the most common is covering the surface with paint; which is oil mixed with some substance capable of giving it the colour which we desire. It is well known, that several of the oils, as those of linseed, hempseed, &c., become dry when thinly spread on any hard substance. The drying quality is much assisted by their being previously boiled with certain metallic oxides, more especially that of lead, litharge. The crust so formed is with difficulty penetrated by moisture or air. For this purpose drying oil is spread on silk or linen, in the manufacture of umbrellas; and will tolerably well succeed in confining hidrogen gas, or inflammable air, in the construction of air-balloons. Hence we see the mode in which the application of paint on wood serves to defend it against the causes of destruction.

Paint employed with this view.

When paint is employed within doors, it is customary to add to the oil, beside the colouring matter, some essential oil of turpentine, which not only makes it dry more readily, but, by giving it greater tenuity, causes it to flow more freely from the brush, and therefore to go farther in the work. For the same purposes I observe it forms a part of the paint used on wood and iron work in the open air; but, as it appears to me, most improperly: For I have re-

Uses of oil of turpentine in it.

Its disadvantages.

marked that on rubbing wood painted white, and long exposed to the weather, the white lead has come off in a dry powder like whiting; as if the vehicle which glued it to the wood had been decomposed and lost, leaving only the pigment behind: And I have been much inclined to suspect, that this has arisen from the oil having been too much *opened*, as the workmen call it, or having its thickness and tenacity too much diminished by a superabundance of the oil of turpentine. In this state it may, in various ways, be more readily acted on by water and air. We know, that the properties of what are called unctuous or fat oils are much changed by the admixture of the volatile or essential oils. On this principle we succeed in getting grease out of woollen cloths by oil of turpentine; but whether the same change is produced on the drying oils, I have not learned.

Acts similarly  
in discharging  
grease.

Is the pigment  
of use?

It appears, then, that these drying oils either by themselves, or boiled with metallic oxides, will form a varnish on wood; but it may be questioned how far the colouring matters, with which they are usually mixed, contribute to increase their preservative power. I do not however, deny, that they may be serviceable in this and other views. They might be supposed to enable the oil to lay firmer hold, as it were, on the wood; and they may serve to increase the thickness of the defensive covering. The first of these

This doubtful.

points is of some importance; for we observe that the paint on street doors, which is become thick by frequent incrustation, is apt, from the strong influence of the summer's sun, to separate from the polished wood beneath, and rise in large blisters; probably in consequence of a greater expansion in the crust itself than in the subjacent wood. Here, therefore, the colouring matter of the paint fails to produce the desired effect; and as to the second end, or that of increasing the thickness of the covering, that may, probably, be much more effectually accomplished than by the mere addition of pigments, some of which are capable of chemical decomposition, and all are costly. This purpose an ingenious artist has of late attempted to answer, by recommending an admixture of road-dust; and for that and other means of reducing the price of paints, has obtained

Road dust.

a premium

a premium from the London Society of Arts\*. However just the general principle in this case may be, the application is somewhat unphilosophical; unless it shall be found, which will scarcely be admitted, that dust of every chemical and mechanical quality will equally or sufficiently answer the intended purpose.

Some material of this kind, selected with greater precision, may however undoubtedly be useful; and none I think promises more fairly than siliceous or flinty sand, which, so far as we know, is absolutely indestructible, and which may be easily procured from the sea-shore, and from the currents of the clear rivers and roads in Berkshire and other counties abounding with siliceous stones. Sand from the sea must first be cleared from all saline impregnations by washing in several waters; and any sand may be obtained of the fineness desired, by mixing it with water in a tub, and after having stirred the whole well together, pouring out, in a longer or shorter time, the muddy water, from which the sand will settle by its own gravity, in a state fit for use when dried.

Perhaps fine sand preferable.

More than thirty years ago this subject presented itself to my mind, on seeing some water-shoots, which had been pitched and painted in the common way, taken down in a state of complete rottenness. I had read that charcoal, buried in the moist earth, had come down to us perfectly sound from the times of the Romans; and that posts long withstood the same moisture, if the part intended to be put into the ground was charred all round to a certain depth. Impressed with these facts, I determined to try an artificial coat of charcoal; and when new water-shoots were constructed, I strongly and carefully rubbed them with a coat of drying oil, which I immediately dredged all over with a thick layer of charcoal finely powdered, and contained in a muslin bag. After two or three days, when the oil was thoroughly dried, and firmly retained the greatest part of the charcoal, I brushed off what was loose, and over that which adhered I applied a coat of common lead-coloured paint, and a few days after, a second. The

Covered with drying oil, and this dusted with charcoal.

\* See Journal, Vol. XIV. p. 258.

whole became a firm and solid crust; after which the shoots were put into their places, and being examined many years afterward, appeared perfectly sound. Any other colour would probably have succeeded equally well with that which I employed. I do not think that lamp black, which is a pure species of charcoal, would have answered the purpose of forming a thick defensive covering so well as the grosser charcoal which I used. But whatever sort of charcoal is employed, it ought either to be fresh made, or heated again in close vessels, so as to expel the water which it greedily attracts from the air.

Lamp black perhaps not so good.

Drying oils expensive.

To all compositions formed from drying vegetable oils there is this objection; that however well they may answer the end proposed, they are too dear for that great consumption, which is usually required for outside work. For this and other reasons, various other substances have been employed for the same purpose.

Pitch does not answer.

Of these the most common is pitch, which is well known to be the resinous matter melted by heat out of the pine tribe of trees in form of tar, and afterward hardened by evaporation. It is applied hot, and when cold, makes a moderately hard varnish. It does not however appear, in fact, to answer the purpose so well as might have been expected. The sun at first melts it, so that it runs off in drops, or adheres to every thing which touches it; and the united influence of air and water seems to make it brittle and powdery like resin. Experience therefore shows it to be of little value. Neither is it probable that its powers would be much improved by admixture with charcoal, sand, or other similar substances. Many members of this Society may recollect its application twenty years ago on the red-deal shingled roofs of part of our market. In this case it was used hot, mixed with Spanish brown, and hardened by sand sifted over it with a sieve; notwithstanding which it seems to have left the wood like the unmixed pitch, and, though frequently renewed, has not prevented the necessity of various repairs within these last five years. The original boards are now every where more or less in a state of decay.

The bituminous substance melted by heat out of coal, Coal tar. and commonly called coal tar, has been strongly recommended for this purpose by that ingenious philosopher Lord Dundonald. I have tried it largely and unsuccessfully, though perhaps not fairly; for the workman whom I employed, in order to make it work more easily, added to it oil of turpentine, which certainly diminished its durability by rendering it more miscible with water. I am however inclined to believe, that no substance of this kind, used by itself, will become sufficiently dry and hard to resist the influence of the weather.

As animal oils are considerably cheaper than those ex- Animal oils made drying. pressed from vegetables, attempts have been made to communicate to them a drying quality. This has been effected by dissolving in them while hot various substances capable of being melted, in such a portion that the whole mass would become dry and hard when cold. Bees' wax, resin, and brimstone are found to have this property. Some of them, when united with drying oil, have long been employed for making boots and shoes water-proof, or impervious to moisture\*. But they will also succeed when mixed with train oil, which is obtained from the blubber of the whale. In the second volume of the Memoirs of this Society, printed in the year 1783, there is the following receipt. Composition of this sort. "Melt twelve ounces of resin in an iron pot or kettle; add three gallons of train oil and three or four rolls of brimstone; and when the resin and brimstone are melted and become thin, add as much Spanish brown, or red or yellow ochre, or any colour you want, first ground fine with some of the oil, as will give the whole as deep a

\* For this purpose there is the following receipt by Mr. Barker Old receipt for water-proof boots or shoes. in Sir John Hawkins's edition of that entertaining work, Isaac Walton's complete Angler: 4th edition, page 223. "Take a pint of linseed oil, with half a pound of mutton suet, six or eight ounces of bees' wax, and half a pennyworth of resin. Boil all this in a pipkin together; so let it cool till it be milk-warm. Then take a little hair-brush, and lay it on your new boots; but it is best that this stuff be laid on before the boot-maker makes the boots; then brush them once over (with it) after they come from him. As for old boots, you must lay it on when your boots be dry."

shade as you like. Then lay it on with a brush as hot and thin as you can. Some days after the first coat is dried, give it a second. It will preserve plank for ages, and keep the weather from driving through brick-work." Page 114.

Tried with apparent success.

This composition I tried about eighteen years ago on some elm paling, substituting for the colouring matter one or two coats of common white paint for the sake of the appearance. This paling appears to me to be in every part of it, which was so covered, as sound as when it was first put up.

Bees wax added.

As compositions of the resinous kind are apt to crack and become powdery, like the varnish of carriages, by exposure to weather, it is not improbable, that this effect may be in some measure counteracted by the mixture of a small proportion of bees' wax. Such a compound I have used, but in the quantity of eight ounces to the gallon found it too slow in drying, and capable of being easily scraped off with the nail. Wax is also at this time very scarce and dear\*.

Remarks.

All the substances contained in these mixtures are capable of perfect incorporation with each other by heat, and when separately exposed, are with great difficulty acted on by water or air in any heat which occurs in our climate.

Method of application.

They should be applied hot with a common painter's brush on the wood which is previously very dry, so as to sink deeply into its pores; and though at first they are apparently somewhat greasy when cold, yet after some days they make a firm varnish, which does not come off on rubbing. When it is required to give beauty to the work, colouring matters may either be added to the mixture, or afterward applied over it in form of common paint. Two

\* For the information of those who may be inclined to make a trial of these compositions, I have inquired the wholesale prices of the different ingredients of Messrs. Cave and Co. Bristol, from whom I learn, that they are very fluctuating, train oil being from 2s. 3d. to 3s. 2d. per gallon; resin from 12 to 21 shillings per cwt.; roll brimstone from 34 to 38 shillings per cwt.; and bees' wax from 3s. 3d. to 3s. 6d. per lb.; the lowest of these prices being about what these articles at present bear.

coats

coats of the composition should always be given; and in all compound machinery, the separate parts should be so varnished before they are put together; after which it will be prudent to give a third coating to the joints, or to any other part which is peculiarly exposed to the action of moisture, such as water-shoots, flood-gates, the beds of carts, the tops of posts and rails, and all timber which is near or within the ground. Each coat should be dry before the parts are joined, or the last coat applied.

These compositions are equally efficacious in keeping iron from decay by rusting. They might also be very advantageously employed in rendering water-tight the plaster which is used to case the outside of the arches of vaults unsheltered by roofs, provided the mortar were made perfectly dry, and the covering of the arch brought up to an angle, instead of making it follow the form of the arch in an ellipse or the segment of a circle.

It is necessary to mention, that compositions made of hot oil should for the sake of security be heated in metallic or glazed earthen vessels in the open air. For whenever oil is brought to the boiling point, or 600° of Fahrenheit's thermometer, the vapour immediately catches fire, although not in contact with any flame; and though a lower degree of temperature than that of boiling should be used in this process, it is not always practicable either exactly to regulate the heat, or to prevent the overflowing of the materials, in either of which cases, were the melting performed in a house, the most fatal accidents might follow.

The following is the proportion of the above ingredients, and the mode of mixing them, which I should recommend.

Take 12 ounces of resin, and 8 ounces of roll brimstone, each coarsely powdered, and 3 gallons of train-oil. Heat them slowly, gradually adding 4 ounces of bees'-wax, cut into small bits. Frequently stir the liquor, which, as soon as the solid ingredients are dissolved, will be fit for use. What remains unused will become solid on cooling, and may be remelted on subsequent occasions.

Charcoal powder or sand may be added.

If the addition of charcoal powder or siliceous sand contributes to the durability of drying oil, it may probably have a similar effect on this composition; but whether it may be best to mix them with the ingredients, or apply them afterward, I cannot from experience tell. In the latter case, the powder should be sifted on, while the first coat of the composition is still hot; and, after some days, when that is dry, should have a brush gently passed over it, in order to remove all the particles which do not adhere; after which other coats of the composition may be applied, as before directed.

This is all which occurs to me as to the mode of preserving wood when exposed to the weather.

(To be concluded in our next.)

### III.

*On the Blight in Wheat. By Mr. THOMAS DAVIS, of Horningsham\*.*

Wheat blight a plant.

THE opinion I gave in the Bath Society's Papers, Vol. X, p. 41, that the wheat blight is a *plant*, and not an insect, is now fully confirmed by the microscopical observations of that able naturalist, Sir Joseph Banks, who, in his treatise on the subject, has given magnified representations of the plant, in which its form and fructification are so conspicuous, that no one can doubt the fact †.

Its destructive operation.

Sir Joseph also describes the manner in which the minute seeds of this plant (which are as light as air) are carried by the wind, and lodged on the growing stalks of wheat, where they take root and vegetate, and, like all other parasitical plants, rob the plant to which they attach of its nourishment, to support themselves. The effect is too well known. The rapidity with which these minute plants vegetate, and the destruction they make in a crop of wheat, of which the ears only a few days before

\* From the Bath Society's Papers, Vol. XI, p. 111.

† See Philos. Journal, Vol. X, p. 225, and Plates IX, X.

appeared



appeared full and heavy and nearly fit for the sickle, can scarcely be believed by those who have not observed it, and is astonishing even to those who have watched its progress. It seems to produce something more than a mere cessation of growth. *Its action is like that of poison.* It absorbs the *farina* or flour of the fairest and plumpest grain, and reduces it to a mere shell of bran.

But although the nature of this disease is now so well known, the remedy is not so easily found. With all due deference to the great abilities of Sir Joseph Banks, I am not so sanguine as to expect, that it can be eradicated by pulling up the diseased plants: or even, if it were practicable, by burning all the straw of every blighted crop.

The seeds of this destructive plant are too minute and abundant, and capable of being wafted to too great a distance, to be totally destroyed. A single acre of blighted wheat will produce seed enough to supply a whole district; and indeed it is too well known to botanists, that the plant grows and flourishes on many *other plants* beside wheat. And were there but a single piece of wheat in a country where none had grown before, the enemy would be ready for the attack, whenever there was a *predisposing* cause in the wheat crop to receive it.

It is probably not within the power of man to prevent, *totally*, the ravages of this destructive, though minute enemy to agriculture, but it may yet be in his power to reduce them in a considerable degree, by ascertaining and obviating the *causes which peculiarly dispose and prepare the wheat plant* for its attacks. These may be summed up in one word, *viz. weakness, or debility.*

The class of plants called by botanists mosses and lichens are the *insects of the vegetable kingdom, created to prey on weak plants, as the insects of the animal kingdom, are to prey on weak animals.* In both instances, the juices by being weakened and deprived of their acidity become *their proper food.* The *remedy* must be to restore to the object *its natural health and vigour.*

To apply this argument to wheat, and to show the cause which render it unproductive, it will be necessary to con-

sider the nature of the plant, and the kind of cultivation which usually renders it productive.

Mode in which wheat grows.

It is well known, that nature has furnished the wheat plant with a double set of roots, so contrived, that the first may be deep enough to enable it to stand the severity of the winter; and the second so shallow as to admit the genial influence of the spring. It first shoots down a perpendicular *tap-root*, which supports the plant and keeps it *steady* during the winter; and in the spring it tillers out a number of *coronul shoots*, each of which has its *own proper root*, and produces its *own ear*, though still adhering to and dependent on each other for mutual support; and when that operation is complete, the winter root *becomes useless and dies*.

An irregularly ripening crop subject to blight.

If this winter root be imperfect, the side shoots which are to produce the crop will also be so. A strong solid *foothold* for the tap-root is therefore necessary for wheat; and the more complete the winter root is, before the spring tillering takes place, the more perfect will be the crop. If the formation of the young plants be unequal, so will be the ripening of the crop; and if the ripe ears on one part of the plant are waiting for the green ones on the other, the blight generally attacks the crop.

Thin and late crops particularly so.

A *thin* crop of wheat, and a *late ripening* crop, (and a thin crop is usually a late ripening one,) are the peculiar *prey of the blight*; and these are generally produced either by sowing land with wheat, which is unfit for wheat, or in an improper state of cultivation, or by sowing it in an improper season. *In fine, any cause which tends to weaken the plant, will predispose it to receive the blight.*

Causes that render wheat weak.

The causes which tend to weaken the wheat plant are many, but the following are the most obvious:

1st. Sowing wheat on land that has been so worn out by cropping, as to have lost that *tenacity* and *cohesion*, which are so necessary to a wheat crop, and which even dung, *without rest*, will not restore.

2dly. Sowing the land in a light loose state, whereby the wheat plant roots too near the surface, and is liable to be injured by the winter's frost, and to have its roots laid bare by the wind.

3dly.

3dly. Sowing wheat too late in the autumn, (which is too common,) especially in poor land and exposed situations, where the roots have not time to establish themselves before the winter comes on, and vegetation is totally at a stand.

Now as these causes have, in consequence of the advance in the price of wheat, occurred more frequently of late years than formerly; it is probable that the assertion "that the blight on wheat has increased of late years" may be true. For,

1st. It has not been uncommon to sow land with wheat every *third* year, instead of every fourth or fifth: and as the land, in the interim, has been under crops, the very nature of which is to make land light, and no fallow year having been allowed to get it close again; the crops, though abundant in straw, have not had strength enough to support them till harvest, and have been *laid by the rains*, and thereby become a prey to the blight.

2d. It has been very much the practice of late years to sow wheat after *turnips*, and very *clean* crops have been produced thereby. But this system is wrong: the turnips are eaten before they are wanted, and the wheat is sown a month too late; and being necessarily *late ripe*, is often attacked by the blight.

3d. It has been also a frequent practice to sow wheat after *potatoes*; and this system is still worse: the land is rendered too light for wheat, and the seed time is much too late, unless it be in deep rich land, where the wheat plants will grow during the whole of the winter.

4th. And even the practice of sowing wheat after *clover* has been carried to too great an extent on light land, especially where the land is nearly tired of clover. It encourages the *slug*, and the *wire-worm*, which destroy a considerable part of the wheat plants, leaving the residue a *thin unequal crop*, which the blight seldom fails to attack, and frequently to ruin.

To sum up the whole:—If it can be proved, (and every man *who is a farmer* must have observed it,) that all *weak crops* of wheat, and particularly all *late-ripe crops*, are peculiarly subject to blight; it should be the great object

of

of every farmer to sow such land, *and such only*, to wheat, as is fit for wheat; to get it in order *early* in the summer, that it may be *close* and *firm* before sowing; to sow as *early* as the state of the weather will permit, particularly in cold soils or exposed situations; and to sow *those kinds of wheat*, which are disposed to *ripen* early, (a circumstance much more attended to in Scotland than in England;) but above all, not to wear out his land by cropping it *oftener with wheat* than its nature will bear; always considering, that it is *not the number of acres sown*, but *the number of bushels produced*, that will *enrich the farmer*, or *supply the market*.

Blight in some cases increased by manure.

When I assert that *weak* crops are the most susceptible of blight, I do not altogether mean such crops as are weak *in consequence of a want of manure*, but such as grow on land which has been made so light by repeated culture, that the plants cannot get firm *foothold*, the great *desideratum*, in fact the *sine quâ non* of a good wheat crop; and manure, particularly horse-dung, instead of remedying this defect, only adds to the evil. In this instance, the remark which has been often made, that the highest manured crops are the most susceptible of blight, is perfectly consonant with my observation. For the same reason, these crops are apt to fall before they are ripe, and in that situation if there be any blight in the air, they are sure to be infected with it, because the sun cannot dry them, and the circulation of the sap is impeded by the bruising of the straw.

Too much manure injurious.

It was well observed in one of the Agricultural Reports, "that land may be made so drunk with dung, that a wheat crop cannot stand upon it:" and I will defy any man to get a good *yielding* crop of wheat in a highly-manured garden. He may, and probably will, get a good crop of *straw*.

Wheat on certain lands seldom blighted.

Mr. A. Young is right, in saying in his Annals, that on *high land*, *not of the best quality*, wheat is seldom blighted. The reason is, that such land is not made too loose by culture and manure, and the straw stands upright and exposed to the sun and wind. I had a very striking instance of this on the Marquis of Bath's land, under my care, a few years ago: I had ploughed up twenty acres of furze-

Instances of blight on land loosened too much by cul-

furze-land in the autumn, with intent to sow it to wheat. ture and manure.  
 It was run back in the spring, and cross-ploughed early in the summer, so as to be quite close and firm before wheat sowing; but having occasion to plant two acres of potatoes, I took part of this land and manured it well with rotten dung, and planted the potatoes therein. They were ripe early, and when dug, the two acres were sown with wheat; on the same day, the rest of the piece, which had not been dunged at all, was sown. The wheat on the two acres was much the proudest during the winter, and the best crop when it came into ear; but when it was just ripe, (which was ten days after the other part,) the blight struck it, and it was as black as a coal, while the rest was as bright as silver. In fact the two acres were scarcely worth reaping.

Again, with respect to *late-ripening* crops being subject to the blight, I am of opinion, that the act of ripening wheat and all annual graminiferous plants is not so much an effort of nature, as a *cessation of nature's efforts*; and that no crop of grain can be a good one, unless the whole ripens together; and if by any cause, particularly by the seed being sown too thin, or by a partial failure of the plants from a severe winter, the plant is forming new roots, or one part of it is doing so, while the other is or ought to be ripening its seed, the straw keeps green and moist, instead of turning yellow and dry, and the blight is sure to take it. And this has brought drilling into disgrace more than all other causes, particularly when the crop has been sown too thin, or the hoe has been used too late\*.

Ripening a cessation of action.

Circumstances tending to bring drilling into disrepute.

\* I have just been a witness to the threshing a piece of drilled wheat, which was injured by harrowing in grass seeds in April: the harrowing made the wheat too thin, and caused it to throw out new shoots; it kept growing while it ought to have been ripening; it of course took the blight, and though the ears were six inches long, the produce weighed only 40lb. per bushel.

IV.

*Answer to Remarks on a Pamphlet, lately published by  
the Rev. T. VINCE, respecting the Cause of Gravitation.  
In a Letter from the Author.*

TO MR. NICHOLSON.

SIR,

MY *Observations on the Cause of Gravitation* having been attacked in the last number of your Journal, by a person calling himself *Dytiscus*, you will, I trust, do me the justice to admit my answer in the next.

Object of Mr. Vince's pamphlet.

What I proposed to establish was, that the fluid assumed by *Sir J. Newton* as the cause of gravitation cannot produce a force to impel a body towards the sun, which shall vary as  $\frac{1}{a^2}$ . The principal objection is to the 18th

The principal objection founded on a mistake.

article, in which it is said, "hence, according to the foregoing reasoning, taking only the two first terms of the series, &c. &c." In the foregoing reasoning we took  $a^n$  for the density of the medium, and then the force was represented by the sum of the alternate terms of the Binomial theorem; in this particular case, therefore, we take the two first terms only, as is here proposed. But in the present article we represented the density by  $P a^n + Q a^q + R a^r +$ , &c. each of which terms gives a series for the force, similar to that stated above; here, therefore, according to the same proceeding, we take the two first terms of each of these series. This *must* be the meaning of the words, "taking only the two first terms of the series;" for they must mean, either the two first terms of each of the series composing the whole force, or the two first terms of the whole considered as one series. But the latter meaning would have entirely excluded all the other series for the force, arising from the general law of density  $P a^n + Q a^q + R a^r +$ , &c. continued to an *indefinite* number of terms, and which it was the declared intention of the proposition to take in, and here confined the force to *two* terms only,  $P a^n + Q a^q$ . It would, therefore, have been totally inconsistent with the terms of the proposition, to have taken the

the words in the latter sense, as it would have destroyed it as a *general* proposition here proposed for investigation, and reduced it to a *particular* case. Besides, the two first terms of the whole as forming one series would not have had a *definite* meaning; for we might write down all the first terms of each series, and then all the second terms, in their order: or, we might write down the first and second terms of the first series, and then the first and second terms of the second series, and so on. As the terms of each series are the alternate terms of the binomial theorem, the first terms only of the first three series were put down, with +, &c. showing that the other terms were to be understood. Two terms only of each series were proposed to be taken, to show, even upon that supposition, that as different powers of *a* must then enter into the two first terms of each series. The whole could not constitute a quantity which should vary as  $\frac{1}{a^2}$ . But Mr. D. seems to have

paid no attention to the words, "taking only the two first terms of the series," nor to have considered that the word *series* is used in both numbers; and hence, instead of taking the first and second terms of each series, he has taken the first terms of the two first series, leaving out the second terms which it was proposed to take in, and thus (to use his own expression) "committed so palpable a blunder," as totally to do away the whole force of his objection.

But Mr. D. goes on thus: "on this point the professor's whole demonstration rests." This is another most unfortunate mistake, and contains a further proof, how little Mr. D. attended to the subject. What is here assumed, is only a very near approximation to the force, but still sufficient for our purpose; the correct law of the force is obtained by taking in *all* the terms of each of the series, instead of the two first only. And the proof of my proposition further rests upon this, that the density of the planet enters into the expression for the force; on which account it was not necessary for me to have gone any further in the investigation than the 13th article; here I have fully established my proposition: but the subject being

new,

Another mistake pointed out.

new, and of a curious nature, I was induced to consider it a little further.

The objection proves nothing against the proposition.

If, however, Mr. D's objection had been well founded, it would have proved nothing against my proposition, as his own conclusion shows, that the force does not vary as

$\frac{1}{a^2}$ , the density  $e$  entering into the expression for the force.

Upon his own assumption, taking in *all* the terms of the series, the force will be represented under this form;

$\frac{\alpha}{a^2} + \frac{\epsilon}{a^4} + \frac{\gamma}{a^6} + \&c.$  and can this vary as  $\frac{1}{a^2}$ , even

omitting  $e$ ?

Farther examination of the objection.

But there is another ground upon which we may examine the objection. The quantity  $Pa^m + Qa^q + Ra^r + \&c.$  representing the density of the fluid, must always be *positive*; hence  $P, Q, R, \&c. m, q, r, \&c.$  are under certain restrictions, such as to make the above quantity positive for every value of  $a$ . Now we must have some standard for our quantities. Let, therefore, the sun's radius = 1, the density of the fluid at the sun's surface = 1. Now according to *Sir J. Newton's* hypothesis, the fluid pervades the sun, causing thereby the gravitation within as well as without the sun. Also,  $a$  varies from 0 to infinity. Now according to Mr. D's assumption of  $Q, m, q$ , the density of the fluid is represented by  $P - \frac{Q}{a^2}$ ; when, therefore, by di-

minishing  $a$ ,  $\frac{Q}{a^2}$  becomes greater than  $P$ , the density of the fluid becomes *negative*, that is, there is no fluid, and consequently no gravitation. Make  $P - \frac{Q}{a^2} = 0$ , and  $a = \sqrt{\frac{Q}{P}}$ .

From the centre of the sun, therefore, to this distance, there is no fluid: hence, according to Mr. D's assumption, part of the sun is not endued with gravitation! he has therefore made an *illegal* assumption of the quantities  $Q, m, q$ ; what then becomes of his objection?

The second objection answered.

But he has brought forward another objection. He says, I ought to have used  $3m, 3q$ , for  $2m, 2q$ ; this, he asserts *would* have been the case, if I had estimated the density



density of the fluid as *Newton* did, that is, by the quantity of matter in a *given cubical space*. True; but the nature of my proposition necessarily obliged me to measure the density by the quantity of matter on a *given plane*; my  $2m$ ,  $2q$ , are therefore perfectly correct, and this is no new use of the term *density*; it is so used when we say the density of light, heat, &c. varies inversely as the square of the distance. With so little attention did Mr. D. examine my investigation, as not to see, that I was under the necessity of so estimating it on the ground I took; for he imputes it to a mistake, that I did not estimate it as *Newton* did. Is not this a "palpable blunder?"

From an attentive consideration of what is advanced by Mr. D., I am clearly of opinion, that he did not read the whole of the essay, so as to comprehend the true grounds upon which the truth of my proposition rests. He seems only to have looked amongst the expressions, to see, if by assuming particular values of the quantities, he could not prove against the proposition; imagining that such values were unlimited, and altogether misunderstanding the subject. If I am wrong in this conjecture, his mistakes must have arisen from his not having mathematical knowledge sufficient to comprehend the investigation.

The objector did not examine the whole of the investigation.

The truth of my proposition rests upon two independent circumstances—that the density  $e$  of the planet enters into the law of force; and that by taking in all the terms of the series expressing the force, it is impossible to make the force vary as  $\frac{1}{a^2}$ , even omitting  $e$ . What then becomes of Mr.

D's vaunting assertion, "on this point the Professor's whole demonstration rests." From the scientific knowledge displayed by Mr. D. in his animadversions on my essay, we are justified in applying to himself his own words, *mutatis mutandis*; "the errors in the works of Dytiscus afford no very flattering specimen of the mathematical abilities of this country."

He further objects thus: "what he says respecting the interference of the ethereal atmosphere of the different planets is totally foreign to the question." Not totally foreign, for it makes directly against the existence of such an existence.

What was said of the ethereal atmospheres of the planets an argument against their existence.

an atmosphere, so far as we have any experience of elastic fluids.

The reviewers vindicated.

Mr. D. is very angry with the Reviewers, that they were not so quick-sighted as himself, in discovering the faults in my essay; what has here been said may, perhaps, tend a little to explain the reason.

The information, that my paper might probably not be printed, came from the Secretary, *Dr. Grey*; this Mr. D. acknowledges was not prudent conduct. But I conceive myself to have been also very uncivilly treated on this account, that the Secretary, whose duty it was to have informed me how my paper was disposed of, never communicated to me the information. Having had occasion to mention *Sir J. Pringle*, and not having been aware of any circumstances, which ought to have prevented me from stating my opinion of his character, I thought it proper to pay him a mark of respect, justly due to his memory.

I am, Sir,

Your obedient Servant,

S. VINCE.

Cambridge,  
April 6th, 1808.

## V.

*Observations on the Structure of the different Cavities, which constitute the Stomach of the Whale, compared with those of ruminating Animals, with a View to ascertain the Situation of the digestive Organ. By EVERARD HOME, Esq. F. R. S.\**

Object of the author.

THE following observations are in some measure a continuation of those upon the stomachs of ruminating animals contained in a former paper. They are intended to show that the stomach of the whale forms a link in the gradation toward the stomachs of truly carnivorous animals.

\* Abridged from the Philos. Trans. for 1807, Part I, p. 93.

The number of cavities constituting the stomach are not the same in all animals of the whale tribe. In the common porpoise, grampus, and piked whale, the number is the same as in the bottle-nose porpoise; but in the bottle-nose whale of Dale there are two more cavities. This variation is however by no means material, since the general structure of the stomach is the same. Stomachs of the whale tribe.

In all of the whale tribe there is one cavity lined with a cuticle, as in the bullock and camel. First cavity.

In all of them there is a second cavity made up of a glandular structure. In the porpoise, grampus, and large bottle-nose whale this structure resembles that which is above described. In the piked whale the rugæ are longitudinal and deep, but in some places united by cross bands; and as the piked whale has whalebone teeth, the great whalebone whale will probably, from the analogy of its teeth, resemble it in the structure of its stomach. Second cavity.

The third cavity in all of them is very small, and bears a strong resemblance to the third cavity in the camel's stomach; its use, therefore, is probably the same. Third cavity.

The fourth stomach in all of them has a smooth internal surface, with the orifices of glands opening into its cavity. In the bottle-nose whale of Dale the two additional cavities have the same internal structure, and therefore must have the same general use, with a greater extension of surface, and the subdivisions will make the food pass more slowly into the intestine. Fourth cavity.

The first stomach of the whale is not only a reservoir, but the food undergoes a considerable change in it. The flesh is entirely separated from the bones in this cavity, which proves that the secretion from the glandular part has a solvent power. This was found to be the case in the bottle-nose porpoise and large bottle-nose whale. In both of them several handfuls of bones were found in the first stomach, without the smallest remains of the fish, to which they belonged. The soft parts only can be conveyed into the second and third stomachs, the orifices being too small to admit the bones to pass. Office of the first stomach.

The bones must therefore be reduced to a jelly in the first stomach, and although the process, by which this is effected,

effected, being slower than that, which separates the flesh, is the reason of their being found in such quantity in the cavity, the means by which it is performed are probably the same.

Mr. Hunter's opinion of the second cavity.

The second cavity was supposed by Mr. Hunter to be the true digesting stomach, in which the food becomes chyle, and the use of the third and fourth he looked upon as not exactly ascertained\*.

Erroneous.

Upon what ground Mr. Hunter was led to draw this conclusion cannot now be ascertained; and, such is my respect for his opinion, that nothing but the following observations, supported by facts, could lead me to form a different one. In considering this subject, it struck me that the second stomach could not be that, in which chyle is formed, since that process having been completed, any other cavities would be superfluous. The last cavity in all stomachs is that, in which the process must be brought to perfection: and therefore the most essential change, which the food undergoes, or that by which it is formed into chyle, should be performed in that cavity. Surveying the different cavities in the whale's and ruminating stomachs with this impression on my mind, and comparing them with the single stomachs of carnivorous animals, it appeared that the first point, which required to be ascertained, was, which of the cavities in these more complex stomachs bears the greatest resemblance to the simple one. The fourth of the whale is certainly more like the human stomach than the second or third. I therefore concluded, that the fourth, both from analogy and situation, is the stomach in which the process is completed: and that in this animal, from the peculiarities of its œconomy, and the nature of the food, not only a cuticular stomach is necessary, but also two glandular ones, in which it undergoes changes preparatory to its being converted into chyle.

Compared with the stomach of the camel;

Having satisfied myself upon this subject, and having compared the stomachs of the whale with the fourth of the camel, the contraction or partial division of the camel's made it apparent, that the lower portion only of that ca-

\* *Vide* Observations on the Structure and Economy of Whales. By John Hunter. Phil. Trans. Vol. LXXVII, p. 411.

vity, which resembles in shape and internal appearance the human stomach, is the cavity in which chyle is formed, and the upper or plicated portion is only to prepare the food, and is therefore analogous to the second in the whale.

As the same appearances are met with in the fourth stomach of the bullock, as well as in the camel, although there is no permanent contraction, or division between them, the upper or plicated portion must be considered as a preparatory organ, and the lower portion as that, in which the formation of chyle is completed. This receives farther confirmation from a more attentive examination of the parts immediately after death, by which it was found, that, before the stomach has been disturbed, there is an evident muscular contraction between the plicated and lower portion. This appearance was met with in every instance that was examined, and these were not fewer than nine or ten. Added to this the lower portion, on a more minute inspection, has an appearance somewhat similar to the inner membrane of the human stomach: and the surface of the plicæ is in many respects different.

From the facts and observations which have been stated, it appears, that, in many animals of the class mammalia, the food undergoes different changes preparatory to its being converted into chyle, and this last process is effected by a somewhat similar secretion, since the part of the stomach which produces it has in all of them an evident similarity of structure.

Chyle produced by a similar secretion in all the mammalia.

The above facts appear to throw some light on the digestion of the different kinds of food, and open a wide field of inquiry into one of the most interesting parts of the animal œconomy, which has been hitherto too much neglected. In the present very limited state of our knowledge there are many circumstances, which cannot be accounted for: these however will be explained, when a further progress has been made in this investigation.

It is obvious, that as the stomachs of carnivorous animals are the most simple, animal substances, on which they feed, require a shorter process to convert them into chyle than vegetables; but why the whale tribe, which live on fish,

Animal substances easier converted into chyle than vegetables.

fish, should have a more complex stomach, it is not easy to explain: since fish are very readily converted into chyle, in the stomachs of animals of their own class, as well as in the human stomach, and there is therefore reason to believe, that they require as little preparation for that process, if not less than animal substances.

Ruminating animals capable of living on fish, without injury from their bones.

The fish bones swallowed by the whale tribe being retained in the cuticular bag, till they are reduced to jelly, explains the circumstance of cows, and other ruminating animals being able occasionally to live on fish, (a fact, of which there is no doubt, both in the Orkneys and in Iceland;) since, if the bones are dissolved in the paunch, the other stomachs are in no danger of being injured from the animal living on this kind of food.

Whether these cavities, which I have called preparatory stomachs, are solely for purposes connected with digestion, or are also in any way connected with the formation of secretions peculiar to those animals, cannot be ascertained in the present state of our knowledge of digestion.

Anomaly of the spermaceti whale.

The oil of the physeter, which crystallizes into spermaceti, shows some affinity in this respect to the secretion of fat, that becomes suet, which is only met with in ruminating animals: but on the other hand, the oil of the rest of the whale tribe does not form this substance, more than the fat of the horse produces tallow. These facts may be hereafter explained by an examination of the digestive organs of the physeter, when an anatomist shall have an opportunity of examining them.

## VI.

*On Family Wine Making.* By W. MATTHEWS, Esq.\*.

*To the Committee of Superintendance of the Bath and West of England Society.*

GENTLEMEN,

HAVING in the 10th volume of the Society's papers <sup>Home made wine,</sup> been indulged with the insertion of a few remarks on the utility of making family wines from several of our garden fruits; I took the liberty of presenting, at a subsequent General Meeting, for its examination, a sample of such wine made under my own notice. It will be within the recollection of different gentlemen, who attended that meeting, that the wine they tasted was deemed a very good, pleasant-flavoured, and useful article. The price at which it was made † was considered as small, when compared with the uses to which the wine may be applied, even in genteel <sup>for family use,</sup> families, where economy is regarded. But the idea of making such an article, in considerable quantities, (especially in abundant fruit years,) so as to have the power of furnishing sick and sickly poor persons with such occa- <sup>and the sick poor.</sup> sional refreshment, could not pass unapproved. The oldest wine of this sort which I now have by me, is yet too young to give proof of that excellence, which three or four years more will give it; but it is now so rich and valuable, that I can have no hesitation about publishing the recipe, by which it is made, and encouraging any of our members fully to rely upon it for success. The fruits used were of the different sorts mentioned in the recipe, excepting gooseberries, and I think nearly of equal quantities, taken out of a private garden, where they would otherwise have turned to very little account. My friends having fully <sup>Goodness.</sup> convinced me, that if I gave them white wine equally good

\* Papers of the Bath and West of England Society, vol. XI, p. 222.

† This will be from 2s. 6d. to 3s. per gallon, according to circumstances.

with that produced, they will not call on me for foreign white wine, of at least *five* times the price; I have this year taken the advantage of a fine fruit season, and made several hogsheads. If I live to present the Society with a taste of it some years hence, I have no doubt of its being found worthy of their commendation.

Several hogs-  
heads made.

Black currants  
recommended

I cannot conclude without repeating my recommendation to the owners of gardens in general, to all farmers in easy circumstances, and country gentlemen especially, to regard this useful practice:—and that they may do it to the greater advantage, the increased cultivation of the black-currant plant seems essential: It is easy to increase, greatly productive, and its fruit, in general, can scarcely form too large a proportion of the mixture.

I remain, with all due respect,  
Your faithful coadjutor,

WILLIAM MATTHEWS.

*Bath, September, 1807.*

---

*A useful Recipe for making Family Wine.*

Receipt for the  
wine.

Take, black currants, red ditto, white ditto, ripe cherries, (black hearts are the best) raspberries, each an equal, or nearly an equal quantity: If the black currants be the most abundant, so much the better.—To 4lb. of the mixed fruit, well bruised, put one gallon of clear soft water: steep three days and nights, in open vessels, frequently stirring up the mass: then strain through a hair sieve. The remaining pulp press to dryness. Put both liquids together, and to each gallon of the whole put three pounds of good, rich, moist sugar, of a bright yellowish appearance. Let the whole stand again three days and nights, frequently stirring up as before, after skimming off the top. Then run it into casks, and let it remain, full and purging at the bung-hole, about two weeks. Lastly, to every nine gallons put one quart of good brandy, and bung down. If it does not soon drop fine, a steeping of isinglass may be introduced, and stirred into the liquid, in the proportion of about half an ounce to nine gallons.

N. B.



N. B. Gooseberries, especially the largest, rich flavoured, Gooseberries may be added. may be used in the mixture to great advantage; but it has been found the best way to prepare them separately, by more powerful bruising, or pounding, so as to form the proper consistence in pulp; and by putting six quarts of fruit to one gallon of water, pouring on the water at twice, the smaller quantity at night, and the larger the next morning.—This process, finished as aforesaid, will make excellent wine, unmixed; but this fluid, added to the former mixture, will sometimes improve the compound.

---

#### ANNOTATION.

I am inclined to think the addition of brandy, here recommended, injurious: an opinion founded on the authority of a respected friend, formerly a chemist in a country town, who excelled in making family wine, and confirmed by my own experience. A similar sentiment is entertained by Dr. Anderson, as appears in his judicious letter on the subject to the author of the preceding article, inserted in Vol. X of the Bath Society's papers, which I shall here annex. Brandy perhaps better omitted.

I will only add, that the best home made wine I recollect to have tasted was made by expressing the juice of white currants, bruised but not picked from the stalks: adding water to the fruit after it was pressed, in the proportion of double the quantity of juice: mixing the two liquors together, and putting the whole into a barrel with three pounds of pretty coarse brown sugar to every gallon of the mixture: stirring it well, and then leaving it to ferment with the bung-hole at first open, and afterward loosely covered, the barrel not being quite filled. As the sugar does not immediately dissolve, the stirring must be repeated occasionally at intervals of a few days, till this is effected. After it has fermented properly, the barrel must be stopped close; and it may afterward be bottled for use. Some useful information respecting the fermentation and management of wine may be obtained from Mr. German's paper on the wines of Champagne; Philos. Journal, Vol. XVII, p. 353. Method of making white currant wine.

Isleworth, Jan. 21, 1804.

DEAR SIR,

“ I received your letter some days ago respecting the *wines* that may be made from the natural fruits of this country, which I should have sooner answered, could I communicate any thing of the importance I wished; but that not being the case, I felt a great reluctance at the thought of troubling you with any thing not satisfactory.

Our own fruits afford wine as good as foreign.

“ I can say little else than that from our own experience for a short time past, and what I have seen of others, I am perfectly satisfied that wine may be made from our native fruits—red and white currants, gooseberries, black currants, raspberries, and other fruits, (with the help of sugar) as good, and of as rich a flavour in all respects, as any that are imported from abroad. But the particulars in the process that may vary the qualities of the wine, where the materials are the same, are so numerous, and the time that must elapse before the result of any experiment can be known is so great, that I despair of living to see any certainty established on this head. At present I sometimes taste as good wine of that sort as could be desired, and again as bad as can be thought of, made by the same persons, when they can assign no reason for the difference. From our own limited practice I have been able to ascertain only two points, that I think can be relied upon as tolerably well established. These are, *first*, that age, I mean not less than *three* years, is required to elapse, before any wine, that is to be really good, can attain such excellence as to deserve the name of *good*; and *second*, that it never can attain that perfection, if spirits of any kind be mixed with it. I apprehend that most of our made wines are greatly hurt by not adverting to these two circumstances.

Liabie to fail.

Two leading points.

Quality of the fruit.

“ Another circumstance that is in my opinion very necessary for the formation of good wine of this sort, is a certain degree of *acidity* in the fruit, without which the wine never acquires the zest which constitutes its peculiar excellence, but hurries forward too rapidly into the state of vinegar. Currants at all times possess enough of that acidity; but if gooseberries be too ripe they are apt to want

want it, and become insipidly sweet at an early period, though they soon become vinegar. It ought to be remarked, that the native acidity of the fruit is different from the acidity of vinegar, and possesses qualities extremely dissimilar. The sourness of vinegar, when it has once begun to be formed, continues to augment with age; but the native vegetable acid, when combined with saccharine matter, is gradually diminished as the fermentation proceeds, till it is totally lost in the vinous zest into which both this and the sugar are completely converted before any vinegar is produced: if the fermentation be properly conducted.

Acidity of fruit is not vinegar.

“ This I believe is a new opinion, which experience alone enabled me to adopt not very long ago. But I have had so many experimental proofs of *this* fact, independent of the support it derives from reasoning, that I am satisfied it is well founded. I am satisfied farther, that the wines of this country are debased chiefly by not adverting to it, and of which I think you will be convinced also by a moderate degree of attention.

“ Every person knows, that an insipid sweetness is the prevailing taste in liquors when they begin to ferment, and that it is gradually changed into a pungent vinosity as the process proceeds; but few persons have had occasion to remark, that the *native acid* of fruit undergoes a similar change by the fermentatory process. Every one who tastes made wines, however, soon after the process has commenced, perceives that sour to a certain degree is mixed with the sweet. It chanced, indeed, that the sweet is sooner blended than the sour; so that when the liquor is tasted a few months after it has been made, it hath lost some part of its sweetness; but still retains nearly the whole of the sourness of the native acid of the fruit. And as the vinous flavour is yet but weak, the liquor appears to be thin and weak, and running into acidity. It is therefore feared, that if it be not then drunk, it will soon run to the state of vinegar; on this account it is often used in this state, when it forms a very insipid beverage. Frequently also, with a view to check the acetous process, and to give that degree of strength which will entitle it to the name of a cordial liquor,

The sweetness goes off, and so would the acidity.

Common mistake.

Brandy,  
injurious in its  
effect.

liquor, a certain portion of brandy is added to it, after which it may be kept for some time. The effect of this addition is to put a stop to that salutary process of fermentation which was going slowly forward, and gradually maturing the native vegetable acid into vinous liquor, which being at last blended with the saccharine vinous juice, produces that warm exhilarating fluid which cheers the heart, and invigorates the strength of man. In this way the sharp insipid and poor liquor which was first tasted is, by a slow process, which requires a great length of time to complete it, converted into rich pleasant wine, possessing, in a great degree, that high zest which constitutes its principal excellence.

The flavour  
affected by the  
skin of the  
fruit.

“ My experience does not yet enable me to speak with certainty respecting all the circumstances that may affect the flavour, or augment or diminish the strength of wine, or accelerate or retard the time of its ripening. But my opinion at present is, that a great part of the flavour of wine depends considerably upon the skin of the fruit, which may be augmented or diminished by the degree of pressure the fruit is subjected to, and other particulars connected with it; or by the macerating the fruit more or less in the juice before the skins be separated from the pulp: and that the ultimate qualities of the wine are considerably affected by the proportion of the original native acid of the fruit, conjoined with the saccharine part of the juice. It seems to me very evident also, that the saccharine juice can be more quickly brought into the state of wine than the acid portion of it, and that of course those wines that consist entirely of saccharine matter, flavoured only by some pleasing vegetable perfume, such as cowslip or elder-flower wine, and others of similar sorts, may be sooner brought to be fit for drinking than those in which the juices of fruit form a considerable ingredient; and may be also made of a weaker and lighter quality. And that fruit-wines, in proportion to the diminution of the quantity of fruit to that of sugar, or in proportion to the quantity of acid in the fruit, may be accelerated or retarded in the progress of fermentation; but that strong full-bodied wine, of good flavour, must have a considerable proportion of native acid,  
and

Some sooner fit  
for drinking  
than others.

and requires to be kept a long while before it can attain its ultimate perfection.

“ I have had too little experience in the practice of Grape wine, making grape wine to enable me to speak with precision. The flavour of different kinds of grapes we know varies considerably, which must affect the wine; but other circumstances in the process must affect it greatly. It is the only fruit known in this country that affords juice in abundance sufficient to admit of being made into wine without the addition of water, or rich enough without the use of sugar. Two years ago the season was so favourable, that my grapes (the muscadine) ripened completely, and I determined to try to make some wine of them without either sugar or water. The juice was squeezed out by hand without any pressure, as I had no press. It fermented very well, and after a proper time it was tried. The liquor tasted sweetish, but wanted much of the vinous zest we wished for. This arose, I have no doubt, from the want of a due proportion of native acid, which would have been probably supplied by a complete pressure of the must, had I possessed the means of doing it, especially if the bunches of grapes had not been separated from the small foot-stalks to which the berries adhere. But not having a quantity sufficient to make it worth while to have a press, I thought of another method of attaining the end I aimed at, to which I was forced to resort; on finding that birds and vermin are so greedy of the grape, that it is a matter next to impossible to preserve them for any time here in quantities after they are ripe without being broken, which, by letting the juice flow out, lodges between the berries in the clusters, and there becomes mouldy, and communicates a musty taste that cannot be got rid of.

Birds and vermin fond of grapes.

and frequently occasion a musty taste by opening them.

“ To avoid all these evils, I determined to gather the fruit when it is so far ripened only as just to begin to be pecked by the birds. As the juice possesses at that time more vegetable acidity, and less of the saccharine taste than when fully ripe, I conceive that the wine made from it will be sharper, and have a higher zest than the other; but dreading that the juice might not be sufficiently matured to do by itself, I added a portion of sugar and water to the juice, and

Attempt to remedy this.

and have put it by for trial. It fermented well, and the liquor has at present as promising an appearance as I could wish. Should this mode of making grape wine succeed, it will be by far the cheapest wine we can make in this country; for the quantity of juice yielded by the grape is so much more abundant, and so much richer than that of our other fruits, and it is so much easier to be gathered and otherwise managed, that it must be much more desirable. The quantity of fruit produced too is much greater when the vines are properly managed, than can be gotten from the same extent of ground of other fruits, as to give it a decided preference on the whole. I have just now in my cellar above forty gallons of that wine made from the grapes that were gathered from a wall of about fifteen yards in length, and fifteen feet high. Nor was that crop above the average. Neither had that wine above half the quantity of sugar that other fruit wines would have required. I have no doubt that were vines raised from seeds of the best and earliest sorts, and carefully selected when they come to bear, we might thus obtain a grape that would ripen very well in this country without the assistance of a wall. It is by no means improbable that such a vine was once known in England.

Advantages of  
the grape.

Black currant  
ranks next.

“Next to the vine, I agree with you in thinking that the *black* currant is the best fruit we have of that kind for making wine. I have seen some of it that was truly excellent. It would be of great use for giving flavour to some other wines.

“When I began this letter I thought that I had nothing to say; but being once begun, it has run on to an enormous length. I hope you will forgive me for it. I now speak little, and write less: and it requires an effort for me to begin with either; but, like a disorderly clock, when I am once fairly set agoing, I run on perhaps without rhyme or reason. Wishing you success in all your useful pursuits.

“I remain, dear Sir,

“Your most humble servant,

“JAMES ANDERSON.”



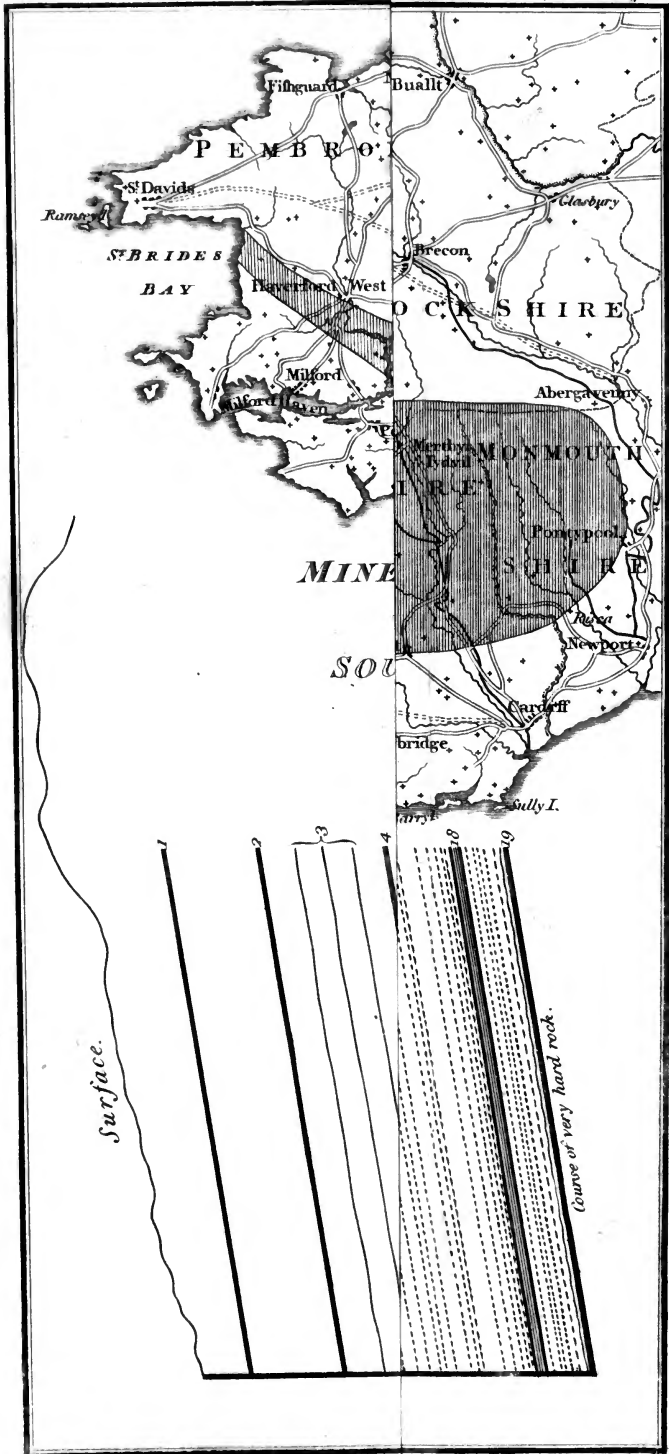



## VII.

*Description of the Mineral Basin in the Counties of Monmouth, Glamorgan, Brecon, Carmarthen, and Pembroke.*

*By Mr. EDWARD MARTIN. Communicated by the Right Hon. C. F. GRENVILLE, F. R. S.\**

1 **T**HE irregular oval line, delineated on the annexed map (Plate IX.) shows nearly the inner edge of a limestone basin containing all the strata of coal and iron ore in South Wales. In which all the strata of coal and iron ore (commonly called iron stone) in South Wales are deposited; the length of this basin is upwards of 100 miles, and the average breadth in the counties of Monmouth, Glamorgan, Carmarthen, and part of Brecon, is from 18 to 20 miles, and in Pembrokeshire only from 3 to 5 miles.

2. On the north side of a line, that may be drawn in an east and west direction, ranging nearly through the middle of this basin, all the strata rise gradually northward; and on the south side of this line they rise southward, till they come to the surface, except at the east end, which is in the vicinity of Pontipool, where they rise eastward.

3. The depths from the surface to the various strata of coal and iron ore depend upon their respective local situations. On the north of the centre the strata rise to the north, and on the south to the south. Depths from the surface vary.

4. The deepest part of the basin is between Neath, in Glamorganshire, and Llanelly, in Carmarthenshire; the uppermost stratum of coal here does not extend a mile in a north and south direction, and not many miles in an east and west direction, and its utmost depth is not above 50 or 60 fathoms. Deepest part of the basin. Uppermost stratum.

5. The next stratum of coal, and those likewise beneath it, lie deeper and expand still longer and wider, and the lowest which are attended by parallel strata of iron ore, of which there are in some situations about 16 accompanied by irregular balls or lumps of iron ore, occupy the whole space between Llanmaddock Hill, near the entrance of Burry river, to Llanbidie, from the Mumbles to Cribbath, from Newton Down to Penderryn, from Castle Coch to Castle Morlais, and from Risca to Llangattock, and in Second and lower strata.

\* From the Philos. Trans. for 1806, p. 342.

length on the south side of the bason from Pontypool through Risca, Tinkwood, Llantrissant, Margam, Swansea Bay, and Cline Wood, to Llanmaddock Hill, and on the north side through Blaenafon, Ebbw, Sirhowy, Merthyr, Aberdare, Aberpergwm, Glyntowy, Llandibie, and the Great Mountain, to Pembrey Hill, near Llanelly in Carmarthenshire, and their depths are at the centre range of strata from 6 to 700 fathoms.

Strata running through Carmarthen bay and Pembroke-shire.

6. The strata of coal and iron ore running from Pembrey Hill, through Carmarthen Bay and Pembrokeshire to St. Bride's Bay, are only a continuation of those in the counties of Glamorgan and Carmarthen, which lie next to and parallel with the north side of the bason, all the remaining strata rising southward; and the middle ranges on the north side of the bason, are lost between where they meet the sea near Llanmaddock Hill and the south side of Pembrey Hill, in their course towards Pembrokeshire, in consequence of a contraction of the sides of the mineral bason, or rather by its becoming shallower; for in Pembrokeshire none of the strata of coal or iron ore lie above 80 or 100 fathoms deep, consequently all those which do not lie above 5 or 600 fathoms in Glamorganshire and Carmarthenshire have not reached this county, by reason of the bason not being of sufficient depth and width to hold them.

Strata at the east end of the basin.

7. The strata of coal at the east end of the bason running from Pontypool to Blaenafon and Clydach, and on the north side from thence to Nanty Glo, Ebbw, Beaufort, Sirhowy, Tredegar, Romney, Dowlais, Penderryn, Plymouth, Cyfarthfa, Abernant, Aberdare and Hurwain Furnaces and Iron Works, are of a cokcing quality, and thence the whole strata of coal to St. Bride's Bay alter in their quality to what is called stone coal, (the large of which has hitherto been used for the purposes of drying malt and hops, and the small, which is called culm, for burning of limestone); the several strata of coal from Pontypool, on the south side of the bason, through Risca, Llantrissant, Margam, and Cline Wood, to Burry River, Llanelly, and the south side of Pembrey Hill, are principally of a bitumiuous or binding quality.

8. Notwithstanding

8. Notwithstanding the principal strata of coal in Glamorganshire lie from 5 fathoms to 6 or 700 fathoms deep, still it has not been necessary to pursue these strata deeper than about 80 fathoms. Strata worked only to eighty fathoms.

9. The veins of coal and iron ore, in the vicinity of most of the iron works in Monmouthshire and Glamorganshire, are drained and worked by levels or horizontal drifts, for which opportunity is given by the deep valleys which generally run in a north and south direction, intersecting the range of coal and iron ore, which run in an east and west direction, under the high mountains, and thereby serving as main drains, so that the collier or miner here gets at the treasures of the earth, without going to the expense and labour of sinking deep pits, and erecting powerful fire-engines. However, in process of time, in situations where the coal and iron ore that are above the level of these natural drains become exhausted, it will be found necessary to sink shallow pits, and erect fire-engines for the draining and working of the coal and iron ore, and at a future period, pits of greater depths must be sunk for the same purposes. Method of working.

10. There are 12 veins or strata of coal in this mineral depository, from 3 to 9 feet thick each; which together make  $70\frac{1}{2}$  feet: and there are 11 more, from 18 inches to 3 feet, which make  $24\frac{1}{2}$  feet, making in all 95 feet; beside a number of smaller veins from 12 to 18 inches, and from 6 to 12 inches in thickness, not calculated upon. Number and thickness of coal veins.

11. By taking the average length and breadth of the foregoing different strata of coal, the amount is about 1000 square miles, containing 95 feet of coal in 23 distinct strata, which will produce in the common way of working 100,000 tons *per acre*, 64,000,000 tons *per square mile*. Produce in the common way of working.

12. If the whole extent of this mineral country was an even plain, the border or outbreak of each stratum would appear regular and true; but owing to the interposition of hills and valleys, the edges of the strata, if nicely measured and planned, would seem indented and uneven, yet in many instances the due range is totally thrown out of course, in consequence of knots, dikes, or faults. Edges of the strata disturbed.

13. These

The irregularities extend far into the basin.

13. These faults or irregularities are not confined to the edges of the strata, but they take grand ranges, through the interior of the bason, generally in a north and south direction, and often throw the whole of the strata, for hundreds of acres together, 40, 60, 80, or 100 fathoms, up or down, and still there is seldom any superficial appearance, that indicates a disjunction, for the largest faults frequently lie under even surfaces.

It is not probable, that any vein or stratum remains undiscovered.

14. As every stratum rises regularly from its base to the surface, and is frequently visible and bare, in precipices and deep dingles, and often discovered where the earth or soil is shallow in trenching, or in forming high roads, and by reason of the whole of the country within this boundary being so perforated by pits, and so intersected by the various operations of art and nature, it is not probable that any vein of coal, iron ore, or other stratum remains undiscovered in this mineral bason.

Their distribution among the counties.

15. Glamorganshire engrosses far the greatest portion of coal and iron ore, Monmouthshire the next in point of quantity, Carmarthenshire the next, Pembrokeshire the next, and Brecknockshire possesses the least.

Breakings out of the strata in Brecknockshire.

16. The strata of coal and iron ore in the last named county, which are the lowest in the bason, break out northward, and only take place in the three following distinct spots, viz. 1st. From Turch River (which is the boundary between Lord Cawdor and Charles Morgan Esq.) across the river Tawe and the Drin Mountain to the great forest of Brecon. 2d. A corner of ground from Blaen Romney to the north of Brynoer. 3d. Another spot, from Rhyd Ebbw and Beaufort Iron Works, through Llwyn y Pwll, near Tavern Maed Sur, to where it joins Lord Abergavenny's mineral property.

Principal faults.

17. *Note.* A principal fault is observable at Cribbath, where the beds or strata of the limestone stand erect, another, of considerable magnitude, lies between Ystrad-vellte and Penderryn, where all the strata on the north side of the bason are moved many hundreds of yards southward (as at Dinas).

Limestone.

18. *Note.* The limestone appears to the surface all along the boundary line in the counties of Monmouth, Glamorgan, Carmarthen,

Carmarthen, Brecon, and no doubt can be entertained of its due range from Newton across Swansea Bay to the Mumbles, and from Llanmaddeock Hill across Carmarthen Bay to Tenby. In Pembrokeshire it appears to the surface on the south side of the bason, at Tenby, Ivy Tower, Cochelard, Bit Church, Williamston, Lawrinny, Cord, Canta, and Johnston; and on the north side of the bason, at Templeton, Picton, Harriston, and Persfield; yet it certainly forms an underground connection from point to point.

*The following is an Enumeration of the Strata, as they appear in the Section, at the Foot of Plate IX.*

1.  $1\frac{1}{2}$  foot Cwm little vein.
2.  $2\frac{1}{2}$  feet Hendro Vawr vein.
3. Three or four small veins of coal.
4. 3 feet the yard vein of Cwm.
5.  $1\frac{1}{2}$  Do. the little coal vein.  
2 or 3 courses of regular balls are seen between 5 and 6.
6. 4 feet Cwm Canaid coal.  
Between 6 and 7 are balls not yet worked.
7. 4 feet, Clynderris coal.  
The division between 7 and 8 varies much in the perpendicular distance between the veins sometimes 30 and sometimes 20 yards.
8. 4 feet, the clay vein.
9. 9 feet, Cwm Glo big vein.  
Balls and little veins of mine are seen in the division between 9 and 10.
10. 9 feet, Cwm Whern big vein.
11. 2 feet, Cwm Glo little vein and  $1\frac{1}{2}$  foot little vein with  $\frac{1}{2}$  yard of rubbish between them.  
2 or 3 poor little veins of mine occur between 11 and 12.
12. 1 foot vein above the balls.  
2 courses of balls, but no veins, between 12 and 13.
13. 4 feet, Whern vein, a little rubbish in the middle.  
There are mines in the division between 13 and 14; but not yet worked.
14.  $2\frac{1}{2}$  feet, and 3 feet vein. These appear at Penywain with 1 foot rubbish between them.

Enumeration  
of the strata.

16. 3 feet

Enumeration  
of the strata.

15. 3 feet, Dowlais little vein, at Penywain.  
No mine yet found in the division between 15 and 16.
16. 4 feet vein between Cwm Moin and Penywain.  
No mine of consequence occurs between 16 and 17.
17. 3 feet Cwm Moin vein. Between 17 and 18 the following occur in succession as here set down.
  - 3 inches yellow vein.
  - 3 ditto Pin Brith.
  - 4 ditto the black vein.
  - 4 ditto the yellow vein.
  - 4 ditto the jack vein.
  - 2 ditto the Gurthean vein.
  - 5 ditto the Gurthean Clase Vawr.
  - 5 ditto the Gurthean Clase, or blue vein.
  - 1 ditto upper black pin.
  - 2 ditto lower black pin.
  - 4 ditto the big vein.
  - 3 ditto Gurthean Spinkin.
  - 4 ditto Gurthean Vawr gona.
  - 2 ditto Gurthean Knappe.
  - 3 ditto Pin Garw.
18. Smoot and fire clay. Between 18 and 19 are
  - 4½ inches lower black vein.
  - 4 ditto black balls.
  - 1 ditto upper inch vein.
  - 1 ditto lower inch vein.
  - 2 ditto upper 2 inch vein and 2 inches lower 2 inch vein.
  - 2 ditto irregular balls.
  - 3 ditto best pin.
19. Course of very hard rock, 3 feet.

## VIII.

*On Fairy-Rings. By W. H. WOLLASTON, M. D. Sec. R. S.\**

THE circles of dark-green grass frequently observed in old pastures, and known to most persons by the name of Fairy-rings, although in themselves of no importance, yet seem to claim some attention, if we consider the many ingenious attempts that have been made to explain their origin. On such a subject I shall be excused offering any examination of opinions previously formed by others, and shall therefore proceed briefly to relate such observations as I made, during a few years residence in the country, on the progressive changes of these circles, and which seem to me to lead to a clear and satisfactory conclusion.

That which first attracted my notice, was the position of certain fungi which are always to be found growing upon these circles, if examined in a proper season. In the case of mushrooms, I found them to be solely at the exterior margin of the dark ring of grass. The breadth of the ring in that instance, measured from them toward the centre, was about twelve or fourteen inches, while the mushrooms themselves covered an exterior ring about four or five inches broad.

The position of these mushrooms led me to conjecture that progressive increase, from a central point, was the probable mode of formation of the ring. I was the more inclined to this hypothesis, when I found that a second species of fungus presented a similar arrangement, with respect to the relative position of the ring and fungi; for I observed, that in all instances the present appearance of fungi was upon the exterior border of a dark ring of grass. I thought it not improbable that the soil, which had once contributed to the support of fungi, might be so exhausted of some peculiar *pabulum* necessary for their production, as to be rendered incapable of producing a second crop of that singular class of vegetables. The second year's crop would consequently appear in a small ring surrounding the original centre of vegetation, and at every succeeding year

Various attempts to account for fairy rings.

Certain fungi grow about them.

These occasions the ring by spreading progressively from the centre, as they cannot continue to grow in the same spot.

\* Phil. Trans. for 1807, p. 133.

the defect of nutriment on one side would necessarily cause the new roots to extend themselves solely in the opposite direction, and would occasion the circle of fungi continually to proceed by annual enlargement from the centre outwards. An appearance of luxuriance of the grass would follow as a natural consequence, as the soil of an interior circle would always be enriched by the decayed roots of fungi of the preceding year's growth.

Dr. Hutton's observation of them at Arthur's seat.

By reference to Dr. Hutton's\* "Observations on certain natural appearances of the ground of the hill of Arthur's Seat near Edinburgh," we find the progressive enlargement distinctly noticed; but as he happened not to observe any of the fungi that occasioned them, he speaks of it merely as "a piece of natural history worth recording, and for which, a theory is wanting."

Respecting the enlargement, he says, "from all the observations I have made, this progress seems always to have proceeded in the direction of a line bisecting the segment, that is to say, those portions of concentric circles are never inscribed, but always circumscribed; and for this reason it appears, that those circles of which segments are exhibited to our observation must be increasing and not diminishing in their diameters."

Dr. Withering ascribed them to their true cause.

Although Dr. Hutton has overlooked the real origin of these appearances, Dr. Withering has ascribed them to their true cause; but his remarks are confined to one species of agaric (the *ag. orcales* of his Arrangement), and do not appear to have been confirmed by any subsequent observation of their annual progress.

"I am satisfied," says he, "that the bare and brown, or highly clothed and verdant circles in pasture fields called Fairy-rings are caused by the growth of this agaric." "Where the ring is brown and almost bare, by digging up the soil to the depth of about two inches, the spawn of the fungus will be found of a grayish white colour; but where the grass has again grown green and rank, I have never found any of the spawn existing."

\* Edinburgh Transactions.



Had Dr. Withering frequently repeated this examination of the soil he would have corrected the last remark, which is not universally true, as the grass may at some period be found luxuriant even over the undecayed spawn. During the growth of the fungi, they so entirely absorb all nutriment from the soil beneath, that the herbage is for a while destroyed, and a ring appears bare of grass surrounding the dark ring. If a transverse section be made of the soil beneath the ring at this time, the part beneath the fungi appears paler than the soil on either side of it, but that which is beneath the interior circle of dark grass is found on the contrary, to be considerably darker than the general surrounding soil. But in the course of a few weeks after the fungi have ceased to appear, the soil where they stood grows darker, and the grass soon vegetates again with peculiar vigour; so that I have seen the surface covered with dark grass, although the darkened soil has not exceeded half an inch in thickness, while that beneath has continued white with spawn for about two inches in depth.

Spawn of fungi sometimes found under the luxuriant grass.

The section of the space occupied by the white spawn has in general nearly the same form, and may be compared to that of a wave proceeding from the centre outwards, as its boundary on the inner side ascends obliquely toward the surface, while its exterior termination is nearly in a vertical position. The extent occupied by the spawn varies considerably according to the season of the year, being greatest after the fungi have come to perfection, and is reduced to its smallest dimensions, and may in some cases not be discernible, before the next year's crop begins to make its appearance.

Progressive course of the spawn.

For the purpose of observing the progress of various circles I marked them three or four years in succession, by incisions of different forms, by which I could distinguish clearly the successive annual increase, and I found it to vary in different circles from eight inches to as much as two feet. The broadest rings that I have seen were those of the common mushroom (*ag. campestris*); the narrowest are the most frequent, and are those of the champignon (*ag. oreades* of Dr. Withering). The mushroom accordingly makes circles of largest diameter, but those of the

Annual increase of the circle various.

Broadest when from the common mushroom: narrowest from the champignon.

Three other species have the same effect. champignon are most regular. There are, however, as many as three other fungi that exhibit the same mode of extension, and produce the same effect upon the herbage. These are the *ag. terreus*, *ag. procerus*, and the *lycoperdon bovista*, the last of which is far more common than the two last mentioned agarics.

Confirmation of this cause. There is one circumstance that may frequently be observed respecting these circles, which can satisfactorily be accounted for, according to the preceding hypothesis of the cause of their increase, and may be considered as a confirmation of its truth. Whenever two adjacent circles are found to interfere, they not only do not cross each other, but both circles are invariably obliterated between the points of contact: at least in more than twenty cases, I have seen no one instance to the contrary. The exhaustion occasioned by each obstructs the progress of the other, and both are starved.

Different fungi stop the progress of each other. I think it also not unworthy of observation, that different species of fungi appear to require the same nutriment; for in a case of interference between one circle of puff-balls and another of mushrooms, they did not intersect; but I cannot say positively that I have seen more than one instance.

Circle interrupted by a tree. I once found that a tree had interrupted the regular progress of a circle; but this appeared to be only a temporary impediment, as the extension had proceeded at the usual rate, and by passing obliquely from each side into the soil beyond the tree, had given the ring the form of a kidney, so that another year or two would probably reunite the two extremities into one curve surrounding the tree.

The spawn will not vegetate again on the spot for some time. Being desirous of ascertaining in what length of time a soil might again recover the power of producing a fresh crop of fungi, I cut a groove, in one or two instances, along the diameter of a mushroom-ring, and inserted a quantity of spawn taken from its circumference, with the hope of seeing it vegetate for some distance near the centre; but the experiment failed altogether: and as I shortly after quitted my residence in the country, I had no opportunity of repeating the experiment, and must leave it to be prosecuted by those who are more favourably circumstanced.

## IX.

*Account of a Musical Instrument, called an Organized Lyre, invented by Mr. ADOLPHUS LEDHUY, late Geometrical Surveyor of Forests, of Coucy-le-Château, in the Department of the Aisne\*.*

THE object of the author was simply to improve the guitar-lyre, but by a simple mechanism he has rendered the sounds of this new instrument susceptible of several different tones or stops, by means of which the performer may imitate several instruments, such as the lyre, the piano forte, the harp, &c.; while at the same time it is as easy to play upon as the guitar-lyre, being fingered in the same manner, and not more inconvenient for carriage. In accompaniments, solos, and quartettes, or with several other instruments, it answers equally well: and, when it was submitted to the examination of the first artists in Paris, the inventor received the most flattering encomiums.

Mr. Adolphus has likewise composed instructions for his new lyre, in which he details every particular necessary for learning to play on it without a master: and in a second part he has added examples and lessons of every kind, to point out the advantages derivable from his invention in gradations of tone and expression; so that any one, who plays already on the guitar, or lyre-guitar, may render himself familiarly acquainted with this instrument in less than a month.

The following is a description of the instrument.

1. The organized lyre has fifteen strings, separated into three distinct divisions, and embracing the compass of four complete octaves. The three divisions are called the base, tenor, and treble.

2. It has a row of six keys, which include the extent of three octaves. With these the pianoforte may be imitated, but the sounds produced are more soft.

\* Sonnin's Bibliothéque Physico-économique, July, 1807, p. 61. The inventor has taken out a patent for this instrument in France.

Mute.

3. By means of a mute the performer may change the sound of the instrument, either gradually or instantaneously, from the loudest of which it is capable to the softest, or the contrary.

Mode of applying the mute.

To apply this mute the performer has not the least occasion to employ his hand, or stop his performance: all that is required is to press with his arm on a pedal, which is precisely at the place where the arm rests habitually on the instrument, and to increase or diminish this pressure, till the mute produces the desired effect.

Two necks for fingering.

4. The instrument has two necks, each with six strings, which are fingered in the same manner as the guitar-lyre.

Case.

5. The case of the instrument, which is indispensably necessary for its conveyance from place to place, is equally so for playing on it; because, the performer being obliged to have the left knee raised a little, the better to support the instrument, and to give freedom of movement to the arm, he rests his foot on the box, out of which rises a stand for the music, which may be raised or lowered at pleasure. This stand folds up so as not to increase the size of the case, and adds but little to its weight.

## X.

*A Botanical and Economical Account of Bassia Butyracea, or the East India Butter Tree. By W. ROXBURGH, M. D.\**

## BASSIA BUTYRACEA.

*Polyandria monogynia.*

Generic character.

**C**ALYX beneath, four or five leaved. Corol, one petalled: border about eight cleft. Berry superior, with from one to five seeds.

Specific character.

*Bassia butyracea.* Roxburgh.

Calyx five-leaved; stamens thirty or forty, crowning the subcylindric tube of the corol.

\* From the Asiatic Researches, Vol. VIII.

*Fulwah;*

*Fulwah*, *phulzarah*, or *phulwara*, of the inhabitants of the *Almorah* hills, where the tree is indigenous. Flowering time, in its native soil, the month of *January*; seeds ripe in *August*.

Trunk of the larger trees, straight, and about five or six feet in circumference. Bark of the young branches smooth, brown, and marked with small ash-coloured specks.

Leaves alternate, about the ends of the branchlets, petioled, obovate-cuneate, obtuse-pointed, entire; smooth above, villous underneath; veins simple, and parallel; length, six to twelve inches; breadth, three to six.

Petioles, from one to two inches long.

Stipules, if any, minute, and caducous.

Flowers numerous, round the base of the young shoots and from the axils of the lower leaves, peduncled, large, pale-yellow, drooping.

Calyx, four, five, or six leaved (five is by far the most common number); ovate, obtuse, covered externally with ferruginous pubescence, permanent.

Corolla; tube subcylindric, length of the calyx; border of eight, spreading, oblong, obtuse divisions, longer than the tube.

Stamens; filaments from thirty to forty, about as long as the tube of the corolla, and inserted on its mouth. Anthers linear-oblong.

Pistil, germe conical, (ten or twelve celled, one seeded,) downy, surrounded with a downy nectarial ring. Style longer than the stamens; stigma acute.

Berry oblong, generally pointed by a remaining portion of the style; smooth, fleshy, containing one, two, or three, rarely more, large seeds; the rest not ripened.

Seeds oblong, rather round than flat, but differing in shape according to the number contained in each fruit; smooth, shining, light brown, with a long, lanceolate, lighter coloured, less smooth, umbilical mark on the inside.

This tree, which is rendered interesting on account of its seeds, yielding a firm butyraceous substance, resembles

Resembles *bassia latifolia*.

*bassia latifolia*, (see *Coromandel Plants*, Volume I, No. 19; also *Asiatic Researches*, Volume I, page 300,) so much as scarce to be distinguished from it, except by the corol and stamina.

Difference in the corols,

Here (in *bassia butyracea*) the corol is of a thin texture, with a tube nearly cylindric, and border of eight, large, spreading, oblong segments. There (in *bassia latifolia*) it is thick and fleshy, with a gibbous, indeed almost globular tube; and border of generally more than eight, small, cordate, rather incurved segments.

and stamina.

Here, the stamina, from thirty to forty in number, have long filaments inserted on the mouth of the tube of the corol. There they are fewer in number; have very short filaments, and are arranged in two, or three series, completely within the tube, to which they are affixed.

Other species.

It may not be improper to notice here some other species of the same genus. The following Botanical description of *bassia longifolia*, Linn. *Mant.* page 563, I have been favoured with by Doctor Klein, of *Tranquebar*, and the account of its economical uses by the Reverend Doctor John of the same place.

*Description by Doctor Klein.*

*Bassia longifolia* described.

Calyx, Perianth; monophyllum, 4-partitum; laciniis ovatis, acutis, coriaceis, extus tomento ferrugineo obductis, persistentibus.

Corolla monophylla, campanulata; tubo cylindraco, inflato, carnosio, limbo 8-partito; laciniis lanceolatis, erectis.

Stamina, filamenta 16, brevissima, in duos ordines divisa, quorum octo ad incisuras laciniarum, octo in tubo corollæ inserta. Antheræ lineares, setacæ, acutæ, extus pilosæ, limbo breviores.

Pistil: Germen superum, ovatum. Stylus setaceus, corolla duplo longior. Stigma simplex.

Pericarp: drupa oblonga, 1-3 sperma, carnosio, lactescens. Seminibus subtrigonis oblongis.

Arbor magna; ramis sparsis, erectis, horizontalibusque.

Folia sparsa, petiolata, lanceolata, acuta, integerrima, glabra, venosa.

Flores longe-pedunculati, axillares, solitarii, et aggregati.

1st. The

- 1st. The oil, pressed from the ripe fruit, is used as a common lamp oil, by those who cannot afford to buy the oil of the cocoa-nut. It is thicker, burns longer, but dimmer, smokes a little, and gives some disagreeable smell. Oil used in lamps.
- 2d. It is a principal ingredient in making soap, and therefore often bears the same price with the oil of the cocoa-nut. for making soap.
3. It is, to the common people, a substitute for ghee, and cocoa-nut oil, in their curries and other dishes. They make cakes of it, and many of the poor get their livelihood by selling these sweet oil cakes. in cookery,
- 4th. It is used to heal different eruptions, such as the itch, &c. and in medicine.
- 5th. The cake (or *sukey*) is used for washing the head; and is carried, as a petty article of trade, to those countries, where these trees are not found. The cake.
- 6th. The flowers, which fall in *May*, are gathered by the common people, dried in the sun, roasted, and eaten, as good food. They are also bruised, and boiled to a jelly, and made into small balls, which they sell or exchange, for fish, rice, and various sorts of small grain. Flowers eaten.
- 7th. The ripe fruit, as well as the unripe, is eaten by the poor, as other fruits. Of the unripe, the skin is taken off, and after throwing away the unripe kernel, boiled to a jelly, and eaten with salt and *capsicum*. Fruit eaten.
- 8th. The leaves are boiled with water, and given as a medicine, in several diseases, both to men, and to cattle. Leaves a medicine,
- 9th. The milk of the green fruit, and of the tender bark is also administered as a medicine. and milk,
- 10th. The bark is used as a remedy for the itch. and bark,
- 11th. The wood is as hard, and durable, as teak wood; but not so easily wrought, nor is it procurable of such a length for beams, and planks as the former; except in clay ground, where the tree grows to a considerable height; but, in such a soil, it produces fewer branches, and is less fruitful, than in a sandy, or mixed soil, which is the best suited for it. In a sandy soil, the branches shoot out nearer to the ground, and to a greater circumference, and yield more fruit. These trees require but little attention; beyond watering them during the first two or three years, in the dry season. Being of so great use, we have here  
whole

whole groves of them, on high, and sandy grounds, where no other fruit trees will grow.

Flowers eaten  
by animals.

12th. We may add, that the owls, squirrels, lizards, dogs, and jackals, take a share of the flowers; but the vulgar belief is, that the latter, especially in the time of blossom, are apt to grow mad, by too much feeding on them.

*Bassia obovata.*

*Bassia obovata*, Forster's *Prod.* No. 200: a native of the Isle of *Tanna*, in the South Sea. Of this species I possess no other account than the definition, which corresponds with the habit of the genus. If Forster has left us no account of the uses of the tree, it may be worth while to make inquiry, when an opportunity offers.

Shea a species  
of the same  
genus.

Park's *shea*, or butter tree of *Africa*, we have reason, from his description, and figure, as well as from analogy, to suppose a species of this same genus. At page 352 of his travels in the interior of *Africa* he says, "The appearance of the fruit evidently places the *shea* tree in the natural order of *sapotæ*, (to which *bassia* belongs,) and it has some resemblance to the *madhuca* tree (*bassia latifolia*), described by Lieutenant Charles Hamilton, in the *Asiatic Researches*, Volume I, page 300.

Park's account  
of it.

"The people were every where employed in collecting the fruit of the *shea* trees, from which they prepare a vegetable butter, mentioned in the former part of this work\*. These trees grow in great abundance all over this part of *Bambarra*. They are not planted by the natives, but are found growing naturally in the woods; and in clearing woodland for cultivation, every tree is cut down but the *shea*. The tree itself very much resembles the *American oak*; and the fruit, from the kernel of which, first dried in the sun, the butter is prepared, by boiling the kernel in

\* This commodity, *shea toulou*, which, literally translated, signifies *tree-butter*, is extracted, by means of boiling water, from the kernel of the nut, has the consistence and appearance of butter, and is in truth an admirable substitute for it. It forms an important article in the food of the natives, and serves also for every domestic purpose in which oil would otherwise be used. The demand for it is therefore great. Park's *Travels in Africa*. Page 20.

water



water, has somewhat the appearance of a *Spanish olive*. The kernel is enveloped in a sweet pulp, under a thin green rind; and the butter produced from it, besides the advantage of its keeping the whole year without salt, is whiter, firmer, and to my palate, of a richer flavour, than the best butter I ever tasted made of cows milk. The growth and preparation of this commodity seems to be amongst the first objects of *African* industry, in this and the neighbouring states; and it constitutes a main article of their inland commerce." Park's Travels in *Africa*, page 203-8.

In the following account of the *bassia butyracea*, by Bassia Butyracea. Mr. Gott, we find the people of *Almorah* eat the dregs, left after the finer parts have been extracted; consequently there can be little doubt of the wholesomeness of the pure vegetable butter itself. The thick oil of *bassia latifolia*, and *longifolia*, the natives of various parts of *India* either use alone, or mixed with ghee (clarified butter), in their diet.

On captain Hardwicke's departure for *England*, in the beginning of 1803, he gave me a small quantity of the above-mentioned substance, observing, that the only account he could give me of it was, that it was reported to him to be a vegetable product from *Almorah*, or its neighbourhood, where it is called *fulwah*, or *phulwarah*. In consequence of this information I applied to Mr. Gott, (who is stationed in the vicinity of that country,) to make the necessary enquiries; and from him I procured an abundance of well preserved specimens, at various times, in leaf, flower, and fruit. From these, and that gentleman's account of the tree, and its product, the foregoing description was taken. Some given the author in 1803.

The same sample, which I got from captain Hardwicke in *January*, 1803, I have still by me. It remains perfectly sweet, both in taste and smell. Its flavour is that of cloves; having, I presume, been perfumed with that spice, previously to its falling into his hands, a practice mentioned in the following narrative. At this instant the thermometer is at ninety-five, and for these six weeks, it has rarely been below ninety, and has often risen to one hundred, or more, yet it continues about as firm as butter is in *England* during winter. Keeps well. Consistent.

Mr. Gott's

Account of  
the tree.

Mr. Gott's account of the tree, and its product, is as follows:—

Native country.

The tree producing a fat-like substance, known in this country by the name of *phulwah*, is a native of the *Almorah* hills; and known there by the same name. The tree is scarce, grows on a strong soil, on the declivities of the southern aspects of the hills below *Almorah*, generally attaining the height, when full grown, of fifty feet, with a circumference of six. The bark, of such specimens as I

Nut.

have been able to obtain, is inclined to smoothness, and speckled; it flowers in *January*, and the seed is perfect about *August*, at which time the natives collect them, for the purpose of extracting the above substance. On opening the shell of the seed or nut, which is of a fine chesnut colour, smooth, and brittle, the kernel appears of the size and shape of a blanched almond; the kernels are bruised,

Fat expressed.

on a smooth stone, to the consistency of cream, or of a fine pulpy matter; which is then put into a cloth bag, with a moderate weight laid on, and left to stand, till the oil, or *fat*, is expressed, which becomes immediately of the consistency of hog's-lard, and is of a delicate white colour.

Use.

Its uses are in medicine; being highly esteemed in rheumatism, and contractions of the limbs. It is also much esteemed, and used by the natives of rank, as an unction, for which purpose, it is generally mixed with an *utr* of some kind. Except the fruit, which is not much esteemed, no other part of the tree is used.

Its difference  
from oil of  
*mawa*.

This tree is supposed to bear a strong affinity to the *mawa*, (*madhuca*, or *bassia latifolia*;) but the oil or *fat*, extracted from the seeds, differs very materially. The oil from the *mawa* is of a greenish yellow colour, and seldom congeals. That from the *phulwah* congeals immediately after expression, is perfectly colourless; and, in the hottest weather, if melted by art, will, on being left to cool, resume its former consistency. The oil from the seed of the *mawa*, if rubbed on woollen cloth, leaves as strong a stain as other oils or animal fat. The fatty substance from the *phulwah*, if pure, being rubbed on woollen cloth, will leave no trace behind.

The

The oil of *mawa* is expressed in considerable quantities about *Cawnpore*, and *Furruckabad*, and being mixed with, is sold as ghee,

This fatty substance very rarely comes pure from the hills, and receives more and more adulteration, (by adding the purest ghee,) as it passes down to the lower provinces: age gives it the firmness of pure tallow.

*Additional Remarks by the same, in consequence of a few Queries transmitted to Mr. GOTT.*

It is supposed there might be annually procured from twenty to thirty maunds, at the price of fourteen or fifteen rupees the maund. Farther remarks on it.

1st. It is never taken inwardly as a medicine, nor is it used in diet; further than that the dregs, after the purer fatty substance is expressed, are eaten, as a substitute for ghee, by the peasants, or labourers, who extract the fat.

2d. I have some pure, which has been by me ten months, and it has neither acquired colour, nor bad smell.

3d. After it is imported into *Rohilkhund*, it is scented with *utr*, (an essential oil,) and a little of the flour of *Indian* corn (*zea mays*) is added, to increase its consistency. N. B. This flour is added on account of its peculiar whiteness.

4th. If it is clean, and free from dirt, it never undergoes any purification; if the contrary, it is heated, and filtered through a coarse cloth.

5th. The flowers are never used. The pulp of the fruit is eaten by some; it is of a sweet, and flat taste.

The timber is white, soft, and porous; and is never made any use of by the natives. It is nearly as light as the *semul*, or cotton tree (*bombax heptaphyllum*).

## XI.

*Observations on Werner's Silex Schistosus Politorius, Polierschiefer, from Billin, in Bohemia\*.*

Where found.

Described.

**T**HIS substance, called *polishing slate*, is found about three miles south of Billin, in Bohemia, immediately under the vegetable mould, and less than a yard deep. It is of a yellowish colour, and slaty texture; has an earthy appearance; and leaves a coloured mark on cloth. Between the fingers it is easily reduced to a powder, which is a little rough to the feel; it adheres strongly to the tongue; it is infusible. Its specific gravity according to Mr. Haberle is 0.6; and if left twelve hours in water 100 parts absorb 117. In Saxony it is known in the shops by the name of *silver tripoli*.

Stratum described.

In the place where I observed it, near the top of a pretty high hill, it forms the superior part of a stratum, which increases in density as you penetrate into it; and in some places at the depth of two yards it is compact, with a yellowish and somewhat shining aspect, like that of certain semiopals: but it is not so hard, or so heavy. From every thing I observed on the spot, the polishing slate is nothing more than a portion of this stratum, the texture of which is loosened and altered by decomposition. According to Mr. Reuss, who lives at Billin, the stratum includes remains of vegetables, and impressions of fish. Every thing besides indicates, that it is a recent alluvial production.

Mr. Bucholz has analysed both the polishing slate and the adhesive slate, *klebschiefer*, that accompanies the menilite of Menil-Montant, which had been considered as a variety of it: and as Mr. Klaproth has made a more full and complete analysis of the *Klebschiefer* than that he first gave the public, we shall here present the three analyses in a comparative view.

	Polishing slate		Adhesive slate	
	by Bucholz.		by Bucholz.	by Klaproth.
Silex	-	79	58	62.5
Alumine	-	1	5	0.75
Lime	-	1	1.5	0.25
Oxide of Iron	-	4	9	4
Water	-	14	19	22
Magnesia	-	-	6.5	8
Carbon	-	-	-	0.75
		99	99	98.25

\* Journal des Mines, N. 121, p. 77.

The oxide in the analysis of the adhesive slate by Bucholz was part of iron, part of manganese: and in the analysis by Klaproth the gas that escaped is included in the .22 of water. He likewise found an alkali present, but in too small quantity to be weighed.

### SCIENTIFIC NEWS, &c.

*Tabellarische Uebersicht der chemisch einfachen und zusammengesetzten Stoffe: &c. A tabular View of simple and compound chemical Substances, with their Synonimes, according to the newest Discoveries; by Fred. Stromeyer, M. D. and Prof. at Gottingen. 32 whole Sheet Tables. 1806.*

PROF. STROMEYER has here given a systematic arrangement of the different substances, that are the particular objects of chemical science, with a pretty copious collection of synonimes in German, Latin, French, and English. The only innovation he has allowed himself, according to his preface, is the classing of oil, sugar, starch, gluten, and several other vegetable and animal matters, as oxides with compound radicals, consisting either of carbon and hydrogen, or carbon, hydrogen, and nitrogen. Among these he makes wax differ from fixed oil only in being more oxidized; and adipocere from fat in the same manner. By the by, the only name he gives for adipocere in the English column is *fat-wax*, a literal translation of the German *fettwachs*.

Stromeyer's  
chemical  
tables.

With these tables prof. S. sent me an account of a paper he read to the Gottingen Society, Oct. 12, 1805, containing part of the results of his chemical investigation of the union of hidrogen with metals. On the present occasion he confined himself to that of arsenic. This he observes succeeds best by digesting an alloy of fifteen parts of tin and one of arsenic with concentrated muriatic acid in a retort connected with the pneumatic apparatus. He was led to this by the observation of Proust, that muriatic acid completely frees tin from arsenic: and on this occasion he convinced himself by experiments, that the fetid hidrogen

Investigation of  
the compounds  
of hidrogen  
with metals.

Best process  
for arsenicated  
hidrogen.

gas

gas evolved, when the tin of the shops is dissolved in muriatic acid, is not a compound of tin and hydrogen, as Fourcroy conjectures in his *Chemical System*, Vol. VI, p. 43, (English Ed.) but of arsenic and hydrogen. When arsenicated hydrogen gas is formed in the manner directed above, a very pure oximuriate of tin is obtained.

Mistake of Fourcroy.

Partly reduced to a liquid by cold.

Though the arsenicated hydrogen gas retains its aeriform state under every known degree of atmospheric temperature and pressure, prof. S. condensed it so far as to reduce it in part to a liquid, by immersing it in a mixture of snow and muriate of lime, in which several pounds of quicksilver had been frozen in the course of a few minutes.

Its properties.

The smell of this gas, he says, is not alliaceous, as has been said, though in the highest degree fetid and nauseating. Warm blooded animals, particularly birds, were killed in a few minutes in an atmosphere containing one tenth of this gas: but frogs and insects lived in it two or three hours. Blood fresh drawn from a vein became black after standing a few minutes in contact with it; and in six or eight hours a layer of reduced arsenic was visible on its surface. The rise of the fluid in the jar likewise proved, that absorption had taken place; but no such change appeared in blood exposed to pure hydrogen gas. Neither sirup of violets, infusion of litmus or turmeric, nor paper stained with them, had its colour in the least altered by the gas. Infusion of galls, and alkaline sulphurets or hydrosulphurets, have no observable action on it. It is not absorbed by alkalis; and scarcely in any perceptible degree by distilled water, particularly if freed from air as much as possible by long ebullition. If however the water contain atmospheric air, or if the arsenicated hydrogen gas be mixed with atmospheric air, not only absorption but decomposition takes place, part of the hydrogen and of the arsenic combining with oxygen so as to form water and brown oxide of arsenic, and part appearing in the form of pure hydrogen gas and metallic arsenic. Hence it is, that, as Proust observed, a jar in which this gas is kept over water will acquire a coating of arsenic and its oxide.

Effects on blood.

Action with reagents.

Absorbed by water only when containing air.

Effects of combustion with different pro-

The arsenicated hydrogen gas burns in contact with atmospheric air, and a thin coat of arsenious acid and brown oxide

oxide of arsenic is deposited on the sides of the vessel. If it be mixed with twice its volume of atmospheric air, the product of the combustion is arsenious acid and water. With six times its bulk of atmospheric air it will not take fire. A mixture of it with an equal part of atmospheric air cannot be fired by the electric spark. With an equal bulk of oxygen gas it detonates violently, and the products are water and arsenious acid: with only half, or a third, of oxygen gas, oxide of arsenic likewise is formed, and part of the metal is reduced. With five parts of oxygen gas it burns without detonation. Arsenic acid is formed in none of these processes. The combustion having been tried with various proportions of the two gasses in Volta's eudiometer, the mean of the experiments gave 0.72 of a cubic inch of oxygen gas as the proportion required to burn 1-inch of arsenicated hydrogen gas, in which the hydrogen is fully saturated with arsenic at the common temperature.

portions of oxygen.  
1 part requires 0.72 of oxygen to burn it.

All acids, in which the oxygen is feebly combined, decompose arsenicated hydrogen gas. This phenomenon is very striking with nitric acid. While part of the hydrogen, being condensed by the oxygen of the acid, is converted into water, another part is set free. At the same time the whole [?] of the arsenic is separated in the metallic form, but is very quickly oxidized by the nitric acid, and at length acidified. The nitric acid acquires a yellow colour, and bubbles of nitrous oxide gas are extricated from it. The gas that ultimately remains is pure hydrogen mixed with nitrous oxide. Prof. Stromeyer employs the action of nitric acid on the arsenicated hydrogen gas, to calculate the proportion of its principles, which, according to him are 10.600 arsenic, and 0.219 hydrogen.

Action of acids.  
Nitric.

Nitrous acid decomposes it instantaneously, and arsenious acid is deposited.

Nitrous.

Oxygenized muriatic acid decomposes it, part of the hydrogen and arsenic undergoing combustion, and the other being separated. Oxygenized muriatic acid gas brought into contact with it in narrow tubes acts upon it in the same manner as the liquid acid: but if the two gasses be mixed in a wide jar, the whole of the arsenic is instantly converted into arsenious acid, appearing as a white va-

Oxygenized muriatic.

pour;

pour; while part of the hydrogen forms water, and another part appears as pure hydrogen gas.

Other acids.

Sulphuric, phosphoric, and arsenic acid, equally decompose this gas; but the effect is produced very slowly, and the arsenic is deposited for the most part in the metallic form. In the decomposition of this gas by acids in general, a very perceptible increase of volume takes place at the commencement of the process.

Acid solutions of metals.

Most of the solutions of the metals in acids likewise decompose it. The hydrogen is in part burned by the disoxygenation of the metallic oxide, and in many cases by the disoxygenation of the acid likewise, with which the metal was combined, and forms water, while another part is converted into pure hydrogen gas. Thus the other component part, the arsenic, is separated, and in most cases, at least at the commencement, appears as a pure metal: but in general, if the acid have a weak affinity for oxygen and the oxide, or if the metal dissolved in it be highly oxidized, the arsenic is soon converted into oxide, and thence into arsenious, or sometimes into arsenic acid. This is most striking with the corrosive muriate of mercury, which in this experiment is converted into mild muriate. This metallic salt is such a sensible test of arsenicated hydrogen gas, that it is capable of detecting it when mixed with ten thousand times its bulk of atmospheric air, or of pure hydrogen, as was found by experiment.

Corrosive muriate of mercury

a very sensible test of it.

Remarkable effect of turpentine.

Prof. Strohmeyer concluded with a remarkable experiment, showing the effect of oil of turpentine on arsenicated hydrogen gas, all the phenomena of which however do not appear easily explicable. Ten cubic inches of the gas being confined over this essential oil, all the arsenic was separated in the course of ten hours, so as to leave the hydrogen gas pure. No perceptible deposition of metal or oxide took place; but the oil appeared milky and viscous; and after some time small six-sided crystals, terminating in pyramids, were found adhering to the sides of the vessel. These crystals, being set on fire, burnt like oil of turpentine, emitting at the same time a very distinguishable smell of arsenious acid. A similar appearance took place on transmitting arsenicated hydrogen gas through oil of turpentine.



# I N D E X.

## A.

- ACCIDENTS** from the sudden decomposition of potash, 146
- Acid** contained in sweat, 63—In urine, 67—In milk, 72
- Albinoes** of Great Britain, account of, 81
- Aldebaran**, or the Bull's eye, described, 3
- Alkalies**, decomposition of, 78, 156
- Allen**, Wm. Esq. and W. H. Pepys, Esq. on the quantity of carbon in carbonic acid, and on the nature of the diamond, 217
- Altitude**, meridian, new methods of finding, 324
- Analysis**—Of Siderite or Lazulite, 20—Of cream of tartar, 29—Of the pyrophysalite, 33—Of animal acids, 63—Of orpiment and realgar, 74—Of the several species of Peruvian bark, 108, 203—Of the fire-damp of coal-mines, 149—Of slate, 380
- Anderson**, Dr. J. on home-made wines, 356
- Anderson**, C. Esq. 318
- Andromeda's head**, its situation and description, 3, 173
- Angustura bark**, compared with that of Peru, 120
- Animal torpidity**, 161
- Antares** described, 6
- Aquarius**, its situation, 9
- Aquila**, described, 6
- Arc of the meridian** measured in India, 309
- Arcet**, M. de, his process for obtaining pure barytes, 23
- Arcturus** described, 2
- Aries** described, 4

VOL. XIX.

- Attraction of surfaces, 14
- Auriga, its situation, 4

## B.

- Banks**, Sir J. on the revival of an obsolete mode of managing strawberry beds, 95—Letter to, on the formation of the bark of trees, 241—On the economy of bees, 253—See 318
- Barclay**, Dr. 318
- Bark of trees**, formation of, 241
- Bark**, Angustura, 120
- of cherry-tree, 119
- of oak, 119
- Peruvian, experiments on several species of, 106, 203—Compared with various vegetable substances, 119
- of white willow, 120
- Barker**, Mr. 335
- Barraud**, Mr. description of his mercurial pendulum, 258
- Barytes**, pure, preparation of, 23
- hydroguretted sulphuret of, 25
- Bason**, mineral, in Wales, 361
- Bassia butyracea**, the, described, 372
- obovata, 376
- Beccaria**, M. 50, 59
- Bees**, natural history and economy of, 250
- Bennet**, Mr. his electrical experiments, 44
- Berger**, Dr. on the heights of several places in France, 272
- Bergman**, M. on orpiment and realgar, 74
- Bernhardi**, M. see Trommsdorff
- Berthollet's** electrical experiments, 51
- Berzelius**, see Hisinger
- Black**, Dr. 199, 201
- Blight in wheat**, its cause and prevention, 338

b

Blind

# I N D E X.

- Blind restored to sight, 99  
 Blumenbach, Professor, on Albinos, 82  
 Bonpland, M. 116  
 Bouillay, *see* Vauquelin  
 Bradley, Dr. on the undulatory velocity of light, 144  
 Brougham, Mr. on coloured concentric rings between object glasses, 195  
 Buch, M. Von, 318  
 Bucholz on the analysis of slate, 380  
 Butter-tree of the East Indies, a botanical and economical account of, 372  
 Buzzi, M. on Albinos, 82
- C.
- Cader Idris, a mountain in Wales, formerly a volcano, 237  
 Cadet, C. A. on a property of camphorated water, 26—On mineral acids, 64  
 Calomel, new mode of preparing, 240  
 Calorimeter, a newly invented one, 197  
 Camphorated water, 26  
 Cancer, the constellation, described, 4  
 Capella, its situation, 2, 4, 173  
 Capricorn, its situation and description, 8  
 Carbon, quantity of, in carbonic acid, 216  
 Cassiopeia described, 1  
 Cataracts of the eyes removed from patients born blind, 99  
 Cavallo, M. his electrical multiplier, 45  
 Cavendish, Mr. 101—His discoveries in electricity, 43—His analysis of common air, 87  
 Centaury compared with Peruvian bark, 120  
 Cepheus, its situation pointed out, 2  
 Chainnes, Duke of, on coloured concentric rings produced by laying two object-glasses upon each other, 194  
 Chemical theory, the modern, objections to, 170  
 Chemical tables, 381
- “Chemist, A,” his correction of some mis-statements in the account of Mr. Davy’s decomposition of the fixed alkalies, 147  
 Cherry-tree bark compared with that of Peru, 119  
 Cheselden on the cataract of the eye, 99, 105  
 Chevreul, *see* Robiquet  
 Chinese radish oil, economical and medicinal uses of, 79  
 Cinchona, experiments on several species of 106, 203  
 Cogan, Dr. on the culture of the poppy for oil, 282  
 Colours, experiments on the cause of, 121, 177  
 Columella, 175  
 Comet expected last January, observations on, 263  
 Constellations, a guide to, 1, 11, 173  
 Cor Leonis, its situation, 4  
 Corona Borealis, its situation and description, 6  
 Coromandel coast, measurement of a degree at, 309  
 Corvus, its situation in the heavens, 6  
 Cetus, its situation and description, 9  
 Coulomb, M. his electrical balance, 45  
 Crater, its situation in the heavens, 6  
 Crawford, Dr. his experiments on heat erroneous, 199, 200, 201  
 Cream of tartar contains lime, 20  
 Cuthbertson, Mr. his electrometer, 45, 153  
 Cygnus, description of its appearance and situation in the heavens, 2, 52
- D.
- Dalton, Mr. on the gas of standing water, 150  
 D’Arcet, *see* Arcet  
 Darwin, Dr. 248, 329  
 Davis, Mr. his improved machine for painters and glaziers, 18—On the blight in wheat, 338

# INDEX.

Davy, Mr. on the decomposition of alkalis, 13; 78, 146, 156, 172—On the analysis of air, 88—On some chemical agents of electricity, 37

Decandolle, M. abstract of his Essay on the medicinal properties of plants, compared with their external form and natural classification, 17

Decay of wood, prevention of, 328

Delphinus, its situation, 9

De Luc, Dr. 199

Deschamps, jun. M. his discovery of a peculiar salt in Peruvian bark, 212

Destouches, M. on the lime in cream of tartar, 20

Deyeux, M. on animal acids, 64

Diamond, experiments on the nature of the, 226

Dispan, M. his observations on the pretended attraction of surfaces, answered, 14

Donovan, Mr. his account of an extinct volcano in Britain, 237

Draco, the constellation, described, 2

Drugs, indication of their virtues, 17

Du Hamel, *see* Hamel

Du Pont, *see* Pont

Dytiscus on a pamphlet lately published by the Rev. S. Vince, on the cause of gravitation, 304—Answered, 344

## E.

Eclipse of the sun, 16th June, 1806, remarks on, 321

Ecliptic, pole of, directions for finding, 10

Edinburgh, a new society of natural history established at, 317

Electricity, 37

Estner, M. 20

Eudiometer, a new one, described, 86

Eys, Mr. S. N. Van, on poppy oil, 292

## F.

Fairy rings, 343

Family wine-making, improvements in, 353

Fire-damp of coal mines, experiments on, 149

Fisher, Mr. G. A. 291

Fixed stars, table of their distances from each other, 11

Fomalhaut, its situation, 9

Forster's *Bassia obovata*, 376

Fourcroy, M. his analysis of Peruvian bark, 115—Mistake in his Chemical System, 382

Fullerton, Lieut. Col. 318

Friesleben, Mr. 318

## G.

Gahn, M. on the fluoric acid contained in the stone called pyrophyllite, 36

Galvanic trough, improvement in, 148

Galvanism, 156, 170

Garnett, J. Esq. on the total eclipse of the sun on the 16th of June, 1806; with some new methods of finding the sun or moon's meridian altitude, and the approximate time, by altitudes taken near the time of noon, 321

Gemini, their situation and appearance, 3, 173

"Geognosy, Elements of," a work recently published, 319

Geological observations in France, concluded from Vol. XVIII. 272

Germander compared with Peruvian bark, 120

Gibber, Dr. on the non-existence of oxygen and hydrogen as bases of particular gases; the action of galvanism; and the compound nature of heat, 170

Glaziers, *see* Painters

Gleditsch,

# INDEX.

Gleditsch, M. 17  
 Gmelin, M. 17  
 Gott, Mr. his account of the vegetable butter of India, 377, 378  
 Gough, Mr. on torpidity in animals, 161  
 Grafting, advantages of, 175  
 Grandi, M. de, 79  
 Grass, striped or ribband, excellent food for cattle, 300  
 Gravitation, investigation of its causes, 304, 344  
 Gravity, specific, of air, 145—Of light 143, 145—Of water, 145  
 Grenville, Hon. C. F. 361  
 Grew, on the formation of the bark of trees, 241  
 Guide to the constellations, 1, 11—Corrected, 173  
 Guyton de Morveau, M. on lazulite, 23—On cohesion, 59—On the analysis of air, 88—On the combustion of the diamond, 216

## H.

Haberle, M. 380  
 Habits of animals, remarkable effects of, 255  
 Hales, the first who observed the absorption of air in certain cases, 87—On the comparative velocity of air and water, 144—His theory of the formation of the bark of trees, 242  
 Hallett, Mr. on the use of tobacco-water in preserving fruit crops, by destroying insects; and on the use of the striped or ribband grass, 298, 301  
 Hamel, Du, on the formation of the bark of trees, 242  
 Hatchett, Charles, Esq. communication from, containing a description of a new eudiometer, by W. H. Peppys, Esq. accompanied with experiments elucidating its application, 86

Hauy, M. 37  
 Heights of various places in France, concluded from Vol. XVIII. 272, 277  
 Heim, M. his analysis of the siderite, 20  
 Helvetius on Albinoes, 82  
 Henry, Dr. W. his experiments on the fire-damp of coal-mines, 149  
 Hercules, its situation and description, 7  
 Herschell, Dr. on the cause of coloured concentric rings between two object-glasses laid upon each other, as discovered by Sir Isaac Newton, 124, 177—On the nature of the new celestial body discovered by Dr. Olbers, and on the comet which was expected to appear last January in its return from the sun, 259  
 Herder, Mr. 318  
 Hisinger and Berzelius, their analysis of a stone called pyrophyssalite, 33  
 Home, Ev. Esq. his account of two children born with cataracts in their eyes, to shew that their sight was obscured in very different degrees; with experiments to determine the proportional knowledge of objects acquired by them immediately after the cataracts were removed, 99—On the structure of the different cavities which constitute the stomach of the whale, compared with those of ruminating animals, with a view to ascertain the situation of the digestive organ, 348  
 Humboldt, M. Von, 116, 318  
 Hunter, Mr. J. on the economy of bees, 256—On the cavities in the stomach of the whale, 350  
 Hutton, Dr. remarks on his theory of granite, 319—His observations on fairy rings, 368  
 Huygens, M. 121  
 Hydra, its situation described, 6  
India,

# I N D E X.

## I.

India, measurement of a degree in, 309  
 Insects destroyed by tobacco-water, 298, 301  
 Irvine, Dr. 199  
 Isenflamm, 17

## J.

Jameson, R. Esq. 318—His system of mineralogy, 319  
 J. G. C. his improvement in the Galvanic trough, to prevent the cement from being melted, when the action is very powerful, 148  
 Jussieu, 17

## K.

Karsten, Professor, 318  
 Kirwan, R. Esq. 318  
 Klapproth, his experiments on the Lazulite of Vorau, 20—On the topaz, 37—On slate, 380—See 318  
 Knight, T. A. Esq. on raising new and early varieties of the potato, 97—On the advantages of grafting walnut, mulberry, and chesnut trees, 175—On the formation of the bark of trees, 241—On the economy of bees, 250

## L.

La Lande, his account of the relative situations of the different stars, by which the principal constellations may be distinguished, 1—Corrections of some errors in his catalogue, 174  
 Lambton, Major W. his account of the measurement of an arc of the meridian on the coast of Coromandel, 309  
 Language of brutes, 253  
 Laplace and Lavoisier's calorimeter defective, 197

Lavoisier, on the quantity of carbon contained in carbonic acid, 216—On the base of potash, 308  
 Lazulite, analysis of, 20  
 Lectures at St. Thomas's and Guy's Hospitals, 160  
 Ledhuy, Mr. A. his new musical instrument described, 371  
 Leo, its situation and appearance, 4  
 Libra, its situation in the heavens, 6  
 Light, specific gravity of, 143  
 Lime in cream of tartar, 28  
 Linæus, 17  
 Lyra, directions for discovering, 2, 6  
 Lyre, organized, 371

## M.

Macnight, Rev. T. 318  
 Malpighi's theory of the formation of the bark of trees, 241  
 Mammoth found in a perfect state 157  
 Martin, Mr. E. his description of the mineral bason in the counties of Monmouth, Glamorgan, Brecon, Caermarthen, and Pembroke, 361  
 Maskeleyne, Dr. 144  
 Matthews, W. Esq. on family wine-making, 353  
 Maupertuis, on albinos, 82  
 Meridian, measurement of an arc of, on the coast of Coromandel, 309  
 Meuder, Mr. 318  
 Milk, analysis of, 72  
 Mineral bason in Wales, 361  
 Mineralogy, 318  
 Mirbel on the formation of the bark of trees, 242  
 Mohs, Mr. F. 20, 318  
 Moll, Baron, 20  
 Mont Blanc, brief description of some mountains in the department of, 272  
 Morozzo, 219  
 Mountains in France, 272, 277  
 Musical instrument, called an organized lyre, 371

Nairne,

# INDEX.

N.

- Nairne, Mr. his electrical machine, 43  
 Neil, P. Esq. 318  
 Newton, Sir. I. his discovery of coloured concentric rings between two object-glasses, laid one upon the other, 121, 177—On light, 143  
 N: R. D. letter from, containing some remarks on, and emendations of La Lande's guide to the constellations, 173  
 Nutgalls compared with Peruvian bark, 119

## O.

- Oakes, Mr. 156, 307  
 Oil of the Chinese radish, 79  
 Olbers, Dr. on the nature of the new celestial body discovered by him, 259  
 Oliviero, Dr. Francis de, 80  
 Ophiucus, or Serpentarius, its situation and description, 7, 173  
 Orion described, 3, 4  
 Orpiment examined, 74

## P.

- Painters and Glaziers, improved machine for, 13  
 Pallas, M. his experiment at conquering the torpid disposition of a marmot, 169  
 Park, Mungo, his account of the butter-tree of Africa, 376  
 Parry, Dr. on the causes of the decay of wood, and the means of preventing it, 328  
 Paul, Mr. on camphorated water, 26  
 Pegasus, description of its appearance and situation among the stars, 5  
 Pendulum, a mercurial, described, 258  
 Pepsy, W. H. Esq. his new eudiometer described, 86—On the quantity of carbon in carbonic acid, and on the nature of the diamond, 216

- Perseus, the constellation, described, 4  
 Peruvian bark, *see* Bark.  
 Philomatos's account of an accident from the sudden deflagration of the base of potash, 146  
 Phosphorescence of bodies from the action of the electric explosion, 153  
 Pisces, its situation and description, 10, 174  
 Plants, medicinal properties of, 17  
 Playfair, Professor, on veins of minerals, 319  
 Plaz, 17  
 Pleiades, the, described, 3  
 Plot, Dr. 168  
 Pole of the ecliptic, directions for finding, 10  
 Pont de Nemours, M. Du, on the torpidity of animals, 161  
 Poppy, culture of, for oil, 282  
 Poske, Mr. 290  
 Potash, decomposition of, by Galvanism, 156  
 Potash and its base, experiments and observations on, 307  
 Pott, Mr. on the cataract of the eye, 106  
 Potatos, on raising new and early varieties of, 97  
 Prato, Dr. J. C. de, in answer to some observations of M. Dispan, on the pretended attraction of surface between oil and water, 14  
 Priestley, Dr. on the different kinds of air, 87  
 Procyon, its situation and appearance, 5  
 Proust, M. on orpiment, 75  
 Pyrophyssalite, description and chemical analysis of, 53

## R.

- Raphanus Sinensis, 80  
 Reade, Dr. J. description of his newly invented calorimeter, 197  
 Realgar examined, 74  
 Regulus, its situation, 4  
 Reus, M. 380

Rigel,

# I N D E X.

Rigel, its situation in the heavens, 3  
 Ritter, M, 23  
 Robiquet, on the preparation of pure barytes, 23  
 Robiquet and Chevreul on the spontaneous decomposition of the hydrogenated sulphuret of barytes, 25  
 Roofs of houses, improved, 266  
 Rouppe, 219  
 Roxburgh, Dr. his botanical and economical account of the butter-tree of the East Indies, 372  
 Roy, General, 315  
 Rumination in animals, 348

## S.

Sagittarius, its situation and description, 6  
 Salting and smoking meat, expeditious and simple process for, 80  
 Saussure, M. on albinos, 81, 83  
 Schroeter, M. on the planet *Vesta*, 264  
 Scientific News, 78, 157, 240, 317, 381  
 Scorpio described, 6  
 Seguin, M. a mistake of, relative to the aqueous infusions of Peruvian bark, 107  
 Siderite, the, analysis of, 20  
 Sight restored to two children born with cataracts, with experiments to determine the proportional knowledge of objects acquired by them immediately after restoration, 99  
 Sirius, described, 3  
 Skrimshire, jun. Mr. W. on the phosphorescence of bodies, from the action of the electric explosion, 153  
 Slate, analysis of, 380  
 Slating houses, new method of, 266  
 Salomé, M. 115  
 Spallanzani, Signor, 167  
 Specific gravity, *see* Gravity.  
 Spica Virginis, described, 6  
 Stars, an account of the relative situation of, by which the principal constellations may be distinguished, 1, 11, 178

Stomach of the whale, on the structure of, compared with that of ruminating animals, 348  
 Strawberry beds, management of, 95  
 Stromeyer, Dr. account of his chemical tools, 381  
 Surfaces, attraction of, 14  
 Sweat, analysis of, 63  
 Sylvester, Mr. C on the advantages of malleable zinc, and the purposes to which it may be applied, 11—On the decomposition of the fixed alkalis by Galvanism, 156—His experiments and observations on potash and its base, 307

## T.

Tan compared with Peruvian bark, 119  
 Tartar, cream of, contains lime, 20  
 Tennant, S. Esq. on the nature of the diamond, 217  
 Thenard, M. on the analysis of sweat, the acid it contains, and the acids of urine and milk, 63—On orpiment and realgar, 74  
 Thomson, Dr. T. on the fire-damp of coal mines, 150—*See* 318  
 Timber saved in building, 266  
 Tobacco-water, its use in destroying insects, 298, 301  
 Torpidity of animals, 161  
 Traill, Dr. his account of two children born in England, with the characteristics of Albinos, 81  
 Trommsdorff and Bernhardt, their analysis of the siderite or lazulite, 20  
 Tugwell, Mr. his new method of slating houses, described, 266

## V.

Van Eys, *see* Eys.  
 Vauquelin and Bouillay, their Report on a memoir of M. Destouches on the lime of cream of tartar, 20  
Vauquelin,

# I N D E X.

- Vauquelin, M. his experiments on the various species of cinchona, 106, 203
- Veins of minerals divided into two orders, 318
- Vesta, observations on the planet so called, 259, 264
- Vince, Mr. remarks on his pamphlet respecting the cause of gravitation, 304—Answered by the author, 344
- Vogel, 17
- Volcano, extinct, in Britain, account of one, 237
- Volta's pile, experimental observations on, 54
- U.
- Urine, analysis of, 67
- Ursa Major described, 1  
— Minor described, 2
- W.
- Walker, P. Esq. 318
- Ware, Mr. on the cataract of the eye, 100, 105
- Wasps, economy of, 256
- Water, camphorated, 26
- Water-proof leather, receipt for making, 335
- Werner, Professor, 318—Observations on his silix schistosis politorius polierschiefer, 380
- Wernerian Natural History Society at Edinburgh, 317
- Whale, stomach of the, on the structure of the different cavities of which it is constituted, 348
- Wheat, blight in, 338
- Wilka, 17
- Wilke, M. 48
- Willow bark compared with that of Peru, 120
- Wines made for family use, improvements in, 353
- Winter, Mr. R. on a method of finding the specific gravity of light, and his defence of the undulatory system, 143
- Withering, Dr. on fairy rings, 368
- W. N. on albinos, 84—On Dr. Crawford's theory of heat, 202—On finding a substitute for tobacco for the purpose of destroying insects, 301
- Wollaston, Dr. his improvements in electricity, 43, 44—On fairy rings, 367
- Wood, decay of, inquiry into the causes of, and the means of preventing it, 328
- Wright, Dr. 318.
- Y.
- Young, Dr. his experiments favourable to the undulatory system of light, 143
- Z.
- Zinc, malleable, uses to which it may be applied, 11

END OF THE NINETEENTH VOLUME.













