

Insects

6

67-226
Smithsonian
218

JOURNAL
OF THE
NEW YORK
ENTOMOLOGICAL SOCIETY

Devoted to Entomology in General

VOLUME XLIX, 1941



PUBLISHED QUARTERLY BY THE SOCIETY
NORTH QUEEN ST. AND MCGOVERN AVE.
NEW YORK, N. Y.

LANCASTER, PA.

THE SCIENCE PRESS PRINTING COMPANY
LANCASTER, PENNSYLVANIA

CONTENTS OF VOLUME XLIX

	PAGE
ABBOTT, CYRIL E.	
Concerning the Musculature of the Male Genitalia in Panorpa Nuptialis Gerst	43
The Sensory Basis of Courtship	217
ALEXANDER, CHARLES P.	
Records and Descriptions of Neotropical Crane-Flies (Tipulidæ; Diptera) XII	139
Records and Descriptions of Neotropical Crane-Flies (Tipulidæ; Diptera) XIII	345
AUSTIN, JEAN, AND C. H. RICHARDSON	
Ability of the Firebrat to Damage Fabrics and Paper	357
BELL, E. L.	
Two New Subspecies of Phlebodes Tiberius Moeschler	193
BELL, E. L., AND W. P. COMSTOCK	
The Synonymy of Papilio Coridon Poda, Papilio Phocion Fabricius and Others	371
BOOK NOTICES	76, 118, 119, 366
BURDETTE, WALTER	
See Mickey, George H.	
CARPENTER, JOHN	
See Mickey, George H.	
CARVER, C. W.	
See McCoy, E. E.	
CHAMBERLIN, RALPH V., AND STANLEY MULAİK	
On a Collection of Millipeds from Texas and New Mexico	57
CHARLES W. LENG	
Notice of Death	100
COMSTOCK, WILLIAM PHILLIPS	
See Johnson, Frank; See Bell, E. L.	
CUMLEY, R. W.	
See Mickey, George H.	
CURRAN, C. H.	
Some New Species of Mallophora Macquart (Asilidæ, Diptera)	269

DEC 18 1941

DAVIS, WILLIAM T.	
New Cicadas from North America with Notes	85
Charles W. Leng and the New York Entomological Society	189
DOBBINS, T. N.	
See Hawley, I. M.	
FORBES, WILLIAM T. M.	
The Positon of <i>Utetheisa Galapagensis</i> (Lepidoptera; Arctiidæ)	101
FOX, HENRY	
See Ludwig, Daniel	
GAUL, ALBRO T.	
Experiments on the Taste Sensitivity of <i>Dolichovespula Arenaria</i> Fab. (Hymenoptera, Vespidae)	367
HASKINS, CARYL P.	
Note on the Method of Colony Foundation of the Ponerine Ant <i>Bothroponera Soror</i> Emery	211
HATCH, MELVILLE H.	
A Second Supplement to the Indices to the Keys to and Local Lists of Nearctic Coleoptera	21
HAWLEY, I. M., AND T. N. DOBBINS	
Mortality Among Hibernating Larvæ of the Japanese Beetle with Special Reference to Conditions in the Winter of 1935-36	47
JOHNSON, FRANK, AND WILLIAM PHILLIPS COMSTOCK	
Anaea of the Antilles and Their Continental Relationships with Descriptions of New Species, Subspecies and Forms (Lepidoptera, Rhopalocera, Nymphalidæ) ..	301
LAFLEUR, LAURENCE J.	
Communal Disaffection in Ants	199
Civil Disturbances in Ant Communities	225
LUDWIG, DANIEL, AND HENRY FOX	
Further Studies of Conditons Influencing the Survival of Japanese Beetles Through Metamorphosis	65
MALKIN, BORYS	
Additions to the New Jersey State List of Coleoptera	285
McCoy, E. E., AND C. W. CARVER	
A Method for Obtaining Spores of the Fungus <i>Beauveria Bassiana</i> (Bals.) Vuill. in Quantity	205

McCoy, E. E.	
See Weiss, Harry B.	
Mickey, George H., John Carpenter, R. W. Cumley, and Walter Burdette	
Experiments on Culture Media in Regard to Oviposition and Mass Production of <i>Drosophila Melanogaster</i>	77
Mulaik, Stanley	
See Ludwig, Daniel	
Nabokov, V.	
On Some Asiatic Species of <i>Carterocephalus</i>	221
Lysandra Cormion, a New European Butterfly	265
PROCEEDINGS OF THE NEW YORK ENTOMOLOGICAL SOCIETY...111,	293
Richardson, C. H.	
See Austin, Jean	
Sherman, John D., Jr.	
Charles W. Leng	185
Soraci, Frank A.	
Hibernation of <i>Myllocerus Castaneus</i>	138
See Weiss, Harry B.	
Thomas, C. A.	
The Elateridæ of Pennsylvania	233
Timberlake, P. H.	
Ten New Species of <i>Stelis</i> from California (Hymen- optera; Apoidea)	123
Tinkham, E. R.	
Biological and Faunistic Notes on the Cicadidæ of the Big Bend Region of Trans-Pecos, Texas	165
Townsend, Charles H. T.	
An Undescribed American <i>Cephenemyia</i>	161
Weiss, Harry B., Frank A. Soraci, and E. E. McCoy, Jr.	
Notes on the Reaction of Certain Insects to Different Wave-Lengths of Light	1
Additional Notes on the Behavior of Certain Insects to Different Wave-Lengths of Light	149

Vol. XLIX

No. 1

MARCH, 1941

Journal

of the

New York Entomological Society

Devoted to Entomology in General

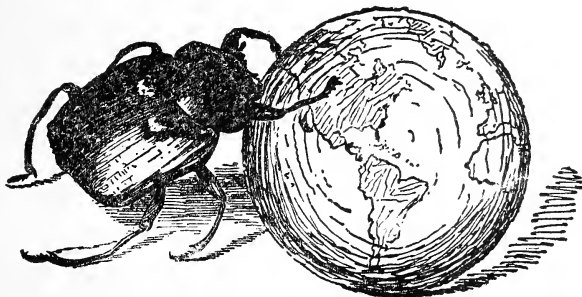

Edited by HARRY B. WEISS

Publication Committee

HARRY B. WEISS
HERBERT F. SCHWARZ

EDWIN W. TEALE
E. L. BELL

Subscription \$3.00 per Year

Published Quarterly by the Society
N. QUEEN ST. AND McGOVERN AVE.
LANCASTER, PA.
NEW YORK, N. Y.

1941

CONTENTS

Notes on the Reaction of Certain Insects to Different Wave-Lengths of Light By HARRY B. WEISS, FRANK A. SORACI, AND E. E. MCCOY, JR.	1
A Second Supplement to the Indices to the Keys to and Local Lists of Nearctic Coleoptera By MELVILLE H. HATCH	21
Concerning the Musculature of the Male Genitalia in <i>Panorpa nuptialis</i> Gerst By CYRIL E. ABBOTT	43
Mortality Among Hibernating Larvae of the Japanese Beetle with Special Reference to Conditions in the Winter of 1935-36 By I. M. HAWLEY AND T. N. DOBBINS	47
On a Collection of Millipeds from Texas and New Mexico By RALPH V. CHAMBERLIN AND STANLEY MULAİK	57
Further Studies of Conditions Influencing the Survival of Japanese Beetles through Metamorphosis By DANIEL LUDWIG AND HENRY FOX	65
Book Notice	76
Experiments on Culture Media in Regard to Oviposition and Mass Production of <i>Drosophila melanogaster</i> By GEORGE H. MICKEY, JOHN CARPENTER, R. W. CUMLEY AND WALTER BURDETTE	77
New Cicadas from North America with Notes By WILLIAM T. DAVIS	85
Charles W. Leng	100
The Position of <i>Utetheisa galapagensis</i> (Lepidoptera, Arctiidae) By WM. T. M. FORBES	101
Proceedings of the New York Entomological Society	111
Three Papers on Fleas	118
Book Notices	119
NOTICE: VOLUME XLVIII, NUMBER 4, OF THE JOURNAL OF THE NEW YORK ENTOMOLOGICAL SOCIETY WAS PUBLISHED ON DECEMBER 17, 1940.	

Entered as second class matter July 7, 1925, at the post office at Lancaster, Pa., under the Act of August 24, 1912.
Acceptance for mailing at special rate of postage provided for in Section 1103. Act of October 3, 1917, authorized March 27, 1924.

JOURNAL

OF THE

New York Entomological Society

VOL. XLIX

MARCH, 1941

No. 1

NOTES ON THE REACTIONS OF CERTAIN INSECTS TO DIFFERENT WAVE-LENGTHS OF LIGHT

BY HARRY B. WEISS, FRANK A. SORACI, AND E. E. MCCOY, JR.

INTRODUCTION

In presenting these notes, on the responses of certain species of insects to light of different wave-lengths, it is our idea that they should be interpreted as indicating the general behavior of a majority of the organisms at a particular time. It is not our thought that the degree of exactness represented by the numbers responding to certain wave-lengths should be read into the results. Experimental work by various investigators supports the idea that color perception exists in insects and that they are especially responsive to the so-called shorter wave-lengths of the spectrum. There is also evidence indicating that light intensity is a factor that should by no means be neglected, as varying responses may be obtained by different intensities. We are aware of the possibility of error in attempting to ascribe insect behavior solely in terms of light responses when it is obvious that other important and seemingly immeasurable factors are operating simultaneously.

It will not do to think of the behavior of the insects under consideration as simple reflexes. Although their behavior on the whole is automatic and conforms to Loeb's physical interpretation of phototropism, their responses to certain wave-lengths do not appear to be such inflexible or precise acts as the theory of

tropisms would imply. Such responses probably depend upon and are modified by a coordinated series of reflexes controlled or initiated by the nervous system. We do not view responses to light as completely tropic or as representing a complex of responses to such additional outer physical stimuli, as, for example, moisture and temperature. In addition there are metabolic conditions, reproductive and oviposition factors, etc., any one of which might take precedence over, or modify the response to light.

It is difficult to draw conclusions about the color responses of insects from experimental work in which lights of varying intensities are used, side by side, and when such intensities are measured by incorrect methods. Light intensity is difficult to measure, and unless some attempt is made to equalize the intensities, when the insects are exposed to different wave-lengths of light, it is impossible to determine whether the wave-length or the intensity is responsible for the behavior. At the outset it was thought that intensities might be measured by photographic means or by photoelectric cells, but we soon discovered that such devices were not equally sensitive to all wave-lengths, however suited they might be to the type of work for which they were designed.

The purpose of these investigations was to determine the response of the insects to color alone, uncomplicated by varying intensities, and therefore it was decided to equalize the intensities of the various colors to which the insects were exposed. We felt that it was necessary to attempt such equalizations before the comparative effects of different wave-lengths could be evaluated.

COLOR AND INTENSITY OF LIGHT USED IN THE EXPERIMENTS

The color, or wave-length, of the light entering the test apparatus was determined by passage of the light given by the source lamps through the appropriate Corning monochromatic filter glass combinations. The physical intensity (as distinct from the human visual intensity) was regulated by the distance between the lamp source and the filter combinations.

The monochromatic filter glass combinations used limited the light transmitted to relatively narrow bands of the spectrum. The data on the transmission characteristics of the respective filter combinations appear in Table 1, and are also represented

graphically in Graph 1. Each filter combination is seen to transmit light over a certain wave-length band, with the maximum transmission of each combination occurring about midway of the transmission range. Thus, light characterized by a definite color is obtained.

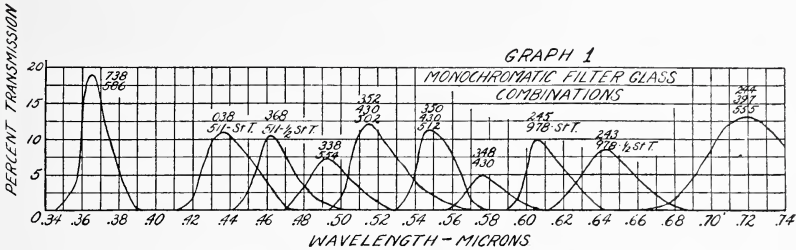

GRAPH 1. Transmission characteristics of monochromatic filter glass combinations. Redrawn from blue print furnished by the Corning Glass Works.

The light emitted by an incandescent lamp has a definite radiant intensity at any given point in the spectrum, but the intensity is not uniform for all regions of the spectrum. The spectral intensity for a 40-watt, 115 volt incandescent lamp is given in graphical form in Graph 2.¹ It is important to note that these data are in the form of definite physical units, and have no connection with human visual units. Since the filters transmit only light of a specific wave-length range, the quantity of such light, or radiant energy, emitted by the source lamp in this wave-length range must be known, and this may be obtained from Graph 2. The quantity of radiant energy of a given wave-length range which falls upon the filter surface is likewise dependent upon the distance from the lamp to the filter surface. Unfortunately, at small distances from such sources as incandescent lamps, the inverse square distance law for light intensity cannot be applied. The empirical relationship existent between the distance from the source for the 40-watt lamp used was obtained by taking readings with these lamps on an optical bench, and using a Weston photoelectric cell in making the measurements. The distance measurements were taken between the axial tip of the bulb, which was the proximal surface, and the Weston cell filter.

¹ Based on data of B. T. Barnes, Lamp Development Laboratory, General Electric Company, Cleveland, Ohio.

GRAPH 2
SPECTRAL RADIANT INTENSITY
40-WATT, 115 VOLT LAMP.

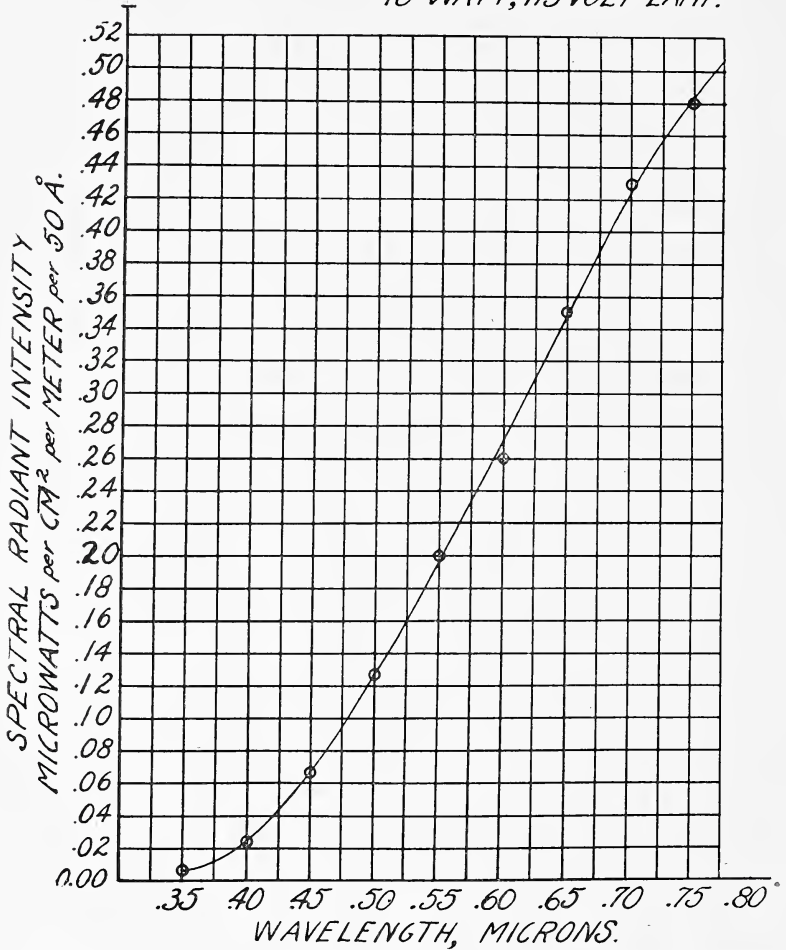

GRAPH 2. Spectral radiant intensity for a 40 watt, 115 volt incandescent lamp.

This same procedure was later followed in arranging the lamps and measuring to the filter surface. The data obtained in these measurements are presented in graphical form in Graph 3.

The quantity of light emitted at any wave-length by the 40-watt Mazda lamp is now determinable from Graph 2. The manner in

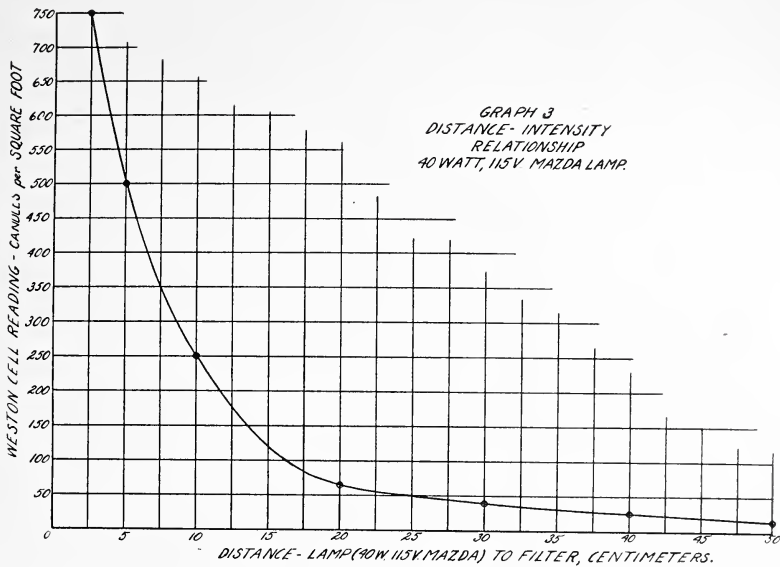

GRAPH 3. Distance-intensity relationship, 40 watt, 115 volt lamp.

which this quantity will change with various distances is determinable from Graph 3. The quantity of incident light which will be transmitted by the various filter combinations is determinable from Graph 1.

It is now possible to calculate the setting of the lamps with respect to the filters so that the light transmitted by the various combinations should be of an equal physical intensity, although it will be impossible to assign any physical unit of measurement to the quantity of transmitted light. Since the problem of this investigation is solely to determine the relationship of phototropic response to various portions of the spectrum, it is only necessary to equalize the intensities, or know definitely their numerical relationships one to another, and actual measurement in terms of physical units is not required.

In calculating the setting of the lamps, it is evident that light is transmitted over the entire wave-length band covered by the filter, although the greater portion will be transmitted close to the wave-length for which the filter combination has its maximum transmission. Since some of the filter combinations transmit over

a relatively broad band, even though the maximum transmission be relatively low, and others are much more selective, with a relatively high transmission, it seemed desirable to consider all of the light which would be transmitted by the filters rather than base the calculations on maximum transmission alone. For each filter combination a table was prepared giving the transmission of the filter at the mid-point for each interval of 50 ångstrom units over the entire transmission band of the combination, using the data from Graph 1 to obtain these values. Likewise, for each mid-point of the 50 ångstrom unit band, the spectral radiant intensity of the lamp was tabulated using the data in Graph 2. The product of the filter transmission and source intensity for each 50 ångstrom unit band was then obtained. These products were then summed for the filter combination. These calculations were made for each of the filter combinations. The sum of the products of transmission times source units yields, in effect, an integrated value for the total light energy passed by each filter when illuminated by each source lamp at a standard distance. Thus, filters with a high transmission over a narrow band are put on a comparative basis with filters having a low transmission over a wider band, and at the same time the relative energy distribution of the lamps at various wave-lengths is taken into consideration. The procedure also acknowledges the fact that the light transmitted is not strictly "monochromatic," and makes due allowance for that fact.

For the purpose of determining the relative positions of the lamps and various filter combination, that combination for which the sum of the products of emissivity times transmission was a minimum (038-511 Std. T.) was taken as a point of departure, and the distance from the nearest portion, or axial tip, of the bulb surface to the filter surface was arbitrarily assumed at 2.50 centimeters. The distance from bulb surface to filter surface was then determined for the other combinations, to yield an equal physical intensity, by the following equation and procedure:

$$X = \frac{(E' F') 750}{(E'' F'')}$$

Where X = a reading in candles per square foot on Graph 3.

(E' F') = summed products of spectral intensities times filter

transmission for the filter combination 038-511 Std. T., this combination being set arbitrarily 2.50 cm. from the source, as above explained.

750 = the Weston Cell reading (Graph 3) for the 40-watt lamp at a distance of 2.50 cm.

(E'' F'') = summed products of spectral intensities times filter transmission for the filter combination being calculated.

The value X, then, is in candles per square foot and is referred back to Graph 3, from which the corresponding distance from lamp to filter surface is read off and tabulated. This procedure is followed for each of the filter combinations. Table 2 presents the final results of these calculations in the 3rd column. It should be emphasized that the lamps are used in a reclined position, with the axis centered and normal to the filter surface, and that the distance measurement is from the proximal, or tip, bulb surface to the filter combination surface. This procedure is valid because the distance-intensity data of Graph 3 were derived by an identical procedure.

Using the calculated X value, a table of fractional intensities for each filter combination may be calculated by multiplying X successively by the fractional quantities desired, and obtaining the corresponding distance measurements from Graph 3. These settings for fractional intensities have been tabulated in the successive columns of Table 2. A graph of these fractional intensity-distance relationships may be drawn, resulting in a family of more or less parallel curves, if it is considered convenient to do so.

It is necessary to repeat all measurements, calculations, and graphs for any change in the lamps used as sources of illuminations, since no simple numerical relationship exists between such lamps. When mercury vapor lamps are used, still other considerations are necessary in order to equalize the intensity of illumination with that given by incandescent lamps.

Mercury vapor lamps are characterized by a discontinuous spectral emissivity, with very little energy emitted between the principal lines of emission. The mercury lamp, in its housing, must first be standardized against the incandescent lamp. This may be done by using the mercury line at 5461 ångstrom units, which is within the transmission range of the filter combination 350-430-512 and within the range of emission of the incandescent

lamp as well as the sensitivity of the Weston cell. The filter combination mentioned above must be used in order to limit the Weston cell readings with the incandescent lamp to the same range as is emitted in this portion of the spectrum by the mercury lamp. With this filter combination in place before the Weston cell, readings were taken with both the incandescent and mercury vapor lamp. Identical readings of 3.75 candles per square foot were obtained with the 40-watt lamp at 4.0 cm., and the mercury lamp at 37.8 cm. The manufacturer's data on the emission of the mercury lamp shows the ratio of emission at 5461 ångstrom

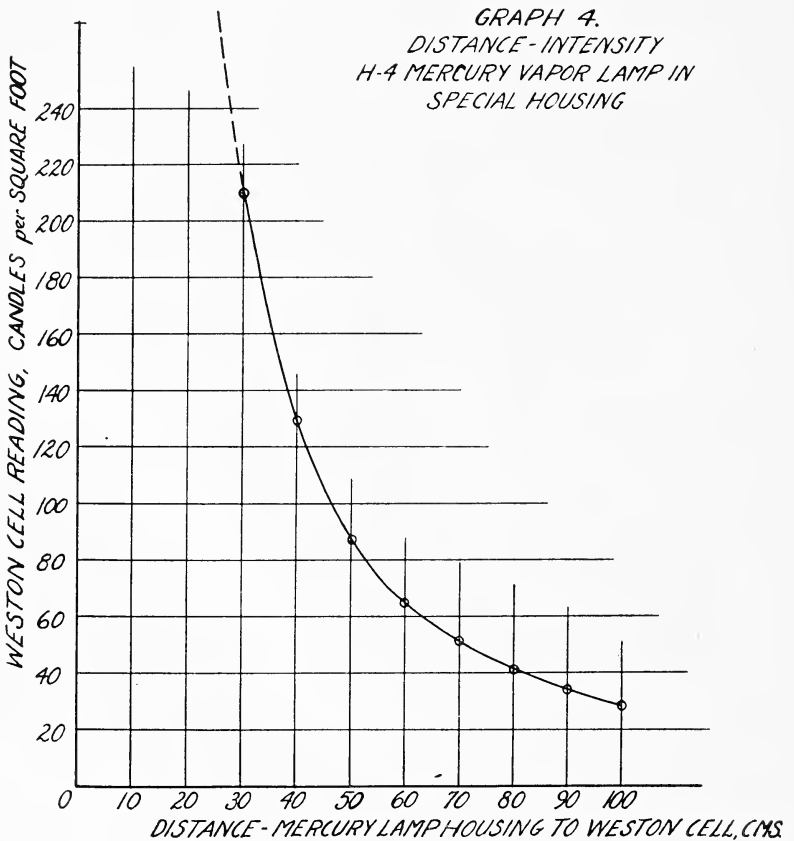

GRAPH 4. Distance-intensity relationship, H-4 Mercury vapor lamp in special housing.

TABLE 1
LIGHT TRANSMISSION CHARACTERISTICS OF CORNING MONOCHROMATIC FILTER COMBINATIONS

Filter glass combinations, Corning designation numbers	Color of light transmitted	Transmission range, Å	Wave-length of maximum transmission, Å	Maximum transmission, per cent of incident light
244-397-555	Infra-red	6620-7400*	7200	13.0
243-978 ($\frac{1}{2}$ Std. T.)	Orange-red	6120-6860	6420	8.5
245-978 (Std. T.)	Yellow-orange	5900-6420	6060	9.8
348-430	Yellow-yellow-green	5550-6070	5750	4.9
350-430-512	Yellow-green	5300-5760	5460	11.2
352-430-502	Blue-green	4940-5660	5150	12.2
338-554	Blue-blue-green	4700-5280	4920	7.2
368-511 ($\frac{1}{2}$ Std. T.)	Blue	4420-5000	4640	10.5
038-511	Violet-blue	4120-4760	4360	11.0
738-586	Ultra-violet	3460-3900	3650	18.5

* The filter combination, 244-397-555, transmits light into the infra-red spectrum beyond 7400 Å. The data on transmission (Graph 1) beyond 7400 Å were not available.

units to that at 3650-63 ångstrom units as 1.37, which, multiplied by 3.75 candles per sq. ft. equals 5.14 candles per sq. ft., and was found to be equivalent to a distance of 31.5 cm. for the mercury lamp, equivalent to 194 candles per square foot for the mercury lamp without filter. See Graph 4 for distance-intensity relationships of the mercury lamp without filter. The ratio of filter transmissions for the filter combinations 350-430-512 and 738-586 is as 1/1.65, which, multiplied by 194 equals 118 candles per square foot, or equivalent to 42.5 cm. distance from mercury lamp to 738-586 filter, to give equal intensity with the 40-watt lamp and 350-430-512 filter combination at 4.0 cm. However, the latter combination will be used at 9.25 cm., which gives only 0.475 times the light at 4.0 cm. Therefore, the mercury lamp must be placed to give a similarly reduced light, or 0.475×118 candles per square foot = 56 candles per square foot, which, from the mercury lamp distance graph is found to be equivalent to 66 cm. This, then, is the unit distance for the mercury lamp when used with filters 738-586, which gives an illumination at 3650-63 ångstrom units in the ultra-violet. The other intensity settings for the ultra-violet are found in a manner identical with that employed for the incandescent lamps.

APPARATUS

The testing equipment consisted of a low, cylindrical box made of galvanized iron (24 gage), the inside measurements being diameter 22 inches, height $4\frac{1}{2}$ inches (Fig. 1). The inside was divided into eight wedge-shaped compartments and a central octagonal compartment 11 inches in diameter. Each of the eight compartments was separated from the adjoining ones by solid walls, and from the central compartment by a gate hinged at the top. The gates were raised in such order that the first rested upon the second, the second upon the third, etc., and the eighth was held up by a rod. At the end of a test, the rod was pulled out and all the gates fell, closing each compartment. Each of the eight compartments was covered with a wire screen, and each contained a single side-window $1\frac{3}{4} \times 1\frac{3}{4}$ inches opening to the outside and cushioned with rubber. Glass filters were placed against the rubber cushion and fastened by a metal frame held

in place by thumbscrews (Fig. 2). A lid lined with felt strips to prevent light leakage, with a circular opening in the centre (for the introduction of the insects) was held in place by four

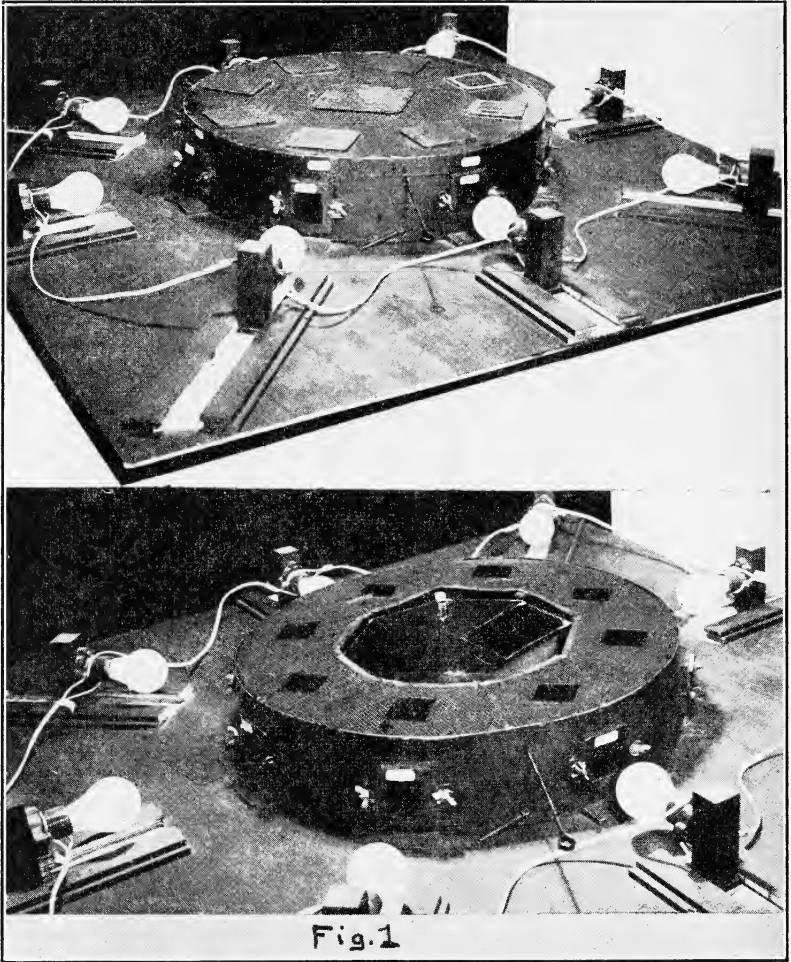

FIG. 1. Upper: Photograph of apparatus with lid on. Lower: With lid off and showing one hinged gate raised.

springs. During the tests, the circular opening in the lid was tightly covered. The entire box was painted dull black inside and out.

The testing box was placed in the centre of a flat board which carried eight grooved wooden tracks on which the mountings holding the lamps could be moved, thus bringing the lamps to the required distances from the windows holding the filters (Fig. 1).

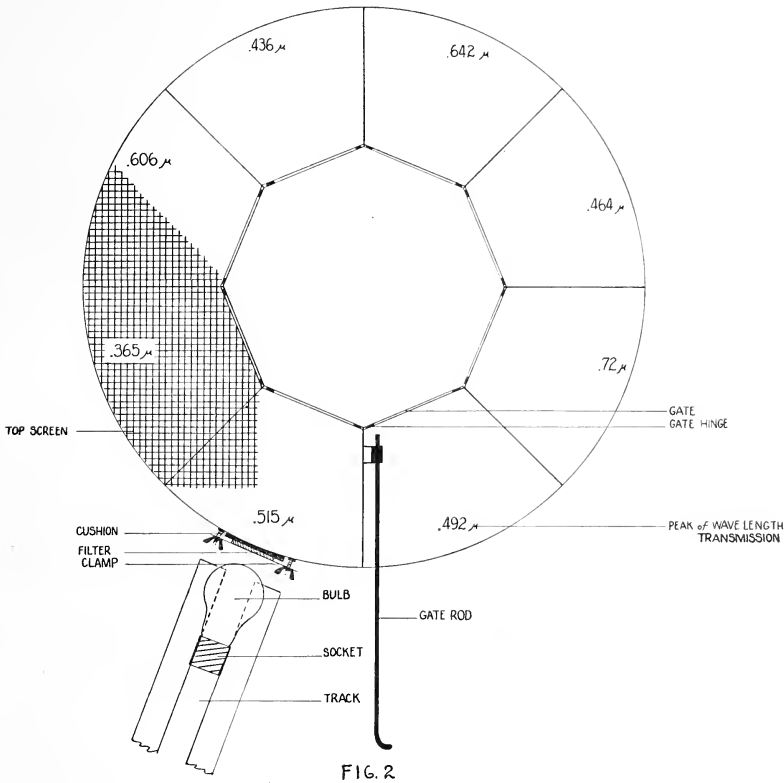

FIG. 2

FIG. 2. Diagrammatic top view of apparatus with lid off showing details and also the peak of wave-length transmission for each chamber.

Forty-watt, frosted Westinghouse Mazda lamps were used and the ultra-violet light was supplied by a General Electric Mazda mercury lamp, type A-H4 (100 watts), in which the arc discharge takes place within a small, capsule-like tube of quartz.

Corning filter glasses were used in order to isolate specific portions of the spectrum. Each was 2" x 2", and every filter or

combination of filters, when in place, was equally distant from the central compartment into which the insects were introduced.

The distance settings, from the 40-watt lamps to the filter combinations, were, in all experiments, the same as those shown in column 3, Table 2.

METHODS

Eighteen species of insects were tested for their color reactions. Nearly all were Coleoptera. These particular species were used only because they could be collected in the field in numbers large enough to permit testing. After being collected in the field the insects were brought into the laboratory where the daylight was weak and placed in cages containing food until it was convenient to test them. Most of them were tested within three or four hours after having been collected. Each species was tested three or more times. The specimens were introduced into the central compartment after all lights were turned on. As a rule, they were exposed to the various wave-lengths for fifteen minutes, after which the gates were closed, trapping them in the outer compartments, where they could be counted, along with those remaining in the centre, after the lid was removed. The results of the three tests were added together, for each filter combination, and then converted into percentages of the total number that reacted. The sexes were not separated and the specimens were disturbed as little as possible. Usually the three tests were successive as it was found that rest periods between the tests were not necessary. Nothing was known about the ages, etc., of the specimens, but care was taken to use what appeared to be healthy, active adults.

Theoretically at least, when all compartments are dark, the insects, after being introduced through the central opening, should distribute themselves more or less equally in the compartments. This was tried with the squash bug *Anasa tristis* and with one or two other species and it was found that a fair degree of distribution, approaching equal numbers, was obtained by averaging three or four tests. The dates on which each species was tested and the relative humidity and temperatures during the tests are given in the following Table 3.

TABLE 3

Name	Date tested	Relative humidity during test	Temperatures °C.	
			At start of test	At end of test
<i>Chauliognathus pennsylvanicus</i> DeG.	Sept. 12	46	24	26
<i>Epicauta pennsylvanica</i> DeG.	Sept. 6	48	26	27
<i>Epilachna corrupta</i> Muls.	Aug. 8	52	29	30
<i>Cyllene robiniae</i> Forst.	Sept. 12	46	24	25
<i>Tetraopes canteriator</i> Drap. }	July 17	70	27	28
<i>Tetraopes tetraophthalmus</i> Foer. }				
<i>Leptinotarsa decemlineata</i> Say.	July 1	50	25	26
<i>Chalepus dorsalis</i> (Thun.)	Aug. 12	58	29	30
<i>Galerucella notata</i> Fab.	Sept. 13	52	23	24
<i>Chrysochus auratus</i> (Fab.)	July 30	55	33	36
<i>Rhyssomatus lineaticollis</i> Say.	Aug. 15	60	28	29
<i>Myllocerus castaneus</i> (Roelofs)	Aug. 7	67	28	28
<i>Hylurgopinus rufipes</i> (Eich.)	July 25	68	28	31
<i>Scolytus multistriatus</i> Marsham	July 25	98	26	28
<i>Anasa tristis</i> DeG.	Sept. 10	68	25	26
<i>Corythucha ciliata</i> Say.	Aug. 5	55	29	31
<i>Popillia japonica</i> Newm.	July 15	68	26	28
<i>Autoserica castanea</i> Arrow	Sept. 3	62	26	26

RESULTS

A summary of the results obtained in testing the various species is given in Table 4 and graphically in Graph 5. It appears at once, from consideration of either Table 4 or Graph 5 that there was considerable variation in the reaction of the different species, although by no means do these variations appear discordant. It should be kept in mind that the wave-length figures given in microns in both table and graph represent the maximums of the filter transmissions. Actually, the insects reacted to a wave-length band, and the relation between wave-length and stimulation was not the same for all species, at the times they were tested. We assumed that a positive reaction occurred whenever an insect went into one of the compartments containing a light filter.

Of all specimens tested, a little over 72 per cent reacted positively to one wave-length band or another, while a little under 28 per cent remained in the central compartment. These percentages varied with individual species. Of those that reacted

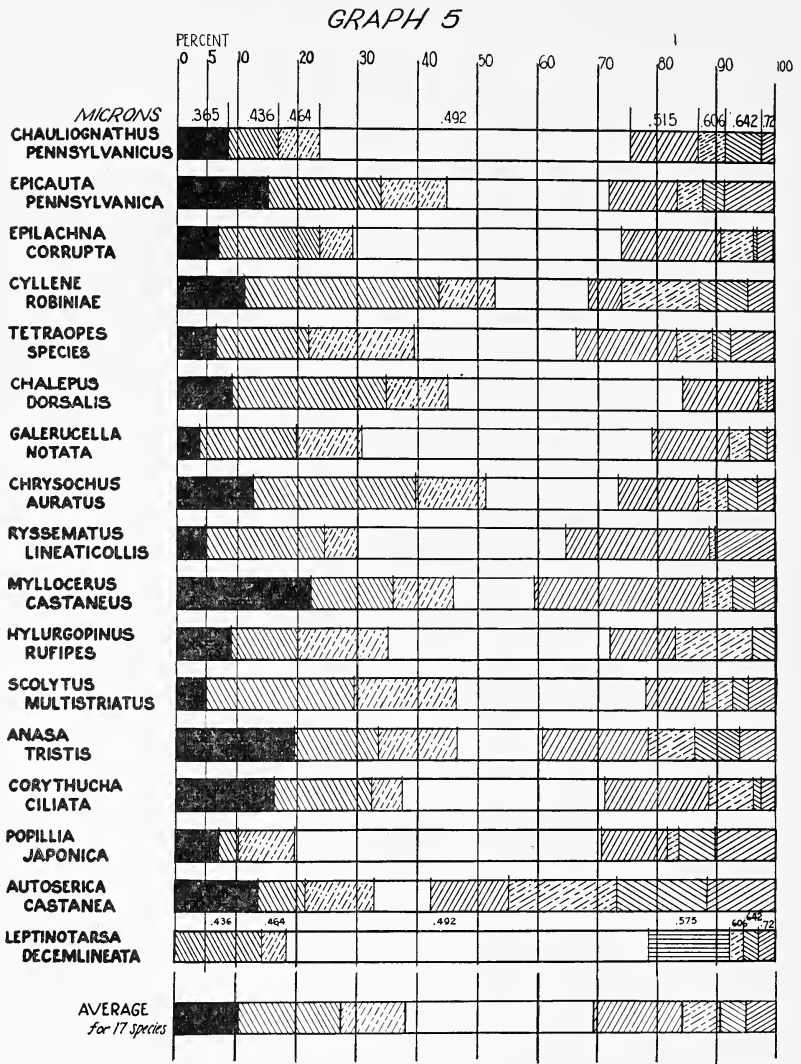

GRAPH 5. Graphic presentation of the behavior of certain species of insects to various wave-lengths when the physical intensities are constant. Peak of wave-length transmission indicated by the figures at top of graph, and also by the types of shading below the figures. For example, 51.9 per cent of the individuals of *C. pennsylvanicus*, reacted positively to a combination of filters that transmitted a band from .470 to .528 microns but which had its transmission peak at .492 microns. For *Leptinotarsa decemlineata*, the peaks of wave-length transmission are shown above the bar for this species. The mercury vapor lamp was not available when this species was tested. The vertical guide lines in the graph enable one to roughly calculate the percentages reacting positively to the bands.

positively approximately 33 per cent went to the wave-length band 4700–5280² (blue-blue-green), 14 per cent to 4940–5660 (yellow-green), 14 per cent to 4120–4760 (violet-blue), 11 per cent to 4420–5000 (blue), and 11 per cent to a wave-length of 3650–3663 (ultra-violet). On the whole much smaller percentages went to the longer wave-lengths 5900–7400 (yellow-orange, orange-red, infra-red). It therefore may be concluded that under the conditions described and at the time the particular species were tested, the stimulating efficiency of wave-lengths from 3650 to 5280 was much greater than that of wave-lengths from 5900 to 7400+. If wave-lengths from 4120 to 5280 (violet-blue, blue, blue-blue-green) are considered as one unit, it may be noted that approximately 60 per cent of the total number reacted positively to that band, which apparently is a region of maximum stimulation. It should be kept in mind that this is simply a generalization, for convenience, of the behavior of the species tested. The data for the potato beetle are not included in these generalizations.

The behavior of the particular species took place when the filter combinations were arranged in the order shown in Fig. 2. Changing the order in which the filters were arranged with respect to one another did not appear to influence the results.

At this time we have done little more than report the behavior of the eighteen species as it took place under the conditions outlined. Some of the insects went to every choice that was open to them, from infra-red to ultra-violet, however, certain wave-lengths were more stimulating to them than others. All were Coleopterous species, with the exception of two Hemipterous ones and much work remains to be done with representatives of additional orders.

It has been asserted by Mast that the reaction of animals with image forming eyes to light is a very much complicated one; that there is little evidence that any one color is much more attractive than another, and that they may be positive to one, at one time, and negative at another time. There is no doubt about

² Wave-length bands are given in Angstrom units. One $\text{\AA} = \frac{1}{10,000}$ micron.

the behavior of insects to light being complicated. The types of compound eyes and ocelli perhaps need to be considered. If insect behavior, including the reaction to light, depends upon the physiological state of the specimen and if all movements are secondary to this state and the factors producing it, the problem of explaining is indeed complicated. As the movements of our experimental specimens took place in a closed box, we do not know if their orientation was immediately direct or direct after a series of preliminary movements. Neither do we have any idea of the importance of photochemical reactions which may have taken place in retinal cells or in photosensitive areas. Neither do we know if the behavior can be explained entirely on the basis of chemistry and physics. There may be a psychic factor which regulates behavior with respect to time and direction.

Mast in his work with unicellular and colonial forms, concluded that his animals were devoid of true color vision. He found that in the species studied, stimulation depended upon the wave-length, but that the wave-length was not independent of luminous intensity. His work demonstrated that although there was a clear wave-length region of maximum stimulating efficiency, it was possible to increase the stimulating effects of wave-lengths on either side of the maximum, by increasing their intensities.

Peterson and Haeussler in their work with the Oriental peach moth, and the codling moth found that intensity is a factor that should be considered as influencing the reactions of insects to different wave-lengths. In our work as outlined in this paper, we attempted to equalize the physical intensities within each chamber, in order that the wave-length could be evaluated by itself. We have no reason for believing that the behavior could not be changed by varying the intensities.

Of our eighteen species of insects all except one are active in daylight. The exception is *Autoserica castanea* which feeds at night. For this species the least stimulating wave-length band was the one most stimulating for the daylight species. On the other hand this species is photonegative to daylight and its behavior as recorded may have been a dispersal in search of dark-

ness which it could not find in the apparatus. It is doubtful if the experimental set-up was suitable for testing photonegative insects. In considering the reactions of the other species there is a faint idea that with the testing of many more additional species, it might be possible to correlate their behavior to various wave-lengths with some of their general habits in the field, at particular times.

ACKNOWLEDGMENTS

We are greatly indebted to Mr. Robert J. Sim for collecting in the field, many of the species mentioned herein, and also to Mr. Lewis P. Hoagland, and Mr. C. W. Collins for supplying certain species in numbers sufficient for testing. And we are especially grateful to Mr. S. G. Hibben, Director of Applied Lighting, Lamp Division, Westinghouse Electric & Manufacturing Company, for his advice and helpful criticisms.

REFERENCES³

- HALLOCK, HAROLD C. 1936. Recent developments in the use of electric light traps to catch the Asiatic garden beetle. *Jour. N. Y. Ent. Soc.*, vol. 44, p. 261-279.
- HERMS, W. B., AND JOE K. ELLSWORTH. 1935. The use of colored light in electrocuting traps for the control of the grape leafhopper. *Agrie. Engineering*, vol. 16, No. 5, May.
- LOEB, J. 1918. *Forced movements tropisms and animal conduct.* J. B. Lippincott Co., Philadelphia.
- LUTZ, F. E. 1924. Apparently non-selective characters and combinations of characters including a study of ultra-violet in relation to flower-visiting habits of insects. *Ann. New York Acad. Sci.*, vol. 29, p. 181-283.
- MAST, S. O. 1911. *Light and the behavior of organisms.* John Wiley & Sons, 410 p.
- MAST, S. O. 1917. The relation between spectral color and stimulation in the lower organisms. *Jour. Exp. Zool.*, vol. 22, p. 471-528.
- PETERSON, ALVAH, AND G. J. HAEUSSLER. 1928. Response of the Oriental peach moth and codling moth to colored lights. *Annals Ent. Soc. Amer.*, vol. 21, No. 3, p. 353-375.
- RICHMOND, E. A. 1927. A new phototropic apparatus. *Jour. Econ. Ent.*, vol. 20, p. 376-382.
- WIGGLESWORTH, V. B. 1934. *The principles of insect physiology.* E. P. Dutton & Co., New York. 434 p.

³ In view of the availability of numerous references to the subject, this list includes only such papers as were of immediate interest to us.

A SECOND SUPPLEMENT TO THE INDICES TO THE KEYS TO AND LOCAL LISTS OF NEARCTIC COLEOPTERA

BY MELVILLE H. HATCH

In its arrangement the present second supplement follows the plan of the two indices and the first supplement by the author, to which reference should be made for explanations.¹ The author is indebted to Mr. Henry Dietrich and Prof. W. P. Hayes for corrections and additions to the present Index, and he will appreciate having further errors and omissions called to his attention.

I. INDEX TO KEYS

COLEOPTERA Bradley, Man. Gen. Beetles Amer. n. of Mex. 1930, 360 p. (genera); Brues and Melander, Class. Ins. 1932, p. 408 (fam.); Hatch, Ann. Ent. Soc. Amer. XXI, 1928, p. 575 (series); Wardle, Gen. Ent. 1936, p. 260 (superfam.); Chagnon, Col. Prov. Queb. 1935-38, p. 1-320² (common genera and sp. of Quebec: Carabidæ-Chrysomelidæ); Wellhouse, How Ins. Live 1926, p. 412 (19 fam.); Metcalf and Metcalf, Key to Princ. Orders and Fam. Ins. 1928, p. 13 (32 fam.); Comstock and Herrick, Man. Study Ins. 1930, p. 130 (40 fam.); Hatch, Ent. Notes (mimeographed) 1937, p. 42 (33 fam.), p. 44 (60 larger sp. of Wash.); Jaques, How to Know the Ins. 1938, p. 55 (54 fam.); Matheson, Lab. Guide in Ent. 1939, p. 67-69 (49 fam.); Peterson, Ann. Ent. Soc. Am. XXXII, 1939, p. 267-278 (orders of immature insects); Townsend, Pr. Ent. Soc. Wash. XXXVII, 1935, p. 26 (larvæ of Coleoptera and Neuroptera); Rymer Roberts, Bull. Ent. Res. XXI, 1930, p. 59 (fam. of larvæ); Böving and Craighead, Ent. Amer. XI, 1931, 80 p. (266 major

¹ A Systematic Index to the Keys for the Determination of the Nearctic Coleoptera, JOUR. N. Y. ENT. SOC. XXXV, 1927, p. 279-306.

A Geographical Index to the Catalogues and Local Lists of Nearctic Coleoptera, JOUR. N. Y. ENT. SOC. XXXVI, 1928, p. 335-354.

A Supplement to the Indices to the Keys to and Local Lists of Nearctic Coleoptera, JOUR. N. Y. ENT. SOC. XXXVII, 1929, p. 135-143.

² A reprinting of material originally published in *Le Naturaliste Canadien*.

- groups of larvæ); van Emden, Ann. Soc. Ent. Belg. LXXII, 1932, p. 204 (23 groups of larvæ of Ostomidæ-Malacodermata-Sternoxia group); Wellhouse, How Ins. Live 1926, p. 427 (18 fam. larvæ).
- CICINDELIDÆ** Hatch, Univ. Wash. Publ. Biol. I, 1938, p. 225-240 (Wash.); Eckhoff, Iowa St. Coll. Jr. Sci. XIII, 1939, p. 202-208 (Iowa). **Cicindela** Dawson, Univ. Minn. Agric. Exp. Sta. Tech. Bull. 56, 1928, p. 7 (Minn.); Nicolay and Weiss, Jour. N. Y. Ent. Soc. XL, 1932, p. 344 (*purpurea*-group); Varas Arangua, Rev. Chilena Hist. Nat. XXXIII, 1929, p. 395 (*oregona*-group); Cazier, Bull. S. Cal. Acad. Sci. XXXV, 1936, p. 157 (*fulgida*-group).
- CARABIDÆ** Sloane, Trans. Ent. Soc. London 1923, p. 242 (tribes).
- Carabinae: Cychrini-Carabini** Lapouge, G. I., 192, 1929, p. 325-362 (subg.); p. 44-59 (subg. of larvæ). **Scaphinotus** Van Dyke, Ent. Amer. XVIII, 1938, p. 95 (*Scaphinotus* s.str.); Darlington, Psyche XXXVIII, 1931, p. 147 (*viduus*-group of *Irichroa*); Valentine, Jr. E. Mitchell Soc. LI, 1935, p. 348 (*Steniridia*); Van Dyke, Bull. Brook. Ent. Soc. XXXI, 1936, p. 39 (*Nomaretus*).
- Nebriini: Pelophila** Bänninger, Not. Ent. X, 1930, p. 97. **Nebria** Hatch, Pan-P. Ent. XV, 1939, p. 117 (n.w. N. A.).
- Scaritini: Scarites** Bänninger, Deutsch. Ent. Zeit. 1938, p. 137-138, 148-152. **Dyschirius** Fall, Occ. Pap. Cal. Acad. Sci. VIII, 1901, p. 209 (*hæmorrhoidalis*-group).
- Harpalinae bisetosæ: Nomiini-Psydrini** Hatch, Pan-P. Ent. XI, 1935, p. 118.
- Pogonini** Darlington, Ent. Am. XVIII, 1938, p. 143 (3 subtribes). **Patrobus-Platidius** (Patrobini) Darlington, l.c., p. 145-173. **Trechus-Anophthalmus** (Trechini) Jeannel, Arch. Zool. Exp. Gen. LXXI, 1931, p. 411-499. **Pseudanophthalmus** Valentine, Jour. E. Mitchell Sci. Soc. XLVII, 1932, p. 261-279 (no keys).
- Pterostichini: Platysma** (*Pterostichus*) Nicolay and Weiss, Jour. N. Y. Ent. Soc. XLII, 1934, p. 197 (*Cylindrocharis*); Hatch, Ann. Ent. Soc. Amer. XXIX, 1936, p. 701 (*castaneus*-group of *Hypherpes*), p. 703 (*Leptoferonia*); Darlington, Psyche

- XXXVIII, 1931, p. 156 (*Gastrellarius* part), p. 157 (*Monoferonia*); Nicolay and Weiss, Jour. N. Y. Ent. Soc. XLVII, 1934, p. 199 (*Euferonia*); Poppius, Zur. Kennt. Pteros.-Untergatt. *Cryobius* Chaud. 1906, p. 18 (*Cryobius*); Nicolay and Weiss, Jour. N. Y. Ent. Soc. XLII, 1934, p. 208 (*Melanius* = *Omascus*), p. 210 (*Dysidius*). **Anilloferonia** Hatch, Pan-P. Ent. XI, 1935, p. 116.
- Amarini: Amara** Minsk and Hatch, Bull. Brook. Ent. Soc. XXXIV, 1939, p. 4 (*Pseudotriena*).
- Agonini (Platynini): Agonum (Platynus)** Hatch, Pan-P. Ent. IX, 1933, p. 121 (4 subg. of *Agonum* and sp. of *Oxypselaphus* = *Anchus*).
- Anchonoderini: Lachnophorus** Liebke, Rev. Ent. VI, 1936, p. 461.
- Colliurini (Odacanthini)** Liebke, Mitt. Zool. Mus. Berlin XV, 1930, p. 656-678.
- Driptini: Zuphium** Liebke, Rev. Ent. III, 1933, p. 461. **Pseudaptinus** Liebke, l.c. IV, 1934, p. 372.
- Harpalinæ unisetosæ: Broscini: Miscodera** Hatch, Pan-P. Ent. IX, 1933, p. 8.
- Harpalini: Harpalus** Hatch, Bull. Brook. Ent. Soc. XXVII, 1932, p. 173 (*pennsylvanicus*-group). **Stenomorphus** Darlington, Pan-P. Ent. XII, 1936, p. 35.
- HALIPLIDÆ** Scholz, Ent. Nachr. III, 1928, p. 28 (genera); Hickman, Pap. Mich. Acad. Sci. Arts and L. XI, 1929 (1930), p. 422-423 (eggs, larvæ, and pupæ of 6 sp.). **Haliplus** Guignot, Bull. Soc. Ent. Fr. 1930, p. 74 (subg.); Wallis, Trans. Roy. Can. Inst. XIX, 1933, p. 1-76.
- DYTISCIDÆ: Cœlambus** Leech, Pan-P. Ent. XIV, 1938, p. 85 (*pedalis*-group). **Hydroporus** Hatch, Bull. Brook. Ent. Soc. XXVIII, 1933, p. 21 (subg.), p. 23 (*Oreodytes*). **Ilybius** Wallis, Can. Ent. LXXI, 1939, p. 192. **Graphoderus** Wallis, Can. Ent. LXV, 1933, p. 278 (*occidentalis*-group); LXXI, 1939, p. 130.
- GYRINIDÆ: Dineutus** Hatch, Publ. Univ. Okla. Biol. Surv. II, 1930, p. 17. **Gyretes** Ochs, Kol. Rund. XV, 1929, p. 63.
- HYDROPHILIDÆ: Chætarthria** d'Orchymont, Bull. Mus. Ry. Hist. Nat. Belg. XV, 7 p. (*pallida*-group) **Sphæridiinae**

- Blackwelder, Pan-P. Ent. VII, 1931, p. 19–32 (Pacific Coast).
Sphæridium Brown, Can. Ent. LXXII, 1940, p. 71.
- SILPHIDÆ: Silphinæ** Hatch and Rueter, Univ. Wash. Publ. Biol. I, 1934, p. 151–161 (Wash.). **Nicrophorini** Semenov-Tian-Shanskij, Trav. Inst. Zool. Acad. Sci. URSS, I, 1932, p. 151–154 (gen. and subg.). **Silpha** Dorsey, Ann. Ent. Soc. Am. XXXIII, 1940, p. 131 (5 sp. larvæ). **Catopinæ** Hatch, Jour. N. Y. Ent. Soc. XLI, 1933, p. 189–227, 235; Jeannel, Mem. Mus. Nat. Hist. Nat. I, 1936, 433 p. **Nemadus** Fall, Jour. N. Y. Ent. Soc. XLV, 1937, p. 336–337. **Colon** Hatch, l.e., XLI, 1933, p. 229 (*hubbardi*-group). **Leiodinæ** Brown, Can. Ent. LXIX, 1937, p. 160 (genera of *Neocyrtusa-Isoplastus*). **Hydnobius** Hatch, Jour. N. Y. Ent. Soc. XLIV, 1936, p. 34 (*substriatus*-group). **Neocyrtusa** Brown, Can. Ent. LXIX, 1937, p. 161. **Anisotoma** (*Leiodes* Leng) Brown, l.e., p. 195. **Agathidium** Fall, Ent. Amer. XIV, 1934, p. 100; Hatch, Jour. N. Y. Ent. Soc. XLIV, 1936, p. 38 (subg.).
- STAPHYLINIDÆ: Oxytelinæ: Trigonurus** Van Dyke, Bull. Brook. Ent. Soc. XXIX, 1934, p. 178. **Olophrum** Scheerpeltz, Verh. Zool.-bot. Ges. Wien LXXIX, 1929, p. 172. **Orobanus** Mank, Pan-P. Ent. X, 1934, p. 123. **Coprophilus** Leech, Can. Ent. LXXXI, 1939, p. 261. **Bledius** Notman, Bull. Amer. Mus. Nat. Hist. XLII, 1920, p. 695 (*armatus*-group), p. 696 (*semi-ferrugineus*-group).
- Euæsthetinæ: Euæsthetus** Bernhauer, Deutsch. Ent. Zeit. 1928, p. 38–40.
- Pæderinæ: Pæderini** Blackwelder, Proc. U. S. Nat. Mus. LXXXVII, 1939, p. 95 (genera).
- Staphylininæ: Staphylinini** Voris, Ann. Ent. Soc. Amer. XXXII, 1939, p. 288 (3 genera of larvæ). **Philonthus** Hatch and Ortenburger, Publ. Univ. Okla. Biol. Surv. II, 1930, p. 12 (*hepaticus*-group). **Staphylinus** Voris, Ann. Ent. Soc. Amer. XXXII, 1939, p. 288 (5 sp. of larvæ). **Quedius** Voris, Ent. News L, 1939, p. 151 (3 sp. of larvæ).
- Tachyporinæ: Tachyporini** Cooper, Can. Ent. LXIV, 1932, p. 236 (genera). **Tachyporus** Blackwelder, Proc. U. S. Nat. Mus. LXXXIV, 1936, p. 42. **Coproporus** (*Erchomus*) Blackwelder, l.e., LXXXVI, 1938, p. 2.

- Aleocharinæ:** *Myllæna* Notman, Bull. Amer. Mus. Nat. Hist. XLII, 1920, p. 707. *Bolitocharæ* Notman, l.c., p. 713 (genera). *Silusæ* Notman, l.c., p. 711 (genera). *Hoplandriini* Notman, l.c., p. 719 (genera). *Acrotona* Notman, l.c., p. 727. *Falagræ* Notman, l.c., p. 730 (genera).
- PSELAPHIDÆ** Bowman, Pselaphidæ of N. A. 1934, 149 p. *Rhexidius* Fletcher, Can. Ent. LXIV, 1932, p. 31.
- HISTERIDÆ:** *Hololeptinæ* Dillon, Ann. Ent. Soc. Amer. XXVIII, 1935, p. 462 (genera). *Hister* Wenzel, l.c., LXVIII, 1936, p. 268 (*Paralister*). *Dendrophilus* Hatch, Jour. Kans. Ent. Soc. XI, 1938, p. 19. *Terapus* Hinton, Ent. News XLV, 1934, p. 272. *Pseudister* Hinton, Can. Ent. LXVII, 1935, p. 11. *Saprinus* Ross, Pan-P. Ent. XV, 1939, p. 40 (*Eremosaprinus*). *Bæckmanniolus* Hinton, Can. Ent. LXVII, 1935, p. 81.
- CANTHARIDÆ:** *Cantharis* Fall, Pan-P. Ent. XII, 1936, p. 181 (*imbecillis*-group).
- MELYRIDÆ:** *Endeodes* Blackwelder, l.c., VIII, 1932, p. 132. *Dasytini* Blaisdell, Tr. Amer. Ent. Soc. LXIV, 1938, p. 6 (genera). *Eschatocrepis* Blaisdell, l.c., LVII, 1932, p. 331. *Vectura* Blaisdell, Pan-P. Ent. X, 1934, p. 73.
- CLERIDÆ:** *Priocera* Cazier, Pan-P. Ent. XV, 1939, p. 164. *Aulicus* Linsley, Univ. Cal. Publ. Ent. VI, 1936, p. 250.
- CEPHALOIDÆ:** *Cephaloön* Hopping, Pan-P. Ent. X, 1934, p. 67.
- CEDEMERIDÆ:** *Nacerda* Schatzmeyer, Col. Cent. I, 1926, p. 52.
- MORDELLIDÆ:** *Mordellistena* Ray, Can. Ent. LXVIII, 1936, p. 124-125 (Sect. I).
- RHIPIPHORIDÆ** Rivnay, Mem. Amer. Ent. Soc. 6, 1929, p. 14-63.
- MELOIDÆ:** *Pyrota* Horn, Tr. Amer. Ent. Soc. XII, 1885, p. 112-115 (no key). *Epicauta* Van Dyke, Bull. Brook. Ent. Soc. XXIV, 1929, p. 129 (*caviceps*-group). *Macrobasis* Horn, Tr. Amer. Ent. Soc. XII, 1885, p. 109. *Meloini* Denier, Rev. Chil. Hist. Nat. XXXVII, 1933, p. 237-246 (genera). *Nematognathinæ* Parker and Böving, Proc. U. S. Nat. Mus. LXIV (23), 1924, p. 32 (genera of larvæ).
- PYTHIDÆ:** *Cononotus* Van Dyke, Pan-P. Ent. XV, 1939, p. 19.

- Rhinosimus Blair, Ent. Mo. Mag. LXVIII, 1932, p. 254-255.
 Mycterus Hopping, Pan-P. Ent. XI, 1935, p. 76.
- PYROCHROIDÆ:** Ischalia Van Dyke, Ent. News XLIX, 1938, p. 193.
- PLASTOCERIDÆ:** Euthysanius Van Dyke, Proc. Cal. Acad. Sci. XX, 1932, p. 454 (males). **Plastocerus** Van Dyke, l.c., p. 458 (males); Sloop, Pan-P. Ent. 1935, p. 19 (*schaumi*-group). **Aplastus** Van Dyke, Proc. Cal. Acad. Sci. XX, 1932, p. 459 (males).
- RHIPICERIDÆ** (Sandalidæ) van Emden, Ent. Blätt. XXVII, 1931, p. 49-53 (genera). **Sandalus** van Emden, l.c., p. 112.
- ELATERIDÆ:** Alaus Hatch, Publ. Univ. Okla. Biol. Surv. II, 1930, p. 23. **Conoderes** Van Dyke, Proc. Cal. Acad. Sci. XX, 1932, p. 294. **Æolus** Brown, Can. Ent. LXV, 1933, p. 133 (var. of *mellillus*). **Limonius** Van Dyke, Proc. Cal. Acad. Sci. XX, 1932, p. 334. **Leptoschema** Van Dyke, l.c., p. 357. **Elathous** Van Dyke, l.c., p. 358. **Athous** Van Dyke, l.c., p. 361. **Ludius** Van Dyke, l.c., p. 390; Brown, Can. Ent. LXVIII, 1936, p. 213 (*cribrosus*-group), p. 218 (*volitans*-group), p. 178 (*propola*-group), p. 105 (*triundulatus*-group), p. 100 (*fallax*-group); LXVII, 1935, p. 126 (*aripennis*-group); LXVIII, 1936, p. 18 (*nitidulus*-group), p. 134 (*inflatus*-group); LXVII, 1935, p. 2 (*cruciatus*-group), p. 4 (*edwardsi*-group); LXVIII, 1936, p. 12 (*semivitattus*-group). **Eanus** Brown, l.c., LXII, 1930, p. 162; LXVIII, 1936, p. 249. **Hypnoidini** Van Dyke, Proc. Cal. Acad. Sci. XX, 1932, p. 326 (genera). **Dalopius** Brown, Can. Ent. LXVI, 1934, p. 35. **Agriotes** Brown, l.c., LXVIII, 1936, p. 250 (*isabellinus*-group). **Agriotella** Brown, l.c., LXV, 1933, p. 180. **Megapenthes** Van Dyke, Proc. Cal. Acad. Sci. XX, 1932, p. 311. **Anchastus** Van Dyke, l.c., p. 319.
- MELASIDÆ:** Hypocœlus Van Dyke, l.c., p. 292.
- BUPRESTIDÆ:** **Polycesta** Chamberlin, Jour. N. Y. Ent. Soc. XLI, 1933, p. 43. **Schizopini** Obenberger, Arb. Morph. Taxon. Ent. Berlin-Dahlem VI, 1939, p. 258. **Schizopus** Cazier, Pan-P. Ent. XV, 1939, p. 86. **Paratyndaris** Knull, Ann. Ent. Soc. Amer. XXX, 1937, p. 253. **Buprestis** Hopping, Pan-P. Ent. IX, 1933, p. 85 (*aurulenta*-group), p. 86 (*rusticorum*-

- group), p. 87 (*fasciata*-group). **Melanophila** Sloop, Univ. Cal. Publ. Ent. VII, 1937, p. 1-19. **Chrysobothris** Chamberlin, Pan-P. Ent. XIV, 1938, p. 11 (4 groups); X, 1934, p. 35 (group IV). **Taphrocerus** Obenberger, Sbornik Ent. Nar. Mus. Prazе XII, 1934, p. 7.
- DRYOPOIDEA** Hinton, Tr. Roy. Ent. Soc. London IXC, 1939, p. 147, 151, 161, 167, 169 (fam. and subfam. of adults, pupæ, and larvæ); West, Ann. Ent. Soc. Am. XXII, 1929, p. 717 (larvæ).
- DRYOPIDÆ** Sanderson, U. Kans. Sci. Bull. XXV, 1938, p. 660 (genera). **Lara** Darlington, Psyche XXXVI, 1929, p. 328. **Helichus** Musgrave, Proc. Ent. Soc. Wash. XXXVII, 1935, p. 139.
- HELMIDÆ** Sanderson, U. Kans. Sci. Bull. XXV, 1938, p. 660 (genera). **Stenelmis** Sanderson, l.c., p. 661, 663, 684. **Neoeelmis** Musgrave, Proc. Ent. Soc. Wash. XXXVII, 1935, p. 35; Hinton, Ent. Mo. Mag. LXXV, 1939, p. 234 (*cæsa*-group). **Macronychus** Hinton, Tr. Roy. Ent. Soc. LXXXV, 1936, p. 433; Hatch, Ent. News XLIX, 1938, p. 18³
- DASCILLIDÆ**: **Macropogon** Brown, Can. Ent. LXI, 1929, p. 273 (Canada); Hopping, Pan-P. Ent. XII, 1936, p. 45. **Anorus** Blaisdell, Trans. Amer. Ent. Soc. LX, 1934, p. 324.
- CHELONARIIDÆ** Mequignon, Ann. Soc. Ent. Fr. CIII, 1934, p. 199-256.
- NITIDULIDÆ**: **Epuræa** Dodge, Ent. News L, 1939, p. 287 (*flavomaculata*-group). **Lobiopa**, **Soronia**, **Phenolia**, **Amphotis** Parsons, Psyche XLV, 1938, p. 156-164. **Amphicrossus** Parsons, Bull. Brook. Ent. Soc. XXXIV, 1939, p. 59. **Pocadius** Parsons, Psyche XLIII, 1936, p. 114. **Cryptarcha** Parsons, l.c., XLV, 1938, p. 96-100. **Glischrochilus** Brown, Can. Ent. LXIV, 1932, p. 256; Siepmann, Bull. Brook. Ent. Soc. XXVI, 1931, p. 27 (*fasciatus*-group).
- CUCUJIDÆ**: **Laemophloeus** Park, Jour. N. Y. Ent. Soc. XXXVII, 1929, p. 433 (Ind.).
- EROTYLIDÆ** Rymer Roberts, Tr. Roy. Ent. Soc. London LXXXVIII, 1939, p. 92 (tribes of larvæ).

³ Hinton, Ent. Mo. Mag. LXXV, 1939, p. 181, points out that the *parvulus* Horn and *thermæ* Hatch of this key belong to *Zaitzevia* Champ. and are probably synonymous.

- CRYPTOPHAGIDÆ** Park, Jour. N. Y. Ent. Soc. XXXVII, 1929, p. 432 (genera of part).
- MYCETOPHAGIDÆ**: *Berginus* Pierce, Bull. S. Cal. Acad. Sci. XXXVIII, 1939, p. 53.
- COLYDIIDÆ** van Emden, Zool. Anz. CI, 1932, p. 8 (3 groups of larvæ).
- MYCETÆIDÆ**: *Liesthini* Blaisdell, Tr. Am. Ent. LVI, 1931, p. 376, 390.
- COCCINELLIDÆ** Stehr, Univ. Minn. Agric. Exp. Sta. Tech. Bull. 75, 1930, p. 1-54 (Minn.); Longnecker, Proc. Iowa Acad. Sci. XXXV, 1928, p. 307-111 (Iowa, except *Hyperaspis* and *Seymni*). *Coccinella* Dobzhansky, Proc. U. S. Nat. Mus. LXXX (4), 1931, p. 30. *Anatis* McKenzie, Univ. Cal. Publ. Ent. VI, 1936, p. 270 (male genitalia).
- ALLECULIDÆ**: *Hymenorus* Fall, Tr. Am. Ent. Soc. LVII, 1931, p. 165. *Pseudocistela* Hopping, Can. Ent. LXV, 1933, p. 282.
- TENEBRIONIDÆ** Smith, Proc. Iowa Acad. Sci. XXXVIII, 1931, p. 259-265 (Iowa).
- Tentyriinæ**: *Auchmobius* Blaisdell, Tr. Am. Ent. Soc. LX, 1934, p. 232-234. *Stibia* Blaisdell, l.c., LXII, 1936, p. 57-102. *Zopherodes* Blaisdell, Pan-P. Ent. VII, 1931, p. 113 (Cal.). *Usechini* Blaisdell, Proc. U. S. Nat. Mus. LXXV (19), 1929, p. 12.
- Scaurinae**: *Eulabris* Blaisdell, Tr. Am. Ent. Soc. LVIII, 1932, p. 35-101.
- Blaptinae**: *Eleodes* Blaisdell, Can. Ent. LXVII, 1935, p. 29 (*routundipennis*-group of *Blapyllis*); Pan-P. Ent. V, 1929, p. 163 (*Metablapyllis*).
- Diaperinae**: *Diaperis* Blaisdell, l.c., VI, 1929, p. 61. *Tribolium* Good, U. S. Dept. Agric. Tech. Bull. 498, 1936, p. 4.
- Tenebrioninae**: *Centronopus* Blaisdell, Tr. Am. Ent. Soc. LIX, 1933, p. 221. *Alobates* Cooper, Bull. Brook. Ent. Soc. XXVIII, 1933, p. 106.
- LAGRIIDÆ** Borehman, G. I., 204, 1936, 561 p. (sp. of world).
- MELANDRYIDÆ**: *Zilora* Mank, Psyche XLV, 1938, p. 102. *Scotochroa* Mank, Can. Ent. LXXI, 1939, p. 181. *Serropalpus* Mank, l.c., p. 237. *Mycterus*, see Pythidæ.

- BOSTRICHIDÆ** Anderson, Jour. Wash. Acad. Sci. XXIX, 1939, p. 388 (14 genera and 20 sp. of larvæ). **Hendecatomus** Lesne, Bull. Soc. ent. Fr. 1934, p. 174.
- LYCTIDÆ**: **Berginus**, see Mycetophagidæ.
- SCARABÆIDÆ** Paulian, Ann. Soc. ent. Fr. CVII, 1938, p. 228-234 (tribes of Scarabæitæ = Laprosticti); Hayes, Ill. Biol. Mon. XII (2), 1929, p. 73 (subfam. of larvæ); Blatchley, Fla. Ent. XI, 1927, p. 58-60; XII, 1928, p. 13, 28, 65; XIII, 1929, p. 33, 72; XIV, 1930, p. 14, 28 (Fla. tribes).
- Coprinæ** Paulian, Ann. Soc. ent. Fr. CVII, 1938, p. 231-235 (genera). **Deltochilum** Paulian, l.c., p. 237-296. **Onthophagus** Boucomont, l.c., CI, 1932, p. 293-332.
- Ægialiinæ** Brown, Can. Ent. LXIII, 1931, p. 9-19, 42-49. **Ægialia** Saylor, Pan-P. Ent. X, 1934, p. 75 (*Leptægialia*).
- Aphodiinæ**: **Aphodius** Brown, Can. Ent. LXI, 1929, p. 225 (*Diapterna*); Fall, Jour. N. Y. Ent. Soc. XL, 1932, p. 187 (*bidentatus*-group). **Dialytellus** Brown, Can. Ent. LXI, 1929, p. 212. **Euparixia** Hinton, Univ. Cal. Publ. Ent. VI, 1936, p. 275. **Atænius** Brown, Can. Ent. LXIV, 1932, p. 10 (*abditus* subspecies); Fall, Jour. N. Y. Ent. Soc. XXXVIII, 1930, p. 94 (*strigatus*-group). **Rhyssemus** Hinton, Pan-P. Ent. X, 1934, p. 30.
- Geotrupinæ** Paulian, Ann. Soc. ent. Fr. CVII, 1938, p. 228-229 (genera).
- Pleocominæ**: **Pleocoma** Davis, Bull. S. Cal. Acad. Sci. XXXIII, 1935, p. 7.
- Glaphyrinæ** Chapin, Proc. Biol. Soc. Wash. LI, 1938, p. 84 (genera).
- Melolonthinæ** Hayes, Ill. Biol. Mon. XII (2), 1929, p. 75 (genera of larvæ); Böving, Proc. Ent. Soc. Wash. XXXVIII, 1936, p. 174-175 (4 genera of larvæ). **Oncerus-Nefoncerus** Saylor, Proc. Ent. Soc. Wash. XL, 1938, p. 101. **Chnaunanthus** Saylor, Jr. Wash. Acad. Sci. XXVII, 1937, p. 534. **Phyllophaga** Travis, Iowa St. Coll. Jour. Sci. VIII, 1934, p. 315 (Iowa); Hayes, Ill. Biol. Mon. XII (2), p. 78 (34 sp. larvæ); Ritcher, Jour. Kans. Ent. Soc. XI, 1938, p. 24-27 (14 sp. larvæ from Kentucky); Sanderson, l.c. X, 1937, p. 256 (*heterodoxa*-group). Saylor, Proc. Ent. Soc. Wash. XLVI, 1939, p.

- 90 (*sociatus*-group); Proc. U. S. Nat. Mus. LXXXVI, 1939, p. 160 (*Phytalus*). **Chlænobia** Chapin, Smiths. Misc. Coll. XCIV (9), 1935, p. 2-4. **Dinacoma** Blaisdell, Pan-P. Ent. VI, 1930, p. 176. **Pachydemini** Barrett, Can. Ent. LXVII, 1935, p. 52; Cazier, Jour. Ent. Zool. XXIX, 1937, p. 81. **Hoplia** Boyer, Microënt. V (1), 1940, p. 1-31.
- Rutelinae** Ohaus, G. I., 199A, 1934, 172 p. (tribes; subtribes and genera of Rutelini); Hayes, Ill. Biol. Mon. XII (2), 1929, p. 75 (genera of larvæ). **Strigodermella** Hatch, Publ. Univ. Okla. Biol. Surv. II, 1930, p. 25.
- Dynastinae** Hayes, Ill. Biol. Mon. XII (2), 1929, p. 76 (genera of larvæ). **Cyclocephala** Saylor, Jour. Ent. Zool. XXIX, 1937, p. 67-70 (5 Cal. sp.). **Phileurini** Cazier, Bull. S. Cal. Acad. Sci. XXXVIII, 1939, p. 171.
- Cetoniinae** Hayes, Ill. Biol. Mon. XII (2), 1929, p. 77 (genera of larvæ). **Gymnetini** Schürhoff, Deutsch. Ent. Zeit. 1937, p. 69 (genera). **Gymnetis** Schürhoff, l.c., p. 71. **Cineretis** Schürhoff, l.c., p. 80. **Cremastocheilini** Cazier, Bull. S. Cal. Acad. Sci. XXXVII, 1938, p. 86 (genera and subgenera). **Osmoderma** Hoffmann, Ann. Ent. Soc. Amer. XXXII, 1939, p. 516. **Trichiotinus** Hoffmann, Ent. Amer. XV, 1935, p. 153. **Valgus** Cazier, Pan-P. Ent. XIII, 1937, p. 191.
- LUCANIDÆ** Hayes, Ill. Biol. Mon. XII (2), 1929, p. 77 (genera of larvæ). **Diphyllostoma** Linsley, Pan-P. Ent. VIII, 1932, p. 109; Fall, l.c., p. 159.
- CERAMBYCIDÆ** van Emden, Ent. Mo. Mag. LXXXV, 1939, p. 257-264 (genera of British larvæ). **Cerambycinae**: **Æmini** Linsley, l.c., p. 113 (genera). **Haplidus** Linsley, l.c., p. 113. **Methiini** Linsley, l.c., p. 120 (genera). **Phoracanthini** Linsley, Ann. Ent. Soc. Amer. XXIX, 1936, p. 462 (genera). **Aneflus** Linsley, l.c., p. 468. **Sphæriorini** Linsley, l.c., p. 468 (genera). **Lepturini** Hopping, Can. Dept. Mines and Resources Bull. 85 (Biol. Ser. 22), 1937, p. 1-27 (sp. of *Pyrotrichus-Euryptera*). **Clytini** G. Hopping, Ann. Ent. Soc. Amer. XXV, 1932, 529-570 and XXX, 1937, p. 438-457. **Neoclytus** Linsley, Pan-P. Ent. IX, 1933, p. 94 (*muricatulus*-group). **Atimini** Linsley Bull. S. Cal. Acad. Sci. XXXVIII, 1939, p. 63-80. **Atimia** Linsley, Pan-P. Ent., X, 1934, p. 23.

- Lamiinæ:** *Moneilema* Psota, Col. Contrib. I, 1930, p. 119 (*Moneilema* s. str.). *Monochamus* Linsley, Can. Ent. LXV, 1933, p. 118 (part). *Pogonocherini* Linsley, Ann. Ent. Soc. Amer. XXVIII, 1935, p. 74 (4 genera of larvæ), 76-103. *Pogonocherus-Ecyrus* Linsley, Pan-P. Ent. VII, 1930, p. 78, 86
- CHRYSOMELIDÆ** Beller and Hatch, Univ. Wash. Publ. Biol. I, 1932, p. 65-144 (Wash.); Zia, Sinensis VII, 1936, p. 339 (male genitalia of subfam.); Böving, Proc. Ent. Soc. Wash. XXXII, 1930, p. 57 (certain groups of larvæ).
- Donaciinæ:** *Donacia* Mead, Pan-P. Ent. XIV, 1938, p. 118 (Pacific Coast).
- Criocerinæ:** *Lema* Schaeffer, Jour. N. Y. Ent. Soc. XLI, 1933, p. 305.
- Clytrinae:** *Anomœa* (*Antipus*) Schaeffer, l.c., p. 309-311; Hatch, Publ. Univ. Okla. Biol. Surv. II, 1930, p. 26 (col. var. of *latioclavia*). *Bahia* Schaeffer, Jour. N. Y. Ent. Soc. XLI, 1933, p. 319.
- Chlamydinæ** (Fulcidacinæ) van Emden, Zool. Anz. CI, 1932, p. 14-16 (larvæ of 5 related groups and 4 genera).
- Eumolpinæ:** *Myochrous* Schaeffer, Jour. N. Y. Ent. Soc. XLI, 1933, p. 473. *Glyptoscelis* Krauss, Univ. Cal. Publ. Ent. VII, 1937, p. 22.
- Chrysomelinæ** Johnson, Proc. S. Dak. Acad. Sci. XIII, 1930, p. 38-44 (S. Dak.). *Chrysolina* Van Dyke, Bull. Brook. Ent. Soc. XXXIII, 1938, p. 46. *Phædon* Fall, Pan-P. Ent. V, 1929, p. 148.
- Galerucinæ** Böving, Proc. U. S. Nat. Mus. LXXV (2), 1929, p. 8 (certain genera and species of larvæ). *Erynephala* Blake, Jour. Wash. Acad. Sci. XXVI, 1936, p. 426. *Monocesta-Trirhabda* Blake, Proc. U. S. Nat. Mus. LXXIX (2), 1931, p. 9. *Galerucella* Hatch, Can. Ent. LXV, 1933, p. 14 (col. var. of *decora*). *Monoxia* Blake, Proc. U. S. Nat. Mus. LXXXVII, 1939, p. 150.
- Halicinæ:** *Disonycha* Blake, Proc. U. S. Nat. Mus. LXXXII (28), 1933, p. 9; Bull. Brook. Ent. Soc. XXV, 1930, p. 210 (*pensylvanica*-group). *Altica* Blake, Proc. Ent. Soc. Wash. XXXVIII, 1936, p. 15 (*bimarginata*-group). *Psylliodes* Fall, Can. Ent. LXV, 1933, p. 233.

- Hispinæ: Chalepus-Xenochalepus** Uhman, Festschr. E. Strand I, 1936, p. 61 (genera). **Chalepus** Uhman, l.c., p. 624. **Xenochalepus** Uhman, Rev. Ent. VIII, 1938, p. 420, 426. **Stenopodius** Blaisdell, Tr. Amer. Ent. Soc. LXIV, 1939, p. 427. **Microrhopala** McCauley, Bull. Brook. Ent. Soc. XXXIII, 1938, p. 148.
- MYLABRIDÆ** Bridwell, Proc. Ent. Soc. Wash. XXXIV, 1932, p. 103 (subfam.).
- BRENTIDÆ** Kleine, Ent. Nachr. XI, 1937, p. 17-29, 91-103 (genera). **Platystrophus** (*Eupsalis*) Kleine, l.c., XII, (1938) 1939, p. 69. **Paratrachelizus** (*Trachelizus*) Kleine, l.c., XI, 1937, p. 154.
- PLATYSTOMIDÆ** Pierce, Proc. U. S. Nat. Mus. LXXVII (17), 1930, p. 1-32 (genera; species except *Eusphyryus*, *Eupariius*, "Brachytarsini" and "Choragidæ"). **Brachytarsus** Zimmerman, Pan-P. Ent. XII, 1936, p. 191 (3 Cal. sp.).
- CURCULIONIDÆ** Keifer, Ent. Am. XIII, 1933, p. 48 (4 major groups of larvæ); van Emden, Tr. Roy. Ent. Soc. London LXXXVII, 1938, p. 7 (13 subfam. and tribes of larvæ).
- Rhinomacerinæ** Voss, Ent. Blätt. XXVII, 1931, p. 164 and XXVIII, 1932, p. 11-18, 67-72.
- Rhynchitinæ: Auletobius** (*Auletetes*) Voss, Arch. f. Naturg. LXXXVIII (A8), 1922, p. 29-95; Stett. Ent. Zeit. XCIV, 1933, p. 113-136. **Rhynchitini** van Emden, Tr. Roy. Ent. Soc. London LXXXVII, 1938, p. 12 (genera of larvæ). **Rhynchites** Voss, Kol. Rund. XXIV, 1938, p. 129-171.
- Attelabinæ** Voss, Stett. Ent. Zeit. LXXXV, 1925, p. 239-242 (genera); van Emden, Tr. Roy. Ent. Soc. London LXXXVII, 1938, p. 15 (genera of larvæ). **Attelabus** Fall, Bull. Brook. Ent. Soc. XXVI, 1931, p. 110; Voss, Stett. Ent. Zeit. LXXXV, 1925, p. 262-264 (*Homælabus*), p. 251-253 (*Synolabus*), p. 242-243 (*Himatolabus*).
- Apioninæ** van Emden, Tr. Roy. Ent. Soc. London LXXXVII, 1938, p. 17 (genera of larvæ).
- Otiorhynchinæ** Keifer, Ent. Am. XIII, 1933, p. 50 (8 genera of larvæ); van Emden, Stett. Ent. Zeit. XCVII, 1936, p. 66-99, 211-239 (tribes and genera of "Brachyderinæ"); Anderson, U. S. Dept. Agric. Mimeo. Ser. E. 422, 1938, 3 pp. (4 sp. larvæ

- related to *Pantomorus leucoloma*). **Cimbocera** Van Dyke, Pan-P. Ent. XI, 1935, p. 1. **Crocidema** Van Dyke, l.c., X, 1934, p. 186. **Mimetes** Van Dyke, l.c., XI, 1935, p. 83. **Dyslobus** Van Dyke, l.c., IX, 1933, p. 31; Keifer, Ent. Amer. XIII, 1933, p. 61 (3 sp. of larvæ). **Panscopus** Buchanan, Smiths. Misc. Coll. XCIV (16), 1936, 18 p. **Tropiphorus** Brown, Can. Ent. LXXII, 1940, p. 75. **Pantomorus** (incl. *Artipus*) Buchanan, U. S. Dept. Agric. Misc. Publ. 341, 1939, 39 p. **Brachyrhinus** Keifer, Mo. Bull. Dept. Agric. Calif. XX, 1931, p. 472 (Calif.); Ent. Am. XIII, 1933, p. 64 (5 sp. larvæ). **Mesagroicus** (*Lepidocricus*) Buchanan, Proc. U. S. Nat. Mus. LXXVI (4), 1929, p. 5-12. **Sciopithes** Van Dyke, Pan-P. Ent. XI, 1935, p. 88. **Agronus** Buchanan, Proc. Ent. Soc. Wash. XXXI, 1929, p. 103. **Paraptochus** Van Dyke, Pan-P. Ent. XI, 1935, p. 93. **Peritelinus** Van Dyke, l.c., XII, 1936, p. 20. **Nemocestes** (*Geoderces*) Van Dyke, l.c., p. 24. **Eucyllus** Van Dyke, l.c., p. 31.
- Curculioninæ:** **Lepidophorus** Van Dyke, l.c., VI, 1930, p. 149; Buchanan, Bull. Brook. Ent. Soc. XXXI, 1936, p. 2. **Hylobius** Buchanan, Proc. Ent. Soc. Wash. XXXVI, 1934, p. 254. **Smichronychi** Pierce, Bull. S. Cal. Acad. Sci. XXXVIII, 1939, p. 44 (genera and subgenera). **Smicronyx** Pierce, l.c. p. 45 (*Synertha*), p. 47 (*Pachyhanes*). **Sthereus** (*Trachodes*) Buchanan, l.c., XXXVII, 1935, p. 178. **Mecini** van Emden, Tr. Roy. Ent. Soc. London LXXXVII, 1938, p. 20 (genera of larvæ). **Gymnetron** Buchanan, Jour. Wash. Acad. Sci. XXVII, 1937, p. 313. **Cosmobaris** Hayes, Jr. Kans. Ent. Soc. IX, 1936, p. 29. **Anacentrinus-Oligolochus** Buchanan, Ann. Ent. Soc. Amer. XXV, 1932, p. 328-336. **Ceutorhynchus** Buchanan, Bull. Brook. Ent. Soc. XXXII, 1937, p. 207 (*ætatus*-group). **Perigaster** Buchanan, Jour. Wash. Acad. Sci. XXI, 1931, p. 321. **Eubrychiopsis** (*Phytobius*) Brown, Can. Ent. LXIV, 1932, p. 11. **Chalcodermus** Alsterlund, Proc. Ent. Soc. Wash. XXXIX, 1937, p. 219 (3 sp. larvæ).
- Cossinæ:** **Cossonous** Buchanan, Pan-P. Ent. XII, 1936, p. 111 (*pacificus*-group).
- Calendrînæ:** **Calendra** (*Sphenophorus*) Satterthwait, Ann. Ent. Soc. Amer. XXIV, 1931, p. 159 (pupæ).

- SCOLYTIDÆ** Chamberlin, Bark and Timber Beetles of N. A. n. of Mex. 1939, p. 107-469; Dodge, Univ. Minn. Agric. Exp. Sta. Tech. Bull. 132, 1938, 60 pp. (Minn.). **Scolytus** Blackman, U. S. Dept. Agric. Tech. Bull. 431, 1934, p. 6. **Hylesinæ** Bruck, Bull. S. Cal. Acad. Sci. XXXV, 1936, p. 38-51, 108-126 (western N. A.). **Carphoborus** Bruck, Can. Ent. LXV, 1933, p. 103. **Chramesus** Blackman, Jour. Wash. Acad. Sci. XXVIII, 1938, p. 536. **Pseudothyanoes** Bruck, Bull. S. Cal. Acad. Sci. XXXV, 1936, p. 30-37. **Cactopinus** Blackman, Proc. Ent. Soc. Wash. XL, 1938, p. 151. **Gnathotrichus** Blackman, Jour. Wash. Acad. Sci. XXI, 1931, p. 266. **Pseudopithyophthorus** Blackman, l.c., p. 225. **Ips** Hopping, Can. Ent. LXXI, 1939, p. 169 (*tridens*-group).
- STREPSIPTERA**: **Stylops** Bohart, Pan-P. Ent. XII, 1936, p. 10 (males); XIII, 1937, p. 49 (Cal. females).

II. INDEX TO LOCAL LISTS

GENERAL

- Leng and Mutchler**, II and III Suppl. 1926 to 1932 (incl.) to Cat. Col. Amer. n. of Mex. 1933, 112 p. (22,050 sp.). **Blackwelder**, IV Suppl. 1933 to 1938 (incl.) to Leng, Cat. Col. Amer. n. of Mex. 1939, 146 p. **Craighead and Middleton**, U. S. Dept. Agric. Misc. Publ. 74, 1930, 30 p. (83 sp. forest beetles; A). **Barrett**, Univ. Cal. Publ. Ent. V, 1932, p. 285-294 (128 sp. on *Jugulans* including 13 not N. Amer.). **Harris and Leng**, Amer. Mus. Nat. Hist. Mon. Ser. 5, 1916, 20 p. (Cicindelidæ). **Horn**, Tr. Amer. Ent. Soc. LVI, 1930, p. 76-86 (Cicindelidæ). **Wickham and Wolcott**, Bull. St. U. Iowa Lab. Nat. Hist. VI, 1912, p. 49-67 (119 sp. Cleridæ-Corynetidæ; C, D). **Easterling**, O. Jour. Sci. XXXIV, 1934, p. 140-142 (e.N.A.; 48 sp. injurius to conifers; B, C). **Wade**, A Contrib. to a Bibliog. of the Described Immature Stages of N. A. Col. (mimeographed) 1935, 114 p. (larvæ).

ALASKA⁴

- Scott**, Pan-P. Ent. IX, 1933, p. 126 (5 sp. Coccinellidæ; A, B).
Hatch, Pan-P. Ent. XIV, 1938, p. 145-149 (Aleutian Is.; 27

⁴ See note on Alaskan beetle fauna by Hatch, Pan-P. Ent. XIII, 1937, p. 63.

sp.; A, B); (and Engelhardt) Bull. Brook. Ent. Soc. XXXIV, 1939, p. 45-50 (60 sp.; A, B).

CANADA

Entomological Record,⁵ Ann. Rep. Ent. Soc. Ont. LIX, 1928, p. 111-120 (377 sp.; A; including 33 sp. Gyrinidæ and 169 sp. Scarabæidæ); LX, 1929, p. 149-155 (321 sp.; A); LXI (1930), 1931, p. 88-91 (164 sp.; A); 25th and 26th Rep. Queb. Soc. Protec. Plants, 1934, p. 140-162 (262 sp.; A). **Brown**, Can. Ent. LXIX, 1937, p. 106-111 (eastern Arctic; 28 sp.; A); LXXII, 1940, p. 65-78 (47 sp. introduced from Europe; A, B, D).

ALBERTA: **Wallis**, Contrib. Can. Biol. and Fish. IV, 1929, p. 223-225 (Jasper Park; 33 sp.; A, B). **Richmond**, Can. Ent. LXII, 1930, p. 184 (Grost R.; 11 sp. from trout).

BRITISH COLUMBIA:⁶ **Sherman, Harvey, and Taylor**, Bull. B. C. Ent. Soc. 2, 1906, p. 3 (11 sp.; A, B). **Harvey**, l.c., 3, 1906, p. 2 (Vancouver; 4 sp.; B). **Brittain**, Proc. Ent. Soc. B. C. 4, 1914, p. 17-19 (Okanagan Dist.; 73 sp.). **Anderson**, l.c., p. 57-58 (Okanagan Dist.; 26 sp.). **Bush**, l.c., p. 59-60 (106 sp.; A, B). **Dennys**, l.c., 24, 1927, p. 19-25 (Salmon Arm; 15 sp. hibernating in dry trees). **Smith**, Mus. Art Notes (Vancouver) IV, 1929, p. 69-74 (Copper Mt.; 199 sp.). **Leech**, Proc. Ent. Soc. B. C. 27, 1930, p. 11-12 (Salmon Arm; 15 sp. from smoking stumps); Pan-P. Ent. XI, 1935, p. 120-123 (14 sp. Carabidæ, 9 sp. Sphæridiini; A, B, C). **Clark**, Rep. Prov. Mus. B. C. 1930, 1931, p. 14 (5 sp.; A). **Dobzhansky**, Jour. N. Y. Ent. Soc. XLIII, 1935, p. 331-336 (30 sp. Coccinellidæ; A, B, C). **Hatch**, Bull. Brook. Ent. Soc. XXXIV, 1939, p. 45-49 (Stikine R.; 9 sp.; B).

ONTARIO: **Brimley**, Can. Field-Nat. XLIV, 1930, p. 135-140 (Rainy R. Dist.; 540 sp.; B). **Brown**, Can. Ent. LXVI, 1934, p. 225-231 (Timagami; 114 sp.; A, B, C).

⁵ All records of species published in the Entomological Record from its inception in 1901 through 1930, when its publication in the Annual Report of the Entomological Society of Ontario was discontinued, are indexed alphabetically by Petch, Gen. Index to the 38 Ann. Reports Ent. Soc. Ont. 1900-1937, 1939, 267 p.

⁶ Delete from p. 341: "**Tucker**, Can. Ent. XLII, 1910, p. 229-237 (Plano; 178 sp.; B, C).'" Plano is in Texas!

QUEBEC: **Brown**, Can. Ent. LXII, 1930, p. 231-237, 239-246; LXIV, 1932, p. 198-209 (n. shore Gulf of St. Lawrence; 2 lists of 192 and 115 sp.; A, B, C). **Blair**, Ann. Mag. Nat. Hist. (10) XII, 1933, p. 96 (Akpatok Is.; 9 sp.; C, D). **Chagnon**, Can. Ent. LXVII, 1935, p. 278 (Montreal; 16 sp. from *Polyporus betulinus*). **Morley**, Can. Ent. LXXI, 1939, p. 243-248 (Laniel; 18 sp. from coniferous logs; B, C). **Beaulne**, l.c. LXXII, 1940, p. 61-62 (18 sp.; A, B, C).

GREENLAND

Henricksen and Lundbeck, Meddel. om Gronl. XXII, 1917, p. 484-517 (41 sp.; A, C, D). **Blair**, Ann. Mag. Nat. Hist. (10) V, 1930, p. 394-400 (48 sp.; D).⁷ **Carpenter**, Ann. Mag. Nat. Hist. (11) I, 1938, p. 537-538 (w. Greenland; 7 sp.; A, B, C). **Henricksen**, Meddel. om Gronl. CXIX (10), 1939, p. 40-48 (44 sp.; A, C).

LOWER CALIFORNIA

Linsley, Pan-P. Ent. X, 1934, p. 59-63 (22 sp. Cerambycidae; A, B).

NEWFOUNDLAND

Bruton, Ent. News XLI, 1930, p. 37 (23 sp.).

LABRADOR: **Eidmann**, Arb. Morph. Taxon. Ent. Berlin-Dahlem II, 1935, p. 87-91 (S. Labrador; 61 sp.). **Frost**, Can. Ent. LXVI, 1935, p. 19 (3 sp.).

UNITED STATES

Wickham, Ent. Amer. VI, 1890, p. 83-88 (89 sp. Tenebrionidæ; A, C). **Knull**, Ent. News XLI, 1930, p. 82-86 (26 sp.). **Jeannel**, Arch. Zool. Exp. Gen. LXXI, 1931, p. 404-411 (Ky., Va., Ind.; 17 sp. from caves). **de Leon**, Can. Ent. LXVI, 1934, p. 53-58 (Mont., Wash., Id.; 70 sp.; A, B, C). **Park**, Ent. News XLVI, 1935, p. 212-215 (Ill., Ind., Wis., Mich.; 34 sp. myrmecophiles mostly from Ill.; A, B, C); **Psyche** XLII, 1935, p. 216-231 (15 sp. with *Formica ulkei*). **Good**, Jour.

⁷ Of these 48 species, one is endemic, 45 are found in northern Europe, 17 in North America, and only two in North America and not in Europe. The fauna is thus Palearctic and Greenland should not be included in future catalogues of Neartic Coleoptera.

- Kans. Ent. Soc. X, 1937, p. 135-148 (Mo., Kans., Okla.; 18 sp. in flour mills; A, B, C). **Kaston**, Conn. Agric. Exp. Sta. Bull. 408, 1938, p. 238-239 (82 sp. from elm). **SeEVERS**, Ann. Ent. Soc. Amer. XXXI, 1938, p. 422-441 (14 sp. termitophiles). **Hoffmann**, Bull. Brook. Ent. Soc. XXXV, 1940, p. 54-61 (57 sp. from elm bark and wood including 38 sp. from N. J.).
- ALABAMA**: **Löding**, Bull. Brook. Ent. Soc. XXVIII, 1933, p. 139-151 (486 sp.; A); XXIX, 1934, p. 43 (Mobile Bay; 9 sp.; C).
- ARIZONA**:⁸ **Wickham**, Ent. News. II, 1891, p. 130-132 (Pinal Mts.; 53 sp.; C); IX, 1898, p. 197-198 (Needles; 37 sp.; C). **McKinney**, Jour. Econ. Ent. XXXII, 1939, p. 809 (Salt River Valley; 10 sp. attacking vegetables; C).
- ARKANSAS**: **Hatch**, Publ. Univ. Okla. Biol. Surv. II, 1930, p. 15-26 (w. Ark.; 16 sp.; A, B, C).
- CALIFORNIA**: **Notman**, Bull. Brook. Ent. Soc. XXIV, 1929, p. 222-223 (n. Cal.; 58 sp. Carabidæ; A, B, C). **Larson and Fisher**, Ent. News XLI, 1930, p. 75 (15 sp. from beans). **Simonds**, Jour. Ent. Zool. XXIII, 1931, p. 61-63 (s. Cal.; 27 sp. of Cureulionidæ). **Thorpe**, Pan-P. Ent. VII, 1931, p. 145-153 (s. e. Cal.; 10 sp. from saline waters). **Davis**, Bull. Brook. Ent. Soc. XXVI, 1931, p. 187-188 (12 sp.; A, C); XXIX, 1934, p. 81-83 (Cypress; 21 sp. in ground squirrel burrows; B, C); Bull. S. Cal. Acad. Sci. XXXI, 1932, p. 75-87 (Fort Tejon; 272 sp.); XXXIII, 1934, p. 16-22 (53 sp. from nests of wood rat; A, B, C). **Fall**, Can. Ent. LXVI, 1934, p. 143-144 (Santa Cruz Is.; 50 sp.). **Ingram**, Jour. Ent. Zool. XXVI, 1934, p. 51-52 (Balboa Bay; 5 sp. *Cicindela*; B, C). **Lange**, Pan-P. Ent. XIII, 1937, p. 172-175 (Lassen Nat. For.; 71 sp. from Jeffrey Pine). **Moore**, Occ. Pap. San Diego Soc. Nat. Hist. II, 1937, 109 pp. (San Diego Co.; 1649 sp.; A, B). **von Blöcker**, Bull. S. Cal. Acad. Sci. XXXVIII, 1939, p. 152-156 (Channel Is.; 35 sp. Scarabæidæ; A, B, C). **White**, Pan-P. Ent. XV, 1939, p. 69-75 (Santa Barbara Co.; 20 sp. *Acmæodera*). **Donohoe**, Proc. Ent. Soc. Wash. XLI, 1939, p. 154-162 (Fresno and Tulare Co.; 32 sp. in stored raisins). **Barnes and Kaloostian**, Jour. Econ. Ent. XXXIII, 1940, p.

⁸ Cf. Torre-Bueno, Bull. Brook. Ent. Soc. XXXII, 1937, p. 187-194, on Arizona insect localities.

- 115-119 (Fresno; 9 sp. in stored raisins). **Linsley and Ross**, Pan-P. Ent. XVI, 1940, p. 75-76 (San Jacinto Mts.; 11 sp.; C).
- COLORADO**: **Wickham**, Ent. News X, 1899, p. 5-8 (Colorado Springs; 73 sp.; C); XI, 1900, p. 597-600 (Breckenridge; 45 sp.; C). **Carter**, Pan-P. Ent. VI, 1930, p. 4 (Rocky Ford; 4 sp.). **Smith**, Jour. Colo-Wyom. Acad. Sci. II (5), 1939, p. 37 (Amphizoidæ and Haliplidæ).
- CONNECTICUT**: **Britton**, Conn. St. Geol. Nat. Hist. Surv. Bull. 60, 1938, p. 79-114 (suppl. list of 571 sp.).
- FLORIDA**: **Wickham**, Ent. News VI, 1895, p. 210-212 (Tortugas Key; 24 sp.; C). **Notman**, Bull. Amer. Mus. Nat. Hist. XLII, 1920, p. 693-732 (101 sp. Staphylinidæ; A, B, C). **Blatchley**, Fla. Ent. XI, 1927, p. 44-46, 55-62; XII, 1928, p. 9-14, 22-30, 44-46, 63-65; XIII, 1929, p. 33-37, 52-56, 69-77; XIV, 1930, p. 13-17, 25-35 (196 sp. Scarabæidæ; A, B, C); Can. Ent. LXII, 1930, p. 28-35 (54 sp.; A, B, C). **Young and Goff**, Fla. Ent. XXII, 1939, p. 59-61 (17 sp. in burrows of Florida gopher tortoise; A, B, C).
- GEORGIA**: **Fattig**, Ent. News XLVI, 1935, p. 153-160; XLVII, 1936, p. 15-20, 233-238; XLVIII, 1937, p. 4-10, 250-255 (729 sp.; Cicindelidæ—Phalacridæ).
- IDAHO**: **Bedard**, Can. Ent. LXX, 1938, p. 191-194 (Coeur d'Alene; 59 sp. on Douglas Fir; C).
- ILLINOIS**: **Park**, Ecol. XII, 1931, p. 200 (Chicago; 37 sp. from *Hydnum septentrionale*; B), p. 204 (Chicago; 42 sp. from fungi; C).
- INDIANA**: **Montgomery**, Proc. Ind. Acad. Sci. XL, 1931, p. 357-359 (18 sp. Cicindelidæ; A, B, C). **Wolcott and Montgomery**, Am. Midl. Nat. XIV, 1933, p. 113-169 (Mineral Springs; 393 sp.; B, C). **Trippel**, Bull. Brook. Ent. Soc. XXIX, 1934, p. 74-76 (19 sp. Chrysomelidæ; A, B, C). **Park and Strohecker**, O. Jour. Sci. XXXVI, 1936, p. 48-49 (n. Ind.; 31 nocturnal sp.; C). **Summerland and Amos**, Jour. Econ. Ent. XXXIX, 1936, p. 1172 (Orleans; 32 sp. Cerambycidæ in bait traps; B).
- IOWA**: **Wickham**, Can. Ent. XXIV, 1892, p. 99-101 (28 sp. winter beetles; C); Psyche VI, 1892, p. 321-323; VII, 1894, p. 79-81 (22 sp.), 1896, p. 370-372 (14 sp.); VIII, 1898, p. 219-221 (3 sp.); IX, 1900, p. 3-5 (30 sp.) (Iowa City; myrmecophiles;

- C). **Jaques**, Proc. Iowa Acad. Sci. XXXIII, 1926, p. 337-339 and XXXIV, 1927, p. 314-315 and XXXV, 1928, p. 303-304 (31 sp. *Phyllophaga*; A, C). **Longnecker**, l.c., XXXV, 1928, p. 307 (39 sp. Coccinellidæ). **Ware**, l.c., XXXVI, 1929, p. 368-369 (Henry Co.; 45 sp. Cerambycidæ). **Hendrickson**, Iowa St. Coll. Jour. Sci. IV, 1930, p. 91-120 (310 sp. from prairies; A, B, C); Can. Ent. LXIII, 1931, p. 110 (Ames; 13 sp. from roots of marsh grass; B); Bull. Brook. Ent. Soc. XXVIII, 1933, p. 193 (7 sp. Mordellidæ; A, B, C). **Travis**, Iowa St. Coll. Jour. Sci. VII, 1933, p. 397 (21 sp. *Phyllophaga*; C). **Bleasdel**, l.c., XI, 1937, p. 405-445 (462 sp. Rhyncophora; A). **Hatch**, Jour. Kans. Ent. Soc. XI, 1938, p. 17-20 (14 sp. Histeridæ; A).
- KANSAS**: **McColloch**, Tr. Kans. Acad. Sci. XXX, 1922, p. 182-183 (Riley Co.; 4 sp. *Eleodes*; A, C). **McColloch** and **Hayes**, l.c., p. 184-195 (Riley Co.; 29 sp. *Phyllophaga*), p. 345-351 (59 sp. Scarabæidæ Pleurosticti; A, B, C). **Hayes**, l.c., p. 205-212 (169 sp. Rhyncophora; A, C). **Douglass**, Jour. Kans. Ent. Soc. II, 1929, p. 2-15, 26-38 (315 sp. Chrysomelidæ; A, C). **Knaus**, Jour. Kans. Ent. Soc. I, 1928, p. 98-99 (Medora Sand Hills; 17 sp.; B, C); II, 1929, p. 66-69 and III, 1930, p. 79 (38 sp. *Agrilus*; A, C). **Smith**, Jour. Econ. Ent. XXXII, 1939, p. 756 (6 sp. from castor bean plants).
- LOUISIANA**: **Glick**, U. S. Dept. Agric. Tech. Bull. 673, 1939, p. 29-37 (Tallulah; 175 sp. in air; C).
- MAINE**: **Procter**, Biol. Surv. Mt. Desert Reg. VI, 1938, p. 87-174 (Mt. Desert Is.; 888 sp.; A, B, C).
- MASSACHUSETTS**: **Frost**, Bull. Brook. Ent. Soc. XXV, 1930, p. 46 (7 sp. *Acton*). **Johnson**, Ins. Fauna Nantucket, Mass., Publ. Nantucket Maria Mitchell Assoc. III (2), 1930, p. 38-69 (Nantucket; 535 sp.; A, B).
- MICHIGAN**: **Jewell** and **Brown**, Ecol. X, 1929, p. 434-443 (Cheboygan Co.; 5 lists of 13, 12, 4, 14, and 22 sp. aquatic sp.; A, C). **Cole**, Ent. News XLII, 1931, p. 36 (Monroe; 4 sp. from *Typha*).
- MINNESOTA**: **Fletcher**, Can. Ent. LXI, 1929, p. 256-260 (59 sp.; A, B, C).
- MONTANA**: **Hatch**, Can. Ent. LXV, 1933, p. 5-15 (252 sp. of 9

fam.; A). **Mank**, l.c., LXVI, 1934, p. 73-81 (Glacier Nat. Park; 318 sp.; B).

NEBRASKA: **Powell**, Ent. News XLIII, 1932, p. 92-97 (24 sp. Chrysomelinae; A, B, C). **Meserve**, l.c., XLVII, 1936, p. 132-134 (21 sp. Silphidae; A, B, C); p. 270-275 (30 sp. and 29 var. Cicindelidae; A, B, C). **Whelan**, Jour. Kans. Ent. Soc. IX, 1936, p. 111-115 (prairie near Lincoln; 102 sp.; B, C); XII, 1939, p. 118-120 (Lincoln; 13 sp. Meloidae and Coccinellidae from light traps).

NEW JERSEY: **Sim**, Jour. N. Y. Ent. Soc. XXXVIII, 1930, p. 139-147 (20 sp. Scarabaeidae; A, B, C). **Wilson**, l.c., XL, 1932, p. 77-83 (Princeton; 43 sp. from sheep dung; B). **Metzger** and **Sim**, Jour. Econ. Ent. XXVI, 1933, p. 296-297 (Woodstown; 36 sp. at light). **Moennich**, Bull. Brook. Ent. Soc. XXXIV, 1939, p. 155-157 (14 sp. from fungi; A, B, C). **Whitten** and **Baker**, Jour. Econ. Ent. XXXII, 1939, p. 631 (Morristown; 11 sp. in elm bark and wood; C). **Hoffmann**, Bull. Brook. Ent. Soc. XXXV, 1940, p. 54-61 (38 sp. from elm bark and wood).

NEW YORK: **Ochs**, Jour. N. Y. Ent. Soc. XXXVIII, 1930, p. 135-137 (25 sp. Gyrinidae; A, B). **Cooper**, Bull. Brook Ent. Soc. XXV, 1930, p. 21-24 (Flushing; 65 sp.; B, C); XXVII, 1932, p. 189-195 (Long Is.; 142 sp.; A); XXX, 1935, p. 142-159 (157 sp. suppl. N. Y. St. list). **Belkin**, l.c., XXVIII, 1933, p. 220-222 (Roslyn; 55 sp.). **Wolcott**, Ecol. Mon. VII, 1937, p. 43-55 (Oneida Co.; 80 sp. in two pastures and a meadow; A, B, C). **Pechuman**, Bull. Brook. Ent. Soc. XXXII, 1937, p. 9-14 (53 sp. from bark and wood of *Ulmus americana*; A). **Moennich**, l.c., p. 169-170 (21 sp. from *Pleurotus* fungi); XXXIV, 1939, p. 155-157 (Little Neck; 15 sp. from fungi; B, C).

NORTH CAROLINA: **Manee**, Ent. News XXIV, 1913, p. 167-171 (Southern Pines; 36 sp. Buprestidae; B, C). **Sherman**, l.c., p. 245-247 (21 sp. Meloidae; A, B, C). **Brimley**, Ins. N. Car. 1938, p. 113-248 (2959 sp.; A, B). **Savely**, Ecol. Mon. IX, 1939, p. 378-379, 382-383 (Durham; 60 sp. from pine logs; 68 sp. from oak logs; C).

OHIO: **Bomberger** and **Hill**, Ohio Acad. Sci. II, 1893, p. 41-45 (Columbiana Co.). **Easterling**, Ohio Jour. Sci. XXXIV, 1934,

- p. 131, 135 (York Forest; 9 sp. in coniferous association).
Everley, l.e., XXXVIII, 1938, p. 140-148 (Toledo; 130 sp. in sweet corn; B, C).
- OKLAHOMA: Shackleford** (with Davidson), Proc. Okla. Acad. Sci. IX, 1929, p. 54-59 (Chickasha; 12 sp.; C); XV, 1935, p. 68-72 (Chickasha; 13 sp.; A, B, C). **Hatch and Ortenburger**, Publ. Univ. Okla. Biol. Surv. II, 1930, p. 7-26 (3 lists of 94, 59, and 76 sp.; A, B, C). **Fenton**, Proc. Okla. Acad. Sci. XVII, 1937, p. 31 (26 sp. *Phyllophaga*). **Hefley**, Ecol. Mon. VII, 1937, p. 389 (Canadian R. floodplain; 12 sp.; A, B, C).
- OREGON: Larson and Hinman**, Proc. Ent. Soc. Wash. XXXIV, 1932, p. 43-44 (Corvallis; 38 sp. in moss and lichens on oak). **Hatch and Beller**, Pan-P. Ent. VIII, 1932, p. 102-107 (91 sp. Chrysomelidæ; A). **Canova**, l.e., XII, 1936, p. 126-132 (80 sp. Lepturini; A). **Beer**, l.e., XVI, 1940, p. 13-16 s.w. Ore.; 11 sp. Buprestidæ; A, C).
- PENNSYLVANIA: Frost and Dietrich**, Ann. Ent. Soc. Amer. XXII, 1929, p. 427-437 (Arendtsville; 138 sp.; B, C). **Knoll**, Ent. News XLI, 1930, p. 82-86, 101-102 (56 sp.; A, B, C); XLIII, 1932, p. 42-45, 62-67 (74 sp.; A, B, C), (with Champlain) p. 253-257 (84 sp. in 5 fam.; A, B, C); XLV, 1934, p. 207-212 (53 sp.; A, B, C). **Gamble**, l.e., XLIII, 1932, p. 123 and Univ. Pitts. Bull. XXVIII (4), 1931, p. 2 (Presque Isle; 91 aquatic sp.). **Hallock**, Ent. News L, 1939, p. 121-124, 156-159 (Lancaster Co.; 11 sp. Halticinae; C).
- RHODE ISLAND: Davis**, Check List Col. R. I., 1st ed., 1901 (755 sp.); 2nd ed., 1902, p. 10-47 (948 sp.; B).
- SOUTH CAROLINA: Cartwright**, Ent. News XLII, 1931, p. 269-270 (Jacassee; 20 sp. Buprestidæ caught by wasps); XLV, 1934, p. 237-240, 268-269 (Clemson College; 147 sp. Scarabæidæ; B, C); Bull. Brook. Ent. Soc. XXX, 1935, p. 69-77 (22 sp. Cicindelidæ); Ent. News L, 1939, p. 284-286 (46 sp. Scarabæidæ; A, B, C).
- SOUTH DAKOTA: Gilbertson**, Proc. S. Dak. Acad. Sci. XI, 1927, p. 22-26 (17 sp. and 10 var. Cicindelidæ; A, B).
- TENNESSEE: Meyer**, Ecol. Mon. VII, 1937, p. 437-439 (Nashville; 51 sp. from cedar glades; B, C).
- TEXAS: Wickham**, Ent. News IX, 1898, p. 22-24, 39-41, 81-84 (Brownsville; 133 sp.; C). **Tucker**, Can. Ent. XLII, 1910, p.

229-237 (Plano; 178 sp.; B, C); Tr. Kans. Acad. Sci. XXX, 1922, p. 150-154 (14 sp. from mistletoe; A, B, C). **Gaines**, Bull. Brook. Ent. Soc. XXVIII, 1933, p. 50-52 (Burlleson Co.; 89 sp. in cotton fields), p. 211-215 (55 sp. Coccinellidæ; A, B, C). **Linsley and Martin**, Ent. News XLIV, 1933, p. 178-183 (Brownsville; 65 sp.; C).

UTAH: Tanner, Pan-P. Ent. VI, 1929, p. 78-87 (24 sp. and 16 var. Cicindelidæ); Ann. Ent. Soc. Amer. XXVII, 1934, p. 43-49 (Zion. Nat. Park; 81 sp.; C); (and Hayward) Ut. Acad. Sci. Arts & L. XI, 1934, p. 216-221 (La Sal Mts.; 88 sp.; A, C). **Pack**, Ent. News XLI, 1930, p. 219-222 (48 sp. Cerambycidæ, CEdemeridæ, Elateridæ; A, B). **Knowlton**, Fla. Ent. XIV, 1930, p. 36-37, 53-56, 75-77; XV, 1931, p. 10 (112 sp.; A, B, C); (and Cutler) Ut. Acad. Sci. Arts and L. IX, 1933, p. 11 (Snowville; 14 sp.); (and Thomas) XI, 1934, p. 245-246 (Logan; 105 sp.); (and Thatcher) XIII, 1936, p. 277-281 (92 sp. Buprestidæ, Cerambycidæ; A, B, C); Jour. Kans. Ent. Soc. VII, 1934, p. 79-86 (124 sp.; A, B, C); IX, 1936, p. 107-111 (69 sp. in 8 fam.; A, B, C); (and Smith) Ent. News XLVI, 1935, p. 241-244 (63 sp. Scarabæidæ and Chrysomelidæ; A, B, C); (and Nye) Utah Agric. Exper. Sta. Mimeograph Ser. 200 (Tech.), part 3, 1939, 25 p. (660 sp.; A, B, C). **Thatcher**, Ut. Acad. Sci. Arts and L. XII, 1935, p. 261 (15 sp. Scolytidæ; A, B, C).

VIRGINIA: Jones, Proc. Ent. Soc. Wash. XXXVII, 1935, p. 151 (Virginia Beach; 19 sp. along seashore).

WASHINGTON: Hatch, Pan-P. Ent. VIII, 1931, p. 78 (9 sp. Sphæridiinae; A); (with Exline) Jour. N. Y. Ent. Soc. XLII, 1934, p. 450 (San Juan Is.; 20 sp. from black widow spider nests); Ent. Notes (mimeographed) 1937, p. 48-52 (Seattle; 379 common sp.); (with Pratt) Jour. N. Y. Ent. Soc. XLVI, 1938, p. 191-193 (Whidby Is.; 24 sp. from black widow spider nests); Univ. Wash. Publ. Biol. I, 1938, p. 183-194 (201 injurious sp.); Prelim. List Col. Wash. (mimeographed) 1939, 41 p. (2070 sp. plus 130 unnamed sp.; A); Pan-P. Ent. XVI, 1940, p. 34-35 (Seattle; 12 sp. in flour mill; B). **Scheffer**, Ecol. XIV, 1933, p. 29-30 (Echo L.; 36 aquatic sp.). **Gray**, Univ. Wash. Theses Ser. II, 1937, p. 309-313 (38 sp. Agonini). **Beer**, l.c., IV, 1939, p. 277-278 (56 sp. Buprestidæ; A).

CONCERNING THE MUSCULATURE OF THE MALE GENITALIA IN PANORPA NUPTIALIS GERST.

BY CYRIL E. ABBOTT

The Mecoptera are insects of ancient origin, combining with certain generalized and probably primitive characters, certain specializations peculiar to the group.

The male genitalia of *Panorpa nuptialis* Gerst. are typical of the group, in that they exhibit a primitive forcipate condition; but also like others of the group, they include accessory structures which are extremely elaborate and therefore specialized. This is true, not only of the chitinous parts, but of those muscles which activate them, so that a complete analysis of both is necessary in order to homologize them with the corresponding parts of related insects.

Since, furthermore, a description of the chitinous structures

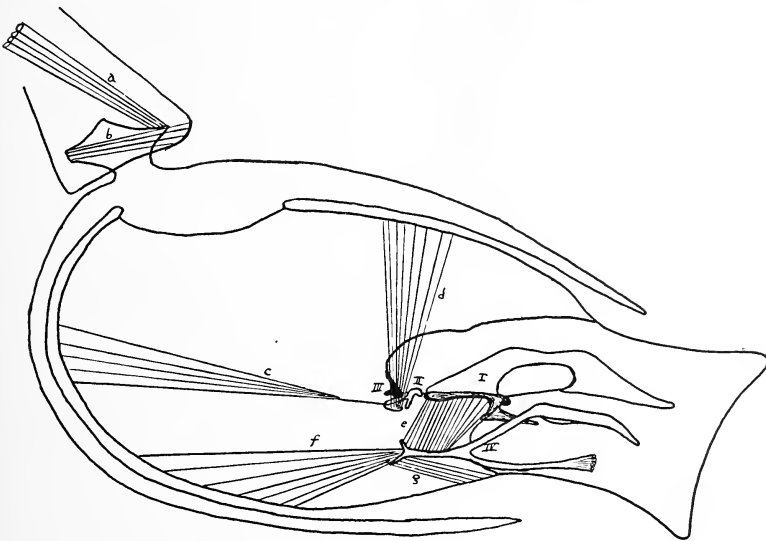

Fig. 1

is essential to and indeed inseparably bound up with the muscles, I am taking the liberty of describing in detail parts which doubtless have been described before.

The abdomen of the male *Panorpa* terminates in a bulbous enlargement consisting of four, articulated, exoskeletal parts. The most distal of these are the dorso-ventrally articulated (and hence laterally moveable) forceps. These are simply extensions of the bases of the bifurcation; bases which constitute an immovable part of the bulbous portion. This bulbous portion is in turn articulated with and partially inclosed in a strap-shaped segment which circles it dorso-ventrally (Fig. 1). This piece is in turn articulated with the last, generalized segment of the abdomen.

Caudally, between the bifurcation of the bulbous portion, and more or less retracted into an investing pocket, is the copulatory apparatus proper. It consists of: (1) a median furca, the exposed tines of which are twisted laterally and are ventrally concave. (Figs. 1 and 3, I); (2) a minute, intermediate piece (Fig. 2), by

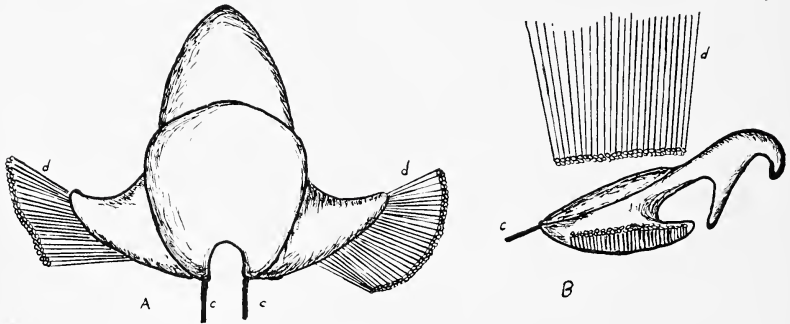

Fig. 2

means of which the median furca articulates with a dorsal invagination of the external cuticula; and (3) two lateral furcæ (Figs. 1 and 3, IV), each of which terminates dorsally in a spatulate tine, its ventral counterpart ending in a "ruffle." The trilobed base of each lateral furca is attached by means of muscles shortly to be described. The entire copulatory apparatus is not more than 2 mm. in length.

The musculature of these parts produces an interesting complex of movements. To each lateral furca three sets of muscles are

attached. One of these (Figs. 1 and 3, e) has its origin on the ventral margin of the median furca, and extends for some distance into the hollow interior of that organ. A fan-shaped sheet of

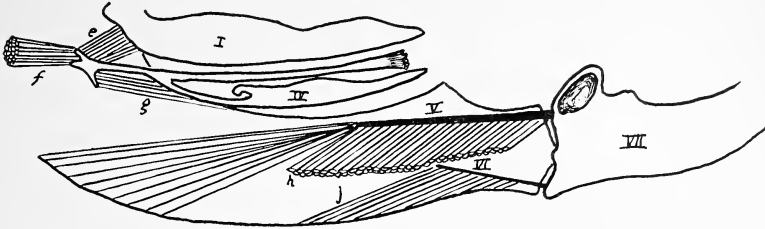

Fig. 3

muscle (Figs. 1 and 3, f) extends from the lateral furca to the ventral body wall anteriorly, while a third muscle (g) originates on the body wall ventro-medially and *posterior* to the base of the furca. Two other pairs of muscles are attached, not to the lateral furcæ, but to the middle piece illustrated in detail in Fig. 2 (in Fig. 1, II). One of these (d) has its insertion in the expanded ventro-lateral extension of the piece, and extends dorsally to the body wall; the other (c) extending anteriorly, is inserted on a tendon continuous with the anterior of the middle piece.

Let us consider the action of the muscles thus far described. It is evident that the contraction of *g* extrudes the lateral furca, while *f* is definitely a retractor of that part. The contraction of *e*, by proximating the bases of the lateral and median furcæ, separates their distally exposed tines. The contraction of *d*, by forcing the middle piece (II) *down*, has the corresponding effect; while *c*, though producing a similar effect, also acts as a retractor of the median furca.

In Fig. 3 the interior of one side of the forceps is illustrated. The base of the tine is articulated dorsally and ventrally on pivots, its extension and flexion depending upon paired muscles attached to flattened tendons which penetrate the immovable base. Of these tendons, the median is by far the larger; its musculature (h) is correspondingly heavy, and, occupies a considerable portion of the space within the basal bifurcation, on the lateral wall of

which it has its origin. Consequently it is capable of flexing the tine with considerable force. But *j*, which is the *extensor* of the tine is not large. Curiously enough, it has its origin very close to that of the flexor of the tine. Extension of the tine is, therefore, relatively feeble as compared with its flexion: this may be corroborated by observing the action of the forceps in the living insect. This is doubtless accounted for by the force necessary to hold the female during copulation.

In closing, I want to thank Mr. A. B. Gurney of the Bureau of Entomology and Plant Quarantine for the identification of the species used in this study.

MORTALITY AMONG HIBERNATING LARVÆ OF
THE JAPANESE BEETLE WITH SPECIAL
REFERENCE TO CONDITIONS IN
THE WINTER OF 1935-36

BY I. M. HAWLEY AND T. N. DOBBINS

UNITED STATES DEPARTMENT OF AGRICULTURE
BUREAU OF ENTOMOLOGY AND PLANT QUARANTINE

In 1916 a few Japanese beetles (*Popillia japonica* Newman) were found in this country near Riverton, N. J. Each year the insect has moved outward in all directions until the area covered by its natural spread in 1938, commonly spoken of as the area of general distribution, embraced 15,100 square miles, with a northern limit in southeastern New York, a western limit near Harrisburg, Pa., and a southern limit in northeastern Maryland. This area of general distribution is still so small that climatic conditions near its outer limits vary but little from those near the point of introduction. Beyond this generally infested area are many isolated colonies, in some of which beetles are present locally in moderate numbers. The most northern infestation of this type is at Brewer, Maine, and the most southern is at Atlanta, Ga. At some of the isolated colony sites to the north the insect has encountered climatic conditions that have brought about marked differences in the seasonal cycle from that found in central New Jersey, but even at the more widely separated points the insect has now been established for several years. This indicates that, if climatic factors of any kind are to limit or retard the ultimate spread and establishment of the insect in this country, their influence has not, as yet, become operative.

Extensive studies dealing with the biology of the Japanese beetle in the earliest infested area and its reactions to climatic conditions were carried on by Fox (1, 3).¹ Data obtained in this investigation led him to believe that the major climatic factors limiting the establishment of the pest in parts of this country now uninfested would be a deficiency of summer rainfall when

¹ Italic numbers in parentheses refer to Literature Cited.

eggs and small larvæ are dominant in the soil, low summer temperatures at certain northern points which might prevent the insect from completing its summer cycle, and, lastly, low soil temperatures in winter which might destroy hibernating larvæ. In the older infested area there have been several seasons in which a deficiency in summer rainfall has been definitely correlated with a decrease in infestation the following year. Because of the restricted spread of the insect, no field data on the influence of summer temperatures are available. As to the influence of low winter temperatures on survival, certain data have been obtained, and this subject will be treated in some detail.

As Fox (3) points out, the Japanese beetle in its spread to the north will probably encounter climatic conditions where winter mortality will be an important factor affecting its establishment. However, in the area then generally inhabited by this pest there was no evidence prior to 1936 that larvæ were ever killed in appreciable numbers during the winter months. In another paper Fox (2) presented data to show that the reduction in the soil population during the winter months in a 7-year period averaged only 3 per cent, based on the maximum population for the year, which occurs normally early in September.

The winter of 1933-34 was unusually severe throughout most of the East, and the general public, largely as a result of reports circulated in the press, was led to believe that a high mortality among overwintering larvæ of the Japanese beetle would occur. As pointed out by Fox (1), the mortality that year was not appreciably higher than in winters featured by milder weather. It came to be assumed, therefore, that, within the present limits of general distribution, extended periods of severe winter were of negligible importance in destroying this pest. In 1936, however, a heavy mortality among overwintering larvæ was associated with a cold period in January and February involving unusual meteorological conditions. It is of this mortality in 1936 and the circumstances accompanying it that this paper will deal.

Tolerance to cold in larvæ of the Japanese beetle has been the subject of investigation by various workers. Fox (1, 3) reviewed papers by these authors and reassembled unpublished data obtained at the Moorestown laboratory dealing with the lethal tem-

peratures required to destroy larvæ in balled nursery plants. As a result of these studies, supplemented by observations of his own, he came to the conclusion that a soil temperature of 15° F. (-9.4° C.) was the lowest temperature that could be withstood by hibernating larvæ of the Japanese beetle under natural conditions, and that a few might succumb at temperatures as high as 22° F. (-5.6° C.).

Most larvæ of the Japanese beetle winter in the ground at depths between 2 and 6 inches. Soil-temperature records taken at the 3-inch depth at Moorestown, N. J., have shown that in most years, the temperatures at this depth do not fall below 30° F. In fact, in only four years since 1925, namely, 1926, 1927, 1934, and 1936, have soil temperatures at 3 inches been recorded below this temperature. As noted by Fox (1), a snow cover of only 1 to 2 inches will act as an insulating blanket for the ground beneath and serves to keep soil temperatures at or near the freezing point of water even when air temperatures fall far below freezing. In years with adequate snow cover, therefore, there is little mortality among larvæ.

The existence of heavy winter mortality in 1936 was accidentally discovered by one of the members of the laboratory staff, when the ground was still partially frozen. As soon as this unusual situation was confirmed at several widely separated points, surveys were begun to determine the extent and degree of mortality. Soil surveys or diggings were made at as many points in New Jersey, Pennsylvania, Delaware, and Maryland as time would permit. The time available for this work was limited to about four weeks, since, as soil temperatures rose, dead larvæ decomposed and disappeared and counts of the living and dead could no longer be made.

On the map, Figure 1, is shown the mortality found in surveys, expressed as the percentages of the total number of larvæ recovered. At least 10 surveys, each in a plot 1 foot square, were made at each point, and at some sites 50 or more were made. It is evident that the mortality varied greatly in different parts of the area surveyed, and in many cases there was considerable variation even at closely associated stations. From the map it is apparent that the highest mortality occurred in south-central

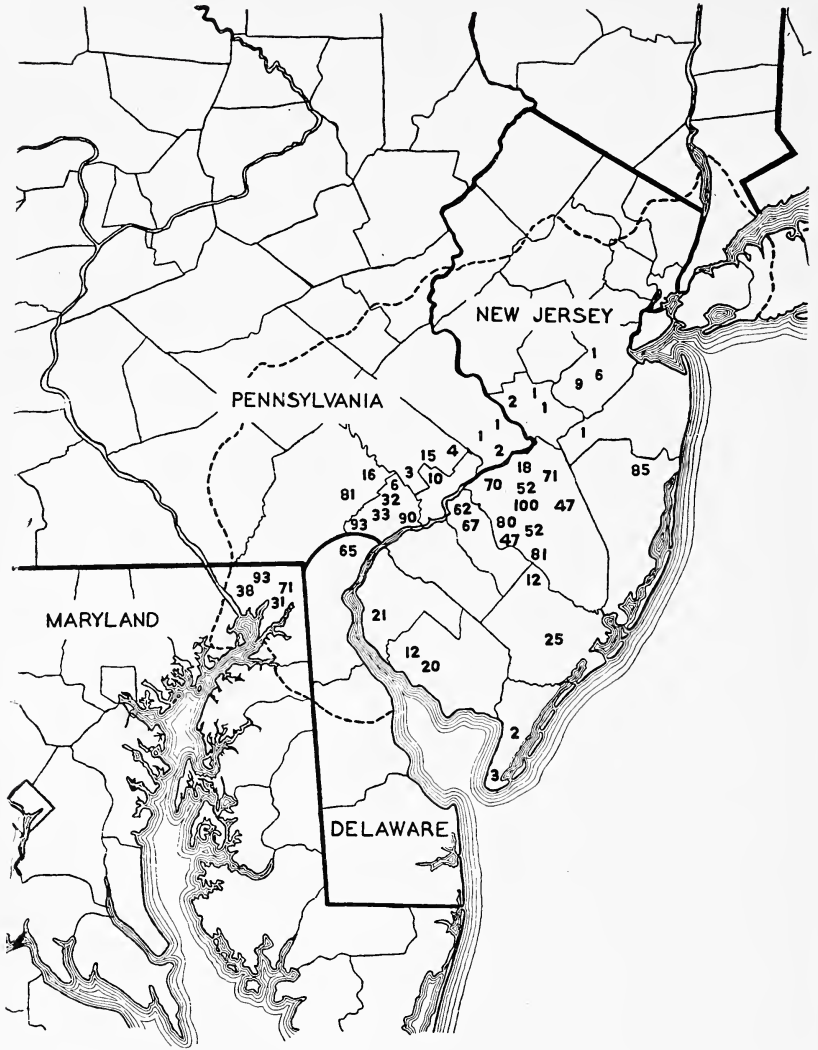

Fig. 1. The mortality among hibernating larvæ of the Japanese beetle, following the cold period of January–February, 1936, as found in soil surveys at selected points. Mortalities are expressed as the percentages of the actual numbers of larvæ recovered. The broken line indicates the limit of the area of general distribution of the beetle in 1935.

New Jersey, southeastern Pennsylvania, northern Delaware, and northeastern Maryland.

Some features in the succession of meteorological events preceding the cold period of 1936 were in marked contrast to those recorded in previous years. Thus, in the three weeks preceding the cold period in 1936 the precipitation throughout the general area of infestation was roughly 4.8 inches, while in 1934, the most severe winter since 1917, it was approximately only 0.9 inch.² Probably of greater significance was the fact that throughout most of the area of general infestation a rain immediately preceded the cold period of 1936. As this storm developed it was characterized by a marked drop in air temperatures which altered radically the form of precipitation in different localities. At the conclusion of the storm and the beginning of the cold period the covering ranged from approximately 1.5 inches of glaze, sleet, and some snow in northern Delaware and Maryland to roughly 7.0 inches in north-central New Jersey, the latter consisting largely of snow but also of varying amounts of sleet.

The history of the snow and sleet covering throughout the area generally infested was quite similar to that indicated for Moores-town in table 1, decreasing generally to less than an inch in most of southern New Jersey, as well as the adjacent sections of Pennsylvania, Delaware, and Maryland, while, on the other hand, in north-central New Jersey the covering never fell below approximately 4 inches. A subsequent general snow occurring at the beginning of the latter half of the cold period provided a covering of from 10 to 14 inches in southeastern Pennsylvania and north-central New Jersey and from 2 to 7 inches in different localities of southern New Jersey.

The area experiencing the unusually heavy mortality corresponded quite closely with the area in which the covering during the first two weeks was limited principally to glaze and sleet. It also must be emphasized that this was the area in which the greatest amount of rain appears to have fallen immediately preceding the sleet and snow.

² The writers wish to acknowledge the kind cooperation of the regular stations of the U. S. Weather Bureau located in Baltimore, Philadelphia, and Trenton in supplying meteorological data for the periods concerned.

TABLE 1

COMPARISON OF AIR AND SOIL TEMPERATURE TRENDS AT MOORESTOWN, N. J.,
DURING TWO COLD PERIODS IN THE WINTERS OF 1933-34
AND 1935-36

Days after start of cold period	Mean temperatures (°F.) for 3-day periods									
	Air		Soil						Snow and sleet cover	
			3" depth		6" depth		9" depth			
	1934	1936	1934	1936	1934	1936	1934	1936	1934	1936
1	13.5	27.0	31.9	36.1	32.9	37.1	34.3	38.0	0	1.6 ^a
1-3	21.8	25.5	31.6	34.6	32.4	35.5	33.6	36.5	0	1.8 ^a
2-4	23.9	26.3	31.3	33.5	32.1	34.3	33.2	35.2	0.8	1.6 ^a
3-5	21.7	21.8	31.3	32.9	32.0	33.8	33.1	34.3	4.2	1.4 ^a
4-6	15.3	16.2	31.2	32.3	31.9	33.3	33.0	33.8	7.4	1.2 ^a
5-7	15.8	10.7	31.2	31.9	31.9	33.0	32.9	33.7	9.8	1.1 ^a
6-8	17.2	13.3	31.0	31.6	31.8	32.6	32.8	32.9	8.8	1.3 ^a
7-9	18.7	14.3	30.9	31.6	31.7	32.4	32.7	32.8	7.3	1.4 ^a
8-10	14.7	14.8	30.6	31.5	31.4	32.3	32.5	32.7	5.6	1.4 ^a
9-11	8.2	15.5	29.8	31.5	30.8	32.3	32.2	32.6	4.5	1.2 ^a
10-12	5.2	17.0	28.8	31.4	29.8	32.3	31.7	32.5	4.2	0.9 ^a
11-13	7.9	17.5	28.2	31.3	29.3	32.2	31.3	32.4	4.0	0.8 ^a
12-14	19.5	16.2	28.7	30.5	29.6	32.0	31.2	32.3	3.9	0.6 ^a
13-15	23.3	15.5	29.5	30.3	30.3	31.8	31.3	32.2	3.5	0.6 ^a
14-16	21.5	15.8	29.3	29.7	30.2	31.6	31.3	32.0	3.4	0.5 ^a
15-17	20.2	21.5	29.2	30.1	29.9	31.6	31.1	32.0	3.3	0.4 ^a
16-18	20.3	21.7	28.7	30.7	29.6	31.7	31.0	32.0	3.0	0.3 ^a
17-19	22.2	26.8	28.2	31.4	29.1	31.8	30.6	32.0	2.8	0.5 ^a
18-20	20.7	23.0	27.6	31.2	28.7	31.8	30.3	31.9	2.4	1.0
19-21	23.0	23.3	28.2	30.9	29.0	31.6	30.3	31.9	2.2	3.2
20-22	23.0	19.8	29.5	30.6	29.9	31.3	30.9	31.8	2.5	4.5
21-23	22.0	18.2	30.0	30.6	30.3	31.3	31.2	31.7	4.2	4.7
22-24	23.2	16.7	29.9	29.8	30.3	30.8	31.2	31.5	5.5	4.5
23-25	25.0	14.8	29.6	28.7	30.2	30.1	31.2	31.0	5.7	4.5
24-26	23.2	17.5	28.6	27.9	29.6	29.2	30.9	30.4	3.0	4.1
25-27	18.0	23.5	27.9	28.8	28.9	29.5	30.5	30.3	1.5	4.0
26-28	16.3	29.8	27.5	30.2	28.4	30.4	30.1	30.8	0.7	3.8
27-29	15.3	32.3	28.3	31.3	28.8	31.3	30.1	31.4	3.0	3.3
28-30	13.8	34.3	28.4	31.7	28.7	31.6	30.2	31.7	4.7	2.5
29-31	15.0	30.0	28.5	31.8	28.9	31.7	30.3	31.8	5.7	2.4
30-32	21.2	23.8	28.9	31.7	29.3	31.8	30.5	31.9	5.1	3.6
31-33	32.7	15.7	30.0	31.2	30.3	31.6	30.9	31.8	4.2	3.1
32-34	42.2	14.3	31.1	30.3	31.1	31.1	31.4	31.6	2.5	2.9
33-35	49.8	17.7	32.8	29.6	31.5	30.6	31.6	31.4	1.0	2.6
34-36	47.5	21.5	33.8	29.3	32.1	30.2	31.8	31.0	T ^b	2.4
35-37	42.7	27.8	33.7	29.9	32.2	30.5	31.9	31.0	T ^b	1.5
36-38	34.8	34.5	32.5	30.1	32.2	30.0	32.0	30.9	T ^b	1.0

^a Largely glaze and sleet.

^b Trace.

The surveys yielded considerable indirect evidence to the effect that additional snow covering over surprisingly small areas in all probability markedly influenced soil temperatures beneath such tracts. Minor local differences in topography undoubtedly played an important role in such phenomena. It was often noted that a slight depression in a field was usually associated with less mortality than occurred in the higher ground in the immediate vicinity. In one unusual observation it was revealed that the mortality beneath a cow trail in a pasture was decidedly less than that on either side of the depression. Surprising as it may seem, mortality was generally less in cultivated fields than in closely associated pastures. A possible explanation of this phenomenon is that the irregularities of the ground surface as well as the residual vegetation from the previous year's crop reduced snow drifting to a minimum. As the few surveys in cultivated fields generally indicated a much lighter mortality in such situations than in pastures and golf courses, the difficulty of arriving at a correct estimate of the mortality in any area based upon a few widely separated surveys made largely in pastures and golf courses is at once apparent. It follows then that the mortalities shown in Figure 1 probably represent the extremes in the various sections rather than the average mortality.

Paradoxical as it might seem, soil temperatures were higher at Moorestown, N. J. (situated in the area with the covering limited principally to sleet), during the cold period of 1936 than in that of 1934. This is quite evident from an examination of the temperature trends in Table 1. Thus, at the 3-inch level in 1936 the lowest temperature recorded was 26.4° F., a temperature 2.4° above the extreme minimum at that level in 1934, while at the 6-inch level the extreme minimum recorded was 28.4° F. and at the 9-inch level 29.6° F. These relatively high minimum temperatures at the 6- and 9-inch levels are of unusual interest in view of the fact that in many surveys a surprisingly large proportion of the larvæ found at 6 inches or below were dead.

Taking into consideration all the foregoing facts, it seems fairly evident that the mortality experienced in 1936 was occasioned by a complex of factors, which probably involved moisture as well as temperature. Although no soil-temperature records are avail-

able from northern New Jersey for comparison with those taken at Moorestown, it is the opinion of the writers that the ample snow covering in the former region effectively prevented soil temperatures at the upper levels from dropping appreciably below 32.0° F.

That soil moisture may have been an important factor in the mortality of 1936 is suggested by the work of Salt (4). In studying the freezing process in insects he made the interesting observation that in the presence of what he termed "contact moisture" the undercooling process, in some insects, is eliminated or greatly lessened and freezing begins at or slightly below the highest freezing point of the insect tissues. Salt noted a wide range in the degree of susceptibility to inoculations by contact moisture among the various insects studied. In insects susceptible to this phenomenon, it appears that the amount of contact moisture in the form of ice which is necessary to eliminate effectively the undercooling point is a variable quantity, governed, presumably, by the physiological peculiarities of the insect in question. It is not possible at present to state to what extent Japanese beetle larvæ are susceptible to the action of contact moisture, as no fundamental work along this line has been carried on with larvæ of this insect.

Since the areas in which heavy mortalities occurred were largely those associated with a heavy coating of sleet or glaze, it is possible that such coatings, by restricting the ventilation of the soil, may have been a factor in bringing about killing. It is conceivable also that the high pressure exerted by water freezing in the soil may have had an influence on mortality. With the limited knowledge of the influence of such factors on soil-inhabiting insects, it is impossible to attribute killing to any one factor alone.

Larval surveys made later in the spring in the Philadelphia area in general confirmed the marked reduction among hibernating larvæ. Quite a number of partially discolored live larvæ were observed during the earlier surveys. These discolorations probably were associated with physiological changes accompanying the initial stages of freezing. It is possible that a considerable portion of these larvæ were injured to the extent that they

were unable to complete their development, so that, locally at least, the mortality was higher than the early surveys indicated.

In July, when beetles are normally at their peak abundance for the season, it was evident to entomologists working with the insect, and even to the public at large, that the number of Japanese beetles present in the greater portion of the area experiencing winter mortality was decidedly less than in the preceding year. This was more generally noticeable in the Philadelphia area than in some of the other sections in which surveys indicated that high mortality had occurred. At a golf course near West Chester, Pa., 1,050 larvæ out of 1,260 recovered in 50 surveys were dead. However, the residual infestation was high enough to result in rather severe tree injury at some points in that region during the season of beetle flight.

It is interesting to note that in 1937 an example of local winter mortality, under conditions somewhat similar to the one described, was found in New England. During a spell of warm weather in February the snow melted and water collected in a low area, which was covered with a sheet of ice when temperatures again fell below freezing. Dead larvæ were found at this point when surveys were made later in the spring.

It is realized that a mortality such as that experienced in 1936 is unusual and that a complex of weather conditions, such as the one that brought it about, may not occur again for many years. The experience this year indicates, however, that in evaluating the factors governing winter killing consideration should be given to the possible influence of soil moisture and the type of precipitation, as well as to the action of low temperatures.

SUMMARY

Data from larval surveys indicated that prior to 1936 the mortality among hibernating larvæ of the Japanese beetle was negligible in the area then infested. The available information pointed to 15° F. (-9.4° C.) as the lowest temperature which could be withstood by hibernating larvæ under natural conditions. Continuous soil-temperature records at Moorestown, N. J., since 1925 indicate that only occasionally, during periods of severe weather, have temperatures at the 3-inch level fallen

appreciably below 30.0° F. This has been due largely to the insulation afforded by snow cover during such periods.

A heavy mortality among overwintering Japanese beetle larvæ was evident in 1936 after a severe cold period, although soil temperatures at Moorestown, N. J., were not as low as in 1934, a year with no unusual amount of mortality. A critical comparison of meteorological data for 1934 and 1936 indicates that in the latter year, in all probability, mortality was occasioned by a complex of factors, which probably involved moisture as well as low temperature.

LITERATURE CITED

1. FOX, HENRY. 1935. Some misconceptions regarding the effects of the cold of February 1934 on the larvæ of the Japanese beetle, *Popillia japonica* Newman. Jour. Econ. Ent. 28: 154-159.
2. ———. 1937. Seasonal trends in the relative abundance of Japanese beetle populations in the soil during the annual life cycle. Jour. N. Y. Ent. Soc. 45: 115-126.
3. ———. 1939. The probable future distribution of the Japanese beetle in North America. Jour. N. Y. Ent. Soc. 47: 105-123.
4. SALT, R. W. 1936. Studies on the freezing process in insects. Minn. Agr. Exp. Sta. Tech. Bul. 116, 41 pp.

ON A COLLECTION OF MILLIPEDES FROM TEXAS AND NEW MEXICO

BY RALPH V. CHAMBERLIN AND STANLEY MULAİK
UNIVERSITY OF UTAH

This article is a report upon a collection of millipeds made by Mr. and Mrs. Stanley Mulaik chiefly in Texas, but it also lists a smaller number of forms taken in Bear Canyon, southeast of Clouderoft, New Mexico. In Texas the major portion of the collecting was done in Hidalgo Co., at Edinburg and in Kerr Co., at Raven Ranch, but adjacent counties also supplied considerable material. The lot includes twenty-one species, distributed in ten families. Of these species nine are regarded as new, and two as representing new genera.

POLYXENIDÆ

Polyxenus fasciculatus Say

Jour. Phil. Acad. Sci., 1821, II, p. 108.

Localities.—Texas: Hidalgo Co., Edinburg, one specimen, December, 1939; Kerr Co., Raven Ranch, one specimen in August and one in December, 1939. The specimens are badly rubbed but seem to conform fully to this species.

FONTARIIDÆ

Nannaria ursa Chamberlin

Proc. Biol. Soc. Wash., 1938, vol. 51, p. 207.

Locality.—New Mexico: Bear Canyon, Camp Mary White. Male and female, Aug., 1934.

Aporiaria texicolens Chamberlin

Proc. Biol. Soc. Wash., 1938, vol. 51, p. 207.

Locality.—Texas: Edinburg, May, 1937; Feb., December, 1939, etc. Many specimens.

***Aporiaria anamesa* Chamberlin and Mulaik, new species**

In general appearance resembling *A. texicolens* but a much smaller and darker, more blackish form with less strongly depressed keels.

Dorsum dull brown to nearly black with a narrow yellow band across caudal borders of tergite and along lateral borders of keels. Antennæ, venter and sides, except for a dark area just below keels, yellow. Legs with two or three distal joints yellow, the others dark, especially those over middle of length. Head yellow, with a network of darker lines above and in front.

Body rather slender, the sides parallel except toward ends. Keels moderately narrow, somewhat less depressed than in *toxicolens*; caudal angles slightly produced on fourth and fifth keels, becoming more strongly so on posterior segments, the processes of the nineteenth keels widely rounded.

Length, about 30 mm.; width, 4 mm.

Locality.—New Mexico, Camp Mary White. Three females taken in August, 1934.

CYCLODESMIDÆ

Genus **ETHOCYCLUS** Chamberlin and Mulaik, new

Resembling *Cyclodesmus* in general body form. Surface nearly smooth, shining, but bearing well separated, seriated setæ. Keels flaring outward a little from bases.

Third segment with keels narrowly margined both in front and behind, not ridged.

Fourth segment with keels rounded at lower end, presenting no corners.

Keels not notched above caudodistal angle as they are in *Cyclodesmus*, but smoothly continuous to base where weakly incurved at junction with dorsum.

Genotype.—*E. atophus*, sp. nov.

Ethocyclus atophus Chamberlin and Mulaik, new species

General color pale brown, the legs whitish.

Vertex of head with a few erect setæ, crossed by a fine median longitudinal sulcus.

First tergite with anterior margin weakly convex, the posterior essentially straight, and the lateral margins converging caudad as in species of *Cyclodesmus*; margins raised; corners well rounded; apparently a transverse series of six setæ back of anterior border, and also a submarginal seta at middle of each end and four across caudal border. (The setæ rubbed off in type but small basal tubercles seem to indicate their position.)

Second tergite with keels bent forward to level of anterior margin of first tergite, their distal ends rounded; all margins raised.

Third tergite with keels of relative size and general form found in *Cyclodesmus*, narrowly margined, surface smooth.

Fourth keels with lower end narrowly rounded, decidedly less acute than those of fifth tergite.

On typical segments the posterior portion of tergite elevated above level of anterior portion and divided into low tubercular swellings which appear to have born setæ forming a transverse series.

Width of maximum specimen, the holotype, 1.8 mm.

Locality.—Texas: Kerr Co., two specimens taken in August, 1939, and one, the holotype, in December, 1939.

This record is the first for the *Cyclodesmidæ* in this country, other species being known only from Mexico and the West Indies.

LEPTODESMIDÆ

Eurymerodesmus melacis Chamberlin and Mulaik, new species

Characterized in color by having the lateral borders of the keels and the posterior border of tergites brick red, this brick red posterior area extending broadly forward in middle region and anteriorly divided by the extension backward of a tongue from the blackish area covering the dorsum outside the red portions. Collum black bordered all around with brick red. Head black above, a median pale area in front, and also pale below and on sides. Antennæ pale except for most of last article and the distal half of penult article which are black. Venter, sides and legs yellow.

Head smooth. A distinct median sulcus over vertex and ending between antennæ. A seta each side of middle in frontal region. A transverse series of about 16 setæ above the labial margin. Antennæ filiform; the seventh article subconical, truncate at apex.

Collum with keels narrowed downward as usual, their anterior margin a little incurved and the posterior convex; middle part of anterior margin widely convex, the posterior straight except at ends where convex and continuing outline of the keels.

In the keels of anterior portion of body both anterior and posterior corners rounded, the posterior becoming more rectangular in going caudad, and from about the twelfth on produced in increasing degree, those of last five segments more distinctly and acutely extended.

Last tergite narrowed caudad, the sides incurved and the apex narrowly truncate; bearing above several pairs of long setæ. Anal valves with mesal borders elevated as usual. Anal scale broadly subtriangular with sides convex and caudal angle very obtuse.

Telopodite of male gonopods in general form very much resembling that of *E. mundus* of Oklahoma but the distal series of long setæ on vertical portion much closer to the bend. It differs clearly from *mundus* in lacking the characteristic columnar sternal process behind the gonopods.

Length of female, about 23 mm.; width, 3.5 mm. Width of male, 3 mm.

Localities.—Texas: Kerr Co., Raven Ranch, many of both sexes taken in August and December, 1939; Boerne; Edinburg, many in December; Kendall Co., numerous; Bandera Co.; Concho Co., 10 miles west of Eden; all taken in December, 1939, except for some taken in August at the Raven Ranch.

Related to *E. mundus* Chamberlin of Oklahoma but a clearly

smaller form differing in the male in lacking the columnar sternal processes behind the gonopods, etc.

CRASPEDOSOMIDÆ

Genus **RHABDARONA** Chamberlin and Mulaik, new

Body composed of 30 segments with carinæ and tubercles obsolete. Ocelli numerous and well developed. Antennæ long and filiform, with the third joint longest and the fifth next longest; sixth and seventh joints about equal in length, the seventh slenderly subfusiform, the sixth abruptly thicker, clavate. First joint of ninth legs of male with a conspicuous chitinous process from mesal side extending ventrad between anterior gonopods, and at side of a median chitinous, laminate process; the joint beyond this process cylindrical, a little thicker than the slender and cylindrical second joint; third joint very short, narrower than second in end of which it is more or less telescoped, the fourth joint also very short and narrow; a narrow terminal process. First joint of tenth legs also with a long process from inner side, similar processes on eleventh and twelfth legs shorter.

Genotype.—*R. bacillipus*, sp. nov.

Rhabdaron a bacillipus Chamberlin and Mulaik, new species

General color brown, with a series of yellow spots along sides below which the color becomes lighter from a mottling of yellow. Legs proximally pale, becoming brown distally.

Ocelli black, convex, in a large triangular patch, the arrangement from above appearing to be 7, 6, 5, 4, 3, 2.

First two legs of male more slender than those that follow. Ninth legs of male with the process of first joint and process of tenth legs characteristic. Processes of twelfth legs reduced, subconical.

Gonopods bent strongly caudad, relatively large, of form shown in the figure.

Length, about 14 mm.

Locality.—Texas: Kerr Co., Raven Ranch. One male taken on 15 July, 1939, by D. and S. Mulaik.

LYSIOPETALIDÆ

Spirostrephon texensis Loomis

Localities.—Texas: Kerr Co., Raven Ranch, and 17 miles south of Kerrville; McCulloch Co., south of Brady; Bandera Co., 7 miles south of Medina; and Kendall Co. Many specimens taken in December, and some at Raven Ranch in July and August, 1939.

This species was previously known from Dallas, Smith, Tarrant and Wharton Counties, the last named being the type locality.

PARAIULIDÆ

Aniulus adelphus Chamberlin

Localities.—Texas: Kendall Co., a number of males and females, December, 1939; 11 miles southwest of Boerne, several specimens; Kendall Co., many specimens.

Aniulus craterus Chamberlin

Locality.—Texas: Kerr Co., Raven Ranch, many specimens taken in December, 1939.

Aniulus dorophor Chamberlin

Locality.—Texas: Many specimens taken in December, 1939.

Aniulus prosoicus Chamberlin

Locality.—Texas: Hidalgo Co., Edinburg. Three adult males and three adult females taken in 1938, and many, mostly immature, specimens taken in December, 1939.

Gosiulus conformatus Chamberlin

Localities.—Texas: Live Oak Co., south of Three Rivers, one male taken in December, 1939; Big Springs, many males and females; McCulloch Co., south of Brady, several; Brooks Co., 17 miles north of Alice, several.

Hakiulus amophor Chamberlin

Localities.—Texas: Kerr Co., Turtle Creek, several mature males and females taken in December, 1939; Live Oak Co., south of Three Rivers, many specimens.

Ziniulus medicolens Chamberlin

Localities.—Texas: Kerr Co., Raven Ranch. Many specimens taken in December, 1939; 11 miles southwest of Boerne.

ATOPETHOLIDÆ

Eurelus kerrensis Chamberlin and Mulaik, new species

Apparently resembling *E. soleatus* Cook, the genotype, in general color and appearance but a smaller form, 6 mm. in diameter as against 8 mm.; and composed of a larger number of segments, 53, or in one female 51, as against

47 or 48. Judging from the published description of the male gonopods of *soleatus*, the present species is distinct in details of these organs.

The general color is from dark brown to nearly black, in preserved specimens at least showing a narrow light band or line along caudal margin of the segments; prozonites somewhat lighter than the metazonites.

Metazonites subdensely finely punctate and marked with some fine impressed lines, the prozonites smoother.

Clypeal foveolæ normally 5 + 5.

Ocelli, *e.g.*, 6, 6, 7, 6, 5, 3, the rows as given subvertical and recorded from behind forward; the ocelli decrease in size from below upward. Thus there are 33 ocelli in six rows as against 43 or 44 in seven series in *soleatus*. Lower angle of collum narrow but rounded at apex, the posterior edge obtusely indented near point where anterior sulcus meets it. The anterior margining sulcus deeply impressed up nearly to level of middle of eye patch. Three short longitudinal sulci over caudal border just above lower margin.

The claws of the first three pairs of legs enlarged as in *soleatus*, those of the next four pairs abruptly smaller and of the same size as those on legs of the post-genital segments, not smaller as given for *soleatus*.

The coxal process of the third legs laminate and directed caudad as in *soleatus* and *proximus* but much shorter, extending only over the processes of the following segment. Processes from coxæ of fifth, sixth and seventh legs laminate but short, blunt and erect.

Locality.—Texas: Kerr Co., Raven Ranch. One adult male, holotype, and two adult females, together with partly grown individuals taken in July, 1939, by D. and S. Mulaik.

***Eurelus proximus* Chamberlin and Mulaik, new species**

A species undoubtedly close to *E. soleatus*, the genotype, but somewhat smaller, the diameter of the male being 7 mm. as against 8 mm., and the body has 45 segments as against 48, apparently the normal and nearly constant number in *soleatus*.

In the present species the claws of the three anterior pairs of legs are but slightly larger than those of post-genital region, while those of the four pairs following are greatly reduced and almost abortive. The processes of the third coxæ are as described for *soleatus* but the coxal processes of the sixth legs are erect and not covered by the processes of the third legs, the processes of the seventh also erect, much thicker and larger, and distally rounded.

Above the lower angle of the collum only two striæ and these incomplete. The raised ventral flange of the second segment prominent.

The gonopods of the male close in general form to those of *soleatus* as nearly as can be told from the description, but the posterior gonopod conspicuously exposed in anterior view.

Ocelli in eight series, thus, proceeding from above, 2, 5, 6, 8, 8, 8, 7, 7. Clypeal foveolæ 5 + 5.

The general color is dark, almost black, excepting for the narrow pale ring about caudal border of each segment. Legs also blackish. The first segment and the middle part of the last segment not paler as they are said always to be in *soleatus*.

Locality.—Texas: Hidalgo Co., Edinburg. One male taken in the spring of 1938.

SPIROSTREPTIDÆ

Orthoporus texicolens Chamberlin

Proc. Biol. Soc. Wash., 1938, vol. 51, p. 207.

Locality.—Texas: Edinburg. One male taken in March, 1936, and two females in the spring of 1938. The larger female has a maximum diameter of about 9 mm.

Orthoporus entomacis Chamberlin and Mulaik, new species

General color chestnut brown, the metazonites with caudal border darkest, and the prozonites lighter than the metazonites. Legs brown.

Collum with three sharply impressed striæ above and caudad of the lower and anterior margining sulcus extending from level of middle of eye ventrad and caudad to posterior margin; the uppermost stria curving evenly ventro-caudad, the two others angular below where turning from subvertical position to the horizontal.

Repugnatorial pores beginning on sixth segment; each pore located behind sulcus at one-fourth or less the distance from sulcus to posterior margin; sulcus smooth, sharply impressed, widely curved opposite the pore.

Segments nearly smooth above; distinct striæ beginning a little below level of pore and deeply impressed below.

Last tergite much exceeded by the valves which are compressed and elevated as usual. Anal scale relatively very broad, the posterior margin very obtusely angular with angle widely rounded.

The gonopods of the male are of the type of *O. punctilliger* and *O. texicolens* but the spine of the anterior gonopod extending directly ectad and presenting a characteristic notch at its apex.

Number of segments in male holotype and female allotype, 70.

Diameter of male holotype, 7 mm.; of female allotype, 5 mm.

Locality.—Arizona: Duncan. Male (holotype) and female taken September 7, 1939, by Dorothea and Stanley Mulaik.

Orthoporus flavior Chamberlin and Mulaik, new species

At once distinguishable from other known species of the Southwest in its bright coloration. Prozonites and anterior border of metazonites with nar-

row caudal borders of the latter yellow, narrower annulus of brown over posterior and major portion of metazonites in front of the narrow caudal annulus. Anal valves and tergite light yellow. Collum yellowish, bordered within a broader band of brown by a narrower marginal stripe of yellow. Head light brown. Legs and antennæ brown.

Eyes with ocelli arranged in five or six oblique and curved series, *e.g.*, 8, 8, 6, 4, 1.

Collum narrowed below as usual with both corners rounded and the inferior margin weakly concave; narrowly margined below and up anterior side to level of eye; two long, oblique sulci curving from caudal margin up to level of eye, with a very short one between the posterior ends of these two.

Segmental sutures smooth, light, only very slightly curved opposite the pore which is situated at about one-third the distance from suture to caudal margin. Metazonites striate beneath but not on sides toward pores.

Last tergite with caudal portion broadly subtriangular, the caudal angle obtusely rounded, set off by a deep transverse sulcus, the middle somewhat darker region conspicuously compressed and elevated. Anal scale with caudal margin over middle region weakly convex, truncate or weakly concave at middle.

Number of segments, 66.

Diameter, 4.2 mm.

Locality.—Texas: 4 miles east of Dryden. 4 Sept., 1939. One not fully mature male.

SIPHONOPHORIDÆ

Siphonophora texascolens Chamberlin and Mulaik, new species

After preservation in alcohol, the general color is fulvous to light brown, commonly showing a whitish band or a series of white spots along each side, the head and several anterior segments also sometimes whitish, as may also be some of the posterior segments.

Head and antennæ and the collum as in *pseustes* or nearly so.

Separated primarily on the basis of the form of the gonopods which are typically erect, not geniculate at base, with the posterior pair extending well beyond tips of the anterior pair.

Number of segments in male holotype, 96; of other adults, from 90 to 101.

Length, up to about 23 mm.

Localities.—Texas: Kerr Co., Raven Ranch; nine specimens taken in August and three in December, 1939; Bandera Co., fifteen specimens taken in December, 1939; Kendall Co., four specimens, December.

FURTHER STUDIES OF CONDITIONS INFLUENCING THE SURVIVAL OF JAPANESE BEETLES THROUGH METAMORPHOSIS

BY DANIEL LUDWIG AND HENRY FOX

DEPARTMENT OF BIOLOGY, UNIVERSITY COLLEGE, NEW YORK UNIVERSITY

INTRODUCTION

In a previous publication, Ludwig and Fox (1938) suggested that wheat grains are beneficial to Japanese beetle larvæ in early developmental stages, but are toxic if allowed to remain in the medium until the approach of metamorphosis. It was shown, however, that with soil as a component of the medium, this toxic effect of the wheat is partially counteracted. Thus, when wheat was present throughout larval life in a medium composed exclusively of *Andropogon* mold, only 33.4 per cent of the larvæ which had survived 70 days of the third instar pupated, whereas, when soil was present with the *Andropogon*, 54.5 per cent pupated. No data were obtained from these studies to show the effect of soil in counteracting the toxic action of wheat in media other than *Andropogon* mold, and even in the latter, the only results considered were those obtained at a single temperature, namely 25° C.

The present paper reports the results of three later series of experiments; the first two, on larvæ reared at 25° C., in a medium composed either exclusively or in part of *Carex* mold; the third, on others kept at 27.5° C., in a mixture of soil and *Andropogon* mold. In the former series, where *Carex* mold formed the basic material of the medium, the conditions under which the various tests were carried out are indicated in Tables I and II. In these experiments, *Carex* mold was selected because earlier unreported experiments had shown that Japanese beetles cannot be reared to the pupal stage in this medium unless other sources of food are present, such as wheat grains or a suspension of yeast. Hence, the use of *Carex* mold makes it possible to determine (1) the length of time during which the larvæ require this extra food to enable them to reach the pupal stage, (2) the precise period during larval life when the use of additional food produces optimal

effects, (3) the effects of the presence or absence of soil in the medium, and (4) the results on survival of retaining or removing the products of food decomposition.

In the third series, where larvæ were reared at 27.5° C., in a mixture of soil and *Andropogon* mold, the object was (1) to compare the survival of larvæ fed wheat during a limited portion of larval life with that of others given this additional food throughout, and (2) to test the effect of the replacement of wheat by yeast during all or a part of the same period. Earlier attempts to rear Japanese beetle larvæ from hatching to pupation at this temperature had yielded very unsatisfactory results, only a very small proportion reaching the pupal stage. In these instances, the larvæ had been kept in *Andropogon* mold without any admixture of soil and had been fed wheat grains throughout larval life. In view of the results previously reported (Ludwig and Fox, 1938), it was thought that modification of the procedure as outlined might result in an improved survival at the higher temperature.

MATERIAL AND METHODS

The procedure used in these experiments is essentially the same as that reported by Ludwig and Fox (1938). The larvæ were hatched from eggs obtained from beetles collected in the field or reared in the laboratory. On hatching, each larva was placed in a 1-ounce metal salve box containing the selected medium. Wheat grains or yeast were added for different periods of time during larval development as indicated in Tables I, II, and III. The yeast consisted of a suspension of one-half cake of baker's yeast in approximately 100 cc., of tap water. This suspension was used both to moisten the medium and to supply the larva with food. In other cases, the basic medium was kept moderately moist by the addition of tap water. The soil was obtained just beneath the sod on the New York University campus and contained a trace of organic material, but not enough to darken it perceptibly. The plant molds used were collected beneath tussocks of *Carex stricta* and *Andropogon glomeratus*. The salve boxes and the basic media were always sterilized before use by heating in a hot air sterilizer for approximately two hours at 150–200° C. Throughout the experiments, the larvæ were kept

in incubators at the desired temperatures. On the approach of molting they were examined daily and at other times twice weekly.

OBSERVATIONS

A. *Tests with larvæ in Carex mold at 25° C.* The first series of tests, the results of which are summarized in Table I, was made with six lots of larvæ, all kept in *Carex* mold but with wheat added during a period of five consecutive days. The precise time at which this occurred varied progressively in the different lots as shown in the table. The object of this procedure was to deter-

TABLE I

EFFECTS OF WHEAT, PRESENT FOR DIFFERENT PERIODS OF FIVE DAYS EACH, ON THE SURVIVAL OF JAPANESE BEETLE LARVÆ KEPT IN *Carex* MOLD AT 25° C.

Food	No. of larvæ	First-instar larvæ		Second-instar larvæ		No. of larvæ metamorphosing
		Per cent completing instar	Average duration in days	Per cent completing instar	Average duration in days	
Carex + wheat first 5 days after hatching, then Carex only	50	84.0	18.8 ± 0.50	16.7	43.1	2
Carex only first 5 days, then Carex + wheat 5 days, then Carex only	50	80.0	20.3 ± 0.66	37.5	43.6 ± 2.13	2
Carex only first 10 days, then Carex + wheat 5 days, then Carex only	50	54.0	22.2 ± 0.57	51.9	39.9 ± 2.05	3
Carex only first 15 days, then Carex + wheat 5 days, then Carex only	50	58.0	24.3 ± 0.42	51.7	40.3 ± 3.43	4
Carex only first 20 days, then Carex + wheat 5 days, then Carex only	25	72.0	27.4 ± 0.36	77.8	32.1 ± 1.70	2
Carex only throughout first instar, then Carex + wheat first five days of second instar, then Carex only	25	56.0	27.0 ± 0.65	78.6	23.3 ± 1.32	4

mine the effect of the addition of wheat at different times upon (1) the degree of survival, and (2) the duration of each of the first two instars. Since earlier tests had repeatedly shown that larvæ rarely live through the second instar if *Carex* mold is the sole source of food, it was considered unnecessary in the present series to include any special experiments in which the larvæ were deprived of wheat at all times.

Effect on survival. Comparison of the results given in Table I indicates that neither the temporary presence or the total absence of wheat during the first instar; or the precise time at which it is available, makes any obvious difference in the proportion of larvæ completing the instar. The last lot listed, which consisted of larvæ subsisting exclusively upon *Carex* throughout the entire stadium, shows a survival as high as 56 per cent, which is essentially equal to that obtained in two other lots, one of which was given wheat from 10 to 15, the other from 15 to 20 days after hatching. The highest survival for the first instar characterized the first two lots, which were supplied with wheat within the first ten days after hatching, but the significance of these results is rendered rather questionable by the high survival obtained in the experiment where wheat was not added until 20 days after hatching.

For the second instar, the results given in Table I are more definitely suggestive. In general, they favor the view that survival through this instar is conditioned by the time elapsing since the larvæ had last eaten wheat. Where this interval was longest, as in the first lot of larvæ listed in the table, which had not eaten wheat since the fifth day after hatching, survival was lowest (16.7 per cent); while at the other extreme, where wheat was present early in the second instar or immediately preceding it, maximum survival was shown (77.8 per cent).

Effect on metamorphosis. From the data given in Table I, it is evident that only a very small number of the larvæ of each lot passed through metamorphosis. This result is not surprising when it is considered that, with the exception of five consecutive days, the larvæ throughout their lives were forced to subsist exclusively upon *Carex* mold, a highly deficient form of food. The number of survivors in the different lots is obviously too small to

warrant the drawing of any conclusions regarding the effects of variations in treatment upon survival of fully grown larvæ. Apparently, if such larvæ are able to subsist upon *Carex* mold for all except a very brief period, the precise time at which they are given wheat makes no difference in their ability to pass through the last larval instar and to undergo metamorphosis.

Effect upon the duration of the larval instars. It was earlier shown (Ludwig and Fox, 1938) that the presence of wheat in *Carex* mold accelerates larval growth and development. The results here reported show that in the first instar this acceleration is greater the earlier the wheat is given and that, in general, it decreases steadily the longer the wheat is withheld. It is perhaps noteworthy that the duration of the first instar in the case of larvæ given wheat during the first five days after hatching (18.8 days) is almost identical with that previously recorded for larvæ in *Carex* mold given wheat throughout the instar (18.1 days). However, at the opposite extreme, the length of the instar in larvæ deprived of wheat is in the present instance given as 27.0 days, whereas that previously reported was 34.2 days.

The time required for the development of the second instar larva in *Carex* mold, as shown in Table I, is clearly shortened when wheat is present early in the instar and to a less extent if available at the close of the preceding instar. In the former case, it averages 23.3 days; in the latter, 32.1 days. Both averages are considerably higher than that (16.8 days) previously recorded (*op. cit.*, Table I) for larvæ supplied wheat in *Carex* mold throughout the larval period. When wheat is added earlier than the close of the first instar, the precise time at which it is present appears to have little, if any, effect upon the length of the second instar, the average time required for the development of this stage in such cases ranging from 39.9 to 43.6 days. However, that the presence of wheat under these circumstances had some accelerative effect upon development is indicated by the fact that in larvæ wholly deprived of wheat and reared solely upon *Carex* mold, the average length of the second instar, as previously recorded (*op. cit.*, Table I), was 66.8 days.

The second series of tests was devised primarily to determine the toxic effects of wheat on metamorphosing larvæ (Ludwig and

Fox, 1938) as affected by (1) the length of the period during which third-instar larvæ were supplied with wheat, (2) the presence or absence of soil, (3) the regular removal of all old wheat and its decomposition products, and (4) the alternation of equal periods of presence of wheat with its absence.

Since previous work had shown that metamorphosis is rarely indicated before 70 days after larvæ had entered the third instar and had further shown that mortality up to this time is normally slight, the results on survival through metamorphosis are computed on the basis of the number of larvæ alive after 70 days in the third instar.

Effect of variations in the duration of the period of wheat supply upon survival through metamorphosis. The results under this head are summarized in Table II opposite the first seven lots listed. The highest survivals (32.0–37.3 per cent) occurred in larvæ deprived of wheat for periods of time extending from 10 to 30 days after the molt to the third instar until the end of this stage. It was slightly reduced in a lot (No. 5) where wheat was retained for 50 days of the third instar, and very decidedly reduced in one (No. 1) where no wheat was given after the larvæ had molted to this stage. The greatest mortality, however, occurred in two lots (Nos. 6 and 7) where wheat was retained 70 or more days of the third instar. These results are quite in accord with those previously reported (Ludwig and Fox, 1938) which indicated that wheat either contains or gives rise to some material which is toxic to the larvæ on the approach of metamorphosis.

The limited survival (14.2 per cent) through metamorphosis of individuals given no wheat after the molt to the third instar (lot No. 1) was doubtless due not to any toxic action of the wheat, but to deficient nutrition, most larvæ presumably failing to obtain from the *Carex* mold a sufficient store of reserve food to carry them through metamorphosis.

Effect of the presence or absence of soil upon survival through metamorphosis. Comparison of the results recorded in Table II for lots 7 and 8 shows that when soil is mixed with the *Carex* mold survival through metamorphosis is greatly increased, the proportion (50.8 per cent) pupating even exceeding that in cases

TABLE II

TOXIC EFFECT OF WHEAT, FED FOR DIFFERENT PERIODS OF TIME DURING LARVAL LIFE, ON THE METAMORPHOSIS OF JAPANESE BEETLES

Food	No. surviving 70 days of 3rd instar	No. pupating	Per cent pupating
All larvæ fed Carex throughout life cycle + wheat and soil as indicated.			
1. Wheat until end of 2nd instar	48	7	14.2
2. Wheat removed 10 days after molt to 3rd instar	47	15	32.0
3. Wheat removed 20 days after molt to 3rd instar	59	22	37.3
4. Wheat removed 30 days after molt to 3rd instar	58	19	32.7
5. Wheat removed 50 days after molt to 3rd instar	43	11	25.6
6. Wheat removed 70 days after molt to 3rd instar	37	1	2.7
7. Wheat present throughout life cycle	54	2	3.7
8. Wheat and soil present throughout life cycle	87	44	50.8
9. Wheat throughout life cycle but all old wheat removed before new wheat was added	49	22	44.9
10. Wheat present for five day periods alternating with five day periods without wheat	51	19	36.9

where wheat was removed long before the approach of metamorphosis. The presence of soil in the medium thus serves to counteract in large measure the toxic effects of wheat upon metamorphosing larvæ, as noted in an earlier paper (*op. cit.*, p. 452).

Effect of removal of old and disintegrated wheat upon survival through metamorphosis. Acting upon the possibility that the toxic action of wheat upon metamorphosing larvæ might result from their previously feeding upon the products of decay of the grain, the procedure was adopted in one lot (No. 9) of larvæ of removing from the medium all visible fragments of old wheat whenever fresh wheat was added. This change was made at intervals of approximately five days. Comparison of the results

obtained in this lot with those in another comparable lot (No. 7) where the old wheat was retained, shows in the former a greatly improved survival (44.9 per cent), suggesting that the toxic effects of wheat on metamorphosing larvæ arise from the accumulation in the medium of the decomposition products of the wheat.

Effect of alternating periods of presence and absence of wheat upon survival through metamorphosis. In lot No. 10 of Table II, the larvæ were supplied with wheat until metamorphosis during periods, each of five consecutive days, alternating with periods of equal length without wheat. In all cases when the change was made, all visible remains of the old wheat were removed. The result was a survival of 36.9 per cent as compared with 44.9 per cent obtained in lot No. 9 where old wheat was removed each time new wheat was added, and of 3.7 per cent in lot No. 7 where wheat was given throughout larval life. The procedure adopted in lot 10 probably effected the removal of much of the decomposition products of the wheat, which presumably form the chief agent responsible for the apparent toxicity of wheat on metamorphosing individuals.

B. Experiments with Andropogon mold and soil at 27.5° C. Earlier experiments had indicated that exposure to this temperature was in itself highly detrimental to larvæ immediately preceding metamorphosis. In the present series, as shown in Table III, when Japanese beetle larvæ were kept at 27.5° C., in a mix-

TABLE III

THE TOXIC EFFECTS OF WHEAT ON THE METAMORPHOSIS OF JAPANESE BEETLE LARVÆ REARED AT 27.5° C.

Food	No. surviving 70 days of 3rd instar	No. pupating	Per cent pupating
Andropogon mold + soil + wheat throughout larval life	36	0	0.0
Andropogon mold + soil + wheat to 30 days of 3rd instar, then wheat removed	38	9	23.7
Andropogon mold + soil + yeast	45	16	35.6
Andropogon mold + soil + wheat to 30 days of 3rd instar, then wheat replaced by yeast	44	1	2.3

ture of *Andropogon* mold and soil and supplied with wheat grains throughout the larval period, none survived through metamorphosis.¹ However, when wheat was present throughout the first two instars, but during only the first 30 days of the third, 23.7 per cent of the larvæ surviving 70 days of the latter instar pupated successfully. The replacement of wheat by yeast throughout larval life resulted in the highest survival, 35.6 per cent of the 70-day-old third-instar larvæ forming pupæ in this instance. Thus at 27.5° C., the use of wheat to a late period in larval development is indicated as definitely toxic to metamorphosing individuals, while the use of yeast under like circumstances appears to be less detrimental. However, when the larvæ were started on a diet of *Andropogon* mold, soil and wheat, with the replacement of wheat by yeast at the end of 30 days of the third instar, only one individual pupated. This possibly indicates that a medium cumulatively rich in organic content is likely to be detrimental to metamorphosing larvæ at a temperature as high as 27.5° C.

DISCUSSION

Ludwig and Fox (1938) stated that, "The acceleration in developmental rate, and the larger size of larvæ grown in media to which wheat grains or yeast were added, may be considered evidence that Japanese beetles need, or at least are able to use, accessory food substances of the nature of the vitamin B complex." The present experiments with *Carex* mold indicate that the addition of wheat for only five days of early larval life improves the medium to such an extent that from 14 to 56 per cent survived the second instar, and of these, a few individuals completed growth and metamorphosis; whereas, in the earlier experiments, only 12.3 per cent of the larvæ fed *Carex* mold alone survived the second instar and all of these died early in the third

¹ In some earlier experiments, hitherto unreported, where larvæ were kept in *Andropogon* mold, without soil, and given wheat throughout life, a small number survived to the pupal stage. Under these conditions, the senior author in 1927 obtained 4 pupæ from a lot of 32 larvæ which had survived through 70 days of the third instar, while in 1936, the junior author obtained 6 pupæ from a lot of 70 similar larvæ. Since more recent work indicates that the presence of soil favors survival of larvæ feeding on wheat, it seems strange that in the instance cited in the text the results were negative.

instar. If this improvement is due to the addition of vitamins, it is evident that the Japanese beetle larva needs only a limited quantity of these accessory food substances. Furthermore, since wheat grains were given only during early larval life, either the need for vitamins is limited to this period or it must be possible for the larva to store and utilize the supply for at least four months, since complete larval development requires 139.1 days at 25° C. (Ludwig 1928). Sweetman and Palmer (1928) obtained evidence to indicate that insect larvæ may be able to store vitamins of the B complex. They found that the larva of the flour beetle, *Tribolium confusum*, was very sensitive to the presence of vitamin B, as little as 0.5 per cent of a source being sufficient to produce some pupæ. Furthermore, they reported that the vitamin was present in the larvæ in sufficient amount to produce a fair rate of growth in rats to which 0.5 gram of larva was fed daily.

The high mortality recorded for the late larval and early metamorphic stages when individuals were grown in media containing wheat grains substantiates the suggestion made by Ludwig and Fox (1938) that wheat grains are toxic to metamorphosing individuals. The present experiments show, however, that this effect is less marked if decomposing grains are removed from the medium and suggest that the decomposition products may be the actual toxic agent.

It is interesting to note that soil did not show as beneficial an effect on survival with larvæ reared at 27.5° C. that it had with those reared at 25° C. It seems likely that exposure to this higher temperature is itself detrimental to larvæ ready to metamorphose and that consequently they are more sensitive to accumulated organic materials than at the lower temperature. As indicated in the earlier publication, the reactions of the larva to a food combination appear to be definitely conditioned by temperature.

SUMMARY

1. Japanese beetle larvæ were reared at 25° C., in *Carex* mold to which grains of wheat were added for different periods of time during larval development. The addition of wheat for only a five-day period during early larval life improved the medium to

such an extent that a few individuals were able to complete development and metamorphosis; whereas, in *Carex* alone, all larvæ died during the first, second, or early part of the third instar. The maximal beneficial effects of wheat were obtained when it was fed throughout the first two instars, and during 10 to 50 days of the third instar. If continued beyond this time, there was a high mortality amongst larvæ approaching metamorphosis.

2. These toxic effects of wheat are partially counteracted at 25° C., by the presence of soil in the basic medium.

3. It is suggested that these toxic effects are due to the decomposition products of wheat grains since they are not evident when wheat is fed throughout larval life but all old wheat removed each time fresh wheat is added, or when presence of wheat alternates with its absence.

4. Larvæ reared at 27.5° C., in *Andropogon* mold and soil to which wheat grains were added throughout the larval period did not survive pupation. However, when the wheat was removed after the larvæ had passed 30 days of the third instar, 23.7 per cent of those surviving 70 days of this stage metamorphosed. At this temperature, which in itself is apparently detrimental to metamorphosing larvæ, the toxic effects of wheat were not counteracted by the presence of soil. Hence, the reactions of the larvæ to a food combination appear to be conditioned by temperature.

LITERATURE CITED

- LUDWIG, D. 1928. The effect of temperature on the development of an insect (*Popillia japonica* Newman). *Physiol. Zool.*, 1: 358-389.
- LUDWIG, D., AND H. FOX. 1938. Growth and survival of Japanese beetle larvæ reared in different media. *Ann. Ent. Soc. of Amer.*, 31: 445-456.
- SWEETMAN, M. D., AND L. S. PALMER. 1928. Insects as test animals in vitamin research. I. Vitamin requirements of the flour beetle, *Tribolium confusum* Duval. *Jour. Biol. Chem.*, 77: 33-52.

BOOK NOTICE

The Problems of Insect Study. By Paul Knight. Edwards Brothers, Inc., Ann Arbor, Michigan, 1939. Second Edition. $10\frac{3}{4} \times 8\frac{1}{4}$ inches. x + 132 p. 22 pls., 31 Figs. Litho-printed. Stiff paper covers. \$2.50. For sale by Student Supply Store, University of Maryland, College Park, Md.

This book, which deals with the science and problems of entomology and which is the outgrowth of a course along these lines for students, with diverse interests, at the University of Maryland, is a good example of the interesting way in which an introductory course in entomology can be handled. There are six chapters entitled, "The Insect Problem," "Man Surveys the Damage," "Man Counts the Gains," "Man Appraises a Competitor," "Man Classifies the Hexapods," and "Tentative Solutions," but in themselves these titles give few clues to the varied subjects which the author has brought together and to the expert manner in which he has woven them to form patterns which leave definite impressions in the minds of the readers.

Professor Knight's book emphasizes the relationship of entomology with the social activities of man in their various ramifications and although his treatment does not conform to that followed in elementary texts, his departure is justified and has resulted in an interesting and well-written account from angles that are seldom covered in other works. In it one finds a sensible, well-balanced and accurate entomological philosophy that is tied up with many of our present-day activities, and I can think of no more interesting introduction, not only to entomology, but to economic entomology as well. The illustrations add to its merit.—H. B. W.

EXPERIMENTS ON CULTURE MEDIA IN REGARD TO OVIPOSITION AND MASS PRODUCTION OF DROSOPHILA MELANOGASTER

BY GEORGE H. MICKEY, JOHN CARPENTER, R. W. CUMLEY
AND WALTER BURDETTE
THE UNIVERSITY OF TEXAS

INTRODUCTION

In certain genetic studies of *Drosophila melanogaster*, particularly with reference to inversions and lethals, the method known as "egg-counts" has been very useful (Stone & Thomas, 1935). The value of this method is dependent upon the procuring of large numbers of eggs, which will hatch under favorable conditions. Therefore, it is desirable to ascertain the factors influencing oviposition. Certain factors concerning the condition and content of food as related to oviposition are reported herein. The factors studied were: the concentration of agar in the food, concentration of sugar, presence of wheat germ, and the presence of a roughened food surface. The results were measured in terms of the number of eggs laid by a single female during successive twenty-four hour periods. In the last experiment data are presented concerning the number of imagos produced on two foods differing only in that one contained paper toweling and the other contained "cellucotton."

EXPERIMENT 1: SUGAR CONCENTRATION AND EGG-PRODUCTION

Procedure

A particular *carnation* strain of *Drosophila melanogaster* was chosen for the experiment because it was found to be more viable than the wild stock (D. R. Parker, unpublished). After removal from the cultures, virgin females were retained in 3-inch shell vials, containing regular banana food, for two days before mating. One female was then placed with 3 or 4 males in a regular food vial and left for one day, after which both the female and the males were transferred to a vial containing only

TABLE 1
FOOD FORMULÆ USED IN THE VARIOUS EXPERIMENTS

Food constituents	Food number											
	3	6	7	8	9	12	13	14	15	24a	24b	25
Water, cc.	1500.00	625.00	625.00	625.00	1500.00	1000.00	1000.00	1000.00	1000.00	1000.00	1000.00	1000.00
Dried brewer's yeast, gm.	30.00	15.00	15.00	15.00	30.00	100.00	100.00	100.00	100.00	120.00	120.00	30.00
Agar, gm.	59.00	25.00	20.00	20.00	59.00	20.00	20.00	40.00	40.00	30.00	30.00	12.00
Bananas, gm.		454.00	454.00	454.00								
White Karo, cc.	2.00	125.00	125.00	125.00	2.00	1.30	1.30	1.30	1.30	1.30	1.30	200.00
Moldex Sol., cc.	+	1.00	1.00	1.00	+	+	+	+	+	+	+	0.36
Yeast spray		+	+	+								
Wheat germ, cc.					75.00	2.00	2.00	2.00	2.00	2.00	2.00	2.00
K ₂ HPO ₄ , gm.	1.12				1.12							
(NH ₄) ₂ SO ₄ , gm.	7.50				7.50							
MgSO ₄ , gm.	0.15				0.15							
Tartaric acid, gm.	1.50				1.50							
Glucose, gm.	150.00				150.00							
(NH ₄) ₂ C ₄ H ₄ O ₆ , gm.												
Ca ₃ (PO ₄) ₂ , gm.												
Synthetic spray												
Scratched												
Per cent agar on basis of water alone												
Cane sugar, gm.	4.00	3.33	2.66	2.66	4.00	2.00	2.00	4.00	4.00	3.00	3.00	150.00
						200.00	200.00	100.00	200.00	150.00	150.00	

N.B.—In computing percentage of agar, the Karo syrup was considered as water.

a spoon of food. The males remained with the females during the entire egg laying period.

The spoon and the spraying methods were of the types described by Mickey (D. I. S. No. 6, p. 19, April, 1936). The spoons were removed, and the eggs were counted every 24 hours for a period of 4 to 7 days. The flies were provided then with fresh food spoons. The food which was in the spoons, and which retained the eggs, was transferred to vials that contained about 10 cc. of food, so that hatching of the eggs could proceed. The same procedure was used in the first four experiments.

Results

Four foods, varying in sugar and agar content, were tested for their effect upon egg production. Synthetic food No. 12 (2 per cent agar) was of the same composition as synthetic food No. 13, except that No. 12 contained 10 per cent sugar, whereas No. 13 contained 20 per cent. The number of eggs per female per day on food 13 was found to be 26.1, as compared with 18.45 for food No. 12. Hence, with the low agar concentration, the greater concentration of sugar favors the production of a larger number of eggs per female per day.

Likewise, synthetic food No. 14 (4 per cent agar) was of the same composition as synthetic food No. 15, except that No. 14 contained 10 per cent sugar, whereas No. 15 contained 20 per cent. The number of eggs per female per day on food 14 was 13.7 and that on food 15 was 11.4. With the higher agar concentration, then, the lower concentration of sugar favors deposition of a greater number of eggs. These data are shown in Table 2.

More than 12,000 eggs were counted. Hence, the results should indicate roughly the effects of sugar concentration. It appears that sugar concentration is not a single limiting factor in egg production; but rather it is important in that it influences the combination of food constituents as a whole. The optimum amount of sugar may be available to the fly at low concentrations. Any further addition of sugar may produce its effect by adding bulk to the food, or by some other means, rather than by making possible a higher consumption of sugar by the fly.

TABLE 2
SHOWING EFFECT OF SUGAR CONCENTRATION ON THE NUMBER OF EGGS
LAID BY A SINGLE FEMALE PER DAY

Food number	Per cent sugar	No. flies	No. eggs	No. days	Eggs/♀/day
12	10	33	3046	5	18.45
13	20	36	4695	5	26.10
14	10	38	2602	5	13.70
15	20	33	1884	5	11.40

EXPERIMENT 2: AGAR CONCENTRATION AND EGG-PRODUCTION

A series of tests was made to determine the influence that the percentage of agar in the fly food had upon the number of eggs laid. Foods containing 2 per cent, 2.66 per cent, 3.33 per cent, and 4 per cent agar were used. Two foods, prepared with the regular banana formula, were the same, except that No. 6 contained 3.33 per cent agar and No. 7 contained 2.66 per cent agar. Foods No. 12 and No. 14 were synthetic, both containing approximately 10 per cent sugar, but differing in that they contained 2 per cent and 4 per cent agar respectively. The 2 per cent and 4 per cent agar concentrations were tested in another pair of synthetic foods, 13, and 15, which contained 20 per cent of sugar. The results are presented in Table 3.

The data in Table 3 indicate that *Drosophila* lay considerably more eggs on foods of low agar concentration, regardless of the type of food or sugar concentration. For example, with the 10 per cent sugar foods (Nos. 12 and 14) the one containing 2 per cent of agar yielded 4.75 more eggs per ♀ per day than did the one containing 4 per cent of agar. Likewise, the 2 per cent agar concentration in the 20 per cent sugar foods (No. 13 and No. 15) influenced the production of 14.7 more eggs per female per day than were laid on food with 4 per cent agar concentration. Although the eggs obtained on foods No. 6 and No. 7 were relatively few, the variation in regard to agar concentration was in the same direction and similar to that obtained on the other foods. Consequently, 2 per cent agar concentration in the synthetic food is superior to 4 per cent and 2.66 per cent in banana food is better than 3.33 per cent agar in obtaining large egg production.

A possible explanation of this observation may be the relative humidity in the vials produced by the different concentrations of agar. Spencer (D. I. S. No. 8, p. 87-88) has suggested that there is a direct relation of humidity to oviposition.

TABLE 3

SHOWING EFFECT OF AGAR CONCENTRATION ON NUMBER OF EGGS LAID BY A SINGLE FEMALE PER DAY

Food number	Type of food	Per cent sugar	Per cent agar	No. flies	No. eggs	No. days	Eggs/♀/day
7	Regular banana	5% Karo	2.66	31	2491	4	20.1
6	Regular banana	5% Karo	3.33	19	542	4	7.14
12	Synthetic	10% Karo	2.0	33	3046	5	18.45
13	Synthetic	20% Karo	2.0	36	4695	5	26.1
14	Synthetic	10% Karo	4.0	38	2602	5	13.7
15	Synthetic	20% Karo	4.0	33	1884	5	11.4

EXPERIMENT 3: FOODS WITH AND WITHOUT WHEAT GERM

The effect of wheat germ upon oviposition in *Drosophila* was studied using two pairs of foods. The foods used included regular banana food (No. 7 and No. 8) and a synthetic formula (No. 9 and No. 3). The components of each pair were the same except that one contained wheat germ and the other did not. Table 4 shows the results of this study. Approximately 6,000 eggs were laid on the regular banana foods. The number of eggs per day was 20.1 on No. 7 (without wheat germ) and 25.92 on No. 8 (with wheat germ). On the synthetic foods, Nos. 9 and 3, more than 3,000 eggs were laid, and the number of eggs per female per day was 14.61 and 8.7 on the foods containing and lacking wheat germ, respectively. Consequently, one may assume that the addition of wheat germ to the food may be influential in obtaining a higher egg production, although no data have been accumulated to indicate the cause of this influence.

EXPERIMENT 4: EFFECTS OF SCRATCHING THE FOOD SURFACE

A brief test was performed to determine the effect of roughening the food surface upon egg production. Foods 24a and 24b were identical as to composition, differing only in that the

TABLE 4
SHOWING THE EFFECT OF WHEAT GERM ON THE PRODUCTION OF EGGS

Food number	Type of food	Per cent sugar	Per cent agar	Wheat germ + or -	No. flies	No. eggs	No. days	Eggs/♀/day
7	Regular banana	5% Karo	2.66	-	31	2491	4	20.1
8	Regular banana	5% Karo	2.66	+	35	3629	4	25.92
9	Synthetic	10% Karo	4.0	+	39	2279	4	14.61
3	Synthetic	10% Karo	4.0	-	22	765	4	8.7

surface of the former was roughened by scratching with a piece of fine mesh screen wire before spraying. In spite of a relatively small number of eggs the results were so striking that their significance seemed apparent. The number of eggs per female per day on the scratched food was found to be approximately 4 times that on the unscratched. Table 5 shows these results. Hence, scratching of the food surface may be said to aid considerably in causing the flies to lay more eggs.

Spencer suggests (D. I. S. No. 8, p. 88) that "the scraping and roughening of the food surface described by a number of workers supplies tiny humid valleys where the oviposition meets an environment sufficiently moist to induce the reaction." Our data tend to substantiate this view.

EXPERIMENT 5: COMPARISON OF CELLUCOTTON AND
PAPER TOWELING

Procedure

A wild stock of *Drosophila melanogaster* used in this laboratory was selected for these experiments. The parent flies were taken from young, healthy stocks in which copulation had taken place and oviposition was in progress. Ten pairs of flies were placed in each half pint milk bottle which contained the food and base to be tested. Parent flies were discarded after having remained in the bottles for periods ranging from 24 to 144 hours. At the end of each period the flies in two bottles of each type of food were discarded. The productivity of the parent females during the various periods was measured by counting the offspring every twelve hours after emergence began. The count

TABLE 5
SHOWING RESULTS OBTAINED BY SCRATCHING SURFACE OF FOOD

Food number	Type of food	Per cent agar	Per cent sugar	Scratched + or -	No. flies	No. eggs	No. days	Eggs/♀/day
24a	Regular banana food +	3%	15%	+	18	489	7	3.88
24b	Synthetic spray	3%	15%	-	46	393	7	0.92

was continued until all F_1 individuals had emerged. Particular pains were taken not to include any F_2 flies in the counts.

This experiment compares a new commercial product, "cellucotton," to the usual paper toweling as a base for the food. This test involved twenty bottles of the regular banana-Karo-agar food (No. 26) which was prepared according to directions set forth by Parker in D. I. S. No. 6, p. 65. Ten of the bottles contained cellucotton, the other ten contained paper toweling. When cellucotton was used, it was introduced into the bottles before food was poured. These pads of cellucotton, which did not exceed 2.5 grams in weight, were placed in the bottles in such a way that a portion protruded above the food so as to provide a suitable surface for pupation of larvæ. When paper toweling was used, it was punched down into the previously poured and cooled food, a portion of the paper likewise protruding for pupation.

Results

Data comparing the effects of cellucotton and paper toweling on F_1 progeny produced during the different periods are shown in Table No. 6. In all cases the hatch from bottles containing cellucotton was greater than that from bottles containing paper toweling. The *hatch* during the first period, *i.e.*, from flies allowed to remain in the bottles for 24 hours, showed a greater differential in favor of the cellucotton than that during other periods. The ratios exhibited during the latter are fairly consistent and average about one and one-half for cellucotton to one for paper toweling. The total number of progeny in the cellucotton bottles was 6,474 as compared to 4,350 in the paper toweling bottles, giving a ratio of 1.48:1. These data indicate that

cellucotton in the food may favor a production of a larger number of flies than does paper toweling.

TABLE 6
SHOWING THE RELATIVE VALUES OF PAPER TOWELING AND
CELLUCOTTON IN THE FOOD BOTTLE

Hatch from 100 ♀ flies left in bottle	Banana agar food (#26) using cellucotton	Banana agar food (#26) using paper toweling	Ratio
24 hrs.	209	48	4.30 : 1
84 hrs.	862	819	1.05 : 1
96 hrs.	1017	964	1.05 : 1
120 hrs.	2297	1323	1.73 : 1
144 hrs.	2089	1196	1.74 : 1
Total hatch	6474	4350	1.49 : 1

SUMMARY

1. In foods of low (2 per cent) agar content a 20 per cent concentration of sugar (in contrast with 10 per cent sugar concentration) favors production of a larger number of eggs per female per day. Conversely, in foods with a higher percentage of agar (4 per cent), the lower concentration of sugar (10 per cent) favors deposition of a greater number of eggs.

2. *Drosophila* tend to lay more eggs on foods of low agar concentration, possibly because of the relationship of agar content and humidity.

3. The presence of wheat germ in the food formulas tested was influential in bringing about the production of a larger number of eggs than that with foods not containing wheat germ.

4. Scratching of the food surface aids in causing the flies to lay more eggs.

5. The limited data of experiment 5 indicate that cellucotton in the food may favor a production of a larger number of flies than does paper toweling.

BIBLIOGRAPHY

- MICKEY, G. H. 1936. *Drosophila Information Service*, No. 6, p. 19.
 PARKER, D. R. 1936. *Drosophila Information Service*, No. 6, p. 65.
 SPENCER, W. P. 1937. *Drosophila Information Service*, No. 8, p. 87.
 STONE, W., & THOMAS, I. 1935. *Genetica*, XVII, pp. 170-184.

NEW CICADAS FROM NORTH AMERICA WITH NOTES¹

BY WILLIAM T. DAVIS

STATEN ISLAND, N. Y.

A TENDENCY AMONG CICADAS TO VARY IN WING VENATION ACCORDING TO SPECIES

In this JOURNAL for June, 1936, and September, 1938, attention was called to the interesting and predominate localization of variation in wing venation in *Okanagana magnifica* and *Okanagana rimosa*. In *magnifica* the usual variation consisted in a supernumerary vein extending from Cu 1 into the 8th marginal area of the fore wing in seventy-seven of the three hundred and four specimens examined, while twelve of the sixty *Okanagana rimosa* collected by Dr. A. E. Brower in the blueberry barrens at Aurora, Maine, had the first cross veins in the fore wings either forked or double, while the 8th marginal area remained normal.

Lately Dr. Richard Dow sent for examination thirty-one *rimosa* collected in the blueberry barrens, Washington County, Maine, five of which had extra cross veins in the fore wings. An examination of one hundred and thirty-six specimens of the closely related *Okanagana canadensis* in the writer's collection, from Canada, Maine, Michigan, New York and Pennsylvania, resulted in the discovery of but one female with extra cross veins in each of the fore wings, and one male with an extra cross vein in one fore wing (Plate II, Figs. 1 and 3).

In *Fidicina compostela* from Mexico, variation in wing venation may be of a somewhat different character, or differently located, from that observed in *magnifica* and *rimosa*, already mentioned. There may be a development of supernumerary cells between the median areas and the row of marginal areas, as shown in the cicada on the accompanying plate. Mr. Albert E. Maas has sent fifty-nine examples of *compostela* taken in October,

¹I am indebted to Mrs. Muriel Mattocks Cleaves for drawing the text figures, and to Edwin Way Teale, Edward E. Hannigan and Warren Condit for taking photographs.

1939, at Zapotan near Compostela, Nayarit, Mexico. In this lot eleven either have additional areas as illustrated, or the first or second cross veins in the fore wings are doubled. In two hundred and eleven additional specimens examined from the same part of Mexico, only eleven examples show variation in wing venation (Plate II, Fig. 2).

It appears that while the three species mentioned follow somewhat different lines of variation, it is probable that among the different broods of the same species, as in *compostela*, there is also some difference in the tendency to vary.

Two hundred and forty-nine spread specimens of *Fidicina determinata* Walker, collected in July, 1940, at Compostela, Nayarit, Mexico, were lately examined, and found wonderfully free from variation both as to color and wing venation. Slight variation in wing venation in but two individuals was found. The celebrated loud songster, *Quesada gigas* Olivier, found from Texas southward to Argentina, is another species in which the markings are surprisingly alike over its wide range, whereas *Tibicen chloromera* Walker, and *Tibicen lyricen* DeGeer, from small areas in the eastern United States, are subject to considerable variation in maculation and general color.

TIBICEN BIFIDA AND NEW VARIETY

The species was described and figured in the JOURNAL OF THE NEW YORK ENTOMOLOGICAL SOCIETY for March, 1916, as *Cicada bifida*, the type locality being Clear Creek, Colorado. The allotype came from Washington County, Utah, and paratypes from Colorado, Utah, Arizona and Kansas. All the males of this series had the uncus bifid at the extremity as shown in the accompanying illustration drawn from the type. Additional specimens of typical *bifida* have been examined from the above-named states, as well as from New Mexico and Texas. The opercula in *bifida* are longer and more pointed than in *Tibicen inauditus*, which has the opercula rounded at the extremities.

On June 21, 1932, Dr. Elmer D. Ball wrote: "I got tired mounting cicadas and am shipping the rest to you. They came from the Tombstone area, June 14, 1932, part of them from the slopes of the Tombstone Mountains to the west and part of them from

the slopes of the Dragoon Mountains to the east. I found 17 on one yucca but my technique is a little bad and I got only 11 of them. I thought you might be interested in the variation in opercula length and shape."

Thirty-seven of the males sent to me in 1932 by Dr. Ball, together with seventeen *bifida* also collected by him on June 14, 1932, and now in the collection of the U. S. National Museum, have recently been examined. In this considerable series of 54, none has the uncus of the typical bifid form, but instead it is of a more simple shape.

On June 30, 1932, Mr. Douglas K. Duncan of Globe, Arizona, sent 22 males of *bifida* collected June 21, 1932, between the Whetstone and Dragoon Mountains. He reported them: "hard to catch on anything but the yucca where they crawled in between the long grass-like leaves and apparently went to sleep. . . . Also took some on the tips of bear grass, which was mixed in all over with the yucca, by using a net."

While the above mentioned specimens came from about the same part of Cochise County as those collected a few days earlier by Dr. Ball, an examination of the uncus shows six with the extremity bifid and broadened, nine with it not bifid, and seven that may be classed as intermediate.

Dr. Raymond H. Beamer has sent two males of *bifida* collected at Bisbee, June 10, 1933, in which the uncus is nearly simple and not of the bifid form. Also in the Huachuca Mountains specimens having the uncus simple and not broadened at the extremity, have been collected.

The form of *Tibicen bifida* mentioned above in which the uncus is not bifid or broadened at the extremity has so far been found

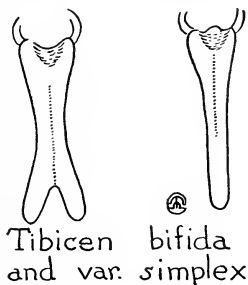

in Cochise County, Arizona, and apparently does not occur over the entire range of the species. For this structural variety as here characterized and illustrated, the following name is proposed: *Tibicen bifida*, variety *simplex*, new variety (Plate II, Fig. 4). Type male, Tombstone area, Arizona, June 14, 1932 (Dr. Elmer D. Ball), Davis collection.

It would appear that in variety *simplex* we have in process of evolution a closely allied species to *bifida*, exemplifying the same sort of relationship and association as now exists in some of the large green and black species of *Tibicen* in the eastern United States. As mentioned by Dr. Ball the opercula vary considerably in length and shape.

Tibicen hidalgoensis, new species (Plate II, Fig. 5).

Type male, Agua Fria, south of Jacala, Hidalgo, Mexico, July 3, 1939 (Ralph Haag), Davis collection.

Resembles in size and general appearance *Tibicen inauditus* described and figured in the *JOUR. N. Y. ENT. SOC.*, December, 1917, and now known from

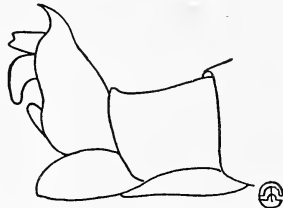

Tibicen hidalgoensis

Texas, Oklahoma and New Mexico. As in that species the rostrum barely reaches the hind coxæ. The uncus though similar is differently shaped, having the upper line suddenly bent and not gradually rounded; the first and second cross veins of the fore wings are rather heavily infuscated, the veins about the basal cell are green and the cell contains a conspicuous black spot somewhat triangular in shape.

Head above black with the following marks dark olive green: a spot on the rather prominent front; a triangular one just behind this; two small ones (one larger than the other) above each antenna, and an irregular one each side of the ocelli at the back of the head. Pronotum dark olive green with the grooves irregularly black; hind margin of the collar greenish, fore margin with an interrupted black band which is continuous or solid in the three paratypes. Mesonotum black with an irregular pale stripe each side containing numerous silvery hairs, especially near the X where they assume the character of a spot. The hind margin is greenish orange including the

ridges of the X. The central portion is occupied by two light spots at the extremities of the X, and anterior to the depressions there are four others, the two central spots being curved on the inner side of the obconical marks and the outer short and irregularly oblong. Tergum black with two small pruinose spots at the base; one large one each side bordering the tympanum, and the eighth segment also conspicuously pruinose. The black abdomen irregularly covered with appressed rufus hairs, and on each side there is a band of appressed silvery hairs with rufus hairs intermixed. The uncus is black. Fore wings with the costal margin pale to the end of the radial cell, beyond darkened; subcostal vein black. The veins about the radial and basal cell are green, and the triangularly shaped black spot, included in the latter, is conspicuous. The anal membranes are gray in the fore wings, and slightly straw colored in the hind wings. Beneath, pale, the front femora darker on the under side, with the head, pronotum and mesonotum pruinose. The rounded opercula touch on the inner edges and are pruinose at the sides. The abdomen is pruinose at the sides, with a pale central area extending from the opercula to and including the pale valve.

MEASUREMENTS IN MILLIMETERS

	Male Type
Length of body	27
Width of head across eyes	9
Expanse of fore wings	72
Greatest width of fore wing	11
Greatest length of operculum	5.5

In addition to the type, 3 paratypes were collected at the same place and time. All four agree, and have the noticeable feature of the short, black spot in the basal cell, which, with the shape of the uncus will separate it from *inauditus*. The allied *Tibicen montezuma* Distant, has the anal membranes of all of the wings orange.

Tibicen sugdeni, new species (Plate III, Fig. 1).

Type male, Montemorelos, Nuevo Leon, Mexico, August 11, 1940 (Dr. John W. Sugden), Davis collection, and allotype female, Monterey, Nuevo

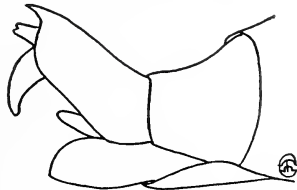

Tibicen sugdeni

Leon, Mexico, August 1, 1940, Dr. John W. Sugden collection.

Resembles in size and general appearance *Tibicen inauditus* and *Tibicen hidalgoensis* but differs in the shape of the more slender uncus; in having the rostrum longer, and more than reaching the posterior coxæ; in being more orange in color, and in having each abdominal segment in all of the males examined, edged posteriorly with orange instead of being all black. The first and second cross veins of the fore wings are rather heavily infuscated; the veins about the basal cell are yellowish green and the oblong black spot contained therein is not as triangular in shape as in *hidalgoensis*.

Head above orange with a black band connecting the eyes and the area about the ocelli black. Front with converging black lines, leaving an orange spot centrally. Black above each antenna. Pronotum orange, the grooves irregularly black; front margin of the collar black, hind margin rather broadly greenish orange. Mesonotum black; an oblong orange spot each side centrally above the elevated X which is orange. Orange each side at the base of the wings partly overlaid with an attenuated band of silvery hairs, which do not assume the spotted condition as in *hidalgoensis*. Tergum black with two small pruinose spots at the base; one large one each side bordering the tympanum and the eighth segment also conspicuously pruinose. In the type and ten male paratypes, each abdominal segment is narrowly edged posteriorly with orange; in the allotype the tergum is darker. The silvery hairs are not as conspicuous as in *hidalgoensis*. Uncus orange, black at the sides. Fore wings with the costal margin pale to the end of the radial cell, beyond darkened; subcostal vein black. The veins about the radial and basal cell are green, and the black spot in the latter is conspicuous. The anal membranes are pale gray in all of the wings. Beneath, pale orange; legs orange, claws darker. The rounded opercula touch on the inner edges, and are pruinose at the sides. Abdomen pale centrally and pruinose at sides; valve orange.

MEASUREMENTS IN MILLIMETERS

	Male Type	Female Allotype
Length of body	27	27
Width of head across eyes	10	10
Expanse of fore wings	75	76
Greatest width of fore wing	11	11
Greatest length of operculum	5.5

In addition to the type and allotype five males collected at Montemorelos by Dr. Sugden, and five others from Monterey, have been examined.

DICEROPROCTA TEXANA AND RELATED SPECIES

It has been thought by some collectors, based on their field observations, that several species have sometimes been included under the name *Diceroprocta texana*. The most easily separated of these forms are here described as a new species and a new

variety. The type of *texana* came from Cameron County, Texas, and was described and figured in the JOURNAL NEW YORK ENTOMOLOGICAL SOCIETY, March, 1916. Among the characters given for the species was: "first and second cross veins of the fore wings clouded," as shown in the figure of the type. This character is present in 237 specimens from Texas now in the writer's collection, and a great many more have been examined, all collected in 23 counties in central and southern Texas, as well as others from Grant, Chaves and Eddy counties in southern New Mexico. Specimens from the last named county, collected near Carlsbad, are straw colored as a result of their environment, and differ considerably from the much larger and darker variety or race, here described from Mexico.

On July 2, 1940, Mr. Paul C. Avery of Mission, Texas, wrote: "On June 18 about 11 miles west of Roma, Starr County, Texas, I heard a cicada song new to me. I stopped the car and located a tree in which I heard the new sound; all around I heard the song of the *Diceroprocta texana* I have caught for several years. When I located one of the new cicadas, it looked just like *D. texana*, but its song was very different. This new species had only one tune or note. Last week in Jim Hogg County, some 65 miles northwest of Mission, I heard another cicada new to me. Again I stopped and caught two specimens. These specimens looked like the typical *D. texana* to me, but again the song was different from the kind I find here. In Starr County this new species is not heard over 10 miles along U. S. Highway 83. Today I heard what I took to be the same species I discovered in Starr County in Jim Hogg County."

Tibicen robinsoniana, now well recognized as a species, was first definitely separated from its allies by its very different song, so it is not remarkable that a similar condition should be detected in the *Diceroprocta texana* group.

Diceroprocta texana* var. *lata, new variety (Plate III, Fig. 2).

Type male, Linares to Villagran, Nuevo Leon, Mexico, August 1, 1940 (Dr. John W. Sugden), Davis collection.

A large dark form with the colors more sharply contrasted than is usual in *texana*. First and second cross veins in the fore wings often deeply clouded. Head black with a greenish spot near the base of each antenna



Diceroprocta texana *var. lata*

and an oblong greenish spot near each eye. Transverse rugæ black; a pale spot centrally on the front. A large spot each side on the hind margin between the ocelli and the eyes. Pronotum brownish, with a rather large wedge-shaped greenish spot centrally extending backward to the black band on the front margin of the collar. The hind margin or collar greenish with a dark spot at the extremities each side before the humeral angle. Mesonotum with two short, obconical black spots centrally at the fore margin edged with pale, on each side of which there is a dark, reticulated band broadest anteriorly and extending backward to the extremities of the elevated X. There is also a black stripe extending along each side from the X to the base of the fore wings. Between the X and the two central obconical spots there is an irregular cross-shaped spot. The X, the lighter lines on the mesonotum, and the posterior margin of the metanotum are brownish or brownish-green. The tergum is blackish brown with the hind margin of the segments of a paler brown. The dorsal surface with much short, silken pubescence, especially along the hind margins of the segments. A pruinose spot each side on segment eight. The fore wings have the costal margin greenish brown, and the subcostal veins are dark brown. The first and second cross veins of the fore wings are conspicuously clouded, and the basal membranes of the fore wings are darker gray than is usual in typical *texana*. The basal membranes of the hind wings are much paler. Beneath lighter colored and pruinose; the legs pale streaked and spotted with testaceous. Abdomen conspicuously pruinose with the hind margin of each segment less so; valve nearly black. The opercula pale, rounded at the extremities, with the inner edges overlapping. Uncus when viewed in profile with the extremities prolonged into a sharp hook.

MEASUREMENTS IN MILLIMETERS

	Male Type
Length of body	27
Width of head across eyes	11
Expanse of fore wings	77
Greatest width of fore wing	13
Width of operculum at base	6
Greatest length of operculum	6

In addition to the type, there are two slightly smaller male

paratypes collected by Dr. Sugden, July 31, 1940, at Cienega de Flores, Mexico. Also in the writer's collection there are specimens smaller than those from Mexico, collected by Mr. P. C. Avery in Starr and Jim Hogg counties, Texas, in June and July, 1940, that approach variety *lata*, especially in their dark color and markings.

Diceroprocta averyi, new species (Plate III, Fig. 3).

Type male and allotype female, Starr County, Texas, June, 1940 (Paul C. Avery), Davis collection.

First and second cross veins in the fore wings not clouded as in *texana*. Head black, with two pale spots near the base of each antenna and a third near each eye. Hind margin with two pale spots, one each side near the eyes. Transverse rugæ streaked with black, and an oblong pale spot centrally on the front, which is paler in the paratype. Pronotum dark reddish brown with a central, longitudinal pale stripe irregularly margined each side with black. Hind margin or collar pale with a slightly greenish tinge



Diceroprocta averyi

and a dark spot at the extremities each side before the humeral angle. Mesonotum with two short, obconical black spots at the fore margin edged with pale, on each side of which there is a dark band broadest anteriorly and extending backward to the extremities of the elevated X. Also a dark stripe extending along each side from the X to the base of the fore wings. An irregular cross-shaped spot between the X and the two central obconical spots, and the two depressed black points common to many species, and near the anterior extremities of the X, are also present. The X, the lighter lines on the mesonotum and the posterior margin of the metanotum are yellowish. The tergum is almost black; the tympanal areas lighter with the terminal segments lighter in color along their posterior margins. The dorsal surface is more or less covered with a light colored, short silken pubescence. A pruinose spot each side on segment eight. The fore wings have the costal margins greenish yellow and the subcostal veins are dark brown. The first and second cross veins of the fore wings not clouded, and the basal membranes of both fore and hind wings are grayish. Beneath lighter colored and pruinose, blackened about the eyes; the legs yellowish, streaked and spotted with testaceous. Abdomen nearly of a uniform color with a linear

dark spot on the valve. In the allotype there is a dark spot each side of the shallow, terminal notch. The opercula pale, rounded at the extremities, with the inner edges overlapping, except in one of the paratypes where they almost touch. Uncus when viewed in profile with an almost right angle notch near the extremity.

MEASUREMENTS IN MILLIMETERS

	Male Type	Female Allotype
Length of body	24	21
Width of head across eyes	10	9
Expanse of fore wings	67	63
Greatest width of fore wing	11	10
Width of operculum at base	6
Greatest length of operculum	5.5

In addition to the type and allotype, the following specimens have been examined: five males, Starr County, Texas, June, 1940 (P. C. Avery), and two males, Roma, Starr County, Texas, June 2, 1933 (P. W. and M. J. Oman). Some are larger than the type.

Mr. Avery has also collected in Jim Hogg County, which adjoins Starr County to the north, two males and one female, June 2, 1940, and three males, August, 1940, that are like typical *averyi* except that they are not as darkly colored.

In "Cicadas Belonging to the Genus *Diceroprocta* with Descriptions of New Species," published in this JOURNAL for 1928, is the statement that on September 11, 1928, F. F. Bibby and J. F. Cooper had collected nine specimens in Winkler County, Texas, in which the first and second cross veins in the fore wings were not clouded or infuscated as in typical *texana*. These specimens closely resemble *averyi*, and are probably but a lighter colored and smaller form.

Diceroprocta albomaculata Davis

This species was described and figured in the JOURNAL NEW YORK ENTOMOLOGICAL SOCIETY, December, 1928, from a male type, now in the U. S. National Museum, and a male paratype in the writer's collection. Both came from Vera Cruz, Mexico. Another male in the National Museum, is from Vera Cruz, Mexico, June, 1937. Lately I received from Mr. Harry Hoogstraal of the University of Illinois, five males collected by Ralph Haag from July 17 to 20, 1939, at El Pojul, San Luis Potosi, which adjoins the state of Vera Cruz on the northwest.

Okanagana villosa, new species (Plate III, Figs. 4 and 7).

Type male, Cloud's Rest, 9,924 feet, Yosemite National Park, California, June 9, 1931, University of California collection.

Resembles *Okanagana oregona* and *Okanagana wymori* in size and general appearance, or a small *Okanagana bella*, but may be told by its being extremely hairy both below and above. The thick growth of hairs extends all over the dorsal surface from the front of the head to the uncus, which also has some hairs both above and below. Uncus when viewed in profile sinuated, but not hooked at the extremity. Wings transparent, costal margin of the fore pair yellowish, the basal area clouded, and the anal membranes of all of the wings orange.

Head black with the supra-antennal plates and a short line in the depression before the front ocellus, yellowish. Pronotum black margined all around, but narrowly in front, with yellowish. Mesonotum black with the posterior margin pale, except where reached by the hind limbs of the X

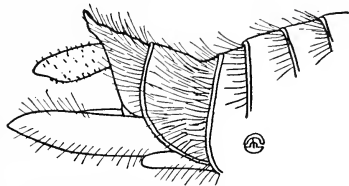

Okanagana villosa

which are black. Metanotum with the posterior margin nearly pale. Dorsum of the abdomen black, the segments edged posteriorly with orange. Uncus all black. Beneath, head black with a pale line each side of the transverse rugæ. Legs with the femora largely black except beneath; the tibiæ with the basal parts black, except beneath. Abdomen black with each segment sharply margined posteriorly with orange. Valve long, black, except the upper edge near the base, which is orange.

MEASUREMENTS IN MILLIMETERS

	Male Type
Length of body	20
Width of head across eyes	6
Expanse of fore wings	50
Greatest width of fore wing	8
Length of valve	3.5

Although this species is described from a single male, the remarkable development of hairs on all parts of the body, should serve to identify it. It is possibly confined to high altitudes.

Platypedia australis, new species (Plate III, Figs. 5 and 6).

Type female, Galeana, Nuevo Leon, Mexico, July 31, 1939 (Ralph Haag), Davis collection.

Front of the head not prominent, and not as hairy as in many *Platypedia*. Abdomen stout and broad almost to the extremity, with the terminal notch on the underside U shaped. The front margin of each fore wing suddenly bent at the end of the radial cell about as in the species of *Neoplattypedia*, but each wing has 8 marginal areas as in *Platypedia*; in *Neoplattypedia* there are seven. The median vein in the fore wing is considerably bent downward near its central portion, more so than observed in any other species of *Platypedia* or *Neoplattypedia*. The 6 marginal areas in each hind wing are distinctive in form, as shown on the plate, and differ from that usual in both *Platypedia* and *Neoplattypedia*.

Head black with a pale spot above each antenna. Pronotum black with the grooves pale, edged all around with a greenish margin; a dark spot at the hind angles, on the collar. Mesonotum black, including the X, with an irregular pale stripe on each side of the obconical areas, and an irregular spot at the base of each fore wing. Hind margin pale. Abdomen with the segments, except the terminal one, black at base and pale on the posterior margins. The terminal segment is black above; on the sides pale with black spots. Under side of the head black, legs greenish, margined with black; abdomen green except at the notch where there is a small black spot each side of the ovipositor. The terminal spine is small. Wings with the front margin mostly pale; the remainder of the venation black; basal cell slightly clouded, with the membranes at the base of all of the wings red or reddish in color.

MEASUREMENTS IN MILLIMETERS

	Female Type
Length of body	14
Width of head across eyes	4
Expanse of fore wings	34
Greatest width of fore wing	6.5

Pending the examination of the much desired male the peculiar venation of this species will distinguish it from other *Platypedia*.

The type locality is nearly 150 miles south of the Rio Grande and a like distance from the Gulf of Mexico.

PLATE II

- Figure 1. *Okanagana magnifica*, wing venation.
 Figure 2. *Fidicina compostela*, wing venation.
 Figure 3. *Okanagana rimosa*, wing venation.
 Figure 4. *Tibicen bifida* variety *simplex*, type.
 Figure 5. *Tibicen hidalgoensis*, type.

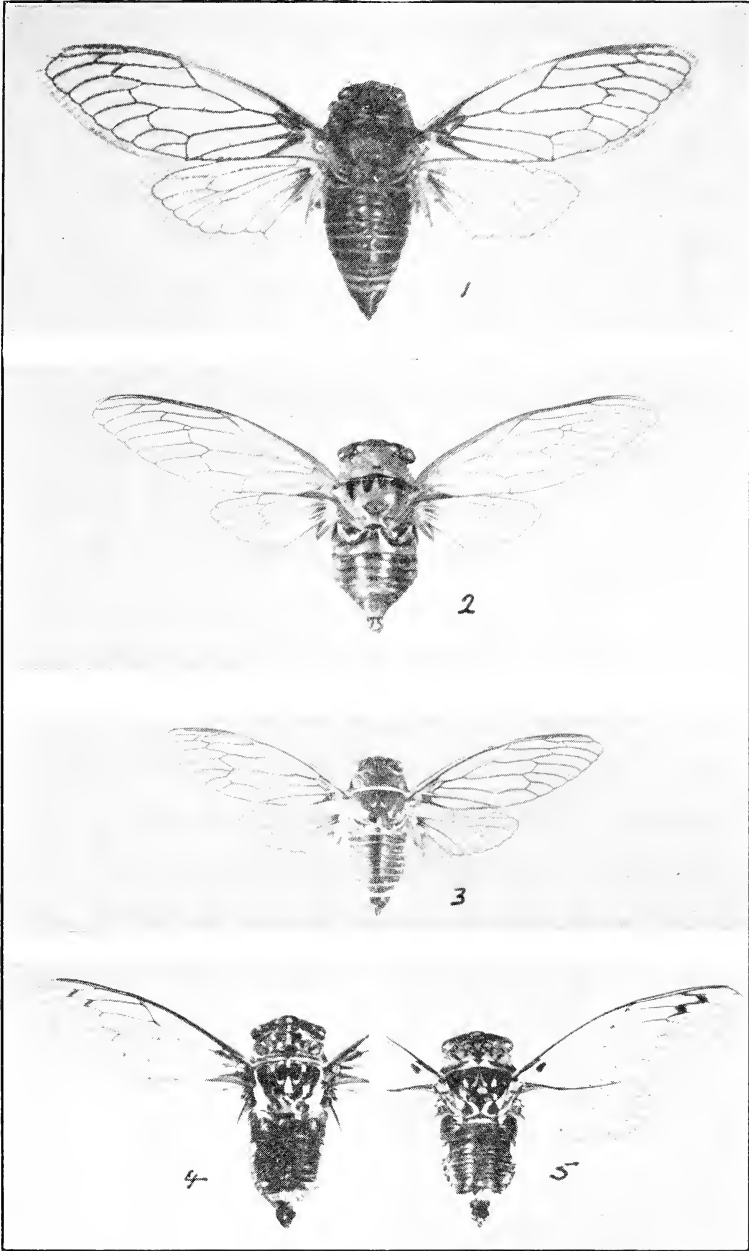
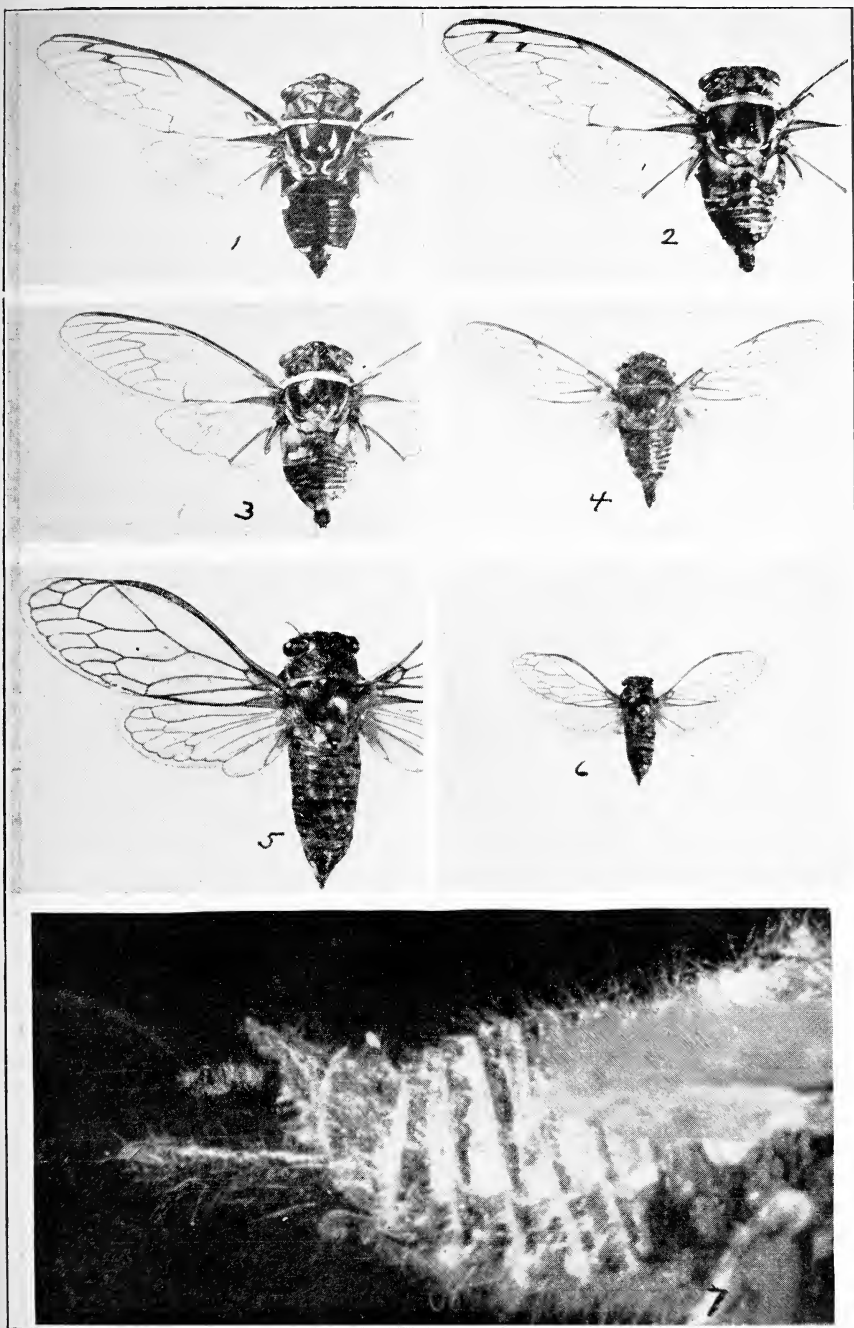

PLATE III

- Figure 1. *Tibicen sugdeni*, type.
Figure 2. *Diceroprocta texana* variety *lata*, type.
Figure 3. *Diceroprocta averyi*, type.
Figure 4. *Okanagana villosa*, type.
Figure 5. *Platypedia australis*, type, enlarged.
Figure 6. *Platypedia australis*, type.
Figure 7. *Okanagana villosa*, type. Much enlarged and showing hairs on top of abdomen.



CHARLES W. LENG

We regret to announce the death of Charles W. Leng on January 24, 1941, at the age of 81 years. Mr. Leng joined the New York Entomological Society in 1902 and was closely identified with it for many years afterward. From 1903 to 1906 he served as Vice-President, from 1907 to 1911, as President, and from 1912 to 1930 as Secretary. At the time of his death, he was director of the Staten Island Institute of Arts and Sciences. A complete account of Mr. Leng's life will be published in a forthcoming issue of the *JOURNAL*.

THE POSITION OF *UTETHEISA GALAPAGENSIS* (LEPIDOPTERA, ARCTIIDÆ)

BY WM. T. M. FORBES, CORNELL UNIVERSITY
ITHACA, NEW YORK

In a recent paper (Nov. Zool. xli: 251, 1939) Dr. Jordan has discussed the relationships of the Old World species of *Utetheisa* with a somewhat full analysis of their characters. The present note supplements this with reference to the two New World species, *ornatrix* and *galapagensis*, and makes suggestions as to the geographical history of the group. I have also added some purely personal opinions, not capable of proof but as I believe worth evaluation.

The genus *Utetheisa* is wholly of Old World affinity, and there is no other genus extremely close to it, in itself a hint that it may be a relict type, against which is the fact that several of the species are wide-spread and extremely abundant, notably *ornatrix* in the New World, *pulchella* in Africa and southern Europe and *pulchelloides* in the Indo-australian. A parallel case is *Libythea*, also a very ancient type with a few species which are abundant in the same warm-temperate and tropical areas. The closest relatives are *Rhodogastris* and *Argina*, both limited to the Old World; and a few other Old World genera, such as *Baroa*, *Digama* and *Soloe*, may also be related but have not yet been studied. At present these are divided between the two families Arctiidæ and Hypsidæ, on account of some fluctuation in the degree of fusion of Sc and R, but all other features, and especially the almost identical larvæ of *Utetheisa* and *Argina*, show this is an arbitrary division. In fact *Argina* genitally could be a direct descendant of the original *Utetheisa*.

Habitus figures of almost all the species may be found in Seitz's "Macrolepidoptera of the World," vol. ii, pl. 13, line k (*pulchella* forms) vi, 38: h (*ornatrix*, *o. bella* and an unrecognizable figure labelled *galapagensis*), x, 24: g (*semara*, *lotrix*, *marshallarum*—i.e., *pulchelloides*, *sumatrana* and *salomonis*) and xiv, 12: a, b (*elata*, *pulchella kallima* and *p. dilutior*, *cruentata*, *lactea* and

pulchelloides). The rarer of these species are also figured in Hampson's Cat. Lep. Phal. iii, pl. 50, and supplement ii, pl. 68, including figures of *pectinata*, typical *pulchelloides*, *elata fatua* and a more recognizable figure of *galapagensis*. *Utetheisa amhara* Jord. and several subspecies of *pulchelloides*, described in Nov. Zool., l.c., have not been figured, but will not be superficially separable from *pulchella* and *pulchelloides*. I have published male genitalic figures of *U. pulchella*, *lotrix* (as *semara* in error) and *ornatrix* in Bull. Am. Mus. N. H., xxxvii, 342, 1917; and Jordan publishes figures of *pulchella*, *pulchelloides*, *lotrix*, *semara*, *amhara* and *salomonis* in Nov. Zool., but the very significant *U. lactea* has never been figured, and the external figure of *semara* does not show the homologies of the structures, nor any indication of the "clasper" complex. In the present paper I figure *U. galapagensis* (Fig. 3), and refigure *U. pulchella* (Fig. 2), both for comparison and to bring out some additional features of the inner face of the valve.

In order not to prejudice my opinion too much I made a survey of all the tangible structural characters I could find. Besides the external features of antenna, wing-tuft and hind tibia, already fully reported by Jordan, the six species at hand show the following points capable of sharp characterization in their male genitalia:

Uncus: normal, somewhat compressed (*pulchella*, *pulchelloides*) or hatchet-shaped (*lotrix*).

Sides of *tegumen* dorsally: divergent (*ornatrix*), fused for half their length (*lotrix*) or more shortly fused.

Basal part of costa: varies much in its length proportionally to the rest of the valve, and especially in the length of the fully chitinized portion just below the base of the "ampulla,"—the articular membrane being extended almost up to the base of the ampulla in *galapagensis* and nearly as far in *ornatrix*.

Outer part of costa (P_2 of Jordan, including his P_3 in *pulchella*, but not in *lotrix*): breadth and form, whether straight (*lotrix* and *ornatrix*), angulate (*pulchelloides*) or arched (the residue, including *galapagensis*!). In *ornatrix* alone the extreme tip is tessellated; there is a different, more diagonal type of sculpture in the basic *pulchella* group and *pulchelloides* (also

Argina, Fig. 4), but I believe of a different type, while *lotrix* is plain.

“*Ampulla*” (so-called on superficial resemblance, without any guarantee that it is homologous with the true ampulla of the Noctuidæ) (P_1 of Jordan): large (*ornatrix*, *elata*) small and conical (*pulchelloides*) or medium with rounded hairy apex.

“*Clasper*” (a vestigial structure in the form of a hook surrounding a pointed process of the sacculus; I believe this is morphologically the clasper, since the clasper-muscle is attached to it (Fig. 1), though it has no free portion in *Utetheisa* and is entirely lost in *Argina*;—it is the middle part of the complex “*n*” in Jordan’s Figs. 238, 241, 243; everted to project beyond costa in *ornatrix*, otherwise on inner face of valve.

Hairy area of sacculus: Not strong and mostly basad of clasper, or heavily extended distally (*ornatrix*) or divided into two pads (the outer one P_3 of Jordan) in *lotrix*.

Process of ampulla, extending up to clasper: simple and flat, or set diagonally in surface of valve and dished (*pulchella* and *elata*);—also the ampulla-hair at its base may be overdeveloped (*ornatrix*) or the punctate area extended up its basal edge (*pulchelloides*). It is lost in *Argina* (Fig. 4) but the punctate area survives, showing it has been retracted into the general mass of the sacculus.

Punctate base of ampulla: lost in *U. pulchelloides*. This is also well marked in *Argina*, and shows that the “ampulla” material has been incorporated into the outer segment of the costa.

The armature of the penis exhibits more complicated relationships, but it may be noted that only *pulchella* and *pulchelloides* have free cornuti like *Argina* (few in *pulchella*), the external chitinization is heavily dentate only in *galapagensis* and *lotrix*, though *pulchella* shows less striking scobination, and on the other hand *elata* and *ornatrix* have pretty well lost their armature.

Passing these features in review we find that three of the species have each so many absolutely unique features and so few common ones that we must think them independently derived from the common ancestor, while *pulchelloides* and *idæ* may well come from the common ancestor of *pulchella* and *elata*.

In *galapagensis*, the male antennæ are strongly pectinate (as suspected by Jordan) and female serrate. The base of costa (Fig.

3) is shortest of any species, its fully chitinized portion a mere bridge; punctate area below ampulla lost, and internal nodules of penis blunt and rounded. The two surviving rose thorns (a likeness to *pulchella* and *lotrix*) are partly fused. The complete loss of pattern is unique though typical *lactea* has taken a long step in this direction. The only character shared by another species is the dentate outer plate of the penis (like *lotrix*), while all other features are either primitive or shared by all the normal species of the genus. Obviously *galapagensis* has had a separate descent from the common ancestor.

In *lotrix* (Fig. 1) the hind tibia shows reduced spurs and special scaling; the uncus is cleaver-shaped, attached to a specially massive tegumen; base of the valves longer and outer part much shorter and smaller than in any other species; the sacculus has a separate and very heavy distal hairy pad (which is the best recognition character without dissection). *Lotrix*, then, also has certainly a separate ancestry; the narrowed outer costa being unlike that of *ornatrix* in details; and the dentate penis-plate of *galapagensis* cancelled by the complete lack of other resemblances.

In *ornatrix* (therein including *bella* and the various West Indian forms which are absolutely identical in structure), the two halves of the tegumen are divergent almost from their apex, the tip of the costa is scobinate, the whole inner face of the valve everted, throwing the clasper up to the costal edge, and the hairy patch of the sacculus is extended up its process more than half way to the clasper. Outside connections are few and do not point in any one direction,—the weakly armed penis to *elata*, the large ampulla and narrow outer costa to *lotrix*, the very short base of costa to *galapagensis*. I may also note that the pattern of *U. o. stretchii*, which I consider the most primitive subspecies, is practically identical with *U. pulchella kallima* and *dilutior*, while the other species diverge, most of them following *p. pulchella*.

U. pulchelloides is perhaps not quite so isolated. It also has its absolutely unique features,—the angulate outer costa, triangular ampulla, extension of the punctation up the basal side of the saccular process and numerous free cornuti (like *Argina cribraria*), but it also shows a special tendency to have the characters of *pulchella* and *elata*, especially the hair-pencil of

elata and the cornuti of *pulchella*; and in all three against the three preceding species, the base of the costa has a long fully chitinized portion, though less in my specimen from Formosa than the one from New Guinea, which is almost like *lotrix*.

This leaves *pulchella* and *elata*, of the species at hand. Their differences are of a lower order, though plentiful enough: the hair-pencil, much heavier ampulla and distal part of costa, and loss of armature of the penis, as well as the striking pattern,—*elata* being in each case more specialized. The only unique feature in common is the curved and obliquely placed process of the sacculus, but they share a long list of primitive or generic features lost by one or more of the others. We may then see in *pulchella* the nearest survivor of the original generic type. In pattern, also, the identity of the West Indian races of *ornatrix* and the African races of *pulchella* is highly suggestive. If so the differentiation of the pink hind wing of the Cuban race and the yellow fore wing of *bella* are successive advancing mutations. In general the yellow and red pigments of the Arctiidæ are evidently closely connected, and readily change into each other, even within a species, so that there is no reason in a given case to think one is original and the other derived. If we were to take *Argina cribraria* as the immediate ancestor of *Utetheisa* it would give a bias in favor of yellow, but in fact the genitalia of *Argina* are definitely more degenerate, having lost even the base of the clasper, and having costa and sacculus fused distally,—and both colors also occur in *Argina*, so the evidence is an illusion. The presence of red in all but one species of the group, and the limitation of the yellow to subspecies of only two (*ornatrix* and *lactea*), each of which also has red, seems strongly to point to the red as original.

U. lactea, which in its structure, and the pattern of fully marked specimens, falls between *pulchella* and *elata*, is the only species which (in other specimens) shows a general loss of pattern approaching *galapagensis*. As may be seen by Figures 2 and 3, the general appearance of *galapagensis* is almost like *pulchella*, and if such points as the process of sacculus were overlooked it might well be put in the *pulchella* group. If on examination *lactea* should also turn out to be a member of the

group only in having preserved primitive features, and otherwise approaching *galapagensis*, we would have the same odd grouping as in the case of the Giant Tortoises, which have also survived only on the Galapagos and on the islands off Madagascar. To judge only by its appearance and the external figure in Nov. Zool., *U. semara* will make still another species standing on a line by itself.

In brief. *Utetheisa* is an ancient genus in spite of its present dominance in individuals, and like other ancient types it is represented by a few sharply distinguished species, not forming any geographical pattern. The most primitive form, *pulchella*, lies at the center with a few derivatives. The three New World species have no connection with each other, and little with Old World species, any common features being merely primitive. Doubtless they are accidental survivors from a more extensive lost fauna.

To supplement Figure 3, the chief characters of *Utetheisa galapagensis* Wallengren may be summed up as follows: Male antennæ pectinate, the pectinations slender and much longer than segments, female serrate; fore wing with a small trapezoidal accessory cell (only one specimen examined) with R_2 arising separately from it; pattern cryptic, the usual red and black markings lost; hind wing without pencil or pocket and (in slightly rubbed condition) without even long loose hairs. Hind tibiæ normal. Male tegumen as in *pulchella* and most other species, the uncus hardly compressed. Valve with chitinized part of base of costa minimum, ampulla separated by the usual membranous gap from it, masked by the wide arched outer part of costa, without a punctate area at base; outer costa arched and widened as in *pulchella*, but only $\frac{2}{3}$ as wide and less ridged (*pulchella* group of Jordan!); basal part of sacculus with the usual dense hair on inner face, but outer part with only scattered setæ, the dense hair just invading the base of its process which is nearly an isosceles triangle and cut off from rest of sacculus by a complete band of granulation (Fig. 3, upper left). Penis with a heavy dentate outer plate on one side, internally with a twice-humped plate, two partly fused rose thorns, and three large semi-ellipsoidal cornuti, besides the usual fine shagreening inside and out.

Argina cribraria may be described in similar terms (Fig. 4). Tegumen flaring as in *ornatrix*, but with a single strengthening middorsal ridge to base of uncus instead of the two divergent ones of *Utetheisa*; uncus not compressed, as in *Utetheisa*; basal costa short as in *Utetheisa*, with a membranous break on costal edge, and the articular membrane reaching almost up to it in middle; outer costa enormously inflated, scobinate on inner face, except baso-ventrally where it is smooth and sparsely bristled; no intervening ampulla or clasper-like structures, the usual granulated patch at base on ampulla strong and lying along distal edge of the membranous break. Sacculus slender, nearly straight, and ending in a chitinized spine homologous with P_3 of *U. lotrix*, but perhaps also incorporating the tip of the costa; no saccular process, but a long straight band of membrane separating the costal and saccular areas, to which the clasper muscle seems to be attached; the granulated area forming a partial break in the sacculus itself.

I may add the following as pure matters of opinion in which I differ from Dr. Jordan; they can be considered to have no greater validity than opinion.

1. I believe that the primitive pattern of the Lepidoptera, of transverse bands, etc., has been modified too long to have validity in the Arctiidæ. Our knowledge of the direct ancestry of the genus is zero, and we can assume only details based on the usual macrolepidopterous ground plan (as shown in Comstock's Introduction to Entomology, p. 575, Fig. 712). There is no evidence that vein-stripes persisted as such, as high as the Arctiidæ, but they could always be recreated on the basis of the underlying veins.

2. I consider the red and white coloring of *U. o. stretchi* and *U. p. kallima* primitive rather than the yellow and red of *bella* (see above).

3. I consider the form with trapezoidal acc. cell primitive, with R_2 arising from it separately, this being directly derivable from the original plan with R_2 stalked with 3 , and 4 with 5 (as in *Ilemodes*, Hampson, Fig. 229, and early members of most other families of higher moths). In terms of Jordan's paper I take his Fig. 226 E as primitive for *Utetheisa*, and derive two lines of

specialization, *a*, through atrophy of a sector of R_3 , freeing R_2 (E, F, G) and *b*, through the reduction of the acc. cell, leaving R_2 stalked (E, B, C, D).

4. I consider the basic pigment of Lepidoptera (and all insects) to be the melanin series (cream-buff-brown-black). In the different and later yellow-red series of colors we have no reason to believe yellow is older than red, and I do not believe that brown in general involves either the red or the yellow, though it may in the special case where the brown of *Utetheisa* replaces a normal red (*U. pulchelloides*).

5. I consider the various main-land American forms merely subspecies of *U. ornatix* (Bull. Am. Mus. Nat. Hist., xxxvii, 342; Sci. Surv. Porto Rico xii, 38 and Supplement, 343), since there is no difference whatever in structure and they intergrade perfectly in the Antilles,—forming mixed colonies in characters that mendelize; though they have attained enough distinction to remain separate in a narrow zone from Kansas to Texas.

Postscript. Since this article went to press I have had the opportunity to study three more species at the U. S. National Museum. *U. lactea* and *U. sumatrana* were found in undetermined material, and I can confirm Jordan's placing of them. Of extraordinary interest, however, were the types of *U. idæ* Clarke (Proc. Ent. Soc. Wash. xlii, 42, 1940). They show pure Old World affinity, having no resemblance either to *ornatrix* or *galapagensis*. Besides the characters given by Clarke, it may be noted that they have very much the pattern of a fully marked specimen of *U. lactea*, though a little different habitus, and also show the serrate antennæ and hair-pencil on the hind wing of *U. pulchelloides*. As Clarke's figures show, the genitalia are quite distinct from any other species, the oddly widened costa giving a faint suggestion of *U. pulchelloides* and *Argina*.

PLATE I

- Figure 1. Nomenclature of parts of male genitalia of *Utetheisa*, based on *U. lotrix* (slightly diagrammatic).
 P_1 , P_2 , P_3 processes of valve so labelled by Jordan.
 n Clasper complex (so labelled by Jordan).
A. Punctate area of ampulla.
B. Punctate area of process to sacculus.
- Figure 2. *Utetheisa pulchella*, male genitalia with left valve omitted and penis figured separately.
- Figure 3. *U. galapagensis*, male genitalia with penis figured separately, and process of ampulla more enlarged, showing punctate area.
- Figure 4. *Argina cribraria*, distal part of valve.
(All figures by Dr. May Gyger)

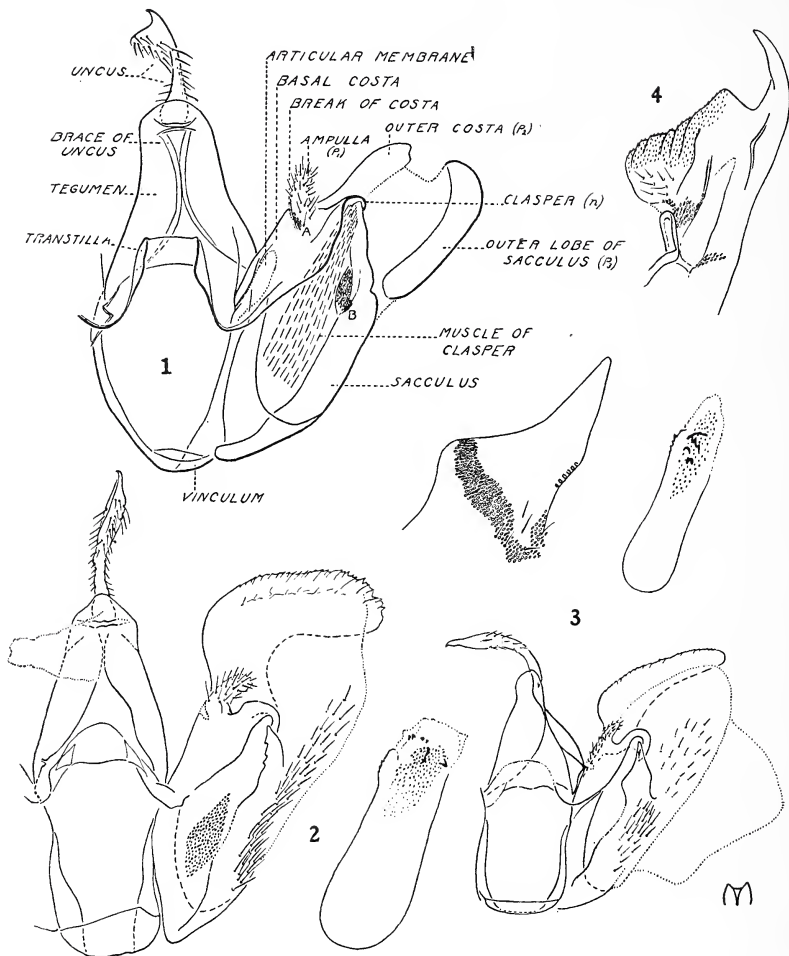

PROCEEDINGS OF THE NEW YORK ENTOMOLOGICAL SOCIETY

MEETING OF JANUARY 2, 1940

The annual meeting of the New York Entomological Society was held on January 2, 1940, in the American Museum of Natural History; Dr. Curran in the chair with thirty-two members and visitors present.

The following officers were elected for the year 1940:

President	Dr. A. B. Klots
Vice-President	Max Kisliuk
Treasurer	Dr. H. T. Spieth
Secretary	Lucy W. Clausen
Librarian	Dr. R. E. Blackwelder
Curator	Chris. E. Olsen
 Executive Committee	 Publication Committee
Dr. F. E. Lutz	H. B. Weiss
Dr. Wm. Procter	J. D. Sherman, Jr.
H. F. Schwarz	Dr. Wm. Moore
Henry Bird	E. L. Bell
Dr. H. Ruckes	

Delegate to the New York Academy of Sciences
William T. Davis

In recognition of Mr. Davis' long association with the Society and his many scientific contributions to entomology in general, he was elected to the permanent office of Honorary President.

Several members, including Dr. Horsfall, Dr. Forbes and Mr. Kisliuk, reported on the Christmas meetings in Columbus, Ohio.

Dr. Ruckes suggested that help be given the program committee by members offering to give papers.

A vote of thanks was extended to all officers of the Society for 1939.

Mr. Engelhardt spoke of the financial security that the Brooklyn Entomological Society has achieved through hard work.

LUCY W. CLAUSEN, *Secretary*.

MEETING OF JANUARY 16, 1940

A regular meeting of the New York Entomological Society was held on January 16, 1940, in the American Museum of Natural History; President Klots in the chair with forty-three members and visitors present.

Dr. Klots appointed the following committees:

Program—Dr. W. J. Gertsch
Frank Soraci
Edwin W. Teale

Field —J. W. Angell
 A. S. Nicolay
 G. Rau
 Auditing—Dr. J. L. Horsfall
 E. L. Bell
 G. B. Engelhardt

Dr. Gertsch, the speaker of the evening, then addressed the Society on "Comparison of the Burrowing Wolf Spiders and Burrowing Tarantulas," an abstract of which follows.

LUCY W. CLAUSEN, *Secretary.*

A COMPARISON OF THE BURROWING WOLF SPIDERS AND BURROWING TARANTULAS

Some spiders have gone to great lengths to establish a permanent site of residence which offers shelter from the sun and the rain. One of the most interesting practices is that of digging a tunnel into the earth. Within the confines of this burrow retreat the spider is assured some immunity from the extremes of inclement weather and a measure of security from many of its enemies. The burrowing habit, which is seemingly a most satisfactory and advantageous one, is shared by species of widely separated families. Within the limits of the United States the most notorious burrowers are some of the wolf spiders or lycosids and the trap-door spiders and their relatives.

The typical burrow is a cylindrical tunnel in the earth which may be lined with silk for all or only part of its length. The diameter of the tube is determined by the size and age of the burrower. The opening to the typical burrow is the spider's only contact with the outside, except in very rare cases where more than one exit is known to have been constructed. One of the advantages of the burrow is that it is the property of a single, unsocial individual, and can become, with the passage of time, more and more adequately coated with silk, more and more familiar in every part, and thus increasingly acceptable to the spider as something which is his personal property. It is his retreat from the sun's rays, the extreme heat of which is shunned even by diurnal forms. A collar, a turret, or lid at the entrance prevents much rain and surface water from entering, thus keeping it dryer than situations on the ground. All the burrowing spiders live more than a single year, some of them several years.

Some of our wolf spiders are accomplished burrowers. As a general rule, it can be said that the true trap-door spiders are finer artisans, but the excellence of the building of some of the lycosids is in many respects comparable with them. We can see a definite series in point of habits from the vagrant wanderer to the confirmed burrower. Some of them are just beginning to avail themselves of this interesting habit, accepting any likely space, enlarging it and lining it with silk. Others are digging characteristic tunnels into sand or soil.

For a digging instrument the true trap-door spiders have developed comb-like rakes or rastellums on the margins of the chelicerae. With the aid of this rake they are able to cut and scrape away small particles of earth which are molded into balls and carried outside the burrow. The walls of the tube are waterproofed by applying a firm coating of saliva and earth, so that the surface becomes smooth and firm. The silken lining of the tube varies in thickness and extent, in some cases not completely lining the burrow.

Finally, in summarizing what has been said about burrowing lycosids and the burrowing tarantulas, we can conclude that these animals, so widely separated in their respective heritages and so differently endowed from the

viewpoint of structural and sensory qualities, have responded in much the same way to a subterranean life. The notable achievement in each line has been identical, the development of a distinctive, hinged cover for the burrow, a trap-door.—W. J. GERTSCH.

MEETING OF FEBRUARY 6, 1940

A regular meeting of the New York Entomological Society was held on February 6, 1940, in the American Museum of Natural History; President Klots in the chair with about 250 members and visitors present.

Dr. Melander, the speaker of the evening, then showed his 1939 edition of colored motion pictures of insect life.

LUCY W. CLAUSEN, *Secretary*.

MEETING OF FEBRUARY 20, 1940

A regular meeting of the New York Entomological Society was held on February 20, 1940, in the American Museum of Natural History; Dr. Klots in the chair with twenty-three members and visitors present.

The Secretary read a letter from Mr. Davis conveying his deep appreciation for the highly prized honor of being Honorary President of the Society.

The resignations of Mr. DeGhika and Mr. W. Bennett were accepted with regret.

A motion was made and carried that the Society suspend sending the JOURNAL to countries now beset with difficulties until such time as they become straightened out.

The paper of the evening was then presented by Dr. Ruckes on "Brochymena," an abstract of which follows.

LUCY W. CLAUSEN, *Secretary*.

ABSTRACT OF PAPER ON *Brochymena* A. AND S.

The genus *Brochymena* is the New World representative of the tribe Halyini of the family Pentatomidæ. There are altogether some twenty-three species known to date. They are all plant feeders, provided with a long, thin beak too weak and pliable to be used in predatory feeding. The food plants are very varied, though trees of various kinds are most frequented. The species are widely distributed in North America, Mexico and Central America. Some species are distinctly local and sparse, others are widespread and common.

The genus lends itself readily to division into two major groups, (1) those with pronotal shoulders which are quadrangular, in which the metasternal pore is without a canal or evaporating area and in which the males have claspers with prominent ventrally projecting hooks and in which the females have prominent tumid basal valves in the genital plates; (2) those with pronotal shoulders which are triangular and usually without dentition; in which the metasternal pore is provided with a laterally extending canal and a triangular evaporating area about it and in which the males have claspers devoid of the ventral hooks and in which the females have basal valvular plates that are not tumid and not particularly prominent.

Of the first group there are the following species: *arborea* (Say), *florida* Rks., *poeyi* (Guer.), *hædula* Stål, *aculeata* Dist., *barberi* Rks., *apiculata* Van D., and *barberi* var. *diluta* Rks.

Of the second group there are the following species: *quadripustulata*

(Fabr.), *sulcata* Van D., *pilatei* Van D., *cuspidata* Dist., *cariosa* Stål, *lineata* Rks., *dilata* Rks., *carolinensis* West., *marginella* Stål, *myops* Stål, *usingeri* Rks., *humeralis* Rks., *affinis* Van D., *hoppingi* Van D., *punctata* Van D., and *tenebrosa* Walk. (?).

The paper was illustrated with chalk drawings and lantern slides of photographs of as many types and paratypes as have been available for study. Details of each species were remarked upon.—H. RUCKES.

MEETING OF MARCH 5, 1940

A regular meeting of the New York Entomological Society was held on March 5, 1940, in the American Museum of Natural History; President Klots in the chair with twenty-nine members and visitors present.

The speaker of the evening, Dr. Ernst Mayr, then spoke on "Geographical Distribution of Species," an abstract of which follows.

LUCY W. CLAUSEN, *Secretary*.

ABSTRACT OF "GEOGRAPHICAL DISTRIBUTION OF SPECIES"

The principles and techniques of ornithological taxonomy are applicable to insects as well as to birds. In the present discussion, birds are employed because of our relatively complete knowledge of the group. During the last fifty years, no new species of birds has been discovered in North America or in Europe, and only about three new species are discovered per year the world over. In 1910, there were 18,000 species of birds known. This number has been reduced to about 8,000 species because of the introduction around 1900 of trinominals. There is every reason to believe that insect taxonomy will follow the same path. In some better known families, a similar trend is already discernible.

At present a species can be defined as a group of populations which replace each other geographically or ecologically and of which the neighboring ones intergrade or hybridize wherever they are in contact, or which are potentially capable of doing so (with one or more of the populations) in those cases where contact is prevented by geographical or ecological barriers.

Intensive study of the characters within the populations often shows regular spatial variations, *i.e.*, the clines of Huxley. Rensch and others have worked out for birds rather complete sets of ecological rules affecting such characters as size, pigmentation, proportions, number of eggs, etc. Goldschmidt has done similar work on *Lymantria*.

Wherever these replacing populations are in geographical contact and where isolation is lacking, there is inevitably a gliding intergradation. If they are isolated then there is a discontinuity and the question arises whether to call them species or subspecies. There also arises the major question of how species come into existence. Darwin in his "Origin of Species" really discussed macro-evolution and not micro-evolution. Our ideas on species formation are relatively new and not until the advent of genetics were they really brought to the fore.

Goldschmidt thinks that geographical subspecies do not give rise to species. He, however, has been dealing with continental species that range over a large area without potent geographical barriers. Study of insular and especially oceanic birds indicates that species formation may take place through geographical subspecies and isolation. The isolation mechanisms may be of various sorts, *i.e.*, geographical, ecological or psychological.—ERNST MAYR.

MEETING OF MARCH 19, 1940

A regular meeting of the New York Entomological Society was held on

March 19, 1940, in the American Museum of Natural History; President Klots in the chair with thirty-three members and visitors present.

Mr. Filmer, the speaker of the evening, then addressed the members.

In the old days of bee breeding a man would start with 10 hives and by the end of the season would have 40 or 50. The modern apiary uses movable frame hives in 2 or 3 stories.

Mr. Filmer pointed out that modern practices show that the healthier the bees in a hive the more honey is produced. Honey yields of the state of New Jersey average 30 pounds per colony. The work of late is directed toward finding a way of combating American foul brood by producing a disease-resistant strain of bees. Federal workers have developed some strains that are 95-99 per cent resistant. Apparently this resistance to foul brood is to be found in the gland secretion that is fed to the young bees during the first two days of their lives, and in certain colonies this glandular secretion proves toxic to the disease organism.

LUCY W. CLAUSEN, *Secretary*.

MEETING OF APRIL 2, 1940

A regular meeting of the New York Entomological Society was held on April 2, 1940, in the American Museum of Natural History; President Klots in the chair with sixty-four members and visitors present.

Dr. Blackwelder announced that the last general auction of the Society's books was now being held.

Dr. Klots welcomed several distinguished visitors—Dr. Hoffman from China, Dr. William Beebe and Dr. Palm of Ithaca.

Mr. Samuel Harriet of 200 W. 58th Street, New York City, was proposed for membership.

Dr. Emerson spoke on the "Phylogeny of the Termites" with special reference to *Nasutitermes* and related genera of that group. From his studies it seemed evident that the various genera, formerly regarded as representing a single line, could be grouped into two series which had traveled much the same road in their development.

The mandibles of termites may be considered as a fundamental stable character since they hark back to the ancient heritage of the cockroach and stay essentially the same over many millions of years.

From the most primitive types, those in which the mandibles are still functional and the frontal protuberance is weakly developed, the progression to the most highly developed genera was outlined. The group culminated in specialized genera such as *Nasutitermes*, which is the most successful type of termite that exists. Dr. Emerson's talk was illustrated with charts and lantern slides.

LUCY W. CLAUSEN, *Secretary*.

MEETING OF APRIL 21, 1940

A regular meeting of the New York Entomological Society was held on April 21, 1940, in the American Museum of Natural History; President Klots in the chair with thirty-eight members and visitors present.

Dr. Blackwelder announced that the auction would close at the end of the meeting.

Dr. Klots announced that the last meeting on May 21 would be in the nature of a social gathering.

Mr. Samuel Harriet was elected to membership.

The speaker of the evening, Dr. Sally Hughes-Schrader of Columbia University and Sarah Lawrence College, addressed the members on "Studies on the Biology of Primitive Coccidæ," an abstract of which follows.

LUCY W. CLAUSEN, *Secretary*.

STUDIES ON THE BIOLOGY OF PRIMITIVE COCCIDS

The insect family Coccidæ poses a wide range of problems for the biologist. Here are species in which no males are known, species in which the males seem to be in process of elimination, others in which an obligatory parthenogenesis produces females only, still others in which a facultative parthenogenesis gives rise to haploid males, and at least one species with functional hermaphroditism. It was in the hope that the more generalized members of the group, quite unknown in life cycle and general biology, might shed some light on these and related problems that the search for the primitive coccids was begun in 1928.

Thus far we can report on two tribes of the most generalized subfamily—the Monophlebinae—of the taxonomically most primitive division of the coccids—Morrison's family Margarodidae. In the tribe *Iceryini*—to which the functional hermaphrodite *Icerya purchasi* belongs—I have studied four species of *Icerya*, one of *Crypticerya*, one of *Ecimincerya*, and one of *Steatooccus*. With the exception of *I. purchasi* none shows any trace of hermaphroditism; all have a facultative parthenogenesis resulting in haploid males. The chromosomes in all are identical in size and number, and on cytological criteria the Tribe emerges as a very real unit.

More successful from the point of view of discovering ancestral conditions has been the study of the Tribe *Llaveini*. In this group the life cycle and biology of *Protortonia primitiva* have been reported by Schrader. The present report summarized the life cycles and general cytological features of four other forms, *Llaveia bowvari*, *Llaveia oaxacoensis*, *Llaveiella taenechina*, and *Nautococcus schraderi*. Habitat, host plants, number of generations annually, mating habits, egg laying, and hibernation habit were given for each. This tribe emerges as genuinely primitive in many features. Thus there is no trace of hermaphroditism, no parthenogenesis, and a normal XX-XO sex determining mechanism is present in all the forms studied. Asynapsis of one pair of autosomes is incipiently developed in *Llaveia*; it affects more cells and both pairs of autosomes in *Llaveiella*; and suggests the kind of changes that may have brought about the complete absence of synapsis in *Protortonia* and possibly in the Pseudococcinae of the higher coccids.—SALLY HUGHES-SCHRADER, Dept. Zoology, Columbia University.

MEETING OF MAY 7, 1940

A regular meeting of the New York Entomological Society was held on May 7, 1940, in the American Museum of Natural History; President Klots in the chair with forty-nine members and visitors present.

Mr. Kisliuk, the speaker of the evening, then addressed the Society on "Scientific Contributions Made by the Staff of the Division of Foreign Plant Quarantine at the Port of New York."

The Division of Plant Quarantine of the Port of New York covers the water front, airports and surrounding territory and is staffed by 37 inspectors. Foreign mails are inspected and returned to their country of origin if dangerous. There is also inspection of American grown produce to meet foreign requirements. Mr. Kisliuk discussed the interception of certain insects at the Port of New York and passed around for inspection various papers published by the staff.

The talk was illustrated by lantern slides and supplemented by photographs.

LUCY W. CLAUSEN, *Secretary.*

MEETING OF MAY 21, 1940

A regular meeting of the New York Entomological Society was held on May 21 in the American Museum of Natural History; Vice-President Kisliuk in the chair with fifty-five members and visitors present.

The meeting was held at 6.00 P.M. and was in the nature of a social gathering following the custom of previous years in conducting the closing meeting of the season. Refreshments were served.

The business of the reading of the minutes of the previous meeting was therefore suspended.

Dr. F. Martin Brown from Colorado showed kodachromes of his recent trip to South America. He accompanied each with explanatory comments.

LUCY W. CLAUSEN, *Secretary.*

THREE PAPERS ON FLEAS

A Check List of the Fleas of the Pacific Northwest; A Review of the Fleas of the Genus Meringis with Two New Species; A Review of the Western Fleas of the Genus Malaræus with One New Species and the Description of a New Thrassis from Nevada. By C. Andresen Hubbard. Pacific University Bulletin, vol. 37, Nos. 4, 5, 6, Nov., Dec. 1940. 4 p. each.

The titles of these three papers are descriptive of their contents. The check list includes 90 species from Washington, Oregon, Northern California and Northwestern Nevada, together with a list of 27 species described from California south of San Francisco Bay. In the second paper, Dr. Hubbard reviews the genus *Meringis* and describes two new species, *M. walkeri*, and *M. jewetti*. In the third paper he reviews the western fleas of the genus *Malaræus*, and describes *Malaræus dobbsi*, and *Thrassis jellisoni*. Dr. Hubbard, whose papers on fleas have been noted previously in this JOURNAL, is head of the Department of Biology in Pacific University, Oregon.—H. B. W.

BOOK NOTICE

Plant Galls and Gall Makers. By Ephraim Porter Felt, D.Sc.
Ithaca, New York, Comstock Publishing Company, Inc.,
1940. 9 × 6 inches. viii + 364 p., 41 pl., 344 text illus.
\$4.00.

On October 27, 1732, Mr. Richard Lewis of Annapolis, Md., wrote to Mr. Collinson, F.R.S., of London, a letter which appeared in the "Philosophical Transactions" (London) in 1735 (vol. 38, p. 119-21), entitled, "A Letter Containing the Account of a remarkable Generation of Insects; of an Earthquake and of an Explosion in the Air."

The "remarkable generation of insects" involved "little bags as large as filberts" on the leaves of a "fly-tree," which, upon being cut open, yielded "red grubs and flies," much to the astonishment of Mr. Lewis, who was at a complete loss for an explanation of the phenomenon. Gall insects and plant galls are still remarkable, but after the passage of 200 years, much more is known of them and the literature about them has become extensive.

Dr. Felt's book is a totaling of the literature on the subject, and although it is a revision of his previous work, "Key to American Insect Galls" (N. Y. State Mus. Bull. 200, 1917), it, as a comparison of the two will show, has been rewritten and greatly extended by the addition of new material.

Part I (p. 4-35) deals with gall types, gall producers, the biology of gall producers, the distribution of gall insects, gall insect preferences, natural checks, the rearing of gall insects, and related subjects, the whole being an excellent introduction to the subject.

Part II (p. 39-338) is a key to the galls of various plant families, grouped first by their hosts, and later by arrangements best suited to facilitate identification. For example, the oak galls are divided into those on roots, twigs, leaves, etc., and these divisions are broken down still finer, thus making identification easier. Almost 150 pages of the book are devoted to oak galls, showing the importance of the oaks as hosts to a large and interesting gall insect fauna.

Part II is illustrated by over 700 figures, all of uniform excellence, and these in themselves frequently make identification painless.

Entomologists and teachers of nature study will find Dr. Felt's book invaluable, because it is a thorough summary of the subject into which he has incorporated the results of his own extensive studies and mature knowledge.—H. B. WEISS.

Entomophagous Insects. By Curtis P. Clausen. McGraw-Hill Book Company, Inc., New York and London, 1940. 9 × 6 in., X + 688 p., 257 figs. \$7.00.

In Brooklyn, N. Y., in 1860 there was an outbreak of the measuring worm *Ennomos subsignarius* and the Common Council passed a resolution "to free the city from the perpetually increasing measure worm nuisance" even by the removal of all infested trees from the streets. In 1862 H. A. Graef and Edward Wiebe submitted to a large committee appointed by the Brooklyn Horticultural Society, a report upon the insect, which was published during the same year. This report recommended a mapping of the infested area, scraping egg masses off the trees in winter, application of tar bands, etc. It would not be necessary to mention this report, which was received flatteringly by many persons except for the fact that Dr. Isaac P. Trimble of Newark, N. J., a member of the committee published a minority report in which he dissented from the recommendations as given. He said that it was useless to spend money because a "little fly" was destined to do the controlling. However, the rest of the committee did not believe that a parasite would be able to combat an enemy so strong and as practical men they preferred to rely upon their own exertions and refused any help from "a fanciful agency."

Approximately eighty years later or at the present time we now have a large volume on these "fanciful agencies," by Dr. Curtis P. Clausen, Principal Entomologist in Charge of the Division of Foreign Parasite Introduction of the Bureau of Entomology and Plant Quarantine of the United States Department of Agriculture. And Dr. Clausen, by experience and knowledge is particularly fitted to write conclusively upon entomophagous insects.

At one time the utilization of parasites in the control of crop pests was principally a federal activity, but now various states are

embarking upon programs of biological control, and numerous workers are engaged in the field of insect parasitology. In Doctor Clausen's book, these workers and other students will find a complete survey of the extensive literature of the world, dealing with entomophagous insects especially those which disclose a high degree of specialization in their host relationships. The entomophagous groups in all orders are covered, but the Hymenoptera being predominant in this respect occupy 50 per cent of the book, followed by the Diptera to the extent of 20 per cent. The balance is devoted to the remaining 15 orders, which contain many interesting cases of entomophagous feeding. Doctor Clausen's treatment throughout is such that it furnishes exactly the type of information needed by the worker in biological control. In the Hymenoptera, for example there is a preliminary discussion of various topics with reference to the entire order. This is followed by discussions of the various superfamilies and families, broken down under such topics as host preferences; biology and habits which include the development of all stages, the life cycle, reproductive capacity and sex ratio; effect of parasitism upon the host; description of immature stages. This method of presentation is followed throughout, for each family, except where it is not permitted because of the unavailability of certain types of information, and except where additional topics are interpolated. In this way the discussions centre about the various parasitic and predaceous species within the families.

Dr. Clausen's book is difficult to review, even in general terms, because it is packed from cover to cover with specific facts relative to the insects used in biological control, and because the author plunges immediately into his subject matter and wastes no time upon broad generalizations, except in a few instances where such treatments are desirable. The bibliography of over a thousand references, in various languages, representing only those cited in the text will give one an idea of the enormous and sustained effort that went into the writing of this book. However, the users of books seldom give a thought to the efforts that go into their making, and are interested only in the result. In this particular case the result is an excellent, and all-embracing summary of our knowledge of entomophagous species, long needed by those interested in the biological control of insects.—H. B. WEISS.

Embryology of Insects and Myriapods. By Oskar A. Johannsen and Ferdinand H. Butt. McGraw-Hill Book Company, Inc., New York and London, 1941. 9 × 6 in., xi + 462 p., 370 Figs. \$5.00.

Many entomologists, exclusive of those engaged in teaching, think of the embryology of insects only as something in which they took a course during their college years. And in later years when they have become specialists in some phase or another, embryology to most of them remains an unknown field, of which their general knowledge is vague. This condition is probably due to the comparatively few American students of insect embryology and to the unfamiliarity of American entomologists with foreign languages.

There is no longer any excuse for such incomprehension, because the present work is a reliable text in English devoted to the development of insects, centipedes and millepedes from egg deposition to hatching. It is the outgrowth of over twenty years of study, revision and critical evaluation of the literature of Europe and America. In the bibliography of approximately 875 titles, sixty-five per cent are in languages other than English.

The first twelve chapters of Part I cover the cell, embryonic development in insects, fertilization, maturation and cleavage of the egg, early development, embryonic envelopes, gastrulation, the alimentary canal, ectodermal and mesodermal derivatives, polyembryony and parthenogenesis, symbionts in the eggs and experimental embryology, in which are also presented the important opinions on debatable points.

The remaining nine chapters of Part II describe the embryonic history of various insects, representing most of the orders, and reflect the opinions of the different investigators.

Three hundred and seventy text figures add to the completeness of this authoritative and excellent book which should meet the needs of all teachers and which should stimulate interest in a subject in which it is possible to make fascinating and important discoveries, if one is equipped for a delicate, precise and high type of investigation.—H. B. W.

The New York Entomological Society

Organized June 29, 1892—Incorporated June 7, 1893

Certificate of Incorporation expires June 7, 1943

The meetings of the Society are held on the first and third Tuesday of each month (except June, July, August and September) at 8 P. M., in the AMERICAN MUSEUM OF NATURAL HISTORY, 77th Street and Columbus Avenue.

Annual dues for Active Members, \$3.00; including subscription to the Journal, \$4.50.

Members of the Society will please remit their annual dues, payable in January, to the treasurer.

Honorary President, WILLIAM T. DAVIS

Officers for the Year 1941

President, MAX KISLIUK Federal Bldg., New York, N. Y.

Vice-President, HARRY B. WEISS Highland Park, N. J.

Secretary, ANNETTE L. BACON American Museum of Natural History

Treasurer, DR. HERMAN T. SPIETH College of the City of New York, N. Y.

Librarian, L. JAMES SANFORD American Museum of Natural History

Curator, DR. WILLIS J. GERTSCH American Museum of Natural History

EXECUTIVE COMMITTEE

W. T. DAVIS

DR. ALBERT HARTZELL

DR. WM. PROCTER

DR. A. B. KLOTS

FRANK A. SORACI

PUBLICATION COMMITTEE

HARRY B. WEISS

EDWIN W. TEALE

HERBERT F. SCHWARZ

E. L. BELL

PROGRAM COMMITTEE

J. W. ANGELL

M. H. SARTOR

HAROLD HAGAN

AUDITING COMMITTEE

DR. WM. MOORE

DR. W. J. GERTSCH

F. S. BLANTON

FIELD COMMITTEE

DR. A. B. KLOTS

A. S. NICOLAY

WM. P. COMSTOCK

DELEGATE TO THE N. Y. ACADEMY OF SCIENCES

WILLIAM T. DAVIS

JOURNAL

of the

NEW YORK ENTOMOLOGICAL SOCIETY

Published quarterly by the Society at N. Queen St., and McGovern Ave., Lancaster, Pa. All communications relating to manuscript for the Journal should be sent to the Editor, Harry B. Weiss, 19 N. 7th Ave., Highland Park, New Jersey; all subscriptions to the Treasurer, Dr. Herman T. Spieth, American Museum of Natural History, New York, N. Y. Orders for back issues should be sent to the Librarian, L. James Sanford, American Museum of Natural History, 77th St. and Columbus Ave., New York, N. Y. The society has a complete file of back issues in stock. The Society will not be responsible for lost Journals if not notified immediately of change of address. We do not exchange publications.

Terms for subscription, \$3.00 per year, strictly in advance.

Please make all checks, money-orders, or drafts payable to New York Entomological Society.

Twenty-five reprints without covers are furnished free to authors. Additional copies may be purchased at the following rates:

	4 pp.	8 pp.	12 pp.	16 pp.	24 pp.	32 pp.
25 copies	\$2.40	\$5.22	\$5.58	\$5.58	\$9.00	\$9.60
Additional 100's60	1.44	1.92	1.92	3.00	3.00
Covers	50 copies, \$2.00; additional 100's, \$1.50.					
Half-tone prints 1½ cents for each half-tone print.						

Authors whose papers are illustrated with text figures or full page plates will be required to supply the electroplates or pay the cost of making the same by the Journal and also to pay the cost of printing full page plates on coated paper, when advisable.

JUNE, 1941

Journal

of the

New York Entomological Society

Devoted to Entomology in General

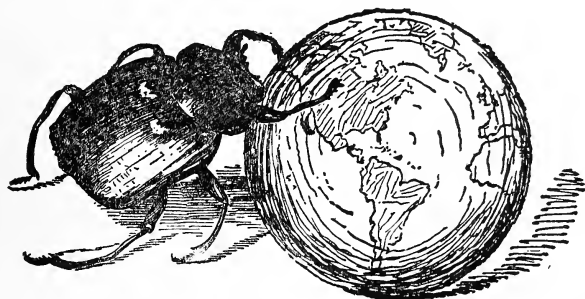

Edited by HARRY B. WEISS

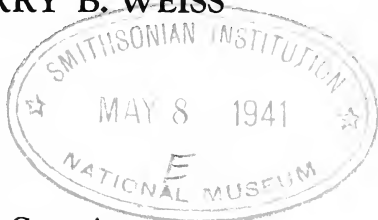

Publication Committee

HARRY B. WEISS
HERBERT F. SCHWARZ

EDWIN W. TEALE
E. L. BELL

Subscription \$3.00 per Year

Published Quarterly by the Society
N. QUEEN ST. AND McGOVERN AVE.
LANCASTER, PA.
NEW YORK, N. Y.

CONTENTS

Ten New Species of <i>Stelis</i> from California (Hymenoptera: Apoidea) By P. H. TIMBERLAKE	123
Hibernation of <i>Mylocerus castaneus</i>	138
Records and Descriptions of Neotropical Crane-Flies (Tipulidæ, Diptera), XII By CHARLES P. ALEXANDER	139
Additional Notes on the Behavior of Certain Insects to Different Wave-Lengths of Light By HARRY B. WEISS, FRANK A. SORACI AND E. E. MCCOY, JR.	149
An Undescribed American <i>Cephenemyia</i> By CHARLES H. T. TOWNSEND	161
Biological and Faunistic Notes on the Cicadidæ of the Big Bend Region of Trans-Pecos, Texas By E. R. TINKHAM	165
Charles W. Leng By JOHN D. SHERMAN, JR.	185
Charles W. Leng and the New York Entomological Society By WM. T. DAVIS	189
Two New Subspecies of <i>Phlebodes Tiberius</i> Moeschler By E. L. BELL	193
Communal Disaffection in Ants By LAURENCE J. LAFLEUR	199
A Method for Obtaining Spores of the Fungus <i>Beauveria Bassiana</i> (Bals.) Vuill. in Quantity By E. E. MCCOY AND C. W. CARVER	205
Note on the Method of Colony Foundation of the Ponerine Ant <i>Bothroponera Soror</i> Emery By CARYL P. HASKINS	211

NOTICE: VOLUME XLIX, NUMBER 1, OF THE JOURNAL OF THE NEW YORK ENTOMOLOGICAL SOCIETY WAS PUBLISHED ON MARCH 12, 1941.

Entered as second class matter July 7, 1925, at the post office at Lancaster, Pa., under the Act of August 24, 1912.
Acceptance for mailing at special rate of postage provided for in Section 1103, Act of October 3, 1917, authorized March 27, 1924.

JOURNAL

OF THE

New York Entomological Society

VOL. XLIX

JUNE, 1941

No. 2

TEN NEW SPECIES OF STELIS FROM CALIFORNIA (HYMENOPTERA, APOIDEA)

BY P. H. TIMBERLAKE

CITRUS EXPERIMENT STATION, RIVERSIDE, CALIFORNIA

It is becoming evident that our species of *Stelis*, especially in the Southwest, are rather numerous, but their study is hampered by the difficulty of obtaining adequate material. In this connection it is interesting to note that five of the species described here are known only from uniques.

The new species of *Stelis* made known in this paper are all from southern California. The types, except of *Stelis linsleyi*, are in the collection of the Citrus Experiment Station, Riverside, California.

***Stelis* (*Heterostelis*) *anthidioides* new species.**

A large robust bee, with extensive yellow markings, its nearest ally probably being *S. manni* Cwfd. from Arizona. It differs from that species in having the clypeus and sixth segment of abdomen yellow, and yellow bands of other segments very broad and entire.

FEMALE.—Black with light markings as follows: Mandibles, except apical margin, labrum and clypeus; supraclypeal mark much broadened in middle; lateral face marks extending almost to summit of eyes and widened below to occupy the space between antennal socket and eye; broad band on vertex and behind eyes, slightly notched in middle and broadened laterally, with a slender extension downward on cheeks to anterior end of eye, but separated from the eyes and lateral face marks by a narrow dark orbital streak; broad band on lateral and anterior margins of mesoscutum, broadly interrupted medially; axillæ and broad band on margins of scutellum, interrupted medially; tegulæ except reddish central area posteriorly; tubercles, large mark

MAY 8 - 1941

beneath tubercles and another small one below base of hind wings; apex of coxæ, most prominent on front and hind pair, and spot on trochanters; apex of femora broadly, the mark extending to middle or slightly beyond on dorsal margin, and nearly to the base on ventral edge, except on hind pair; tibæ and tarsi entirely, except a somewhat rufescent color on inner side; broad bands on tergites 1 to 6, those on 5 and 6 covering almost entire surface, those on 2 to 4 slightly notched medially in front; and venter almost entirely, all yellow. Basal declivity of tergite 1 black, and base of following segments narrowly black, but almost entirely concealed on tergites 5 and 6. Apical border of tergites 1 to 5 blackish, with the narrow apical depression somewhat reddened. This apical border broadest on tergites 1 and 2 and becoming very narrow on 5. Venter slightly stained with rufous on second segment, and the impunctate, normally concealed (but very broad) portion of segments 3 and 4 largely suffused with fuscous. Antennæ brownish black, the apex of scape on outer side slightly suffused with dull yellow. Wings dark reddish fuscous, the hind pair clearer. Nervures nearly black, the stigma reddish. Head and thorax closely, moderately coarsely punctured. Inner orbits of eyes narrowly impunctate and polished. Propodeum finely and densely punctured. Punctures of tergites a little finer than those of head and notum and nearly as close, except on 3 and 4 where they are sparser, and becoming very dense and rather obscure on 6. Apical dark band of tergites finely and densely punctured except the larger part of apical depression. Tubercles sharply carinate anteriorly, the margin broadly arcuate. Mandibles gently bisinuate on the very broad cutting edge, with faint indication of a median tooth. Labrum dull, minutely and densely punctured, and hairy. Clypeus broadly truncate in front, the margin finely crenulate. Axillæ roundly protuberant laterad. Scutellum with a shallow median groove, the apex subtruncate, the margin subcarinate. Metanotum and propodeum almost vertically declivous beneath the slightly protruding edge of scutellum. Base of propodeum without a transverse, pitted groove. Tergite 6 broadly rounded at apex, the margin erose with blunt little teeth and a much broader short tooth or lobe on each side of middle. Ventricle 6 not at all produced, triangular, the subacute apex thickened, opaquely sculptured and with a very narrow smooth lip. Pubescence ochreous, rather thin and moderately long, most abundant on cheeks, pleura, sternum and base of legs. A dense tuft of hair behind base of hind wings. Hair of mesonotum short and subappressed. Ventriles 2 to 5 with a long apical fringe. Hair on inner side of tarsi ferruginous. Length, 12 mm.; anterior wing, 9 mm.; width of abdomen, about 4.2 mm.

One female (holotype), Riverside, California, on *Hemizonia kelloggii*, June 9, 1927 (Timberlake).

The time of flight and mimetic resemblance of this bee to *Heteranthidium timberlakei* Schwarz suggests that the latter is possibly the host.

For this fine bee I propose a new subgenus of *Stelis*, to be called *Heterostelis*. From typical *Stelis* it differs in having the axillæ not toothed, although they are roundly produced outward beyond margin of scutellum; mandibles very broad on apical edge, with the usual teeth very feebly indicated; anterior edge of mesopleura very abruptly reflexed into a broad, perpendicular face, with the margin between the two surfaces carinate; basal pitted groove of propodeum obliterated, etc. From *Pavostelis* it differs in color and in having the anterior face of mesopleura broad and sharply reflexed, mandibles peculiar, axillæ roundly produced laterad, etc. From *Microstelis* it differs in the mandibles, axillæ, anterior face of mesopleura, and lack of a narrow pitted groove at base of propodeum. From *Protostelis* (*Stelis costalis* Cress. and allies) it differs in the mandibles, axillæ, lack of a broad pitted groove at base of propodeum and in having the sharp anterior edge of tubercles not continued inward beyond the anterior corners of mesoscutum, but it agrees closely in the sharply reflexed anterior face of mesopleura. From *Chelynia*, *Melanostelis* and *Stelidium* it differs in venation and other characters, the second recurrent nervure being received on the cubitus well beyond the apex of second cubital cell.

Other peculiar features shown by the type species are the dull, finely and densely punctate and hairy labrum, erose apical margin of the sixth tergite and the comparatively elongate maxillary palpi. These palpi have two (or possibly three) joints, the apical joint being elongate spindle-shaped, with the thinner apical portion possibly forming another segment, although this can not be verified without a slide preparation.

Other species probably belonging to *Heterostelis* are *Stelis australis* Cresson and *S. manni* Crawford.

Genotype.—*Stelis anthidioides* Timb.

***Stelis* (*Pavostelis*) *anthracina* new species.**

This is a rather small, entirely black bee, with whitish pubescence. From *S. diversicolor* Cwfd. it differs in being rather dull black, with no indication of hair-bands on abdomen.

MALE.—Robust, somewhat dull black, without ornamentation. Mandibles with a red band before the apex. Small joints of tarsi rufescent, but spurs, tegulæ, and antennæ black. Wings a little dusky, with a darker stain at apex and on outer half of marginal cell. Nervures and stigma almost black.

Head distinctly narrower than thorax, about as broad as long. Inner orbits of eyes slightly converging below. Mandibles with three subequal acute teeth. Maxillary palpi one-jointed, the joint about four times as long as thick. Clypeus gently convex, broadly truncate in front, the margin with a fine median notch and sometimes with minute notches on each side. Tubercles rather small, with the front margin somewhat arcuate and sharply carinate, but the carina not extending mesad farther than the corners of scutum. Margins of axillæ and scutellum continuous, the apex of scutellum rounded. Disk of scutellum without median furrow, but basal margin foveately impressed as usual. Pitted groove at base of propodeum very narrow and shallow, distinct only at sides, and more or less obliterated in middle. Punctures of head and thorax close and moderately coarse, becoming sparser on mesopleura. Clypeus dull, finely and densely punctured. Labrum polished, almost impunctate. Metapleura and propodeum finely and closely punctured, but bowl-shaped enclosure of propodeum impunctate, except that it is variably more or less punctured above. Punctures of abdomen close, considerably finer than those of mesonotum, and becoming slightly coarser caudad. Second ventrite closely punctured, but exposed parts of following segments almost impunctate. Pubescence dull whitish, moderately dense and erect on head and thorax, that of the abdomen shorter, mostly sub-appressed, inconspicuous in most aspects, and without indication of apical bands. Ventrites 3 and 4 with a dense apical fringe of ochreous hair, that of 4 broadly interrupted in middle. Ventrite 4 also with an apical comb of short, black, very close set, minute teeth, covering a little more than the middle half and overlapping the inner ends of the hair fringe. Length, about 7 mm.; anterior wing, 5.6 mm.; width of abdomen, about 2.8 mm.

Four males (holotype and paratypes) collected at Andreas Canyon, near Palm Springs, California, on *Encelia farinosa*, three including the holotype on March 24, 1933, and one on April 11, 1936 (Timberlake). Also one male (paratype) in Michener's collection, taken by him at the same place and on the date last mentioned.

A male *Stelis* from Raleigh, North Carolina, on *Rubus*, May 5, 1934 (T. B. Mitchell) in Michener's collection, must be referred to *S. diversicolor* Cwfd. This specimen differs from *anthracina* in being a little more shiny and less closely punctured, the punctures of mesoscutum mostly about a puncture width apart (mostly less than half a puncture width in *anthracina*), and in having the hair of abdomen considerably longer and a little sparser, the hair forming a thin fringe at apex of tergites, but not a distinct band. These North Carolina and California bees are so similar that it is easy to suppose that they are races of one species, which indeed may be the case, unless the females, when discovered, exhibit more distinctive characters.

These bees agree structurally with the subgenus *Pavostelis* Sladen and it is necessary to conclude that the blue color of the type species is not of especial importance in distinguishing the group. Except in venation, *Pavostelis* is similar to *Chelynia* in many ways.

Stelis (Chelynia) semirubra new species.

Black, without ornamentation, the abdomen mainly red. There is no other species of this group known with a red abdomen.

FEMALE.—Moderately slender. Head and thorax black, the abdomen red. Triangular mark at base of first tergite, sixth tergite except the base narrowly on each side, and sixth ventrite, black. Fifth ventrite suffused with black except at apex. Antennæ, tegulæ and legs black. Spurs pale brownish. Mandibles black, stained with red before the apex. Wings dusky, the outer half of marginal cell more deeply stained. Nervures and stigma black. Head somewhat wider than long and a little narrower than thorax. Inner orbits of eyes converging below. Mandibles with subequal acute teeth. Maxillary palpi one-jointed, the joint small and spindle shaped. Clypeus broadly truncate anteriorly, the margin denticulate. Tubercles not enlarged nor sharply margined in front. Outer margin of axillæ and scutellum continuous, the latter rounded at apex. Metanotum and propodeum strongly declivous, the base of the latter with traces of a pitted groove laterally. Tergites 1 to 4 moderately impressed at base. Tergite 6 broadly rounded at apex, with a very narrow, smooth, marginal lip. Ventrite 6 barely exceeding the tergite, rounded at apex and without an obvious lip. Head and thorax moderately finely, closely punctured, and shining between the punctures. Clypeus dull, very finely and densely punctured. Labrum closely punctured except at base. Punctures of mesoscutum mostly about one-half to one puncture width apart. Punctures of posterior face of propodeum nearly as coarse as those of mesonotum, but those on the sides and on metapleura much finer. A shallow bowl-shaped area on propodeum polished and impunctate. Punctures of abdomen close, finer than those of mesonotum, and becoming finer and dense on the apical tergite. Venter very finely and densely punctured, the apical segment opaque. Pubescence white, rather short and moderately dense, most abundant on the face. Hair of abdomen short, fine and inconspicuous in most aspects. Tergite 6 and ventrites 2 to 5 with a very short, dense, pale, apical fringe. Disk and apex of ventrite 6 with dense short pubescence. Length, 7 mm.; anterior wing, 4.4 mm.; width of abdomen, 2.3 mm.

One female (holotype), trail above Glen Ivy, Riverside County, California, on *Eriophyllum confertiflorum*, var. *trifidum*, May 13, 1928 (Timberlake).

Stelis (Chelynia) depressa new species.

An entirely black species, except for a creamy white fascia on tergites 1 to 5, similar to *S. interrupta* Cresson, but a little larger, with wings uni-

formly dusky and hair of vertex and notum white, intermixed with long black hairs (hair on these parts black and sparse in *interrupta*). *S. interrupta* was very briefly described and a comparison with the type will be necessary to show whether *depressa* has other and more substantial differences.

FEMALE.—Form robust. Black, but tergites 1 to 5 each with a narrow, creamy white fascia, not quite reaching the lateral margins. Each fascia moderately widely interrupted medially and those on 3 and 4 interrupted sublaterally. Fascia on 1 and 2 emarginate behind on each side, the width of the emargination about equaling the width of the medial interruptions and also the lateral interruptions on following segments. Median pair of white marks on tergites 3 to 5 becoming shorter on each successive segment, those on the fifth being the sole remnants of the fascia of that segment. Wings strongly dusky, the nervures black. Head barely wider than long and not quite equaling width of thorax. Clypeus depressed, the apex broadly truncate, the margin finely toothed. Mandibles tridentate, the two inner teeth equal, well separated and much smaller than apical tooth. Labrum about one and one-half times longer than wide and broadly truncate at apex. Tubercles obscurely carinate on anterior margin. Propodeum sharply declivous, the pitted basal groove obliterated except far to the sides, as usual in *Chelynia*. Abdomen ovate, convex at base and strongly depressed toward apex. Tergite 6 much broader than long, rounded at apex, but not evenly, as there is a slight inward curve on each side. Ventrite 6 distinctly but not greatly exceeding the tergum, subangular at apex, the angle distinctly greater than a right angle. Exposed dorsal lip of ventrite 6 narrow, finely and densely pubescent except on inner margin. Head and thorax closely and moderately finely punctured, the punctures dense on frons, and finer and dense on clypeus. Punctures of mesoscutum mostly less than a puncture width apart, those of the mesopleura no sparser except just above the middle coxæ. Upper portion of metapleura and sides of propodeum with finer, shallow, crowded punctures. Propodeum with a large polished bowl-shaped area, otherwise closely punctured, and finely punctured and dull across the base between the lateral pits. Abdomen more shining, closely and considerably more finely punctured than mesoscutum. Venter dullish, finely and densely punctured. Pubescence white, long and rather dense on face, cheeks and pleura, and much shorter and thinner on mesonotum except around the margins. Face, vertex and mesonotum with numerous long erect fuscous or black hairs intermixed, the cheeks with a few similar hairs. Abdomen with very fine appressed pale pubescence and short erect black hairs, which are numerous on apical tergite and become gradually sparser on successive segments toward the base. Venter with rather dense, fine pubescence, forming a very short fringe at apex of segments. Length, 7 mm.; anterior wing, 5.5 mm.; width of abdomen, 2.6 mm.

MALE.—Similar to female. Fascia on tergites 2 to 5 usually interrupted sublaterally as well as medially, tergite 5 having a small spot on each side, that is always absent in the female. Venter shining, the second segment

with minute, not very close punctures. Disk of ventrite 3 with a broad concave depression in the middle, the apical protuberance in the form of a small tooth. Apical comb on ventrite 4 narrow, with a raised margin on the disk just above and before it. Ventrite 5 with a broad angular emargination and a deep broad impression medially. Ventrite 6 with a much narrower median impression or furrow. Pubescence whitish, intermixed with fuscous hairs on frons, vertex and mesonotum, and a few dark hairs along inner orbits. Hair of abdomen sparse and mainly black, except on first tergite. Second ventrite without an apical fringe. Apical fringe of ventrites 3 and 4 dense but abbreviated, pale fulvous and interrupted on 4 by the comb. Length, 6.5 mm.; anterior wing, 5 mm.; width of abdomen, 2.7 mm.

The female varies from 6.5 to 7.5 mm. and the male from 6 to 7 mm. in length. The fasciæ on tergites 2 and 3 may be emarginate behind or broken sublaterally in the female. In the male the fascia on tergite 1 is emarginate behind on each side, that on 2 either broken or emarginate sublaterally, and those on following segments interrupted sublaterally, except on one side of 3 in one specimen.

Holotype female, allotype, three male and three female paratypes, on flowers of *Cryptantha micrantha*, var. *lepida*, Santa Rosa Peak, 7500 feet, Santa Rosa Mountains, California, June 8, 1940 (Timberlake and Michener); and one female (paratype), 2 miles north of Palm Springs, on *Hyptis emoryi*, March 7, 1936 (Timberlake). Four paratypes have been returned to Mr. Michener.

Stelis (Chelynia) linsleyi new species.

Allied to *S. subemarginata* and *S. monticola* of Cresson. It differs from *subemarginata* in having thorax and abdomen shining, with punctures well separated, the abdominal bands pale yellow, rather broad, strongly and moderately broadly emarginate behind on each side. From *monticola* it differs in the elongate, somewhat tapering abdomen and in the broad abdominal fasciæ.

FEMALE.—Thorax robust, appearing unusually broad through the mesopleura, on account of the much narrower head and abdomen. Black, except for a broad, pale yellow band on tergites 1 to 5. Band on tergites 1 and 2 constricted at the middle, those on 3 to 5 narrowly interrupted medially, and all moderately broadly and distinctly emarginate on each side behind. Band on tergite 1 and 2 distinctly broadened at outer ends, and the inner ends of the halves on 5 much broader than the outer ends. Claws red, and a small red area on mandibles just before the apex. Tibial spurs, tegulæ and antennæ dark. Wings strongly and nearly uniformly dusky, the venation blackish. Clypeus convex, finely and densely punctured, its margin broadly truncate, finely crenulated. Frons, vertex and cheeks finely and very closely punctured. Punctures of mesoscutum slightly coarser than those of frons and much sparser, mostly about one to two puncture widths apart. Punctures of scutellum distinctly coarser and closer than those of scutum.

Mesopleura closely punctured like cheeks. Propodeum finely and closely punctured except enclosure, which is more shiny and in the form of a short-stemmed Y, with flaring arms. Tegulæ large, shining, finely and moderately closely punctured. Abdomen elongate, rather slender and tapering, much longer than head and thorax together, broadest across the first segment and strongly convex above toward base. Tergites shining, finely punctured, the punctures mostly about one to two puncture widths apart, and considerably sparser on the pale fasciæ. Apical tergite large, almost as long as broad, rounded at apex, its disk gently convex, becoming depressed at apex, its puncturation similar to that of preceding segments, but becoming finer, obscure and crowded on apical border. Venter finely, very closely and uniformly punctured. Apical ventrite subangular at apex, slightly produced beyond tergum, so that the apical lip is exposed, which is densely covered with fine pile. Pubescence whitish, rather dense on face, cheeks and pleura, and short, sparser and mostly appressed on vertex and mesonotum. Hair of legs very short and whitish, becoming pale ferruginous brown on inner side of tarsi. Hair of abdomen mostly pale brownish, fine, short, mostly appressed, with a few somewhat longer erect hairs along the sides and at apex. Venter with fine appressed very short pubescence, which is much denser than that of tergum. Length, 10 mm.; anterior wing, 6.5 mm.; length of abdomen, 6.5 mm.; width of abdomen at base, 2.5 mm.

One female (holotype), Idyllwild, San Jacinto Mts., California, June 4, 1939 (E. G. Linsley), in the collection of Dr. Linsley.

Stelis (Stelidina) trichopyga new species.

Allied to *S. hemirhoda* Linsley but larger, the abdomen much less red, the apical ventrite broadly rounded at apex, with a little nipple-like median lobe, the disk of apical tergites with coarse erect reddish hairs, apical margin of last segment with a short dense fringe, and maculations of abdomen more yellowish.

FEMALE.—Head and thorax black, without maculations, except that the tubercles are rufo-testaceous. Tegulæ bright ferruginous. Labrum reddish on lateral margins. Mandibles black at base, rufo-testaceous in middle and piceous at apex. Antennæ black, the flagellum slightly brownish. Legs black, the knees, apex of tibiæ, apex of tarsal joints and claws red, the base of tibiæ with a small yellowish spot. Spurs testaceous. Abdomen black, considerably reddened on margins of tergites, especially on basal segments. Depressed apical margin of tergites rufo-testaceous, becoming red on each side. Apex of tergite 6 narrowly red. Tergites 1 to 3 each with a narrow pale yellow subapical fascia, slightly narrowed medially in front on 2 and 3, subinterrupted far to each side by red on 1 and interrupted by red and black on 2 and 3. Tergites 4 and 5 with only the median portion of the fascia, which is much abbreviated on 5 and more broadly constricted medially in front on 4 than on the preceding segments. Ventral segments broadly rufo-testaceous at apex, becoming more reddish at sides, the black band at base of ventrites 2 and 3 not reaching the lateral margins. Ventrite 1 en-

tirely red and ventrite 6 entirely black. On the tergum the margins between the black and yellow markings suffused with red. Wings strongly and almost uniformly infuscated. Nervures blackish. Head broader than long and as broad as thorax. Inner orbits strongly converging below. Mandibles tridentate, the outer tooth largest. Tubercles flattened at apex, but not especially sharp-edged anteriorly. Margins of axillæ and scutellum continuous, the scutellum slightly angulated at apex. Metanotum and face of propodeum sharply declivous, the propodeum without a pitted impression at base. Abdomen broad, subdepressed. Tergite 6 broader than long and broadly rounded at apex. Apical ventrite slightly exceeding the tergum, broadly rounded at apex and with a small nipple-like lobe in the middle. Head and thorax moderately shiny, finely and closely punctured. Punctures of frons and vertex dense, those of clypeus finer and slightly separated. Punctures of mesoscutum less than a puncture width apart, those of mesopleura a little coarser and sparser. Sides of propodeum more obscurely punctured, the punctures very fine and dense. Bowl-shaped area of propodeum shining, impunctate, except that it is finely, shallowly punctured on the basal margin. Tegulæ minutely and sparsely punctured. Abdomen closely punctured, the punctures slightly finer than those of mesoscutum. Apical ventrite minutely and densely punctured. Pubescence of head and thorax white, subappressed, moderately long, thinner than in *hemirhoda*, but moderately dense on face. Hair of vertex and mesonotum much shorter, slightly tinged with dull ochraceous. Pubescence of abdomen fine and short, the hairs becoming more plumose and whiter on apical segments. Apical margin of segments 1 to 5, both dorsally and ventrally, with a short, rather dense fringe of white plumose hair, very broadly interrupted in middle on tergites 1 and 2 and also more or less on 3. Disk of tergites 3 to 6 with many long coarse suberect reddish hairs, most abundant apically, and becoming shorter and sparser on the more basal segments. Apex of tergite 6 and ventrite 6 densely fringed with fine, simple, pale brownish ochraceous hair, which is about twice as long as the small median lobe of the ventrite. Length, 5 mm.; anterior wing, 3.9 mm.; width of abdomen, about 1.9 mm.

One female (holotype), flying over ground, Riverside, California, May 7, 1937 (Timberlake), and one female (paratype), flying over ground, the Gavilan, Riverside County, April 18, 1940 (Timberlake).

This species and the one following belong to the group recently treated by Linsley (1939, Ent. News, 50, p. 250-255). This group I propose to treat as new subgenus of *Stelis* under the name *Stelidina*, with *Stelis hemirhoda* Linsley as the genotype. *Stelidina* differs from *Stelidium* Robertson in having no pale maculations on the head and thorax, except that the tubercles may be rufotestaceous, and in having the tegulæ bright ferruginous, without a white spot, and base of propodeum with only a trace of a pitted transverse impression. From *Chelynia* Provancher the species

of *Stelidina* differ in their small size, although the form is robust, and in having the hind basitarsi not much thickened. *Chelynia* always has the head and thorax immaculate, but the tegulæ are never ferruginous. Although *Stelidina* has not much structural basis to distinguish it from *Chelynia* and *Stelidium*, it forms, however, a compact, easily recognizable group, and probably has had a somewhat different phylogeny.

Stelis (Stelidina) nigriventris new species.

This is even more similar to *S. hémirhoda* than is *S. trichopyga*, but differs in having the abdomen black, with apical margin of tergites testaceous, the white fasciæ thrice interrupted on tergites 2 to 5 and interrupted on middle of 1. Tergite 6 also has two apical white spots. The apical white fringe of the tergites is lacking except laterally on the basal segments, although possibly worn off in the type, and ventrite 6 is more broadly and evenly rounded at apex.

FEMALE.—Black. Mandibles broadly rufo-testaceous in middle. Flagellum brown beneath. Tegulæ clear pale ferruginous. Extreme apex of femora and tibiæ on outer side, and apex of tarsal joints, rufous. Spurs pale yellow-testaceous. Depressed apical border of tergites 1 to 5 and a corresponding apical band on ventrites 1 to 5, testaceous, becoming rufo-testaceous on lateral margins of abdomen. Tergites 1 to 5 with a subapical yellowish-white fascia, interrupted medially (rather broadly on 2 and 3) and also laterally on 2 to 5. Fascia on 1 broadened toward the sides and deeply emarginate behind sublaterally. The four white marks on tergites 2 and 3 subequal. Lateral spots on 4 and 5 smaller than the submedian marks. Tergite 6 with a pair of small roundish yellowish-white spots close to the median line and apex. Wings dusky, nervures black. Head as broad as thorax and slightly broader than long. Inner orbits converging below. Apical tooth of mandible slightly larger than other two. Margin of axillæ and scutellum forming a broad curve. Metanotum and propodeum sharply declivous beneath apex of scutellum. Base of propodeum shining, with three or four short longitudinal carinæ on each side, and the middle broadly dulled by fine close striate punctures. Abdomen subovate, convex above. Tergite 6 rounded at apex. Ventrite 6 not exceeding the tergum and broadly and evenly rounded at apex. Head and thorax moderately shining, finely and closely punctured, the punctures a little coarser on frons, vertex and mesopleura, and finer and sparser on sides of propodeum. Propodeum with a large polished bowl-shaped area. Abdomen finely and closely punctured, the punctures nearly uniform on tergum, and becoming increasingly finer and denser on apical ventrites. Pubescence of head and thorax white, moderately long, subdepressed, and thickest on the face, cheeks, mesopleura and apex of scutellum. Disk of mesoscutum and the venter with short, thin hair. Abdomen with very short fine pale pubescence. Apical white fringe of tergites lacking except laterally on first two segments. Apical margin

of the tergite and ventrite of segment 6 with fine dense simple hairs, forming a very short fringe. Apex of marginal cell more pointed than in *hemirhoda* and less receding from the margin. Second recurrent nervure also received closer to apex of second submarginal cell. Length, 4.75 mm.; anterior wing, 3.3 mm.; width of abdomen, 1.2 mm.

One female (holotype), collected 10 miles south of Adelanto, San Bernardino County, California, May 3, 1939 (Timberlake). It was flying about a small stick on the ground.

Stelis (Stelidium) ashmeadiellæ new species.

This and the two following species differ from *Stelidiella* in having pale markings on the head and thorax, ocelli usually much smaller, and base of propodeum with a narrow, transverse, pitted groove. *S. ashmeadiellæ* may be known from the other species of *Stelidium* by having two or three yellowish-white marks on the clypeus.

FEMALE.—Black, with creamy white markings as follows: A large oval oblique mark on each side of clypeus; stripe on inner orbits much dilated below next to the clypeus; transverse band on occipital margin of vertex, widened behind summit of eyes, otherwise narrow and sub-interrupted medially; large oval mark on each side of anterior margin of mesoscutum, and a short line on each lateral margin opposite tegulæ; spot on axillæ and line on apical margin of scutellum on each side; tubercles and large semicircular mark on tegulæ; spot at base of all tibiæ; subapical fasciæ on tergites 1 to 5, and two subapical dots on tergite 6. The white fasciæ of abdomen almost reaching lateral margins, all emarginate anteriorly on each side, and decreasing in width on successive segments caudad. Emarginations of fasciæ of tergite 1 deep and rounded, those of following segments becoming successively broader and shallower, those on tergites 4 and 5 being as broad as, or broader than, the median portion of fasciæ. Mandibles reddish, the base broadly suffused with black and the apical teeth black. Flagellum slightly reddened beneath. The central boss and inner margin of tegulæ reddish-piceous, the extreme outer margins testaceous. Joints 3 and 4 of tarsi and apex of joints 1 and 2 dark reddish. Spurs yellow-testaceous. Very narrow apical depression of tergites 1 to 5 testaceous. Wings dusky hyaline, the nervures blackish. Head as broad as long and about equaling thorax. Clypeus finely denticulate apically. Apical tooth of mandible much larger than the other two teeth. Ocelli small. Tubercles inconspicuously carinate in front. Axillæ much more discrete than in species of *Stelidiella*, but continuous on outer margin with the scutellum, which is rounded at apex. Propodeum sharply declivous, the basal groove distinct, narrow and divided into small pits by carinate plicæ. Abdomen elongate-ovate, subconical, strongly convex above. Apical tergite depressed and flattened on apical third, and rounded at apex. Sixth ventrite distinctly produced beyond apex of tergum and narrowed to a rather broad subtruncate apex, which is very slightly notched medially. Head and thorax closely and rather finely punctured. Punctures of clypeus finer and dense, those of mesoscutum and mesopleura

coarser than elsewhere and a little more separated. Labrum with a triangular impunctate space on basal half. Abdomen about as finely and closely punctured as frons. Dorsal exposed lip of ventrite 6 minutely densely punctured at base and polished around the margin. Pubescence pale brown or brownish-ochreous on vertex and mesonotum, paler on remainder of face and whitish on cheeks and pleura. Hair thin and rather short, becoming longer and denser on middle of face, cheeks, pleura, apex of scutellum, and in a tuft behind base of hind wings. Hair of abdomen short, thin and depressed, the apex of the tergites with a very weak fringe. Ventrite 1 with long whitish hair. Ventrites 2 to 5 with an apical fringe, which is long, rather thin and pale ochreous on 2 and becomes successively shorter, denser and browner on following segments. Length, 5.5 mm.; anterior wing, 3.7 mm.; width of abdomen, 1.8 mm.

Paratype female (Santa Monica).—Larger. Clypeus with three white marks conjoined anteriorly, leaving the base black with two forward directed prongs. Band on vertex less narrowed in middle and entire. Tergite 6 more sparsely punctured at base. Its disk depressed throughout, with the outline in profile straight from base to apex. Two white spots on tergite 6 much larger. Length, 6.5 mm.; anterior wing, 4.3 mm.; width of abdomen, 2.3 mm. Another female (West Los Angeles) is more similar to type, except that the clypeus is marked as in the Santa Monica specimen. Band on vertex more broadly interrupted than in type. Spot at base of hind tibia reaching to the middle.

MALE.—Similar to female but smaller. Clypeus with a broad trilobed white band as in paratype female, except that the median lobe extends no further basad than the other two. Band on vertex broadly interrupted in middle. Anterior emarginations of the abdominal fasciæ subequal from one segment to the next. Puncturation similar. Pubescence pale ochraceous on face and mesonotum and not appreciably denser on the pleura than on the notum. Disk of first three ventrites with moderately short and abundant pale ochreous plumose hair. Ventrites 2 to 4 with an apical pale fringe, slightly shorter and broadly interrupted on the middle of 4. The middle of apical margin of ventrite 4 occupied by a shining black arcuate corneous structure, with a broad raised margin. Length, 5 mm.; anterior wing, 3.5 mm.; width of abdomen, 1.6 mm.

One female (holotype) reared from nest of *Ashmeadiella californica* (Ashm.) in a pithy weed stem, collected in the Puente Hills, near Whittier, California, Feb. 25, 1928, and found issued and dead on May 12 (Timberlake); one female (paratype), Santa Monica, June 30, 1935 (E. G. Linsley); one female (paratype), West Los Angeles, July 14, 1930 (C. H. Michener); one male (allotype), Riverside, on *Gutierrezia californica*, May 26, 1928 (Timberlake).

The paratype females are in the collections of Messrs. Linsley and Michener.

***Stelis (Stelidium) palmarum* new species.**

This differs from allies in having labrum and tegulae ferruginous, the apex

of clypeus red, tergite 6 with suberect bristle-like red hairs and ventrite 6 rather small, but shortly exceeding the tergum, and acute at apex.

FEMALE.—Black, marked with creamy white as follows: Stripe on inner orbits, reaching middle of frons and gradually widened below; transverse elongate mark behind each eye, widely separated from its fellow; two transverse spots on anterior margin of mesoscutum; small spot on lateral margin of axilla and scutellum on each side; spot at anterior end of tegulae and spot on tubercles; short line at base of all tibiae; and fascia on tergites 1 to 5. Abdominal fasciae subapical, almost reaching to lateral margins, that on tergite 1 roundly and deeply emarginate in front on each side, with mouth of emargination much constricted. Emargination of following fasciae successively broader, and quite or almost breaking through, with the lateral more or less isolated spot becoming successively smaller. Median portion of fascia on tergites 2 to 4 narrowed in middle. Fascia on 5 represented by only a short narrow line on middle of disk. Narrow depressed apical margin of tergites 1 to 5 testaceous, that of 6 dark red. Ventrites 2 to 5 with a narrow subapical rufo-testaceous band. Ventrite 6 dark red, dusky at base. Mandibles with a dark red band before apex. Apical margin of clypeus red. Labrum reddish-ferruginous. Tegulae bright ferruginous. Flagellum dark reddish. Apex of femora and tibiae narrowly, and tarsi in large part, except most of hind basitarsi, dark red. Wings slightly infuscated, slightly darker in marginal cell. Head as broad as long and equaling thorax in width. Ocelli about as large as in *S. hemirhoda*. Inner orbits converging below. Two inner teeth of mandible much smaller than apical tooth. Tubercles with a testaceous carinate margin. Axillae subdiscrete and continuous with margin of scutellum, the latter subacutely rounded at apex. Propodeum sharply declivous, with a narrow, pitted groove at base. Abdomen ovate, convex. Tergite 6 convex, rounded and with a smooth narrow depressed marginal lip at apex. Ventrite 6 rather small, triangular, with apex a little blunt and shortly produced beyond tergum. Head and thorax rather finely and closely punctured, the punctures finer and closer on clypeus and sides of propodeum. Truncation of propodeum mainly polished, with a few scattered punctures, mainly toward the sides. Puncturation of abdomen similar to that of mesonotum, but becoming successively finer on apical ventrites, that on the last extremely fine and dense. Pubescence white, rather thin and short, becoming a little denser on middle of face, cheeks, pleura and apex of scutellum. Basal tergites with a thin apical fringe on each side. Ventrites 2 to 5 with a rather dense, white, apical fringe, long on 2 and much shorter and denser on 5. Disk of ventrite 6 and exposed dorsal surface of its lip dull and densely covered with an extremely fine short pale pile. Sides of the tergum with rather long, sparse, erect, pale hairs, those on apical part of tergite 6 more bristly and red. Length, 5 mm.; anterior wing (badly frayed), about 3.6 mm.; width of abdomen, 1.9 mm.

One female (holotype) collected at Andreas Canyon, near Palm Springs, California, on *Cryptantha intermedia*, April 23, 1933 (Timberlake).

Stelis (Stelidium) robertsoni new species.

Distinguishable from *S. ashmeadiellæ* by having the clypeus immaculate and the abdomen more conical toward apex, with the exposed lip of the last ventrite very broad. From *S. palmarum* it differs in the conical abdomen, with the last ventrite strongly produced. Without much doubt it is closely related to *S. trypetina* (Robt.) and *S. permaculata* Ckll., but differs in having white spots on mesoscutum, axillæ, tegulæ, tubercles and base of tibiæ.

FEMALE.—Black, with creamy white markings as follows: Line on inner orbits, reaching middle of frons and rather abruptly dilated below; short line behind summit of each eye; dot on each side of anterior margin of mesoscutum; dot on each axilla; spot at anterior end of tegulæ and at apex of of tubercles; dot at base of four anterior tibiæ and a more elongate spot at base of hind pair; four subapical marks on each of tergites 1 to 3, and a small subapical spot far laterad on each side of tergite 4. Tegulæ and labrum ferruginous. Mandibles strongly reddened, black at apex and suffused with black at base. Flagellum reddened beneath. Extreme apex of femora and of basal joint of tarsi, and small joints of tarsi, dark red. Spurs pale testaceous. Narrow depressed apical margin of tergites slightly testaceous. Ventrite 6 strongly reddened at sides and broadly at apex, the exposed dorsal lip rufo-testaceous. Wings dusky hyaline, the infuscation slightly deeper on costal margin of apical half of wing. Head as broad as long and nearly equaling width of thorax. Mandibles tridentate, the two inner teeth small and equal. A small fovea on sutural margin of clypeus on each side above (not noticed in allied species). Ocelli very small. Tubercles slightly carinate on anterior margin. Axillæ continuous with margin of scutellum, which is rounded at apex. Propodeum sharply declivous, the base with a well developed narrow pitted groove. Abdomen conic-ovate, convex above. Tergite 6 depressed on disk, subacutely rounded at apex. Ventrite 6 strongly produced, somewhat narrowed to the rather broad subtruncate apex, which is very slightly emarginate in middle. Exposed dorsal lip of ventrite 6 about twice as broad as in *S. ashmeadiellæ*.* Head and thorax moderately finely and closely punctured, the punctures finer on cheeks and sides of propodeum and sparser on mesopleura. Clypeus minutely and densely punctured. Labrum densely and finely punctured except in a depressed polished triangular area on basal half. Posterior face of propodeum polished, with a few scattered punctures laterally. Abdomen punctured much like the mesonotum, the punctures a little sparser on last two tergites. Last two ventrites much more finely and rather densely punctured, the punc-

* Cockerell in his report on the type of *S. ontariana* Sladen (1922, Can. Ent., 54, p. 143) complains that he is unable to find the subapical carina of the last ventral segment, which was stated by Robertson to be present in *S. trypetina*. Dr. Cockerell searched for this carina on the ventral surface, whereas the carina, that Robertson had in mind, is evidently on the exposed dorsal surface of the sclerite and constitutes the basal boundary of what is called the dorsal lip in this paper.

tures disappearing on apical margin of the sixth. Pubescence whitish, rather thin and moderately long, not appreciably denser on pleura than on notum of thorax, but distinctly denser on middle of face than on vertex. Hair of clypeus rather dense, subappressed, but not concealing surface, becoming brownish-ochreous on anterior border. Hair of abdomen short, thin, subappressed, with a thin apical fringe on sides of first two tergites. Ventrite 1 densely hairy at apex. Ventrites 2 to 5 each with an apical fringe, rather thin and long on 2 and successively shorter and denser on following segments. Length, about 5.5 mm.; anterior wing, 3.5 mm.; width of abdomen at base, 1.7 mm.

Paratype female.—Differing from holotype in having labrum and tegulae piceous, the former reddened laterally and at apex. Ventrite 6 entirely dark. Length, 6 mm.; anterior wing, 3.6 mm.; width of abdomen, 1.8 mm.

MALE.—Similar to female. Tergites 1 to 3 each with four spots, 4 usually with four, sometimes with only the two median spots. Tergite 5 either entirely black, or with two or even four small spots. In one male the two median spots are enlarged on 2 and 3, even coalescing on 2 and narrowly separated on 3 (the same specimen has four spots on tergite 5). Tegulae ferruginous, or dusky ferruginous. Labrum dark. Venter with apical fringes and shining black corneous structure on middle of apical margin of segment 4 much as in *S. ashmeadiellæ*. Length, about 4.5–5 mm.; anterior wing, 3.3–3.7 mm.; width of abdomen, 1.5–1.6 mm.

Described from a small series collected at Riverside, California, by the writer: One female (holotype), May 28, 1925, on *Eschscholtzia californica*; one female (paratype), May 27, 1932, on *Eriogonum fasciculatum*; two males (allotype and paratype) on *Gutierrezia californica*, May 27 and 29, 1925; and two males (paratypes) in 1934, one on *Encelia farinosa*, April 25, the other on *Cryptantha intermedia*, May 2.

This species is named in memory of Charles Robertson, noted for his work on the anthophilous insects of southern Illinois.

HIBERNATION OF (MYLLOCERUS) CORIGETUS? CASTANEUS ROELOFS

Hibernating adults of this weevil were taken from litter during March and April of 1941. The collections were made around trees that were almost completely defoliated, by the feeding of the adults in late summer of last year. Specimens were taken at Upper Montclair, Millburn and Atlantic Highlands.—F. A. SORACI.

RECORDS AND DESCRIPTIONS OF NEOTROPICAL
CRANE-FLIES (TIPULIDÆ, DIPTERA), XII

BY CHARLES P. ALEXANDER

AMHERST, MASSACHUSETTS

The preceding instalment under this general title was published in June, 1940 (Journal of the New York Entomological Society, 48: 105-116). The novelties discussed herewith were received from Mr. Pablo Anduze, who collected them at San Esteban and Borburata, Venezuela, between December, 1939, and March, 1940. I am very deeply indebted to Mr. Anduze for the privilege of retaining the types of these species; wherever represented by duplicates, allotype or paratype specimens have been returned to Mr. Anduze for the National Collection.

Genus *Ozodicera* Westwood***Ozodicera (Ozodicera) striatipennis*** new species.

General coloration of mesonotum yellowish gray, the præscutum with four conspicuous dark brown stripes; pleura yellowish gray pollinose; antennæ, with its branches, relatively short; flagellum black, the segments vaguely paler at their bases; wings pale brown, conspicuously patterned with white, especially in cells *R* and *M* and beyond the cord; cells M_1 broadly sessile; abdominal tergites obscure yellow, trivittate with black.

FEMALE.—Length about 17 mm.; wing 14.5 mm.

Frontal prolongation of head brown; palpi black. Antennæ relatively short; scape obscure yellow, pedicel clearer yellow; flagellum black, the bases of the individual segments restrictedly paler; outer simple segments vaguely more dimidiate, the basal half obscure brownish yellow to pale brown, the outer portion darker; terminal segments broken, preceding three segments short and decreasing very gradually in length outwardly. Head brownish gray, the front and very narrow anterior orbits darker.

Pronotum yellowish gray, variegated with dark brown. Mesonotal præscutum yellowish gray, with four conspicuous dark brown stripes, the intermediate pair distinctly separated, their mesal edges on anterior fourth more darkened; lateral stripes darker; humeral region blackened; scutum and scutellum brown, the latter more yellow pollinose; mediotergite dark, the surface yellow pollinose. Pleura conspicuously yellowish gray pollinose, the ventral pleurites more pruinose; dorsopleural membrane darkened. Halteres relatively long and slender, brownish black, the base of stem slightly paler. Legs with the coxæ gray pruinose; trochanters obscure yellow;

femora obscure yellow, the tips rather narrowly but conspicuously blackened; tibiæ brown, the tips narrowly more blackened; tarsi black. Wings conspicuously patterned with pale brown and white, the latter chiefly as a broken central longitudinal stripe; cells *C* and *Sc* more yellowish brown; the white areas occupy the outer ends of cells *R* and *M*, most of cell 1st *M*₂, subbasal portions of *R*₃ and *R*₅, outer two-fifths of *R*₅, and broad bases of cells *M*₁ to *M*₄ inclusive; veins dark brown, *Sc* more brownish yellow. Venation: Cell *M*₁ broadly sessile.

Abdominal tergites obscure yellow, trivittate with black, the median vitta narrowly more interrupted on the basal ring; basal sternites obscure yellow, the outer segments concealed by the overlapping tergal margins; ovipositor with the cerci long and slender, brownish yellow.

Holotype, ♀, Antimano, Venezuela, altitude 900 meters, January 13, 1940 (R. Lichy); through P. Anduze.

Ozodicera (Ozodicera) striatipennis is closest to the Brazilian *O. (O.) epicosma* Alexander, differing very conspicuously in the nature of the wing pattern.

Genus *Gonomyia* Meigen

Gonomyia (Progonomyia) compacta new species.

General coloration gray, the præscutum with four more or less distinct brown stripes; thoracic pleura with a more or less distinct gray to clear yellow stripe; knobs of halteres darkened; legs brownish yellow; wings subhyaline, unpatterned except for the faintly indicated stigma; male hypopygium with the apex of basistyle terminating in three or four strong flattened setæ; outer dististyle short and compact, heavily blackened; ædeagus with rounded lateral shoulders.

MALE.—Length about 5–6 mm.; wing 5.5–6.5 mm.

FEMALE.—Length about 6–7 mm.; wing 6–7 mm.

Rostrum brown; palpi black. Antennæ black; flagellar segments long-oval, the outer segments shorter and smaller. Head gray.

Pronotum and pretergites obscure yellow. Mesonotum brownish gray, the posterior portion of scutellum more obscure yellow to brownish yellow; præscutum, in cases, with four more or less distinct darker brown stripes; humeral and lateral portions of præscutum obscure yellow. Pleura gray, with a grayish to clear yellow longitudinal stripe. Halteres with stem obscure yellow, knob dark brown. Legs with coxæ darkened basally, the surface pruinose; trochanters light brownish yellow; remainder of legs brownish yellow, the terminal tarsal segments darkened. Wings subhyaline, the prearcular and costal portions more whitish; stigma oval, very pale brown; veins dark, paler in the brightened portions. Venation: *Sc*₁ ending beyond midlength of the long *Rs*; *m-cu* at or just before fork of *M*.

Abdomen, including hypopygium, dark brown. Male hypopygium with the terminal three or four setæ of basistyle shorter and stouter than the

remainder but scarcely spinous. Outer dististyle short and compact, heavily blackened, terminating in an acute spine. Inner dististyle with the apical spine long and straight. *Ædeagus* ending in a short curved point, the lateral shoulders rounded but relatively conspicuous.

Holotype, ♂, Borburata, altitude 500 meters, March 15, 1940 (Anduze). Allotopotype, ♀, pinned with type. Paratopotypes, 8 ♂ ♀, with the types. Paratype, 1 ♀, San Esteban, January 1, 1940 (Anduze).

The nearest allies are *Gonomyia (Progonomyia) balzapamba* Alexander and *G. (P.) patruelis* Alexander, both of which differ in the structure of the male hypopygium, especially of the dististyles.

***Gonomyia (Lipophleps) anduzeana* new species.**

Belongs to the *manca* group; mesonotum dark brown, the caudal border of scutellum obscure yellow; thoracic pleura brown with a conspicuous yellowish white longitudinal stripe; legs brownish yellow, the outer segments darker; wings with a weak brown tinge, the costal border paler; *Sc* relatively long; male hypopygium with the dististyle bilobed, the lateral lobe a blackened spine; phallosome large and blackened, with a single blackened spinous point.

MALE.—Length about 3–3.5 mm.; wing 3.5–4 mm.

Rostrum obscure yellow; palpi black. Antennæ black throughout. Head dark gray, the occipital region more yellowish.

Pronotum and lateral pretergites china-white. Mesonotum chiefly dark brown, the caudal border of scutellum obscure yellow. Pleura brown, with a conspicuous yellowish white longitudinal stripe extending from the fore coxæ to the base of abdomen, passing beneath the root of the haltere. Halteres dusky. Legs with the coxæ testaceous, trochanters a little darker; remainder of legs obscure yellow to brownish yellow, the outer tarsal segments darker. Wings with a weak brown tinge, the prearcular and costal portions more whitish; stigma scarcely indicated; veins brown. Venation: *Sc* relatively long, *Sc*₁ extending to shortly beyond the origin of *Rs*, *Sc* immediately before this origin; *m-cu* close to fork of *M*.

Abdominal tergites dark brown; sternites and hypopygium yellow. Male hypopygium with the outer lobe of basistyle fleshy, cylindrical to feebly bulbous at distal end. Dististyle bilobed, the lateral lobe a blackened spine that bears a brush of setæ in its curve; outer lobe obtuse and narrowly blackened at apex, the fasciculate bristles near lateral margin. Phallosome large and flattened, with a single blackened spinous point that bears a few setæ on lower face before the spine; margin of phallosome with a conspicuous, obtusely rounded lobe.

Holotype, ♂, San Esteban, January 6, 1940 (Anduze). Paratopotype, ♂, with type.

I take great pleasure in dedicating this distinct species to the collector, Mr. Pablo Anduze. It is entirely different from all described species in the structure of the male hypopygium. While somewhat similar to *Gonomyia (Lipophleps) macswaini* Alexander, of northern Panama and Costa Rica, all details of the male hypopygium are distinct.

***Gonomyia (Lipophleps) vindex* new species.**

Belongs to the *manca* group; mesonotum brownish gray, the median region of the scutum and the scutellum obscure yellow; thoracic pleura with a scarcely indicated pale longitudinal stripe; legs brown; wings with a weak brownish tinge; Sc_1 ending opposite origin of R_s ; male hypopygium with the basistyle produced into a stout fleshy lobe; dististyle bearing two powerful black spines on outer margin; phallosome prolonged apically into a neck that terminates in a head and further provided with spinous points.

MALE.—Length about 3.3 mm.; wing 3.8 mm.

Rostrum obscure yellow; palpi black. Antennæ black. Head brownish gray.

Pronotum dark, china-white laterally. Mesonotum brownish gray, the lateral pretergites china-white; median region of scutum and the scutellum except at base obscure yellow. Pleura obscure yellow to pale brownish yellow, with a scarcely indicated paler ventral longitudinal stripe. Halteres with stem pale, knob weakly darkened. Legs with the coxæ and trochanters testaceous yellow; remainder of legs brown, the tarsi a little darker. Wings with a weak brown tinge, the prearcular and costal fields more whitish; stigma scarcely differentiated; veins brown. Venation: Sc relatively long, Sc_1 ending immediately opposite origin of R_s , Sc_2 a short distance from its tip; $m-cu$ at or just beyond fork of M .

Abdominal tergites brown; sternites and hypopygium more brownish yellow. Male hypopygium with the outer angle of basistyle produced into a stout fleshy lobe that extends slightly beyond the level of all other elements of the hypopygium. Dististyle bearing two powerful black spines on outer margin. Phallosome a flattened pale mass that is produced apically into a slender neck that bears an apical head, the latter further produced into a slender straight spine, with a second smaller spine placed slightly more distad; apex of head with abundant microscopic setulæ; a strong curved black spine at base of the apical prolongation of the phallosome.

Holotype, ♂, Borburata, altitude 500 meters, March 15, 1940 (Anduze).

Gonomyia (Lipophleps) vindex is quite distinct from all of the now very numerous species of the subgenus that have been described. The fly falls in that section where the male hypopygium has the basistyle produced apically into a stout fleshy lobe so that the dististyle is subterminal in position; dististyle with spinous

armature; phallosome asymmetrical and complex, provided with blackened spinous points, including an apical one that terminates a distinctly dilated head. It comes closest to *G. (L.) macswaini* Alexander and *G. (L.) anduzeana* new species, yet is entirely distinct.

Gonomyia (Lipophleps) borburatana new species.

Belongs to the *manca* group; thoracic pleura weakly striped; legs pale brown; wings pale brown, the preareolar and costal fields more yellow; *Sc* short; male hypopygium with the outer angle of basistyle prolonged into a slender spine; dististyle simple; phallosome without blackened spines or points.

MALE.—Length about 3 mm.; wing 3 mm.

Rostrum obscure yellow; palpi black. Antennæ brownish black. Head buffy yellow.

Pronotum china-white. Mesonotum reddish brown, the præscutum darker brown in front; scutellum and mediotergite more infuscated, the former with the posterior border obscure yellow. Pleura pale brown, with a scarcely indicated paler ventral longitudinal stripe. Halteres weakly darkened, the base of stem restrictedly pale. Legs pale brown. Wings with a pale brown tinge, the preareolar and costal fields more yellow; veins brown. Venation: *Sc* short, *Sc*₁ ending a distance before origin of *Rs* about equal to three-fourths to four-fifths the total length of the latter vein; *m-cu* at or just before fork of *M*.

Abdominal tergites pale brown; sternites more yellow; hypopygium obscure yellow. Male hypopygium with the basistyle small, its outer apical angle produced into a very long spine that is much longer than the dististyle. Dististyle a simple elongate structure, slightly narrowed outwardly, both margins weakly roughened or serrulate; fasciculate setæ unequal in size. Phallosome pale, without blackened spines or points.

Holotype, ♂, Borburata, altitude 500 meters, March 10, 1940 (Anduze).

Gonomyia (Lipophleps) borburatana is quite different from all regional species of the subgenus, differing especially in the structure of the male hypopygium. Superficially, the hypopygium resembles that of *G. (L.) macintyreii* Alexander but the details of structure are entirely different.

Genus *Teucholabis* Osten Sacken

Teucholabis (Teucholabis) nocturna new species.

General coloration polished black, including the head and thorax; rostrum unusually long; apices of knobs of halteres yellow; legs black, the femoral bases more brightened; wings whitish subhyaline, restrictedly patterned with brown, including the narrow apex and a seam along cord; male hypopygium

with the outer dististyle very large and conspicuous, bilobed, both lobes terminating in short spines; ædeagus terminating in a slender spine.

MALE.—Length about 7 mm.; wing 6 mm.

Rostrum unusually long, exceeding in length the remainder of head, black; palpi black. Antennæ black throughout; flagellar segments passing through oval to long-oval, gradually decreasing in size outwardly. Head polished black.

Thorax polished black, the pleura with a broad gray pruinose longitudinal stripe extending from behind the fore coxæ to the base of abdomen, passing beneath the root of the halteres. Halteres black, the apex of knob restrictedly yellow. Legs with the coxæ and trochanters black; femora black, the bases a trifle paler, somewhat more extensively and broadly so on the middle and hind legs; tibæ and tarsi uniformly black. Wings broad, whitish subhyaline, restrictedly patterned with brown; cell *Sc* darkened except at outer end; stigma and a narrow confluent seam on cord dark brown; wing tip narrowly darkened, extending from cell R_2 to M_3 inclusive; no darkening of cells basad of cord; veins black, the prearcular ones paler. Venation: *Sc* relatively long, Sc_1 extending to opposite three-fifths the length of *Rs*, Sc_2 a short distance from its tip; anterior branch of *Rs* nearly straight; *m-cu* about one-third to one-fourth its length beyond fork of *M*.

Abdomen black throughout. Male hypopygium with the lobe of basistyle relatively short, flattened, at apex directed laterad into a strong black spine; inner margin of lobe with numerous setulæ. Outer dististyle very large and conspicuous, bilobed, both lobes terminating in short spines, the outer lobe longest. Inner dististyle a blackened cultriform blade, the outer margin simple, not bidentate. Ædeagus terminating in a slender, gently curved spine.

Holotype, ♂, San Esteban, December 19, 1939 (Anduze).

Teucholabis (*Teucholabis*) *nocturna* is readily distinguished from other uniformly black species by the wing pattern and the structure of the male hypopygium. The wing pattern is most like that of *T. (T.) decora* Alexander, *T. (T.) stygica* Alexander, and similar forms, but the species is entirely distinct.

Genus *Gnophomyia* Osten Sacken

Gnophomyia (*Gnophomyia*) *digitiformis* new species.

General coloration brown, the thoracic pleura indistinctly variegated with yellow; antennal flagellum black; wings with a very faint dusky tinge, the stigma lacking or restricted to a narrow seam along vein R_{1+2} ; male hypopygium with the sides of tergite produced into slender finger-like lobes.

MALE.—Length about 6.5 mm.; wing 7 mm.

Rostrum dark brown; palpi black. Antennæ with the scape and pedicel brownish yellow, flagellum black; flagellar segments subcylindrical, the verticils subequal in length to the segments. Head gray.

Pronotum pale brown. Mesonotum medium brown, without præscutal stripes, the humeral region of præscutum vaguely brightened. Pleura brown, with a more yellowish longitudinal stripe involving the dorsal sternopleurite and ventral pteropleurite. Halteres with stem obscure yellow, knob darkened. Legs with the coxæ yellow, the middle pair slightly more darkened; trochanters yellow; femora, tibiæ and basitarsi obscure yellow or brownish yellow, the tips of the tibiæ and basitarsi narrowly more darkened; terminal tarsal segments uniformly dark brown. Wings with a very faint dusky tinge, the prearcular field more flavous; stigma lacking or barely indicated by a darkened seam along vein R_{1+2} ; veins brown. Venation: Sc_1 ending opposite R_2 , the latter just beyond the fork of R_{2+3+4} ; $r-m$ close to fork of R_s ; $m-cu$ nearly its own length beyond fork of M .

Abdominal tergites brownish yellow, the sternites clearer yellow; hypopygium scarcely darkened. Male hypopygium with the outer dististyle rather strongly arcuated, conspicuously narrowed on outer fourth, the apex narrowly subacute. Inner dististyle relatively small and weak, narrowed apically. Phallosome broad, the ædeagus extending caudad beyond the level of the phallosomic mass; sides of tergal plate produced caudad into slender fingerlike lobes, one on either side of the phallosome.

Holotype, ♂, San Esteban, December 19, 1939 (Anduze).

Gnophomyia (Gnophomyia) digitiformis is generally similar to *G. (G.) subhyalina* Alexander, differing especially in the structure of the male hypopygium, as the dististyles and the tergite. The peculiar digitiform tergal lobes on either side of the phallosome (as they appear in a microscopic slide mount) are not found in any other of the now numerous species of the genus in Tropical America.

***Gnophomyia (Gnophomyia) stenophallus* new species.**

Allied to *subhyalina*; general coloration brown, the thoracic pleura brightened on ventral portion; wings with a weak brown tinge; R_2 very faint to subatrophied, placed close to fork of R_{2+3+4} ; male hypopygium with both dististyles blackened, the outer style unusually straight, gradually narrowed to the subacute tip; inner style parallel-sided, its tip subtruncate; phallosomic mass blackened apically, widest at base.

MALE.—Length about 5 mm.; wing 5.2 mm.

Rostrum light brown, palpi slightly darker. Antennæ with basal three or four segments pale brown or yellowish brown, the outer segments darker; flagellar segments oval, gradually decreasing in size outwardly. Head gray; eyes (male) very large, reducing the anterior vertex to a narrow line.

Pronotum darkened, the pretergites yellow. Mesonotum almost uniformly brown, the surface very sparsely pruinose, the scutal callosities more yellowish; lateral margins of præscutum behind the pseudosutural foveæ restrictedly yellow. Pleura with the dorsal sclerites darker brown than the ventral

and posterior ones, forming a vague stripe on the anepisternum. Halteres dusky, the base of stem yellow. Legs with the coxæ and trochanters yellow; remainder of legs yellow, the terminal tarsal segments darkened; very vague indications of a narrow darkened subterminal ring on femora. Wings with a weak brown tinge, the prearcular field slightly more yellow; veins brown. Venation: Sc_1 ending just before fork of R_{2+3+4} , Sc_2 some distance from its tip and nearly opposite the fork of R_s ; R_2 close to fork of R_{2+3+4} , very faint to nearly atrophied; $r-m$ at fork of M ; cell 1st M_2 widened outwardly; $m-cu$ approximately one-half its length beyond the fork of M .

Abdominal tergites dark brown, the sternites more yellow; hypopygium brownish yellow. Male hypopygium with the outer dististyle unusually straight, blackened, gradually narrowed to the subacute tip; inner style a similarly blackened, parallel-sided rod, the tip subtruncate but not widened. Phallosome massive, blackened apically, unusually narrow, widest at base, the apex with a microscopic median notch.

Holotype, ♂, San Esteban, January 6, 1940 (Anduze).

Gnophomyia (*Gnophomyia*) *stenophallus* is closest to *G.* (*G.*) *subhyalina* Alexander, differing especially in the structure of the male hypopygium, notably of the inner dististyle and the phallosome.

Gnophomyia (*Gnophomyia*) *rubicundula* Alexander.

1921. *Gnophomyia rubicundula* Alexander, Proc. Acad. Nat. Sci. Philadelphia, 1921: 74-75.

The unique type (Yurimaguas, Peru, April 1, 1920, *H. S. Parish*) was described as being a male. The genitalia of the dry specimen was badly shrunken and it was only when a slide mount was made that it was found to represent the female sex. The valves of the ovipositor are unusually short and fleshy, the cerci being reduced to triangular plates that are provided with setæ to their tips.

Genus *Neognophomyia* Alexander

Neognophomyia monophora new species.

General coloration yellow to fulvous yellow; thoracic pleura with two major black spots to form an interrupted dorsal stripe; legs yellow, the four terminal tarsal segments infuscated; wings subhyaline, with a narrow dark band along cord; male hypopygium with the inner dististyle terminating in a simple blackened point; phallosome terminating in a single small black knob.

MALE.—Length about 5 mm.; wing 5 mm.

FEMALE.—Length about 6 mm.; wing 6 mm.

Rostrum yellow; palpi brown. Antennæ with scape and pedicel brownish yellow, flagellum dark brown; flagellar segments oval to long-oval. Head yellow; anterior vertex relatively narrow.

Pronotum and mesonotum almost uniformly yellow to fulvous yellow, the surface polished, the lateral præscutal stripes and centers of the scutal lobes a trifle darkened. Pleura yellow, with major black areas on the anepisternum and pleurotergite, separated by the pale pteropleurite. Halteres with stem yellow, knob infuscated. Legs with the coxæ and trochanters yellow; remainder of legs yellow, the four terminal tarsal segments infuscated. Wings subhyaline; a narrow dark band along cord, extending from the stigma to posterior end of *m-cu*; veins brownish yellow to pale brown, darker in the central clouded area. Venation: R_2 at near midlength of petiole of cell R_3 ; *m-cu* a little less than its own length beyond the fork of *M*.

Abdomen of male yellow, narrowly darkened laterally, the subterminal segments weakly darkened; hypopygium yellow. In the female, abdomen with tergites more extensively dark brown, including the lateral portions of the more basal segments and all of segments five and six; sternites pale. Male hypopygium with the inner dististyle terminating in a narrow blackened point. Interbases entirely pale, sinuous, the distal half a long straight spine. Phallosome a broadly depressed plate, the apex a single slender blackened knob; a more slender pale blade lying above the phallosome.

Holotype, ♂, San Esteban, December 28, 1939 (Anduze). Allotopotype, ♀, pinned with type. Paratypes, 2 ♂♂, Borburata, altitude 500 meters, March 10-15, 1940 (Anduze).

Neognophomyia monophora is entirely distinct from the now rather numerous species. The nearest described form is *N. trinitatis* Alexander, which has the male hypopygium entirely distinct. The hypopygial structures described here and elsewhere as being interbases certainly appear to be such, but the strict homologies cannot be affirmed at this time.

Genus *Cryptolabis* Osten Sacken

Cryptolabis (*Cryptolabis*) *nebulicincta* new species.

General coloration yellow, the mesonotal præscutum reddish brown; a conspicuous, dark brown, dorsal pleural stripe; legs dark brown; wings with a weak dusky tinge, the prearcular field more yellowish; a very diffuse dusky seam along the cord; macrotrichia in all but basal portions of cells beyond cord; R_s long, sinuous on distal half; abdomen yellow, the caudal margins of the tergites broadly and conspicuously blackened.

FEMALE.—Length about 4.5 mm.; wing 5.2 mm.

Rostrum testaceous yellow; palpi black. Antennæ with the scape and pedicel dark brown, flagellum paler brown. Head yellow.

Pronotum yellow above, dark brown on sides. Mesonotal præscutum reddish brown, the lateral margins restrictedly pale yellow; scutal lobes slightly darker brown; median region of scutum and the scutellum more testaceous yellow, the latter slightly pruinose; mediotergite darkened. Pleura yellow, with a conspicuous, dark brown, longitudinal stripe extending from the pronotum across the dorsal pleurotergite to the abdomen, passing above the root of the halteres. Halteres yellow. Legs with the coxæ and trochanters yellowish testaceous; remainder of legs dark brown, the femoral bases restrictedly obscure yellow. Wings with a weak dusky tinge, the prearcular field more yellow; a very diffuse dusky seam along the cord, not quite attaining the posterior border behind; a less evident darkened seam along vein *Cu* in cell *M*; wing-axil darkened; veins brown, more yellowish in the prearcular and subcostal fields. Numerous macrotrichia in cells beyond cord, lacking only in the basal portions of these cells. Venation: *Rs* long, sinuous on distal half; *R*₂₊₃ angulated and short-spurred at near midlength; *m-cu* about its own length beyond the fork of *M*.

Abdominal segments yellow, the caudal margins of the tergites broadly and conspicuously blackened to produce a ladder-like appearance.

Holotype, ♀, San Esteban, December 19, 1939 (Anduze).

Cryptolabis (*Cryptolabis*) *nebulicincta* is closest to *C. (C.) laticostata* Alexander (Ecuador) and *C. (C.) schadeana* Alexander (Southeastern Brazil), differing from both in the coloration of the body and wings, and from the latter in the pattern of the legs.

ADDITIONAL NOTES ON THE BEHAVIOR OF CERTAIN INSECTS TO DIFFERENT WAVE-LENGTHS OF LIGHT

BY HARRY B. WEISS, FRANK A. SORACI AND
E. E. MCCOY, JR.

This paper covers the results obtained by testing the color responses of 22 species of insects, the notes thereon having accumulated since the first tests involving 18 species were made and reported upon in this JOURNAL for March 1941. The same apparatus was used and the same procedure was followed as were outlined in the March 1941 paper and there is no need to describe either again. Except where noted, adult stages were used and the physical intensities of the wave-lengths of the light were equalized by the methods previously described. In fact, this paper is, for the most part, an extension of the first one.

Twenty-two species, representing seven orders, were tested for 15 minutes for their color reactions and the results are outlined in Table 1. In addition, the behavior of these species is shown graphically on Plates 4 and 5 together with the behavior of those tested previously and reported in the first paper. These "behavior curves" should not be regarded as continuous records of the reactions of the insects to that portion of the electromagnetic spectrum from 3650 to 7400 ångstrom units. As a matter of fact, the insects were exposed to only eight bands, these having peaks of energy at .365, .436, .464, .492, .515, .606, .642, and .720 microns respectively.¹ In other words, each curve simply connects the points that represent the percentage distribution of the reacting numbers of each species, and gives one a rough idea of the relative responses of the species to certain wave-lengths in the spectrum, when light of equal energy or physical intensity was used. Conversely, the relative efficiency of wave-lengths of equal energy is demonstrated.

¹ These peaks occur in transmitted bands, extending as follows: 3650-3663; 4120-4760; 4420-5000; 4700-5280; 4940-5660; 5900-6420; 6120-6860; 6620-7400 ångstrom units. The order as given is identical with the order of the peaks. See JOUR. N. Y. ENT. SOC., Mar., 1941, p. 1-20.

TABLE 1

DISTRIBUTION IN PERCENTAGES OF NUMBER REACTING POSITIVELY TO DIFFERENT WAVE-LENGTHS

Name	No. tests	Total No. insects involved	Per cent of total in centre	Per cent of total reacting	Wave-lengths of maximum transmission in microns													
					.365	.436	.464	.492	.515	.606	.642	.720						
Orthoptera																		
Gryllidæ																		
<i>Gryllus luctuosus</i> Serv.	4	156	1	99	8.3	23.6	11.1	18.0	11.9	11.1	11.1	9.9	6.1					
Mantidæ																		
<i>Tenodera sinensis</i> Sauss. (1 day old)	2	477	45	55	31.6	17.8	7.5	14.9	10.6	8.4	4.8	4.4						
Homoptera																		
Cicadellidæ																		
<i>Entettix tenellus</i> Baker	1	114	45	55	37.1	8.1	0.0	29.0	14.5	8.1	0.0	3.2						
<i>Agallia sanguinolenta</i> Prov.	1	98	29	71	21.7	13.0	1.5	29.0	23.0	5.8	3.0	3.0						
<i>Macrostelus divinus</i> Uhl.	1	96	18	82	30.0	2.5	0.0	37.1	25.4	0.0	2.5	2.5						
Hemiptera																		
Coreidæ																		
<i>Leptocoris trivittatus</i> Say	3	209	4	96	25.5	10.5	7.0	21.5	19.0	6.0	6.0	4.5						
Coleoptera																		
Chrysomelidæ																		
<i>Diabrotica vittata</i> Fab.	3	569	10	90	13.7	18.3	14.6	21.6	18.6	7.2	3.9	2.1						
Scarabeidæ																		
<i>Aphodius fimetarius</i> L.	3	172	17	83	20.4	9.2	8.4	29.6	18.3	9.2	1.4	3.5						
Same insects 3 days later	3	110	23	77	16.4	22.4	8.2	31.7	5.9	11.8	2.4	1.2						
<i>Aphodius distinctus</i> Muls.	3	159	23	77	33.0	5.0	4.1	12.4	19.0	9.1	9.1	8.3						
Same insects 3 days later	3	95	22	78	36.5	2.7	8.2	20.3	12.0	10.8	5.4	4.1						
<i>Popillia japonica</i> (Larvæ—3rd instar)	4	299	62	38	10.4	14.9	11.3	2.6	9.5	14.9	20.8	15.6						
<i>Popillia japonica</i> 2nd lot (Larvæ—3rd instar)	3	147	24	76	5.4	16.2	11.8	7.2	6.2	9.0	27.0	17.2						
Dermestidæ																		
<i>Dermestes vulpinus</i> Fab. (Full grown larvæ)	1	106	21	79	18.6	9.2	4.6	10.4	14.0	4.6	28.2	10.4						
Tenebrionidæ																		
<i>Nyctobates pennsylvanica</i> DeG.	12	93	25	75	15.1	9.0	6.0	10.7	9.1	17.8	15.6	16.7						
Bruchidæ																		
<i>Bruchus obtectus</i> Say	3	1,117	20	80	19.0	9.0	6.0	26.0	16.0	12.0	5.0	7.0						
<i>Bruchus obtectus</i> Say (2nd lot)	3	95	18	82	10.3	18.1	7.7	28.0	11.5	10.3	7.7	6.4						

Some previous workers have concluded that photopositive insects appear to "see" ultra-violet better than the other parts of the spectrum, basing their conclusions on experiments in which light of unequal energy was used over different portions of the spectrum and then calculating the relative effects of equal energies.

Sanders² has questioned the validity of these methods, and in his work with the honey bee, he found that, when light of equal energy was used at all parts of the spectrum, there was no trace of a high maximum at 3650 ångstrom units.

An examination of the "behavior curves" from 1 to 28 inclusive, on Plates 4 and 5 indicates that Sanders' conclusion may be correct. The responses of the 29 species, which are all generally regarded as photopositive were, for the most part, remarkably constant with respect to certain characteristics. Of the 29 species, 18 showed a peak response at .492 microns (blue-blue-green), 7 at .365 microns (ultra-violet), 3 at .436 microns (violet-blue), and 1 at .515 microns (blue-green). In all cases the peaks took place between .365 and .566 microns, and the longer wave-lengths had comparatively little attractive value. The secondary peaks which occur in many of these curves appear quite significant, but at this time we are in no position to offer explanations for them. These "behavior curves," we believe, have value only in demonstrating the efficiency of certain wave-lengths as compared to others and in calling attention to the trend of behavior under the conditions of the experiments. The fact that small numbers of insects reacted positively to wave-lengths of apparently little stimulating value may be due to various factors such as certain physiological states, an unfavorable position when first placed in the testing box which resulted in the insects not being truly oriented to the most stimulating wave-lengths, or to other factors which reduced their receptivity.

The "behavior curves" of *Gryllus luctuosus* (7), *Diabrotica vittata* (13A), *Anasa tristis* (18), *Musca domestica* (20) and *Bruchus obtectus* (21, 25) do not exhibit pronounced peaks as do many of the other photopositive species. Without attempting

² Sanders, W., Z. vergl. Physiol., 20 (1933), 267-86 (response to light of different wave-length in honey bee).

TABLE 2

Name	Date tested	Relative humidity during test	Temperature °C.	
			At start of test	At end of test
<i>Gryllus luctuosus</i> Serv.	Sept. 27, 1940	Per cent	24.0	25.0
<i>Tenodera sinensis</i> Sauss. (1 day old nymphs)	Dec. 31, 1940	50	24.0	26.0
<i>Eutettix tenellus</i> Baker	Nov. 8, 1940	36	25.0	26.0
<i>Agallia sanguinolenta</i> Prov.	Nov. 8, 1940	36	25.0	26.0
<i>Macrosteles divinus</i> Uhl.	Nov. 8, 1940	36	25.0	26.0
<i>Leptocoris trivittatus</i> Say	Oct. 14, 1940	50	23.0	24.5
<i>Diabrotica vittata</i> Fab.	Nov. 7, 1940	40	22.7	24.0
<i>Aphodius fimetarius</i> L.	Oct. 29, 1940	38	25.5	26.0
<i>Aphodius fimetarius</i> , same lot	Nov. 1, 1940	44	25.0	27.0
<i>Aphodius distinctus</i> Muls.	Oct. 29, 1940	38	25.0	26.5
<i>Aphodius distinctus</i> , same lot	Nov. 1, 1940	50	24.0	25.0
<i>Popillia japonica</i> , larvæ	Oct. 1, 1940	48	24.0	25.0
<i>Popillia japonica</i> , larvæ, 2nd lot	Oct. 29, 1940	38	26.0	26.5
<i>Dermeestes vulpinus</i> Fab., larvæ	Oct. 25, 1940	46	23.0	24.0
<i>Nyctobates pennsylvanica</i> DeG.	Nov. 9, 1940	38	23.0	25.0
<i>Bruchus obtectus</i> Say	Nov. 26, 1940	40	21.0	24.0
<i>Bruchus obtectus</i> , 2nd lot	Jan. 14, 1941	30	23.0	24.0
<i>Musca domestica</i> L.	Dec. 9, 1940	36	23.5	24.5
<i>Aedes aegypti</i> L.	Dec. 23, 1940	34	23.0	25.0
<i>Neodiprion lecontei</i> Fitch	Oct. 25, 1940	42	26.0	27.0
<i>Triaspis thoracicus</i>	Dec. 4, 1940	28	23.0	25.0
<i>Microplectron fuscipennis</i> Zett.	Dec. 14, 1940	40	21.5	23.5
<i>Galleria melonella</i> Linn.	Dec. 16, 1940	40	21.5	22.5
<i>Achroia grisella</i> Fab., larvæ	Jan. 6, 1941	38	22.0	23.0
<i>Tineola biselliella</i> Hum.	Jan. 10, 1941	36	24.0	26.0
<i>Bombix mori</i> Linn.	Nov. 6, 1940	40	24.0	25.0
<i>Bombix mori</i> , larvæ	Oct. 8, 1940	60	24.0	25.0

to explain the reasons for this, it should be mentioned that *Gryllus luctuosus*, *Diabrotica vittata*, and *Anasa tristis* were about ready for hibernation when they were tested. One does not expect pronounced responses to light from insects that are about to hibernate or from the housefly, which is seemingly indifferent to light except when disturbed. Dates tested, relative humidity and temperatures are found in Table 2. The fact that all species do not behave similarly under similar conditions is shown by the behavior of the 7 species that peaked at .365 microns (ultra-violet).

The similarity of the behavior of different lots of the same species or of successive tests of the same lot of specimens is shown by "behavior curves" 21 and 25, and 23 and 24. The first lot of *Bruchus obtectus*, in which 1117 insects were involved, reacted as shown by curve 21. The second lot, in which 95 insects were tested about 50 days later, reacted as shown by curve 25. For the most part the curves are similar. The two curves in each of the figures 23 and 24 represent the behavior of the same individuals three days apart. They follow the same trend.

For the photopositive species that were tested under the conditions described, it may be stated that, with lights of equal energy, wave-lengths from 3650 to 5660 ångstrom units had a decided stimulating value, and that within this portion of the spectrum, a band of from 4700 to 5280 ångstrom units had the greatest stimulating value for most of the species. With the equalization of the physical intensities of our lights, the responses obtained from the photopositive species should be due to wave-length alone.

Although the apparatus in use was not designed for testing the behavior of photonegative insects, the reactions of eight photonegative species are reported as a matter of interest. As it was impossible, on account of the circular arrangement of the chambers, to have one that was completely dark, the same filters and the same arrangements were used for both photopositive and photonegative insects, and all lights were of equal energy. A description of the equipment and methods will be found in our first paper published in this JOURNAL for March 1941.

The results of the tests of the photonegative species are found both in Table 1 and on Plate 2, numbers 29 to 38. It will not

do to draw many conclusions from the "behavior curves" 29 to 38. They have certain characteristics in common. For the most part the peaks occur in that portion of the spectrum with wave-lengths from 5900 to 7400, and the band 4700-5280, that was the most attractive to the photopositive species, was the least attractive one for the photonegative species. Aside from the decided negative reaction to 4700-5280 ångstrom units, the balance of the behavior as recorded may not be a positive movement to certain wave-lengths, so much as a dispersal in search of darkness which could not be found, and the wave-lengths in which the peaks occur may represent those that were least objectionable rather than attractive. The two tests of Japanese beetle larvæ (34) represent two different lots with a month between the tests. Their behavior in both cases was almost identical.

Species which failed to react either photopositively or photonegatively were silk-worm adults and larvæ, *Bombyx mori* L., and the larvæ of *Neodiprion lecontei* Fitch. The latter saw-fly larvæ were full grown and about to pupate. In the case of the silk-worm adults and larvæ, this species has been under domestication for so many years that it appears to have lost its capacity for responses to some stimuli that activate other species.

ACKNOWLEDGEMENTS

For generously supplying the specimens used in the tests, our sincere thanks are hereby given to Mr. R. J. Sim, Mr. Paul L. Holcombe, New Jersey Department of Agriculture; Dr. R. W. Glaser, Dr. L. O. Kunkel, Rockefeller Institute for Medical Research, Princeton, N. J.; Dr. A. Glenn Richards, Jr., University of Pennsylvania; Dr. N. V. Anthony, American Museum of Natural History; Dr. H. F. Dietz, Du Pont de Nemours Co., Inc., Wilmington, Delaware; Mr. I. W. Bales, Chipman Chemical Co., Inc., Bound Brook, N. J.; Mr. T. R. Gardner, and Mr. R. C. Brown, Bureau of Entomology and Plant Quarantine, United States Department of Agriculture, and Dr. Wm. Moore, American Cyanamid Company, Stamford, Conn.

PLATE IV

- Figure 1. *Leptinotarsa decemlineata*.
Figure 2. *Epicauta pennsylvanica*.
Figure 3. *Epilachna corrupta*.
Figure 3A. *Chrysochus auratus*.
Figure 4. *Chauliognathus pennsylvanicus*.
Figure 5. *Galerucella notata*.
Figure 6. *Chalepus dorsalis*.
Figure 7. *Gryllus luctuosus*.
Figure 8. *Scolytus multistriatus*.
Figure 9. *Hylurgopinus rufipes*.
Figure 10. *Rhyssematus lineaticollis*.
Figure 11. *Cyllene robinie*.
Figure 12. *Popillia japonica*.
Figure 13. *Tetraopes* spp.
Figure 13A. *Diabrotica vittata*.
Figure 14. *Macrosteles divisus*.
Figure 15. *Agallia sanguinolenta*.
Figure 16. *Eutettix tenellus*.
Figure 17. *Leptocoris trivittatus*.
Figure 18. *Anasa tristis*.
Figure 19. *Corythucha ciliata*.
Figure 20. *Musca domestica*.
Figure 21. *Bruchus obtectus*.
Figure 22. *Triaspis thoracicus* (males).
Figure 23. *Aphodius fimetarius* (dotted line, same insects tested 3 days later).
Figure 24. *Aphodius distinctus* (dotted line, same insects, 3 days later).

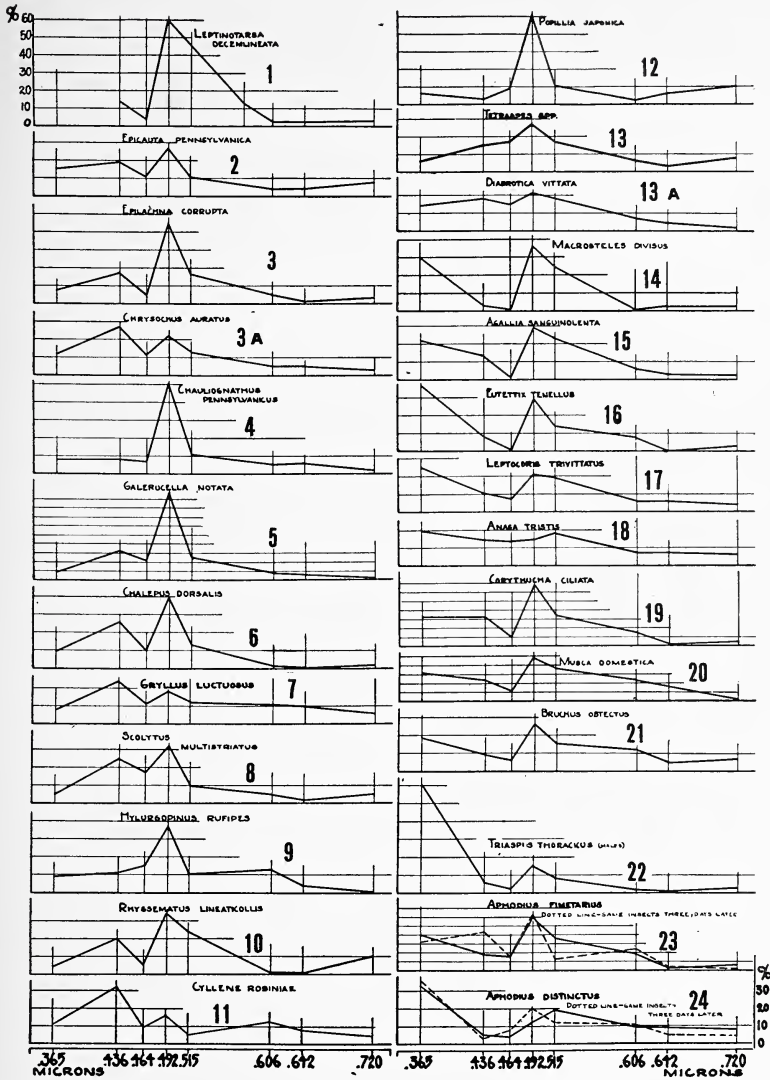
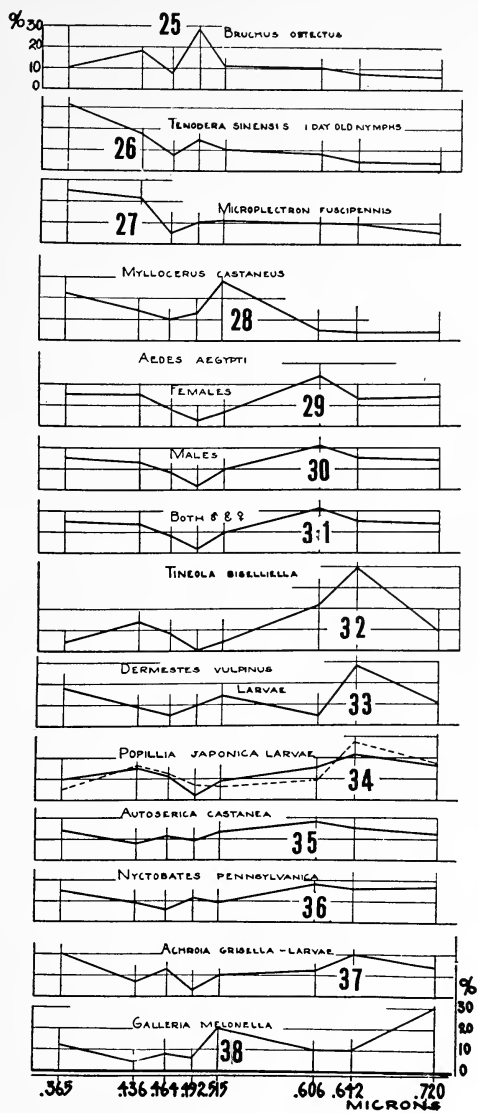

PLATE V

- Figure 25. *Bruchus obtectus*.
Figure 26. *Tenodera sinensis* (1-day-old nymphs).
Figure 27. *Microplectron fuscipennis*.
Figure 28. *Mylocerus castaneus*.
Figure 29. *Aedes ægypti* (females).
Figure 30. *Aedes ægypti* (males).
Figure 31. *Aedes ægypti* (males and females).
Figure 32. *Tineola biselliella*.
Figure 33. *Dermestes vulpinus* (larvæ).
Figure 34. *Popillia japonica* (larvæ) (dotted line represents testing of a second lot).
Figure 35. *Autoserica castanea*.
Figure 36. *Nyctobates pennsylvanica*.
Figure 37. *Achroia grisella* (larvæ).
Figure 38. *Galleria melonella*.



AN UNDESCRIBED AMERICAN CEPHENEMYIA

BY CHARLES H. T. TOWNSEND

The writer is indebted to Dr. Cornelius B. Philip, through Dr. R. R. Parker, Director of the Rocky Mountain Laboratory at Hamilton, Montana, for the material described below as well as for information relating to it.

Cephenemyia jellisoni new species

Length, 14 mm. One male, Girds Point Lookout, Ravalli County, Montana, about 7700 feet, August, 1938 (William L. Jellison). Holotype in U.S.N.M.

Male vertex almost $\frac{1}{3}$ head width. Pile of head pale yellowish, with blackish on outer side of parafrontalia and on most of parafacialia. Same yellowish pile on thorax, with black band between wing bases and some black interspersed on mesopleura. Abdominal pile pale rufous, with short blackish on broad sides of second segment and long yellowish on sides and venter of first segment. Wings brown in 1R and on R6, less so in 2S, 3R and 6R, rest clear. Squamæ pale yellowish tinged. Femora with yellowish pile except broadly terminally.

This species has the black mesoscutal band of *pratti* and the wing infuscation of *phobifer*. Named in honor of the collector, who on April 28, 1933, also secured from *Odocoileus hemionus* in Ravalli county, Montana, the maggot III from which the following description has been made.

Maggot III—Length, 33 mm. Dorsal spines much larger than ventral, which are more numerous and more closely set. Fourteen segments including the pseudocephalon, which is bare. Antennæ each with pair of micro brownish circles on tip. Labial sclerites (mouthhooks) strongly curved back hook-like. Fourteenth segment much reduced and terminal ventrally, while the anal stigmata though pertaining thereto are set in the posterior face of the thirteenth and well above the body of the fourteenth. All spine tips are distinctly but only slightly reclinate with the sole exception of those on posterior margin of twelfth segment which are distinctly proclinate. The rows of spines are more or less irregular and are all in bands anteriorly on segments unless otherwise stated.

Upper or dorsal surface—Second segment, about 3 or 4 irregular rows of spines but the anterior row stouter by far than the rest; 3d, bare, midplate bearing some 3 dozen brown dots in 3 longitudinally disposed groups; 4th,

not the faintest sign of anterior spiracles, 2 to 3 irregular spine rows in doubly sinuate band with front row much stouter than others, a few micro dots behind spines each side and a few posteriorly on middle; 5th, 3 rows, hind row not so stout as others, more micro dots each side and some strung along middle on posterior edge, continuing thus to 12th segment; 6th, about 4 rows, hind row less stout; 7th, about 5 or 6 rows, 2 front rows occupying only middle $\frac{1}{3}$ with group at each end laterally, hind row or two less stout; 8th, about 5 rows and like preceding; 9th, nearly same as preceding but spines not quite so thickly placed; 10th, 3 or 4 irregular rows still less thickly placed; 11th, 2 or 3 rows still more irregular and scattered; 12th, a few widely scattered spines anteriorly but on posterior rim 1 to 3 rows of proclinate spines, intervening space extensively set with scattered brown dots; 13th, bare of spines but many brown dots, anal stigmata set in posterior face and with arcuate group of dots over them, plates characteristic and with 3 separated micro tubercles on outer upper margin of each; 14th, micro dotted on upper face, row of small spines posteriorly, below which is the swollen tip bearing about 4 rows of larger spines. Segments 6 to 10 show short transverse posterior row laterally joining posterior group of ventral side.

Under or ventral surface—Second segment, about 4 rows of very micro spines; 3d, bare; 4th, 2 rows on middle and increased to about 4 rows at sides, large spines only at lateral ends; 5th, about 4 rows increased laterally to 5 or 6 with large spines at ends; 6th, about 5 or 6 rows, band wider at ends and there bearing large spines; 7th, over front $\frac{1}{2}$ covered with about 7 rows of small spines, becoming large spines only at lateral ends; 8th to 10th, same in about 8 rows; 11th, same but spines more irregular; 12th, about 6 or 7 rows of scattered spines and many small dots; 13th, only 1 to 3 rows of scattered spines, rest all covered with dots; 14th, small and surmounted with spines as already described. Segments 7 to 12 show lateral groups of dots posteriorly, the number of dots becoming successively greater.

The ranges of the 3 nonpolar American species are as follows:

C. phobifer Clark—New York to northern Georgia and westward to the eastern half of the Dakotas (syns. *macrotis* Brauer on maggot III, *abdominalis* Aldrich on male fly). Somewhat over 5000 feet.

C. pratti Hunter—Western Texas to Durango and lowland California (syn. *mexicana* BB nomen nudum on maggot III). Ascending to about 7500 feet.

C. jellisoni TT—Western Montana to New Mexico, northern Arizona and highland California. About 8000 to over 12,000 feet, being lower altitudes in north and higher in south.

The writer was in error in 1917 (Jour. N. Y. Ent. Soc., XXV, 100, 102, 103) in extending the range of *pratti* to the Atlantic

seaboard. It now seems evident that the males sensed in swift flight by the writer on top of Elk Mountain in northern New Mexico in 1916 were *jellisoni*. Those sensed by him in 1892 on top of Humphreys Peak, Arizona, and in 1898 on top of Sierra Blanca, southern New Mexico, were probably the same species and not *pratti*.

These 3 species, now known in both fly and maggot III, may be separated in both by the following keys:

MALE FLIES

- 1. Black mesoscutal band absent, only the ends showing at wing bases; wings blackish near costal border *phobifer* C
- Black mesoscutal band entire 2
- 2. Wings black at extreme base only *pratti* Hntr
- Wings brown near costal border *jellisoni* TT

MAGGOTS III

- 1. Ventral spines somewhat larger than dorsal spines *phobifer* C
- Dorsal spines larger than ventral spines 2
- 2. Labial sclerites gently arcuate but not curved posteriorly *pratti* Hntr
- Labial sclerites strongly curved posteriorly and describing more than a semicircle *jellisoni* TT

NOTE: *C. jellisoni* was recorded by Jellison as *pratti* in 1935 (Pr. Helminth. Soc. Washington, II, 69).

The writer has not seen the maggot III of *phobifer*. But Brauer's *macrotis* maggot III can have been no other than *phobifer*, because of the respective ranges of the 3 species. Neither *pratti* nor *jellisoni* range as far east as the old Northwest Territory, which comprised Minnesota, the eastern Dakotas and western Iowa. Nor does *pratti* range that far north. *C. jellisoni* is the distinctively high altitude or Rocky Mountain species, while *pratti* is the lower southern or Sierra Madre species. The maggot III from wapiti determined by Brauer as *ulrichii* was probably *jellisoni*.

**BIOLOGICAL AND FAUNISTIC NOTES ON THE
CICADIDÆ OF THE BIG BEND REGION
OF TRANS-PECOS TEXAS**

BY E. R. TINKHAM

An entomologist for the first time on the desert of southwestern Texas is singularly impressed by the insect life of the desert, particularly the great development of some groups and the paucity or total absence of others. Nor is the insect life as abundant as is often imagined, but some families such as the Acrididæ and Asilidæ and others, present a strikingly rich fauna not only by their numbers but also in the abundance of their species.

This is especially true of the Cicadidæ. In the spring-time the desert rings with their piercing shrills and trilling songs. To the cicada hunter the note of each species is as distinctive and interesting as the songs of the various warblers to the ornithologist. He comes to know them by the power and pitch of the trill, and is ever listening for a song that is strange and new. To the uninitiated, and perhaps the uninterested, the song of any one cicada sounds like all the others. Furthermore a cicada singing on the desert means more to the cicada collector and student than does a cicada in Louisiana, Minnesota, or any other wooded state, simply because, in the latter regions, the cicada is nearly always up in some tall tree, often impossible to locate and as difficult to approach and capture. In contrast, the vegetation on the desert is usually short and sparse, enabling the hunter to readily locate the cicada and perhaps capture it. On the other hand the higher temperature, the clarity of the atmosphere and the openness of the cover make the cicada extremely wary and it is usually found in some thorny tree or bush such as mesquite, ocotillo, or catclaw, or hiding among the spines of the prickly pear. The cicada collector trying to capture his specimen under these conditions usually attempts it only once for no matter of what strong construction the bag of the net is made, it is often badly torn and tangled up amongst the claws and spines. The cicada invariably escapes.

To capture desert cicada, the writer achieved excellent results with a *cicada swatter*. This is built on the same principle as a huge fly swatter. To construct it requires only a few minutes' work. A stick of wood some four or five feet long and an inch in thickness is selected for the handle. Then a piece of wire screen about ten inches wide and fourteen inches long is cut out and the base reinforced by folding in the corners at one end. This reinforced base is tacked on strongly to the end of the handle and the swatter is ready for use.

The hunter cautiously approaches the wary cicada trilling on some ocotillo stem, or other spiny plant, with the cicada swatter outstretched at arm's length and off to one side of the singer. When about even with it a sudden swinging blow catches the cicada on the plant or just as it commences to fly away, the flexible screen wire stunning it and knocking it to the earth, where it can readily be retrieved. On the morning of June 8, 1930, in the Chinatis Mountains of Presidio County, Trans-Pecos Texas, the writer caught forty males and seven females of the rare and wily *Tibicen townsendi* Uhler by this method. It was possibly 90 per cent effective, only a few cicadas making an escape. Only by this method could the species have been captured, for it is exceedingly wary. It was difficult enough trying to get within striking distance with the swatter, let alone trying to use an insect net.

The writer's attempts to photograph the trilling Townsend cicada at a distance of several feet proved quite a different matter and far more exasperating, and it was indeed taxing on patience, as well as on energy, to do this under a blazing desert sun. In his studies on cicadas as part of a large-scale plan to study the animal and plant life of the desert of southwestern Texas, the writer had hoped to obtain photographs of the mode of trilling in the various species of cicadas of that region. Unfortunately a number of those taken were ruined for reproduction by a somewhat faulty bellows. The writer left the desert regions before he had completed his studies.

It is hoped that the following notes made from the writer's experience during the summers of 1929 and 1930 will be of some value to the student and contribute towards an understanding

of the cicadas of this particular region. From time to time the author plans to publish notes and papers on the desert life of this region. Three have already appeared¹ and others are being prepared.

The writer wishes to thank Mr. Wm. T. Davis who has been most gracious and prompt in determining the Cicadas collected by the author.

FAUNAL DISTRIBUTION

The Big Bend region, that area of Trans-Pecos Texas lying north of the Big Bend of the Rio Grande and extending north through the Davis Mountains area, may be divided into several vegetational types or faunal regions. These represent two main types, the Lower and Upper Sonoran Faunal Zones, and each is characterized by plants and animals more or less peculiar to it. Due to the rugged physiography of the region however these two zones are never uniform, floristically speaking, but each is a composite of various plant groups of various sizes called associations or, in a more restricted sense, communities, and each of these has its own dominant plants. Nor is there any sharply defined line but one zone merges imperceptibly into the other.

The Rio Grande Valley proper is dominated largely by mesquite *Prosopis chilensis*, with scattered groves of cottonwoods and willows occurring along old water courses. In places where the soil is alkaline, screw mesquite *P. pubescens*, occurs, and catclaw, *Acacia greggii*, is found in adobe arroyo flats. Along the margin of the Rio Grande impenetrable thickets of Mexican jara, *Baccharis glutinosa* abound, but of all, the mesquite is the dominant plant.

The mesa commences as a low escarpment running more or less parallel to the river and at about one mile distant from the river. It gradually rises in elevation northward to merge with the lower slopes of the Chinati Mountains about 20 miles to the north. Everywhere it is transversed by numerous arroyos which have cut

¹ The Odonata Fauna, Can. Ent., October, 1934.

The Mutillid Fauna, Can. Ent., October, 1935.

Western Orthoptera Attracted to Light, JOUR. N. Y. ENT. SOC., 46: 339-353.

The Orthopteran Fauna, MS., 175 pages.

valleys of various sizes into the mesa. The mesa is dominated by the creosote bush, *Covillea tridentata*, with scattered plants of Spanish dagger, *Yucca macrocarpa*, and Ocotilla, *Fouquieria splendens*, which is often called the "Flame of the Desert." Many species of cactus abound, chief of which are the prickly pear (*Opuntia* spp.). Patahaya (*O. stramineus*) and in certain areas cane cactus (*O. arborescens*) forms communities of its own. In the arroyo valleys crossing the mesa, mesquite, *Condalia ovata*, desert willow, *Chilopsis linearis*, and other plants are found along the margins of the dry streams. In other regions where the soil is sandier, especially the large alluvial sand fans built up at the mouth of larger arroyos coming into the valley, Huisache, *Acacia farnesiana*, narrow-leaved yucca, *Yucca elata*, and desert willow are dominant, with clumps of *Covillea* here and there.

Many of the valleys in the Chinati Mountains have mesquite, catclaw and condalia along the stream beds, and in the larger arroyos, where water occurs, cottonwoods are found.

The lower levels of the Chinatis ranging from 4500 to 5500 feet, are dominated by Sotol, *Dasyllirion texana*, and Lechuguilla, *Agave lechuguilla*, with Covillea, Ocotilla, Huisache, and other shrubs and plants present. Above 5500 feet grasslands predominate on the mountain plateaux with live oak, *Quercus virginiana*, and scrubby Mexican walnut, *Juglans ruprestis*, found on the steep northern slopes. Red cedar, *Juniperus monosperma*, occurs on the peaks at approximately 6500 feet elevation.

The northern part of Presidio and the southern portions of Jeff Davis counties, comprising a considerable portion of the Big Bend Region, is a level, far-stretching grassland dominated by various species of *Bouteloua* or gramma grass, with considerable bear grass, *Nolina texana*, on its southern margin, where it merges with the desert vegetation of the Lower Sonoran. On the north, these grasslands, representing the Upper Sonoran, stretch throughout the valleys of the Davis Mountain range and merge with groves of live oaks in the valleys and with oaks, and cedars, on the mountain slopes. At higher elevations the Piñon pine, *Pinus edulis*, is found.

DISTRIBUTION OF THE ASSOCIATED CICADA FAUNA

The distribution of the cicada fauna, dependent as it is upon

the flora, for the nymphs feed upon the roots and the adults suck the sap of various plants, presents a number of very interesting features.

The dominant cicada of the Rio Grande Valley proper is *Diceroprocta cinctifera*. This species is practically restricted to the impenetrable thickets of mesquite and the nymphs probably feed on the roots of the mesquite. This species is also found in the arroyo valleys of the Chinati Mountains, but only where mesquite occurs.

Where the sandy alluvial fans cross the valley floor, the dominant cicada is *Diceroprocta eugraphica*. It is found most commonly singing in creosote, but occasionally in catclaw and other plants.

On the mesa proper, *Cacama calvata* is very abundant and appears to be restricted to Ocotillo. The exuviae are commonly found on the mesa floor, but whether the nymphs feed on Ocotillo, creosote, or perhaps prickly pear, remains to be ascertained. The adults probably prefer Ocotillo, for the narrow upright stems afford a good trilling surface and enable the wary cicada to observe the approach of enemies. The adults also feed on prickly pear and when disturbed appear to possess a strong heliotropic response, rocketing towards the sun with a loud screeching trill.

Beameria venosa, one of the smallest of the Nearctic Cicadidæ, is found feebly trilling in grasses and low plants such as lechuguilla and the skeleton weed, *Candelaria*, along the sides of arroyos and at low elevations in the Chinati and Davis ranges.

In the arid Chinatis the striking cicada dominant is the large handsome *Tibicen townsendi* Uhler. This species is found trilling on Sotol, Huisache and Ocotillo. Plate VI, Figure 1, illustrates a male Townsend cicada trilling in a Huisache bush; the photograph was taken during the actual progress of the song. Figure 2 shows a Townsend female in the act of ovipositing in the broken-off stub of the flower stalk of a Sotol plant. Upon examination this stub was found to have numerous oviposition scars of previous years and Sotol is undoubtedly the host plant of this interesting cicada.

In the Davis Mountains at Paisano, *Tibicen inauditus* Davis was found in the live oak trees (*Quercus grisea*) but it is not a common species. It is not known whether the nymphs feed upon

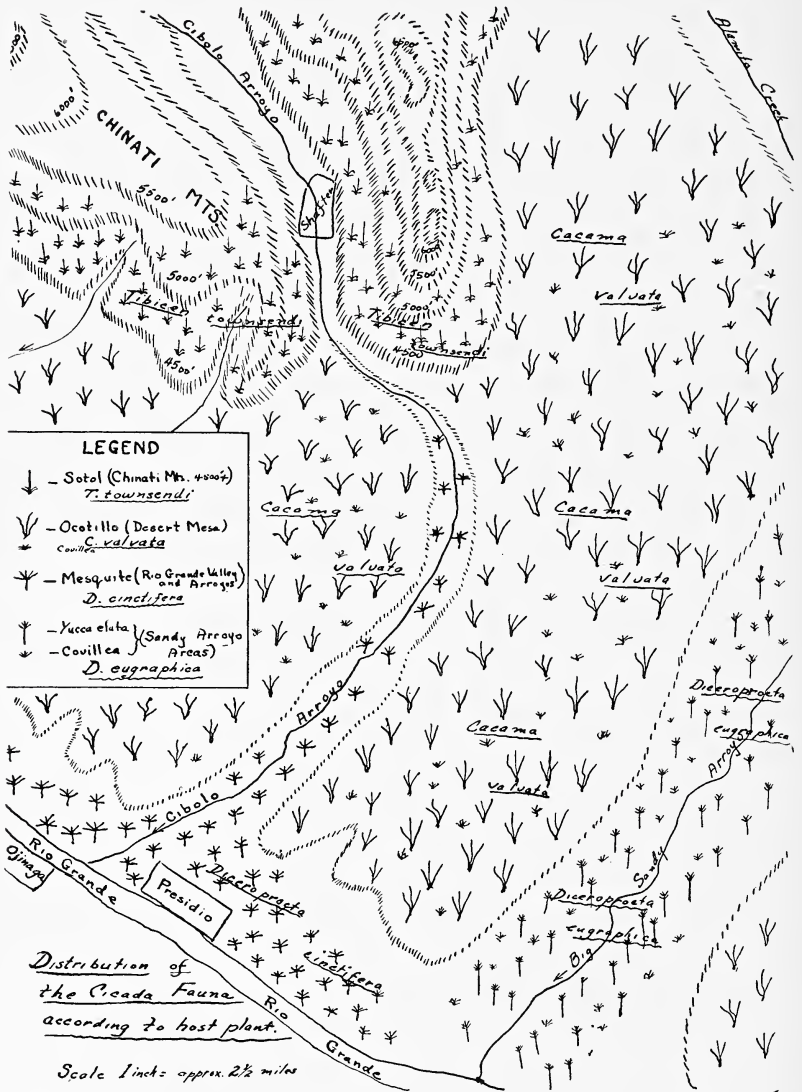

FIG. 1. Distribution of the cicada fauna according to host plant.

the live oaks. In this same general region adults of *Beameria venosa* were common in the grass and *Pacarina puella* Davis was taken rarely in the cedars, which may also be the nymphal host plant.

Of other species of the region the writer has little to offer from personal experience. The Gottholt Brothers of Marfa informed me that *T. dorsata*, with its piercing song, sings in the oak trees of the Davis mountains during the month of August. Davis (1932) reports *Cicada chisos* from the Davis Mountains and was there associated with *Tibicen inauditus* in the oak trees. Davis states that it is a much shyer species than *inauditus* and recognized by its pulsating "ticker-ticker ticker" note. In the same paper Davis describes the variety *limpia* of *D. cinctifera* from Limpia Canyon in the Davis Mountains. This variety is structurally different from *cinctifera* and probably represents a geographically isolated race of the species. It was found in cottonwoods, whereas *cinctifera* is mainly a denizen of mesquite thickets. In the same publication Davis describes the interesting *Okana-godes terlingua* from Terlingua but without any faunistic notes. As the writer has been in the Terlingua area on a number of occasions he wishes to say that that area is Lower Sonoran and almost entirely composed of creosote mesa. *Terlingua* is unquestionably a Lower Sonoran species with creosote as its probable host plant. Two other species have been described in recent years from the Chisos mountain area, namely *Tibicen chisosensis*, in 1934, and *Diceroprocta canescens*, in 1935. Unfortunately no faunistic notes were given with the specimens by the various collectors. *Canescens* occupies the area north of the Chisos which is predominately creosote mesa for miles and miles. Its distribution and association with *D. eugraphica* undoubtedly stamps it as a member of the Lower Sonoran Faunal Zone. Little is known of *T. chisosensis*, but it is probably a species of the oak belt in the Chisos Range.

SEASONAL DISTRIBUTION

The first cicada to appear on the desert mesa of the Rio Grande Valley, at Presidio, is the large *Cacama valvata*. In the spring

of 1929 it reached its maximum abundance in early May and it was then so abundant as to make the desert ring with its high-pitched, piercing trill. A few specimens first appear towards the end of April with the maximum in mid May to disappear in June. The species starts to sing at about 10:00 to 10:30 A.M., when the temperature ranges about 82 degrees Fahrenheit; the sun passing under a cloud causes a lull in the song.

Cacama is soon followed by *Diceroprocta cinctifera* and *D. eugraphica* which commence to emerge in early May and reach their greatest numbers in late May or early June. From that time on their numbers begin to dwindle although there are some that are still present in July. The writer took one specimen of *cinctifera* in September, 1928, but such a catch is rare and may represent a fall brood emergence. The small *Beameria venosa* (Uhler), formerly placed in the genus *Proarna*, appears later on in May to reach its maximum in June. *Pacarina puella* though not common appears to be commonest in June.

Tibicen townsendi, an inhabitant of the desert mountains, starts to emerge in late May to reach its greatest numbers in mid June and by the middle of July only a few worn individuals remain. *T. inauditus* appears to be commonest in mid June. *T. dorsata* is a late summer species appearing in the Ft. Davis region of the Davis range in August. Although not observed *T. duryi* appears in the months of June and early July and of the species discussed is probably the only one pertaining to the Transitional Faunal Zone.

In general May and June are the Cicada months, July still possesses many but few persist through August into September.

SONG AND MODE OF TRILLING

Although it may not be possible to differentiate each species by its mode or position assumed while singing, it would appear from field observations that the various genera may be distinguished.

The genus *Diceroprocta* assumes a very interesting and characteristic attitude while trilling, raising the anterior portion of its body away from the resting surface by straightening the

anterior legs so that the longitudinal axis of the body is tilted at an acute angle away from the supporting surface. While in this position the wings are drawn sharply downwards below the body so that the wings usually project beyond the further side of the mesquite limb upon which it is usually trilling. *D. cinctifera* and *D. augraphica* are alike in this respect as is also *D. apache* from the desert regions of Arizona and southern California. The song of *cinctifera* is a loud metallic zing; of *eugraphica* less voluble and less metallic.

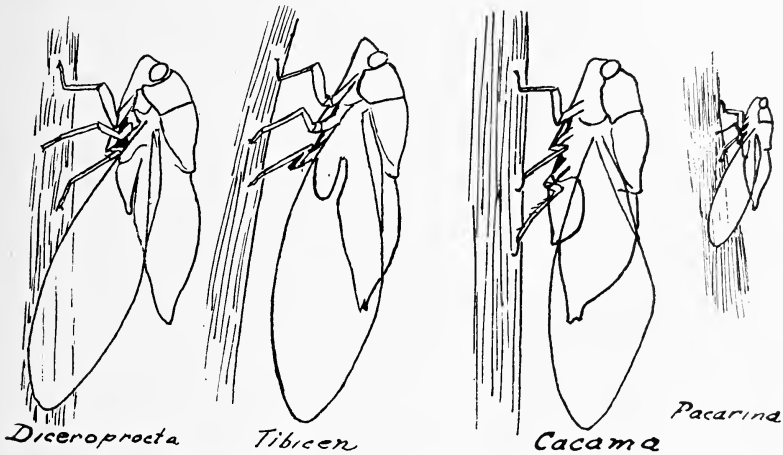

FIG. 2. Positions assumed by *Diceroprocta*, *Tibicen*, *Cacama* and *Pacarina* while trilling.

Cacama valvata, the only species of *Cacama* in the region, trills with the longitudinal axis of the body and wings nearly parallel to and raised off of the supporting plane. The song has a high-pitched, piercing, metallic ringing quality to it.

Tibicen resembles *Cacama* closely in the position assumed but the abdomen is more arched and deflexed at the apex and the axis slightly subparallel caudally (see photograph of male singing). The song of *T. townsendi* of the Chinatis has a high-pitched, metallic ringing quality to it. Although not personally observed the song of *T. dorsata* is said to be piercing like a steam whistle.

Pacarina tilts slightly with its wings drawn downwards sug-

gesting, to a certain degree, a miniature *Diceroprocta*. *Beameria*, being a feeble triller of minute size, exhibits no peculiarity but rests and sings in the same position.

COLLECTIONS AND DISTRIBUTIONAL NOTES

Actual specimens recorded here were taken by the writer; other notes on various species are derived from the publications of Wm. T. Davis.

Tibicen townsendi Uhler

Abundant on Sotol in Chinati Mts., Presidio Co., Texas, 40 ♂, 7 ♀, June 9, 1930; 1 ♂, July 14, 1929 (worn). Chisos Mts., Brewster Co., Texas, 1 ♂, July 17, 1930 (at north base of Mt. Emory at about 5500 feet elevation). This species is known from southwestern Texas, New Mexico and Arizona.

Tibicen inauditus Davis

Paisano, Jeff Davis Co., elev. 5200 feet, 4 ♂, June 23, 1930 (*Quercus grisea*). Davis records this species from Western Texas, and the Chisos mountains, New Mexico and Oklahoma.

Tibicen duryi Davis

Reported by Davis from 8000 feet in the Davis Mts., and 7000 feet in the Chisos; also known from Utah, northern Arizona, Colorado and New Mexico.

Tibicen chisosensis Davis

Davis described this species, in 1934, from specimens taken in the Chisos Mountains by Dr. Dana Casteel and Mr. H. B. Parks, Jr., of the University of Texas.

Diceroprocta cinctifera (Uhler)

Common on mesquite at Presidio in the Rio Grande valley, in valleys of the Chinati Mountains having mesquites and from mesquite arroyos some 20 miles north of the Chisos Mountains and the Chisos Mts., July 17-18, 1930. Davis records *cinctifera* from central Texas, Rio Grande valley, New Mexico and Arizona. The distribution of this species up the Rio Grande valley from central Texas is probably accounted for by the distribution of its host plant, mesquite.

Diceroprocta cinctifera var. *viridicosta* Davis

This variety was described from the Del Rio region within recent years.

Diceroprocta cinctifera limpia Davis

Davis described this new race, in 1932, from Limpia Canyon in the Davis mountains. It probably represents an isolated geographic race long separated from the main distribution of *cinctifera* in the Rio Grande Valley.

Diceroprocta eugraphica Davis

A common species of the region found mainly on *Covillea* at Presidio, the Chinati Mountains, Marfa, Chisos Mountains and the creosote-covered desert forty miles north of the Chisos Mountains, from June to late July. The Chisos records were made July 17-18, 1930. This species was described from New Mexico and it is also known from Kansas, Oklahoma, Texas and Arizona.

Diceroprocta canescens Davis

This interesting new species was described, in 1934, from the region north of the Chisos Mountains. It was associated with *D. eugraphica* and is undoubtedly a member of the Lower Sonoran Fauna.

Diceroprocta texana Davis

Carlsbad, N. Mex., 3 ♂, July 19, 1930 (E.R.T.; on *Prosopis glandulosa*). This species has been reported from Uvalde, Del Rio, Midland and other localities in Texas and New Mexico.

Diceroprocta bibbyi Davis

This species was named in honor of my friend Mr. F. F. Bibby who collected the series at Langtry, Texas. Since then it has been taken in the Chisos Mountains. It is commonly found on creosote bush.

Cacama valvata Uhler

This species is common on Ocotillo and creosote at Presidio in May, 1929; Chinati Mts., June 7 and July 6, 1930, and Paisano, June 29, 1930. Davis reports this species from Colorado, Texas,

Utah, New Mexico and Arizona where the species is common in late May and early June on the mesas of creosote, mesquite and Cholla.

Cicada chisos Davis

One specimen taken near Marfa, without date, was in the Gott-holt Collection at Marfa. The species was described from the Chisos Mountains, in 1916, and further reported from Alpine, the Davis Mts., and Mexico. This species dwells in oaks associated with *Tibicen inauditus*.

Pacarina puella Davis

Paisano, elevation 5200 feet, 4♂, June 23, 1929 (cedars). Davis reports this species from Louisiana, Texas, Oklahoma, Arizona and northern Mexico.

Okanagodes terlingua Davis

Described by Davis in 1932 and known only from the type locality, Terlingua, in Brewster County, Texas. The species is a member of the Lower Sonoran Faunal Zone.

Platypedia falcata Davis

A single specimen, the type, was described from El Paso, Texas, in 1920.

Beameria venosa (Uhler)

Chinati Mts., June 16, 1929, common on grass and lechuguilla. Paisano, June 23, 1929 (common in grass). In 1934 Davis erected the new genus *Beameria*, in honor of Dr. Raymond Beamer, for *Prunasis venosa* Uhler which had, in 1911, been placed in the genus *Proarna* by Distant. This species is known from Nebraska, Kansas, Oklahoma, Colorado, New Mexico and Arizona.

FAUNAL DISTRIBUTION

In a more comprehensive study on the wonderfully developed Orthopteran fauna of the Big Bend Region of Trans-Pecos Texas, which is in manuscript form but unpublished, the writer has ascertained the existence of a Mexican Sonoran fauna in this

region. East of the Continental Divide this fauna is known only from the Chinati Mountains of Presidio County and the Chisos Mountains of Brewster County of the Big Bend Region of Trans-Pecos Texas. South of these regions this particular fauna extends far southwards into Mexico. West of the Continental Divide this fauna appears only in south-central Arizona in the mountains extending from the Baboquivaris on the west, through the Tumacacoris and Santa Ritas to the Huachucas on the east.

From these studies the writer felt it necessary to divide the Lower and Upper Sonoran Faunal Zones into two component faunal elements which in this paper will only be briefly outlined.

A. Lower Sonoran Zone

- a. American Lower Sonoran Fauna—characterized by the desert areas of western Texas, Arizona, southeastern California and southern Nevada with creosote [*Larrea (Covillea) tridentata*] the dominant plant.
- b. Mexican Lower Sonoran Fauna—a fauna composed of Mexican species finding their northern limits of distribution in the Chinati and the Chisos Mountains of the Big Bend Region of Trans-Pecos Texas and in the Baboquivaris, Tumacacoris, Santa Ritas, and Huachucas of southern Arizona with Ocotillo, Agave, Sotol and Cacti, the dominant plants.

B. Upper Sonoran Faunal Zone

- a. American Upper Sonoran Fauna—characterized by grasslands at elevations generally above 5000 feet to 6500–7000 feet which extend from the Davis Mountains, the Highlands of northern Mexico and the southeastern corner of Arizona, north through New Mexico to the southeastern tip of Alberta and east of the Rockies to the Missouri River in North Dakota and the central portions of South Dakota, Nebraska and Kansas, western Oklahoma and the Panhandle region of Texas.
- b. Mexican Upper Sonoran Fauna—ranging in elevation from 5000 to 6500 feet in the Chinatis and Chisos Mts., of the Big Bend region of Trans-Pecos

and the Baboquivaris, Tumacacoris, Santa Ritas and Huachuacas of southern Arizona and composed of an oak-savannah type of vegetation.

- C. Transitional Zone—generally represented by the pine belt in the mountains of the southwest and ranging from elevations of 6500 and 7000 feet to the upper limits of the pines at approximately 9500 feet altitude.

FAUNAL DESIGNATION OF THE CICADIDÆ OF THE BIG BEND AND THE TRANS-PECOS TEXAS REGIONS

A. Lower Sonoran Faunal Zone

a. American Lower Sonoran Fauna

Big Bend Region	Trans-Pecos Texas Region
Big Bend Region	
<i>Diceroprocta cinctifera</i>	<i>D. cinctifera</i>
<i>Diceroprocta eugraphica</i>	<i>D. eugraphica</i>
<i>Cacama valvata</i>	<i>D. cinctifera viridicosta</i>
	<i>D. texana</i>
	<i>D. delicata</i>
	<i>C. valvata</i>
	<i>Platypedia falcata</i>

b. Mexican Lower Sonora Fauna

<i>Tibicen townsendi</i>	<i>T. townsendi</i>
<i>Tibicen chisosensis</i>	<i>T. chisosensis</i>
<i>Diceroprocta bibbyi</i>	<i>D. bibbyi</i>
<i>Diceroprocta canescens</i>	<i>D. canescens</i>
<i>Okanagodes terlingua</i>	<i>O. terlingua</i>

B. Upper Sonoran Faunal Zone

a. American Upper Sonoran Fauna

<i>Tibicen inauditus</i>	<i>T. inauditus</i>
<i>Tibicen dorsata</i>	<i>T. dorsata</i>
<i>Diceroprocta cinctifera limpia</i>	<i>T. montezuma</i>
<i>Pacarina puella</i>	<i>D. cinctifera limpia</i>

Beameria venosa *D. vitripennis?*
 P. puella
 B. venosa
 Melampsalta texana?

b. Mexican Upper Sonoran Fauna
 Cicada chisos *Cicada chisos*

C. Transitional Faunal Zone
 Tibicen duryi *T. duryi*

HOST PLANT PREFERENCE OF THE CICADIDÆ OF THE BIG BEND REGION

Species	Adult Host Preference	Probably Nymph Host
<i>Tibicen townsendi</i>	Sotol and Huisache	Sotol
<i>T. inauditus</i>	Oaks	Same
<i>T. dorsata</i>	Oaks	Same
<i>T. duryi</i>	Oaks or pines	Same
<i>Diceroprocta cinctifera</i>	Mesquite	Same
<i>D.c. limpia</i>	Cottonwoods	Same
<i>D. eugraphica</i>	Creosote, catclaw	Same
<i>D. bibbyi</i>	Creosote, mesquite	Same
<i>D. canescens</i>	Creosote, mesquite	Same
<i>Cacama valvata</i>	Ocotillo, creosote, prickly pear	Same
<i>Cicada chisos</i>	Oaks	Same
<i>Okanagodes terlingua</i>	Creosote	Same
<i>Pacarina puella</i>	Cedar	Same
<i>Beameria venosa</i>	Grass, lechuguilla	Same

ENEMIES OF CICADAS—INSECTS AND BIRDS

One would hardly imagine that cicadas, especially those of large size and as wary and swiftly-flying as they are, should have their enemies.

It is hoped that the notes here appended will serve as a small contribution to this obscure subject. They all pertain to one of the largest cicadas of the region, namely, *Cacama valvata*. It is generally known that the large wasp, *Sphecius speciosus* Uhler, is a cicada predator. On one occasion the writer had an oppor-

tunity to observe this predatism. About the end of May, 1930, he was near a colony of these cicada wasps breeding in the sandy banks of an irrigation ditch, close to a pumping station on the north banks of the Rio Grande. Suddenly a large object came flying and buzzing along from across the Mexican side of the river into the colony and upon capture the writer found in his net a large cicada wasp and a teneral adult of *Cacama valvata*. Later on in the summer at another place, he observed a large metallic blue Sphecoid wasp, probably *Chlorion cyaneum*, light with a specimen of *Cacama* near the entrance to its burrow. The cicada was left at the mouth of the burrow while the wasp made a preliminary inspection of its tunnel. Returning, it seized the cicada by its head and dragged it, head foremost, down into the host chamber previously excavated for some unfortunate insect.

Stranger still was the accidental discovery made one evening in June at about dusk. The writer was out on the desert near Presidio and happened to have along a 410 gauge bird collecting pistol. Suddenly he came upon a Texas night hawk, *Chordeiles acutipennis texensis* Lawrence. The actions of the bird seemed to indicate something was wrong for it could fly only with difficulty and the end of its body seemed to be very heavy, causing the creature to fly in a peculiar manner. As the writer was licensed, he was prompted to shoot, and fortunately so, for upon examination the abdomen was found to be greatly distended. Later when skinning the bird it was found that this enormous distention was caused by the greatly swollen gizzard. Imagine the writer's surprise when, on dissection, he found the gizzard contained five large and freshly engorged specimens of *Cacama valvata*. The writer could not restrain his astonishment, for he had always supposed that nighthawks fed exclusively on mosquitoes and small insects, but here were five large cicadas in the gizzard of a single bird. How this night hawk captured these large, fast-flying cicadas by swooping them into its mouth is rather difficult to picture. No other explanation, however, seems plausible, as the feet of night hawks are very small and weak and entirely unfitted for grasping objects while on the wing. Furthermore, they cannot even perch upon a limb. It has been generally thought that night hawks and the related whip-poor-

wills and poor-wills are insectivorous only on small insects, such as mosquitoes, gnats, midges, flies, and similar insects that swarm in the crepuscular light of dusk and dawn. Their mouths, however, are cavernous in proportion to their heads and from these observations it appears that they use them to their fullest capacity. Probably in the height of the cicada season these avians of the twilight hours will live almost exclusively on cicadas. Unfortunately the writer made no further efforts to secure specimens of nighthawks for stomach content analysis. The food habits of even our commonest birds are only partially known; here surely is a field for useful scientific exploration.

FALSE CICADAS

A number of large desert species of the Coleopterous family, Buprestidæ, stridulate so deceptively that they can easily deceive a person familiar with the songs of the various species of Cicadidæ. The buprestid that produces the most baffling song is the large Huisache wood-borer, *Psiloptera drummondi* Cast. This species is usually heard trilling in clumps of the desert shrub called Huisache, *Acacia farnesiana*, which appears to be its host plant, at noon or in the early afternoon on very hot summer days in August and September. Another rarer species is *Hippomelas sphenicus*, which has a coarser and more staccato-like song. It is found on mesquite. I have also observed a similar habit in the far north for *Dicerca prolongata* trilling on white poplar, *Populus tremuloides*, in Glacier National Park, Montana, and at Edmonton, Alberta. In *Dicerca* the elytra are raised well above the abdomen, but the song is softer than that of the desert species. The sound in the larger desert species, such as *Psiloptera drummondi*, can be likened to the staccato noise produced by a riveting machine. Trilling may be found to be of common occurrence among the larger species of the Buprestidæ.

BIBLIOGRAPHY

DAVIS, WM. T.

1917. Sonoran cicadas collected by Harry H. Knight, Dr. Joseph Bequaert and others with descriptions of new species. Jour. N. Y. Ent. Soc. 35: 203-215, 4 Figs., Pl. 13.
1919. Cicadas of the genus *Cacama*, with descriptions of several new

- species. Jour. N. Y. Ent. Soc., 27(1): 68-79, Figs., Pl. 13-14.
1920. North American cicadas belonging to the genera Platypedia and Melampsalta. Jour. N. Y. Ent. Soc., 28(2): 95-135, Pl. 5.
1928. Cicadas belonging to the genus Diceroprocta with descriptions of new species. Jour. N. Y. Ent. Soc., 36: 439-458, Figs., Pl. 17-18.
1930. The distribution of cicadas in the United States with descriptions of new species. Jour. N. Y. Ent. Soc., 38: 53-72, Figs., Pl. 8.
1932. Additional records of North American cicadas with descriptions of new species. Jour. N. Y. Ent. Soc., 40: 241-264, Pl. 5-6.
1934. New cicadas from North America. Jour. N. Y. Ent. Soc., 42: 38-60, Figs., Pl. 2-4.
1935. New cicadas with notes on American and West Indian species. Jour. N. Y. Ent. Soc., 43: 173-198, Figs., Pl. 13-15.

PLATE VI

- Figure 1. Male *Tibicen townsendi* photographed while singing on Huisache bush.
- Figure 2. Female *T. townsendi* ovipositing in the dry broken-off stub of a Sotol plant (*Dasyliirion texana*).
- Figure 3. Male *Cacama valvata* trilling in a Creosote bush.



CHARLES W. LENG

In July, 1894, after my graduation at Columbia, I took a job at eight dollars a week with the firm of John S. Leng's Son & Co. This firm dealt in steel tubing manufactured in Birmingham, England, and in bicycle parts and sundries, with headquarters at 4 Fletcher Street on one of New York City's narrowest thoroughfares. In this business Charles W. Leng was the managing partner. Associated with him as partners were two brothers, their mother (a silent partner), Thomas G. Voorhis (a brother-in-law) and James B. Pratt.

At this time Charles W. was a very active and energetic young man of 34 with red hair and a quick temper which never lasted very long. Those were busy days in the bicycle business and our hours were from 8:30 in the morning until nearly midnight during the busy season, with a few minutes off for an excellent lunch at a small beer saloon conveniently located on the nearest corner, and ample time for dinner at Peck's restaurant on Fulton Street where each one of us drank many cups of coffee. Our very "homey" office was heated in winter from an open stove in which we burned cannel coal. During our quieter seasons dinners and social evenings on Staten Island were frequent at Charles' home or that of his mother, or with Mr. and Mrs. Voorhis, and altogether we were quite a happy family.

From February 1, 1898, until September, 1901, I was one of the junior partners of the firm so that for seven years a very intimate and pleasant business relation existed between Charles and myself in which I served both as employé and partner.

During my college years and for some time afterward, I bought and sold beetles, and in this enterprise Charles was of great assistance both as a generous buyer of whatever was lacking in his collection, and furnishing from his duplicates various specimens for my other customers.

Our entomological relations, however, were by no means entirely of a business character but included many collecting excursions on Staten Island where he and William T. Davis introduced me to all of the best places for aquatic beetles. On one of these

outings we took in one dredge of the net one thousand specimens of *Bidessus flavicollis* (Lec.), which I had never before taken in the field.

Although never a companion of Charles on any of his collecting trips away from home, Mrs. Sherman and I were at least the partial instigators of his visit in September, 1909, to the White Mountains of New Hampshire. One of my treasured letters he wrote with great enthusiasm on September 23, the day after he and Mrs. Leng returned from Randolph, N. H., asking us to "come down with your baby (Elizabeth, then nearing two years) and swap yarns."

All of us who were members of our society during his active years will always remember the regular Election Day gatherings at the Leng home at West New Brighton, and the wonderful minutes of our meetings which he gave us during his long service as secretary. And the coleopterists among us enjoyed greatly the Saturday afternoon sessions at the American Museum, working on the local beetle fauna, under his guidance.

Mr. Leng began his entomological writings very early in life, with his synoptic tables of Cerambycidae in the early Bulletin of the Brooklyn Entomological Society, of which he was a charter member. Even during the very active years in the bicycle business, his interest in beetles never waned. In 1902 there was published in the Transactions of the American Entomological Society his "Monograph of North American Cicindelidæ," and his "Notes on Coccinellidæ" in four parts appeared in the JOURNAL OF THE NEW YORK ENTOMOLOGICAL SOCIETY, 1903-1911.

About 25 years ago at my request Mr. Leng prepared his "Catalogue of the Coleoptera of America, North of Mexico," which was published in December 1920. This work of nearly 500 pages is much more than a mere catalogue. Our species, more than 18,000 in number, are not only listed, but their distribution is shown, and there is also a page citation of the original description of each species. At the beginning is a comprehensive essay on the various systems used in the classification of the Coleoptera: at the end is a complete bibliography of the literature. A Supplement was published in 1927, and the second and third Supplements, printed under one cover, appeared in 1933. In preparing

these Supplements after Mr. Leng assumed the directorship of the Staten Island Institute of Arts and Sciences, Andrew J. Mutchler gave valuable assistance, which was gratefully acknowledged by Mr. Leng.

The Leng-Mutchler "Catalogue of the Coleoptera of America, North of Mexico," is Mr. Leng's greatest contribution to entomological science and it is a very great contribution indeed.—

JOHN D. SHERMAN, JR.

CHARLES W. LENG AND THE NEW YORK ENTOMOLOGICAL SOCIETY

BY WM. T. DAVIS

On January 24, 1941, Charles William Leng died at his home, 439 Clove Road, Staten Island, and the New York Entomological Society lost one of its most illustrious members, and the Staten Island Institute of Arts and Sciences its Director for the past twenty-one years. Mr. Leng was born on Staten Island, April 6, 1859, but shortly thereafter the family removed to Brooklyn, Long Island, where they remained until March, 1879, when they returned to Staten Island.

While living in Brooklyn he was a student at the Brooklyn Polytechnic Institute from which he graduated in 1877, receiving the degree of Bachelor of Science. He also helped start the Brooklyn Entomological Society and drew the seal in use on the cover of the Bulletin of the Society since 1878. He was one of the incorporators of the Brooklyn Society in 1885, and served again in that capacity fifty years later in 1936, when the Society was re-incorporated. It was under the auspices of the Brooklyn Society that he commenced his studies in Coleoptera, and the publication of his Synopsis of the Cerambycidae. He aided the Brooklyn Society in many ways, and was elected its Honorary President on December 14, 1922.

He contributed to the first volume of the JOURNAL OF THE NEW YORK ENTOMOLOGICAL SOCIETY in 1893, and, with Mr. Beutenmuller commenced the publication of a "List of the Coleoptera of North Eastern America," and also of a "Preliminary Handbook of the Coleoptera of North Eastern America."

In the published minutes of our Society for 1902, we read that: "Mr. Charles W. Leng, of 4 Fletcher St., N. Y., was proposed as an active member by Mr. Davis," at the meeting of March 18, 1902, and was duly elected at the April meeting. At that time he was an iron merchant, but gave up his mercantile interests to become Director of the Staten Island Institute of Arts and Sciences in 1919. He was one of the founders of the old Natural

Science Association of Staten Island in 1881, which later became the Institute.

Upon his election to membership in 1902, Mr. Leng became a regular attendant at the meetings of our Society, and his help both as an executive and as an entomologist was soon apparent. He was elected Vice-President, January 6, 1903, and served as President from January 15, 1907, to January 2, 1912, when he became Secretary. He held that office for 19 years or until January 6, 1931. Meanwhile he wrote many entomological papers as well as a "History of the New York Entomological Society, 1893-1919," which appeared in the JOURNAL for 1918. It is to Mr. Leng and Mrs. Annie Trumbull Slosson that we owe much of the recorded history of our Society. Mr. Leng was solicitous for preserving the memory of his entomological friends, and accordingly published appreciative notices of their lives, both in our JOURNAL and in the Bulletin of the Brooklyn Entomological Society. Of happy memory to some of the older members of the Society are the field days spent on Staten Island, which often terminated at the home of Mr. Leng and with an examination of his extensive collection of Coleoptera.

W. S. Blatchley and C. W. Leng were the authors of "Rhynchophora or Weevils of North Eastern America," published in 1916. This useful work gives descriptions of nearly 1,100 species and includes many helpful illustrations.

In 1920 Mr. John D. Sherman, Jr., published Mr. Leng's monumental work, a "Catalogue of the Coleoptera of America, North of Mexico," which enumerates 18,000 named forms, citing the original description of each species, and giving in a general way its known distribution. This great work includes an Essay on Classification, as well as a Bibliography of Taxonomic Coleopterology (to January 1st, 1919). He lists 141 of his own papers on Coleoptera, and notices of the passing of his entomological friends.

In the Proceedings of the Natural Science Association of Staten Island for January 12, 1884, there is a paper on "The Cicindelidæ of Staten Island," which appears to have been Mr. Leng's earliest contribution to entomology. In the years that followed he published many notes and papers in the proceedings of the

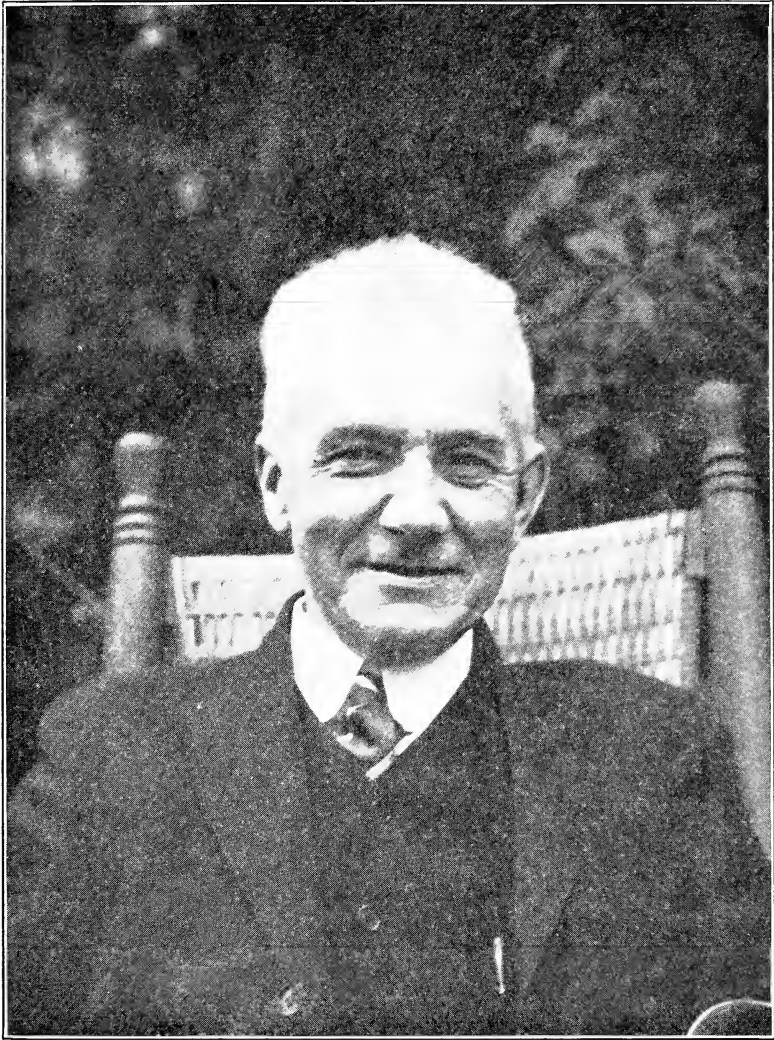

CHARLES W. LENG
(Photograph by Wm. T. Davis, Oct. 15, 1914)

Staten Island society. After becoming Director of the Institute in 1919, he turned his attention more and more to the history of Staten Island, and was the author of several papers on local history. In 1930 the Lewis Historical Publishing Company brought out four volumes of "Staten Island and Its People," by Charles W. Leng and Wm. T. Davis. As the work was favorably received, a fifth volume was issued in 1933. The getting together of the material for these volumes was a considerable task, and occupied much of Mr. Leng's attention for several years. He was very helpful to the many who desired information concerning their ancestors and the old families of the Island, and he acquired a considerable knowledge of the local ecclesiastical records.

There could hardly have been a more helpful man than the genial Mr. Leng. Whatever aid he could render was given so pleasantly and with such good will, that naturally he was often consulted. He always had time, or appeared to have, which is said to be one of the attributes of the competent man. It is with pleasure that the writer looks backward over the sixty-one years of close association with one so gifted and of such a happy disposition.

TWO NEW SUBSPECIES OF PHLEBODES TIBERIUS MOESCHLER

By E. L. BELL

Phlebodes tiberius Moeschler is widely distributed from Mexico through Central America, South America to southern Brazil and in Trinidad, British West Indies, and is subject to considerable variation in the maculation, color shade of the maculation and in the color of the under side of the wings.

Some of the variations widely differ from the nymotypical form and appear to have become stabilized in certain localities and where this has occurred they have attained a subspecific status. Two of these extreme forms, which so widely differ from typical *tiberius* as to be taken for other species, are described here and the general characters of the maculation of *tiberius* Moeschler and the form *reticulata* Ploetz are given for the purposes of comparison with the newly described subspecies of *tiberius*.

In view of the uncertainty of the identity of Cramer's *pertinax*, the type of the genus *Plebodes*, it may be that *tiberius* and several other allied species are not congeneric with *pertinax*.

Phlebodes tiberius Moeschler

1882. *Apaustus tiberius* Moeschler, Verhandlungen der kaiserlich-koeniglichen zoologisches-botanischen Gesellschaft in Wien, xxxiii, p. 329, Surinam "Innern."
1900. *Phlebodes tiberius* Godman, Biologia Centrali-Americana, Rhopal., ii, p. 553; iii, pl. 99, figs. 40-43.
1924. *Phlebodes tiberius* Draudt, in Seitz Macrolepidoptera of the World, v, p. 966, pl. 187a.

Moeschler's description, based on a single male, is detailed and clear and it is not difficult to find specimens which agree or very closely agree with it. Godman's figures are excellent but those of Draudt do not represent the typical form.

On the upper side of *tiberius* males there is a discal band on the primaries composed of four yellow spots, one each in inter-

spaces 1 to 4, the upper one very small, and there are three subapical spots of the same color, the upper one smaller than the others. Occasional individuals lack the small spot in interspace 4 and the upper subapical spot. The upper side of the secondaries is unmarked.

On the under side there is no spot of the discal band in interspace 1 of the primaries. On this side the ground color of the secondaries is brownish, the veins are yellowish and there is a discal band of yellowish spots.

On the upper side of *tiberius* females the spot of the discal band in interspace 1 of the primaries is yellowish, those above are whitish or a little tinged with yellow. The secondaries above show dim traces of a discal band of small yellowish spots.

The under side of the primaries is brown and there is a purplish sheen in the apical area, the subapical spots and those of the discal band in interspaces 2 and 3 are repeated and in addition there is a small spot in interspace 4 and another in 5, the spot in interspace 1 is absent or dimly visible. The secondaries are brown with a purplish sheen, the veins are paler and there is a discal band of pale spots.

In the collections of The American Museum of Natural History and the Academy of Natural Sciences of Philadelphia there are specimens of *tiberius* agreeing or closely agreeing with Moeschler's description, from La Ceiba and Lancetilla, Tela, Honduras; Canal Zone, Panama; Sint Barbara Pln., Surinam River, Surinam; Putumayo River, Peru; Santarem, Brazil; Sapucay, Paraguay.

Phlebodes tiberius form reticulata Ploetz

1883. *Hesperia reticulata* Ploetz, Stettin Entomologische Zeitung, xlv, p. 208. Lagunayra; Chiriqui.
1891. *Pamphila meton* Mabille, Annales de la Societe Entomologique de Belgique, xxxv, Comptes-Rendus des Seances, p. clxxiv. Tefte.
1891. *Pamphila suffenas* Mabille, Annales de la Societe Entomologique de Belgique, xxxv, Comptes-Rendus des Seances, p. clxxv. Porto Cabello.
1907. Godman, Annals and Magazine of Natural History, (7) xx, p. 145.

1924. *Phlebodes reticulata* Draudt, in Seitz Macrolepidoptera of the World, v. p. 966; pl. 187a.

The description by Ploetz covers quite a little variation in maculation and Godman says that the four figures in the unpublished drawings of Ploetz seem to represent more than one species. Draudt's figures of the male and female are perhaps taken from the Ploetz drawings and those of the male are taken to represent the type of *reticulata*; the figures of the female are unlike any of the specimens of that sex of *reticulata* before the writer. The figure of the upper side of the male is too highly colored green in the basal area of the wings, which may possibly be due to a little inaccuracy in the reproduction of the plate.

Godman says *meton* and *suffenas* Mabilles are the same as *reticulata* and this seems to be borne out by Mabilles's descriptions.

On the upper side of the primaries of the male there are small but well-defined spots of the discal band in interspaces 4 and 5. On the secondaries there is a discal band of yellow spots varying from small, rather indistinct, ones of approximately equal size to a well-defined band in which the spot opposite the end of the cell is elongated, extending inwardly into the cell, as shown in the Draudt figure of the upper side of the male. On the under side of the primaries of the typical form there is usually at least a trace of a small spot of the discal band in interspace 1. On the under side of the secondaries the basal area of the wings is yellow or yellowish, sometimes with a brownish suffusion and this area is separated from the discal band of yellow spots by a narrow band of brown spots, variably developed. There is a more or less well defined, broad outer marginal border of brown, variable in the shade of that color.

The less heavily maculated individuals appear to predominate in the island of Trinidad, British West Indies, and they also occur in Venezuela. This form seems to be the *suffenas* of Mabilles as it well agrees with the description.

There are at hand specimens of the typical form from Caripito, Monagas, Venezuela; St. Laurent, French Guiana; Putumayo River, Peru.

The form of the male genitalia does not differ from that of typical *tiberius*.

The females differ but little from those of *tiberius*, the maculation of the upper side of the primaries being a little more prominent and the spots of the discal band in interspaces 4 and 5, while small, are well developed. On the under side of both wings the maculation is more developed.

***Phlebodes tiberius* race *conspicuus* new subspecies**

MALE. On the upper side of the primaries *conspicuus* differs from *reticulata* in having the three lower spots of the discal band very much larger in size, while the two upper spots, in interspaces 4 and 5, are either very small or entirely lacking. The three subapical spots elongate and prominent. On the secondaries the spots of the discal band are more extended than in *reticulata* and form a broad, irregular discal patch, cut into spots by the veins.

On the under side of the primaries the apical area is more or less suffused with rusty brownish and at the apex there is a yellow spot, followed immediately below by another smaller one and these are continued downward by a thin yellow marginal line, sometimes a little hazy. The subapical spots and discal band are repeated and the two spots in interspaces 4 and 5 are prominent in all cases whether or not they are present on the upper side. Interspace 1 is usually without a spot but sometimes a very small, hazy one is present.

On the under side of the secondaries the outer marginal band is narrower than in *reticulata* and rusty brown in color and indented opposite the cell, the rest of the wings is a pale yellowish or creamy white with from six to seven small, rusty brown spots in the basal half. The discal band is obliterated by the pale creamy color of the inner area of the wings. The abdominal fold is brownish and the inner margin is the same color as the discal area.

The females more nearly resemble the males in general appearance than in *reticulata*. On the upper side the discal band of the primaries and the subapical spots are more nearly whitish than in the males but there is a slight yellowish tinge around the edges of the discal spots and in the upper subapical spot. There are no spots of the discal band in interspaces 4 and 5. The secondaries have a prominent discal band of yellow spots, the spot opposite the cell sometimes elongated to the end of the cell.

On the under side the spots in interspaces 4 and 5 of the discal band are dimly indicated. The appearance of both wings is very similar to that of the male.

The form of the male genitalia is the same as that of *tiberius*.

Expanse: male, 34 mm.; female, 36 mm.

Type material. Holotype male, one male paratype, Massaranduba-Blumenau, Santa Catharina, Brasil; two male paratypes, Blumenau, Santa Catharina, Brasil, in collection of The American Museum of Natural History. Allotype female; two male

and one female paratypes, all Santa Catharina, Brasil, in collection of the Academy of Natural Sciences of Philadelphia.

This race of *tiberius* appears to be confined to the region about Massaranduba-Blumenau, Santa Catharina, Brasil.

Phlebotomus tiberius race **obscurus** new subspecies

MALE. On the upper side *obscurus* differs from typical *tiberius* in the smaller size of the spots of the discal band of the primaries and in their deeper orange fulvous color. The subapical spots are also small and orange fulvous. In one specimen the discal band has a spot in interspace 4 and in the other specimen there is a spot in each of interspaces 4 and 5, in both cases the spots are very minute. These small, darker spots do not stand out in the sharp contrast shown in typical *tiberius* and the wings present a rather diffuse appearance. The secondaries have no trace of a discal band.

On the under side of the primaries the subapical spots and the discal band are repeated except the spot in interspace 1 in one specimen and there is just a trace of it in the other specimen. The apical area is reddish brown. On the secondaries the broad outer marginal band and the abdominal fold are reddish brown, the rest of the wings to the base are yellowish suffused with reddish brown. The veins are not paler and there is no distinct discal band of pale spots.

FEMALES. On the upper side of the primaries there is a discal band of three minute orange fulvous spots, in interspaces 1, 2, and 3. One specimen has a very minute subapical spot of the same color, the other two specimens are without subapical spots. The secondaries are unmarked.

On the under side there is a very blurred appearance to both wings. The apical area is reddish brown, the upper two spots of the discal band and three subapical spots are very dimly present. The secondaries vary from brown to reddish brown, the basal area a little paler with a slight purplish reflection and there is a discal band of small, slightly paler spots. The veins are not paler.

The form of the male genitalia is the same as that of *tiberius*.

Expanse: male, 31 mm.; female, 30 mm.

Type material. Holotype male, allotype female, one male and two female paratypes, El Volcan, Chiriqui, Panama, 4,000 feet, February 20, 22, 24, 25, March 6, 1936 (W. J. Gertsch), in collection of The American Museum of Natural History.

Obscurus seems to be a race of the higher altitudes and perhaps may be confined to this region.

COMMUNAL DISAFFECTION IN ANTS

BY LAURENCE J. LAFLEUR

NEW YORK, N. Y.

It has been generally accepted that ants are perfectly loyal to the group to which they belong, despite the regular disloyalty of parasitic queens and despite some rather infrequent exceptions to this rule. Many of these exceptions were collected by the present author in "Punitive Behavior of Ants,"¹ and since the publication of that article the author has observed occasional fighting among the workers of a nest of *Formica neocinerea*. The belief in formicine loyalty has brought about the particular assumption, by the writer no less than by all other myrmecologists, that when ants affiliate with one another, living amicably together for a few days, cleaning one another and interregurgitating; then the union between them is permanent and indissoluble.² Two sets of observations show that this assumption is not always correct, and suggest a possible method of origin of the temporary parasites from more normal ants.

The first case is that of a nest of *Formica subsericea* which I started in the fall of 1934 by collecting several queens after their nuptial flight. By the fall of 1935, when the nest contained three queens and a number of eggs and larvæ, hostility among the queens was first observed. Around September 1, twenty workers were born, and soon thereafter one of the queens was dismembered by another and by several workers. A second queen was attacked, and rescued only after a foreleg was permanently paralyzed.

Somewhat the same thing happened the next time I obtained queens of this species. This was on August 8, 1940. On Sep-

¹ The Journal of Comparative Psychology, June, 1940, p. 327.

² An exception must be noted in the case of Miss Fielde's work, which was recognised by Forel in the last book he wrote. Miss Fielde found that apparently successful affiliation sometimes broke up in a series of fights, so that observation over a period of weeks rather than days was necessary in order to determine the success of affiliation. Even Miss Fielde, however, had no suspicion of the phenomena suggested in this paper.

tember 30, five of the original six queens being still alive, the first worker was born into this nest, which we shall call nest A. The second came on October 1, and on October 2 I noticed two queens attacking a third, one pulling a leg while the other sawed her neck. I separated them, and observed that all the other queens threatened or attacked the victim whenever they met her. On at least one occasion the attack resulted in an exchange of poison. The two workers licked her off at some length, but this did not keep the other queens from attacking her, so that I at length removed her from nest A, placing her, together with the pupa that was nearest maturity, in nest B.

The pupa in nest B hatched on the following day. On October 8 I tried placing the B queen back in nest A but she was again attacked. Neither the two workers that knew her, nor the two born on October 4 joined in the attack. On November 2 the B worker was placed in nest A, and was immediately attacked by the A workers. Queen B lived with the worker until January 16, when the queen died, never having laid an egg.

Now let us return to nest A. The fifth and last pupa hatched on October 10, and at this time one of the four remaining queens, whom we shall call D, began to spend considerable periods away from the others. This continued for two weeks, until I began urging D back to the others, in which efforts one or two of the workers aided me. Eventually I suspected that one of the queens was responsible for D's behavior, so on October 29 I forced D back to the main nest, discovered the particular queen (C) who was attacking her, and removed C to solitary confinement. Two days later, C was allowed to return and was peaceable, while D, who had remained with the others during C's absence, showed resentment for only a few minutes.

C's reform lasted only three days, when she again attacked D, and was placed in solitary for one day. After this she was quiescent for almost two weeks, but then nest A gave increasing evidence of being in a highly nervous state. On November 19 D was again attacked and terrorized; so much so in fact that she was afraid even of the workers, and her fear of the other ants completely obscured her usual timorousness towards me. In addition, D had been unable to approach the water supply until

my removal of C, after which the members of nest A reunited and calmed down within a few hours.

C was replaced in nest A after four days of isolation, during which she laid five eggs. The first workers she met did not behave towards her altogether as towards a nestmate, and she regurgitated to them. All the ants palpated her, and no doubt recognized her as a temporary stranger, but there was no hostility. On the following morning I found C with the larvæ and eggs in the usual compartment, one queen in the food chamber, and D and the remaining queen in still another room; while the nest as a whole was extremely nervous. In the afternoon the three queens, A, D, and E, were together with one worker. I urged them towards the main nest in the water compartment, and they were very reluctant. When I succeeded, moreover, C attacked them until she was removed, whereupon nest A quieted immediately.

C, meanwhile, was allowed to found her own nest, but made little progress because of a tendency to eat her own eggs. On the death of B on January 16, B's worker was caused to affiliate with C, and the nest has made reasonable progress since then.

But let us turn back once more to the three queens remaining in nest A. The nest became so calm with C gone that I could remove the glass cover with less disturbance than was formerly produced by my walking in the same room with them. Fifteen young pupated from December 8 to December 21, but their times of birth unfortunately fell within a period when I was absent, and the record is thus for a time at second hand. Two were born on December 27, two on December 30, one on the 31st, two on January first, and one January 2nd. On January 2nd A and D were fighting, A being supported by one of the older workers. When finally separated, A had lost the right front leg and had the right rear leg paralyzed: D had lost the right antenna, right rear leg, left front leg, and left middle leg. I returned at this juncture, and on the following day found A and E fighting and completed the separation of the nests. The excitement had an unfavorable effect on the workers still unborn, as they were not freed from their membranes at birth and only two of the seven survived.

Something should be said, perhaps, of the subsequent history of A, D, and E. A was prolific and has been progressing rapidly. E was much less so, and ate some of her eggs, so that her progress has been very slow. D had much difficulty in standing or moving, but gradually learned ways of aiding herself. At first she used her mandibles as an extra leg; later she learned to bend her fore-leg under her body in such a way as to get a tripod effect out of her three legs. When she falls over, her only method of righting herself is to push herself on her back to a wall, then to bend over with the posterior of the thorax supported by the wall. Subsequently she took to resting on her back for long periods, which in other ants would imply death. Her crippled condition has not impaired her fertility.

What interpretation is to be placed on the behavior described in this article? We must recognize, to start with, that it is not exceptional but a more or less standard form of behavior with this and probably with related species. It might be supposed that the queens driven out were those whose presence was harmful to the group, either because they were infertile or because they ate the young. This supposition was at first supported by the fact that B, the first queen driven out, proved sterile; but broke down later, since the other queens were all fertile and since C and E, the two outstanding transgressors in the matter of consuming their young, were far from being the principal victims of attack.

The clue to the situation seems to reside in the fact that the outbreak in each case coincided very closely with the maturation of workers. In the first nest, the first batch of twenty workers to mature were born around September 1, and hostilities among the queens occurred only a few days thereafter, although these queens had lived peaceably together for over a year. In the second case, the first batch of six workers were born between September 30 and October 4, and B was attacked and removed on October 2. One worker was born on October 10, and should perhaps be considered one of the first batch: at all events the intransigence of C dates from October 10. This intransigence lasted to November 3; and was renewed and extended on November 19th until her removal on November 24. The renewal of

hostilities was not itself marked by any births, and is probably to be considered merely the continuation of the fighting of October 10. Nevertheless, this period was marked by the most intensive egg-laying in the history of the group. The last batch of workers to mature were ten that were born from December 27 to January 4, plus some five others that died from insufficient attention during this period. Fighting between A and D broke out on January 2, and between A and E on January 3.

As a hypothesis to account for the behavior in question, I suggest an emotion of jealousy between queens, the biological basis of which would be identical with that of jealousy among mammals except that it has reference to the loyalty of the brood rather than to the faithfulness of a mate. Miss Fielde has demonstrated that workers remain friendly with any individuals they are acquainted with in their first few days of life, so that this period is the critical time for associated queens. If any one is driven away for these few days, she will find her return made difficult by the hostility of the new workers, and the advantages of the combined brood will accrue to the remaining queens. At the beginning of their association, the jealousy would be at a minimum and formicine gregariousness in the ascendant, thus permitting affiliation. Affiliation would have the advantage to the associated queens that some of them could forage while others guarded the young. And doubtless cases do occur where the affiliation is permanent.

This hypothesis is not asserted to apply to all ants. *Acanthomyops* queens, for example, refuse to affiliate, and if several are put in a common enclosure, will fight until one only remains alive. *Prenolepsis* queens, on the other hand, are more sociable than the *Formica*. If this behavior, however, is assumed to have been typical in groups wherein the practice of slavery arose, the origin of this instinct becomes a simple matter to explain. If the queen of one strain of an ancestral *Formica* developed increased fighting ability at the expense of its maternal capacities, and intensified its early gregariousness and later jealousy, it would have immediate increased survival value and could readily develop into the temporary parasitism of *rufa exsecta* types, and the permanent parasitism of *sanguinea* and *Polyergus*. A similar development

in other genera may account for the occurrence of temporary parasitism in *Aphanogaster* and other genera and for the Myrmecine degenerates. A further point of some interest is that in two cases described in this paper workers of *Formica subsericea* took sides in the fighting between queens. This indicates that Miss Fielde's principles of affiliation are not altogether adequate; and suggests as well that there may be some correlation with such instances among parasitic ants as the assassination of their own mother by *Monomorium* workers in the presence of *Wheeleriella* parasites.

The existence and prevalence of the suggested jealousy among queens for the favor of workers is supported by two other facts. The first is that, in a long course of observations of many species of ants, it has become evident to the author that affiliation between queens and workers is easier to achieve than affiliation between alien groups of either caste alone. The second point is that in the closely related and socially parallel case of the bees, the jealousy between queens is so strong that it is the predominant factor in the conduct even of related queens in the same hive. It is not at all unlikely that the instinct of jealousy may have its root in the nature of a common ancestor, as well as in the requirements of adaptation to a somewhat similar social structure.

A METHOD FOR OBTAINING SPORES OF THE
FUNGUS *BEAUVERIA BASSIANA* (BALS.)
VUILL. IN QUANTITY

E. E. McCOY AND C. W. CARVER

NEW JERSEY DEPARTMENT OF AGRICULTURE, TRENTON, N. J.

From time to time the possibility of applying entomogenous fungi as control measures for insect pests arouses interest among entomologists. Unfortunately most attempts to use fungi in practical control work have not met with marked success and yet, under natural conditions, wide-spread epidemics of some of these fungous diseases occur and cause drastic reductions in their insect hosts. Possible reasons for these failures may be: too light spore dosages employed; too small areas involved; repeated applications not made.

Many workers would undoubtedly use heavier or repeated spore distributions if it were possible to obtain a larger quantity of spores without a disproportionately large amount of culture work. The authors feel that the procedures here described will at least alleviate this latter difficulty. While the methods described apply specifically to the culture of *Beauveria bassiana*, it appears probable that they are subject to adaptation to a number of fungi. They have already been applied by us to an *Aspergillus* sp. recently isolated from diseased sawfly adults.

A number of the entomogenous fungi offer no particular difficulty from the standpoint of artificial culture, and have been grown on various media. Many of these media are essentially some type of nutrient agar. *Beauveria* grows well on a variety of agar media, and has also been grown on corn meal mush (1) and soy bean mash (2), for example. The yield of spores from such cultures, large though it appears in the laboratory, seems small when one considers spreading the material over an area of several acres. Other workers have recognized this difficulty.

The authors became interested in the culture of *Beauveria* as a result of recent experiments which indicate that the fungus readily parasitizes the Japanese beetle adult (3). The spores

used in the initial phases of this work were grown in Petri dishes, using potato agar as the culture medium. It was soon evident that a better culture method would be necessary if any extensive work was to be done. *Beauveria* is not fastidious, and was found to grow on various agar media, corn meal mush, soy bean mash, sweet potato, bread and a number of other materials. However, the best growth by far occurred on autoclaved, moistened, bran. Bran does not appear to have been widely used in mycological work, but possesses certain physical properties, as well as nutrients, which adapt it excellently for the problem. Foremost among these is that fungi fruit, or bear spores, on the surface of the medium, and the bran particles present an enormous surface. Spore production, in bran cultures, therefore becomes practically a three dimensional effect. It is evident that a wide range of nutrient solutions, or solid materials, can be mixed with the bran if necessary to promote growth of the more fastidious fungi.

The wheat bran employed is the ordinary kind used for feeding livestock and is obtainable at any feed store. The adherent and intermixed starch, etc., supply the nutritional requirement of the *Beauveria*. The *Beauveria* used in this work was obtained originally through Dr. M. Timonin, who described the strain as a parasite of the Colorado potato beetle (4). This strain, however, was later used to infect a series of Japanese beetle adults and re-isolated from the latter insect by us. The final fungus strain appears to have growth habits which differ somewhat from the original material, possibly as a result of unintentional selection, or selective adaptation. At any rate it seems to sporulate more rapidly and compactly than does the original material.

The bran is moistened with tap water, using 1 part by weight of bran to 1.5 parts by weight of water; as 100 gms. bran plus 150 ml. of water. The mass is thoroughly mixed. The moistened bran is placed in flasks, the latter plugged, and autoclaved. Experience has shown that a 30-minute period at 15 lbs. steam pressure is sufficient to sterilize the medium in a 2-liter Erlenmeyer flask. It is best not to have the flasks more than half filled with medium.

After the autoclaved medium has cooled it is inoculated with the fungus. A small amount of a matured bran culture makes

an ideal inoculum. The inoculum is thoroughly distributed by shaking the plugged flask. The culture may be incubated in the flask, in which case it is desirable to shake the flask occasionally to break the extremely dense mycelial development, and maintain the contents in a more or less granular condition. More rapid growth occurs if the inoculated bran medium is spread in sterile Petri dishes, maintaining the mass as loose as possible. Culture dishes 200 mm. in diameter by 20 mm. high will contain roughly the equivalent of 60 gms. of bran (150 gms. medium) each. Such a culture yields approximately 3 gms. of spores. The yield is therefore about 22 gms. of spores per pound of bran. If the spores were applied at the rate of 20 gms. per acre, as has been done in some experimental work with the corn borer, the culture material would cost \$0.02 per acre, and 7 of the 8" culture dishes would be required.

The rate of development of the *Beauveria* depends upon temperature. The optimum incubation temperature is 80–85° F. At 72° F. these cultures are customarily incubated for from 10 to 15 days. After incubation the cultures are removed from the culture vessels, spread in a rather thin layer, and permitted to air dry at room temperature. This requires several days. After drying the material may be stored for at least several months without injury. For many purposes it is not necessary to separate the spores from the dried bran medium. However when such separation is desired several rapid methods are available.

Probably the simplest procedure is to place the dried medium in an ordinary flour sifter, place the sifter tightly in contact with the collecting paper or pan, cover the top, and turn the sifter handle. The spores are detached from the dried bran and collected below the screen. This procedure is dusty and does not give a complete recovery. The following method is much cleaner and more efficient.

Figure 1 illustrates an apparatus devised specifically for collecting the spores. The principle of operation is that compressed air under moderate pressure agitates the dried medium contained in a separatory funnel (500 ml. size), thereby detaching the spores and also suspending them in the air stream. The air escapes from the funnel mouth through a glass tube, the latter

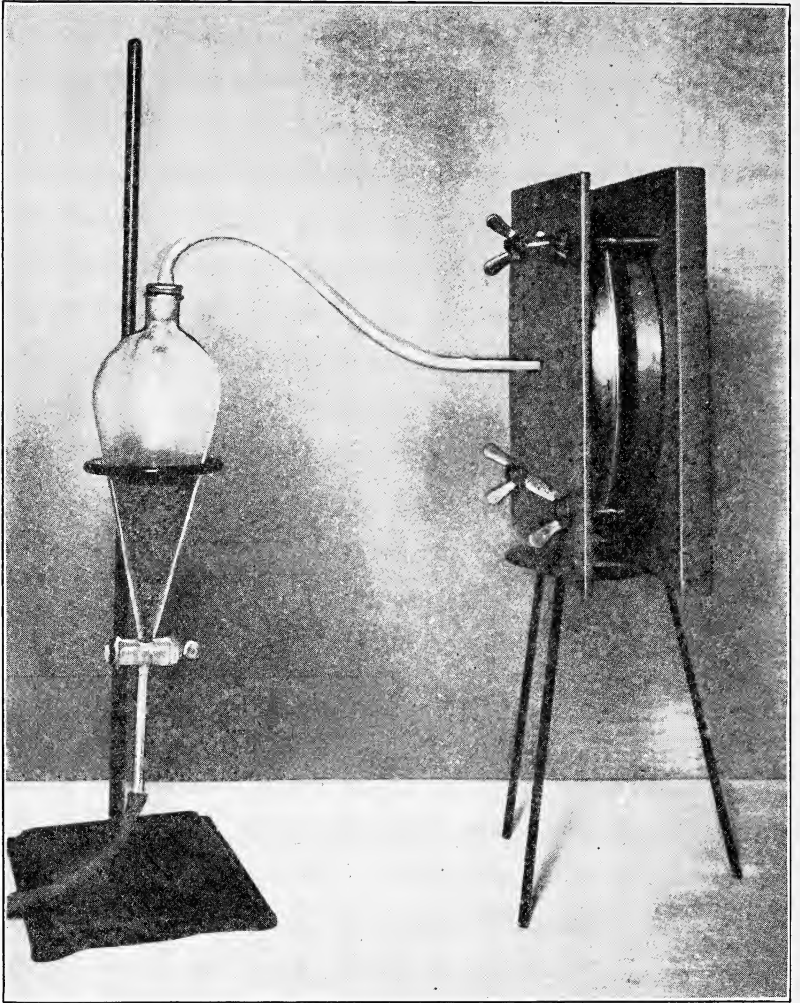

Figure 1.

being held in place by a tightly fitting rubber stopper. The glass tube extends about 4 cms. into the funnel, this end being capped by a thimble of insect screen (16 mesh per inch) to prevent the passage of bran particles. The air stream is conducted through a short rubber tube to the filter, where the spores are collected. The filter consists of two aluminum pie pans, each 23 cms. in

diameter, which, when opposed, clamp a disc of filter paper between the two rims. In order to assure a tight seal, the rim of one pan has a sponge rubber gasket cemented to the circumference. A central hole is drilled in each pan, and a short length of glass tubing cemented in each, to act respectively as inlet and escape ports for the filter. The filter paper is placed between the pans, and the assembly held tightly together by means of a simple wooden clamp.

In operation the dried medium is placed in the funnel through the mouth, the stopper replaced (thus connecting the filter) and the air pressure turned on by means of the stopcock. The pressure should be sufficient to thoroughly agitate the contents of the funnel. Within several minutes almost all of the spores are blown out of the residual bran. The residue is removed, and a fresh charge placed in the funnel. With a filter area of approximately 300 sq. cms. about 10 gms. of spores may be collected before the filter must be opened and the spores scraped from the paper. The paper may be used repeatedly. It has been found best to lightly crush the dried medium before placing it in the separator. This may be easily and cleanly done by a very short grinding in a closed ball mill.

This method of separation and collection of fungous spores is obviously not confined to any particular fungus.

SUMMARY

A procedure for culturing and obtaining large quantities of spores of the entomogenous fungus *Beauveria bassiana* (Bals.) Vuill. has been described. It is suggested that the methods are adaptable to use with a number of other fungi. The fungus is cultured on autoclaved, moistened wheat bran. The yield of spores is much heavier than occurs on commonly used culture media. The spores may be readily obtained in a practically pure condition by an air separation and filtration method. The construction of a simple separator and filter is described.

LITERATURE CITED

- BARTLETT, K. A., AND LEFEBVRE, C. L. Field experiments with *Beauveria bassiana* (Bals.) Vuill., a fungus attacking the European corn borer. Jour. Ec. Ent., 27: 1147-1157. 1934.

- STIRRETT, GEO. M., BEAL, G., AND TIMONIN, M. A field experiment on the control of the European Corn Borer, *Pyrausta nubilalis* Hubn., by *Beauveria bassiana* Vuill. Scientific Agric., 17: 587-591. 1937.
- REX, E. G. A promising fungous pathogen of adult Japanese beetles (*Popillia japonica*). Jour. N. Y. Ent. Soc., 48: 401-403. 1940.
- TIMONIN, M. I. Pathogenicity of *Beauveria bassiana* (Bals.) Vuill. on Colorado potato beetle larvae. Canadian Jour. Research, 17, D: 103-107. 1939.

NOTE ON THE METHOD OF COLONY FOUNDATION
OF THE PONERINE ANT BOTHROPONERA
SOROR EMERY

BY CARYL P. HASKINS

The method of colony formation among the Ponerine ants presents problems of very considerable phylogenetic interest to students of the development and basic structure of formicid societies. It is of some interest that, whereas the normal method of colony foundation among higher ants is extremely easy to observe under experimental conditions, and has been reported repeatedly since the days of Réamur and Gould, it is far less easy to follow the process under controlled conditions among the Ponerinæ, where, perhaps, it would be most significant to know it. Wheeler (1) has studied the question extensively, has observed the formation of colonies by isolated females of *Odontomachus haematoda*, and has recorded a set of extremely interesting observations on the primitive Ponerines of the Australian genus *Myrmecia*. The author (2), among others, has observed the occurrence of a true nuptial flight under natural conditions in *Stigmatomma pallipes*, *Ponera coarctata*, *Odontomachus hæmatoda* and its variety *insularis*, *Ectatomma ruidum*, and *Paraponera clavata*, and has recorded observations on the method of colony formation for *Odontomachus hæmatoda* and *insularis*, *Paraponera clavata*, *Pachycondyla harpax*, *Euponera (Trachymesopus) stigma*, and *Proceratium croceum*.

The great similarity in stature between the perfect females and the worker forms of most Ponerine ants makes the supposition that young fertile females isolate themselves after the nuptial flight and rear their first brood entirely without foraging, after the manner of higher ants, very unlikely, although we have found (1938) progressive degeneration of wing musculature of fertilized females of *Stigmatomma pallipes* and *Euponera stigma*, presenting a physiological picture markedly similar to that for higher ants. To account for this situation Wheeler proposed the idea of "partial provisioning" supposing that the young

female after fertilization descends to earth and isolates herself like the queen of a higher ant, but leaves an entrance open to the cell and repeatedly forages for the developing brood. Wheeler later obtained evidence for this view in *Myrmecia* and *Amblyopone* and we have found marked indication of it with *Paraponera clavata*, *Pachycondyla harpax*, and especially with *Euponera stigma*.

It is notable, however, that in none of these observations has the complete inception of a young colony of a Ponerine ant, from the time of the isolation of the young queen to the appearance of adult workers, been recorded under artificial conditions, so that the picture of partial provisioning is lacking in completeness. It is not difficult to find half-formed young communities of Ponerine ants of many species under natural conditions, especially in the tropical rain-forests of both hemispheres, which give the most decided appearance of having been formed by isolated young females, and in the artificial nest this impression is readily confirmed. It is less easy, however, to watch the development of a young colony from an isolated female to its early adult phase under the same circumstances.

It therefore seems worthwhile to record an instance of colony foundation which was observed through its entirety under artificial conditions, and which gives the clearest evidence for partial provisioning.

Thanks to the great kindness of Dr. Victor Van Strahlen, Director of the Musée Royale d'Histoire Naturelle de Belgique and of the Parc National Albert of the Belgian Congo, it was possible to undertake myrmecological studies in this beautiful area during the summer of 1938. Fairly extensive collecting was done in the dense temperate rain forests of the Secteur Mikeno, in the Ituri Forest, and on the Ruindi Plains, and particular attention was paid to evidences of the formation of colonies by young isolated Ponerine females. The present note is concerned entirely with the species *Bothroponera soror* Emery (Ponerinæ, Ponerii).

Bothroponera soror is a fairly common, though locally distributed, active paleotropical Ponerine ant of the Congo rain forest, to which it is largely confined. It nests by preference in

the soil about decaying wet logs in the deeper forest, frequently running its galleries and chambers well into the wood, but ordinarily maintaining open communication to the earth beneath.

On July 21, 1938, two young fertile females of this species were found isolated together in a cell constructed in black lava earth on the lower slopes of Mt. Mikeno. They were transferred together to an artificial nest, to which they quickly became adapted, and fed at first with honey and later with a variety of insect food, which was readily accepted.

Eggs were laid in late August, formed into a packet and assiduously tended by both young queens. The first egg hatched on September 1, and by early November two cocoons had been spun, and there were in the colony, in addition, six larvæ and six eggs. All larvæ matured and spun cocoons normally. Throughout the period of growth of the larvæ, both adult females foraged actively, and the larvæ were kept well supplied with cut-up insect food, which they actively devoured. At no time was there any evidence of feeding of the larvæ by regurgitation. The larvæ and their resulting pupæ were of the normal size and form of those of typical workers of the species, there being none of the dwarfing so characteristic among first-brood workers of the higher ants.

When nine cocoons had accumulated, the females began systematically to destroy the older ones, cutting them open and extracting and dismembering the pupæ, which were those of already partially pigmented young workers. Seven cocoons were so destroyed, when the remaining two were artificially isolated in an attempt to save them. One of these perished, and was found to have been a normal young worker. The remaining one was returned to the colony, and was there allowed to hatch, eclosing a perfect and robust young callow of a light lemon yellow color on January 9. The young ant was treated with marked attention by the females, and freely deported, but was not injured. It immediately assumed charge of the remaining brood, and rapidly darkened in color, first to red and finally to the black typical of the species.

A second adult was eclosed on January 16, slightly smaller than the first, but otherwise like it. The females, however,

clipped off the flagella of both antennæ in the course of extracting it from the cocoon and it shortly perished.

The two females, hitherto completely cooperative, now showed slight hostility, and were separated, the entire brood being given to one. The second immediately constructed a new cell, laid additional eggs, formed them into a packet, and tended them as had the two females earlier. Two colonies were thus set up.

A third young worker was eclosed in the original colony on January 24, of unusually large size, which survived and matured normally. Workers continued thereafter to be produced in the original colony, which was now essentially established. On April 9 the first adult was eclosed in the new colony formed by the secondarily isolated female. It was large and of the form typical of the workers of mature colonies. Thereafter normal workers were regularly produced in both colonies, which took on the form characteristic of Ponerine communities in early maturity. The nests were maintained until March, 1940. During the second year the interest of the females in their respective broods diminished, although it never entirely disappeared, and they assumed the functions characteristic of older Ponerine perfect females. On December 19, 1939, a mature worker from the original colony was introduced into the offshoot group, and was immediately violently attacked. The two communities, originally fused, had thus become entirely independent, a development which is probably fairly common under natural conditions among communities originally cooperatively founded by more than one fertile female.

The colonies of *B. soror* were maintained in Lubbock earth-containing nests with open entrances housed in a greenhouse maintained at a mean temperature of 75° F. and nearly saturation humidity. Under these conditions the duration of the egg period was found to be about 15 days, of the larval instar, about 15 days, while the duration of the pupal stage was about a month. The length of larval life varied greatly with the extensiveness of larval feeding.

After death, the thorax of one of the founding queens was sectioned in paraffin. It was found that the wing musculature had practically disappeared, as it does typically among the higher ants. It would seem, therefore, that the characteristic absorption of the wing musculature after dealation which among higher ants

serves so indispensable a purpose in permitting them to form a colony without taking food during the process phylogenetically antedates that habit.

CONCLUSION

The development of these two colonies, I believe, presents a fairly clear and complete picture of the method of colony formation practiced by at least some of the Ponerine ants. Young females remove their wings following the nuptial flight, after the manner of higher ants, and, singly or in small groups, excavate cells in earth or decaying wood. Eggs are deposited, formed into a packet, and tended assiduously. The females do not isolate themselves during this time, however, but forage actively, certainly after the hatching of the first eggs, and probably before. The larvæ are fed with insect material in the fashion so typical of the Ponerines and of many higher ants. Ingluvial feeding has not been seen. The larvæ mature, and spin cocoons of normal size and form. There is no evidence of any specialized depauperate first-brood form so common among higher ants. The pupæ mature and are eclosed, aided or unaided depending upon the type, and the young workers take their place in the community. Gradually the foraging instincts of the brood-queen lapse and the egg-laying habit becomes specialized, so that the Ponerine mature queen approaches the condition of the mature female of ants of the higher subfamilies, although colonial duties are never completely relinquished during the lifetime of the former. It is to be supposed that the destruction of the earlier cocoons in the case recorded was an abnormal procedure consequent upon artificial conditions.

The whole procedure as thus observed is quite in accord with expectation, and represents a generalized condition from which we must suppose that the highly evolved methods of colony foundation of Myrmicine and Formicine ants have been derived by successive specializations.

The wing musculature of the queen is apparently destroyed during the process of colony foundation as among the higher ants, even although the young queen may freely partake of nourishment during the period. It is doubtful if any fat-body is fed to the young ingluvially, as among the higher ants, but the muscle resorption undoubtedly contributes to the resistance of the queen

herself if threatened by long periods of enforced abstinence. It would seem that this physiological characteristic phylogenetically antedated the completely claustral habit of colony formation and eventually became tributary to it.

ACKNOWLEDGMENTS

Particular thanks are due to Dr. Victor Van Strahlen for his kind permission to collect and study ants within the area of the Parc National Albert in the Belgian Congo in 1938, and to Dr. Neal A. Weber of the University of North Dakota for identification of the ant concerned. All investigations resulting from this expedition were originally, by agreement with Dr. Van Strahlen, to have been published in Belgium. This has become inadvisable by reason of the present war, and they are presented in the United States with very deep acknowledgements to the source and the nation which made them possible.

BIBLIOGRAPHY

1. WHEELER, W. M.
 1900. A study of some Texan Ponerinæ. *Biol. Bull.*, 2: 1.
 1900. The habits of *Ponera* and *Stigmatomma*. *Ibid.*, 2: 43.
 1905. On the founding of colonies by Queen ants. *Bull. Amer. Mus. Nat. Hist.*, 22: 33.
 1910. Ants, their structure, development, and behavior. Columbia University Press. 663 pp.
 1916. The marriage flight of a Bull-dog ant. *Jour. Anim. Behavior*, 6: 70.
 1932. How the primitive ants of Australia start their colonies. *Science*, N. S., 76: 532.
 1933. Colony founding among ants, with an account of some primitive Australian species. Harvard University Press. 179 pp.
2. HASKINS, C. P.
 1928. Notes on the behavior and habits of *Stigmatomma pallipes* Haldermann. *Jour. N. Y. Ent. Soc.*, XXXVI: 179.
 1930. Preliminary notes on certain phases of the behavior and habits of *Proceratium croceum* Roger. *Ibid.*, XXXVIII: 121.
 1931. Notes on the biology and social life of *Euponera gilva* Roger var. *Harnedi* M. R. Smith. *Ibid.*, XXXIX: 509.
3. HASKINS, C. P., AND ENZMANN, E. V.
 1938. Studies of certain sociological and physiological features in the Formicidæ. *Annals of the New York Academy of Sciences*, XXXVII, Art. 2: 147.

The New York Entomological Society

Organized June 29, 1892—Incorporated June 7, 1893

Certificate of Incorporation expires June 7, 1943

The meetings of the Society are held on the first and third Tuesday of each month (except June, July, August and September) at 8 P. M., in the AMERICAN MUSEUM OF NATURAL HISTORY, 77th Street and Columbus Avenue.

Annual dues for Active Members, \$3.00; including subscription to the Journal, \$4.50.

Members of the Society will please remit their annual dues, payable in January, to the treasurer.

Honorary President, WILLIAM T. DAVIS

Officers for the Year 1941

President, MAX KISLIUK.....Federal Bldg., New York, N. Y.

Vice-President, HARRY B. WEISS.....Highland Park, N. J.

Secretary, ANNETTE L. BACON.....American Museum of Natural History

Treasurer, DR. HERMAN T. SPIETH.....College of the City of New York, N. Y.

Librarian, L. JAMES SANFORD.....American Museum of Natural History

Curator, DR. WILLIS J. GERTSCH.....American Museum of Natural History

EXECUTIVE COMMITTEE

W. T. DAVIS

DR. ALBERT HARTZELL

DR. WM. PROCTER

DR. A. B. KLOTS

FRANK A. SORACI

PUBLICATION COMMITTEE

HARRY B. WEISS

EDWIN W. TEALE

HERBERT F. SCHWARZ

E. L. BELL

PROGRAM COMMITTEE

J. W. ANGEI

M. H. SARTOR

HAROLD HAGAN

AUDITING COMMITTEE

DR. WM. MOORE

DR. W. J. GERTSCH

F. S. BLANTON

FIELD COMMITTEE

DR. A. B. KLOTS

A. S. NICOLAY

WM. P. COMSTOCK

DELEGATE TO THE N. Y. ACADEMY OF SCIENCES

WILLIAM T. DAVIS

JOURNAL

of the

NEW YORK ENTOMOLOGICAL SOCIETY

Published quarterly by the Society at N. Queen St., and McGovern Ave., Lancaster, Pa. All communications relating to manuscript for the Journal should be sent to the Editor, Harry B. Weiss, 19 N. 7th Ave., Highland Park, New Jersey; all subscriptions to the Treasurer, Dr. Herman T. Spieth, American Museum of Natural History, New York, N. Y. Orders for back issues should be sent to the Librarian, L. James Sanford, American Museum of Natural History, 77th St. and Columbus Ave., New York, N. Y. The society has a complete file of back issues in stock. The Society will not be responsible for lost Journals if not notified immediately of change of address. We do not exchange publications.

Terms for subscription, \$3.00 per year, strictly in advance.

Please make all checks, money-orders, or drafts payable to New York Entomological Society.

Twenty-five reprints without covers are furnished free to authors. Additional copies may be purchased at the following rates:

	4 pp.	8 pp.	12 pp.	16 pp.	24 pp.	32 pp.
25 copies	\$2.40	\$5.22	\$5.58	\$5.58	\$9.00	\$9.60
Additional 100's60	1.44	1.92	1.92	3.00	3.00
Covers	50 copies, \$2.00; additional 100's, \$1.50.					

Half-tone prints 1½ cents for each half-tone print.

Authors whose papers are illustrated with text figures or full page plates will be required to supply the electroplates or pay the cost of making the same by the Journal and also to pay the cost of printing full page plates on coated paper, when advisable.

SEPTEMBER, 1941

Journal

of the

New York Entomological Society

Devoted to Entomology in General

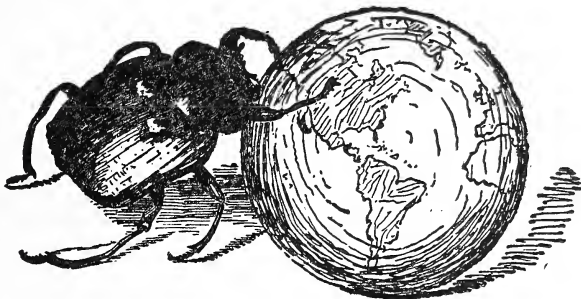

Edited by HARRY B. WEISS



Publication Committee

HARRY B. WEISS
HERBERT F. SCHWARZ

EDWIN W. TEALE
E. L. BELL

Subscription \$3.00 per Year

Published Quarterly by the Society
N. QUEEN ST. AND McGOVERN AVE.
LANCASTER, PA.
NEW YORK, N. Y.

CONTENTS

The Sensory Basis of Courtship BY CYRIL E. ABBOTT	217
On Some Asiatic Species of <i>Carterocephalus</i> BY V. NABOKOV	221
Civil Disturbances in Ant Communities BY LAURENCE J. LAFLEUR	225
The Elateridæ of Pennsylvania BY C. A. THOMAS	233
<i>Lysandra Cornion</i> , a New European Butterfly BY V. NABOKOV	265
Some New Species of <i>Mallophora Macquart</i> (<i>Asilidæ</i> , <i>Diptera</i>) BY C. H. CURRAN	269
Additions to the New Jersey State List of Coleoptera BY BORYS MALKIN	285
Proceedings of the New York Entomological Society	293
 NOTICE: VOLUME XLIX, NUMBER 2, OF THE JOURNAL OF THE NEW YORK ENTOMOLOGICAL SOCIETY WAS PUBLISHED ON MAY 6, 1941.	

Entered as second class matter July 7, 1925, at the post office at Lancaster, Pa.,
under the Act of August 24, 1912.
Acceptance for mailing at special rate of postage provided for in Section 1103.
Act of October 3, 1917, authorized March 27, 1924.

JOURNAL

OF THE

New York Entomological Society

VOL. XLIX

SEPTEMBER, 1941

No. 3

THE SENSORY BASIS OF COURTSHIP

BY CYRIL E. ABBOTT

Courtship may be defined as an elaborate sexual response involving recognition, selection, and pursuit. Although these various phases of behavior may be complicated by elaboration of details and variation of execution, the "pattern" of courtship, as generally understood, is easily recognized whenever and wherever it occurs. Selection, though it involves individuals is accompanied or preceded by the recognition of characteristics both specific and sexual. These may precede or follow pursuit, according to conditions. That is to say, recognition and even selection are seldom infallible, as any one who has studied the courtship of insects knows.

For in many species courtship regularly precedes sexual union. This is notably true of diurnal, flying forms; indeed it is a form of behavior typical of "daylight" species. In those rare cases where courtship occurs among nocturnal insects (*e.g.*, the Lampyridæ) one will find that there is special provision for the stimulation of the visual senses.

Courtship is, in fact, an almost exclusively *visual* process; courting animals (not insects exclusively) depend almost entirely upon the visual impressions they receive. Why is this the case, and what relation does it have to the property of being diurnal? I believe that the explanation is contained in two conditions; the high degree of acuity of daylight vision which makes possible the recognition of patterns, and the restriction of elab-

AUG 29 1941

orate patterns to species inhabiting intense light. Correlary to these conditions is the fact that the visual senses are the only senses sufficiently discriminating to make such behavior possible.

Night vision, even in animals primarily or exclusively nocturnal, is not only generally insensitive to differences to color, but is also less sensitive than daylight vision to form and depth; this is true of both vertebrates and arthropods. Animals active both during the day and at night certainly have the resolving power of the eyes reduced in weak light. It is, in fact, impossible to separate color vision absolutely from the perception of form, since, to considerable extent, the latter condition depends upon the condition known as "simultaneous contrast." The truth of this is indicated by the familiar examples found in human color-blindness; as, for example, the difficulty experienced in locating a red apple among green foliage.

But to recognize a pattern implies the presence of a pattern to recognize, and it is also true that the formation of brilliant, strongly contrasting pigments is directly dependent upon exposure to intense illumination. Caverniculous animals are unpigmented; so too, are many insects inhabiting the trunks of trees or which are subterranean in habit; and the eggs of most species of birds nesting in hollow trees or underground burrows are white. Most nocturnal animals, though pigmented, are dull in color, and, more significantly, do not exhibit the striking color patterns characteristic of diurnal forms.

This relationship of light to pattern is especially obvious among insects. The wing-patterns of moths lack both the distinctness of line and brilliancy of color so consistently present in their diurnal relatives, the butterflies. Moths which are diurnal generally have acute vision, distinct color patterns, and exhibit some inclination to courtship, although their behavior in this respect is less intricate than that of the butterflies. Parenthetically, most butterflies are much more sensitive to the longer rays of the visible spectrum than are the nocturnal moths, and animals sensitive to the longer spectral rays appear to have a higher visual acuity than those insensitive to the red end of the spectrum.

Most of the large, silk-producing moths (*Saturnidæ*) are

strictly nocturnal. The males are attracted to the females by odor, and mating occurs without any intervening courtship. But I have found that *Callosamia promethia* not infrequently flies and mates by day, and this moth exhibits so striking a difference in the color patterns of the two sexes that the uninformed laymen often mistakes them for distinct species. I have not seen this moth exhibit courtship, although I have read somewhere that actual experiments made in transferring the wings of one sex to the other gave results indicating some visual sex recognition. But even if courtship is lacking in this species, we need not be surprised, since phyletically sex differentiation probably has preceded the development of courtship behavior to some extent; indeed it could hardly be otherwise.

Also significant is the fact that the flashing of fireflies is a visual stimulus to sexual union; but it constitutes a part of the courtship itself. It differs from diurnal courtship also in the fact that instead of depending upon a fixed pattern for recognition, the same result is achieved by a "time pattern." That is to say, each species has a flash frequency which is specific both as to the duration of the glow and the interval of darkness; recognition depends upon these alone.

As one might expect, courtship is particularly characteristic of predatory insects, even though their very nature makes the sexes potential enemies. The reason for this is obvious, since predatory forms are generally visually acute. Dragonflies, for example, refute the popular dogma that the bulk of initiative in courtship is masculine. Recently I observed with interest the mating behavior of an unidentified species of *Enallagma*. Females as well as males pursued other females; not infrequently a female insect pursued a male. Because the life of the predatory insect depends upon the *pursuit* of prey, it may be that the pursuit of a potential mate is initiated by the same impulse. Students of human psychology have often remarked that the impulses concerned with nutrition and reproduction are inextricably interwoven.

The behavior of animals other than insects supports the conclusions here set forth. For instance, birds, which have been cited as the animals exhibiting courtship in its most intricate

and highly specialized forms are predominantly diurnal and predominantly dependent upon vision. Also, most of them are predatory, for it is impossible to regard insectivorous birds as otherwise than predators in a broad sense, nor is it possible to draw a distinct line between insectivorous forms and those predatory upon other animals. Song, it is true, plays a minor role in the courtship of birds, but this also has its counterpart among such insects as cicadas and grasshoppers.

To recapitulate: courtship among animals depends directly upon diurnal habits, acute vision, and the development of patterns. Among insects this is almost exclusively the case, and it is generally true elsewhere in the animal kingdom. The exhibition of courtship does not depend upon taxonomic relationships, except such as are related to the requirements described.

ON SOME ASIATIC SPECIES OF CARTEROCEPHALUS

BY V. NABOKOV

1. The true *Carterocephalus*¹ *dieckmanni* Graeser.

In 1888 (Berl. Ent. Z.) Graeser described a new *Carterocephalus*, *dieckmanni* from two males taken near Vladivostok; in 1891 (Entmol. XXIV Suppl.) Leech named another Asiatic species, from Tibet, *gemmatus*; a month later, this was described and figured as *demea* by Oberthur (Études Entom.) who never forgave Leech for having hastily forestalled him after seeing a proof copy of the plate; and in 1897 Elwes and Edwards, revising the family (Trans. Zool. Soc.) cheerfully sank both *gemmatus* Leech and *demea* Obthr., as synonyms of Graeser's *dieckmanni*.

Little though Leech seems to have deserved it, his *gemmatus* (*demea* Obthr.) must now be restored. Elwes and Edwards' error was rather remarkable in view of Oberthur's perfect representation of his *demea* and of Graeser's detailed and beautifully accurate description of his *dieckmanni*; but more remarkable still is the fact that this confusion ("*dieckmanni* Graeser = *gemmatus* Leech) has been kept up for half a century by other writers including of course Mabille, in his half-hearted, incredibly muddled survey (I volume of Seitz), and Gaede (Suppl. to "Seitz") who, however, was sufficiently acquainted with the facies of the alleged synonym to be bothered by the figure in Seitz, and no wonder he was; that figure happens to represent the true *dieckmanni*! "The form illustrated in volume I, says Gaede (trying as it were to patch up the matter), has two rows of white spots on underside of hind wings. Occasionally these are conjoined forming two bands as illustrated by Oberthur."

The simple reality of course is that *gemmatus* Leech (*demea* Obthr.) and *dieckmanni* Graeser are separate species, and incidentally, the latter is more seldom met with in collections than the former. On the underside of the secondaries the central sil-

¹The "black-and-white" group merges into the "golden" so naturally that I do not see any reason for isolating the former in the subgenus *Aubertia* very vaguely proposed by Oberthur in 1896.

very band of *gemmatus* is replaced in *dieckmanni* by three spots² with the general pattern recalling a "golden" species *argyro-stigma* Ev. (as was noted by Graeser himself); and another striking feature is that, in *gemmatus*, the fringes of the secondaries are dark, the costal part alone being white, whereas in *dieckmanni* (as again Graeser notes) they are white throughout except for a short stretch between the upper angle and vein 2 where there is a peculiar shading not quite reaching the outer edge.

The only specimen of *C. dieckmanni* at the American Museum of Natural History is a male, from Sining.

2. *Carterocephalus canopunctatus* new species.

Upperside brownish black with small dull-white spots; these recall *flavomaculatus* Obthr. in size and *christophi* Gr.-Grsh.³ in disposition. Wings and abdomen have a slim elongated appearance.

Primaries above with two spots in the cell, the first near the base, wedge-shaped, surmounted by a small bluish-white patch, the other at one third from the end, bar-shaped across the cell; below this a slightly broader spot placed outwards; and four sub-apical spots, the first three from near the costa in a narrow band divided by the veins and the fourth placed outwards, with a hardly perceptible dot in a line below. Apex tipped with white even more slightly than in *niveomaculatus* Obthr. Fringes brownish.

Secondaries with two spots, the first bar-shaped across the cell and the other below it less extended inwards than in *flavomaculatus*. Fringes shaded with brownish, except along the costa and at one point above the anal angle where they are white.

Primaries underside washed with olivaceous along the costa and on apical area, otherwise brown with the spots of the upperside reproduced and slightly enlarged.

Secondaries underside resembling *niveomaculatus* and, still more, *flavomaculatus*, olivaceous, with the usual pale pincer-shaped markings at the base, a yellow medial streak, a line of more or less distinct yellow dots along the margin and nine spots, silvery-white (except the small costal one, central series, which is yellowish as in *flavomaculatus*) and placed as follows: a sub-basal one, rounded, as large as in *flavomaculatus*; five forming a central

² This is curiously paralleled in another Hesperid genus, *Pyrgus*, by the difference between *maculata* Brem. et Gr. and *malvae* L.

³ Or rather *dulcis* Obthr. if the latter be considered as a form of *christophi* with slightly reduced spots. There is also *niveomaculatus* var. *tibetanus* South, but the author's meager description (Bomb. Nat. Hist. Soc. 1913) is worthless as the few characters he mentions might apply equally well to *christophi* or *dulcis*.

series, the fifth being more extended inwards than in *flavomaculatus* or *niveomaculatus*, and a sub-marginal series represented by a small rounded spot at the upper angle, one below, extended outwards (not both ways as in the two other species), and two in the medium interspaces.

One male, holotype, in the American Museum of Natural History, labelled "Ta-Tsien-Lu, Ost Tibet" and coming from the collection of Mr. E. L. Bell who obtained it from the firm of Staudinger and Bang Haas.

CIVIL DISTURBANCES IN ANT COMMUNITIES

BY LAURENCE J. LAFLEUR

It is not so long ago that the title of this paper would have seemed almost paradoxical, as ants were believed to be perfectly social. Recently, however, new observations and the collection of previously recorded incidents have not only made it clear that civil disturbances do occur, but have also indicated that there may be a variety of motivation for them. It is the purpose of this paper, not merely to add to the recorded list of civil disturbances, but also to detail the probable motivations thereof.

First, a word or two may be devoted to the question of recognition. We are concerned with the deliberate attack by one ant upon a nest-mate, but the appearance of such an attack could readily be produced by one ant's failure to recognize a nest-mate as such, and her consequent attack upon her as an enemy. If a strong perfume is sprinkled over ants it interferes with their power of recognition: in most cases it causes the ant, depending upon its species and individual attitude, to treat strangers as friends, or, *per contra*, to treat its friends as enemies. A similar result is sometimes produced by poisons, such as corrosive sublimate, and by the amputation of the antennæ. Brain lesions or disease might well have the same effect. When individual ants are handled, or sprayed with poison by hostile ants, or when they fall into honey or even into water, it sometimes causes their comrades to fail to recognize them, and temporary "arrests" or more serious attacks may then occur. In a very large nest, recognition, if based on individual characteristics, as must be the case in at least some cases (*e.g.*, those where individuals of other species have been adopted), might fail at times due to the number of individuals involved. It therefore becomes necessary to take every precaution lest a case of mistaken identity be listed among the instances of deliberate attack on a nest-mate, I have taken such precautions, and none of the incidents referred to in this or in previous articles on the same topic may reasonably be ascribed to a failure in recognition.

Certain cases of civil disturbance have the appearance of being the deliberate punishment by some ants of nest-mates who fail to defend the nest. The psychological implications of such behavior are so startling that one naturally hesitates to accept them, but the behavior itself is well attested and no alternative explanation has as yet been offered. This problem is discussed in "Punitive Behavior of Ants."¹

Sometimes the conduct of individual ants has all the characteristics that attend human cruelty or even sadism. Some instances of this type of conduct are discussed in an article entitled "Anti-Social Behavior of Ants."² Since the writing of that article, a further incident has occurred in my nests which may be of this type, and which merits recording. I had a nest containing a queen and three workers of *Formica subsericea* to which, from time to time, I introduced some young of *Formica neocinerea*. The first of these alien ants was born into the nest on March 16, the second on March 17, and a third on April 10. These workers behaved and were treated precisely as would ants that were progeny of the queen. On the evening of April 15 the fourth *neocinerea* was born, the *subsericea* queen died on the night of April 17-18, and on April 18 one of the older *neocinerea* was observed attacking her callow sister. The attack was persistent, until I separated them by force after a few hours. The attack was not then repeated. This affair was exceptional, since the participants were not only nest-mates and blood-sisters, but also because they were so very young. A newly born worker is hardly ever attacked by any ant of its own or a closely allied species, regardless of the nest of origin.

I have observed that fighting frequently breaks out between affiliated queens in an incipient nest, and the timing of these outbreaks strongly suggested to me that the motivation was jealousy between the queens for the loyalty of the brood. This was discussed in "Communal Disaffection in Ants."³ Since the publication of that article I have found that a similar case was re-

¹ Journal of Comparative Psychology, Vol. 29, No. 3, p. 327, June 1940.

² To be published in The Journal of Comparative Psychology.

³ Journal of the N. Y. Entomological Society, Vol. XLIX, p. 199, June 1941.

ported by von Buttler-Reepen, where two *Lasius niger* queens fought shortly after the birth of their first young, although they had lived peacefully together for almost a year.⁴

There are times when it may seem to be to the communal interest to dispose of certain members of the community, as is the case with drones among the bees. Indeed, it has been reported that some ants similarly dispose of any males that may be left after the annual swarming. Sterile queens are almost as useless, and Brun, who observed the workers in a nest of *Lasius niger* kill one of two adopted queens, believes this conduct to be the result of the victim's sterility.⁵ While Brun's conclusions may well be correct, his data are hardly sufficient to validate his hypothesis. It is supported, nevertheless, by some associated facts. In some cases of formicine parasitism, the workers regularly kill off their own queens in favor of the parasitic queens; presumably because the latter are smaller and require less sustenance. Forel suggests that *Formica fusca* slaves may object to the food consumption of their *Polyergus* masters in times of scarcity, and relates a fatal disturbance that resulted from this.⁶

Another case, though incompletely authenticated, occurred in the Bronx zoo this past winter. For some time a nest of the leaf-cutting *Atta* has been housed in the reptile house, where the lines of leaf-bearing ants is a great public attraction. To increase the showiness of the spectacle, the zoo provided roses of different colors, in the expectation that the various colors of petals and the green leaves would provide a brilliant show. Unfortunately the ants decided otherwise, and confined themselves to the yellow petals, taking the red ones only after the yellow were exhausted, and the leaves only when everything else was gone. This year it was decided that the ants should be given fallen petals as an economy measure, whereupon the ants went on a hunger strike. It was the habit of this colony to deposit its dead during the night, and the death rate increased during this period to several hundred a day. It was suggested that the ants

⁴ Archiv für Rassen- und Gesellschafts- Biologie, 1905, pp. 24-31.

⁵ Biologisches Centralblatt, 1912, p. 163-167.

⁶ International Monthly, Vol. 5, p. 721-722, Burlington Vt., 1902. Republished in "Punitive Behavior of Ants," *q. v.*

deliberately reduced their number in view of their depleted food resources, but unfortunately there is no direct evidence on this point, however probable it may seem. The arrangements in the reptile house are such that no glimpse of the interior of the nest is possible, and even the exterior was not observed during the night. As soon as living roses were again supplied, the death rate was reduced to the normal. Reports of these events that appeared in the newspapers inferred that the workers were eating each other in lieu of other food, and although this is highly improbable, there is no direct evidence to refute it. It is much more likely that the corpses would be used as fertilizer for the fungus beds as it is known that these ants use their own excrement for this purpose. But even this is hardly to be accepted as there was no indication, on the discarded corpses of the ants, of actual violence. Perhaps this is putting it too strongly: the correct statement is only that the officials at the zoo do not remember any evidences of mutilation.

The suggestion of cannibalism, although unfounded in the case just considered must not be ignored when considering possible motivations for anti-social conduct. If ants may kill one another for other reasons including the reason that there is not enough food to go around, it would seem likely that they might do the same for cannibalistic use. Especially is this the case among ants that regularly feed on their own dead, as do *Formica subsericea*. There is, however, no evidence of such behavior, though it is a well-nigh universal practice of ants to use their larval forms as food when necessary. Queens frequently eat their eggs in the early stages of the nest, and I have many times observed pupae similarly consumed. We might add that cannibalism is quite ordinary among the termites.

Janet has suggested that ants may kill one another for lack of space when they become overcrowded. This factor may well have been present in the case of the *Atta* already reported, and Janet himself describes *Solenopsis fugax* and *Tetramorium caespitum* as killing off supernumerary queens when expansion of the nest became impossible.⁷ But even in a natural nest a

⁷ Reported by Forel, in "The Social World of the Ants," Vol. 1, p. 428, Boni, N. Y., 1929.

similar thing may occur, for Bruch observed *Acromyrmex Lundii* kill fertile queens shortly after swarming time by cutting off their abdomens,⁸ and Brauns observed fertile queens of *Messor meridionalis* driven out of their nests by workers or other queens.⁹ It seems likely that all these instances are somehow related, and two hypotheses come to mind. Perhaps queens fertilized in the nest or returning to it after a nuptial flight are subsequently driven out with or without workers as a sort of colony-budding process. Of perhaps the new queens are accepted and the old ones, whose seminal vesicles may be exhausted or nearing exhaustion, are driven out or killed. On the other hand, Janet's hypotheses may be near the truth, and the ants may restrict their numbers to a limit determined by the species or by the resources of the vicinity.

If fighting within the community once starts, it might spread by imitation. In "Communal Disaffection in Ants" I have described how workers twice joined with one of their queens in an attack upon another. Jealousy, which is the presumed motive of the queens, would not apply to the workers, who may therefore have been following the cue given by the queen. This motive would also act to cause the observed continuity of disturbance noticed in the cases described in "Anti-Social Behavior among Ants" and in the present article and is, obviously, closely parallel to mob psychology among human beings

There are, in addition to the ones we have already mentioned, cases of civil disturbances that do not fall into any of these six categories. By this I do not mean merely that it is uncertain in which category they belong; as would be true in the case where fertile queens were simultaneously expelled from many nests of the same species in a given locality; but that it is apparent that no one of the motivations previously discussed will explain the situation. An example involving this difficulty occurred among my nests recently. A fairly large nest of *Myrmica scabrinodis* was dug up by Mr. Windsor in Chicago on April 13, and received by me on April 19. On April 22 the ants were allowed to migrate from a temporary into a permanent nest, and on April 23 fourteen decapitated corpses were observed. Their deaths must all

⁸ Revista del Museo de la Plata, 1921, p. 175-211.

⁹ Forel, "The Social World of the Ants," Vol.2, p. 232.

have occurred within twenty-four hours. At the same time one worker was observed grasping another's neck, a grip which she maintained half an hour. At the end of that period the aggressor released her hold, and I noticed that both were treated normally by the other workers. After about a minute they met again, and the aggressor seized her victim's antenna, then her head, and then released her once more. After seven or eight minutes during which the two did not meet, I lost track of them in the crowd.

No further corpses were found the next day, nor were any subsequent attacks observed until May 9, when two workers were seen attacking a third. Some further fighting was observed around May 13, and again on May 28. These dates are not the only ones on which fighting occurred, since minor fighting was not always recorded and because the nest was observed rather infrequently.

On June 7 the fighting increased in intensity. Two pairs were observed, one in each pair chewing at the other's pedicel. After an hour and a half I used a glass to focus the sun's rays on the aggressors and they let go. At this time and subsequently, it was noticeable that when separated in this or in any other way the aggressor made no effort to find her victim, and when they met accidentally after separation no further fighting developed. In this and in almost every other way this case differs from the apparently deliberate cruelty of *Formica neocinerea*.

A few minutes after separating the two pairs mentioned above, another pair was observed in a similar struggle, but the victim wandered off when the aggressor let go to clean herself. Later two more pairs were observed, both grips being antennal, and after an hour and a half I separated them by the same method used before. On June 9 the nest was unobserved, but on the tenth there were several fighting pairs one of which could not be separated by the use of the glass, the aggressor being sufficiently tenacious to suffer sooner than to release her victim.

At this point it was evident that none of the categories discussed in this article would apply to this case unless it could be lack of space that induced the trouble, there being approximately four hundred ants in a nest of forty square inches. To test this hypothesis I connected the nest with an empty one of similar

construction and equal size expecting that, if the hypothesis were correct, the ants would either divide into two nests or use the new one as an antechamber. In either case the fighting should stop. But in fact the ants showed no great interest in the new nest, beyond the number of exploratory visits that would be expected in such a confined space. I then proceeded to divide the nest by force, putting two of the seven queens, a few young, and almost half the workers in the new nest. Although this involved handling many of the ants, no fighting was caused thereby, which helps to dispose of the possibility that the fighting might be caused by a failure of recognition. Finally the disturbances not only failed to disappear, but even increased somewhat in frequency and intensity in the succeeding days, several deaths occurring which were probably due to this condition. This was true, moreover, not only of the old nest where the pressure of population was much decreased but also in the new nest, where the actual population was less than half the original density, and the potential population distinctly inferior. The condition of casual fighting that was typical of the original nest thus continued to be true of both its successors. The hypothesis of spacial restriction is therefore untenable in this instance, and no other hypothesis is at present available to account for the facts.¹⁰

We have, then, four motives fairly well established as possible causes of civil strife among formicine communities: these are, punishment or pseudo-punishment, cruelty, jealousy, and the communal interest in disposing of such unneeded individuals as males or infertile or overlarge females. In addition there are other possible motives in lack of food, cannibalism, spacial limitation, and imitation. Even with this additional list of possible motives, however, it is clear that there is a residue of anti-social behavior that still awaits explanation.

¹⁰ It is nevertheless possible, if highly improbable, that spacial restriction may have been responsible for originating the fighting which continued subsequently as a result of imitation.

THE ELATERIDÆ OF PENNSYLVANIA*

BY C. A. THOMAS

PENNSYLVANIA STATE COLLEGE

As part of a study on the Elateridæ, or click beetles inhabiting Pennsylvania, a number of collections and publications was examined and the data were assembled into the following list. This shows the approximately 220 species and varieties of this coleopterous family which have been found in this state, their distribution, and gives some idea of the comparative abundance of each species. The arrangement of the Leng list and its supplements has been used; the localities of collection are arranged as nearly as possible according to their location from eastern to western Pennsylvania. Most of the collecting of elaterids has occurred in the southern half of the state, especially near Philadelphia, Harrisburg and Pittsburgh, with a lesser amount in the eastern and western counties north of those cities. Only a limited amount of collecting has been done in the north central and northern border counties. It is hoped that these latter localities may be more extensively examined, in order to determine whether the species found further south in the state have a distribution which is continuous with the same species as noted in Leonard's New York State list. John B. Smith's 1909 New Jersey list records several species which have so far not been found in Pennsylvania.

The collections consulted in compiling this list were as follows: the collections of Knull, Kirk and the Bureau of Plant Industry (BPI) at Harrisburg; of Horn, Haimbach and Frank Mason at the Philadelphia Academy of Natural Sciences; of the Zoology Department of the University of Pennsylvania; the Reading Museum collection, mostly collected by Dr. D. M. Castle near Philadelphia; the collections at the University of Delaware (Newark, Del.); Cornell University (Ithaca, N. Y.); Franklin and Marshall College (Lancaster, Pa.); Rutgers University (New Brunswick, N. J.); the H. W. Wenzel collection at Ohio State Univer-

* Authorized for publication on May 7, 1940, as paper No. 973 in the journal series of the Pennsylvania Agricultural Experiment Station.

sity; the Slosson and Palm specimens in the American Museum of Natural History, New York; the E. D. Quirsfeld collection; the Klages collection at the Carnegie Museum in Pittsburgh; and the writer's personal collection, which also contains numerous specimens collected by S. W. Frost at Arendtsville, Pa. Data on Pennsylvania-collected specimens were also contributed by M. C. Lane, Walla Walla, Washington, W. J. Brown, Ottawa, Canada, H. C. Fall, Tyngsboro, Mass., and specialists of the United States National Museum at Washington, D. C. The above coleopterists also kindly identified many specimens for the writer, while others were determined by comparison with the types in the Horn collection at the Academy in Philadelphia, or from descriptions in the literature. The lists by Hamilton and Klages have provided a number of Pennsylvania records. When the specimens in any collection could not be accurately identified, those records were omitted from this list, and will be considered in a later paper.

In general, the records from the region of the Pocono Mountains and the Delaware Water Gap were from Palm, Nicolay and Quirsfeld; Bethlehem region by Slosson, Quirsfeld and G. W. Caffrey; Philadelphia, Bucks and Delaware counties by Haimbach, Kaeber, Robinson and Castle; Chester County by Thomas; Lancaster County, by the Franklin and Marshall College collection; Harrisburg and the Susquehanna Valley by Champlain, Greene, Kirk, Knull and their associates of the Pennsylvania Bureau of Plant Industry; State College vicinity, by students in the Zoology Dept.; Mt. Alto by Knull; Arendtsville by Frost; Jeanette, Pittsburgh and vicinity by Hamilton, Klages and Chermock. Although the Fall and Liebeck collections, now in the Museum of Comparative Zoology, have not been examined, they undoubtedly contain Pennsylvania collected elaterids. Since it is impossible within the confines of this paper to include the name of the collection from which each locality record was made, these in most instances have been omitted; however, these will be furnished to anyone who applies to the writer.

The writer wishes to express his appreciation to all the above collectors who so kindly sent data to be used in this list, or who permitted examination of the collections under their care. He also wishes to thank Mr. George Greene, of the Pennsylvania

Bureau of Plant Industry, for the use of many notes taken from his personal files.

To this paper is appended a list of publications containing original descriptions of Pennsylvania elaterids, and many notes on these insects.

THE ELATERIDÆ OF PENNSYLVANIA

Pyrophorinæ

ADELOCERA Latr.

The larvæ and adults of this genus are usually found under the bark of dead trees, stumps and logs. The larvæ of some species are predacious.

8553—*aurorata* Say. Throughout the winter in the above situations; June. Beneath the bark of dead pitch pine, according to Kirk, '22. Greentown, Clarks Valley, Clearfield, State College, Loretto, Jeannette, Wilmerding, Pittsburgh.

8554—*impressicollis* Say. Type locality Pennsylvania: Say, 1825, 260. Active from mid-April to mid-July. Hibernates in decaying cavities of old trees (Kirk, '22). Not common, although Hamilton, '95, stated that it was common under old logs in Allegheny County. Harrisburg, Rockville, Chambersburg, Jeannette, Pittsburgh.

8557—*brevicornis* LeC. Rare. Found in stumps in winter; active April to Sept. Delaware Water Gap, Balsam Swamp, Pike County, Mt. Alto, Caledonia, Charter Oak, State College, Ricketts, Allegheny County, Northeast.

8558—*obtecta* Say. Hamilton stated that this species was not rare under the bark of trees. Kirk, '22, found the larvæ in the galleries of wood-borers. Champlain, Kirk and Knull caught them in fermenting baits. Active from early April to mid September. Hibernate under bark. Greentown, Delaware Water Gap, Bethlehem, Angora, Upper Darby, Honey Brook, Kennett Square, Laporte, Hummelstown, Clarks Valley, Inglenook, Chinchilla, Linglestown, McAlevys Fort, State College, Hollidaysburg, Jeannette, Pittsburgh.

8560—*marmorata* Fab. Kirk, '22, found the larvæ feeding on larvæ of bostrychid beetles (*Trichodesma gibbosa*) in a gum tree.

Adults active from April to October. Greentown, Parryville, Tinicum, Mt. Moriah, Parkland, Olney, Angora, Philadelphia, Fernwood, Bromall, Unionville, Manoa, Harrisburg, West Fairview, Linglestown, Hummelstown, Rockville, State College, Jeannette, Wilmerding, Pittsburgh, Allegheny County, New Brighton.

8561—*discoidea* Web. Generally distributed and fairly common throughout the state. Collected in every month except September. Hibernates under bark, in dead logs, etc., as both larva and adult. Found in bait pails in summer. The following are a few typical localities where this species has been collected: Delaware Water Gap, Bethlehem, Wyoming, Lafayette, Olney, Frankford, Philadelphia, Glenolden, Castle Rock, Broomall, West Chester, Kennett Square, Jennersville, Honey Brook, Hummelstown, Rockville, Dauphin, Clarks Valley, State College, Mt. Alto, Chambersburg, Hollidaysburg, Jeannette, Pittsburgh.

8562—*avita* Say. Adults reared from larvæ under bark of dead and dying hickory trees containing wood-boring larvæ on which they fed; adults collected at night (Kirk, '22). March to August. Hummelstown, Harrisburg, State College, Marion, Linglestown, Jeannette, Wilmerding, Pittsburgh.

8563—*modesta* Boisd. Collected in April, July and August. State College, Pittsburgh, Northeast.

—*maculata* LeC. Type locality near Philadelphia: LeConte, 1866, XVIII, 389. Philadelphia: O. Schwartz, 1907, 318; Wilmerding: one specimen in the Lane collection.

ALAUŠ ESCH.

8571—*oculatus* L. Common and widely distributed. This, our largest click beetle and wireworm, is most common in May, June and early July, but has been collected in nearly every month. The adult hibernates under bark and in rotten logs and stumps. The large larvæ are very active and pugnacious; they feed on the larvæ of woodboring beetles and other insects which live under bark and in decaying wood. Kirk, '22, said that this species occurs only on deciduous trees, according to the notes of the Bureau of Plant Industry. Champlain, Kirk, and Knull ('26, '32) caught many adults in baits in June and July at Clarks Valley. Typical collections: Bethlehem, Scranton, Pittston,

Kutztown, Philadelphia, Germantown, Angora, Roxboro, Bustleton, Media, Swarthmore, Broomall, Devon, Castle Rock, Cheyney, Kennett Square, Unionville, Honey Brook, Reading, Mt. Hope, Hummelstown, Harrisburg, Rockville, Clarks Valley, Mt. Alto, Hollidaysburg, Benton, State College, Irvona, Danville, Laporte, Williamsport, Port Allegany, Bingham Center, Corydon, Brookville, Erie, Uniontown, New Alexandria, Indiana, Jeannette, Pittsburgh, and many other localities.

8572—*myops* Fab. This beetle, which is locally fairly common in the New Jersey Pine Barrens, is quite rare in Pennsylvania, where it is found under loose pine bark. Kirk, '22, collected it near Harrisburg in pine trees and stumps infested with woodboring larvæ. Knull, '32, found it feeding on adult carpenter ants in a decaying pine log. The writer found it breeding under bark on dead pines in the Nottingham Barrens, Chester County, Pa., in May 22, 1940. It has been collected in January, March, May to August, and November, at Angora, Hummelstown, Rockville, Mt. Alto, State College, Harrisburg, Promised Land Lake (Pike County).

HEMIRHIPUS LATR.

8576—*fascicularis* Fab. This is apparently very rare in Pennsylvania. Specimens labelled Pittsburgh are in the Klages collection. One Philadelphia specimen in the Bureau of Plant Industry collection. One in the collection at Franklin and Marshall College, Lancaster, labelled Pa. Pennsylvania specimens are also in the Horn and Wenzel collections. June and July.

CHALCOLEPIDIUS ESCH.

8584—*viridipilis* Say. An uncommon species found in southern Pennsylvania. Kirk, '22, collected a specimen at Rockville on sour sap on an oak tree in the evening. Active in June to August. Collected at Cornwells, Philadelphia Neck, Lester, Linglestown, Rockville, Franklinville, Jeannette and Pittsburgh.

CONODERUS ESCH. (MONOCREPIDIUS)

8596—*lividus* De G. One of our more common click beetles, especially in southeastern Pennsylvania. The adults are active

from late May to early September. They are commonly attracted to lights and to molasses baits, and are frequently beaten from the leaves of peach, hickory, walnut, oak and other trees. The larvæ are predacious, but also feed to some extent on crops. Typical collections: Bethlehem, Delaware Water Gap, Morrisville, Feasterville, Uhlertown, Philadelphia, Mt. Airy, Fox Chase, Overbrook, Angora, Glenolden, Broomall, Chadds Ford, Avondale, Kennett Square, West Grove, Jennersville, Downingtown, Homeville, New Holland, Reading, Paxtang, Hummels-town, Harrisburg, New Bloomfield, Linglestown, Franklinville, Carlisle Jet., York, State College, Williamsport, Jeannette, Pittsburgh.

8601—*vespertinus* Fab. Larvæ injurious to roots of truck crops and tobacco, but not important in Pennsylvania. Adults sometimes found on mullein. Active May to August. Philadelphia, Delaware County, Jeannette, Allegheny County.

8607—*auritus* Hbst. Adults active from late April to September. Hibernates under weeds, stones, mullein leaves, etc. Delaware Water Gap, Wyoming, Bethlehem, Manayunk, Philadelphia, Bustleton, Germantown, Frankford, Roxboro, Mt. Airy, Angora, Glenolden, Broomall, Castle Rock, Harrisburg, Chinchilla, Rockville, Enola, Linglestown, Ingleenook, Charter Oak, Jeannette, Pittsburgh.

8609—*bellus* Say. Active May to August. Adults hibernate. Sometimes attracted to lights. Bethlehem, Manayunk, Philadelphia, Angora, Mt. Airy, Germantown, Glenolden, Broomall, Castle Rock, Kennett Square (several under rubbish in greenhouse), Downingtown, Rockville, Mt. Alto, Jeannette, Allegheny County (rare, according to Hamilton).

AEOLUS ESCH. (DRASTERIUS)

8613—*amabilis* LeC. Adult hibernates, and is active from April to August. Attracted to baits. Philadelphia, Angora, Tinicum Island, Middletown, Harrisburg, Linglestown, Enola, Rockville, Arendtsville, Caledonia, Jeannette.

8614—*mellilus mellilus* Say. (*Drasterius elegans* of authors.) The larva of this species is injurious to tobacco roots. Delaware Water Gap, Bethlehem, Philadelphia, Bustleton, Angora, Mt.

Airy, Frankford, Glenolden, Kennett Square, Green Lawn, West Grove, Palmyra, Middletown, Harrisburg, Rockville, Lemoyne, State College, Arendtsville, Mechanicsburg, Jeannette, Pittsburgh.

PITYOBIUS LÆC.

8617—*anguinus* LeC. Endeavor. Now in the Bureau of Plant Industry collection, this was collected by Knull on July 30. It apparently is the only Pennsylvania record, although it has been taken occasionally in New Jersey and southern New York. The above larva was taken on a freshly cut white pine log, according to Kirk, '22. The large larva resembles that of *Alaus oculatus*, and lives under bark and in rotten wood in the same manner as that species.

LIMONIUS ESCH.

8619—*auripilis* Say. May to July. Delaware Water Gap, Bethlehem, Nottingham Barrens (beaten from Post Oak), Hummelstown, Drumgold, Cedar Run, Laporte, Kane, Horse Valley (Franklin County), Mt. Alto, Chambersburg, Charter Oak, Hollidaysburg, Jeannette, Pittsburgh, Charleroi, Allegheny County (not rare, according to Hamilton).

8624—*aurifer* LeC. June, July. Rare. State College, Forksville, Barbours, Laporte, Murraysville, Jeannette, Allegheny County (rare (Hamilton, 1895)). Williamsport: LeConte, 1866, p. 347.

8625—*propexus* Cand. (*griseus* Beauv.). A common species from mid May to late July. May often be found on rhubarb flowers in May, and on weeds. Typical collections: Edge Hill, Parkland, Ashbourne, Philadelphia, Bustleton, Olney, Fairmount Park, Glenside, Germantown, Roxboro, Manayunk, Glenolden, Devon, Castle Rock, West Chester, Kennett Square, Avondale, Oxford, Downingtown, Lancaster, New Holland, Pequea, Landisburg, Hummelstown, Linglestown, Harrisburg, New Germantown, Cly, Marsh Run, Cresco, Charter Oak, Jeannette, Pittsburgh.

8626—*griseus* Beauv. (*interstitialis* Melsh.). Type locality Pennsylvania: Melsheimer, 1846. Much more scarce than *propexus*. May to August. Manayunk, Bustleton, Philadelphia Neck, Upper Darby, Kennett Square, Eberleys Mill, Jeannette,

Pittsburgh, Allegheny County (rare (Ham., '95)). LeConte, 1853, p. 430, cited a Pa. record.

8627—*confusus* LeC. Early May to mid July. Cresco, LaPorte, Barbour, Philadelphia, Roxboro, Castle Rock, Hummelstown, Linglestown, Perry County, Mt. Alto, Jeannette, Allegheny County (not common (Ham., '95)).

8629—*plebejus* Say. A fairly common and widely distributed species. Early April to late July. Typical collections: Cresco, Bethlehem, Upper Darby, Castle Rock, Hummelstown, Rockville, Enola, Harrisburg, Herndon, New Germantown, Columbia County, State College, Clearfield, Mt. Alto, Shippensburg, Hartstown, Sandy Lake, Jeannette, Pittsburgh, Northeast, Washington County, Allegheny County (very common (Ham., '95)).

8631—*ager* LeC. Klages collection contains specimens labelled this, from Pennsylvania. W. J. Brown believes that this may be found in Pa. Blackwelder lists it from Pa. in Leng's 4th Supplement, 1939, p. 39.

8633—*quercinus* Say. A small species sometimes common on oak and hazelnut in May to July. Numerous in baits in June and July at Clarks Valley, according to Champlain and Knull, '32. Lehigh Gap, Bethlehem, Edge Hill, Penllyn, Parkland, Philadelphia, Roxboro, Frankford, Glenolden, Avondale, Hummelstown, Harrisburg, Inglenook, Linglestown, New Bloomfield, Charter Oak, State College, Chambersburg, Carlisle, Jeannette, Pittsburgh, Allegheny County (very common (Ham., '95)).

8635—*basillaris* Say. Another small species on oaks; quite similar to *quercinus*. Numerous in baits at Clarks Valley, according to Champlain and Knull, '32. Bethlehem, Frankford, South Philadelphia, Manayunk, Lester, Castle Rock, Kennett Square, Jennersville, Hummelstown, Harrisburg, Rockville, New Bloomfield, Charter Oak, Northeast, Jeannette, Pittsburgh.

8639—*dubitans* LeC. (*Nothodes dubitans* LeC.). Type loc. Pa.: LeConte, '53, p. 433. May and June, on *Ambrosia trifida*, rhubarb and other flowers. This is the common economic wireworm pest of truck crops, potatoes, etc., in southeastern Pennsylvania. Bustleton, Cornwells, Philadelphia, Hulmeville, Kennett Square, Downingtown, Pottstown, Millerstown, Hummelstown, Harrisburg, Indiana, Jeannette, Pittsburgh.

8640—*stigma* Hbst. April to late June. Edge Hill, German-

town, Upper Darby, Castle Rock, Inglenook, Rockville, Barbours, Forksville, Chambersburg.

8649—*anceps* LeC. Leng lists this species from Pennsylvania, but it is not represented in any collection which I have examined. Van Dyke ('32) and Fall ('34) believe this to be only a phase or variety of *ectypus*.

8650—*ectypus* Say. Greentown, Cornwells, Harrisburg, Charter Oaks, Forksville, Warren, Jeannette, Pittsburgh. O. Schwarz, 1906, p. 195, and Leng ('20) list this species from Pennsylvania as does Leng's 4th Supplement, 1939, p. 39. Listed from Williamsport by LeConte, 1866, p. 347.

—*agonus* Say. The larvæ are injurious to corn and potatoes in northwestern Pa. Active late April to July. Cresco, New Market, Harrisburg, Inglenook, Warren, Jeannette, Pittsburgh, Allegheny County (common, according to Hamilton), Forest County (on corn grains). It is probable that southeastern Pa. records refer to *dubitans*, acc. to M. C. Lane.

8652—*ornatipennis* LeC. Type locality, York, Pa.: LeConte, 1863b, p. 84. Apparently rare in Pennsylvania. One Delaware County specimen in the University of Pennsylvania collection, and one in the Horn collection. Hamilton collected one on sassafras in Allegheny County. O. Schwarz, 1906, p. 195, and Leng both list this species from Pennsylvania.

8653—*definitus* Zieg. Hummelstown, Harrisburg, Heckton Mills, Mt. Alto, Allegheny County (rare here and at St. Vincent (Latrobe) according to Hamilton). May, June.

8654—*nimbatus* Say. Delaware Water Gap, Edge Hill, Parkland, Glenolden, New Bloomfield, Mt. Alto, Jeannette. According to Hamilton it is rare in Allegheny County and at St. Vincent. Melsheimer, 1806, p. 931, and LeConte, 1853, p. 434, both list it from Pennsylvania, the latter giving it as *L. infernus*. May–July.

—*knulli* Fall. Type locality: Forksville, Pa., July 17, 1930; Fall, '33, p. 229. Also collected by Knull at Laporte.

ELATHOUS REIT. (LEPTOSCHEMA HORN)

8657—*bicolor* LeC. Specimens in the Klages collection labelled Jeannette and Indiana. Pennsylvania specimens in the Lane collection. April.

8658—*discalceatum* Say. Adult in pupal cell in decayed pitch pine at Cold Springs, Adams County, July 26, according to Knull, '32. Listed from Pennsylvania by LeConte, 1853, p. 428, and Leng, 1920. May to mid September. Rockville, Clarks Valley, Indiana, Erie, Jeannette, Pittsburgh, Latrobe.

ATHOUS ESCH.

8661—*trivittatus* Melsh. Type locality Pennsylvania: Melsheimer, 1846, p. 157. Leng lists this from Pennsylvania. No specimens found in collections which I have examined.

8662—*brightwelli* Kby. Common throughout the state. Adults found on oak, beech, walnut and hickory, late April to late August. Are attracted to molasses baits. Larvæ live in rotten logs and stumps. Cresco, Buck Hill, Graterford, Philadelphia, Swarthmore, Castle Rock, Cornwells, Hummelstown, Harrisburg, Inglenook, Rockville, Clarks Valley, Laporte, Arendtsville, Chambersburg, Mt. Alto, Charter Oak, Jeannette, Pittsburgh.

8663—*acanthus* Say. Beaten from willow and other trees. April through July. Delaware Water Gap, Edge Hill, Tabor, Philadelphia, Glenolden, Hummelstown, Harrisburg, Dauphin, Mt. Alto, Hollidaysburg, Northeast, Jeannette, Pittsburgh, Waynesburg.

b-maculicollis LeC. Numerous in baits in July at Clarks Valley, according to Champlain and Knull, 1932. Rare in Allegheny County, according to Hamilton. May–July. Enterline, Hartstown Bog, Jeannette, Pittsburgh.

8667—*cucullatus* Say. Attracted to bait pails. The larvæ feed on wood-boring larvæ in dead logs, according to Kirk, 1922. May to September. Delaware Water Gap, Easton, Montgomery County, Phoenixville, Darby, Markham, Avondale, Cornwells, Philadelphia, Hummelstown, Harrisburg, Rockville, Clarks Valley, Endeavor, State College, Pond Bank, Erie, Jeannette, Pittsburgh. Not common in Allegheny county, according to Hamilton.

—*hypoleucus* Melsh. Leng lists this from Pennsylvania.

8668—*scapularis* Say. Adults on oak and hickory, and in baits; May to Sept., larvæ in rotten stumps and logs. Delaware Water Gap, Lehig Gap, Parkland, Wyoming, Ricketts, Philadel-

phia, Frankford, Upper Darby, Markham, Mendenhall, Stoverdale, Inglenook, New Cumberland, New Bloomfield, Sweden Valley, Arendtsville, Cold Springs, Camp Hill, Charter Oak, Lewisburg, Northeast, Jeannette, Wilmerding, Pittsburgh.

8669—*equestris* LeC. May–July. Not common in Allegheny County (Hamilton), Roxboro, Uniontown, Charleroi, Jeannette, Pittsburgh.

8670—*posticus* Melsh. Type locality Pennsylvania: Melsheimer, 1846, p. 158. Klages collection contains specimens labelled this from Jeannette and Pittsburgh. Klages, 1901, p. 271, called it rare. It is also listed from Pennsylvania by LeConte, 1853, p. 426; Leng, 1920, and Van Dyke, 1932. May–July.

8671—*fossularis* LeC. Enterline, Endeavor, in July (Bureau of Plant Industry).

8676—*rufifrons* Rand. May–July. Mendenhall, Speeceville, Pecks Pond (Susquehanna County), Painter Den Pond (Sullivan County), Laporte, Cooksburg, Northeast, Erie, Jeannette, Pittsburgh.

LEPTUROIDES HBST. (CAMPYLUS FISCHER)

8696⁸—*productus* Rand. May–July. Horse Valley (Franklin County), Latrobe, Jeannette.

8699—*denticornis* Kby. Allegheny County, on weeds in wet ground, not rare according to Hamilton. May and June. Pike County, Ricketts, Jeannette, Pittsburgh. Listed from Pa. by LeConte, 1853, p. 423, and Blatchley, p. 759.

—*flavinasus* Melsh. Type locality, Pa.: Melsheimer, 1846, p. 219. Clearfield, Laporte. June.

LUDIUS ESCH. (CORYMBITES LATR.)

8705—*vernalis* Htz. April, May. Nottingham, Pond Bank, Chambersburg.

8707—*resplendens* Esch. June, July. Painter Den Pond, Northeast.

8708—*sjaelandicus* Muller. April–July. Delaware Water Gap, Frankford, Hummelstown, Charter Oak, Erie

—*tesselatus* Fab. April–June. Ashbourne, Linglestown, South Fork Camp, West Lenox.

8709—*atropurpureus* Melsh. Type locality Pa.: Melsheimer, 1846, p. 215. Delaware Water Gap. Recorded from Pa., by LeConte, 1853, p. 442; O. Schwarz, 1906, p. 224, and Leng, 1920.

8715—*pyrrhos* Hbst. June–August. Numerous in bait pails at Clarks Valley in July, according to Champlain and Knull, 1932. Also found on walnut, hickory and other trees. Quite common throughout Pennsylvania: Delaware Water Gap, Parkland, Philadelphia, Bustleton, Darby, Broomall, Devon, Downingtown, Kelton, Wrightsville, Harrisburg, Hollidaysburg, Charter Oak, Erie, Rector, Jeannette, Pittsburgh.

8717—*bivittatus* Melsh. Klages, 1901, recorded this from Jeannette. June, July.

8721—*cylindriformis* Hbst. Late March to late August, chiefly in April and May. A fairly common species. Delaware Water Gap, Easton, Bethlehem, Parkland, Cornwells, Bustleton, Germantown, Tabor, Castle Rock, Downingtown, Avondale, Dresher, Hummelstown, Harrisburg, Chinchilla, Perdix, State College, Loretto, Cross Forks, Jeannette, Pittsburgh.

8727—*fulvipes* Bland. Mid April to early July. Hummelstown, Inglenook, Rockville, Arcola, Perdix, Mt. Alto, Renovo, Danville, Laporte, Ricketts, Jeannette, Pittsburgh. Hamilton listed the form *rufipes* Bland. from Allegheny County.

8734—*elongaticollis* Ham. Type locality: western Pa.: Hamilton, 1893, p. 307. May–July. Occasionally on rhubarb flowers. Allegheny County, not rare (Ham.). Germantown, Frankford, Bustleton, Clearfield, Nordmont, Laporte, Jeannette, Pittsburgh.

8738—*tarsalis* Melsh. Type locality Pa.: Melsheimer, 1846, p. 157. Late April to early July. On rhubarb and mustard flowers. Parkland, Cornwells, Bustleton, Roxboro, Manayunk, Castle Rock, Broomall, Middletown, Harrisburg, Hummelstown, Laporte, Pine Grove, Forksville, Wyoming, Chambersburg, Arendtsville, Jeannette, Wilmerding, Pittsburgh. Van Dyke says this is a subspecies of *caricinus* Germ. (8733).

8741—*insidiosus* LeC. Mt. Alto, Barbour, Laporte, Ricketts. June.

8748—*sulcicollis* Say. Adult active from April to August; hibernates in dry rotten stumps. Adult found in pupal cell in

decayed *Pinus rigida* at Cold Springs, Adams County, August 16, by Knull, '32. Pike County, Delaware Water Gap, Broomall, Hummelstown, Harrisburg, Endeavor, Linglestown, Chambersburg, Pecks Pond, Jeannette, Pittsburgh.

8751—*morulus* LeC. The Wenzel collection and the Castle collection each contain a specimen labelled this, from Pennsylvania.

8761—*athlops* Hbst. May to mid July. Clarks Valley in bait pails in July, according to Champlain and Knull, 1932. Hamilton found them not common in Allegheny County, by beating *Ampelopsis*. Bethlehem, Edge Hill, Philadelphia and vicinity, Swarthmore, Devon, Castle Rock, New Garden, Hummelstown, Inglenook, Rockville, Drumgold, Speeceville, Chambersburg, State College, Jeannette, Pittsburgh, Erie.

8762—*hamatus* Say. May to late July. A few found in baits. Hamilton said it was not common in Allegheny County, on oak and maple. Cresco, Delaware Water Gap, Parryville, Parkland, Manayunk, Philadelphia, Angora, Castle Rock, Downingtown, Harrisburg, Inglenook, Clarks Valley, New Bloomfield, Forksville, Ricketts, Laporte, Arendtsville, Jeannette, Erie.

8763—*propola* LeC. Rosecrans, Jeannette, Northeast. June-August.

8766—*triundulatus* Rand. North Mountain, Laporte, Jeannette. In bait pails in June, according to Champlain and Knull, 1932.

8769—*medianus* Germ. Indiana, in June, listed by Klages, 1901, p. 27. Champlain collected it at Clarks Valley in May.

8771—*fallax* Say. Laporte, in June, according to Knull.

8776—*splendens* Zieg. Type locality: western Pennsylvania: Ziegler, 1844, p. 44. May to late July. Hummelstown, Clarks Valley, Rosecrans, Perry County, Mt. Alto, Charter Oak. Also listed from Pennsylvania by LeConte, 1853; O. Schwarz, 1907; Blatchley, 1910; Leng, 1920, and Brown, 1935, p. 127.

8777—*areipennis* Kby. Charter Oak, Northeast. June, July. According to Brown (1935, p. 129), *areipennis* collected in the East are to be referred to *appropinquans* and *darlingtoni*.

8778—*nigricornis* Panz. Linglestown, Northeast. June, July.

8780—*inflatus* Say. Type locality Pennsylvania: Say, 1825, p. 258. April to late July. Allegheny County, common (Hamil-

ton). Mt. Pocono, Delaware County, Linglestown, Rockville, New Bloomfield, Speeceville, Arendtsville (in baits), Mt. Alto, Charter Oak, State College, Indiana, Northeast, Jeannette, Pittsburgh. Also listed for Pa. by LeConte, 1853, p. 438, as rare, and by Leng, 1920.

8781—*crassus* LeC. Type locality Pennsylvania: LeConte, X, 1853, p. 440. Van Dyke, 1932, lists this as a subspecies of *divaricatus* LeC. (8797).

8791—*rotundicollis* Say. Type locality Pa.: Say, 1825, p. 259. June–October. Knull, '32, said that the adults are rather rare, but the larvæ are more common, and predacious on Cerambycid larvæ in deciduous trees. Philadelphia, Hummelstown, Linglestown, Clarks Valley, Mt. Alto, Jeannette, Pittsburgh, Allegheny County (by beating *Ampelopsis* (Ham.)). Also listed by LeConte, 1853, p. 440.

8793—*cruciatus* L. Greentown, Forksville, Laporte. May–July.

8796—*hieroglyphicus* Say. Clarks Valley, many in bait pails in June, July and August, according to Champlain and Kirk, 1926, and Champlain and Knull, 1932. Kirk, 1922, stated that Knull and Champlain collected adults of this species feeding on small insects on foliage. Brown, 1936, p. 182, said types were from Massachusetts, New Hampshire and Pennsylvania. Foxburg, Cresco, Parryville, Greentown, Delaware Water Gap, Wind Gap, Graterford, Frankford, Broomall, Hummelstown, Harrisburg and vicinity, Charter Oak, State College, Laporte, Jeannette, Pittsburgh, Allegheny County (common, according to Hamilton).

HEMICREPIDUS GERM.

8812—*indistinctus* LeC. Angora, Harrisburg, Dauphin, Enterline, Jeannette, Pittsburgh, Harmarville, Allegheny County (rare, according to Hamilton). June–August.

8813—*decoloratus* Say. Common and widely distributed. Collected on asparagus and other leaves, by sweeping, and in baits. May to August. Greentown, Bethlehem, Lehigh Gap, Dalton, Easton, Delaware Water Gap, Parkland, Philadelphia, Bustleton, Hulmeville, Frankford, Glenside, Castle Rock, Upper Darby, Mendenhall, Avondale, Downingtown, Pomeroy, Hum-

melstown, Harrisburg, Dauphin, Endeavor, Charter Oak, State College, Laporte, North Mountain, Cresson, Foxburg, Jeannette, Pittsburgh.

—*hemipodus* Say. Feasterville, Hulmeville, Swarthmore, Downingtown, Mendenhall, Lancaster County, Harrisburg, Linglestown, Northeast, Pittsburgh. Listed by Hamilton. June, July.

areus Melsh. Allegheny County, rare, according to Hamilton.

8814—*memnonius* Hbst. Common and widely distributed; frequent in bait pails in July. June–August. Milford, Bethlehem, Coopersburg, Delaware Water Gap, Parkland, Philadelphia, Frankford, Roxboro, Fernwood, Lower Merion, Glenolden, Oxford, Delano, Lancaster, Hummelstown, Harrisburg, Clarks Valley, Endeavor, Arendtsville, Charter Oak, State College, Laporte, Northeast, Erie, Indiana, Jeannette, Pittsburgh.

8815—*brevicollis* Cand. Easton, Parkland, Germantown, York, Indiana, Jeannette, Pittsburgh. June to early September.

8817—*bilobatus* Say. On hickory trees at night, according to Kirk, '22. Late May to late August, Delaware Water Gap, Hulmeville, Philadelphia, Germantown, Roxboro, Harrisburg, Rockville, Clarks Valley (in bait pails), Williamsport, Erie, Jeannette, Pittsburgh.

—*cavifrons* Melsh. Listed from Pa., by LeConte, 1853, p. 453, and by Leng, 1920.

HYPNOIDUS STEPH. (CRYPTOHYPNUS ESCH.)

8820—*pulchellus* (L.). Listed by LeConte, 1866, p. 347, from Loyalsock Creek, near Williamsport. Leng, 1920, questions its occurrence in America.

8821—*exiguus* Rand. Listed from Pennsylvania by LeConte, 1853, p. 487. Linglestown, Pittsburgh. June, July.

8826—*abbreviatus* Say. April to October. Forksville, West Lenox, Northeast, Jeannette, Allegheny County (not rare, by beating, according to Hamilton). Horn, 1891, p. 8, listed it from Hazleton.

8831—*planatus* LeC. (= *Lecontei* Leng). September. Chinchilla, Holiday, Pittsburgh. Also listed from Pa. by LeConte,

1866, p. 347; Horn, 1891; Schwarz, 1906, and Leng, 1920.

8832—*striatulus* LeC. Jeannette, Pittsburgh, Allegheny County (two examples under a stone (Hamilton)). Also listed from Allegheny County by Schwarz, 1906. July.

8834—*choris* Say. Delaware Water Gap, North Wales, Frankford, Chambersburg, Harrisburg, Eberleys Mill. April to June. On swamp huckleberry.

8837—*melsheimeri* Horn. Delaware Water Gap, Chambersburg, West Fairview, Jeannette. April, May, October.

—*guttulatus* LeC. Type locality Pa.: LeConte, 1853, p. 487. Linglestown. July.

8841—*tumescens* LeC. Erie, Pittsburgh. June, July.

8845—*perplexus* Horn. Hummelstown, Harrisburg, Jeannette. May–July. Horn, 1871, p. 304, stated that this occurs in Pennsylvania.

8848—*obliquatulus* Melsh. Type locality Pa.: Melsheimer, 1846, p. 214. Throughout the year; most common in June and July. Manayunk, Harrisburg, Enola, Arendtsville (in baits), Jeannette, Pittsburgh, Allegheny County (common under stones in April (Ham.)). Also listed from Pa. by LeConte, 1853; Candeze, 1860, p. 60; Leng, 1920.

8849—*pectoralis* Say. Milford, Easton, Cornwells, Harrisburg, Jeannette, Pittsburgh. March to late August.

CEOSTETHUS LEC.

8850—*femoralis* LeC. Delaware Water Gap, Linglestown, Jeannette, Pittsburgh, Allegheny County (common on willow in June (Hamilton)). May to October. Horn, 1891, p. 31, lists this from western Pennsylvania.

MELANACTES LEC.

8853—*piceus* DeG. Bethlehem, Lehigh Gap, Edge Hill, Penllyn, Bustleton, Frankford, Glenside, Broomall, Fernwood, Devon, Berwyn, York County (LeConte, 1853, p. 494), Hummelstown, Harrisburg, Linglestown, Landisburg, New Cumberland, Chambersburg, Indiana, Charter Oak, State College, Uniontown, Jeannette, Pittsburgh. April to August. Clarks Valley, numerous in bait pails in July and August, according to Champlain and Knull, 1932.

8855—*morio* Fab. Frankford, Mt. Airy, Glenolden, Marsh Run, Linglestown, Rockville, Dauphin, Chambersburg, Fayette County, Jeannette. June, July.

8856—*puncticollis* LeC. Jeannette in June and July, according to Klages.

CESTODES LEC.

8859—*tenuicollis* Rand. Greentown, Pocono Lake, Harrisburg, Greenfield, Laporte, Forksville, Williamsport, Erie, Presque Isle, Northeast, Jeannette, Pittsburgh, Allegheny County (not common, by beating (Ham.)). July.

PARALLELOSTETHUS O. SCHWARZ.

8861—*attenuatus* Say. This large elaterid is widely distributed in Pennsylvania, and sometimes fairly common, especially in June to August. It is attracted to bait pails. Kirk ('22), noted the larvæ as common in rotten logs, feeding on decaying moist wood. Delaware Water Gap, Iron Hill, Montgomery County, Cornwells, Bustleton, Frankford, Angora, Castle Rock, Broomall, Hummelstown, Harrisburg, Linglestown, Clarks Valley, Camp Hill, South Fork, Cocolamus, Arendtsville, Charter Oak, State College, Perryopolis, Wilmerding, Jeannette, Pittsburgh.

NEOTRICHOPHORUS JACOB (CRIGMUS LEC.)

8866—*abruptus* Say. Fairly common, and widely distributed. June–Sept. Champlain and Knull, 1932, found them plentiful in baits at Clarks Valley and Laporte, and Frost found them in baits at Arendtsville. Delaware Water Gap, Kutztown, Philadelphia, Delaware County, Kennett Square, West Grove, Harrisburg, Linglestown, Camp Hill, Clarks Valley, State College, Laporte, Jeannette, Pittsburgh.

OXYGONUS LEC.

8875—*obesus* Say. Greentown, Lebanon, Chinchilla, State College, Ricketts, Laporte. Klages, 1901, said that this species is rare at Jeannette, but rather common at Indiana in June. May–July.

8876—*montanus* Schfr. Mt. Alto, Laporte. May–July. Records by Knull.

DALOPIUS ESCH.

8878—*lateralis* Esch. Frost collected this from baits at Arendtsville in June, and Champlain and Knull, 1932, found them plentiful in baits at Clarks Valley in May and June. They have also been recorded from mountain maple, blackberry, and tamarack. May–August. Cornwells (rhubarb flowers), East Park, Swarthmore, Hummelstown, Harrisburg, Inglenook, Pine Grove, Mt. Holly, Edenville, Charter Oak, North Mountain, Hartstown Bog, Presque Isle, Northeast, Jeannette, Pittsburgh.

—*pennsylvanicus* Brown. Type locality Pittsburgh: Brown, Can. Ent. March, 1934, p. 68. June.

—*cognatus* Brown. McConnellsburg, June.

SERICUS ESCH.

8881—*viridanus* Say. Delaware Water Gap, Montgomery County, Philadelphia, Germantown, Fernwood, Rockville, Inglenook, South Fork Camp, State College, Laporte, Barbours, Jeannette, Pittsburgh, Allegheny County (not rare, on spruce (Hamilton)). April to June. Also listed by Melsheimer, 1806, p. 963; LeConte, 1853, p. 454; Candeze, 1863, p. 427, and Leng, 1920.

8883—*silaceus* Say. Delaware Water Gap, Cresco, Edge Hill, Wissinoming, Bustleton, Castle Rock, Swarthmore, Glenolden, Lancaster County, Harrisburg, Inglenook, New Cumberland, Drumgold, Charter Oak, State College, Williamsport, Laporte, Middlebury Center, Cedar Run, Uniontown, Cove Mountain, Jeannette, Pittsburgh, Allegheny County (abundant on blossoms (Hamilton)). Clarks Valley, plentiful in baits in May and June, according to Champlain and Knull, 1932. May to July.

—*debilis* LeC. Castle Rock, in June, according to BPI records.

8884—*honestus* Rand. Forksville, Laporte, Jeannette. June.

AGRIOTES ESCH.

8885—*maneus* Say. An economic species, found all over the state, but most injurious to potatoes and other crops in the counties west and north of the mountains. April to July, chiefly in June. Hamilton said this species was rare in Allegheny County, but that the other species were common. Greentown, Bethlehem,

Harrisburg, Chinchilla, Concordville, Kennett Square, Cornwells, Chambersburg, Laporte, Clearfield County, Carbon County, Potter County, Tionesta, Union City, Erie, Edinboro, Corydon, Emlenton, Franklin, Cambridge Springs, Saegerstown, Mercer, Titusville, Volant, New Castle, Murraysville, Mt. Morris, Jeannette, Pittsburgh.

—*truncatus* Melsh. and *striatulus* Melsh. were described from Pa. in 1846, p. 217.

8886—*stabilis* LeC. Greentown, Cedar Run, Laporte, Jeannette, Pittsburgh. Klages, 1901, said it was not rare in Westmoreland County and about Pittsburgh. May to August.

8887—*insanus* Cand. Cornwells, on rhubarb flowers; Delaware County, Chambersburg, Jeannette, Allegheny County. May to July.

8888—*fucosus* LeC. Mt. Pocono, Laporte, Pa. (Horn collection). June.

8893—*pubescens* Melsh. Type locality Pa.: Melsheimer, 1846, p. 217. Cresco, Cornwells, Bustleton, (on rhubarb flowers), Frankford, Linglestown, McConnellsburg, Charter Oak, Laporte, Renovo, Hartstown Bog, Jeannette, Allegheny County. Clarks Valley, in baits. May to July. Also listed from Pa. by LeConte, 1853, 1884; Blatchley, 1910, and Leng, 1920.

8897—*oblongicollis* Melsh. Fairly common and widely distributed. Champlain and Knull, 1932, found them plentiful in baits in June at Clarks Valley. April to July. Delaware Water Gap, Bethlehem, Wyoming, Montgomery County, Parkland, Cornwells, Manayunk, Philadelphia, Roxboro, Overbrook, Media, Glenolden, Castle Rock, Conewago, Hummelstown, Harrisburg, Linglestown, Camp Hill, Pine Grove, State College, Jeannette, Pittsburgh, Allegheny County (Ham.), Natrona, New Brighton.

a-isabellinus Melsh. Type locality Pa.: Melsheimer, 1846, p. 218. Much less common than the above form. Hummelstown, Inglenook, Mt. Alto, State College, Jeannette, Pittsburgh. May–July. Also listed by LeConte, 1853, p. 456; Leng, 1920, and Brown, 1936, p. 250.

8900—*avulsus* LeC. Type locality Pa.: LeConte, 1853, p. 457. Jeannette, Pittsburgh. Klages, 1901, said it was not rare in Westmoreland County and about Pittsburgh. May, June. Also listed by Candeze, 1863, p. 363; Blatchley, 1910, and Leng, 1920.

AGRIOTELLA BROWN (BETARMON KIES.)

8904—*bigeminatus* Rand. May to July. Delaware Water Gap, Frankford, Linglestown, Penn-Mar, Barbours, Jeannette, Pittsburgh, Allegheny County (common on spruce in June (Hamilton)). Also listed from Pa. by LeConte, 1853, and Leng, 1920.

GLYPHONYX CAND.

8906—*recticollis* Say. April to Sept., chiefly in June and July. Bethlehem, Parkland, Manayunk, Glenolden, Lancaster, Landisburg, Hummelstown, Harrisburg, Linglestown, Lemoyne, Chambersburg, Pond Bank, Charter Oak, Charleroi, Jeannette, Allegheny County.

8907—*testaceus* Melsh. Type locality Pa.: Melsheimer, 1846, p. 219. Milford, Eberleys Mills, Arendtsville, Jeannette, Pittsburgh. Also listed from Pa. by LeConte, 1853; Hamilton, 1901, and Leng, 1920.

8910—*inquinatus* Say. May to July. Mt. Alto, Arendtsville (at baits), Hummelstown, Jeannette.

DRASTERIUS ESCH.

8922—*fretus* Csy. Type locality, near Philadelphia: Casey, II, 1886, p. 170. Also listed from Pa., by Schwarz, 1906, and Leng, 1920.

AMPEDUS GERM. (ELATER L.)

The larvæ of this genus feed in rotting wood and under the bark of dead trees. The adults are usually found on flowers or under bark.

8931—*cordifer* LeC. Although this is a western species, a specimen in the BPI collection is labelled North Mountain, Pa.

8932—*pullus* Germ. Champlain and Knull, 1932, collected this in baits at Laporte in late July and early August.

8934—*nigricollis* Hbst. A common and widely distributed species. Hibernates in logs and stumps in woodlands; found as adult throughout the year, but most active from April to late June. Bethlehem, Delaware Water Gap, Wyoming, Ashbourne, Norristown, Philadelphia, Bustleton, Frankford, Overbrook, Tincicum Id., Devon, Upper Darby, Broomall, Morton, Castle

Rock, Unionville, Avondale, Jennersville, Middletown, Hummelstown, Harrisburg, Inglenook, Clarks Valley, Williamsport, Mt. Alto, Hollidaysburg, Charter Oak, State College, Indiana, Uniontown, Nordmont, Cross Fork, Derrick City, Northeast, Jeannette, Pittsburgh.

8935—*luteus* Say. Adults collected in nearly every month; hibernates under bark and in rotten logs and stumps. Most active in April to July. Delaware Water Gap, Bethlehem, Greentown, Wyoming, Philadelphia, Grays Ferry, Germantown, Lester, Castle Rock, Broomall, Kennett Square, West Grove, Jennersville, Hummelstown, Harrisburg, New Cumberland, Linglestown, Mt. Alto, State College, Uniontown, Jeannette, Pittsburgh.

8936—*discoideus* Fab. (*sellatus* Dej.). Hibernates under bark and in dead logs. Most active in April to June. Adult in pupal cell in dead pine at Cold Springs, Aug. 16, according to Knull, 1932. Delaware Water Gap, Philadelphia, Frankford, Broomall, Hummelstown, Inglenook, Camp Hill, Hollidaysburg, State College, Uniontown, Latrobe, Pittsburgh.

8937—*vitiosus* LeC. Hibernates in logs and stumps; most active in May to July. Champlain and Knull, 1932, collected it in baits in July, at Laporte; Knull, 1932, found many adults in pupal cells in decayed beeches at Sweden Valley, Sept. 23. Kirk, 1922, found adults and larvæ with *A. sayi* LeC., in a hole in a living *Celtis occidentalis* on Nov. 12, near Harrisburg. Other collections: Greentown, Painter Den Pond, State College, Sweden Valley, Jeannette, Latrobe, Pittsburgh.

8938—*læsus* LeC. Hibernates as above species; active April to July. Hummelstown, Harrisburg, State College, Elk County, Uniontown, Jeannette, Pittsburgh.

8939—*sayi* LeC. Hibernates as above; most active late April to July. Wyoming, Philadelphia, Bustleton, Frankford, Roxboro, Chester Springs, Hummelstown, Harrisburg, Inglenook, Linglestown, Chambersburg, State College, Tionesta, Jeannette, Allegheny County (rare (Ham.)).

8940—*rubricollis* Hbst. Active April to July. Delaware Water Gap, Lehigh Gap, Bethlehem, Arcola, Philadelphia, Frankford, Swarthmore, Eagle, Rockville, Inglenook, Chambersburg, Charter Oak, State College, Jeannette, Pittsburgh, Allegheny County (common, according to Hamilton).

—*verticinus* Beauv. Active April to July, chiefly in June. Delaware Water Gap, Cresco, Germantown, Broomall, West Grove, Nottingham, Hummelstown, Inglenook, Clarks Valley (numerous in baits in July (Knull, '32)), Rockville, Goodyear, Carlisle Jct., Mt. Alto (common in pupal cells in winter in dead pitch pine (Knull, '32)), Charter Oak, State College, Pine Grove.

8941—*semicinctus* Rand. Hibernates as above species; active April to July. Greentown, Cresco, Broomall, Inglenook, Endeavor, Clarks Valley (numerous in baits in late July), Caledonia (in decayed Sycamore log), Cold Springs (adults in pupal cells in decayed hemlock stumps (Knull, '32)), Hollidaysburg, Cove Mt., Laporte (in baits in June and July (Champlain and Knull, 1932)), Hartstown Bog, Wilmerding, Jeannette.

8942—*militaris* Harris. Frankford, Castle Rock, West Grove, Westtown, Harrisburg, Jeannette, Pittsburgh. Hamilton listed this species from Allegheny County, but Klages (1901, p. 287) stated that this was wrongly determined in that list, and had not been found in Pittsburgh up to 1901.

8943—*rubricus* Say. Bethlehem, Cresco, Delaware Water Gap, Mt. Pocono, Kutztown, North Mt., Ardmore, Inglenook, Clarks Valley (plentiful in baits in June (Champlain and Knull, '32)), Endeavor, Cove Mt., Manada Gap, Hollidaysburg, Charter Oak, Northeast, Hartstown Bog, Jeannette, Pittsburgh, Allegheny County (not common (Hamilton)). Active May to July. Williamsport (LeConte, 1866, p. 347).

8948—*collaris* Say. Active May to August, chiefly June and July. Delaware Water Gap, Cresco, Edge Hill, Montgomery County, Philadelphia, Kennett Square, Hummelstown, Rockville, Clarks Valley, Drumgold, New Bloomfield, Mt. Alto, Carlisle Jct., Charter Oak, State College, Jeannette, Crafton, Pittsburgh, Allegheny County (not common (Ham.)).

8950—*sanguinipennis* Say. March to late June. Philadelphia Neck, Grays Ferry, Castle Rock, Horse Valley, Hartstown Bog.

8951—*xanthomus* Germ. Hibernates under pine and other bark. Active April to July. Many adults in pupal cells in winter under bark of dead *Pinus rigida* at Mt. Alto (Knull, 1932). Delaware Water Gap, Hummelstown, Linglestown, Mt. Alto, State College, Jeannette, Allegheny County (not common (Ham.)).

—*humeralis* Melsh. Type locality Pa.: Melsheimer, 1846, p. 159. Also listed from Pa. by LeConte, 1853, p. 471.

8953—*apicatus* Say.

a—*phænicopterus* Germ. Hamilton listed this from Allegheny County, and from St. Vincent, Westmoreland County. Van Dyke, however, said it was found in the Pacific and Northwestern states.

8955—*obliquus* Say. May to September; most active in June and July. Occasionally at lights and in baits; hibernates under bark. Bethlehem, Parkland, Philadelphia, Bustleton, Frankford, Roxboro, Broomall, Castle Rock, Hummelstown, Linglestown, Clarks Valley, Landisburg, Arendtsville, Jeannette, Pittsburgh.

a—*areaolatus* Say. May to August. Frost collected it in baits at Arendtsville. Ithan, Glenolden, Hummelstown, Landisburg, Clarks Valley, Arendtsville, Chambersburg, Laporte, Jeannette, Pittsburgh.

8956—*pusio* Germ. May to August. Hummelstown, Pond Bank, Charter Oak, Jeannette, Pittsburgh, Allegheny County (not rare, on *Ampelopsis* in May (Hamilton)).

—*luteolus* LeC. Specimen in the Lane collection labelled Germantown, July.

8959—*manipularis* Cand. Adults present throughout the year; active in May to August. Hibernates as above. Occasionally attracted to baits. Castle Rock, Upper Darby, Hummelstown, Harrisburg, Clarks Valley, Linglestown, State College, Jeannette, Pittsburgh.

8960—*pedalis* Germ. April to late July. Occasionally in baits. Has been collected in most sections of the state. Delaware Water Gap, Cresco, Edge Hill, Frankford, Roxboro, Tincum Id., Angora, Glenolden, Nottingham, Hummelstown, Clarks Valley, Dauphin, Hunters Run, Arcola, New Bloomfield, Carlisle Jet., Chambersburg, Charter Oak, State College, Laporte, Northeast, Hartstown Bog, Charleroi, Jeannette, Pittsburgh.

—*ursulus* Melsh. Type locality Pa.: Melsheimer, 1846, p. 213. Also listed by LeConte, 1853, and Leng, 1920.

—*deletus* LeC. Kirk collected this at Clarks Summit in rotten wood.

8964—*mixtus* Hbst. May to late July. Pocono Lake, Dela-

ware Water Gap, Hunters Run, Charter Oak, Laporte (numerous in baits in June (Champlain and Knoll, 1932)), North Mt., Jeannette, Pittsburgh, Latrobe and Allegheny County, common, according to Hamilton.

—*miniipennis* LeC. Quirsfeld listed this from Greentown, in June.

8965—*impolitus* Melsh. Type locality Pa.: Melsheimer, 1846, p. 180. June and July. Jeannette, Pittsburgh (Klages). Southwest Pa., common, by beating, according to Hamilton. Also listed from Pa. by LeConte, 1853, p. 467; Blatchley, 1910, p. 733, and Leng, 1920.

8966—*socer* LeC. Late April to late July. Delaware Water Gap, Cresco, Germantown, Marietta, Landisburg, Inglenook, Endeavor, Charter Oak, State College, Jeannette, Pittsburgh. Also listed from Pa. by Candeze, 1859, p. 441; LeConte, 1884, p. 10; Leng, 1920.

8968—*luctuosus* LeC. May to July. Laporte, specimen in the Knoll collection marked with a question mark; the Lane collection contains a specimen from Blue Ridge Summit; Jeannette. Allegheny County, not common (Ham.). LeConte, 1866, p. 347, listed this from Loyalsock Creek, 30 miles from Williamsport.

8969—*nigricans* Germ. May to July. Rockville, Inglenook, Clarks Valley (numerous in baits in July (Champlain and Knoll, '32)), Mt. Alto, State College, Laporte, Jeannette, Pittsburgh, Allegheny County (not rare (Ham.)).

—*fuscatus* Melsh. and *testaceipes* Melsh. Type locality Pa.: Melsheimer, 1846, p. 213. *Fuscatus* was also listed from Loyalsock Creek, near Williamsport, by LeConte, 1866, p. 347.

—*melanotoides* Brown. Allotype: State College, April 18, 1910; Brown, 1933, p. 134. In Canadian collection.

ECTAMENOGONUS BUYSS.

8971—*melsheimeri* Leng. Leng, 1918, p. 206. April to July. Adult hibernates. Delaware Water Gap, Philadelphia, Harrisburg, Rockville, State College, Jeannette, Pittsburgh.

—*hepaticus* Melsh. Type locality Pa.: Melsheimer, 1846, p. 160. Active April to July. Adult hibernates. Frankford, Hummelstown, Harrisburg, Mt. Alto, Chambersburg, Jeannette,

Allegheny County. Also listed from Pa. by LeConte, 1853, p. 467; Candeze, XIV, 1859, p. 442; Leng, 1920.

MEGAPENTHES KIES.

8980—*limbalis* Hbst. Widely distributed, fairly common, by beating. June to August. Wyoming, Delaware Gap, Bethlehem, Emaus, Philadelphia, Frankford, Broomall, Castle Rock, West Chester, Homeville, Downingtown, Rockville, Clarks Valley, Lotell, Brandtsville, Camp Hill, Cove Mt., Blue Mt., Jeannette, Pittsburgh, Allegheny County (not common (Ham.)).

—*granulosus* Melsh. Listed from Pa. by LeConte, 1884, p. 6.

8983—*rufilabris* Germ. Philadelphia, Mt. Alto (common in baits in July (Champlain and Knull, '32)), Jeannette, Pittsburgh.

DICREPIDIUS ESCH.

8993—*palmatus* Cand. The Horn collection contains one specimen labelled "S.W.Pa. or N.C." Hamilton noted this species as not common at St. Vincent, Latrobe, and in Allegheny County.

8994—*ramicornis* Beauv. The Wenzel collection contained one specimen labelled this, from Frankford.

ISCHIODONTUS CAND.

8996—*soleatus* Say. Specimens in the Lane collection from Pittsburgh, July and August.

ANCHASTUS LEC.

9009—*fuscus* LeC. Specimen in the Knull collection from Fort Hunter, just north of Harrisburg, in July.

9012—*digitatus* LeC. Type locality Pa.: LeConte, X, 1853, p. 459. Listed by Leng, 1920. No specimens in the collections which I examined.

MELANOTUS ESCH.

Adults hibernate in logs and stumps. Some species are commonly attracted to baits, others to lights. Several species are of economic importance.

9015—*castanipes* Payk. May to October, most active in June and July. Delaware Water Gap, Kutztown, Frankford, Fox

Chase, Roxboro, Clarks Valley, Cold Springs, State College, Jeannette, Pittsburgh.

—*inequalis* LeC. LeConte, 1866, p. 347, listed this from near Williamsport; Leng, 1920, also lists it from Pennsylvania.

—*scrobicollis* LeC. May to July. Philadelphia, Arnot, Endeavor, State College, Northeast, Jeannette, Pittsburgh.

9016—*corticinus* Say. Clarks Valley (in baits in mid-July (Champlain and Knull, 1932)), Inglenook, Perry County, Jeannette, Pittsburgh, Allegheny County (not abundant (Hamilton)). Melsheimer, 1806, p. 966, also lists this for Pa.

9019—*decumanus* Er. May to August. Philadelphia, Germantown, Fox Chase, Roxboro, Upper Darby, Lester, Glenolden, Toughkenamon, Jennersville, Clarks Valley, Linglestown, Harrisburg, Speeceville, Arendtsville (in baits), Jeannette, Pittsburgh.

—*cuneatus* LeC. Specimen in the Horn collection labelled Allegheny.

9020—*canadensis* Cand. June, July. Frankford, Fox Chase, Swarthmore, Hummelstown, Harrisburg.

9022—*clandestinus* Er. Specimen in the Lane collection labelled South Philadelphia, July.

9023—*secretus* LeC. Edge Hill. Specimens in the Horn and Cornell collections labelled Pa. July.

9024—*longicornis* Blatch. Specimen in Wenzel collection labelled this species, from Darby.

9025—*ignobilis* Melsh. Type locality Pa.: Melsheimer, 1846, p. 152. Specimen in Klages collection labelled Pittsburgh, June. Also listed from Pa. by LeConte, 1853, p. 475; Schwarz, 1906, p. 190; Blatchley, 1910, and Leng, 1920.

9026—*depressus* Melsh. Type locality Pa.: Melsheimer, 1846, p. 151. June, July. Frankford, York, Arendtsville (in baits), Jeannette, Charleroi, Pittsburgh. Also listed by Schwarz, 1906, and Leng, 1920.

9027—*prasinus* Blatch. Specimen in the Lane collection labelled Mt. Alto, May.

9028—*angustatus* Er. June. Landisburg (det. by Van Zwaluwenburg), Jeannette, Allegheny County (Hamilton). Also listed from Pa. by LeConte, 1853, p. 475, and Leng, 1920.

—*testaceus* Melsh. Type locality Pa.: Melsheimer, 1846, p. 151. No other records seen.

9029—*trapezoideus* LeC. May to July. Delaware Water Gap, Montgomery County, Germantown, Harrisburg, Lingsletown, Arendtsville, Jeannette, Pittsburgh.

9030—*tanicollis* LeC. Type locality Philadelphia: LeConte, 1853, p. 475. May to July. Frankford, Germantown, Broomall, Downingtown, Jennersville, Hummelstown.

9031—*leonardi* LeC. Type locality Pa.: LeConte, 1853, p. 475. June to August. Delaware Water Gap, Jeannette. Listed from Pa., by Leng.

9033—*glandicolor* Melsh. Type locality Pa.: Melsheimer, 1846, p. 152. June, July. Penfield, Laporte (in baits (Champlain and Knull, 1932)), Jeannette. Also listed from Pa. by LeConte, 1853, p. 477, by Leng, 1920, and by Lane.

9034—*divarcarinus* Blatch. May to September. South Langhorne, Nottingham, Jeannette, Pittsburgh.

9035—*communis* Gyll. This and the next species are our most common *Melanotus* species. They are attracted to lights and baits, and hibernate in large numbers in rotten logs and stumps in woodlands, under bark and codling moth bands. The larvæ are injurious to corn and potatoes, especially in the southern part of Pennsylvania, and usually not far from woodlands. Bethlehem, Edge Hill, Parkland, Norristown, Arcola, Philadelphia, Bustleton, Mt. Airy, Glenolden, Upper Darby, Castle Rock, Lester, Devon, Kennett Square, Avondale, West Grove, Jennersville, Greenfield, Hummelstown, Harrisburg, Speeceville, Clarks Valley, Landisburg, Pennsburg, Mt. Alto, Arendtsville, Altoona, Charter Oak, State College, Vosburg, Laporte, Northeast, Harts-town Bog, Jeannette, Pittsburgh. Most active in May to September. Pupates in July and early August.

9036—*fissilis* Say. Nearly as common as *communis*. Hibernates in the same places, and is also attracted to baits and lights. Most active in June to August. Bethlehem, Easton, Parkland, Arcola, Philadelphia, Roxboro, Bustleton, Cornwells, Grays Ferry, Glenolden, Castle Rock, Kennett Square, Jennersville, Hummelstown, Rockville, Clarks Valley, Arendtsville, Carlisle Jct., Charter Oak, State College, Laporte, Northeast, Jeannette, Pittsburgh, New Brighton.

orchraceipennis Melsh. Type locality Pa.: Melsheimer, 1846, p. 150.

sphenoidalis Melsh. Type locality Pa.: Melsheimer, 1846, p. 150.

9037—*exuberans* LeC. Delaware Water Gap. Hamilton said it was common in Allegheny County; the Horn collection contains a specimen from Allegheny. Leng, 1920, listed this species from New Mexico.

9040—*parumpunctatus* Melsh. Late April to late July. Delaware Water Gap, Cornwells, Philadelphia, Delaware County, Hummelstown, Harrisburg, Inglenook, Clarks Valley, Pine Grove, Monroe Valley, Mt. Alto, Charter Oak, State College, Jeannette, Charleroi, Pittsburgh, Allegheny County (common (Hamilton)). Also listed from Pa. by Schwarz, 1906, p. 190, and Leng, 1920.

9042—*verberans* LeC. June, July. Germantown, Angora, Delaware County, Linglestown, Jeannette, Pittsburgh, Allegheny County (common (Hamilton)).

9043—*emissus* LeC. Seven Mts., July 10 (Knull).

9044—*infaustus* LeC. Castle Rock, June (Wenzel).

9045—*cribulosus* LeC. Philadelphia, June (W.I.); Pa. (Geo. Greene).

9048—*pertinax* Say. June to August. Milford, Montgomery County, Frankford, Mt. Airy, Delaware County, Pond Bank, Jeannette, Pittsburgh, Allegheny County (not common (Hamilton)), Washington County.

9049—*dubius* LeC. Delaware Water Gap, Montgomery County, Frankford, Hummelstown, Allegheny.

9050—*tenax* Say. Castle Rock, April 16 (Daecke).

9051—*americanus* Hbst. Common and widely distributed. April to August, chiefly in June and July. Delaware Water Gap, Wyoming, Edge Hill, Parkland, Philadelphia, Bustleton, Angora, Mt. Airy, Lester, Glenolden, Castle Rock, Kennett Square, Jennersville, Downingtown, Lancaster County, Hummelstown, Harrisburg, Linglestown, Wabank, Foxburg, Landisburg, Jeannette, Pittsburgh, Allegheny County (common (Ham.)), Washington County.

9054—*gradatus* LeC. May to July. Hummelstown, Jeannette, Pittsburgh, Allegheny County (not common (Ham.)).

9059—*sagittarius* LeC. June, July. Montgomery County,

Darby, Hummelstown, Harrisburg, Inglenook, Landisburg, New Germantown, Heckton Mills, Pine Grove, Mt. Holly, Laporte (very plentiful in baits in July (Champlain and Knull, 1932)), Hartstown Bog, Indiana, Jeannette, Pittsburgh, Crafton, Allegheny County (common (Ham.)).

9063—*paradoxus* Melsh. Type locality Pa.: Melsheimer, 1846, p. 152. One specimen from Philadelphia, supposedly this, in the Cornell collection. Also listed from Pa. by LeConte, 1853, p. 480, and Leng, 1920.

—*cribulosus* LeC. Listed from Pa., by the Horn collection.

19626—*hyslopi* Van Z. April to September. Have been collected in Japanese Beetle baits. Champlain and Knull, 1932, found them very plentiful in baits at Clarks Valley in June and July. Upper Darby, Hummelstown, Landisburg, Dauphin, Inglenook, Cooksburg, Charter Oak, State College, Cornwall, Doltton, Jeannette.

CARDIOPHORUS ESCH.

9071—*cardisce* Say. June. Jeannette (Klages), Southwest Pa. (not rare (Ham.)). Also listed by Say, VI, 1839, p. 169.

9082—*convexus* Say. May to July. Parkland, Homeville, Inglenook, Dillsville, Erie, Jeannette, Pittsburgh, Southwest Pa. (in fields and hedges, common, according to Hamilton). Blanchard, 1889, p. 15, also listed this from Pennsylvania.

9087—*gagates* Er. Delaware Water Gap, Greentown, Philadelphia, Rockville, Linglestown, Herndon, Heckton Mills, Colemansville, Chambersburg, Caledonia, Charter Oak, Hartstown Bog, Jeannette, Pittsburgh, Allegheny County (not rare, by beating (Hamilton)).

9092—*convexus* LeC. May to October. Milford, Angora, Harrisburg, Charter Oak, Jeannette, Pittsburgh, Southwest Pa. (not rare (Hamilton)).

9098—*robustus* LeC. The Klages collection contained a specimen, presumably this, from Greenville, June 25. Blanchard, 1889, lists it from Pennsylvania.

9114—*curiatus* Say. May to August. Frequently on leaves of May apple. Wyoming, Philadelphia, Angora, Broomall, Glenolden, Lancaster County, Harrisburg, Linglestown, New Cumberland, Enola, Mt. Alto, Jeannette, Pittsburgh, Allegheny County (not rare (Hamilton)).

BIBLIOGRAPHY OF PENNSYLVANIA ELATERIDÆ

- BLANCHARD, F. 1889. Revision of *Cardiophorus*. Trans. Am. Ent. Soc., XVI, p. 7.
- . 1889. Entomologica Americana, V, pp. 139-140.
- BLAND, J. H. B. 1895. Ent. News, VI, p. 185.
- BLATCHLEY, W. S. 1910. Coleoptera of Indiana.
- BROWN, W. J. 1930. Revision of Eanus. Can. Ent., 62, pp. 161-166.
- . 1933a. Studies in the Elateridæ, I. Can. Ent., 65, pp. 133-134.
- . 1933b. Studies in the Elateridæ, II. Can. Ent., 65, pp. 176, 179.
- . 1934. The American species of *Dalopius* Esch. I. Can. Ent., 66, p. 36, 68.
- . 1935. *Ludius*: the *Aeripennis* group. Can. Ent., 67, p. 127.
- . 1936a. *Ludius*: the *Inflatus* group. Can. Ent., 68, p. 135.
- . 1936b. *Ludius*: the *Propola* group. Can. Ent., 68, p. 182.
- . 1936c. Notes on some species of Elateridæ. Can. Ent., 68, p. 249.
- CHAMPLAIN, A. B., AND H. B. KIRK. 1926. Bait pan insects. Ent. News, 37, p. 288.
- , AND J. N. KNULL. 1932. Fermenting baits for trapping Elateridæ and Cerambycidæ. Ent. News, 43, pp. 253-257.
- DURY, C. 1888. Elateridæ of Cincinnati. Ent. Amer., IV, p. 163.
- FALL, H. C. 1933. New Coleoptera. XVI. Can. Ent., 65, p. 229.
- FROST, S. W., AND H. DIETRICH. 1929. Coleoptera taken from bait traps. Annals Ent. Soc. America, 22, p. 247.
- HAMILTON, J. 1893. Descriptions of some new species of Coleoptera. Can. Ent., 25, p. 305.
- . 1895. Catalog of Coleoptera of Southwestern Pennsylvania. Trans. Amer. Ent. Soc., 22, pp. 317-381.
- HORN, G. H. 1871. Descriptions of new species of Elateridæ. Trans. Amer. Ent. Soc., 3, pp. 299-324.
- . 1891. Monograph of Cryptohypnus. Trans. Amer. Ent. Soc., 18, pp. 8, 12.
- KIRK, H. B. 1922. Biological notes on Elateridæ and Melasidæ. Ent. News, 33, pp. 236-240.
- KLAGES, H. 1901. Supplement to Hamilton's list of Pennsylvania Coleoptera. Annals Carnegie Museum, I, pp. 265-294.
- KNULL, J. N. 1932. Notes on Coleoptera, No. 3. Ent. News, 43, p. 43.
- LECONTE, J. L. 1853. Revision of the Elateridæ of the United States. Trans. Amer. Philos. Soc. (2), X, pp. 405-508.
- . 1866a. List of Coleoptera collected in Lycoming County, Pa. Proc. Acad. Nat. Sci., Phila., 18, p. 346.
- . 1866b. Additions to the coleopterus fauna of the U. S., No. 1. Proc. Acad. Nat. Sci., Phila., 18, pp. 361-394.
- . 1863. New species of North American Coleoptera. Pt. I. Smithsonian Misc. Collections, VI, No. 167, pp. 1-92.
- . 1884. Short studies of North American Coleoptera. Trans. Amer. Ent. Soc., 12, pp. 8-19.

- LENG, C. W. 1920. Catalog of Coleoptera of America North of Mexico. Pages 166-175: Elateridæ.
- . 1927. First supplement to above (1914-1924).
- . 1933. Second and third supplements (1925-1932), p. 27.
- . 1939. Fourth supplement (1933-1938), p. 39.
- . 1918. Jour. N. Y. Ent. Soc. 26, p. 206.
- LIEBECK, C. 1888, '89. Collecting notes. Ent. Amer., IV, p. 74.
- MELSHEIMER, F. V. 1806. Catalog of the insects of Pennsylvania. Separate publication, privately printed at Hanover, York County.
- MELSHEIMER, F. E. 1846. Descriptions of new species of Coleoptera of the United States. Proc. Acad. Nat. Sci., Phila., II, pp. 134-160.
- SAY, T. 1825. Ann. Nat. Hist. Lyceum of N. Y., I, pp. 249-268.
- . 1839. Descriptions of new North American insects. Trans. Amer. Philos. Soc., VI, pp. 155-170.
- VAN DYKE, E. C. 1932. Miscellaneous studies in the Elateridæ. Proc. California Acad. Sci., 4th Series, XX, No. 9, pp. 371, 400.

LYSANDRA CORMION, A NEW EUROPEAN BUTTERFLY

BY V. NABOKOV

This peculiar insect is best described in terms of relation to *Lysandra coridon* Poda and *Polyommatus meleager* Esp. Roughly speaking, it is more like the former above, and more like the latter below. Its expanse is that of a slightly under-sized *coridon*.

The upper side is a clear silky blue, comparable to the bluest varieties of *coridon* (and recalling yet another species, *Polyommatus eros* O.). Next to it *meleager* looks purplish and *coridon* silvery gray. The dark fuscous border of the primaries is broader than in *meleager*; less sharply defined than in *coridon*. The fringes belong to the double (*meleager*) type, with the inner line a pale fuscous on the fore wing, but unlike *meleager*'s they are slightly checkered. The secondaries while rounder than in *coridon*, and with a whiter abdominal fold, do not suggest *meleager*'s ample contour; they have their subcostal vein curved in the *coridon* manner, *i.e.*, more arched than it is in *meleager*, and display a submarginal row of conspicuous black dots (that are generally wedge-shaped in *coridon* and absent in *meleager*).

On the under side, as in *meleager*, the primaries lack the two basal spots found in *coridon*, but the first one of the submedian row seems advanced basally—a *coridon* feature. There is a *Lysandra*-like difference in tone between the wings; but the light tint of the primaries is of the *meleager* (whitish) shade, and this tint is merely deepened to a dunnish gray on the secondaries without any admixture of buff so frequently seen in *coridon*. All the ocelli are neatly accentuated, with their white rings especially distinct on the darker hind wing. This has a clear median streak (indiscernible in most males of *meleager* owing to the general bleached effect of the under side); the submarginal chevrons show no trace of orange, but are rather more strongly outlined than in *meleager*, and the base of the wing is dusted with metallic blue.

An examination of the genitalia reveals that the ædeagus of *cormion*, with its bulblike enlargement just before the tip, closely resembles that of *coridon* and has nothing to do with the elongated form and bottleneck terminal process seen in *meleager* and other *Polyommatus* species. In *cormion* this organ appears to be just a trifle thinner and its swelling rather less accentuated than is the case with *coridon*; but there can be no question of its forming any intermediate between *coridon* and *meleager*: it is quite unmistakably of the *Lysandra* type. On the other hand, the more perfectly rounded hump of the vinculum, the deeper notch beneath the terminal spur of the harpé and the irregular, less solid looking structure of the uncus seem to differ from the corresponding parts of *coridon* in a way approaching *meleager*.

The only two specimens known (holotype and paratype, both now in The American Museum of Natural History) are males and were taken by me on the 20th and 22nd of July, 1938, at an altitude of about 4,000 feet on the flowery slopes above Moulinet (Alpes Maritimes, France), a place seldom visited by collectors though famed since Fruhstorfer's time for some remarkable "*Lycæna*" races (and the type locality of his *escheri* var. *balestrei* and *amandus* var. *isias*). Both specimens were netted because they looked so different on the wing from the rest of the "blues" present, and during the next two days I saw two more (or a third one twice) which I missed, bungling being encouraged by a strong wind and the steepness of the ground. Suitable females were also looked for, but in vain; nor did a subsequent search through the rich material of the British Museum yield any additional examples.

Had not the bulk of my collection remained in a basement in Paris, I should have liked to compare *cormion* not only with *coridon*, but with my series of the very closely allied *rezniceki* Bart., the Riviera representative of a Spanish species. I feel a puzzle here. Apart from the link hinted at by *cormion*, there seems to exist a curious mimetic affinity between *meleager* and the "*coridon*" group, thus the pale under side of sturdy *albicans* H.S. bears a striking resemblance to that of *meleager*, especially when, as often happens in the former's case, the fulvous fillings are greatly reduced.

There is also the question of interbreeding. Some of the "blues" have been suspected of unconventional pairings, and in connection with *meleager* one may mention that Rebel described and figured (Verh. zool. bot. Ges. Wien, v. 70, *meledamon*) a *Polyommatus*-like *Agrodiætus* captured in 1919 in the vicinity of Vienna, which he assumed to be—with wholly unwarranted precision—a cross between *meleager* male and *damon* female. In the present case where *meleager* and *coridon* are examined it would be likewise poor science to suppose that *cormion*, not being a plausible mutation of either, ought to be the offspring of both. The powers responsible for the moulding of Mediterranean *Lycænidaë* seem to be in a state of hectic activity, issuing new forms by the hundred, some of which may be fixed and retained by the secret decrees of nature, others dismissed and lost the very next season. Whether *cormion* will have to be deemed the freakish outcome of such evolutionary gropings which fashioned a few specimens in the season of 1938, never to bring out that particular make again, or whether it will turn up here and there, to struggle for elbow room between *coridon* and *meleager*, somewhat in the way *thersites* does between *icarus* and *escheri*, is a matter for the future to settle. Personally I would have postponed describing this rarity were I ever likely to revisit its lovely haunts.

In conclusion, my thanks are due to Mr. W. P. Comstock of The American Museum of Natural History for so very kindly placing all available material at my disposal and dissecting for me the genitalia of the three insects involved.

SOME NEW SPECIES OF MALLOPHORA MACQUART (ASILIDÆ, DIPTERA)

BY C. H. CURRAN

AMERICAN MUSEUM OF NATURAL HISTORY

Descriptions of a number of species of *Mallophora* which have been on hand for some time are presented in this contribution, together with a key to the species represented in the Museum Collection. It is impossible to include a number of the described species since the descriptions lack sufficient detail to make suitable comparisons.

The genus *Mallophora* is readily recognized by the obtuse claws, short ovipositor of the female, the appendiculate marginal cell and the bulbous face, which is clearly divided into an upper and lower section, the lower section with long bristles, pile on both, the upper section with much shorter sparse hair. The genus divides naturally into two groups, one having the face shining while the other has it thickly pollinose. There are about a hundred species described from the Neotropical region but it is possible that some of the names apply to different sexes of the same species. In some species the sexes are similar in coloration but in others there is a striking difference in the color of the hair on the legs. On the whole the color of the pile on the body is the same in both sexes although the females are more inclined to have scattered yellow hair on the under side of the abdomen. The best characters for the separation of the species, other than general coloration, are to be found on the legs of the males, which are very frequently strikingly ornamented with white or yellow pile in distinctive patterns.

The following key includes the Neotropical species in the Museum Collection.

TABLE OF SPECIES

1. Scutellum black haired, at most a few pale hairs	29
Scutellum at least half yellow pilose	2
2. Abdomen wholly black haired	3
Abdomen usually with extensive yellow or reddish pile but sometimes only a lateral patch near the base, or with yellow pile beneath apically	4

3. Front with a band of pale yellowish pile; scutellum black pilose basally *breviventris* Macquart
 Front and scutellum with reddish yellow pile; large species. *speciosa* Curran
4. Mesonotum wholly black haired 5
 Mesonotum with yellowish pile, at least in front 6
5. Apex of abdomen broadly reddish pilose *bassleri*, n. sp.
 Apex of abdomen broadly black pilose *infernalis* Wiedemann
6. Legs wholly black haired *inca*, n. sp.
 Legs partly white or yellow pilose 7
7. Scutellum with thick bright tawny pile, the abdomen almost uniformly orange pilose; large robust species (over 20 mm.).
rufiventris Macquart
 Scutellum with thin reddish pile or yellow pilose, smaller and usually much more slender 8
8. Posterior tibiae with appressed sparse pile, if somewhat dense the scutellar pile white 14
 Posterior tibiae with dense erect pile, scutellar pile always yellow 9
9. Posterior tibiae wholly black haired above *ruficauda* Wiedemann
 Posterior tibiae pale pilose basally 10
10. Face with black bristles 11
 Face with wholly reddish yellow bristles and pile *campestris*, n. sp.
11. All of the abdominal segments tawny pilose dorsally *dana*, n. sp.
 Apical or preapical segments black pilose above 12
12. First segment of posterior tarsi with white hairs in ♂, in ♀ posterior tibiae white haired basally 13
 First segment of posterior tarsi wholly without white hairs, basal third of posterior tibiae of ♀ with pale yellow hair *antica* Curran
13. First segment of posterior tarsus of ♂ broadly white haired on whole length, apex of abdomen of ♀ with sparse yellow hairs.
sexualis Curran
 First segment with white hairs on apical half, apex of ♀ abdomen with scattered white hairs *ajax*, n. sp.
14. Scutellum with white hair *scopifer* Wiedemann
 Scutellum with yellowish pile 15
15. Males 16
 Females 23
16. Posterior tarsi with only black hair on the basal segment 17
 Posterior tarsi with some white or yellow hair on the first segment 20
17. Third to fifth segments of posterior tarsi each with an apical row of long black bristles preceded by a tuft of very long erect white hair *clavipes*, n. sp.
 Pile differently arranged 18
18. Hair on posterior tarsi becoming longer and very dense on the fifth segment 19
 Hair all short dorsally, the second to fourth segments with appressed white hair on the posterior half of the dorsal surface *zita*, n. sp.

19. Posterior trochanters with fine yellowish hair *abana* Curran
 Posterior trochanters with long fine black bristles *clavitarsis*, n. sp.
20. Posterior tarsi with white hair on the first segment 21
 Posterior tarsi with yellow hair on the first segment 22
21. Posterior tibiae with white hair above, black hair in front.
nigritarsis Fabricius
 Posterior tibiae with black hair above and silvery white hair in front.
callida Fabricius
22. Posterior tibiae yellow haired except at the apex *fusca* Bromley
 Posterior tibiae with sparse black hair in front on whole length.
neta, n. sp.
23. Posterior tarsi black except sometimes the last segment 25
 Posterior tarsi all reddish 24
24. Front tibiae with black hair anterodorsally; cheeks without black bristles *callida* Fabricius
 Front tibiae with yellow hair except below, the cheeks with a number of black bristles *abana* Curran
25. Posterior tibiae with only a few black hairs apically *neta*, n. sp.
 Posterior tibiae with the apex broadly black pilose on part of the surface 26
26. Posterior tibiae clavate apically and as large as the first tarsal segment *clavipes*, n. sp.
 Posterior tibiae not conspicuously swollen apically 27
27. First segment of the posterior tarsi more than twice as long as wide 28
 First segment of the posterior tarsi broad, much less than twice as long as wide *zita*, n. sp.
28. Apical abdominal segments practically all tawny haired above.
fusca Bromley
 Apical abdominal segments almost all black haired above.
nigritarsis Fabricius
29. Face wholly pollinose *ada*, n. sp.
 Face mostly shining 30
30. Abdomen with band of reddish or yellowish pile concealing the ground color or mostly pale pilose 31
 Abdomen wholly black haired or with only some scattered pale hairs apically on the under side or the apical segments with sparse appressed tawny pile 40
31. Large species, wings blackish basally, brown apically with a very broad pale band across the middle *tibialis* Macquart
 Generally smaller, the wings not fasciate 32
32. Legs wholly black pilose; wings blackish at the base.
 ♀ * *schwarzi* Curran
 Legs with white or yellow pile 33

* *M. pluto* Wiedemann has the legs wholly black pilose but the wing is not dark at the base.

33. Anterior tarsi with white pile above 34
 Anterior tarsi devoid of white hair 36
34. Anterior four tibiæ silvery white in front ♂ *robusta* Wiedemann
 Anterior tibiæ not silvery white though with some white hair 35
35. Anterior tibiæ black pilose except in front *aria*, n. sp.
 Anterior tibiæ golden yellow pilose dorsally and posteriorly.
rufipes Macquart
36. Wings yellowish brown, contrastingly black basally ♂ *schwarzi* Curran
 Wings almost uniformly colored 37
37. Occiput above, and the front with yellow pile 38
 Occiput above, and the front wholly black haired ♀ *robusta* Wiedemann
38. Pleura wholly black haired 39
 Pleura with considerable yellow pile *pipiens*, n. sp.
39. Middle femora wholly black haired *tolteca*, n. sp.
 Middle femora with white hairs in front *minos* Wiedemann
40. Wings dark brown with the apical fourth very pale brownish.
apicalis Bromley
 Wings almost unicolorous 41
41. An incomplete band of yellow pile on the front of the mesonotum.
flavicollis Bromley
 Mesonotum with at most a few scattered pale hairs in front 42
42. Abdomen with some appressed tawny hair above on the apical segments 49
 Abdomen without such hair 43
43. Posterior tibiæ wholly black haired 44
 Posterior tibiæ with white or yellow hair 46
44. Vertex yellow or white pilose 45
 Vertex with only black hair ♀ *lugubris* Arribalzaga
45. A large patch of white hair below the eyes; face castaneous; legs wholly black haired *vorax*, n. sp.
 A very small patch of pale yellowish hair below the eyes; face black; middle femora yellow haired posteriorly *lucida*, n. sp.
46. Anterior and middle tibiæ with dorsal stripe of dense silvery white pile *lugubris* Macquart
 Not so 47
47. The white pile on the posterior tibiæ is on the apical third of the ventral surface, a little at the base *curiosa*, n. sp.
 The white pile does not extend beyond the apical third of the tibiæ 48
48. The yellow beard extends to the palpi; anterior four tibiæ of male yellow pilose *contraria* Walker
 The yellow beard is confined to a small patch below the eyes; anterior legs wholly black pilose *jeminá*, n. sp.
49. Beard with white patch below the eyes *nitidula* Hermann
 Beard with yellow patch below the eyes *cora*, n. sp.

GROUP I

Face and front normally wide, the face shining, rarely in part thinly pollinose above. Robust species, rarely somewhat slender, usually with dense pile on the abdomen but the hair sometimes short and appressed on the disc. This is *Mallophora* in the strict sense.

Mallophora bassleri new species.

Robust, black pilose, the scutellum and apex of abdomen with dark reddish pile. Length, 20 mm.

FEMALE.—Head black pilose, a small patch beneath the eyes and another behind the eyes above, yellow; face shining black, the sides yellowish pollinose; lower part of face, front and occiput with brown pollen, the posterior orbits broadly cinereous pollinose. Antennæ black, the second segment brownish red, the arista mostly yellowish; third segment long and pointed. Palpi wholly black haired.

Thorax dull black, with thin brown pollen, toward each side of the mesonotum with a broad interrupted more cinereous stripe which merges into brown, the usual broad median vittæ brownish. The pile is wholly black or there are a few scattered yellow hairs on the anterior margin of the mesonotum. Scutellum with long tawny pile, the base more or less broadly black haired.

Legs dark castaneous, the knees, anterior four femora except the apex and the coxæ black, the tarsi more reddish; hair and bristles wholly black, the posterior tibiæ with long dense pile above and below.

Wings brown, paler posteriorly, with violaceous reflections. Squamæ and halteres brown.

Abdomen with thick bright tawny pile, the sides broadly black pilose basally, the genitalia shining black and with thin tawny hair.

TYPES.—Holotype, female and paratype, female, Teffe, Brazil, October, 1928 (H. Bassler).

This species is colored very similarly to *rufiventris* Macquart but does not have the palpi yellow haired and differs in other respects.

Mallophora inca new species.

Robust, mostly black pilose, the second abdominal segment with a band of yellow pile. Length, 20 mm.

FEMALE.—Head black, the facial orbits and occiput cinereous yellow pollinose, the lower part of the face and the front with brown pollen. Pile black, the posterior orbits rather broadly yellow pilose, the frontal pile mostly yellow, that on the upper part of the face and a few hairs on the upper part of the gibbosity yellow. Palpi black haired, the basal segment with mostly yellow, long dense hair. Antennæ black, the second segment

reddish, the arista reddish yellow; third segment long, pointed apically.

Thorax dull black with thin brownish pollen, only obscurely vittate. Pile black on the anterior border, extending to the middle medianly, the propleura, pteropleura and scutellum yellow.

Legs castaneous, the tarsi reddish; pile black, long and dense on the upper and lower surfaces of the posterior tibiæ and on the posterior surface of the front tibiæ; middle tibiæ with sparse appressed yellow hair on the posterior surface, the middle coxæ with yellow hair posteriorly.

Wings brownish, becoming dark brown basally, with violaceous reflection. Squamæ and halteres brown.

Abdomen with thick black pile, the second segment with a band of yellow pile extending over the sides, the pile on the venter more or less brownish; genitalia shining, with pale hairs apically.

HOLOTYPE.—Female, Rio Santiago, Peru, November 10, 1924 (H. Bassler).

Mallophora campestris new species.

Moderately slender, bristles pale except some on the femora. Length, 15 mm.

MALE.—Head brownish, the pollen whitish, reddish brown on the front; pile reddish yellow, yellow on the occiput, white on the proboscis. Face shining except on the sides. Palpi broadly reddish apically. Antennæ black, the second segment reddish, the third elongate and tapering to the apex, the arista a little longer than the third segment.

Thorax dull blackish, the pleura brown pollinose, the mesonotum with a pair of weak, broad, widely separated vittæ that are grayish in front of the suture and brown behind. Pile and bristles reddish yellow.

Legs reddish, reddish yellow pilose, posterior tibiæ except at the base above, the under surface of the posterior femora and the basal two or three segments of the posterior tarsi with black hair, the apical two segments white haired above, the pile long and erect on the hind tibiæ; femora with a few black bristles apically.

Wings with luteous tinge. Squamæ and halteres reddish.

Abdomen black, slightly metallic, with moderately thick tawny pile, the pile on the venter paler. Genitalia overlaid above with thick white hair.

TYPES.—Holotype, male, and paratype, male, Chapada, Brazil (Williston Collection).

Mallophora dana new species.

Moderately slender, mostly reddish pilose, the abdomen metallic above; beard white. Length, 15 to 16 mm.

MALE.—Head black, cinereous pollinose, the face bare except along the orbits and below; pile pale reddish, white on the lower half of the occiput, the face with a number of black bristles. Palpi broadly reddish apically, usually with a few black bristly hairs. Antennæ brown, the second segment

reddish, the third segment elongate, tapering, about as long as the arista.

Thorax black, brown pollinose, the mesonotum with a broad pale vitta anteriorly toward each side. Pile pale reddish, the mesopleura and sternopleura mostly black haired.

Legs reddish, the anterior four femora more or less broadly black basally on the anterior surface. Pile yellowish, black posteriorly on the femora, on the basal three segments of the posterior tarsi, on most of the posterior tibiae and on the broad apex of their femora; pile long and thick on the posterior femora, white dorsally on the basal fifth and on the apical two tarsal segments.

Wings with strong yellowish brown tinge. Squamæ and halteres brownish red.

Abdomen black, the third and following segments somewhat metallic, the pile moderately abundant, more dense basally and laterally, bright tawny, with some coarse black bristly hairs near the posterior border of the segments toward the sides, the shining black genitalia mostly overlaid with silvery white hair.

TYPES.—Holotype, male, Rio Maranon, Peru, November 1, 1924. Paratypes, four males, Iquitos, Peru, March, 1924, and one male, Achinameza, Peru, October 18, 1927. All were collected by Dr. Harvey Bassler.

***Mallophora ajax* new species.**

Scutellum and basal half of abdomen yellow pilose, all the segments of the posterior tarsi with white hair. Length, 18 mm.

MALE.—Head black, brown pollinose, the posterior orbits and sides of the face paler. Hair and bristles black but there is a narrow band of yellow pile behind the eyes which becomes almost white below, the fine hair is yellow on the upper half of the front, there is considerable yellow hair in the middle of the mystax below and the under surface of the palpi are yellow haired. Basal two antennal segments reddish, the third missing, the hair black, yellow on the upper half of the first segment.

Thorax dull blackish, with brown pollen, not distinctly vittate, the humeri and posterior calli brownish. Hair black, but there are some scattered yellow hairs on the anterior half, particularly inside the humeri. Scutellum wholly yellow pilose.

Legs dark reddish, black haired, the posterior tibiae with moderately long hair on the apical half above, with white hair on the basal half except ventrally, the white hair extending to the apical sixth on the posterior surface; posterior femora with white hair below on the apical third, the anterior four tibiae and tarsi with bright yellow hair except ventrally. The posterior tarsi are not broadened, blackish, with long erect white hair above on the second and third segments on the anterior two-thirds and some white hair on the first segment; the two apical segments are missing but undoubtedly bear long erect white hair as on the third segment.

Abdomen black, the basal three segments and genitalia with yellow pile, the under surface of the apical segments with some scattered yellow hairs; genitalia overlaid with silvery white pile. The black pilose apical segments are rather dull.

FEMALE.—The facial gibbosity is reddish brown and bears only a few yellow hairs, there is almost no yellow hair on the front and the yellow pile on the palpi is limited to little more than the basal half. Legs castaneous, black haired, the anterior tibiæ and tarsi with sparse yellow hair above, the posterior femora and tibiæ as in the male but with shorter hair. The genitalia and last sternite have yellowish white hair.

TYPES.—Holotype, male, and allotype, female, Brazil.

This species is close to *sexualis* but may be distinguished by the characters given in the key. The hair on the legs of the female is shorter and less abundant. It is impossible to identify *opposita* Walker and *ciliata* Walker, which may be the two sexes of the same species. One of these names may apply to the species I have described as *antica*, *sexualis* or *ajax*—but this can only be determined by examination of the types.

Mallophora aria new species.

Black, the abdomen thickly reddish pilose above; front tibiæ and tarsi with some white hair. Length, 20 mm.

MALE.—Head black, the front, cheeks and occiput brown pollinose, the sides of the face and posterior orbits with cinereous yellow pollen. Mystax yellow, with fine black bristles on the sides, the hair on the upper part of the face mixed black and yellow; front black haired, the vertex, a narrow band along the posterior orbits and the cheeks with yellow pile. Palpi castaneous, with yellow pile below and black above. Antennæ with the two basal segments reddish, with black hair, the third missing.

Thorax opaque black, with brown pollen laterally, on the pleura and on the scutellum, the hair wholly black; scutellum with a few isolated reddish hairs.

Legs blackish, the anterior four femora castaneous below, the posterior pair on more than the lower half and the upper half of the posterior tibiæ on about the basal half, reddish. Pile black on the front legs except for an entire broad anterior stripe of sparse appressed white hair on the tibiæ and appressed white hair on the anterior half of the upper surface of the tarsi; middle femora with sparse yellow hair posteriorly, their tibiæ with yellow hair on the basal half above and on the whole posterior surface; posterior femora with yellow hair ventrally and anteriorly, their tibiæ with yellow hair on the basal half and the whole posterior surface; posterior tarsi considerably broadened, the second to fourth segments with white pile above, the hair subappressed.

Wings pale yellowish brown. Squamæ with black fringe. Halteres brownish red.

Abdomen thickly reddish pilose above, reddish yellow pilose on the sides and venter but the immediate base black haired. Genitalia shining black, with yellow hair, the hair thick above on the base.

HOLOTYPE.—Male, Rio Santiago, Peru, November 12, 1928 (H. Bassler).

Mallophora pipiens new species.

Black, the abdomen thickly reddish yellow pilose; tarsi wholly black haired. Length, 18 mm.

MALE.—Head black, the cheeks and front brown pilose, the facial orbits and occiput with cinereous yellow pollen. Mystax yellow with black bristles laterally, the upper part of the front and the occiput yellow pilose. Palpi castaneous, yellow pilose, with some black bristles. Antennæ black, the arista reddish yellow, about as long as the third segment; hair black.

Thorax opaque black, the pleura and scutellum with some dark brown pollen, the hair black; mesopleura with two patches of yellow hair, the hypopleura almost all yellow pilose; scutellum with a few scattered yellow hairs.

Legs dark castaneous; anterior legs black haired, the femora with yellow hair behind; middle legs with rather sparse yellow hair, the dorsal surface black haired; posterior femora with moderately long yellow hair but with thick black hair on the apex except below; posterior tibiæ with dense hair above and below, black, yellow on the basal fourth, extending to the middle on the posterior surface. Posterior tarsi somewhat broadened, wholly black haired.

Wings brownish. Squamæ with black fringe. Knob of halteres brown.

Abdomen thickly reddish yellow above, becoming yellow on the venter and more tawny toward the apex, the first segment with black pile posteriorly on the sides. Genitalia short, shining black, with a few black bristles basally, the pile yellow.

HOLOTYPE.—Male, Surinam, January 23, 1939 (D. C. Geijskes).

Mallophora tolteca new species.

Robust, black, the abdomen with pale orange pile. Length, 19 mm.

MALE.—Head black, facial orbits, cheeks and occiput densely cinereous pollinose, the front yellowish brown; facial gibbosity reddish; mystax yellow with black bristles laterally, the hair on the upper part of the face almost all black. Front with black hair in front and yellow hair behind; occiput black haired, with an orbital band of yellow pile which becomes white below, the pale beard extending to the oral margin. Palpi castaneous, wholly black haired. Antennæ with the first segment castaneous, the others missing.

Thorax dull black, the pleura with brown pollen; hair wholly black. Scutellum reddish brown, wholly black haired.

Legs castaneous, black haired; anterior surface of the posterior femora and lower surface of the posterior tibiæ on the basal third with pale yellow pile. Hair of the posterior tibiæ long and dense. Posterior tarsi not broadened, the first segment with long hair.

Wings light brownish. Squamæ with black fringe. Knob of halteres brownish.

Abdomen with the first and second segments black haired, the apex of the second and basal half of the third with yellow pile, the remainder of the abdomen orange pilose. Genitalia wholly yellow haired. Venter black pilose on basal half.

HOLOTYPE.—Male, British Honduras, October, 1928.

Mallophora vorax new species.

Robust, black, the abdomen shining; pile almost wholly black. Length, 16 mm.

MALE.—Face brownish red, its narrow orbits and the posterior orbits cinereous pollinose, the latter black pilose except close to the eyes, where the pile is very pale yellow, the beard pure white. Mystax composed of black bristles with a few white ones in the middle, the hair on the face whitish; front with yellow hair. Palpi reddish, black haired, the apical segment with white hair on the broad base. Antennæ with the first segment reddish, the second brown, the third missing.

Thorax dull black, the humeri and posterior calli brownish red, the pleura brown pollinose; pile wholly black; scutellum thickly brown pollinose. There is a little brown pollen on the mesonotum but it does not form a conspicuous pattern.

Legs shining brownish red, wholly black haired; the hair long and dense on the upper surface of the posterior tibiæ.

Wings yellowish brown, paler apically and posteriorly. Knob of halteres brown.

Abdomen shining black, thinly haired above, the broad sides and the apices of the second to fifth segments with brown pollen, the venter with reddish brown pollen. Hair black, a few yellow hairs on the genitalia.

HOLOTYPE.—Male, Lima, Peru, April 30.

Mallophora lucida new species.

Robust, black, almost wholly black haired. Length, 24 mm.

FEMALE.—Head black; the pollen brown; hair black, the front and the very narrow posterior orbits yellow pilose, the beard black with a very small pale yellow patch below the eyes; mystax with just a few yellow bristles and some yellow hairs. Palpi castaneous. Antennæ black, the third segment long and tapering, twice as long as the reddish arista.

Thorax dull black, wholly black haired, the pleura and scutellum with dark brown pollen.

Legs castaneous, the tarsi more reddish; hair black, dense on the posterior tibiæ, yellow on the posterior surface of the anterior four femora.

Wings brown with violaceous reflections. Knob of halteres brownish red.

Abdomen dull black, the broad sides and venter with brown pollen; hair black; genitalia shining black, with mostly yellow hair.

HOLOTYPE.—Female, Posadas, Argentina.

Mallophora curiosa new species.

Black, beard yellow, posterior tibiæ with white pile on apical half of ventral surface. Length, 20 mm.

MALE.—Head black, with brown pollen; hair black and yellow, middle of mystax with black bristly hairs intermixed. Palpi reddish, yellow pilose, with black bristles on apical third; proboscis with black hair below. Antennæ brown, the third segment missing.

Thorax dull black, the pleura and scutellum brown pollinose. Hair black, the disc of the mesonotum with considerable reddish brown hair intermixed with the black.

Legs castaneous, the femora darker, hair black, the posterior tibiæ with long white pile on the apical half of the ventral surface and sometimes with a little yellow hair at the base; posterior femora with yellow hair on the apex, extending to the apical fourth on the under surface; tip of middle femora and anterior and posterior surfaces of the middle tibiæ on the basal half with yellow hair; posterior tarsi with long white hair on the anterior half or more of the apical four segments and on the anteroventral surface of the first segment; pile long and dense on the posterior tibiæ.

Wings light brownish. Halteres brownish red.

Abdomen shining black, the narrow sides and venter with brownish pollen; hair black, the venter sometimes with a few scattered yellow hairs. Genitalia shining black, with a few yellow hairs at the base of the upper surface.

TYPES.—Holotype, male, and paratype, male, Nova Teutonia, Brazil, January 28, 1939, and February 6, 1939 (F. Plaumann).

Mallophora jemima new species.

Robust, dull black, with very little pale pile. Length, 19 mm.

MALE.—Head black, with brown pollen, the narrow facial and posterior orbits more yellowish; hair black, a very narrow band of yellow pile behind the eyes ending in a small whitish patch below the eyes, the fine hairs of the mystax and some scattered hairs on the face and front yellow. Palpi and antennæ black, the first antennal segment with yellow hair below, the third missing.

Thorax opaque black, the pleura and scutellum with dark brown pollen, the hair wholly black.

Legs dark castaneous, black haired; posterior femora with a large patch of white hair anteriorly beyond the middle, their tibiæ with white hair beneath on the basal two-thirds; the pile long and dense on the hind tibiæ.

Wings brown, with strong violaceous reflections. Halteres reddish and brown.

Abdomen dull black, a little shining apically, the hair black, yellow on the upper surface of the genitalia but there is no dense brush of hair.

HOLOTYPE.—Male, Sao Paulo, Brazil (E. Lefevre), received from Count A. A. Barbiellini.

Mallophora cora new species.

Black, with black and brownish red hair; rather slender species. Length, 15 to 16 mm.

FEMALE.—Head black, cinereous pollinose, brown on the front and cheeks, the face shining. Hair and bristles wholly black except very narrowly yellow along the posterior orbits, the beard black. Palpi reddish on the apical half, black basally, with some yellow hair basally. Antennæ black, the second segment reddish, the arista brown, longer than the third segment.

Thorax black, brown pollinose, with a pair of broad short brownish yellow vittæ on the dorsum extending from near the front margin to behind the middle. Hair wholly black.

Legs castaneous or brownish red, the tarsi more reddish, the anterior four femora mostly blackish or shining dark brown. Hair black, dense on the upper surface of the posterior tibiæ; yellow on the coxæ and trochanters.

Wings brown, more yellowish brown on the apical third or more. Halteres reddish, sometimes with the knobs brown.

Abdomen shining black, somewhat metallic, the sides and venter with brown pollen. Hair thin, black, appressed dorsally, tawny on the disc of the apical tergites and genitalia, and on the apical sternites and sometimes mostly tawny on the sides of the first segment.

TYPES.—Holotype, female, and paratypes, seven females, Chapada, Brazil (Williston Collection).

In one of the specimens there are about a dozen yellow bristly hairs in the lower part of the mystax.

This species is close to *nitidula* Hermann but has less tawny pile on the abdomen and the males of the two species may be quite different. In the male of *nitidula* the sides of the abdomen are tawny pilose.

GROUP II

Rather slender species, never robust, the face always wholly pollinose, the ground color almost all concealed or visible only in certain views, the face and front generally narrow, rarely as broad as in typical forms. Pile thin, never concealing the ground color, always appressed on the dorsum of the abdomen.

This group closely approaches *Promachina* Bromley, differing in the shape of the ovipositor, which here is quite as in the typical *Mallophora*. One of the species, *clavipes*, has the male genitalia elongate as in *Promachina*. It seems impossible to separate *Pro-*

machina and the present group except on the character of the ovipositor. The width of the face and front, a character I have previously used, is of little value. Possibly the species included here would be better placed in *Promachina*. At any rate they form a natural link between this genus and the typical *Mallophora*.

In addition to the species described in the following pages, *nigritarsis* Fabricius, *abana* Curran, *callida* Fabricius and *fusca* Bromley belong in this group.

Mallophora clavipes new species.

Rather slender species, the mesonotum with cinereous pollen, the posterior tibiæ conspicuously swollen apically. Length, 19 to 20 mm.

MALE.—Head black, yellowish pollinose, the posterior orbits more cinereous; pile tawny, yellowish on the lower occiput and beneath the eyes, black on the front, and there are black bristles along the sides of the mystax and on the cheeks; gibbosity reddish in ground color. Antennæ black, the second segment reddish basally, the third about half as long as the arista.

Thorax black, with cinereous pollen, not vittate, the mesopleura light brownish; pile tawny, black on the mesonotum except in front; scutellum with black bristles and tawny hair.

Legs reddish yellow, the posterior tarsi and the apical fourth of their tibiæ black; anterior four femora with broad, black anterodorsal stripe. Pile tawny, black anteriorly and ventrally on the anterior four femora, anteriorly and apically on the posterior tibiæ and on the posterior tarsi. Apical four segments of the posterior tarsi with long erect black bristles apically preceded by a tuft of long white hairs, the basal segment with a pair of long black bristles apically; posterior tibiæ very conspicuously swollen at the apex.

Wings light yellowish brown, darker along the costa. Squamæ with tawny fringe. Halteres reddish.

Abdomen dull black, the sides and venter cinereous yellow pollinose, the pile reddish yellow, black on the disc of the sixth and following segments and mostly black on the shining black genitalia.

FEMALE.—Pile generally somewhat paler; palpi with mixed tawny and black hair. Posterior tibiæ less swollen apically; all the tarsi with black hair. Third and following abdominal segments with triangles of black hair on the disc.

TYPES.—Holotype, male, and allotype, female, Chapada, Brazil (Williston Collection).

Both sexes are readily identified by the clavate tibiæ. The male genitalia are elongate and somewhat clavate.

Mallophora zita new species.

Slender, the pollen brownish yellow; posterior tarsi broadened and with appressed hair. Length, 19 to 21 mm.

MALE.—Head black, the face mostly yellowish; pollen dense, reddish yellow, more cinereous on the posterior orbits; pile reddish yellow, bristles on the cheeks, along the sides of the mystax and on the front black; pile of the occiput becoming whitish below. Palpi with a few black bristles. Antennæ brown, the second segment reddish and with a few black hairs above; third segment obtuse apically, a little more than half as long as the arista.

Thorax with brownish yellow pollen, obscurely vittate, the hair bright yellowish, sparse and black on the posterior half of the disc of the mesonotum; usually no black hairs on the cinereous pollinose scutellum.

Legs pale reddish, with thin bright yellowish pile, the anterior four femora ventrally, the posterior pair apically, the posterior tibiæ anteriorly and on the apical fourth except below, and the posterior tarsi black haired; posterior tarsi greatly broadened, with appressed hair, the second to fifth segments each with a patch of white hair on the posterior half. Anterior four femora with broad anterior shining black stripe.

Wings yellowish brown. Squamæ reddish, with yellow fringe. Knob of halteres black.

Abdomen dull black, the sides yellowish brown pollinose, the venter cinereous. Pile short, black, yellow on the sides, basal two segments, venter and under side of genitalia, the latter overlaid by silvery white pile.

FEMALE.—The tarsi are wholly black haired and the black hair on the posterior tibiæ may be greatly reduced on the basal two-thirds; third abdominal segment mostly yellow pilose. The genitalia without black hair.

TYPES.—Holotype, male, and allotype, female, Achinamiza, Peru, February 18, 1927. Paratype, Rio Santiago, Peru, March 20, 1927. All were collected by Dr. Harvey Bassler.

Mallophora clavitarsis new species.

Slender, with yellowish brown pollen, the mesonotum vittate; posterior tarsi with hair becoming longer and dense apically. Length, 17 mm.

MALE.—Head with yellowish brown pollen, the occiput cinereous white; face mostly reddish in ground color, with black hair and bristles, some pale yellow pile in the lower part of the mystax. Front with black hair, the occiput with yellow pile above which becomes whitish below. Palpi castaneous, with yellow hair basally and coarse black hair on the apical half. Antennæ with the basal segment reddish and with black hair, the others missing.

Thorax with brown pollen, the mesonotum with three more yellowish dorsal vittæ and the sides pale, the pleura more grayish posteriorly. Hair black, yellow on the scutellum, anterior border of the mesonotum and mostly yellow on the posterior half of the pleura. Scutellum with cinereous yellow pollen.

Legs reddish yellow, the posterior tarsi black, their tibiæ darkened apically, the anterior four femora with broad shining black stripe anterodorsally.

Pile reddish yellow, black on the posterior tarsi, anteriorly and ventrally on the anterior four femora and on the anterodorsal surface and apex of the posterior tibiæ; posterior femora with long fine black bristles on the basal half. Posterior tarsi moderately broad, with dense moderately long black hair on the anterior half of the apical three segments and each with a small median tuft of white hair.

Wings light brownish, darker anteriorly, with violaceous reflection. Fringe of the squamæ black and yellow. Halteres reddish.

Abdomen dull black, with yellow pile, the disc of the fifth to seventh segments with appressed black hair, the venter with scattered black hairs intermixed with the yellow. Sides of the abdomen narrowly brown pollinose basally, the venter with obscure brownish pollen. Genitalia short, shining black, the hair mostly yellow, the upper surface with black hair on the basal half.

HOLOTYPE.—Male, Rio de Janeiro, Brazil, November (Williston Collection). The ornamentation of the tarsi is characteristic of this species.

Mallophora neta new species.

Slender, brownish yellow pollinose, the mesonotum distinctly vittate; posterior tarsi of the male with a broad stripe of brassy yellow pile. Length, 14 to 17 mm.

MALE.—Head black, the lower half of the face reddish; pollen cinereous on the occiput, reddish yellow on the face and front; pile tawny, yellow on the lower part of the occiput; sides of the mystax and cheeks with black bristles. Antennæ black, the second segment reddish basally, the third moderately long, two-thirds as long as the arista; hair black, the outer side of the first segment with tawny hair.

Thorax with brownish yellow pollen and with three broad, dark vittæ dorsally, the pleura more brownish above and grayish behind. Pile reddish yellow, mostly black and coarse on about half of the disc of the mesonotum. Scutellar pile all pale.

Legs orange, the posterior tarsi and very broad stripes on the anterior four femora black. Pile tawny, black on the anterior and ventral surfaces of the anterior four femora, on the anterodorsal surface of the posterior tibiæ and on the broad sides of the posterior tarsi. Posterior tarsi broad, with a very broad stripe of brassy yellow pile extending from the base to apex on the anterior half.

Wings pale brownish. Squamæ with yellow fringe. Knob of halteres brown.

Abdomen dull black, pale yellow pilose, the pile becoming tawny apically, particularly on the disc; sides obscurely yellowish brown pollinose, the venter with grayish pollen and yellow pile. Genitalia shining black, with a few black bristles above, overlaid on the basal half with white appressed hair.

FEMALE.—The posterior tibiæ may entirely lack black hair and the posterior tarsi are wholly black haired.

TYPES.—Holotype, male, and allotype, female, Rio Santiago, Peru, November 25 and 20, 1924. Paratypes: female, Rio Santiago, Peru, November 11, 1924, three females, Iquitos, Peru, 1923 and March 15, 1924; male and female, Middle Rio Ucayali, Peru, September 23, 1924. All collected by Dr. Harvey Bassler.

Mallophora ada new species.

Slender, with brownish pollen, the mesonotum weakly vittate. Length, 15 to 20 mm.

MALE.—Face mostly reddish in ground color; pollen yellowish, more cinereous on the occiput, brown on the front. Pile yellowish, the beard paler; mystax yellow, bordered with black bristles; front black haired, the upper part of the face with mostly black hair; a row of black bristles on the upper half of the occiput well back from the eyes. Palpi black, with yellow bristles below and black above. Antennæ blackish, the second segment mostly reddish, the hair black; third segment two-thirds as long as the arista.

Thorax black, brown pollinose, the pollen becoming more grayish on the lower part of the pleura, on the mesonotum more reddish brown, with three broad darker vittæ. Hair black, yellow on the lower half of the pleura.

Legs reddish yellow, the tarsi reddish; posterior tarsi (except the fifth segment) very broad, complete dorsal stripes on the anterior four tibiæ and the apex of the posterior tibiæ blackish, the posterior femora darkened above for about half their length. Femora with black hair, the anterior pair with some tawny hair posteriorly; tibiæ with bright reddish yellow pile, the middle and hind pair mostly black haired anteriorly; posterior tarsi with the fourth and fifth segments with long white hair above, the second and third with white hair on the anterior half, the basal segments otherwise black-haired; middle tarsi mostly black haired but most of the dorsal bristles are tawny.

Wings pale yellowish brown. Squamæ with black fringe. Halteres reddish, sometimes with brownish knob.

Abdomen dull black, the sides brown pollinose; pile black above, sparse, bright yellow on the sides and venter which is cinereous yellow pollinose. Genitalia shining black, with black hair, the basal half overlaid above with dense white hair.

FEMALE.—Posterior tarsi without white hair; abdominal pile shorter; genitalia with black hair only.

TYPES.—Holotype, male, allotype, female, and paratypes, five males and one female, Rio de Janeiro, Brazil (Williston Collection).

ADDITIONS TO NEW JERSEY STATE LIST
OF COLEOPTERA

BY BORYS MALKIN

This list contains ninety-eight species of beetles which heretofore, have not been recorded from the state of New Jersey. The species presented are only such as have come to my attention and no attempt has been made to compile a complete list of additions which have been recorded elsewhere from the state. However I have gone through all available literature to avoid, as far as possible, any repetitions of records. The New Jersey List is much in need of revision, therefore bringing together all additions, corrections, etc., would mean a work several times the size of this paper.

Each locality record is followed by the collector's name in italics. If no such a name appears it may be assumed that the author was the collector. The names of the taxonomists are presented by abbreviations in parentheses as follows: C. A. Frost—(CAF), H. B. Leech—(HBL), R. E. Blackwelder—(REB), J. W. Green—(JWG), C. T. Parsons—(CTP), F. W. Nunenmacher—(FWN), F. T. Scott—(F'TS), O. L. Cartwright—(OLC), L. Lacey—(LL), B. E. White—(BEW), L. L. Buchanan—(LLB), and B. Malkin—(M).

Carabidæ

892. *Tachyta inornata* (Say). Denville, July, (M).
895. *Tachyta debicollis* Csy. Newfoundland, Sept., (M),
Butler, Sept., (M), Colesville, Sept., (M), English-
town, Oct., (M).
18672. *Tachyta parvicornis* Notm. Lakehurst, August, (M).
1398. *Amara familiata* Duft. Manasquan Beach, June, *Funaro*
(CAF).
19092. *Harpalus indigens* Csy. N. J., *Schaeffer* (CAF).

Haliplidæ

2303. *Halplus leopardus* Rbts. L. Lackawanna Stanhope,
July, *Siepmann* (M).
2319. *Halplus blanchardi* Rbts. Colonia, August, *Siepmann*
(M).

2332. *Peltodytes pedunculatus* Blatch. Rahway, April, *Siepmann* (M), Colonia, August, *Siepmann* (M).
 2333. *Peltodytes 6-maculatus* Rbts. Rahway, April, *Siepmann* (M).
 2335. *Peltodytes lengi* Rbts. Rahway, April, *Siepmann* (M), Morristown, August (M).
 2328. *Peltodytes muticus* Lec. Aseh Swamp, Union Co., May, *Siepmann* (M), Cuschetunk, May, *Siepmann* (M), Rah-River, May, *Siepmann* (M), Avenel, May, *Siepmann* (M).

Dytiscidæ

2442. *Hydroporus shermani* Fall. Colonia, August, *Siepmann* (HBL).
 2448. *Hydroporus oppositus* Say. Croton, Wickecheoke Creek, May, *Siepmann* (HBL).
 2548. *Agabus semivittatus* (Lec.). Chadwicks, June, *Siepmann* (M).

Gyrinidæ

19250. *Gyrinus latilimbus* Fall. Rahway, July, *Siepmann* (M), Lackawanna Stanhope, July, *Siepmann* (M).

Hydrophilidæ

2874. *Cercyon quisquilius* (L.). Avenel, *Siepmann* (M), Morristown, August, (M), Colesville, (M).
 2880. *Cercyon indistinctus* Horn. Morristown, August, (M).
 2896. *Pemelus costatus* (Lec.). Avenel, July, *Siepmann* (CAF).
 2900. *Cryptopleurum americanum* Horn. Morristown, August, (M), Colesville, Sept., (M).

Staphylinidæ

3387. *Omalius rivulare* (Payk). Colonia, *Siepmann* (CAF).
 3379. *Omalius humerosum* Fauv. Englishtown, Nov., (CAF).
 3426. *Acidota quadrata* Zett. Manasquan Beach, June, C. W. de Funaro (REB).
 3905. *Gastrolobium atriceps* Csy. Lincoln Park, August, *Funaro* (CAF).

4022. *Tetartopeus angularis* (Lec.). Lincoln Park, July, *Funaro* (CAF').
4084. *Lathrobiella ambigua* (Lec.). Colonia, *Siepmann* (CAF').
19349. *Philonthus tetragonocephalus* Notm. Morristown, August, (CAF), Colesville, September, (CAF), Englishtown, November, (CAF').
4595. *Quedius peregrinus* (Grav.). Mountain Lakes, June, (CAF'), Colonia, *Siepmann* (CAF').
4633. *Oxyporus stygicus* Say. Newfoundland, September, (M).
4635. *Oxyporus fasciatus* Horn. Englishtown, June, *Ragot* (M), Colesville, Sept., (M).
4729. *Boletobius obsoletus* (Say). Manasquan Beach, June, *Funaro* (M).

Histeridæ

6827. *Saprinus lugens* Er. Ocean Co., July, *A. Herschkowitz* (M).

Lampyridæ

- 6975a. *Lucidota corrusca* var. *autuminalis* (Melsh). Ocean Co., June-July, *Herschkowitz* (M), Butler, Sept., (M).

Cantharidæ

- 7058b. *Podabrus basillaris* var. *punctulatus* Lec. Phillipsburg, June, *Green* (JWG), Avenel, *Siepmann* (JWG).
20859. *Podabrus appendiculatus* Fall. Lincoln Park, *Funaro* (JWG).
20883. *Podabrus brevicollis* Fall. Ocean Co., June, *Herschkowitz* (JWG).
7094. *Cantharis tantillus* Lec. Montclair, June, *Funaro* (JWG).
7119. *Cantharis impressus* Lec. Mountain Lakes, June, (JWG), Lake Hopateong, June, (JWG).
- *Cantharis cartwrighti* Green. Lake Hopateong, June, (JWG).

Melyridæ

7215. *Collops vittatus* (Say). Barnegat Bay-Isld., Bch., June, *Siepmann* (CAF').

7238. *Malachius aeneus* L. Ocean Co., June, *Herschkowitz* (M).
 ——— *Anthocomus* Sp.?. Manasquan Beach, June, *Funaro* (M & CAF).
 7281. *Pseudoebaeus pusillus* (Say). Mountain Lakes, June, (CAF), Lakehurst, August, (CAF).
 7304. *Attalus pallifrons* (Mots.). Denville, July, (M).

Cleridæ

7642. *Hydnocera subfasciata* (Lec.). Ocean Co., *Schaeffer* (M).

Mordellidæ

7830. *Glipodes helva* Lec. Dumont, May, *Ragot* (M).
 7867. *Mordellistena amica* Lec. Millburn, July, *Schott* (M).
 7872. *Mordellistena grammica* Lec. Wanaque, July, (M).
 7889. *Mordellistena convicta* Lec. Mountain Lakes, June, (M).
 7915. *Mordellistena pityptera* Lec. Mountain Lakes, June, (M).

Elateridæ

8562. *Adelocera avita* (Say). Lakehurst, August, (M & CAF).
 8727. *Ludius fulvipes* (Bland.). Alpine, April, *Funaro* (M).

Buprestidæ

9399. *Agrilaxia flavimana* (Gory.). Wanaque, July, (M).
 9517. *Agrilus defectus* Lec. Manasquan Beach, June, *Funaro* (CAF).
 21040. *Agrilus olivaceoniger* Fischer. Mountain Lakes, June, (CAF).

Nitidulidæ

10061. *Carpophilus nitens* Fall. Lakehurst, April, (CTP).
 ——— *Nitidula carnaria* Schall. Manasquan Beach, July, (CTP).
 ——— *Nitidula flavomacula* Rossi. Manasquan Beach, July, (CTP).

Erotylidæ

- 10292a. *Acropteroxys gracilis* var. *inornata* Rand. Lake Hopatcong, June, (M).

10332. *Triplax macra* Lec. Manasquan Beach, June, *Funaro* (CAF).

Cryptophagidæ

10422. *Caenoscelis ferruginea* Sahlb. Rahway, April, *Siepmann* (CAF & M).

Coccinellidæ

19743. *Hyperaspis separata* Csy. Lake Hopatcong, June, (FWN).
11010. *Scymnus semiruber* Horn. Palisades, May, June, (FTS), Upper Montclair, August, (M).
11015. *Scymnus rubricauda* Csy. Lincoln Park, November, (FWN).
11026. *Scymnus kinzeli* Csy. Milltown, June (Amer. Mus. Coll. *J. A. Grossbeck*), (FWN).
11202a. *Anatis 15-punctata* var. *mali* (Say). Manasquan, June, *Funaro* (M).

Tenebrionidæ

12408. *Alobates barbata* (Knoch). Lakewood, May, *L. Weiss* (M).
12412. *Idiobates castaneus* (Knoch). Lakehurst, June, *Angell* (CAF).
12423. *Boros unicolor* Say. Manasquan Beach, June, *Funaro* (M).

Scarabæidæ

13198. *Aphodius rubripennis* Horn. Montclair, May, *Funaro* (OLC).
—— *Ataenius falli* Hinton. Manasquan Beach, June, *Funaro* (OLC).
19956½. *Serica parallela* Csy. Manasquan Beach, *Funaro* (OLC).
—— *Serica blatchlei* Dawson. Dumont, May, *Ragot* (OLC).
—— *Serica* sp.? Manasquan Beach, June, *Funaro* (OLC).
13497. *Phyllophaga futilis* Lec. Lakehurst, 1926. Coll. unknown (OLC).
13512. *Phyllophaga ulkei* Sm. Cranberry, June, July, *Angell* (OLC).
13523. *Phyllophaga forsteri* Burm. Englishtown, April, *Ragot* (OLC).

13652. *Dichelonyx diluta* Fall. Passaic, May, *Funaro* (OLC).
 13731. *Anomala nigropicta* Csy. Freehold, July, *Ragot* (OLC).
 13803. *Ochrosidia villosa* (Burm.). Englishtown, August, *Ragot* (OLC).

Cerambycidae

14210. *Hypermallus abruptus* Csy. Manasquan, June, *Funaro* (M).
 14308. *Hapalosalia vibex* (Newn.). Lincoln Park, July, *Funaro* (LL).
 14520. *Anoplodera chrysocoma* Kby. Manasquan Beach, June, *Funaro* (M).
 15148b. *Oberea bimaculata* var. *affinis* Harris. Mountain Lakes, June, (LL).

Chrysomelidæ

15539. *Triachus vacuus* Lec. Morristown, August, (BEW).
 15495d. *Cryptocephalus venustus* var. *simplex* Hald. Barkeley Hghts., *E. A. Bishoff* (M).
 15676. *Calligrapha multipunctata* (Say). Montclair, *Bishoff* (M).
 20196. *Galerucella spiræ* Fall. Lincoln Park, July, *Funaro* (CAF).
 16152b. *Chirida guttata* var. *pennsylvanica* Sp. Boonton, July, *Schaeffer?* (M).

Curculionidæ

24450. *Calomycterus setarius* Roelf. Palisades, May, *Funaro*, (M), Great Notch, August, (M).
 16738. *Sitona tibialis* Hrbst. Palisades, June, (M).
 ——— *Sitona cylindricollis* Fahr. Morristown, August, (CAF), Palisades, June, (M).
 16794. *Listronotus impressifrons* Lec. Manasquan, June, *Funaro* (M).
 16804. *Hyperodes cryptops* (Dietz). Lincoln Park, July, *Funaro* (M).
 16846. *Pissodes approximatus* Hopk. Manasquan, June, *Funaro* (M).

16947. *Smicronyx tessellatus* Dietz. Mountain Lakes, June,
(CAF), Morristown, August, (CAF).
—— *Anthonomus* near *decepiens* Lec. Palisades, June,
(LLB).
—— *Ceutorrhynchus erysimi* Fab. Manasquan Beach, June,
Funaro (LLB).
17901. *Rhyssematus æqualis* Horn. Manasquan Beach, June,
Funaro (LLB), Lake Hopatcong, June, (M).

PROCEEDINGS OF THE NEW YORK ENTOMOLOGICAL SOCIETY

MEETING OF OCTOBER 1, 1940

President Klots in the chair with thirty members and visitors present.

The following were proposed for membership: Messrs. John C. Pallister, 2501 Knapp Street, Yacht Marion the II, Brooklyn, N. Y.; F. Courtney Stone, 1349 Lexington Ave., New York City; Leonard J. Sanford, American Museum of Natural History, New York City; David M. Bigelow, 1701 East Speedway, Tucson, Arizona.

Dr. Ruckes announced with regret the death on July 2 of Edward P. Van Duzee, foremost hemipterist in the country.

Members reported on their summer collecting experiences. Dr. Melander said that from June 5 until Sept. 10, he and Mrs. Melander travelled to the Pacific States and covered over 10,000 miles, collected 4,000 Diptera, 3000 feet of film (Kodachrome) and 1000 still pictures.

Mr. Kisliuk revealed the fact that great changes are taking place in world trade. Strange insects are being found in hosts that the Division of Foreign Plant Quarantine never had occasion to inspect before. Material from Spain, South America, Portugal and the Mediterranean is constantly bringing new pests to light.

Mr. Davis exhibited some of the 17-year locusts caught in 1923 and their progeny in 1940. He noted some of the new records in Long Island of Brood XIV.

Mr. Teale showed some of the pictures he made of the various stages of emergence of the 17-year locust this year on Long Island.

Mr. Bird urged that entomologists make an effort to make the public conscious of the good insects do rather than to have them considered as pests to be destroyed whenever the opportunity arises.

Dr. Hartzell spent some of the summer in the Black Hills of South Dakota where the grasshopper situation is very severe. He noticed that corn grown by the Indians on the reservation was not apparently attacked to the same extent as white man's corn. The grasshoppers are so numerous that education is being carried on as to where they lay their eggs, which is usually about 300 feet from the cornfields in a grass plot. While he was there the county carried on a grasshopper egg pod contest. Some 70 pounds of eggs were brought in, which means an estimated 15 million eggs.

LUCY W. CLAUSEN, *Secretary*.

MEETING OF OCTOBER 15, 1940

President Klots in the chair with thirty-eight members and visitors present.

The following were elected to membership: Messrs. John C. Pallister, F. Courtney Stone, Leonard J. Sanford and David M. Bigelow.

Mr. Louis Roth, 351 E. 45th Street, Brooklyn was proposed for membership.

Mr. Comstock explained that the American Museum of Natural History Entomological Department has a fine exhibition, in the Foyer, of a recent acquisition of a *Morpho* collection.

Dr. Spieth announced that membership cards could be obtained from the Secretary at the next meeting.

Dr. Davis exhibited some Florida species of cicadas collected recently by Dr. Ruckes.

The speaker of the evening, Dr. A. B. Klots, then addressed the members on "Problems of Arctic Alpine Distribution." Dr. Klots' talk was illustrated with movies and lantern slides.

LUCY W. CLAUSEN, *Secretary*.

MEETING OF NOVEMBER 19, 1940

President Klots in the chair with fifty-five members and visitors present.

An invitation to send a delegate to the ceremonies to dedicate a new Natural Resources Building on the campus of University of Illinois at Urbana, Illinois on November 15 was received.

Mr. Louis Roth was elected to membership.

The following were proposed for membership: Dr. Walter Schiller, Director of Laboratories, Cook County Hospital, Chicago, Illinois, and Mr. Malvin Hoffman, 2721 Morris Ave., New York City.

The speaker of the evening, Dr. James Forbes of Fordham University, was introduced and spoke on "Some Observations on the Carpenter Ant." Dr. Forbes illustrated his talk with stained whole mounts and diagrammatic drawings. An Abstract of Dr. Forbes' talk follows.

LUCY W. CLAUSEN, *Secretary*.

OBSERVATIONS ON THE INTERNAL ANATOMY OF THE CARPENTER ANT

1. The first part of the digestive system consists of the buccal tube, the infrabuccal chamber, the pharynx with the post-pharyngeal glands, the oesophagus, and the crop. Histologically this region is composed of a flattened type of epithelium externally covered by longitudinal and circular muscle and internally covered by a chitinous intima. The intima bears hair-like processes and spines in some regions, and in the crop it is thrown into crypt-like folds. The post-pharyngeal glands are structurally similar to the digestive tube but do not possess any muscle coats.

2. The proventriculus or gizzard is divided into three regions: the calyx, the bulb, and the cylindrical section. In this organ the intima, epithelium, and muscle coats are very much modified in the different regions. It is similar in shape and structure to other closely related Camponotinae.

3. The ventriculus is a large elliptical-shaped sac which occupies about one-half the space in the gaster. It is lined with regenerative and secretory cells.

4. The intestine is structurally similar to the first part of the digestive tract, but it lacks the longitudinal muscle fibers.

5. The number of Malpighian tubules varies from 18-21, but the majority of workers have 20.

6. The rectum is a large sac with thin, transparent walls, which bear six rectal pads. The anus has a well developed sphincter muscle.

7. Each cell of the maxillary glands has a very fine cell-duct which unites with a larger collecting-duct. The main-ducts open, one on each side, into the posterior part of the buccal tube.

8. The collecting-ducts of the salivary glands lead into large reservoirs before uniting to form the main-duct which opens into a salivarium between the hypopharynx and the labium.

9. The poison apparatus is of the pulvinate form which is confined to the Camponotinae.

10. The ovarioles of the non-functional ovaries vary in number from 1-3 in each ovary, and they are of the polytrophic type. No seminal receptacle was found in any of the workers dissected.

11. The heart occupies the usual position in the gaster, and it has five pairs of ostia. The heart wall is one cell in thickness, and paired nuclei lie along the lateral edges of the tube. The aorta lies above the oesophagus in the petiole. In the metathoracic region it lies on the right of the oesophagus, and then passes under the oesophagus in the mesothorax. In the prothorax it again comes up on the dorsal side of the oesophagus to open into the head.

12. The ventral nerve cord has three ganglia in the thorax, one in the petiole, and three in the gaster. The terminal ganglion of the gaster is a fusion of three ganglia.

13. Ten pairs of spiracles open on the sides of the body. In the first segment of the gaster the longitudinal tracheal trunks dilate to form tracheal sacs. The branches to the viscera arise in groups on the longitudinal trunk opposite the entrance of the stigmatic trunk.—JAMES FORBES.

MEETING OF DECEMBER 3, 1940

President Klots in the chair with forty-eight members and visitors present.

The following were elected to membership: Dr. Walter Schiller and Mr. Malvin Hoffman.

The Society noted with extreme regret the death on November 9 of Dr. Grace A. Sandhouse. Dr. Sandhouse was in charge of Hymenoptera at the National Museum and devoted herself to the study of Halictidæ.

Mr. Schwarz reported also the death of Dr. Otto Plath, Professor at Boston University, who was a student of bumble bees.

The speaker of the evening, Dr. Stanley Bromley, of the Bartlett Tree Research Laboratories, spoke on "Insects in Relation to the Shade Trees." Dr. Bromley's talk was illustrated with Kodachrome slides showing the insects about which he spoke and the damage peculiar to each.

LUCY W. CLAUSEN, *Secretary*.

MEETING OF DECEMBER 17, 1940

President Klots in the chair with fifty-three members and visitors present.

Dr. Klots appointed the following to serve on the Nominating Committee: Dr. H. Ruckes, Dr. Wm. Moore and Mr. E. Bell.

Dr. Spieth then reviewed and discussed the recent advances in the chemistry and biology of the insect exoskeleton.

LUCY W. CLAUSEN, *Secretary*.

MEETING OF JANUARY 7, 1941

The annual meeting of the New York Entomological Society was held on

January 7, 1941, in the American Museum of Natural History; President Klots in the chair with fifty-three members and visitors present.

The following officers were elected for the year 1941:

President	Max Kisliuk
Vice-President	Harry B. Weiss
Secretary	Miss Annette L. Bacon
Treasurer	Dr. H. T. Spieth
Librarian	L. James Sanford
Curator	Dr. W. J. Gertsch
Executive Committee	
William T. Davis	Harry B. Weiss
Dr. William Procter	E. L. Bell
Dr. Albert Hartzell	Herbert F. Schwarz
F. A. Soraci	Edwin W. Teale
Dr. A. B. Klots	
Publication Committee	

Delegate to the N. Y. Academy of Sciences
William T. Davis

Mrs. Sherman reported on the progress that Mr. John D. Sherman was making after recovering from a serious operation. A motion was made and carried that the Society send their best wishes for a speedy recovery to Mr. Sherman.

Mr. Robert Fuller then showed color movie film on insects and other animals.

LUCY W. CLAUSEN, *Secretary*.

MEETING OF JANUARY 21, 1941

President Kisliuk in the chair, thirty members and visitors present.

President Kisliuk appointed the following committees:

Program: Mr. J. W. Angell, Mr. M. H. Sartor, Dr. H. Hagan.

Auditing: Dr. Wm. Moore, Dr. W. J. Gertsch, Mr. F. S. Blanton.

Field: Mr. A. S. Nicolay, Dr. A. B. Klots, Mr. Wm. P. Comstock.

The Society heard with regret of the serious illness of Mr. Charles W. Leng and instructed the secretary to send an expression of sympathy.

President Kisliuk mentioned the large number of entomological papers presented at the Philadelphia meetings of the A. A. A. S.

A review of Mr. Teale's book, "The Golden Throng," was called to the attention of those present.

Mr. George Rau presented a paper on "Biological Studies of Mealy Bug Parasites."

ANNETTE L. BACON, *Secretary*.

MEETING OF FEBRUARY 4, 1941

President Kisliuk in the chair, thirty members and visitors present.

Mr. George C. Becker was proposed for membership in the Society.

The death of Mr. Charles Leng was deeply felt by members of the Society. He had been a member since 1902 and had served as Vice-President for four years, President for five and secretary for nineteen. Several members spoke of the work he had done, emphasizing his personality and recalling his active interest in many fields. Dr. Ruckes moved that Mr. Schwarz be appointed a committee of one to write a letter to the family of Mr. Leng expressing the sincere sympathy of the Society.

President Kisliuk reported the death of Dr. Charles W. Stiles in Baltimore on January 24.

Dr. Ruckes told of finding among the Pentatomidæ a number of specimens having one antenna with four, rather than five, segments—the abnormal one showing symmetrical compensation in that it approximated the length of the normal one and in that the pigment and sensory hairs covered the same proportional area of the distad segments. He requested that anyone finding similar abnormalities in other orders report such cases to him.

Mr. Gaul spoke interestingly on the "Biology of the Vespinæ" and illustrated his talk with lantern slides. He discussed a new technique of housing hornet nests in hives in the laboratory. The correlation of biological phenomena with the taxonomic divisions was stressed. The life of the individual and of the colony was discussed as were inquilines and some parasites.

ANNETTE L. BACON, *Secretary*.

MEETING OF FEBRUARY 18, 1941

President Kisliuk in the chair, thirty-five members and visitors present.

Mr. George C. Becker, Senior Entomologist, Inspection House, Hoboken, New Jersey, was elected to membership.

A discussion of the request for the exchange of the Journal by the Biological Laboratory of the Science Society of China resulted in the following motion:—The Society will exchange with the Biological Laboratory of the Science Society of China beginning with the March, 1941, issue of the Journal; and that any further application for exchanges shall be brought before the Society as a whole before action is taken.

It was suggested that in a future issue of the Journal, such as the fiftieth anniversary issue, photographs of past presidents of the Society be published. Mr. Teale was appointed a committee on one, with power to act, to get as many photographs as possible of the past presidents.

In the absence of Mr. Weed, the scheduled speaker, Mr. Fred Snyder spoke on "Recent Developments in Pyrethrum, Rotenone and Related Substances."

ANNETTE L. BACON, *Secretary*.

MEETING OF MARCH 4, 1941

Former President Klots in the chair, one hundred and thirty-five members and visitors present.

The reading of the minutes of the previous meeting and all business were postponed.

Dr. A. L. Melander showed his colored motion pictures of the western trip he took last summer.

ANNETTE L. BACON, *Secretary*.

MEETING OF MARCH 18, 1941

Vice-President Weiss in the chair, thirty members and visitors present.

Dr. George W. Barber, Mr. Mont A. Cazier, Dr. Minnie B. Scotland, Dr. Vincent B. Dethier and Prof. C. A. Thomas were proposed for membership.

The Society heard with regret of the death of Miss Louise Joutel, a former member, and also of the death of Dr. Hugo Kahl of the Carnegie Museum, Pittsburgh.

Dr. Roger B. Friend, State Entomologist of Connecticut, spoke on "Some Economic Insect Problems in Connecticut" and illustrated his talk with lantern slides.

There was an exhibit of 342 specimens representing 242 species of lepidopterous larvæ prepared by Mr. Charles Rummel of Green Village, New Jersey.

ANNETTE L. BACON, *Secretary*.

MEETING OF APRIL 1, 1941

Vice-President Weiss in the chair, forty members and visitors present.

Mr. Donald P. Connola was proposed for membership.

Five new members were elected: Dr. George W. Barber, U.S.D.A., New Haven, Conn.; Mr. Mont A. Cazier, American Museum of Natural History; Dr. Vincent G. Dethier, John Carroll University, Cleveland, Ohio; Dr. Minnie B. Scotland, N. Y. State College for Teachers, Albany, N. Y.; and Prof. C. A. Thomas, Kennett Square, Pa.

Dr. D. L. Collins of the Boyce Thompson Institute spoke on "The Dutch Elm Disease in New York State with reference to some of its Entomological Aspects" illustrating his talk with lantern slides and motion pictures.

ANNETTE L. BACON, *Secretary*.

MEETING OF APRIL 15, 1941

President Kisliuk in the chair, thirty members and visitors present.

Mr. Donald P. Connola, Boyce Thompson Institute, Yonkers, New York, was elected to membership.

Mr. James A. Rehn of the Academy of Natural Sciences of Philadelphia presented a paper on "Entomological Prehistory, or the Interpretation of some Problems in the Distribution of New World Orthoptera," an abstract of which is appended.

ANNETTE L. BACON, *Secretary*.

ENTOMOLOGICAL PREHISTORY

The importance of the Bering Sea land-bridge and those at Panama and at the Isthmus of Tehuantepec in molding the Orthopteran life of North America, and in the cases of the two last mentioned that of South America as well, was emphasized by the speaker. Numerous instances were given of

Holarctic types which intrusively have extended their range over either the eastern or western parts of North America, aside from those of broad boreal distribution on the latter continent. Cases of discontinuous North American distribution of several of these of Palearctic relationship and origin were considered due to Pleistocene glacial conditions having eliminated them in the intermediate territory. As much as three definite Palearctice incursions were recognized among the Nearctic members of the group *Chrysochraontes*.

The discontinuous distribution of certain grassland genera common to North America, Mexico and the south-central part of South America, and their absence from the territory between, was considered to be due to the spread of these genera during a Pliocene period of more extensive grassland, and by the wiping out of much of the latter during the cooler and more humid Pleistocene, with its forest predominance; they were extirpated in much of Central America and northern South America, thus producing their present discontinuous ranges.

Evidence in the Orthoptera for a Central American-Antillean land bridge was reviewed, and this postulate considered the only explanation of numerous orthopteran distributions which cannot readily be explained by drift, currents, rafts or hurricanes, on account of the character, habits and environmental preferences of the genera concerned.—JAMES A. G. REHN.

MEETING OF MAY 6, 1941

President Kisliuk in the chair, thirty-five members and visitors present.

The motion that the Treasurer may transfer funds from the savings account to the checking account at his own discretion was approved.

Mr. F. A. Soraci of the New Jersey Department of Agriculture, spoke on "The Behavior of Insects to Light of Various Wave-lengths."

ANNETTE L. BACON, *Secretary*.

MEETING OF MAY 20, 1941

Thirty-five members and visitors present.

Since this was a social meeting, no business was transacted.

Plans for the picnic of the Society on Sunday, June 8, at the home of Mr. and Mrs. Chris Olsen in West Nyack, New York, were announced.

Mr. Mont A. Cazier spoke about Entomology and Entomologists in California.

ANNETTE L. BACON, *Secretary*.

The New York Entomological Society

Organized June 29, 1892—Incorporated June 7, 1893

Certificate of Incorporation expires June 7, 1943

The meetings of the Society are held on the first and third Tuesday of each month (except June, July, August and September) at 8 P. M., in the AMERICAN MUSEUM OF NATURAL HISTORY, 77th Street and Columbus Avenue.

Annual dues for Active Members, \$3.00; including subscription to the Journal, \$4.50.

Members of the Society will please remit their annual dues, payable in January, to the treasurer.

Honorary President, WILLIAM T. DAVIS

Officers for the Year 1941

President, MAX KISLIUK..... Federal Bldg., New York, N. Y.

Vice-President, HARRY B. WEISS..... Highland Park, N. J.

Secretary, ANNETTE L. BACON..... American Museum of Natural History

Treasurer, DR. HERMAN T. SPIETH..... College of the City of New York, N. Y.

Librarian, L. JAMES SANFORD..... American Museum of Natural History

Curator, DR. WILLIS J. GERTSCH..... American Museum of Natural History

EXECUTIVE COMMITTEE

W. T. DAVIS

DR. ALBERT HARTZELL

DR. WM. PROCTER

DR. A. B. KLOTS

FRANK A. SOBACI

PUBLICATION COMMITTEE

HARRY B. WEISS

EDWIN W. TEALE

HERBERT F. SCHWARZ

E. L. BELL

PROGRAM COMMITTEE

J. W. ANGELL

M. H. SARTOR

HAROLD HAGAN

AUDITING COMMITTEE

DR. WM. MOORE

DR. W. J. GERTSCH

F. S. BLANTON

FIELD COMMITTEE

DR. A. B. KLOTS

A. S. NICOLAY

WM. P. COMSTOCK

DELEGATE TO THE N. Y. ACADEMY OF SCIENCES

WILLIAM T. DAVIS

JOURNAL

of the

NEW YORK ENTOMOLOGICAL SOCIETY

Published quarterly by the Society at N. Queen St., and McGovern Ave., Lancaster, Pa. All communications relating to manuscript for the Journal should be sent to the Editor, Harry B. Weiss, 19 N. 7th Ave., Highland Park, New Jersey; all subscriptions to the Treasurer, Dr. Herman T. Spieth, American Museum of Natural History, New York, N. Y. Orders for back issues should be sent to the Librarian, L. James Sanford, American Museum of Natural History, 77th St. and Columbus Ave., New York, N. Y. The society has a complete file of back issues in stock. The Society will not be responsible for lost Journals if not notified immediately of change of address. We do not exchange publications.

Terms for subscription, \$3.00 per year, strictly in advance.

Please make all checks, money-orders, or drafts payable to New York Entomological Society.

Twenty-five reprints without covers are furnished free to authors. Additional copies may be purchased at the following rates:

	4 pp.	8 pp.	12 pp.	16 pp.	24 pp.	32 pp.
25 copies	\$2.40	\$5.22	\$5.58	\$5.58	\$9.00	\$9.60
Additional 100's60	1.44	1.92	1.92	3.00	3.00
Covers	50 copies, \$2.00; additional 100's, \$1.50.					

Half-tone prints 1½ cents for each half-tone print.

Authors whose papers are illustrated with text figures or full page plates will be required to supply the electroplates or pay the cost of making the same by the Journal and also to pay the cost of printing full page plates on coated paper, when advisable.

DECEMBER, 1941

Journal

of the

New York Entomological Society

Devoted to Entomology in General



Edited by HARRY B. WEISS

Publication Committee

HARRY B. WEISS
HERBERT F. SCHWARZ

EDWIN W. TEALE
E. L. BELL

Subscription \$3.00 per Year

Published Quarterly by the Society
N. QUEEN ST. AND MCGOVERN AVE.
LANCASTER, PA.
NEW YORK, N. Y.

CONTENTS

Anaea of the Antilles and Their Continental Relationships with Descriptions of New Species, Subspecies and Forms (Lepidoptera, Rhopalocera, Nymphalidæ). BY FRANK JOHNSON AND WILLIAM PHILLIPS COMSTOCK	301
Records and Descriptions of Neotropical Crane-Flies (Tipulidæ, Diptera), XIII. BY CHARLES P. ALEXANDER	345
Ability of the Firebrat to Damage Fabrics and Paper. BY JEAN AUSTIN AND C. H. RICHARDSON	357
Book Notice	366
Experiments on the Taste Sensitivity of Dolichovespula Arenaria Fab. (Hymenoptera, Vespidae). BY ALBRO T. GAUL	367
The Synonymy of Papilio Coridon Poda, Papilio Phocion Fabricius and Others. BY E. L. BELL AND W. P. COMSTOCK	371
NOTICE: VOLUME XLIX, NUMBER 3, OF THE JOURNAL OF THE NEW YORK ENTOMOLOGICAL SOCIETY WAS PUBLISHED ON AUGUST 27, 1941.	

Entered as second class matter July 7, 1925, at the post office at Lancaster, Pa.,
under the Act of August 24, 1912.
Acceptance for mailing at special rate of postage provided for in Section 1103,
Act of October 3, 1917, authorized March 27, 1924.

JOURNAL

OF THE

New York Entomological Society

VOL. XLIX

DECEMBER, 1941

No. 4

ANAEA OF THE ANTILLES AND THEIR CONTINENTAL RELATIONSHIPS WITH DESCRIPTIONS OF NEW SPECIES, SUBSPECIES AND FORMS (LEPIDOPTERA, RHOPALOCERA, NYMPHALIDÆ)

BY FRANK JOHNSON AND WILLIAM PHILLIPS COMSTOCK

Distributed from the region of the Mississippi basin in North America, throughout the Antilles, Mexico, Central America and South America to 25 degrees south of the equator, the Neotropical genus *Anaea* is represented by about 225 described names although, excluding synonyms, the number of distinct species is considerably less. Godman and Salvin in the "Biologia" (1884) state that there are "not less than 100 species, . . . no less than thirty-five occurring within our limits." [Mexico and Central America.] Dr. Carlos C. Hoffmann in a recent paper (1940, Cat. Sisten. y Zoogeo. Lep. Mex.) lists 21 species from Mexico. In North America three species have been recorded and in the Antilles five species with a considerable number of subspecies and forms; and it is with these, their distribution and relationship to those of Central and South America that this study is mainly concerned.

ANAEA Hübner

Genotype.—*troglodita* (Fabricius).

1819, *Anaea* Hübner, Verzeichniss bekannter Schmettlinger, p. 49. (Generic synonymy is omitted as unnecessary here.)

This genus is characterized by the cross-veins which, in the

forewings, connect the subcosta with the margin and the radius with the subcosta. The number and position of these cross-veins varies among the species. The cell of the forewing is closed and the cell of the hindwing feebly closed. The genus is placed by many authors as the highest of the butterflies.

Consideration of the Antillean species shows that they are divided into three groups and that each of these groups contains continental species as well, with which the Antillean species are more or less closely associated.

Group I

These species of *Anaea* are of medium to large size, some having a length of forewing exceeding 40 mm. Male and female are similar and both have the inner margin of the forewing straight and have tails at M_3 of the hindwing. The color of the upper-side is generally red. The male genital armature has porrect, antler-like gnathos.

This group inhabits the southern and central area of North America, Mexico and a little to the southward, the Greater Antilles and St. Kitts.

Anaea andria Scudder (Figs. 1-5).

1871, *Paphia glycerium* Edwards, Butt. N. Am., I, Pl. Paphia, Figs. 1-6.

1874-1875, *Anaea andria* Scudder, Bull. Buffalo Soc. Nat. Hist., II, p. 248.

1877, *Paphia ops* Druce, P. Z. S., London, p. 633.

1889, *Anaea andria* Scudder, Butt. Eastern U. S. and Canada, III, p. 1796.

1916, *Anaea andria*, Röber, Macrolep. World, V, p. 581, Pl. 117e.

1931, *Anaea andria* Holland, Butt. Book, p. 173, Pl. xxiv, Fig. 1, ♀.

1940, *Anaea andria* Field, Bull. Univ. Kansas, XXXIX, No. 10, p. 107.

Of most extended distribution in North America, this species ranges throughout the Mississippi basin from West Virginia and North Carolina to Illinois, Colorado and Texas. There is also a record from Jalapa, Mexico. It was described without a specific

type by reference to Edwards' figures of "*glycerium*." The source of the imagoes figured by Edwards is not stated but they may have come from Illinois or Missouri. Scudder (1889) quotes a correspondent (Rowley) who "asserts that there are at least two broods of the imago, and that there is a decided seasonal dimorphism in the two broods of the female." More recently, Mr. Harold I. O'Byrne, who has done much collecting in Missouri where *andria* is common, says that he has noted the difference in the summer and fall broods of *andria*. However, it is difficult to separate the broods on any basis of dates because of the long life of the imago. The fall brood lives over the winter and into the succeeding summer, overlapping in part the summer brood, which also overlaps the succeeding fall brood. Thus it is possible to find both summer and fall broods on the wing together during the early summer and again in the fall. Yet there exist two separate broods quite distinguishable one from the other.

Anaea andria Scudder is the fall brood which overwinters, flying again in the spring. *Anaea ops* (Druce) is a synonym of this as is shown by photographs made by Mr. C. F. dos Passos of the type (British Museum, No. 10370, *Paphia ops*, ♂, Texas). A colored drawing of this type is also before us.

Anaea andria, summer form **andriaesta**, new form.

This differs from *andria* in the following characters:

Size and shape:—fall form *andria* has a length of forewing of from 29 to 32 mm. (male), and from 32 to 38 mm. (female); and the summer form from 28 to 34 mm. (male), and from 32 to 39 mm. (female). In the summer form, the outer margin of the forewing tends to be straight; thus the apex of the forewing is not acute, though the costal curvature is approximately the same as in the fall form *andria*. With slight variation in individuals, this characteristic holds true for both males and females. Expressed another way, the outer margin of the forewing is less excavated toward the apex in the summer form than in the fall form. In the summer form the outer margin of the hindwings is less rounded and the apical angle is more obtuse than in the fall form.

Ground-color:—in the summer form the orange-red ground-color is more brilliant in the males and paler in the females than in the fall form *andria*.

Markings:—in the forewings of the summer form males the black sealing which forms the marginal wing-band is narrow and sometimes obsolete. In the fall form this black sealing is heavy and forms a definite border-band broadened at the apex. In the summer form males the cell spot of the forewing is obsolete, whereas in the fall form males this spot is well defined. In

the hindwings of the summer form males the black marginal scaling is cut along the veins by streaks of the bright ground-color, producing in some individuals a series of black marginal spots joined at the marginal edge. In the fall form this black border-band is pronounced, only very slightly penetrated along the veins by the bright ground-color.

The summer form females have less definite characters in their markings to separate them from the fall form females. They seem consistently paler in ground-color; the vein outlining is more distinct and there is less black scaling. As with the fall form there is some variation in individuals. The tint of ground-color in the interspace between the mesial line and the border varies from being the same as in the basal area to distinct lighter.

Underside markings of both males and females of the summer form seem less definite than in the fall form. Individuals of the fall form *andria* show distinct patterns; many summer form individuals show hardly any pattern.

Types:—holotype, male, Alexandria, Louisiana, September 5, 1935; allotype, female, Jefferson Barracks, Missouri, 1932, both from the collection of Mr. C. F. dos Passos. Paratypes:—four males, Birmingham, Alabama, August 8–9, 1916 (F. E. Watson); one male and one female, Mobile, Alabama, September 3, 1925; one male, Texas, No. 1465, collection J. Angus; one male and one female, Texas, No. 5342 collection Hy. Edwards; one female, Jefferson Barracks, Missouri; one female, Springfield, Colorado, June 10, 1919. All are in the collection of The American Museum of Natural History.

The following paratypes are in the collection of Mr. C. F. dos Passos: one male, Sarita, Texas, June 16, 1932; one male, Hunter, Oklahoma, August; one male, Hamilton, Kansas, October 17, 1925; one female, George West, Texas, June 11, 1940; one female, Concordia, Missouri, August 11, 1929. The following paratypes are in the collection of Mr. Frank Johnson: two males, Birmingham, Alabama, August 8–9, 1916 and August 26, 1927; one female, no data. One paratype, male, Kentucky, is in the collection of Mr. Otto Buchholz. One paratype, male, San Antonio, Texas, July, 1899 (O. C. Poling), collection R. C. Williams, Jr., is in the Academy of Natural Sciences of Philadelphia.

With *andria* we have a species living in a uniform environment in the great basin area of the Mississippi River and its tributaries, bounded on the east by the Appalachians and on the west by the Rocky Mountains. This species shows great uniformity throughout its range, as would be expected with a strong flying butterfly living in an extended and unconfined range.

Its usual variation is as previously defined but it occasionally produces an aberrant form as shown by a female *andria* (Willard, Missouri, October 9, collection of Mr. C. F. dos Passos) in which the upperside is extremely suffused with black scales. In the forewings this black scaling covers the apical half of the wings, obscuring all normal banding. In the hindwings this black scaling extends beyond the mesial line but does not obscure it. The underside is normal. Reference is made to several similar aberrations by Field.

Anaea aidea aidea (Guérin-Ménéville) (Figs. 6, 7).

1844, *Nymphalis aidea* Guérin, Icon. Règne Anim. Ins., p. 478.

1916, *Anaea aidea*, Röber, Macrolep. World, V, p. 582, Pl. 118a.

The type of this species is a male taken on shipboard "more than a league at sea" on Campeche Bay, Mexico. Its recorded distribution extends throughout Mexico and south into Guatemala and Honduras from many localities. It is a distinct species, not a race of *troglydyta* as placed by Röber.

Anaea aidea f. morrisonii (Edwards).

1883, *Paphia morrisonii* Edwards, Papilio, III, p. 8.

1883, *Paphia morrisonii* Edwards, Can. Ent., XV, p. 35.

1898, *Anaea morrisonii* Holland, Butt. Book (1st Ed.), p. 193, Pl. xxiv, Fig. 2 ♀.

1916, *Anaea morrisoni* Röber, Macrolep. World, V, p. 582.

1916, *Anaea appiciata* Röber, Macrolep. World, V, p. 582.

1926, *Anaea aidea* Barnes and Benjamin, Bull. So. Calif. Acad. Sci., XXV, p. 16.

1931, *Anaea morrisoni* Holland, Butt. Book, p. 173, Pl. XXIV, Fig. 2 ♀.

1940, *Anaea aidea f. morrisoni* Field, Bull. Univ. Kansas, XXXIX, No. 10, p. 108.

The relationship of *morrisonii* to *aidea* is pointed out by Field. *A. aidea f. aidea* is the summer or dry season form and *A. aidea f. morrisonii* is the winter or wet season form. Field records *morrisonii* from Scott County, western Kansas and gives other United States records of its distribution from Texas, Arizona and

California. Mexican records of *morrisonii* are numerous where it flies in the same places as *aidea* far to the south. Holland (1931) calls attention to a mistake made by Barnes and Benjamin in placing *morrisonii* as a synonym of *aidea*.

There is a curious complication concerning the authorship of the name *morrisonii*. The original reference to *morrisonii* by Edwards in "Papilio" is more a citation than a description.* The actual description by Edwards in the "Canadian Entomologist" seems to have escaped attention until cited by Field. Edwards omitted the reference to his description in his catalogue of 1884 and it had been overlooked since, the "Papilio" reference being the only one cited until Field's publication. Holland was apparently unaware of the description for, although he originally credited the species to Edwards, he later appropriated the name "*Anaea morrisoni* Holland (Edw. Ms.)" making a synonym.

In the interim, Röber described: "appiciata Stgr. i. l. from Mexico being also somewhat more brightly colored." Röber considered his *appiciata* as a race of *troglydyta* and contrasted it with *aidea* which he also placed as a race of *troglydyta*. This association is incorrect as will later be shown and *appiciata* is a synonym of *morrisonii*.

W. H. Edwards in his description did not fix the type of *morrisonii*: "From one male, from Western Texas, in the collection of Mr. B. Neumoegen, and 3 females, taken by Mr. Morrison, on Mt. Graham, Arizona." Mr. Wm. D. Field has kindly examined for us the collection at the U. S. National Museum (where the Neumoegen collection is deposited) and has been unable to find the male from western Texas. However, there is in the collection one of Edwards' "females" which is actually a male. This bears, among others, the label "Morrisoni ♀ Mt. Graham, Ariz." in Edwards' handwriting.

Through the kindness of Dr. A. Avinoff we have examined the two types in the Carnegie Museum at Pittsburgh. These are two males bearing similar labels in Edwards' writing: "Morrisoni ♀ Mt. Graham Ariz." in black ink with the word "type" written across the left end of the label in red ink.

* According to the International Rules of Zoölogical Nomenclature, The Law of Priority, Article 25, a; the "Papilio" reference might be interpreted to be the original description for it was an "indication" of a new name.

Thus the three "females" exist but all are males of what is generally recognized as *morrisonii*. We make one specimen the lectotype ♂ and have so labeled it. This is reasonably perfect but slit midway of the left hindwing, and slit in from the anal angle of the hindwing. The right antenna is missing. It carries the Edwards' label as mentioned above with the additional label "Holland Collection." It is in the collection of the Carnegie Museum, Pittsburgh, Pa.

***Anaea aidea cubana* (Druce) (Figs. 8, 9).**

1905, *Perrhanaea cubana* Druce, Ann. Mag. Nat. Hist. (7th Series), XVI, p. 549.

1916, *Anaea cubana*, Röber, Macrolep. World, V, p. 581, Pl. 117d.

This large, richly colored butterfly appears to be confined to Cuba. It looks like an enlarged and enriched development of *aidea* f. *morrisonii*, the association appearing particularly close in the females. In most of the specimens examined the forewings are apically falcate, like *morrisonii*, but occasional specimens occur where the projection is reduced. The male genital armature shows that *cubana* and *aidea* with form *morrisonii* are sub-specific.

***Anaea aidea floridalis*, new subspecies (Figs. 10, 11).**

1916, *Anaea portia*, Röber, Macrolep. World, V, p. 581, Pl. 117d.

(This figure shows a female, quite evidently of the Floridian subspecies.)

1931, *Anaea portia*, Holland, Butt. Book, p. 173, Pl. XXIV, Fig. 3 ♂.

Size and shape:—males have a length of forewing of from 35.2 to 37.7 mm., females from 37.8 to 41.7 mm. The average is slightly smaller than *cubana* in either sex, but much larger than *aidea*. The forewing shape of the males is slightly less falcate than in *cubana* or *morrisonii* and the outer margin is slightly undulate as in *cubana*. The hindwing shape is like that of *cubana* but the tails are slightly stockier. The outer margins of the *aidea* subspecies are generally more regular than is the case with the various subspecies of *trogodyta* to be discussed later. The females have similar wing-shape characters.

Groundcolor:—in males this is a bright orange-red, in contrast with the orange-brown ground of *aidea* or the considerable buff tinting of *cubana*. The color of the females is less brilliant than that of the males, brighter than in *aidea* and *morrisonii* and very similar to the color of the forewings of *cubana*. Compared with the various subspecies of *trogodyta* there is little difference in color but there is less violet reflection in Floridian males.

Markings:—males on the upperside have a relatively narrower and straighter fuscous border than do any other closely related species or subspecies. The widening of the border between M_3 and Cu_1 is mostly an obsolete character. In the apical area the fuscous scaling is much reduced. The forewing mesial band is variable; October specimens show a definite, black band but later specimens as in December and February show the band to be faint to obsolete. In the hindwings there is little difference from other species. Females have heavier marginal bands, well emphasized mesial lines and cell spots. In the anal areas of the hindwings the fuscous scaling replaces the buff color occurring in *cubana*. The interspace between the forewing mesial line and the border is broader than in *aidea* or *cubana*, but is like them in being less jagged than in any of the *troglodyta* subspecies.

On the underside, males and females are predominantly grey, variously shaded, with a ruddy flush extending over the forewings, though frequently obscured with grey in the anterior half of the wings. This is different from the buff tinting of *cubana* or the greenish-buff tinting of *aidea*. In general, the effect of the underside is much like *troglodyta*, though more brilliant than in any of these subspecies. A notable point of difference occurs in the two spots in the anal area of the hindwings. In over 100 Floridian specimens examined, the spot above the tail is always the larger, that towards the anal angle the smaller, sometimes obsolete, in one case absent. While this is a character found in *cubana* it is not the case with any *aidea* examined in which these spots are of equal size (whether larger or smaller in individuals) and in which there are frequently two other lesser spots close to the anal angle. In over 100 specimens examined of the several *troglodyta* subspecies, the anal spots show consistent equality of size varying in individuals from an equal pair of minute spots to an equal pair of pronounced spots (as in Jamaican *portia*).

Male genital armature:—the harpés are closely rolled and blunt-ended, a characteristic of *aidea*; the gnathos are spread-ended and toothed, also a general character, but differ from those of *aidea* in having pronounced thumb-like toothed branches. In general the gnathos are similar to those of *cubana* but differ in details of structure (Figs. 6–11).

Types (all from Florida):—holotype, male, Florida City, December 10, 1936; allotype, female, Miami, February 18, 1923; Paratypes:—one male, Florida City, December 10, 1936; one male, Royal Palm Park, December 4–10, 1937; three males and four females, Biscayne Bay, collection of Mrs. A. T. Slosson; one female, Homestead, April 18, 1923. All are in the collection of The American Museum of Natural History. Two paratypes are in the collection of Mr. C. F. dos Passos: male and female, Miami, February 2, 1932. Four paratypes are in the collection of Mr. Otto Buchholz: from Florida City, two males, October 10, 1933,

and October 9, 1937; two females, October 28, 1936, and October 9, 1937.

Anaea aidea floridalis, summer form **floraesta**, new form.

The reported dates of *floridalis* show it flying from October into April but a different form occurs from May into October. As fresh specimens appear throughout the year there must be a number of broods but the butterflies of the winter or wet season are different from those of the summer or dry season.

In males and females the average size of the summer form does not differ from the winter form. In wing-shape the summer form shows the same divergence noted in other species under similar conditions; the forewings are not as deeply excavated in the outer margin, thus effecting a blunt apex; and the tails are slightly more robust, thus appearing shorter.

In males, the mesial line of the forewing is more obvious, the forewing borders less so and the fuscous sealing of the hindwing borders is reduced so that the ground-color shows through as a series of spots. In females, the same characters hold but to a less contrasting degree. On the underside, there are no particular points of separation. The male genital armature is the same as in *floridalis*.

Types (all from Florida):—holotype, male, Brickell Hammock, Miami, August 2, 1939, from the collection of Mr. C. F. dos Passos; allotype, female, Florida City, August 14, 1937. Paratypes: males,—one, Brickell Hammock, Miami, July 29, 1939, from the collection of Mr. C. F. dos Passos; two, Miami, July, 1904; one, Florida City, May 19, 1938; females—two, Florida City, July 31, 1933, and October 10, 1937; one, Miami, July, 1904. All are in the collection of The American Museum of Natural History. Paratypes in the collection of Mr. C. F. dos Passos are:—males—four, Brickell Hammock, Miami, August 2, 1939; one, Florida City, August 11, 1933; two, Coconut Grove, August 2, 1939; females—two, Brickell Hammock, Miami, August 2, 1939; one, north-west section Miami, August 3, 1939; one, Florida City, September 2, 1932. Paratypes in the collection of Mr. Otto Buchholz are male and female from Florida City, respectively July 4, 1936, and June 2, 1937.

Occurring in southern Florida, *floridalis* is associated with *aidea* but is more closely connected with *cubana*. The male genital structures show that the three are of one species which divides, in three separate populations, into three subspecies having main characters in common but each differing from the other in minor characters.

It does not seem unreasonable to suppose that the Floridian subspecies originated at some geologically recent date as a migrant from Cuba. Its affinities are distinctly with *cubana* in superficial characters of size, shape and wing pattern and in the structure of the gnathos and harpés (Figs. 8–11). Cuban and Floridian specimens have more in common than either has with the continental subspecies *aidea*. To account for the Floridian subspecies by continental distribution is difficult because *aidea* apparently reaches an extreme northern and eastern limit in Kansas. The Mississippi basin, populated by *andria*, intervenes and also most of the length of Florida before the home of *floridalis* is reached, the southern part of the peninsula of Florida.

Mr. Dean F. Berry says that in fourteen years collecting in the eastern area of Florida, in Orange County and southward through Okeechobee and St. Lucie Counties, he has never seen "*portia*." All known records are from Miami southward.

The naming of the Floridian subspecies raises a question of taxonomy, as may easily be discovered by a perusal of the literature. The name applied to the present is *portia* (Fabricius) based on a determination by Schaus (1898, Ent. News, IX, p. 96). This and also *troglogyta* is inapplicable as will later develop.

So far two species with subspecies have been discussed. The first is *andria* with its form *andriaesta*; the second is *aidea aidea* with its form *morrisonii*, *aidea cubana*, and *aidea floridalis* with its form *floraesta*. There is a third species, *troglogyta*, with several related island subspecies, which is certainly closely connected with both the other species, but with equal certainty is specifically distinct and endemic. These three species with their subspecies occupy distinct regions; two species overlap slightly, but the others are separated.

In the appearance of the imagoes the five subspecies comprising *troglogyta* are very close to each other and superficially similar to *floridalis*. The *troglogyta* subspecies may be separated in facies from *floridalis* by the characters previously given but their separation from each other depends on slight differentiating characters. Fortunately the male genital characters of each are excellent and consistent and make possible a definite separation

of the *troglodyta* subspecies. Further each subspecies is found in a separate island and sufficient material has been studied to place these subspecies safely by their geographical location.

As here recognized, there are five separate populations which occupy Jamaica, Hispaniola, Puerto Rico, Virgin Islands and St. Christopher (St. Kitts). Before considering these butterflies biologically it seems best to study their taxonomy and place the existing names where they belong as nearly as may be from the evidence available.

***Anaea troglodyta troglodyta* (Fabricius) (Figs. 12, 13).**

- 1775, *Papilio troglodyta* Fabricius, Syst. Ent., p. 502, No. 250.
1781, *Papilio troglodita* Fabricius, Species Insect., II, p. 87, No. 348.
1787, *Papilio troglodita* Fabricius, Mant. Ins., II, p. 47, No. 464.
1793, *Papilio troglodyta* Fabricius, Ent. Syst., III, Part 1, p. 77, No. 240.
1819, *Anaea troglodita* Hübner, Verz. bek. Schmett., p. 48, No. 445.
1877, *Paphia troglodyta* Druce, P. Z. S., London, p. 633.
1916, *Anaea troglodyta* Röber, Macrolep. World, V, p. 581. Pl. 117d (3) ♂.

Fabricius gives "Habitat in America, Mus. D. Hunter." However the most likely source of Fabrician material is the Greater Antilles. It seems very unlikely that specimens came from southern Florida for all of the early explorations and settlements were in northern Florida, whether Spanish, French or English. As for the Lesser Antilles, this species of *Anaea* has never been reported further south than St. Kitts. Jamaica, Hispaniola, Puerto Rico and Virgin Islands are the obvious places from which this early material may have come.

With sufficient material from all of the islands available, the brief original descriptions prove helpful. The description of *troglodyta* applies to a male and in describing the hindwings there is the following:—"Puncta aliquot ferruginea, obsoleta in margine fusco. . . ." Of all the island populations, males from Hispaniola are the only ones which exhibit these rusty ground-

color spots in the dark margin in the described degree. The further fact that the insect is common on Hispaniola and occurs at all seasons would increase the likelihood of its capture. Herbert Druce says of *troglydyta*:—"It is peculiar to the West Indies" and gives the habitat "Haiti (Tweedie), Jamaica (Cutter)." For *portia* which "may be only a variety" he gives the habitat "Jamaica." It is on this evidence that the name *troglydyta*, which is the nomenclatory stem of the species, is assigned to the subspecies in Hispaniola.

Anaea troglodyta portia (Fabricius) (Figs. 18, 19).

1775, *Papilio portia* Fabricius, Syst. Ent., p. 507, No. 268.

1793, *Papilio portia* Fabricius, Ent. Syst., III, Part 1, p. 78, No. 242.

1807, *Hamadryas undata astina* Hübner, Samml. exot. Schmett., I, Pl. 56, Female 1, 2.

1877, *Paphia portia* Druce, P. Z. S., London, p. 633.

Fabricius gives "Habitat in America V. Rohr." in 1775 and "Habitat in Americae Insulis Dom. V. Rohr." in 1793.

Accumulated evidence associates the name *portia* with the Jamaican subspecies. The description is of a female and as a distinctive character Fabricius says of the underside of the hindwing:—"Puncta duo distincta nigra in alis posticis ad marginem posticum." An examination of a series of Jamaican *portia* shows that these two spots are of equal size and stand out distinctly on a violet-grey ground in the average much more so than is the case with any other insular subspecies. At the end of his description Fabricius refers to the male:—"Varietas paulo minor alis anticis minus falcatis fulvis, puncto unico nigro, An mas?" (A little smaller variety with the less falcate fulvous forewings, with single black spot, a male?) Of all the island subspecies the mesial line of the forewing is least emphasized in the Jamaican males. The English lepidopterists, Doubleday, Butler and Druce, give the locality of *portia* as Jamaica. It would seem reasonable to accept this allocation.

Hamadryas undata astina Hübner is here determined as a female *portia*, despite the fact that it was placed as a synonym of *troglydyta* Fabricius by Hübner (1831, *Zutrage zur Sammlung exotischer Schmetterlinge*, III, p. 36).

Anaea troglodyta astina (Fabricius) (Figs. 16, 17).

1793, *Papilio astina* Fabricius, Ent. Syst., III, Part 1, p. 81, No. 251.

1781, *Papilio astinax* Cramer. *Papilio astianax* Cramer. Pap. Exot., IV, pp. 91, 248, 4, Pl. 337 A B.

1823, *Papilio agathon* Dalman, Analecta Entomologica, p. 42.

Because of existing names the next insular butterfly to consider is that of the Virgin Islands. Cramer described *Papilio astianax* from St. Thomas. The spelling *astinax* in the Dutch text, first column, is considered a *lapsus calami* as the spelling is given *astianax* in the French text, second column, and in the index (p. 248), and again in Stoll's systematic arrangement (p. 4). *Papilio astianax* is a homonym of *Papilio astyanax* Fabricius (1775) as i and y are ruled interchangeable. Dalman noted this homonym and proposed the name *agathon*. Fabricius also described this St. Thomas butterfly as *astina* saying "anticis lunula atra" referring to the peculiarity of the costal black triangular mark near the apex shown in Cramer's figure and a character of the facies which separates the Virgin Island subspecies from others. Thus *astina* (Fabricius) has precedence and of it *astinax*, *astianax*, and *agathon* are synonyms. Specimens from St. Croix and St. Thomas are alike.

The female of *astina* seems to be undescribed. It is as large as *troglodyta* females and almost indistinguishable from them. It is larger than the females of the remaining island subspecies and has a more jagged mesial line of the forewing and a pronounced junction of this line with the border along M_3 . The specimen described is from St. Thomas, Virgin Islands, November 22, 1925, the type locality of the subspecies. It is designated as a plesiotype and is in the collection of The American Museum of Natural History.

Anaea troglodyta minor Hall.

1936, *Anaea troglodyta minor* Hall, Entom., London, LXIX, p. 274.

The remaining described subspecies is *minor* Hall from St. Kitts. This is a small form as described and though no speci-

mens are available for study, it seems a safe assumption that it is a valid subspecies. From the characters given in the description its appearance must be very similar to that of the following subspecies which inhabits Puerto Rico.

Anaea troglodyta borinquenalis, new subspecies (Figs. 14, 15).

Size and shape:—the length of forewing in males ranges from 31.5 to 34.2 mm., and the length from base to tip of tail of hindwings from 30.8 to 34 mm. In females similar measurements give from 31.3 to 37.4 mm., and 29.7 to 35 mm., respectively. These are thus slightly smaller than the average of *portia* and appreciably smaller than the average of *trogldodyta* or *astina*. The forewings of both sexes are falcate as in *portia* and equally slightly variable in different specimens. The hindwings are more regular in outline with less tendency to scallops between the vein projections thus differing from *portia*. The tails are slightly shorter and broader than in *portia* but not so much so as in *trogldodyta*.

Ground-color:—the tawny-red upperside of the wings of the males is the same as with other subspecies of *trogldodyta* with the rose reflections. The females are slightly paler than *portia* and lack the contrasting tints evident in *trogldodyta* and *astina*.

Markings:—the differences in markings between the several subspecies becomes evident only in comparisons of series of specimens, where the summation of all characters gives weight to the distinctions. In males from Puerto Rico the pattern made by the black markings is different from other subspecies but in elusive and slight characters difficult of definition. The mesial band of the forewing (obsolete in *portia*) is slightly more evident than in *trogldodyta* and a little less so than in *astina*. In the black border, in the interspace between M_3 and Cu_1 there is an indentation doubling the width of this black space and projecting along M_3 as a line to join the mesial band. The hindwings exhibit a slightly narrower black border than in other subspecies, unless it may be equally narrow in *minor* (which differs according to the description in other particulars).

The markings of the females repeat with more emphasis those of the males and differ proportionally in the same respects from other subspecies. On the underside, the elusive and indeterminate characters of the individually variable markings make description difficult. The two equal black spots in the anal area characteristic of *portia* are fully as definite in some specimens as in some specimens of *portia* but in the average they are less so.

Male genital armature:—the character of separation is definite for the Puerto Rican population. That these butterflies belong to *trogldodyta* is obvious because they have the characteristic general type of armature and particularly the strongly developed hook-shaped terminals on the harpés. They also possess slender much incurved gnathos, sharply pointed with small side teeth. This is the simplest kind of gnathos to be found among the four *trogldodyta* subspecies examined and is as definitely and clearly distinct from the others as they are *inter se*. (Figs. 12-19.)

Types (all from Puerto Rico) :—holotype, male, Tallaboa near Ponce, July 23, 1914; allotype, female, Ensenada, June 14–19, 1915. Paratypes :—two males, Tallaboa, March 7, 1927, and July 23, 1914; female, Ponce, July 20–22, 1914. All are in the collection of The American Museum of Natural History.

In the male genitalia of these *Anaea* of "Group I," the tegumen is broad with a well developed uncus, the vinculum is slender, and the saccus mostly well developed. Attached to the tegumen at either side above the vinculum are twin processes called gnathos and below these the harpés are broadly attached to the vinculum. The characters most useful for separation appear in the porrect gnathos and secondarily in the harpés. The ædeagus seems a little variable among the species. For study, wet preparations are necessary to get proper views of the structures.

All of the *Anaea* so far considered are easily separated by their genital structures.

First:—*andria* shows bridged and branched gnathos bluntly tipped with a series of small teeth; broad harpés with a pronounced saccus and a short broadly-based terminal tooth. Spines (not shown in figures) are numerous on these organs but this is a character common to all species. (Figs. 1–5.)

Second:—*aidea*, *cubana* and *floridalis* have a uniform type of genital armature generally similar to *andria* but differing therefrom in a shorter saccus and other important features. They are further subspecifically separable each from the other by the varying gnathos, bridged by a membrane, broadly branched and with many terminal teeth of variable size. The harpés are more closely rolled than in *andria* and blunt at the end with an obsolete terminal tooth. (Figs. 6–11.)

Third:—*portia*, *troglogyta*, *borinquenalis* and *astina* are each distinct but have genital characters in common which separate them from the first and second species mentioned. Here the gnathos, bridged by a membrane, are slender and distinctly falcate and the harpés have a relatively large, falcate, terminal projection. *Anaea minor* Hall from St. Kitts would seem a probable member of this assembly but, lacking material, this cannot be confirmed. (Figs. 12–19.)

As to the possible intermingling of *aidea cubana* and *troglo-*

dyta troglodyta there is no evidence despite the proximity of Cuba and Hispaniola. There are records of *cubana* from various localities in central to eastern Cuba. There are no records of *troglydyta* from Cuba. On Hispaniola, *troglydyta* is well distributed with coastal records from northern and western Haiti. There are no records of *cubana* from Hispaniola. The two species as far as reported are each confined to their own insular homes.

In a series of 60 specimens of *troglydyta* from various localities in Hispaniola over half were caught in February and March. Classed with these are early April specimens. These are all of the decidedly falcate wing-type in both sexes. Then, with one specimen dated June 29, there is a series caught in July and August. The indication is that there are two broods and there may be more. Among the dry season specimens there are some which have the straight outer forewing margin and others which have the falcate wing but in a degree less pronounced than the extremes of the brood occurring earlier in the year. No constant differences seem to occur in upperside marking to separate the broods but on the underside the pattern is less defined in the dry season brood. The Hispaniola records, from 17 localities, are all coastal points or not far inland; none are from the highlands of the interior.

Group II

These species of *Anaea* are of medium size with a length of forewing of 25 to 35 mm. The sexes are dissimilar but both have a straight inner margin to the forewing. The males may have rounded hindwings or may develop a projection from a short spike to a definite tail at M_3 . This variation may occur in males of a single species. The females are always tailed at M_3 . The color of the upperside of males is tawny-red, tawny-brown or purple; of females buff to brown. The underside patterns are highly variable between individuals of the same species. The gnathos of the male genital armature extend ventrad with a continuous broad bridge between the sides.

This group as a whole has a very extensive continental range. There is but one Antillean species, *johnsoni* from Jamaica.

Section 1.

Anaea ryphea (Cramer) (Figs. 23, 24).

- 1775, *Papilio ryphea* Cramer, Pap. Exot., I, p. 76, Pl. 48 G, H.
- 1834, *Anaea phidile* Hübner, Zut. Samml. exot. Schmett., V, p. 27, Figs. 905, 906.
- 1865, *Paphia erythema* Bates, Jour. Entom., II, p. 342.
- 1877, *Paphia ryphea* etc., Druce, P. Z. S., London, p. 634.
- 1916, *Anaea ryphea* etc., Röber, Macrolep. World, V, p. 582, Pl. 118.
- 1929, *Anaea phidile* ab. *albomaculata* Neustetter, Int. Ent. Zeit., Guben, 28 yr., p. 392.

Cramer's *ryphea* was a male described from Surinam. It is of the kind which develops a short projection at M_3 of the hindwings.

Anaea phidile Hübner, stated to be a female, is a male of *ryphea* of the kind which has an entirely rounded hindwing. The type locality was unknown to Hübner.

The butterfly Bates described as *Paphia erythema* came from "Upper Amazons, at St. Paulo." The types in the British Museum are labeled: male, No. 10720, São Paulo de Olivença; female, No. 10721, Amazons. With water-color drawings of these types before us it is evident that *erythema* is a synonym of *phidile*.

Neustetter's ab. *albomaculata* are specimens showing, on the underside of the hindwings, a mesial development of white spots.

The male genital armatures show that all of these names apply to but one species. Present evidence suggests that *ryphea* with the hindwing projection at M_3 is the wet season male. The wet season female has contrasting tints of buff in the ground-coloring, appearing somewhat variegated and brilliant. The dry season form seems to be *phidile* (= *erythema*) with rounded hindwings in males and a uniform ground-coloring of deep buff in the females. As the seasons vary in different localities in the tropics nothing very definite can be said about the seasonal forms until much more exact data can be obtained.

The species *ryphea* extends over a tremendous range from

Mexico throughout South America to 25 degrees south. The males vary in size and richness of coloring on the upperside. The variations from the normal, russet, striated marking on the underside range from those only partly mottled with black to occasional specimens almost entirely black; and from those with a few small mesial white spots on the hindwings to some with a band of large white spots (ab. *albomaculata* Neustetter). Some striking specimens combine both the black and white markings. The females exhibit these black and white markings as well as the males. Some *ryphea* females are almost indistinguishable on the upperside from *eurypyle* females, but are separable by the underside pattern.

The structure of the gnathos in *ryphea* males separates this species from all others of the group (Figs. 23, 24). The presence of tubercles on the central surface is unique. The harpé is also straight across the end but in this respect *cratias* (Fig. 32) is similar.

The figures given by Röber are in some cases misidentified. On plate 118, line a, number 3 is *ryphea* f. *phidile* ♂, number 4 is *ryphea* f. *phidile* ♀; line b, number 3 is *eurypyle* ♂, number 4 is unidentified but not *ryphea* ♀, number 5 is *ryphea* f. *phidile* ♂, number 6 is *eurypyle* ♀ wet season; line c, number 1 is *ryphea* f. *phidile* ♂, number 2 is *eurypyle* ♂, number 3 is *sosippus* f. *rutilans* ♂, number 4 is probably *venezuelana* ♀, number 5 is southern, wet season *glycerium* ♂.

Section 2.

Anaea eurypyle eurypyle (C. and R. Felder).

1862, *Nymphalis eurypyle* C. & R. Felder, Wien. ent. Monat., VI, p. 119.

1877, *Paphia eurypyle* Druce, P. Z. S., London, p. 635.

Typical *eurypyle* is tailed in both sexes and can be further separated from *ryphea* by the straight mesial line crossing the underside of the hindwing. The more regular (straighter) outer margin of the forewing in *eurypyle* separates it from *glycerium* which is definitely scalloped. It was described from equatorial Brazil but its range extends westward spreading from Bolivia to Colombia. It produces wet and dry season forms.

Anaea euryppyle confusa Hall (Figs. 20-22).

1929, *Anaea euryppyle confusa* Hall, Entom., London, LXII, p. 133.

From Mexico and Central America to Panama comes the subspecies *confusa* imagoes of which are generally smaller and darker. Like *euryppyle euryppyle* the wing markings on both sides generally follow a uniform pattern but occasional specimens have black mottling on the underside and others have white spots at the costa of the hindwing. This subspecies produces seasonal forms which are quite distinct. Some males may have the apex of the forewing produced (the wet season form); or have the outer margin of the forewing straight from the apex to a slight bulge before the cubitus extending to the tornus (the dry season form). The females may be either with falcate forewing, even fulvous ground-color, and brown darker markings (the wet season form); or with straight outer margin of the forewing, a trifle deeper fulvous ground-color varied with much paler apical fore- and hindwing spots, and black-brown darker markings (the dry season form).

The male genital armature is shown completely (Figs. 20-22) because *euryppyle* seems typical of the entire group. In the left lateral view (Fig. 20) the relation of parts shown is characteristic of all of the species of the group though slight modifications of shape occur between species. Nevertheless the structure of the gnathos in *euryppyle* has characters in common with three other species so that these four species form a section within the group. There is no apparent difference genitally between *euryppyle* and *confusa*.

Anaea sosippus (Hopffer) (Figs. 28, 29).

1874, *Paphia sosippus* Hopffer, Ent. Zeit. Stettin, 35 yr., p. 329.

1875, *Paphia rutilans* Butler, Ann. Mag. Nat. Hist., (4th Series), XV, p. 223.

1890, *Anaea sosippus* etc., Weymer, Stübel's Reisen, p. 120.

1916, *Anaea sosippus* etc., Röber, Macrolep. World, V, p. 583-4, Pl. 118c. (The figure is form *rutilans*.)

This species was described from two males from Chanchamayo, Peru, but its range extends from Ecuador to Bolivia. The rich

purple color of the male distinguishes it from other species of the group. The described form has rounded hindwings and occurs in the dry season. Butler's *rutilans* (type No. 10722, British Museum, from Pucartambo, Peru), considered a synonym by Weymer, has a tooth-like projection at the submedian vein of the hindwing. This is the wet season form. The elongation at M_3 may even result in a moderate tail 2 or 3 mm. long.

The female of *sosippus* is undescribed. Designating a specimen from Ecuador as a plesiotype, in the collection of The American Museum of Natural History, it may be defined by comparison with dry season females of *ryphea* and *eurypyle*. The wing-shape, variable in individuals is similar in all three species. The tails are slender in *sosippus* and *ryphea*, heavier in *eurypyle*. On the upperside the pattern of marking is much more pronounced in *sosippus* than in either *ryphea* or *eurypyle*. In the forewings of *sosippus* a strong but irregular mesial line divides the basal area from the outer area, and this outer area is light buff as is also the light bar below the apex, contrasting strongly with the basal fulvous and the deep brown margin and apex. The irregular mesial line often appears lightly traced in *ryphea* but is obsolete to absent in *eurypyle*. In the hindwings, from above the tail to the anal angle, there are four or five black elongated points which occur similarly in the males of *sosippus*. All considered, female *sosippus* is a brighter, lighter colored butterfly than either *ryphea* or *eurypyle*. Like *eurypyle*, the species *sosippus* is distinguished from *ryphea* in having the mesial line on the underside of the hindwing straight, not irregular.

A. sosippus in the wingshape of the male has a similarity to *ryphea*. The structure shown in the gnathos, which has a cleanly outlined ventral margin, associates *sosippus* with *eurypyle*. It is therefore placed for classification between *ryphea* and *eurypyle*.

***Anaea ecuadoralis*, new species (Figs. 30, 31).**

Flying in central Ecuador is a peculiar species which shows an amount of individual variation surprising even for an *Anaea*. In the males it resembles *eurypyle* but it develops one form with a spike-like projection at M_3 of the hindwings and another with definite tails. The females are tailed like all other females in this group of *Anaea* and the general wing-shape also corresponds. The pattern of marking of the female is also similar but the upperside color contrasts produce a very distinctive butterfly. A remarkable amount of vari-

ation occurs in the type series where there are not two alike in the underside marking of either males or females. In the males the prevalent underside ground-color is purplish-brown, rather richer than in *sosippus* and with much more contrast of marking. In some specimens the ground-color is overcast with grey; in others with black mottling; and in one there is a mesial row of white spots on the hindwing. The females are striated with brown, buff and grey on the underside; some with the pattern submerged, others with it pronounced. An astonishing peculiarity of both sexes is that the mesial line of the hindwing may be either straight as in *eurypyle* or interrupted excessively as in *ryphea*, thus bridging the gap between these two species in this characteristic. Despite the extreme variation of the specimens which, under some circumstances, might be interpreted as a number of different forms, there seems to be no good reason to regard this series of specimens as other than one species. Therefore, average specimens, male and female, are selected as the holotype and allotype.

Size and shape:—males have a length of forewing from 29 to 30 mm., females from 31 to 32 mm. The wing-shape of the males is the same as that of those *ryphea* males in which the hindwing vein M_3 is produced to a spike. This spike may project no more than 1 mm., or may be prolonged as much as 4 mm., to form a slender tail. Females, though distinctly smaller, are shaped like dry season females of *eurypyle* with a straight outer margin of the forewing and no apical projection.

Ground-color:—on the upperside the males are uniformly more richly colored than *ryphea*, approaching the rich purple-red of *sosippus*; on the underside the effect is iridescent, grey-purple to rose-purple although the basic color is a dirty rust-brown. The females, on the upperside, have a dark rust-brown ground-color, much darker than any other species of this group; on the underside the ground-color is cream, like females of *sosippus* and lacking the yellow tone which produces the buff color of other species.

Markings:—on the upperside the males are marked like *ryphea* but with the ground-color spot in the black-brown apical area slightly more irregular, also the hindwings are dark-bordered with considerable variability in the extension of this border basad. A violet iridescent suffuses the upperside in oblique lights. On the underside the pattern is typical of the group but subject to unusual variability; the pattern of the forewings is fairly constant but the pattern of the hindwings is variable in that the mesial line may vary from being straight to wavy or even to jagged. Shade-bands of varying width and intensity as well as black mottling and white spotting in almost random distribution make a general description of the underside of the males nearly impossible as no two are alike. Females, while marked similarly to others of the group, are strikingly different from all others because of the dark dirty brown ground-color of the upperside and because the light spot in the dark apical area is white, thinly scattered with rusty ground-color scales. On the underside, on the cream ground-color, the typical markings of this group appear in varying intensity among specimens in various shades of brown. The mesial line on the hindwing varies as it does in the males and white spots may occur along it in some specimens.

Male genital armature:—the structure of the gnathos shows that *ecuadoralis* is closely associated with *euryppyle*. (Figs. 30, 31.)

Types:—holotype, male, and allotype, female, Ecuador, from the collection of Mr. Frank Johnson and deposited in The American Museum of Natural History with one paratype, male, Oriente, Ecuador. Paratypes in the collection of Mr. Frank Johnson are five males and five females, Ecuador, and two females, Oriente, Ecuador.

This most unusual species, in its wing-shape and markings, has features reminiscent of *ryphea*, *sosippus* and *euryppyle*. Because of its genital structure it is placed for classification in the section with *euryppyle* following *sosippus*.

Anaea cratias (Hewitson) (Figs. 32, 33).

1874, *Paphia cratias* Hewitson, Bolivian Butt., p. 9.

1916, *Anaea glycerium ornata* Röber, Macrolep. World, V, p. 583.

This species was described from Bolivia but occurs in a more extended range from Minas Geraes, Brazil, and southern Peru. Hewitson gives the color of the upperside "scarlet" which is not borne out by the type (No. 10715 ♂) examined in the British Museum. The color is a deep tawny fulvous similar to other species of this group. The white mesial spots of the underside of the hindwings mentioned in the original description can be exactly matched in occasional specimens. These white spots may be large, small or absent, as Hewitson remarks: "A specimen which corresponds in every other respect to that which I have just described is without the white spot on the underside."

The female of *cratias* is undescribed. Designating a female from Bolivia as a plesiotype in the collection of Mr. Frank Johnson, this may be compared with the male of the species for description. The wing-shape is similar except that the forewings are apically more acute, a variable character. The ground-color is paler, as usual in females, and therefore the dark maculation is more in contrast but placed as in the male. On the underside the specimen chosen is one in which black patching is well developed, presenting the opposite variation from the normal to that of the type male *cratias* which has white spots.

Röber's *ornata*, described from Coroico, Bolivia, as a subspecies of *glycerium*, is a synonym of *cratias*.

The male genitalia of *cratias* show that it is associated with *eurypyle* more closely than it is with *glycerium* although the appearance of the imago is such as to associate it with *glycerium*.

For classification *cratias* is therefore placed following *eurypyle* and belongs in the section arranged by the genitalia and made up of *sosippus*, *ecuadoralis*, *eurypyle* and *cratias*.

Section 3.

Anaea glycerium (Westwood and Hewitson) (Figs. 25-27).

1759-64, *Papilio helie*, Clerck, Icones Ins., II, Pl. 34, Helie 103.

1850, *Paphia glycerium* Westwood and Hewitson, Gen. Diur. Lep., II, p. 317, Pl. 50, Fig. 1.

1882, *Papilio helie* Aurivillius, Recensio Crit. Lep. Mus. Lud. Ulricae, 179.

1916, *Anaea glycerium* etc., Röber, Macrolep. World, V, p. 583, Pl. 118c (No. 5 is *glycerium* ♂).

The type of *glycerium* came from Mexico (No. 10714, British Museum). The original figure and the type which has been examined show this to be a dry season male of that race of *glycerium* which flies from Mexico south to Panama. These average slightly smaller in size and are of a slightly deeper fulvous color on the upperside and darker on the underside than specimens from further south. Larger, paler specimens occur in Colombia and Venezuela and one specimen comes from French Guiana. The females are of paler buff color and they can be associated with their corresponding males in their respective regions. Though this southern race is recognized it is not now described as a new subspecies because of the insufficient data with the specimens in hand.

These butterflies produce seasonal forms both north and south, the wet season specimens being more incised and more apically pointed in the forewings than the dry season specimens. The subapical dark bar of the upperside of the forewings may be continuous or broken with different sizes of opening in a series from the same locality. More are broken in Colombian series and more

continuous in Central American series. On the underside of the hindwings a few specimens show small marginal white points and also a small costal white spot.

Papilio helie Clerck, is a homonym of *Papilio helie* Linnaeus which is presumably an Asiatic Satyrid according to Aurivillius. The butterfly Clerck figured is without doubt *glycerium* and a dry season male from the south in which the subapical dark bar is continuous.

The genital armature of the male of *glycerium* is uniform for specimens of various regions and seasons but it possesses structures in the gnathos (Figs. 25–27) which establishes section 3 of group II. Extending below the deep central sclerite of the gnathos is a folded curtain-like structure also occurring in modified form in the two following species which are associated with *glycerium*.

***Anaea venezuelana*, new species (Figs. 34, 35).**

Size and shape:—males have a length of forewing from 25 to 26.5 mm., females from 28 to 29.5 mm. The wing-shape of the males is close to that of *glycerium* but the undulation of the forewing outer-margin is not so accentuated, although of the same kind. The scallop opposite the median area, pronounced in *glycerium*, is in this species very shallow. The hindwings are more prolonged, more angular and not so rounded as in *glycerium* and the margin is more regular, not noticeably scalloped as in *glycerium*. The same comparisons hold for the females of the two species.

Ground-color:—on the upperside in the males, the ground-color matches *euryppyle*, with the same blue iridescence, seen obliquely. On the underside the color is rust-brown overshoot with an illusive greenish-golden iridescence. The female (probably figured but with the color too bright, Macrolep. World, V, Pl. 118c–4, as “♂ *glycerium*”), matches fairly well the dry season females of *euryppyle* in ground-color. On the underside it is a lighter replica of its male.

Markings:—on the upperside, the black-brown apical area encloses a smaller and more irregular spot of ground-color than in *glycerium* males. Further, the lower enclosing band of brown is unbroken in specimens of the type series. In the forewings, the marginal dark area narrows toward the tornus and in the hindwings it continues narrowly to include the tail which is not the case in *glycerium*. Males on the underside have the *glycerium* pattern. Females on the upperside are marked more heavily than dry season *euryppyle* females and differ in having a tawny border band on the forewing which extends up to the apex through the dark brown apical area. They also have in the hindwings, extending from the anal angle to and sometimes beyond the tail a row of 4 or 5 black points capped with white which are more noticeable than in most

of the related species when present. Both sexes show the group tendency to white spotting along the mesial line on the underside of the hindwings.

Male genital armature:—while directly associated with *glycerium* the differences are evident, particularly in the gnathos. (Figs. 34, 35.)

Types:—holotype, male, and allotype, female, Caracas, Venezuela, from the collection of Mr. Frank Johnson and deposited in The American Museum of Natural History. Paratypes:—three males and two females, Caracas, Venezuela, all in the collection of Mr. Frank Johnson.

Anaea johnsoni Avinoff and Shoumatoff (Figs. 36, 37).

1884, *Anaea glycerium* Godman and Salvin, Biologia Rhop., I, p. 337.

1888, *Anaea glycerium* Staudinger, Exot. Tagf., I, p. 177.

1926, *Anaea glycerium* Kaye, Trans. Ent. Soc., London, (1925), p. 474.

1941, *Anaea johnsoni* Avinoff and Shoumatoff, Ann. Carnegie Mus., XXVIII, p. 313, Pl. XXXVI, Figs. 3–6.

Occurring apparently in restricted regions in the island of Jamaica, *johnsoni* appears to be a scarce species. References to it in literature are under the name "*glycerium*."

Godman and Salvin report Jamaica as a locality for *Anaea glycerium* based upon specimens in the British Museum. Staudinger takes a positive exception to this locality and calls attention to the extensive continental distribution of *glycerium*. Kaye gives the following records for "*glycerium*":—Blue Mountains, February 1920 at 2000 feet and Constant Springs, November 1923. Dr. A. Avinoff, in many trips to Jamaica, obtained a number of specimens at two localities in the Cockpit country.

The structure of the harpés and gnathos of *johnsoni* show conclusively that this species is closely associated with *glycerium* and *venezuelana* (Figs. 25–27, 34–37). It is genitally well separated from *cratias* which belongs in section 2.

A comparison of the facies of the imagoes of *johnsoni* and *venezuelana* show a great similarity between them in both sexes, in size, shape, upperside color and markings. On the underside they differ, for both sexes of *venezuelana* have a greenish, bronzy sheen and males of *johnsoni* have a prune-red tone like males of

Mexican *eurypyle confusa* to which they appear surprisingly similar. Females of *johnsoni* are buff and brown on the underside.

Comparing in the same way, either *johnsoni* or *venezuelana* with *glycerium* gives interesting results. Southern males of *glycerium* are larger and paler but in Mexico and Central America there occur small dry season males of *glycerium* which are very similar in appearance to both *johnsoni* and *venezuelana* males. This comparison does not hold for females.

The comparison of *johnsoni* with *cratias* in the original description is reasonable for they look much alike but with other and closer species for comparison and with genital study for confirmation, more exact placement is possible.

Considering the continental distribution of *glycerium*, its indicated subspeciation and production of seasonal forms, with a closely allied species (*venezuelana*), at the southern end of its range, it seems not unreasonable to suppose that *johnsoni* from Jamaica may have originated from some continental ancestral stock of the *glycerium* stem.

A summary of the facts as observed shows that the closely connected species, assembled in group II and then divided into three sections by their genital structures, contain three widely distributed species one of which occurs in each section.

Anaea ryphea, the single species with no close associates, in section 1, is most wide spread from Mexico to temperate South America.

Anaea eurypyle of section 2 ranges from equatorial Brazil westward, spreading from Bolivia to Colombia and, as the subspecies *confusa*, northward into Mexico. With *eurypyle* in section 2 are associated *sosippus* ranging from Bolivia to Ecuador, *ecuadoralis* confined to Ecuador, and *cratias* from western Brazil, Bolivia and southern Peru. The latter three species thus occur within the range of *eurypyle*.

Anaea glycerium of section 3 occurs in Mexico southward into Colombia and easterly probably through Venezuela as it is recorded from French Guiana. Associated with *glycerium* are *venezuelana* at the south of its range and *johnsoni* in Jamaica as an offshoot at the north.

The study of this group has been based on an examination of many hundreds of specimens from many localities and numerous genital preparations have been made from both sexes. The most useful information obtained concerns variation and the recognition of its nature. There is regional variation, seasonal variation and very marked individual variation; all of which, variously in each species, may affect the wing-shape and the color pattern. The distribution of the various species is also fairly well outlined.

Group III

This might be named the *arginussa* group from the first species described by Hübner. It includes over a dozen *Anaea* names applied to continental species, subspecies and forms of undetermined validity, requiring revision. The species are from small to medium size, with sexes similar, both tailed at M_3 of the hindwings. The forewings of the continental species have the outer margin broadly incurved from apex to tornus, some deeply so, and the inner margin incised near the tornus, some deeply so. The outer edges of both wings are more or less scalloped. The ground-color of continental species is black-brown with a larger or smaller, bright blue, basal area and a more or less extensive row of marginal or submarginal, blue (or white) spots. The underside has a generally similar pattern in all species but subject to great individual variation in definition.

The Antillean representatives of this group differ in having the outer margin of the forewings nearly straight, the inner margin broadly but slightly incurved within the tornus and the ground-color brown of various tones.

The male genitalia are distinctive with the gnathos extending ventrad and bridged by a narrow sclerite. The harpé has tubercles upon the upper surface of its outer lobe. The outline of the tegumen in dorsal view varies markedly between species.

The continental species are found in Mexico and Central America and throughout tropical South America. The Antillean species range spottily throughout the Greater and Lesser Antilles. All of these are closely affiliated with one continental species, *pithyusa*.

Anaea pithyusa (R. Felder) (Figs. 38–41).

- 1869, *Nymphalis pithyusa* R. Felder, Verh. zool.-bot. Ges., XIX, p. 473.
- 1884, *Anaea pithyusa* Godman and Salvin, Biologia Rhop., I, p. 345, Pl. 32, Figs. 7, 8.
- 1916, *Anaea pithyusa* Röber, Macrolep. World, V, p. 584, Pl. 118f.
- 1935, *Anaea pithyusa morena* Hall, Entom., London, LXVIII, p. 224.
- 1938, *Anaea pithyusa* Field, Ent. News, XLIX, p. 28.

Although widely distributed in South America, *pithyusa* was described from Potrero, near Cordova, Mexico and is found throughout Central America. There is an interesting northern record of it from Kenedy Co., Texas by Field.

The normal species is black-brown on the upperside with a slight, bright blue suffusion extending from the wing-bases. A row of submarginal blue spots extends across the forewings and a few white points occur near the tail. Normal females are duller than the males and brownish specimens occur which approach female form *morena* Hall with brownish-white spots on the forewings, a brownish basal dusting and a large dull fulvous discal area of the hindwing suggestive of *verticordia*. This form was described from Cayenne but it is generally distributed. A specimen from S. Pedro de Norte, Nicaragua, is typical.

The transition from blue-colored continental *pithyusa* to the various brown Antillean species is shown by the brown female form *morena*. The genital structures bear out the relationship (Figs. 38–45).

Anaea echemus (Westwood and Hewitson) (Figs. 42, 43).

- 1850, *Cymatogramma echemus* Westwood and Hewitson, Genera Diur. Lep., II, p. 316, Pl. 49, Fig. 4.
- 1857, *Megalura poeyi* Lefebvre, Sagra, Hist. Cuba, VII, p. 562.
- 1900, *Anaea echemus*, Sharpe, P. Z. S., London, p. 199.
- 1916, *Anaea echemus*, Röber, Macrolep. World, V, p. 583, Pl. 118d.
- 1935, *Anaea verticordia echemus* Bates, Butt. Cuba, p. 185.

The description consists of a figure of a female (British Museum, type No. 10364) reputedly from Honduras. Lefebvre described the male as *poeyi* from the neighborhood of Havana, Cuba. As the species is well distributed in Cuba, that island may be accepted as its proper home. It has also been taken at Nassau, Bahamas (Sharpe).

Anaea echemus is quite variable in size, upperside coloring and underside marking. The type female has a length of forewing of 31 mm. The basal half of the forewing is orange-brown and the apical half black-brown but paler along the outer margin. The hindwing is orange-brown except for a small apical patch of black-brown. On the underside a pattern like *pithyusa* may be traced but it is obscured by an overall design of fine brown and white striations. An anal patch extending beyond M_3 in the hindwing is plain yellow-green with black spots between M_3 and Cu_1 and Cu_2 . The red color of the type figure is too deep. In the series of specimens available for study the actual type specimen stands out as more strongly colored than most males and females which do not have so large or so bright an orange-brown area. Males are smaller than the females and average darker. The underside pattern of both sexes is highly variable, some show a strongly marked pattern like *pithyusa*, others have this completely lost in an overall effect of striations. The male genitalia show a close relation to *pithyusa*.

There is a difference in the forewing shape noticeable in our series of specimens which suggests that this species also develops seasonal forms.

Anaea verticordia Hübner (Figs. 44, 45).

1823, *Papilio hypermnestra* Dalman, Anal. Entom., p. 42.

1827, *Anaea verticordia* Hübner, Zut. Samml. exot. Schmett., III, p. 35, Figs. 559, 560.

1871, *Papilio hypermnestra* Kirby, Syn. Cat. Diur. Lep., p. 637.

1884, *Anaea verticordia* Godman and Salvin, Biologia Rhop., I, p. 355.

1916, *Anaea verticordia* Röber, Macrolep. World, V, p. 583.

Dalman described *hypermnestra* without locality. Kirby leaves this name unlocated. Dalman's description is clear and well

defines *verticordia*, but *Papilio hypermnestra* is a homonym and cannot be used, so *verticordia* is valid.

Hübner described and figured *verticordia* giving the locality as "Havannah." His information would seem to be incorrect for there is no known record of this species from Cuba, whereas it is well known from Hispaniola and his figures fit the usual male occurring there. Therefore *verticordia* is used to denominate the Hispaniola population.

Anaea verticordia though of larger size and different color on the upperside, closely resembles *pithyusa*. The forewing marginal row of five spots appears similarly placed, and also the spots in the anal area of the hindwing. On the underside the variable pattern, as in *echemus*, follows *pithyusa*. The dimorphic female *morena* is the obvious connecting link.

The male genital structure of *verticordia* shows its close relationship to *echemus* and *pithyusa* and also its specific validity (Figs. 44, 45).

***Anaea verticordia dominicana* Godman and Salvin.**

1884, *Anaea dominicana* Godman and Salvin, P. Z. S., London, p. 316.

1916, *Anaea verticordia dominicana* Röber, Macrolep. World, V, p. 583, Pl. 118d.

This was described as a species from Dominica but was correctly placed as a subspecies by Röber. The figure given by Röber is misleading because the dark brown apical and marginal marking is much heavier than the type or in any specimen of our long series. The male genitalia of *dominicana* and *verticordia* are the same.

***Anaea verticordia luciana* Hall.**

1929, *Anaea verticordia luciana* Hall, Entom., London, LXII, p. 133.

The type localities are given as St. Lucia and Martinique and both the type and our specimens from Martinique show a more heavily marked butterfly than *dominicana*. The apical brown area of the forewing is more extensive, extending further towards the base. The five marginal spots are more evident than in

dominicana but not as large or as well defined as in *verticordia*. The male genitalia are the same as *verticordia*.

Anaea pleione (Godart).

1819, *Nymphalis pleione* Godart, Enc. Méthod., IX, p. 336.

Godart says of this:—"We suspect that it inhabits the Antilles." The description is sufficiently enlightening to make it certain that *pleione* belongs to the *verticordia* group but it does not fit exactly any of the butterflies available to us. Therefore *pleione* is placed tentatively as a species.

Hypna clytemnestra (Cramer).

1779, *Papilio clytemnestra* Cramer, Pap. Exot., II, pp. 61, 148, Pl. 137, A, B.

This species has been included in the genus *Anaea* through its subspecies *iphigenia* Lucas, which occurs in Cuba, by Bates (1935, Butt. Cuba, p. 183).

The forewing neuration suggests this but the structure of the male genital armature raises a doubt. This armature differs from that of any *Anaea* with which the authors are familiar and a varied selection has been examined. Without more extended study of the species of *Anaea* and species placed in other closely associated genera, *clytemnestra* cannot be accurately placed. It would seem best therefore for the present to leave it in the genus *Hypna*.

Summary

This study includes all the species of *Anaea* so far known from the Greater and Lesser Antilles. The relationships of the various butterflies to each other and also their relationships to continental butterflies are shown. The taxonomy of the island species is cleared of some misconceptions and a step taken toward clearing problems which exist with the numerous continental species of this large genus.

With more definite placing of the related insular and continental species there is a better understanding of their geographical distribution. This gives a broader application to the facts obtained and adds a small quota to the accumulated knowledge of

the origins of the fauna of the Antilles. All evidence points to an origin of the various island populations from the Central American mainland and not from South America through the Lesser Antilles. Only one species extends markedly into the Lesser Antilles and the evidence is that this has spread from the Greater Antilles and came originally from Central America. In all cases, whether a continental species is considered to be the actual ancestor or was itself derived from some primitive stock there, the corresponding island species or subspecies is closely related although occurring as a definitely modified population. The evidence as a whole is of zoögeographical interest. The maps for each group, prepared from the records of specimens determined or considered reliable by us, give the approximate distributions of the species.

For those interested in pursuing the subject of distribution further, the following references will be useful.

- ANTHONY, H. E. 1925. Mammals of Porto Rico, Living and Extinct, etc. Sci. Survey of P. R. and Virgin Isl., IX, Parts 1-2, N. Y. Acad. Sci.
- DALY, R. A. 1935. The Changing World of the Ice Age. New Haven: Yale Univ. Press.
- DARLINGTON, JR., P. J. 1938. The Origin of the Fauna of the Greater Antilles, etc. The Quarterly Review of Biology, XIII, No. 3, pp. 274-300.
- GLICK, P. A. 1939. The Distribution of Insects, Spiders, and Mites in the Air. U. S. Dept. Agri., Tech. Bull. No. 673.
- LUTZ, FRANK E. 1915. List of Greater Antillean Spiders with Notes on their Distribution. Annals N. Y. Acad. Sci., XXVI, pp. 71-148.
- MATTHEW, W. D. 1939. Climate and Evolution, 2nd ed., rev. and enl., arranged by E. H. Colbert. N. Y.: N. Y. Acad. Sci.
- SCHUCHERT, CHARLES. 1935. Historical Geology of the Antillean-Caribbean Region. N. Y.: John Wiley & Sons, Inc.

Taxonomic list of the species, subspecies, forms and synonyms

ANAEA

Group I

andria Scudder, Mississippi basin.

ops (Druce).

form dry, **andriaesta** Johnson and Comstock.

aidea aidea (Guérin), North and Central America.

form wet, **morrisonii** (Edwards).

appiciata Röber.

morrisoni Holland.

aidea cubana (Druce), Cuba.

aidea floralis Johnson and Comstock, Southern Florida.

form dry, **floraesta** Johnson and Comstock.

troglogyta troglogyta (Fabricius), Hispaniola.

troglogdita (Fabricius).

troglogyta portia (Fabricius), Jamaica.

astina Hübner.

troglogyta borinquenalis Johnson and Comstock, Puerto Rico.

troglogyta astina (Fabricius), St. Thomas, St. Croix, Virgin Islands.

astinax (Cramer).

astianax (Cramer).

agathon (Dalman).

troglogyta minor Hall, St. Kitts.

Group II

Section 1

ryphea (Cramer), Mexico to Bolivia and Paraguay.

form dry **phidile** Hübner.

erythema (Bates).

ab. *albomaculata* Neustetter.

Section 2

sosippus (Hopffer), Ecuador and Peru.

form wet, **rutilans** (Butler).

ecuadoralis Johnson and Comstock, Ecuador.

euryppyle euryppyle (C. & R. Felder), Colombia to Bolivia.

euryppyle confusa Hall, Mexico to Panama.

cratias (Hewitson), Bolivia, Peru and Brazil.

ornata Röber.

Section 3

glycerium (Westwood and Hewitson), Mexico to Colombia.

helie (Clerck).

venezuelana Johnson and Comstock, Venezuela.

johnsoni Avinoff and Shoumatoff, Jamaica.

Group III

pithyusa (R. Felder), Central and South America.

form ♀ **morena** Hall.

echemus (Westwood and Hewitson), Cuba.

poeyi (Lefebvre).

verticordia verticordia Hübner, Hispaniola.

hypermnestra (Dalman).

verticordia dominicana Godman and Salvin, Dominica.

verticordia luciana Hall, St. Lucia, Martinique.

pleione (Godart), Antilles?

The proposal of new seasonal form names, the use of existing form names and the relegation of certain names previously considered specific to the status of forms is done with full recognition of the questionable validity of this action. Strictly these names may be considered as synonyms as they merely denote a broodal difference in the same species.

In the drawings the often heavy distal and ventral spining of the harpés is omitted because the desire was to make as clear as possible the underlying structure. In each case the most distinctive portions of the genital structure are figured to show the differentiation of the species or subspecies. For instance, in the eight species figured from No. 20 to 37 the gnathos give the most definite characters of difference though not the only ones. In the three species figured from No. 38 to 45 the gnathos show very slight differences but on the other hand the dorsal views of the tegumen give excellent characters.

All drawings were made by Miss Alice Gray from dissections in alcohol.

PLATE VIII

Figures 1-5. *Anaea andria andriaesta* Johnson & Comstock ♂, Mobile, Alabama, September 3, 1925.

1—left lateral view of male genital armature.

2—ædeagus.

3—inside end of left harpé.

4—dorsal view of tegumen.

5—ventral view of gnathos.

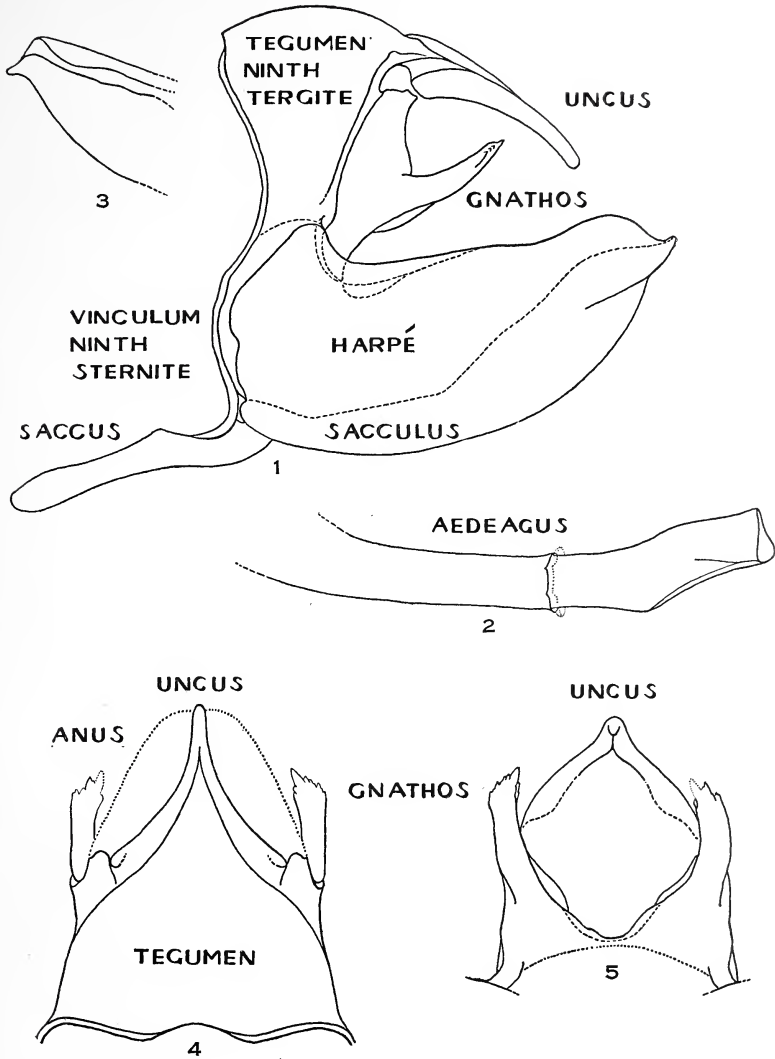

PLATE IX

- Figures 6, 7. *Anaea aidea* (Guérin) ♂, Mexico. (In general the male genital armature is very similar to *andria*, Fig. 1.)
6—inside end of left harpé.
7—ventral view of gnathos.
- Figures 8, 9. *Anaea aidea cubana* (Druce) ♂, San Carlos Est., Guantánamo, Cuba, March 20, 1908.
8—inside end of left harpé.
9—ventral view of gnathos.
- Figures 10, 11. *Anaea aidea floridalis* Johnson & Comstock ♂, Biscayne Bay, Florida.
10—inside end of left harpé.
11—ventral view of gnathos.
- Figures 12, 13. *Anaea troglodyta* (Fabricius) ♂, Barahona, Republic Dominica, July 22-26, 1932.
12—left lateral view of male genital armature.
13—ædeagus.

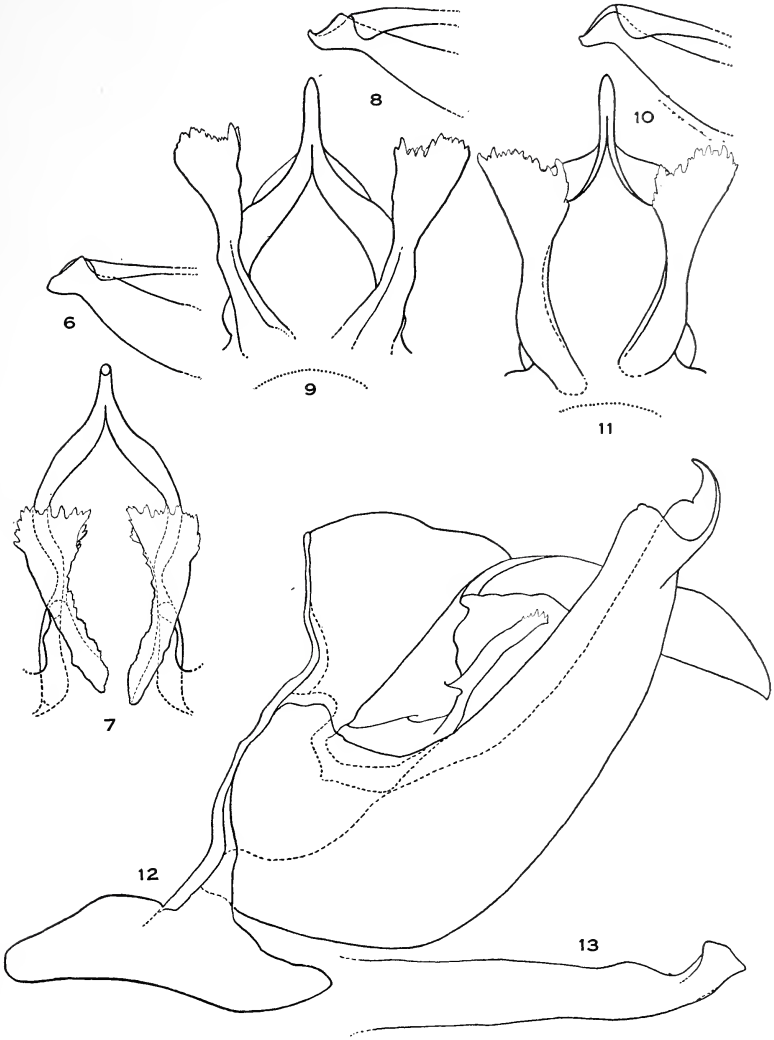

PLATE X

- Figures 14, 15. *Anaea troglodyta borinquenalis* Johnson & Comstock ♂, Guayanilla, Puerto Rico, July 22, 1914.
 14—left gnathos, lateral view.
 15—right gnathos, ventral view.
- Figures 16, 17. *Anaea troglodyta astina* (Fabricius) ♂, St. Croix, Virgin Islands, March 7, 1925.
 16—left gnathos, lateral view.
 17—right gnathos, lateral view.
- Figures 18, 19. *Anaea troglodyta portia* (Fabricius) ♂, Milk River, Clarendon, Jamaica, January 8–12, 1920.
 18—left gnathos, latero-ventral view.
 19—right gnathos, lateral view.
- Figures 20–22. *Anaea eurypyle confusa* Hall ♂, Mexico.
 20—left lateral view of male genital armature.
 21—ædeagus.
 22—ventral view of gnathos.
- Figures 23, 24. *Anaea ryphea* (Cramer) ♂, Colombia.
 23—outside, left harpé.
 24—ventral detail, gnathos.
- Figures 25–27. *Anaea glycerium* (Westwood & Hewitson) ♂, Cordoba, Mexico.
 25—outside, left harpé.
 26—ventral detail, gnathos.
 27—ventro-cephalic detail, gnathos.
- Figures 28, 29. *Anaea sosippus* (Hopffer) ♂, Rio Huallaga, Peru, December 12, 1925.
 28—outside, left harpé.
 29—ventral detail, gnathos.
- Figures 30, 31. *Anaea ecuadoralis* Johnson & Comstock ♂, Oriente, Ecuador.
 30—outside, left harpé.
 31—ventral detail, gnathos.
- Figures 32, 33. *Anaea cratias* (Hewitson) ♂, Bolivia.
 32—outside, left harpé.
 33—ventral detail, gnathos.

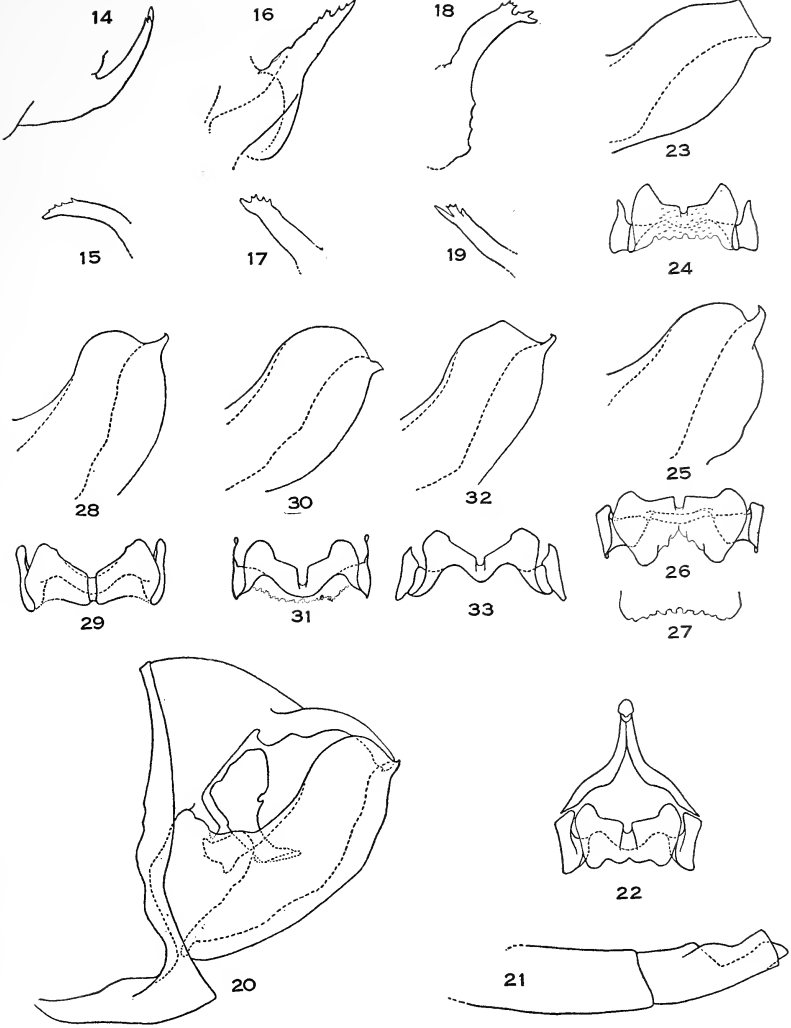

PLATE XI

- Figures 34, 35. *Anaea venezuelana* Johnson & Comstock ♂, Caracas, Venezuela.
34—outside, left harpé.
35—ventral detail, gnathos.
- Figures 36, 37. *Anaea johnsoni* Avinoff & Shoumatoff ♂, Jamaica.
36—outside, left harpé.
37—ventral detail, gnathos.
- Figures 38–41. *Anaea pithyusa* (R. Felder) ♂, Mexico.
38—left lateral view of male genital armature.
39—ædeagus.
40—ventral view of gnathos.
41—dorsal view of tegumen.
- Figures 42, 43. *Anaea echemus* (Westwood & Hewitson) ♂, Cuba.
42—left lateral view of male genital armature.
43—dorsal view of tegumen.
- Figures 44, 45. *Anaea verticordia* Hübner ♂, Port-au-Prince, Haiti, February 19–28, 1922.
44—left lateral view of male genital armature.
45—dorsal view of tegumen.

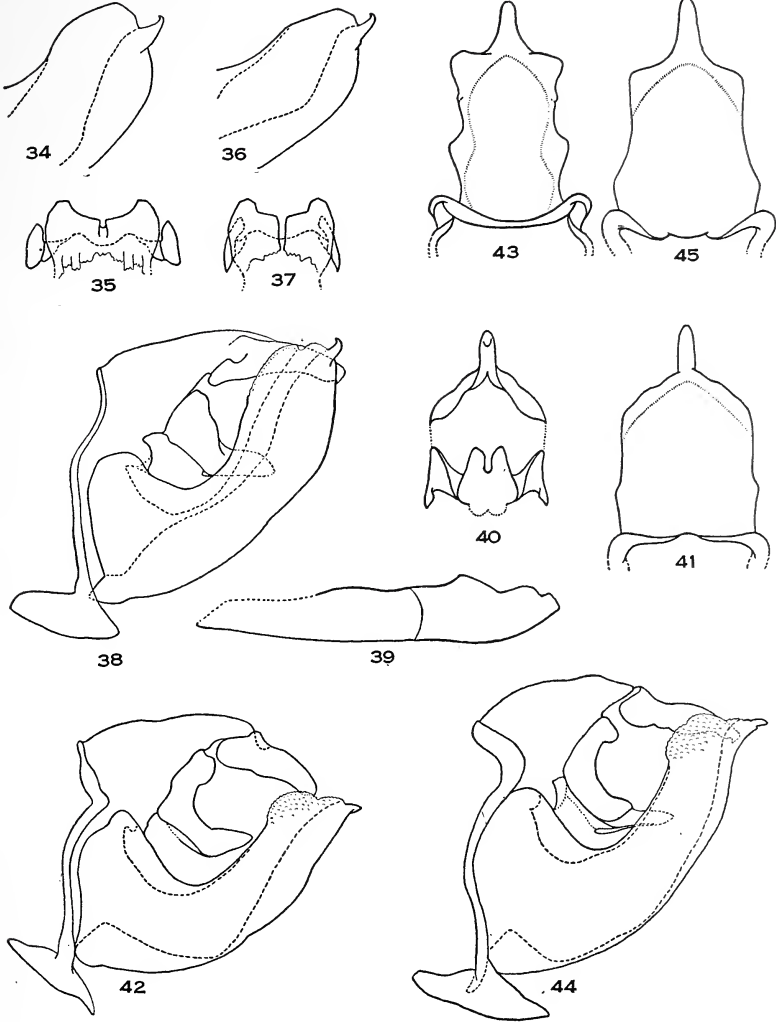

PLATE XII

Map 1. Group I.

One species, *andria* (vertical lines), is endemic in the Mississippi basin. Another species, *aidea* (vertical dashes), slightly overlaps *andria* in the north and extends southward into Guatemala and Honduras. This species appears again in Cuba as *aidea cubana* and in southern Florida as *aidea floridalis*. The third species, *troglogyta* (diagonal lines), is endemic in the islands producing subspecies in Jamaica, Hispaniola, Puerto Rico, Virgin Islands and St. Kitts.

Map 2. Group II.

Section 1; *Anaea ryphea* (vertical lines) is a dominant species of very extended range from Mexico to 25° south in South America.

Section 2; *Anaea eurypyle* (vertical dashes) is a dominant species extending from Mexico to Bolivia and Paraguay. Within its range *sosippus* (horizontal dashes) occurs in Colombia, Ecuador and Peru, *ecuadoralis* (right diagonals) in Ecuador, and *cratias* (left diagonals), overlaps its range in Peru and Bolivia and is detached in eastern Brazil.

Section 3; *Anaea glycerium* (vertical dots) is a dominant species extending its range from Mexico to the northern coast of South America. Within its southern range *venezuelana* (horizontal dots), occurs in central Venezuela and detached from its northern range *johnsoni* (horizontal dots), occurs in Jamaica.

Map 3. Group III.

Anaea pithyusa (vertical lines) extends from Mexico into temperate South America with form *morena* occurring at least in its northern range. *Anaea echemus* (left diagonals), is found in Cuba and Nassau, Bahamas. *Anaea verticordia* (right diagonals), seems confined to Hispaniola but with subspecies *dominicana* in Dominica and *luciana* in St. Lucia and Martinique.

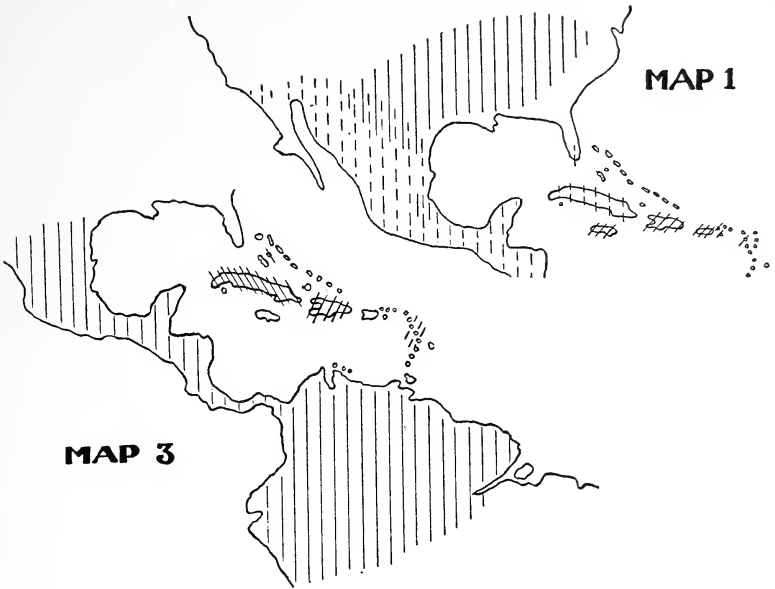

RECORDS AND DESCRIPTIONS OF NEOTROPICAL
CRANE-FLIES (TIPULIDÆ, DIPTERA), XIII

BY CHARLES P. ALEXANDER

AMHERST, MASSACHUSETTS

The preceding part under this general title was published in June, 1941 (JOURNAL OF THE NEW YORK ENTOMOLOGICAL SOCIETY, 49: 139-148). The species considered herewith were taken at and near Potrerillos, "The Valley of the Clouds," in Chiriqui, northern Panama, by Messrs. D. V. Brown and J. W. MacSwain, to whom I am indebted for this rich material. All types are preserved in my personal collection of these flies.

Genus *Limonia* Meigen***Limonia (Limonia) vorax*** new species.

Belongs to the *apicata* group; antennæ (male) elongate, conspicuously nodulose, the flagellar segments heart-shaped, with long apical necks; wings strongly tinged with brown, the oval stigma darker brown; male hypopygium with the lobes on mesal face of basistyle small; dististyle complex, strongly constricted before the beak which is split into three distinct lobes; apical crest of dististyle with a comb of about fifteen teeth; gonapophysis with mesal-apical lobe stout and broad.

MALE.—Length about 4.8-5 mm.; wing 5-5.5 mm.; antenna about 2.8-3 mm.

FEMALE.—Length about 6.5 mm.; wing 6 mm.

Rostrum and palpi black. Antennæ brownish black, in male elongate and conspicuously nodulose; flagellar segments dilated, cordiform, with long glabrous apical necks; on the outer segments the bases are somewhat narrower but still expanded; terminal segment elongate; flagellar segments provided with a dense white pubescence. In female, antennæ less conspicuously nodulose. Head dark brown.

Mesonotal præscutum brownish yellow laterally, the median area dark brown, expanded behind; scutal lobes dark brown; scutellum pale basally, darkened behind; mediotergite darkened. In some specimens the mesonotum is more uniformly brown throughout. Pleura testaceous yellow, extensively variegated with dark brown, the ventral sclerites paler. Halteres with base of stem yellow, the remainder dark brown. Legs with coxæ and trochanters obscure yellow; remainder of legs brown. Wings strongly tinged with brown, the oval stigma darker brown; veins brown. Venation: *Sc* long, *Sc*₁ ending a short distance before the fork of *Rs*, *Sc*₂ at its tip; *m-cu* close to fork of *M*.

Abdominal tergites dark brown, sternites obscure yellow, the lateral portions darker; hypopygium dark. Male hypopygium with the caudal margin of the ninth tergite broadly emarginate medially, the surface with abundant coarse setæ. Basistyle on mesal face with two relatively small lobes provided with long setæ; near apex of basistyle a further setiferous lobe. Dististyle complex, the main body a globular setiferous lobe, the outer margin with a comb of about 15 teeth; the usual beak portion is set off by a marked constriction, at apex the beak split into three distinct lobes. Gonapophysis with mesal-apical lobe unusually stout and broad, obtuse. Ædeagus narrow at apex.

Holotype, ♂, Potrerillos, altitude 3,500 feet, May 2, 1934 (Brown). Allotopotype, ♀. Paratopotypes, 6 ♂ ♀, altitude 3,000 feet, May 14–25, 1935 (MacSwain); 1 ♂, with the type (Brown).

Limonia (Limonia) vorax is very distinct from the other described members of the *apicata* group, especially in the elongate nodulose antennæ of the male and in the structure of the male hypopygium. The latter somewhat suggests *L. (L.) rapax* (Alexander) of Peru but the resemblance is not particularly close.

Limonia (Limonia) sica new species.

Belongs to the *apicata* group; general coloration of præscutum obscure yellow with a broad black median stripe; flagellar segments with glabrous apical necks; wings with cell 1st M_2 short-quadrate; male hypopygium with the dististyle single, extended into a slender dagger-like blackened beak.

MALE.—Length about 5 mm.; wing 6 mm.; antenna about 1.7 mm.

Rostrum and palpi black. Antennæ black throughout, relatively long, as shown by the measurements; flagellar segments oval to subcylindrical, with conspicuous glabrous apical necks; terminal segment about one-half longer than the penultimate. Head blackish, sparsely pruinose.

Pronotum brownish black. Mesonotal præscutum with the ground color obscure yellow; a broad median black stripe, widened behind; scutal lobes infuscated, the median area yellow; scutellum brownish yellow to pale brown; mediotergite testaceous yellow, more darkened behind. Pleura obscure yellow, the mesopleura extensively more darkened but not forming a distinct stripe; pleurotergite pale. Halteres with stem yellow, knob brown. Legs with coxæ pale yellow; remainder of legs medium brown, the femora a trifle darker. Wings with a pale brown tinge; stigma oval, a little darker brown; veins dark brown. Venation: Sc long, Sc_1 ending about opposite four-fifths the length of Rs , Sc_2 at its tip; cell 1st M_2 short-quadrate, shorter than any of the veins beyond it; *m-cu* close to fork of M .

Abdominal tergites dark brown; sternites obscure yellow; hypopygium more brownish yellow. Male hypopygium with the tergite relatively extensive, the caudal margin with a conspicuous V-shaped notch; lobes provided

with long coarse setæ. Basistyles slender, the ventro-mesal lobe long and conspicuous, pale, the proximal portion glabrous, the outer end conspicuously hairy; mesal face of style at near midlength further produced into a very low protuberance. A single dististyle, relatively narrow, on outer face of base with a small oval lobe, the outer portion of style extended into a slender dagger-like blackened beak, the tip acute. Gonapophysis with mesal-apical lobe relatively stout, simple, blackened.

Holotype, ♂, Potrerillos, altitude 3,000 feet, May 15, 1935 (MacSwain).

Limonia (Limonia) sica is quite distinct from all other members of the *apicata* group, the structure of the male hypopygium being very different from the most nearly allied forms, as *L. (L.) acuminata* (Alexander).

***Limonia (Limonia) trialbocincta* new species.**

Belongs to the *insularis* group; antennæ with scape light yellow, the remaining segments black; front wide, silvery white; mesonotum brownish black, with a conspicuous white median longitudinal stripe; legs black, the femoral and tibial tips, together with a ring on tarsi, snowy white; wings with a strong blackish tinge, restrictedly patterned with darker brown; abdominal tergites and hypopygium black, sternites dark, the caudal borders of the individual segments pale; male hypopygium with the rostral prolongation of the ventral dististyle long and slender; gonapophysis with mesal-apical lobe broad, the tip obtuse.

MALE.—Length about 6.5 mm.; wing 8–8.2 mm.

FEMALE.—Length about 7 mm.; wing 8.5 mm.

Rostrum and palpi black. Antennæ with scape light yellow, remainder of antennæ black; basal flagellar segments subglobular, passing through oval to elongate; flagellar segments with short apical necks; terminal segment about one-third longer than the penultimate. Front and anterior vertex wide, silvery white; posterior portions of head dark brown.

Pronotum dark brown. Mesonotal præscutum light brown in front and sublaterally, the lateral margins and extensive posterior portions brownish black; posterior sclerites of notum brownish black; a narrow but very conspicuous white longitudinal stripe begins near anterior end of præscutum continued caudad onto the mediotergite; pleurotergite brownish black, paler on ventral portion. Pleura obscure yellowish brown to brown, sparsely variegated. Halteres black, the extreme base of stem yellow. Legs with the fore coxæ dark brown, the remaining coxæ a little paler; trochanters brownish yellow; femora black, the tips narrowly but abruptly snowy white, the amount subequal on all legs and involving about the distal tenth to twelfth of the segment; tibiæ black, the extreme bases whitened, the tips broadly white, the amount about twice as extensive as the femoral tips; basitarsi

black, the extreme tips and remainder of tarsi with the exception of the outer segments snowy white. Wings with a strong blackish tinge, the costal border and outer radial field a little darker; narrow but still darker seams at origin of *Rs*, stigma, cord and outer end of cell *1st M*₂; veins dark brown. Venation: *Sc*₁ ending about opposite three-fifths to two-thirds *Rs*; *R*₂ long; *m-cu* close to fork of *M*. In the paratype, an adventitious crossvein in cell *R*₃ of one wing only.

Abdominal tergites and hypopygium black; sternites dark brown, the caudal borders of the segments pale. Male hypopygium with the caudal margin of tergite gently emarginate. Rostral prolongation of ventral dististyle long and slender, pale, gently arcuated, the oval sensory area close to extreme tip. Spinulæ of outer dististyle small and relatively sparse. Gonapophyses pale, the mesal-apical lobe broad with the tip obtuse.

Holotype, ♂, Potrerillos, altitude 3,000 feet, May 20, 1935 (MacSwain). Allotopotype, ♀, May 25, 1935. Paratopotype, 1 ♂, with the type.

Limonia (Limonia) trialbocincta is readily told from *L. (L.) praeclara* Alexander and other generally similar species by the abruptly whitened femoral tips, additional to the white rings on the tibiæ and tarsi.

***Limonia (Dicranomyia) aurantiothorax* new species.**

General coloration of thorax light orange yellow, unmarked; halteres and legs yellow, the terminal tarsal segments infuscated; ovipositor with cerci short.

FEMALE.—Length about 5–5.5 mm.; wing 6–6.2 mm.

Rostrum relatively long, pendant, obscure yellow; palpi pale. Antennæ with scape yellow; pedicel and flagellum pale brown to brownish yellow; flagellar segments subglobular to short-oval, the outer segments smaller. Head yellow.

Thorax uniform light orange yellow. Halteres yellow. Legs yellow, the terminal tarsal segments infuscated. Wings light yellow, without markings; veins yellow. Venation: *Sc*₁ ending opposite origin of *Rs*; cell *1st M*₂ closed; *m-cu* shortly before fork of *M*; cell *2nd A* narrow.

Abdomen blackened, the color possibly caused by discoloration resulting from included eggs, the caudal borders of the individual segments pale. In a paratype, the caudal borders of the tergites are very extensively pale, restricting the dark color to small basal areas. Ovipositor with the genital segment light yellow; cerci short, subequal in length to the hypovalvæ.

Holotype, ♀, Potrerillos, altitude 3,000 feet, May 5, 1935 (MacSwain). Paratopotypes, 2 ♀♀, May 5–June 2, 1935 (MacSwain).

Limonia (Dicranomyia) aurantiothorax is readily told by the

orange yellow coloration of the thorax, in conjunction with the yellow unmarked wings and the short cerci.

***Limonia (Geranomyia) carunculata* new species.**

General coloration greenish testaceous, the præscutum with a broad cinnamon-brown median stripe; femora obscure yellow, the tips broadly clear yellow, preceded by a much narrower brown subterminal ring; wings yellow with a heavy brown pattern, including a darker and more extensive costal series, the area at origin of *Rs* and fork of *Sc* single or only slightly separated; *Sc* relatively short, *Sc*₁ ending about opposite one-third to one-fourth the length of *Rs*; male hypopygium with the caudal margin of tergite convexly rounded; rostral prolongation of ventral dististyle with two long curved spines arising from the outer angle of a raised sclerotized plate; gonapophyses with mesal-apical lobe long and slender, nearly straight or but gently curved.

MALE.—Length, excluding rostrum, about 5.2–5.5 mm.; wing 6.2–6.5 mm.; rostrum about 3–3.2 mm.

FEMALE.—Length, excluding rostrum, about 6.5–7 mm.; wing 7–7.5 mm.; rostrum about 3.2–3.5 mm.

Rostrum black throughout, elongate, as shown by the measurements; palpi black. Antennæ black throughout; flagellar segments passing through subglobular, oval to elongate. Head behind gray, with conspicuous brown setigerous punctures, the narrow anterior vertex more silvery.

Pronotum yellow above, darkened laterally. Mesonotal præscutum with a broad cinnamon-brown median stripe, the lateral portions broadly more greenish testaceous; posterior sclerites of notum greenish testaceous, the scutal lobes chiefly brown. Pleura pale greenish testaceous. Halteres pale, the knobs darkened. Legs with the coxæ and trochanters greenish testaceous; femora obscure yellow, the tips broadly clear yellow, preceded by a much narrower brown subterminal ring; tibiæ and basal segments of tarsi brownish yellow, the terminal tarsal segments darkened. Wings yellow, the preareolar and costal portions more saturated yellow, with a heavy brown pattern, arranged as follows: Five larger costal areas, the third a common one at origin of *Rs* and fork of *Sc*, in cases barely disconnected into separate areas; cord and outer end of cell *1st M*₂ seamed with brown; a series of marginal dark clouds on veins *M*₃ to *2nd A* inclusive, the last large and conspicuous; a small marginal darkening at midlength of cell *2nd A*; veins yellow, darker in the clouded areas. Venation: *Sc* relatively short, *Sc*₁ ending about opposite one-third to one-fourth the length of *Rs*; *m-cu* close to fork of *M*.

Abdominal tergites light brown, the caudal borders of the segments paler; sternites more uniformly yellow; hypopygium yellow; in female, the abdomen more uniformly pale brown. Male hypopygium with the caudal margin of ninth tergite convexly rounded. Dorsal dististyle a gently curved rod. Ventral dististyle large and fleshy, the rostral prolongation slender; rostral

spines two, long and curved, arising close together but separately from the outer angle of an elevated sclerotized plate. Gonapophysis with mesal-apical lobe long and slender, nearly straight to very gently curved, the tip weakly expanded.

Holotype, ♂, Potrerillos, altitude 3,000 feet, May 5, 1935 (MacSwain). Allotopotype, ♀, altitude 3,500 feet, May 12, 1934 (Brown). Paratopotypes, 2 ♂♂, 2 ♀♀, with the allotype, May 12-14, 1934 (Brown).

Limonia (Geranomyia) carunculata is closest to *L. (G.) eurygramma* Alexander and *L. (G.) deliciosa* Alexander, differing from all described species in the structure of the male hypopygium. The unusually extensive yellow femoral tips, in conjunction with the pattern of the wings and præscutum, is likewise somewhat distinctive.

***Limonia (Geranomyia) fluxa* new species.**

General coloration grey, the præscutum with three narrow brownish black stripes; halteres with dark brown knobs; femora brown, the tips narrowly yellow; wings with a weak brown tinge, the prearcular and costal portions more whitish; stigma oval, darker brown; outer radial field weakly infumated; *Sc* short, *Sc*₁ ending about opposite origin of *Rs*; male hypopygium with the rostral spines arising from a low common tubercle; gonapophyses with the blackened mesal-apical lobe irregularly bilobed.

MALE.—Length, excluding rostrum, about 5 mm.; wing 5.5 mm.; rostrum about 3 mm.

FEMALE.—Length, excluding rostrum, about 6 mm.; wing 6.5 mm.; rostrum about 3 mm.

Rostrum black, elongate, in male exceeding one-half the length of body; palpi black. Antennæ black throughout; flagellar segments subcylindrical. Head brownish black, the anterior vertex and a median stripe on posterior vertex light gray.

Pronotum brownish black. Mesonotal præscutum with the ground color blackish gray, with three narrow but very clearly defined brownish black stripes, the lateral borders of sclerite behind the pseudosutural foveæ infuscated; posterior interspaces more reddish gray; scutal lobes brown, their mesal portion traversed by a brownish black line, the direct caudal prolongation of the sublateral præscutal stripes; median area of scutum lighter gray; scutellum dark, the posterior border paler; postnotum black, sparsely pruinose. Pleura black, sparsely pruinose, the propleura slightly paler. Halteres with stem pale yellow, knob dark brown. Legs with the fore coxæ blackened, the midcoxæ less evidently darkened; posterior coxæ light yellow; trochanters obscure yellow; femora brown, the tips narrowly and somewhat vaguely paling to yellow; tibiæ and tarsi pale brown, the terminal tarsal

segments darker. Wings with a weak brown tinge, the prearcular and costal portions more whitened; stigma oval, darker brown; wing tip in outer radial field somewhat infumated; veins brownish black. Venation: *Sc* short, *Sc*₁ ending opposite origin of *Rs* or approximately so, *Sc*₂ at its tip; *m-cu* at fork of *M*.

Abdominal tergites brownish black, sternites obscure brownish yellow, the subterminal segments darker. Male hypopygium with the caudal margin of ninth tergite shallowly emarginate medially. Ventral dististyle much more extensive than the basistyle, the rostral prolongation moderately long, its apex obtusely rounded; rostral spines two, of moderate length, gently curved, from a low common tubercle near base of prolongation. Gonapophyses with mesal-apical lobe darkened, short and irregularly bilobed, the outer lobe or point longer and more conspicuous than the more obtuse lateral tooth or flange.

Holotype, ♂, Potrerillos, altitude 3,000 feet, May 14, 1935 (MacSwain). Allotopotype, ♀, May 5, 1935 (MacSwain).

Limonia (Geranomyia) fluxa is most similar to *L. (G.) nigripleura* (Alexander) and allies, differing in the coloration of the wings and legs, and especially in the structure of the male hypopygium.

Genus *Elephantomyia* Osten Sacken

***Elephantomyia (Elephantomyia) luteiannulata chiriquiensis* new subspecies.**

FEMALE.—Length, excluding rostrum, about 7.5 mm.; wing 7 mm.; rostrum about 6 mm.

As in typical *luteiannulata* Alexander, of southern Mexico, differing in colorational details. Yellow femoral rings much wider, being one-half broader than the black tips; in the typical form, the black tips are equal to or more extensive than the yellow rings. Dark abdominal rings wide and conspicuous, occupying from one-fourth to nearly one-third the length of the segment.

Holotype, ♀, Potrerillos, altitude 3,000 feet, May 25, 1935 (MacSwain).

Genus *Teucholabis* Osten Sacken

***Teucholabis (Teucholabis) æquinigra* new species.**

General coloration black and yellow; pronotum uniformly yellow; lateral præscutal stripes reaching the lateral margin of sclerite; scutellum and postnotum black; pleura chiefly black; knob of halteres yellow; legs yellow, the tips of femora conspicuously black, the amount subequal on all legs; wings yellow, with two narrow brown crossbands, the wing tip paler brown; abdominal tergites brownish black, sternites dimidiate, brown, with the poste-

rior borders yellow; male hypopygium with the spine of basistyle long, provided with numerous long silken setæ; outer dististyle long and slender, bearing a small lateral spine at near midlength; ædeagus narrow, directly produced caudad into a black spine.

MALE.—Length about 6.5 mm.; wing 6.5 mm.

FEMALE.—Length about 6 mm.; wing 5.5 mm.

Rostrum black, a little shorter than remainder of head; palpi black. Antennæ black throughout; flagellar segments oval. Head in front polished black, the posterior vertex and occiput paling to obscure yellow.

Pronotum yellow. Mesonotal præscutum with the ground color yellow, with three extensive polished black stripes that are narrowly separated by the interspaces; lateral stripes extensive, including the broad lateral margins of the præscutum and crossing the suture onto the scutal lobes; median region of scutum very narrowly pale; scutellum black, the parascutella paler; postnotum black, the suture between pleurotergite and mediotergite paler. Propleura yellow; mesopleura black, the dorsopleural region surrounding the wing root and the meral region paler. Halteres with stem dusky, knob light yellow. Legs with coxæ and trochanters yellow; femora light yellow, the tips rather narrowly but conspicuously black, the amount subequal on all legs and including the distal sixth to eighth of the segment; tibiæ obscure yellow, the tips more narrowly brownish black; basal tarsal segments obscure yellow, the outer tarsal segments passing into black. Wings yellow, the prearcular and costal regions a little clearer yellow; a somewhat sparse brown pattern, including narrow bands at level of origin of *Rs* and at the cord, the former extended more basad in cell *Cu* and vaguely broken at vein *M*; a narrow cloud at outer end of cell *1st M*₂; wing tip very weakly darkened, best indicated by a deeper color of the veins. Venation: *Sc* relatively long, *Sc*₁ extending approximately to opposite midlength of *Rs*, *Sc*₂ shortly beyond the origin of the latter; *R*₂ slightly oblique; cell *R*₂ at margin more than one-half more extensive than cell *R*₄; *m-cu* shortly beyond fork of *M*.

Abdominal tergites brownish black; sternites dimidiate, dark brown, the caudal half of the segments yellow; hypopygium black. Sternal setæ of male greatly reduced. Male hypopygium with spine of basistyle long, strongly curved at base, the apex a long straight spine that is provided with numerous long silken setæ; on outer margin at base of spine with a few microscopic denticles; mesal margin of basistyle blackened and elevated into a weak flange. Outer dististyle a slender pale rod, a little longer than the spine of basistyle; on mesal margin at near midlength with a strong lateral spine; apex of style narrowed into a point. Inner dististyle with outer lobe elongate, the two spinous points thus widely separated by a broad U-shaped incision, the outermost being a curved hooklike blade; a small cylindrical lobe near base of outer lobe. Ædeagus relatively narrow, the apex produced directly caudad into a gently curved black spine.

Holotype, ♂, Potrerillos, altitude 3,000 feet, May 20, 1935 (MacSwain). Allotopotype, ♀, May 7, 1935.

Teucholabis (Teucholabis) æquinigra is very distinct from other Neotropical species. It is apparently closest to *T. (T.) sackeni* Alexander, yet very distinct in the coloration of body, legs and wings, and in the structure of the male hypopygium.

***Teucholabis (Teucholabis) seposita* new species.**

General coloration black and yellow; head dull black; knobs of halteres weakly yellow; legs black, the femoral bases narrowly yellow; wings whitish subhyaline, unmarked except for the small brown stigma; cell 1st M_2 open by atrophy of basal section of M_3 ; male hypopygium with mesal face of outer dististyle bearing a slender basal spine, with a stronger spinous arm beyond midlength.

MALE.—Length about 9 mm.; wing 7.5 mm.

FEMALE.—Length about 9–10 mm.; wing 7 mm.

Rostrum nearly as long as remainder of head, black; palpi black. Antennæ black throughout; flagellar segments oval to subcylindrical, with long verticils. Head dull black.

Pronotum obscure yellow, darker medially and in front. Mesonotal præscutum obscure yellow, with three confluent polished black stripes that leave broad areas of the ground in the humeral and lateral portions and before the suture; lateral præscutal stripes continued caudad across the suture and including the lateral half of each scutal lobe, the broad median region of the scutum yellow; scutellum dull black, the extreme posterior border more reddish brown, parascutella more reddish brown; mediotergite polished black. Pleura black, the pleurotergite more reddish brown to piceous; a broad, more silvery, longitudinal stripe extending from behind the fore coxæ to the base of abdomen. Halteres black, the apex of knob slightly more yellow. Legs with the fore and middle coxæ black; posterior coxæ more reddish; trochanters brown; femora black, the bases narrowly obscure yellow; remainder of legs black. Wings whitish subhyaline, unmarked except for the small, dark brown stigma; veins brown, *Sc* and the prearcular veins pale yellow. Venation: *Sc* long, Sc_1 ending about opposite three-fifths the length of *Rs*, Sc_2 some distance from its tip; R_2 a little longer than R_{2+3+4} ; veins R_4 and R_5 extending generally parallel to one another for virtually their entire lengths, cell R_2 at margin thus being very wide; cell 1st M_2 open by atrophy of basal section of M_3 ; cell 2nd M_2 about one-half longer than its petiole; *m-cu* a short distance beyond fork of *M*.

Abdomen black, the incisures of the sternites broadly yellow, of the tergites more narrowly so; in the female, the yellow pattern less contrasted; hypopygium black. Male hypopygium with the apex of basistyle obtuse. Outer dististyle complex, consisting of a curved rod provided with long coarse setæ, near base on mesal face with a sharp spine; more distally, also on mesal face, with a stronger chitinized arm that is bifid at apex. Inner dististyle short and compact, the outer lobe with conspicuous setæ, the inner lobe or beak irregularly bilobed at apex. Ædeagus near apex produced into a powerful curved spine.

Holotype, ♂, Potrerillos, altitude 3,500 feet, May 12, 1934 (Brown). Allotopotype, ♀, altitude 3,000 feet, May 5, 1935 (MacSwain). Paratopotype, 2 ♀♀, May 5-14, 1935 (MacSwain).

Among the now relatively numerous Neotropical species of *Teucholabis* with cell 1st M_2 of the wings open, the present fly is very distinct in the black legs and unpatterned wings, as well as in the very different structure of the male hypopygium.

Genus *Gonomyia* Meigen

***Gonomyia* (*Lipophleps*) *peracuta conifera* new subspecies.**

MALE.—Length about 3.5-4 mm.; wing 3.6-4 mm.

Differs from the typical form in the details of structure of the male hypopygium. Lateral spines of basistyle shorter, stouter at base and more strongly incurved. Dististyle with conical spine shorter and more slender, only a little longer than the two fasciculate setæ at apex of style.

Holotype, ♂, Potrerillos, altitude 3,000 feet, May 7, 1935 (MacSwain). Paratopotypes, 1 ♂, May 5, 1935; 1 ♂, altitude 1,000 feet, February 8, 1934 (Brown); paratype, 1 ♂, Finca de Parada, altitude 4,450 feet, September 12, 1932 (W. K. A. Lawlor).

Genus *Erioptera* Meigen

***Erioptera* (*Empeda*) *sutrina* new species.**

General coloration dark brown; rostrum yellow; antennæ black; legs brown; wings grayish, the stigma scarcely indicated; Sc_1 ending shortly before midlength of R_s ; R_2 shorter than R_{2+3+4} ; male hypopygium with the outer dististyle blackened, bifid, the inner arm irregularly lobed, bidentate at apex; inner dististyle pale and narrow.

MALE.—Length about 3 mm.; wing 3.3 mm.

Rostrum obscure yellow; palpi brownish black. Antennæ of moderate length, black. Head dark brownish gray, the front paling to brown.

Pronotum dark brown. Mesonotum almost uniform dark brown, the caudal border of scutellum very narrowly pale; lateral pretergites and borders of præscutum pale. Pleura brown, the dorsopleural region darker. Halteres dusky, the base of stem yellow. Legs with the coxæ pale brownish yellow; trochanters testaceous; remainder of legs brown; legs with abundant linear scales, in addition to the setæ. Wings grayish, the prearcular and costal portions a little more yellow; stigma scarcely indicated; veins brown. Venation: Sc_1 ending shortly before midlength of the long, nearly straight R_s , the latter subequal to vein R_4 ; R_2 shorter than R_{2+3+4} ; veins R_3 and R_4 generally parallel to one another on their basal portion, thence diverging so cell R_3 at margin is wider than cell R_2 ; *m-cu* close to fork of M .

Abdomen brownish black, the hypopygium slightly paler. Male hypopygium with the outer dististyle blackened, bifid, the outer arm simple, longer, a little expanded on outer third, the tip subacute; inner arm irregular, the apex bidentate, with a low marginal flange back from the outer tooth; inner margin of style at near midlength produced into a flattened, roughly triangular point. Inner dististyle a narrow, parallel-sided blade, the apex obtusely rounded. Gonapophyses with blades very broad and flattened.

Holotype, ♂, Potrerillos, altitude 3,000 feet, June 2, 1935 (MacSwain).

Erioptera (Empeda) sutrina is quite distinct from the numerous Neotropical species of the subgenus so far made known. As usual in the genus, the structures of the male hypopygium furnish the chief distinguishing characters.

Genus *Molophilus* Curtis

Molophilus (Molophilus) illectus new species.

Belongs to the *plagiatus* group; size small (wing 4 mm. or less); general coloration dark gray; antennæ short, the scape black, the flagellum light brown; halteres dusky; wings with a weak brown tinge; R_2 in transverse alignment with $r-m$; male hypopygium with the basal dististyle long and slender, gently curved from the slightly dilated base, the mesal edge with a fringe of long setæ and inconspicuous low spines; phallosomic plate narrow.

MALE.—Length about 3 mm.; wing 3.7 mm.; antenna about 1.2 mm.

FEMALE.—Length about 3.8 mm.; wing 4 mm.

Rostrum and palpi black. Antennæ (male) with scape black, pedicel and flagellum light brown; in female, antennæ more uniformly darkened; antennæ relatively short, if bent backward about attaining the wing-root; flagellar segments long-oval. Head gray.

Thorax almost uniformly dark gray, variegated by the restricted white anterior lateral pretergites; vestiture of mesonotum long and conspicuous. Halteres dusky, the base of stem restrictedly brightened. Legs dark brown. Wings with a weak brown tinge, the base and costal region a little more yellow; stigmal region more infumated but ill-delimited; veins pale brown. Venation: R_2 in transverse alignment with $r-m$; petiole of cell M_3 about twice the oblique $m-cu$; vein 2nd A sinuous.

Abdomen brownish black, the sternites a trifle brighter. Male hypopygium with the apical beak of basistyle slender, decurved. Outer dististyle with the inner arm slender, more dilated on basal half. Basal dististyle a long, slender, gently curved rod, the extreme base more dilated; mesal edge of style with a fringe of long curved setæ, with interspersed very low teeth, the setæ extending from shortly beyond base of style virtually to apex; outer face of style with a few scattered spines and spinous setæ; apex of style terminating in a small spine. Phallosomic plate unusually narrow, the apex

obtusely rounded, subtended on either side by a pale setiferous lobe. *Ædeagus* stout.

Holotype, ♂, Potrerillos, altitude 3,000 feet, June 21, 1935 (MacSwain). Allotopotype, ♀, June 19, 1935 (MacSwain).

Molophilus (Molophilus) illectus is closest to *M. (M.) pennatus* Alexander, of Mexico, differing especially in the small size and in the coloration of the body and wings. The hypopygial structure is somewhat similar in the two species but the details are distinct. In *pennatus*, the stouter basal dististyle is enlarged and straight on about the basal fourth, thence gently curved, the mesal face with long black spines additional to the long setæ, these spines very different in appearance from those in the present fly.



ABILITY OF THE FIREBRAT TO DAMAGE FABRICS AND PAPER¹

BY JEAN AUSTIN AND C. H. RICHARDSON

IOWA STATE COLLEGE, AMES

The firebrat (*Thermobia domestica* (P.)) is often confused with the silverfish (*Lepisma saccharina* L.) and much of the damage to fabrics and paper caused by these insects is blamed on the silverfish alone. Because the firebrat is also responsible for a great deal of this injury, an investigation was undertaken to test its ability to damage certain fabrics and papers. The experiments, which covered the period from Sept., 1938, to June, 1939, had the following objectives: To determine which of the common fibers used in textiles are preferred by the firebrat under starvation conditions; to study the relative efficiency for extending survival of these fibers; and to consider the ability of the firebrat to survive on a readily eaten paper.

There are numerous records of the damage caused by members of the Lepismatidæ, but few of them refer specifically to the firebrat. Jackson (1886) reported serious injury to heavily-sized paper by *T. domestica*, but stated that unsized paper was not damaged. McDaniel (1921) states that this species has been observed damaging glue and leather. Spencer (1930) writes that *T. domestica* was found in the laundry in the basement of a hospital in Vancouver in Sept., 1928. Adams (1933) observes that firebrats attack laundered clothes for the starch, and have the ability to live upon dry vegetable and animal materials of considerable variety. Twinn (1933) records that *T. domestica* has become increasingly important as a household pest in Canada, particularly in urban sections of Ontario and Quebec, and that it will feed upon artificial silk (rayon) goods. Back (1937) does not distinguish closely between damage caused by *L. saccharina* and by *T. domestica*, but states that they feed upon the sizing in paper, bookbindings, and wall paper, and upon starchy insula-

¹ Journal paper No. J-932 of the Entomology and Economic Zoology Section, Iowa Agricultural Experiment Station, Ames, Iowa. Project No. 136.

tion materials, thin fabrics, particularly rayon, starched clothing, and lace curtains for the starch. Sweetman (1938) also writes that the firebrat feeds on starchy paper and starchy cloth. Hase (1938) discusses the damage to various types of paper by lepismatids but does not consider the work of *T. domestica* specifically. Weiss and Carruthers (1937) furnish much information on the injury to books and documents by lepismatids and provide an excellent bibliography.

At Ames, Iowa, the firebrat has been a nuisance in dormitories, rooming houses, and college buildings because of its attack on paper and cotton, woolen, and knitted silk and rayon materials.

MATERIALS AND METHODS:

The experimental insects used were adults, unselected except that they exceeded 7 mm. in length. They were reared in laboratory cultures under controlled conditions of 38° C. and 70 per cent relative humidity (Adams 1937).

The twenty-five fabrics used included seven kinds of fibers: cotton, jute, linen, ramie, rayon, silk, and wool; and three samples of paper, two filter papers and one typewriter paper. The names and characteristics of these materials follow:

COTTON

Mercerized; bleached, moderately sized, damask weave.

Organdy; bleached, permanent finish, plain weave.

Broadcloth; unbleached, very lightly sized, twill weave.

JUTE

Burlap; unbleached, plain weave, heavy weight.

LINEN

Toweling; unbleached, plain weave, closely woven.

Gauze; unbleached, loosely woven, theatrical gauze.

RAMIE

Unbleached, plain weave. (Ramie is a fiber obtained from the stem of the perennial *Bœhmeria nivea*, and is used as a cotton substitute.)

RAYON

Celanese; plain weave.

Cellulose acetate; plain weave.

Knitted regenerated cellulose.

Regenerated cellulose; plain weave.

Rayons No. 1 to 8; satin weave, heavy weight.

No. 1 to 7 were given a sizing treatment.

No. 1 to 4 were also treated with fluosilicate compounds.

No. 5 was also treated with tetramethylthiuram monosulfide.

No. 6 was also treated with tetramethylthiuram disulfide.

No. 8 was untreated.

SILK

Cultivated; bleached, crepe weave.

Knitted; cultivated.

Wild; unbleached, plain weave.

WOOL

Partly scoured; unbleached, coarse.

Flannel; bleached, twill weave, fine.

Casein and wool fabric; (50 per cent wool, 50 per cent casein)
plaid, twill weave.

PAPER

Filter paper No. 40, Whatman; diameter 12.5 cms., 0.000174
gm. ash.

Filter paper No. 41, Whatman; diameter 9.0 cms., 0.0001 gm.
ash.

Medium weight typewriter bond paper; white, 16 pound.

Each experiment consisted of a series of ten insects, each insect in an individual open shell vial 25×50 mm. Twenty-four hours of starvation preceded the beginning of each experiment and control, to encourage prompt feeding.

The trays of experimental insects were kept in a constant temperature cabinet maintained at a temperature of 38° C. and 70 per cent relative humidity which were approximately the conditions for maintenance of the cultures.

Each vial of a given experiment contained a piece of the

material, cut with edges as smooth as possible, and weighing approximately 96 mg; the piece was folded or creased transversely and placed on edge in the bottom of the vial.

The conditions for the control series duplicated in every way those for the experimental series, except that a bent strip of light-weight sheet aluminum was inserted to serve as a climbing and resting surface similar to that furnished by the fabric or paper.

There was no actual food in any of the experimental or control vials.

Observations were made every twenty-four hours; only such feeding as was visible to the naked eye was recorded, since microscopic damage was considered to be of little practical significance.

All experiments were replicated, the usual number of replications being 4. The number of insects used in each series of tests is given in Table II.

TABLE I
PROPORTION OF FIREBRATS WHICH FED AND EXTENT OF FEEDING
ON FABRICS AND PAPERS

Material	Percentage of insects which fed	Extent of feeding
Jute	0	None
Wool, partly scoured	"	"
Casein and wool	1-10	Very light
Rayon No. 6	"	" "
Cultivated silk	"	" "
Mercerized cotton	11-20	Very light
Rayons No. 1, 2, 3, 4, 5, 7, & 8	"	" "
Celanese	31-40	Very light
Cellulose acetate	"	" "
Ramie	"	" "
Filter paper No. 40	"	" "
Wild silk	41-50	Moderate
Wool flannel	"	Very light
Cotton broadcloth	51-60	Moderate
Cotton organdy	61-70	Moderate
Linen toweling	"	"
Filter paper No. 41	"	Very light
Knitted silk	71-80	Moderate
Linen gauze	91-100	Heavy
Knitted regenerated cellulose	"	Moderate
Regenerated cellulose, plain weave	"	Heavy
Typewriter bond paper	"	"

RESULTS:

The number of insects feeding on a fabric or paper was calculated on the percentage basis; in addition, the following categories of extent of feeding were recognized: 1. none; 2. very light; 3. moderate; and 4. heavy. These data are presented in Table I.

For each insect the period from time of exposure to the material to the first appearance of feeding was recorded. These

TABLE II
SURVIVAL OF FIREBRATS ON FABRICS AND PAPERS

Experimental materials	Survival on experimental material			Survival on control		
	No. of insects	Mean survival	Range	No. of insects	Mean survival	Range
		<i>Days</i>	<i>Days</i>		<i>Days</i>	<i>Days</i>
Mercerized cotton	50	14	3-24	50	13	1-25*
Cotton organdy	40	14	1-29	40	13	6-29
Cotton broadcloth	50	15	6-27	50	15	8-31
Jute burlap	40	14	6-32	40	12	4-23
Linen toweling	60	16	7-33	60	13	1-32
Linen gauze	40	26	7-76	40	14	3-32
Ramie	40	13	3-25	40	14	6-28
Celanese	40	14	7-29	40	15	2-29
Cellulose acetate	40	14	4-22	40	13	4-26
Knitted regenerated cellulose	40	29†	8-69	40	14	7-21
Regenerated cellulose, plain weave	50	24	5-51	50	15	1-31
Rayon No. 1	40	15	5-30	40	15	6-28
Rayon No. 2	40	17	4-48	40	16	1-37
Rayon No. 3	40	18	6-42	40	18	4-37
Rayon No. 4	40	17	3-39	40	16	4-31
Rayon No. 5	40	18	6-35	40	15	4-31
Rayon No. 6	40	16	5-32	40	14	1-30
Rayon No. 7	40	15	5-23	40	13	3-33
Rayon No. 8	68	16	4-34	50	14	1-33
Cultivated silk	50	16	5-31	50	13	1-26
Knitted silk	40	15	6-36	40	14	6-27
Wild silk	50	14	4-25	50	14	7-25
Wool, partly scoured	50	16	4-34	50	14	1-31
Wool flannel	40	14	7-23	40	14	5-24
Casein and wool	20	14	6-33	20	12	4-26
Filter paper No. 40	80	14	3-33	80	13	1-27
Filter paper No. 41	60	18*	5-42	60	14	3-33
Medium typewriter bond paper	605	34†	1-117	670	14	1-37

* Statistically distinct from the control when probability is 0.05.

† Statistically distinct from the control when probability is 0.01.

figures are of much consequence only for the materials on which a large percentage of insects fed. The mean pre-feeding periods for these four materials are as follows: Linen gauze, 6 days; knitted regenerated cellulose, 4 days; regenerated cellulose, plain weave, 3 days; and typewriter bond paper, 4 days.

Survival data are presented in Table II, with the mean survival period and range in days for each material placed opposite the mean survival period and range for its respective control group. By use of the *t*-test this mean survival period for a given material was compared with that for the control group.

DISCUSSION:

The two fabrics, jute and partly scoured wool (Table I), on which there was no feeding, may have been unattractive to the insects because of the stiff, wiry composition of the fiber. The grease remaining in the partly scoured wool may be an additional factor to help explain its position in the table, for it has not been reported that firebrats have a liking for materials of a fatty nature.

In the next group, in which feeding is very light and the number feeding is small, there are three fabrics, casein and wool, rayon No. 6, and cultivated silk. Although dried milk is used as a food for firebrat cultures, casein as a fiber does not appear to be attractive to this insect. More thorough scouring of the wool does not add materially to the amount of feeding on it. It might be expected that the cultivated silk would be more seriously damaged, since it is a thin fabric, upon which firebrats have been observed to feed (Back 1937). However, this particular sample was of a hard-twist, closely woven thread, and these characteristics probably account for its inclusion in this group.

It was predicted that the mercerized cotton would be placed among the materials seriously attacked for the sizing they contain. However, this material appeared to have little attraction for the firebrat.

While the categories that have been arbitrarily established separate rayon No. 6 from the seven other rayons of the same type, the extent of feeding on the eight samples was practically identical, and the percentage of insects that fed was not great.

Since the eight samples, including the untreated fabric, occupy approximately the same position in the table, it is considered that the heavy, slick texture of the material comprising these rayon samples is the deciding factor in their comparative freedom from attack.

Celanese, cellulose acetate, and ramie, the fabrics on which 31 to 40 per cent of the insects fed and to a very light extent, evidently are those to which slight, occasional damage can be expected.

The tests on filter paper were interesting because of the absence of sizing in this type of paper. Filter paper No. 40 has a thicker, tougher texture than paper No. 41, which probably accounts for the difference in the percentage of feeding. The extent of feeding, classified in both cases as "very light," was difficult to determine because of the possibility of considerable almost invisible surface feeding. The occurrence of such feeding may help to explain the significant difference in survival time between No. 41 and the control which will be discussed later.

Damage to wild silk, cotton broadcloth, cotton organdy, and linen toweling is occasional to rather frequent, and of an extent that would be of some concern where these fabrics are stored in firebrat-infested places for long periods of time. Although this broadcloth was only lightly sized, the starchy material used in sizing probably attracted the insects a very little. The cotton organdy was more attractive, it is suggested, not primarily because of a different sizing given to produce a "permanent finish," but because of the very fine threads which made feeding easier. Linen is possibly the most attractive fiber thus far discussed; and although this sample of linen toweling was a rather heavy, stiff material, the experimental data placed it in a group where more significant damage occurred.

The attacks on knitted silk and knitted regenerated cellulose, observed in 71 to 80 per cent and 91 to 100 per cent, respectively, of the cases and to a moderate extent, represent a more important economic problem than those on any other fabric in this list; for with a knitted material, the cutting of a single thread, as was observed to occur in many instances, causes, after strain, damage to the strength and appearance of the fabric all out of proportion to the original injury.

Linen gauze, regenerated cellulose, plain weave, and medium typewriter bond paper, the three materials upon which feeding was heavy and undertaken by 91 to 100 per cent of the individuals, can be said to be definitely attractive to the firebrat. The points of injury were often numerous and involved a large area. Where linen gauze is used in curtains and draperies, regenerated cellulose, plain weave, is used in wearing apparel, and typewriter bond is the paper for stored records and manuscripts, the presence of firebrats will be a distinct nuisance and will cause severe loss.

Regarding all of these materials, medium typewriter paper, knitted and plain weave regenerated cellulose and linen gauze have been shown to be especially attractive to firebrats, while cotton and silk are attacked if the texture of the material is particularly suitable for feeding, as is the case with cotton organdy and knitted silk. A sizing-free paper is not seriously damaged.

That the firebrat is able to obtain some nourishment from knitted regenerated cellulose and typewriter bond paper is shown by the *t*-test which demonstrates a highly significant difference between mean survival in days on experiment and control (Table II). Survival on regenerated cellulose, plain weave, and on linen gauze was more variable; and the *t*-test failed to reveal significant differences in spite of rather large actual differences between the means. However, there is a close approach to significance, especially for the difference between regenerated cellulose, plain weave and its control. It seems probable that additional experimental data would demonstrate the ability of the firebrat to extend its life on these fabrics. Although mean survival on filter paper No. 41 proved significantly different than the mean survival on the control, the fact that a mean survival of 18 days was reached in one control of smaller sample size (control for rayon No. 3) lends some doubt to the reality of this difference.

SUMMARY:

The damage by *Thermobia domestica* to twenty-five fabrics of seven fibers (cotton, jute, linen, ramie, rayon, silk, and wool) and to three papers (two low ash filter papers and one medium typewriter bond) was investigated.

Medium typewriter bond paper, regenerated cellulose, either knitted or plain weave, and linen were the materials most heavily damaged; cotton and silk were attacked if the texture of the material was very suitable for feeding. The typewriter bond was the only one of the 3 papers tested that was seriously damaged.

The significance of the ability of the firebrat to survive on these materials was tested statistically by comparing data for the survival period on the material with the survival data for the corresponding starvation control. The differences in the mean survival periods were significant for knitted regenerated cellulose and medium typewriter bond paper.

ACKNOWLEDGMENTS:

The writers are indebted to the E. I. Dupont de Nemours and Company, Wilmington, Delaware, for a number of samples of rayon fabrics. To Dr. Rachel H. Edgar, Iowa State College and Dr. E. J. Seiferle, General Chemical Company, New York, N. Y., they acknowledge generous aid.

LITERATURE CITED

- ADAMS, J. A. 1933. A biological investigation of the firebrat, *Thermobia domestica* Packard, (Thysanura). Master of Science Thesis. Iowa State College.
- ADAMS, J. A. 1937. Temperature preference of the firebrat, *Thermobia domestica* (Pack.). Iowa State Coll. J. Sci. 11 (3): 259-265.
- BACK, E. A. 1937. The silverfish as a pest of the household. U. S. Dept. Agr. Farmers Bull. 1665.
- HASE, A. 1938. Zerstörungen von Papierwaren durch Silberfischen (Lepismatiden) und deren Bekämpfung. Anz. Schädlingskunde 14 (4): 37-42.
- JACKSON, R. T. 1886. A new museum pest. Science 7 (178): 481-483.
- MCDANIEL, E. 1921. The silverfish (*Lepisma* spp.). Quart. Bull. Mich. Agr. Expt. Sta. 4 (2): 62-64.
- SPENCER, G. J. 1929. Another household pest arrives in Vancouver, the firebrat, *Thermobia domestica* Packard. Proc. Ent. Soc. Brit. Columbia, 1929, No. 26: 58-60.
- SWEETMAN, H. L. 1938. Physical ecology of the firebrat, *Thermobia domestica* (Packard). Ecol. Monographs 8 (2): 285-311.
- TWINN, C. R. 1934. Ontario Dept. Agr. 64th Ann. Rept. Ent. Soc. Ontario 1933, p. 79.
- WEISS, H. B., AND CARRUTHERS, R. H. 1937. Insect enemies of books. New York Public Library, New York.

BOOK NOTICE

A Lot of Insects. Entomology in a Suburban Garden. By Frank E. Lutz. G. P. Putnam's Sons, New York, 1941. $8\frac{1}{2} \times 5\frac{1}{2}$ inches, xii + 304 p. illustrated. \$3.00.

This book contains a lot of interesting things about insects, things that are not commonly found in our ordinary insect books, things that Dr. Lutz did to insects, and things that he found out about them through observations and experiments. The title does not give any clue to its contents and it would be difficult to think up a short title that would do justice to its varied and entertaining components. To be sure there is an orderly table of contents but it does not reveal the field over which Dr. Lutz ranges, nor the richness which awaits the reader, who is interested in insects, whether he is a professional or amateur entomologist. The author states that his book is largely a story of American Museum of Natural History expeditions and experiments that took place for the most part in his suburban yard, however, the digressions, bits of personal history, and the author's activities, thoughts and entomological philosophy make us forget his "back yard" until he mentions it.

Dr. Lutz is not a bit interested in the destruction of insects and this may be one reason why his book is fascinating to read. However, his style is always lucid and his clear conception leads to clear expression and so the reader's interest is held throughout.

Because of Dr. Lutz's boundless curiosity about insects, we are permitted to enjoy his descriptions, to mention only a few, of butterfly migrations, migratory locusts, ant-lions, the recording of cricket chirps, the effect of supersonic waves upon crickets, the honey bee, ultraviolet and flower visiting insects, ultraviolet flowers, bumble bees, ants, wasps, termites, tiger beetles, the fire-fly's light, fruit flies, the Mendelian formulae, etc., all written from thought provoking and stimulating viewpoints. There is not a dull page in the whole volume.—H. B. W.

EXPERIMENTS ON THE TASTE SENSITIVITY OF
DOLICHOVESPULA ARENARIA FAB. (HYMEN-
OPTERA, VESPIDÆ)

BY ALBRO T. GAUL
BROOKLYN, N. Y.

The following experiments were undertaken to determine the range of acceptable foodstuffs to both adult and larval wasps. A colony of *Dolichovespula arenaria* Fab., was captured at Hartsdale, N. Y., on July 27, 1941. The nest was particularly large for this species, harboring about 200 workers and 75 males.

Individual workers and males were placed in cotton stoppered culture tubes without food or drink for 24 hours. After this period of thirst and fast a pellet of cotton was thoroughly soaked with a test solution and was placed in the tube. If the wasp drank the test material, a positive (×) reaction was recorded; if the solution were rejected, a negative (-) reaction was recorded. It was found that males and workers exhibited the identical taste reactions.

The same test solutions were administered to the larvæ with a pipette. To make uniform test conditions the larvæ were deprived of food and drink for a 24-hour period. However, no difference in reaction was discovered between the thirsty larvæ and those which had received ample attention.

After the administration of some test solutions the larvæ produced their trophallactic secretion, apparently to dilute the irritating solution. It is doubtful if this secretion was not induced by chemoreceptors other than taste. The same solutions produced the same reactions when placed upon the thoracic sternites and out of contact with the mouth. This particular reaction is recorded as double negative (--) in the table.

Each test was tried on three larvæ and three adults. In doubtful and negative cases tests were repeated with eight individuals.

A remarkable contrast is revealed between the range of materials acceptable to the larvæ and those acceptable to the adults. Although most creatures are equipped to distinguish between

TABLE OF TEST MATERIALS SHOWING THE REACTIONS OF THE WASPS TO EACH TEST

Material tested	Larva	Adult
Glycerine, C.P. conc.	x	-
Saccharine (1 grain in 20 drops H ₂ O)	x	-
Sodium chloride (1 Normal)	x	-
Sodium bicarbonate (dilute)	x	x
Benzoic acid (Sat. Sol.)	x	-
Water	x	x
Honey (all dilutions)	x	x
Quinine sulphate (powder)	x	-
Quinine sulphate (Sat. Sol.)	x	-
P. dichlorbenzene (crystal)	x	-
Chromic acid ($\frac{1}{3}$ per cent Sol.)	x	-
Ammonium oxalate (dilute)	x	-
Sodium Hydroxide (.1 normal)	x	-
Citric acid (dilute)	x	-
Chloral hydrate (crystal)	x	-
Maltose (dilute)	x	-
Saccharose (dilute)	x	x
Potassium alum (dilute)	x	-
Strychnine sulphate (crystal)	x	-
Strychnine sulphate (10 per cent Sol.)	x	-
Sodium tetraborate (sat. sol.)	x	-
Ethyl alcohol (70 per cent, denatured)	x	-
Formalin (15 per cent Sol.)	x	-
Mineral oil, light	x	-
Calcium sulphate (powder)	x	-
Acetic acid (1 normal)	-	-
Picric acid (4 per cent sol.)	-	-
Chromic acid (2 per cent)	-	-
Sodium carbonate (dilute)	-	-
Potassium hydroxide (pH 13.5)	--	-
Commercial ammonium hydroxide	--	-
Sodium chloride, crystals	--	-
Nicotine sulphate (dilute)	--	-

toxic and non-toxic materials those wasp larvæ which were offered p-dichlorbenzene, chloral hydrate and chromic acid ($\frac{1}{3}$ per cent) all consumed lethal quantities.

The difference in taste selectivity between the adult and the larva is further emphasized by comparing the pH of their acceptable foods. The larva will drink liquids from pH 1.1 to pH 9.2; it rejects anything more basic than 9.2 and the trophallactic stimulation begins at pH 11.6. The same solutions offered to the adults showed their pH range to be between pH 6.6 and 8.6, anything beyond these limits being rejected.

The disregard of the larvæ for obvious taste differences implies

an absence of taste distinction. By reviewing their life in the nest, it may be seen that the larvæ have no need for any individual sense of taste. All water and food consumed by the larvæ is brought to the nest by a foraging worker; it is usually distributed to nurse workers before it is finally fed to the brood; therefore each bit of food is passed upon by the delicate taste of one or more adults, and the larva could hardly receive harmful materials.

The larvæ need no sense of taste to determine when food is being offered. When they are gently touched upon the head or upon the thorax, they bob their heads about in search of the food. If no food is forthcoming they usually produce a drop of the trophallactic juice; the head and thoracic senses of touch and chemical irritation (if they are distinct senses) seem to stimulate the same motor nerves that in turn stimulate the production of the trophallactic secretion.

It therefore seems likely that the larvæ of *Dolichovespula arenaria* Fab., have no sense of taste and that their food discrimination is delegated to the adults. This tentative conclusion is based upon only one colony and upon a very few test solutions. Much work remains to be done with other social species both in the fields of reactions toward foods and of the determination of actual taste receptors.

THE SYNONYMY OF PAPILIO CORIDON PODA, PAPILIO PHOCION FABRICIUS AND OTHERS

BY E. L. BELL AND W. P. COMSTOCK

Having been confronted with the problem of applying the correct name to the insect usually known as *Perichares coridon* Fabricius (often misspelled "*corydon*"), the authors have assembled all the pertinent references by the early authors involving the various names which have been applied to this insect and the same names given by the same or other authors to entirely different insects. These references are listed below in their chronological order.

The main confusion has arisen from the action of Fabricius in applying the same name to different insects. For instance, he used the name "*phocion*" for three species of *Hesperiidae* and one species of *Satyridae*.

The first name applied by Fabricius to the insect in question is *Papilio coridon* (1775) from Jamaica which is a homonym of *Papilio coridon* Poda (1761). He later changed the name of this insect to *Hesperia phocion* (1793, p. 335) the first usage of this combination and a valid name.

Prior to this he had described *Papilio phocion* (1781) an African hesperid in the modern genus *Ceratrichia*, the first usage of this combination and a valid name.

Unfortunately in the same publication in which he uses *Hesperia phocion* (1793, p. 335) to replace *Papilio coridon* (1775), on a later page he lists the African species he had described as *Papilio phocion* (1781) under the name *Hesperia phocion* (1793, p. 354) which is the second usage of this combination and under ordinary circumstances would be an invalid name.

We take the view that since both *Papilio phocion* (1781) from Africa and *Hesperia phocion* (1793, p. 335) from Jamaica were valid names when published and the insects to which they refer are members of widely separated modern genera and in no way conflict, the action of Fabricius in including them both under *Hesperia* does not invalidate either of them.

Apparently Turton (1806) had one view and Westwood (1852) another; we think both incorrect.

1761, *Papilio* (Plebeji Parvi) *coridon* Poda (Nicolaus)

Insecta Musei Græcensis, etc., p. 77, No. 48.

This is a valid species in the Palearctic fauna, *Lycæna coridon* (Poda), 1909, Seitz, Macrolep. World, I, p. 315, Pl. 81 c, d.

1763, *Papilio coridon* Scopoli (I. A.)

Entomologia Carniolica, etc., p. 179.

This is a reference to *P. coridon* Poda from "Carniolia calidiore."

1775, *Papilio* (Plebeji Urbicolæ) *coridon* Fabricius

Systema Entomologiæ, p. 533, No. 385. "Jamaica."

This is a hesperid and the type of the genus *Perichares* Scudder. The name is a homonym of *P. coridon* Poda (1761).

1781, *Papilio coridon* Cramer

Pap. Exot., IV, p. 97, Pl. 340 C, D, E. From Cape of Good Hope and coast of Coromandel.

Butler (1869, Cat. Diur. Lep. desc. by Fabricius, etc., p. 162) places this name as a synonym of the Old World Lycænid *Castalius rosimon* Fabricius (1775). The name is a homonym of *P. coridon* Poda (1761).

1781, *Papilio* (Plebeji Urbicolæ) *phocion* Fabricius

Species Insectorum, II, p. 138, No. 642. From "Africa æquinoctiali."

Butler (1869, *loc. cit.*, p. 274) erects the genus *Ceratrichia* with *nothus* Fabricius as genotype and includes *phocion* Fabricius (1781) in the genus. This is a valid name.

1787, *Papilio* (Plebeii Rurales) *corydon* Fabricius

Mantissa Insectorum, II, p. 74, No. 693. From "Austria."

The following references are given:

"Papilio Corydon Wien, Verz. 184. 10.

"Papilio Corydon Esp. pap. tab. 33. fig. 4.

"Papilio Tiphys Esp. tab. 51. fig. 4. vix a Fæmina hujus distincta."

Butler (1869, *loc. cit.*, p. 170) cites "Denis" 1776, Schiffermueller, Ignatz und Denis, Johann N. C. M., Systematisches Verzeichniss der Schmetterlinge, etc., Wien. and "Esper, Eur. Schmett. i, pt. 1. pl. 33, fig. 4 (1777)." These references all apply

to *P. coridon* Scopoli (1763) and thus to *P. coridon* Poda (1761), the name being misspelled "*corydon*."

1787, *Papilio* (Plebeii Urbicolæ) *coridon* Fabricius

Mantissa Insectorum, II, p. 87, No. 790.

This is a relisting of *P. coridon* (1775).

1793, *Papilio* (Satyri) *phocion* Fabricius

Entomologia Systematica, III, Part I, p. 218, No. 683. No locality.

Butler (1869, *loc. cit.*, p. 15) places this butterfly in the genus *Euptychia* giving the locality, United States. Kirby (1871, Syn. Cat. Diur. Lep., p. 55, No. 123) erroneously cites the reference: "Spec. Ins., II, p. 138, n. 642. (1781)." This name is a homonym of *P. phocion* Fabricius (1781). It is replaced by *Neonympha areolatus* Abbot and Smith (1797, *Papilio Areolatus*, Hist. nat. Lep. Georgia, I, p. 25, Pl. 13).

1793, *Hesperia* (Rurales) *corydon* Fabricius

Entomologia Systematica, III, Part I, p. 298, No. 133.

This is a relisting of *P. corydon* (1787, Mant. Ins., II, p. 74, No. 693) under *Hesperia* instead of *Papilio*.

1793, *Hesperia* (Urbicolæ) *phocion* Fabricius

Entomologia Systematica, III, Part I, p. 335, No. 274. From "Jamaica."

Fabricius refers to "*Papilio Coridon*. Mant. Ins. 2, 87, 790" which as above noted is a relisting of *P. coridon* (1775). Thus a new and valid name is given to the Jamaican hesperid. This is the first usage of the combination "*Hesperia phocion*."

1793, *Hesperia* (Urbicolæ) *phocion* Fabricius

Entomologia Systematica, III, Part I, p. 354, No. 345. From "Africa."

This is a relisting of *Papilio phocion* (1781) under *Hesperia*. This is the second usage of the combination "*Hesperia phocion*" but it does not invalidate the original description of the insect under the name *Papilio phocion* (1781).

1798, *Hesperia* (Urbicolæ) *phocion* Fabricius

Supplementum Entomologiæ Systematicæ, p. 431, No. 232. From "America meridionali."

This name is a homonym of *H. phocion* (1793, *loc. cit.*, p. 335, No. 274) and it is placed by prior authors in the synonymy of *Polites themistocles* (Latreille) (1823).

1806, *Papilio* (Hes. Urb.) *julianus* Turton (M. D., William)

A General System of Nature, translations of Linnæus Systema Naturæ, III, Part 2, p. 158.

This is a new name for *Hesperia phocion* Fabricius (1793, *loc. cit.*, p. 335, No. 274) and as it is unnecessary it is a synonym of that name.

1852, *Cyclopides phocæus* Westwood

Doubleday, Westwood and Hewitson, Gen. Diur. Lep., II, p. 521, No. 5.

Westwood proposes a new name:

“Cyclopides

“5. Cycl. Phocæus Westw.

“*Hesperia Phocion* Fabricius, *Ent. Syst.*, III, part I, p. 354, n. 345.

“Not *H. Phocion* *Fab. Op. C.* p. 335, nor *Suppl.* p. 431.”

As the *Hesperia phocion* referred to is valid and the original combination of *Papilio phocion* (1781) is valid, the new name is unnecessary and *phocæus* Westwood becomes a synonym of *Ceratrachia phocion*.

On the basis of the names mentioned (but not including any other synonymy) we list the valid names with their synonymy.

Neonympha areolatus Abbot and Smith

phocion Fabricius (1793, p. 218, No. 683)

Lycæna coridon Poda

Castalius rosimon Fabricius

coridon Cramer (1781)

Ceratrachia phocion Fabricius (1781)

phocæus Westwood

Polites themistocles Latreille

phocion Fabricius (1798)

Perichares phocion Fabricius (1793)

coridon Fabricius (1775)

julianus Turton

INDEX TO NAMES OF INSECTS AND PLANTS
IN VOLUME XLIX

Generic names begin with capital letters. New genera, subgenera, species, subspecies, varieties and new names are printed in italics.

- Anæa
 aidea
 aidea, 305
 cubana, 307
 floridalis, 307
 floræsta, 309
 morrisonii, 305
 andria, 302
 andriæsta, 303
 cratias, 322
 echemus, 328
ecuadoralis, 320
 euryppyle
 euryppyle, 318
 confusa, 319
 glycerium, 323
 johnsoni, 325
 list of species, 332
 pithyusa, 328
 pleione, 331
 ryphea, 317
 sosippus, 319
 troglodyta
 astina, 313
 borinquenalis, 314
 minor, 313
 portia, 312
 troglodyta, 311
venezuelana, 324
 verticordia, 329
 dominicana, 330
 luciana, 330
- Aniulus
 adelphus, 61
 craterus, 61
 dorophor, 61
 prosoicus, 61
- Ants, communal disaffection in, 199
- Ant communities, civil disturbances in, 225
- Aporiaria
 anamesa, 57
 texicolens, 57
- Beauveria
 bassiana, 205
- Behavior, of insects to light, 1, 149
- Bothroponera
 soror, 211
- Brochymena, 113
- Carpenter ant, internal anatomy of, 294
- Carterocephalus
 canopunctatus, 222
 dieckmanni, 221
- Cephenemyia
 jellisoni, 161
- Cicadidæ
 biological and faunistic notes, 165
 of Big Bend region, 165
- Coccids, biology of primitive, 116
- Coleoptera
 additions to N. J. list of, 285
 Elateridæ of Penna., 233
 Indices to keys, 21
 Indices to local lists, 1
- Colony foundation, method of a Ponerine ant, 211
- Courtship, sensory basis of in insects, 217
- Cryptolabis
 nebulicincta, 147
- Culture media, in relation to oviposition, 77

- Culture method for *Beauveria bassiana*, 205
- Diceroprocta
albomaculata, 94
averyi, 93
texana, 91
lata, 91
- Dolichovespula
arenaria, 367
- Drosophila
melanogaster, 77
- Elateridæ, of Pa., 233
- Elephantomyia
luteiannulata
chiriquiensis, 351
- Entomological prehistory, 298
- Erioptera
sutrina, 354
- Ethocyclus*, 58
atophus, 58
- Eurelus
kerrensis, 61
proximus, 62
- Eurymerodesmus
melacis, 59
- Firebrat, damage to fabrics and paper, 357
- Formica
fusca, 227
neocinera, 226
subsericea, 199, 226
- Genitalia
 musculature of, 43
- Geographical distribution of species, 114
- Gnophomyia
digitiformis, 144
stenophallus, 145
- Gonomyia
anduzeana, 141
borburatana, 143
compacta, 140
- peracuta*
conifera, 354
vindex, 142
- Gosiulus
conformatus, 61
- Hakiulus
amophor, 61
- Hypna
clytemnestra, 331
- Insect behavior to light, 1, 149
- Insects, courtship of, 217
- Japanese beetle
 mortality of larvæ, 47
 survival of, 65
- Lasius
niger, 227
- Leng, Charles W., 185
 and the N. Y. Ent. Soc., 189
- Limonia
aurantiothorax, 348
carunculata, 349
fluxa, 350
sica, 346
trialbocincta, 347
vorax, 345
- Lysandra
cormion, 265
- Mallophora
ada, 284
ajax, 275
aria, 276
bassleri, 273
campestris, 274
clavipes, 281
clavitarsis, 282
cora, 280
curiosa, 279
dana, 274
inca, 273
jemima, 279
lucida, 278

- neta*, 283
 new species of, 269
vorax, 278
zita, 282
- Molophilus
illectus, 355
- Myllocerus
castaneus, 138
- Nannaria
ursa, 57
- Neognophomyia
monophora, 146
- New Jersey, Coleoptera new to, 285
- Okanagana
villosa, 95
- Orthoporus
entomacis, 63
flavior, 63
- Ozodicera
striatipennis, 139
- Panorpa
nuptialis, 43
- Papilio
coridon, synonymy of, 371
phocion, synonymy of, 371
- Pennsylvania, Elateridæ of, 233
- Phlebodes
tiberius, 193
conspicuus, 196
obscurus, 197
reticulata, 194
- Platypedia
australis, 95
- Polyxenus
fasciculatus, 57
- Popillia japonica, 47
- Rhabdarona*, 60
bacillipus, 60
- Siphonophora
texascolens, 64
- Species, distribution of, 114
- Spiders, burrowing wolf, 112
- Spirostrephon
texensis, 60
- Stelis
anthidioides, 123
anthracina, 125
ashmeadiellæ, 133
depressa, 127
linsleyi, 129
nigriventris, 132
palmarum, 134
robertsoni, 136
semirubra, 127
trichopyga, 130
- Tarantulas, burrowing, 112
- Taste sensitivity of *Dolichovespula*,
 367
- Teucholabis
aquinigra, 351
nocturna, 143
seposita, 353
- Thermobia
domestica, 357
- Tibicen
bifida, 86
simplex, 88
hidalgænsis, 88
sugdeni, 89
- Utetheisa
galapagensis, 101
- Ziniulus
medicolens, 61

The New York Entomological Society

Organized June 29, 1892—Incorporated June 7, 1893

Certificate of Incorporation expires June 7, 1943

The meetings of the Society are held on the first and third Tuesday of each month (except June, July, August and September) at 8 P. M., in the AMERICAN MUSEUM OF NATURAL HISTORY, 77th Street and Columbus Avenue.

Annual dues for Active Members, \$3.00; including subscription to the Journal, \$4.50.

Members of the Society will please remit their annual dues, payable in January, to the treasurer.

Honorary President, WILLIAM T. DAVIS

Officers for the Year 1941

President, MAX KISLIUK.....Federal Bldg., New York, N. Y.

Vice-President, HARRY B. WEISS.....Highland Park, N. J.

Secretary, ANNETTE L. BACON.....American Museum of Natural History

Treasurer, DR. HERMAN T. SPIETH.....College of the City of New York, N. Y.

Librarian, L. JAMES SANFORD.....American Museum of Natural History

Curator, DR. WILLIS J. GERTSCH.....American Museum of Natural History

EXECUTIVE COMMITTEE

W. T. DAVIS

DR. ALBERT HARTZELL

DR. WM. PROCTER

DR. A. B. KLOTS

FRANK A. SORACI

PUBLICATION COMMITTEE

HARRY B. WEISS

EDWIN W. TEALE

HERBERT F. SCHWARZ

E. L. BELL

PROGRAM COMMITTEE

J. W. ANGELL

M. H. SARTOR

HAROLD HAGAN

AUDITING COMMITTEE

DR. WM. MOORE

DR. W. J. GERTSCH

F. S. BLANTON

FIELD COMMITTEE

DR. A. B. KLOTS

A. S. NICOLAY

WM. P. COMSTOCK

DELEGATE TO THE N. Y. ACADEMY OF SCIENCES

WILLIAM T. DAVIS

JOURNAL

of the

NEW YORK ENTOMOLOGICAL SOCIETY

Published quarterly by the Society at N. Queen St., and McGovern Ave., Lancaster, Pa. All communications relating to manuscript for the Journal should be sent to the Editor, Harry B. Weiss, 19 N. 7th Ave., Highland Park, New Jersey; all subscriptions to the Treasurer, Dr. Herman T. Spieth, American Museum of Natural History, New York, N. Y. Orders for back issues should be sent to the Librarian, L. James Sanford, American Museum of Natural History, 77th St. and Columbus Ave., New York, N. Y. The society has a complete file of back issues in stock. The Society will not be responsible for lost Journals if not notified immediately of change of address. We do not exchange publications.

Terms for subscription, \$3.00 per year, strictly in advance.

Please make all checks, money-orders, or drafts payable to New York Entomological Society.

Twenty-five reprints without covers are furnished free to authors. Additional copies may be purchased at the following rates:

	4 pp.	8 pp.	12 pp.	16 pp.	24 pp.	32 pp.
25 copies	\$2.40	\$5.22	\$5.58	\$5.58	\$9.00	\$9.60
Additional 100's60	1.44	1.92	1.92	3.00	3.00
Covers	50 copies, \$2.00; additional 100's, \$1.50.					
Half-tone prints 1½ cents for each half-tone print.						

Authors whose papers are illustrated with text figures or full page plates will be required to supply the electroplates or pay the cost of making the same by the Journal and also to pay the cost of printing full page plates on coated paper, when advisable.

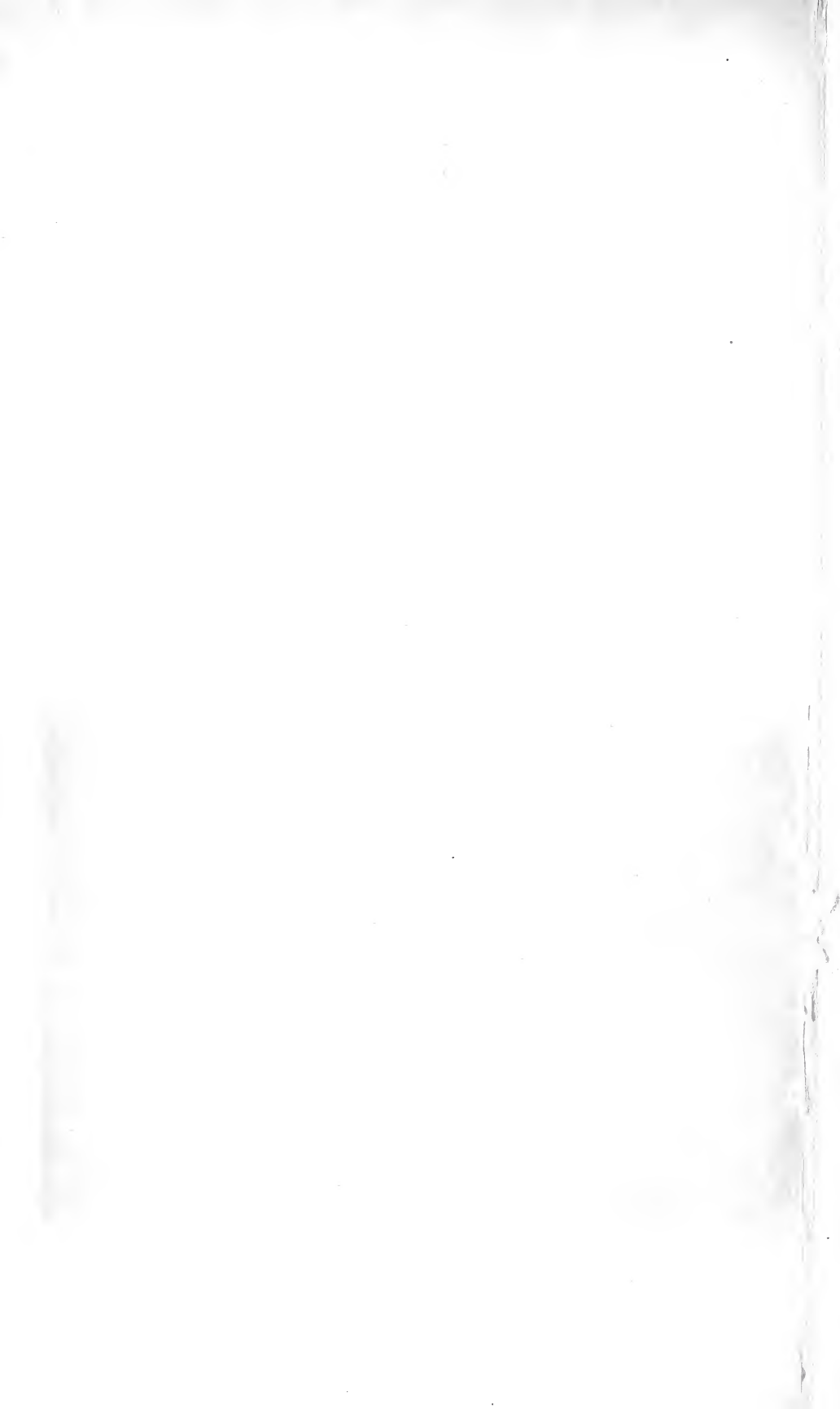



SMITHSONIAN INSTITUTION LIBRARIES



3 9088 00833 6547