















45

# THE JOURNAL

OF THE

# Quekett

# MICROSCOPICAL CLUB.

EDITED BY  
EDWARD MILLES NELSON

SECOND SERIES.

VOLUME V.

1894-1897.

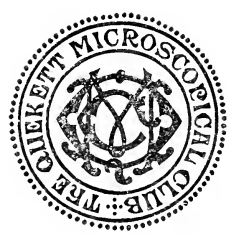
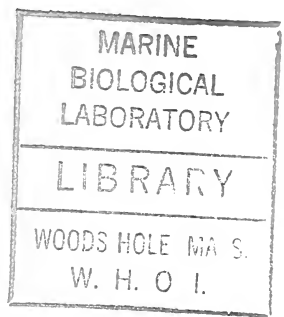

London:

[PUBLISHED FOR THE CLUB]

WILLIAMS AND NORGATE,  
14, HENRIETTA STREET, COVENT GARDEN, LONDON,  
AND 20, SOUTH FREDERICK STREET, EDINBURGH.

PRINTED BY  
HAZELL, WATSON, & VINEY LTD.,  
LONDON AND AYLESBURY.



THE JOURNAL  
OF THE  
Quekett Microscopical Club.

---

THE FOSSIL DIATOMACEE OLDER THAN THOSE OF VIRGINIA AND CALIFORNIA, WHICH ARE OLDER MIOCENE.

BY PROF. ARTHUR M. EDWARDS, M.D., Newark, N.J., U.S.

*(Read December 21st, 1894.)*

I have found Diatomaceæ older than the Lower Miocene, and I desire to place this on record, more especially as they are not developing forms, but identical with those growing at the present time.

As some geologists have expressed a doubt of my finding Diatomaceæ in the Newark-period sandstone of Arlington, N.J., I will state how and when I did so, and trust that others will collect the clay in which they were found, and repeat the discovery. I should say that the Newark-period sandstone is so called by Prof. T. C. Russell, and includes the red sandstones that crop out in New Brunswick, at New Haven, Connecticut, and in which the celebrated tracks were found by the late Prof. Hitchcock, at Newark, N.J., and south into Virginia. It has also been called the Jura-Triassic sandstone, and is supposed to represent the upper part of the Keuper-Sandstein of Germany.

It is now nearly twenty years since I came to reside at Newark. I saw the sandstone and came to the conclusion it must have been formed in shallow pools of fresh water, because the plants found in it were those of the shores of fresh and not salt water; the Mollusca, scarce, of course, were fresh-water forms also. I expected to find the remains of Diatomaceæ if they existed; they had been found in the coal of England, in the Carboniferous coal by Castracane, and in the Tertiary by Ehrenberg and Bailey, but I sought in vain. The fact was I searched only in Newark itself, in the sandstone alone, and not

the red shale that occurs in the sandstone elsewhere. Last summer I examined the shaley sandstone at Arlington, or between Arlington and Kearney, about two miles from Newark, on the opposite or eastern side of the Passaic river, where the clayey or shaley sandstone is intercalated in strata with the ordinary red sandstone. In this clayey shale I found the Diatomaceæ occurring in spots of clay about one inch or less across. The material was cleaned by washing in weak aqua ammonia and subsequent boiling in acids. The species found are as follows:—

*Achnanthes subsessilis*, Ehr. (*Achnanthidium*) *coarctatum*, A. B.

*Amphora ovalis*, Ktz.

*Cocconeis placentula*, Ehr.

*Epithemia turgida*, Ehr.

*Melosira varians*, Ag.

*Nitzschia* (*Hantzschia*) *amphioxys*, Sm.

*Synedra ulna*, Ehr.

*Achnanthes* (*Achnanthidium*) *coarctatum*, A. B., is the same as *Stauroneis constricta*, Ehr., and should be called *Achnanthes constricta*, Ehr. It was found in Chile and Mexico by Ehrenberg, and published by him in the "Abh. Berl. Akad.," the reprint in 1843 being commonly known as the "America." I have seen it only in this preparation from the Newark sandstone. The above are all I have detected up to the present, but a consideration of how the shale originated warrants me in the conclusion that other forms will be discovered when this sandstone is searched more thoroughly, and at other places than Arlington, N.J.

I have found every year, for the last four or five, in a running brook which is fed by the trickling of water down the sandstone, coming from the glacial drift above it, the following diatoms:—*Nitzschia spectabilis*, Ehr., not *N. spectabilis*, W. S., and which includes *N. linearis*, W. S., *N. multifasciata*, Ktz., and *Synedra spectabilis*, Ehr. There is also present a sigmoid form, which looks like *Nitzschia sigmoidea*, Ehr. (= *Navicula sigmoidea*, Ehr., = *Nitz. elongata*, A. H. H., = *Sigmatella Nitzschii*, Ktz). I enumerate these to show they are not the same as those found in the Newark sandstone.

Now I wish to point out the way in which I think the sandstone and shale were formed. There were shales and sandstones

in the Carboniferous period, but I have not examined them as they do not occur here. They were probably deposited in comparatively quiet water of no great depth, and it was *fresh* water, as there are no marine fossils. The Newark sandstone was formed in damp meadows, not marshes, containing pools of water of no great extent or depth; for the Diatomaceæ in it are not the same as now occur in *wet*, but merely *moist* meadows, such as those around Newark, and the same diatoms exist there now in the same circumstances. I think, too, the temperature was the same in the Newark period as in the meadows between Newark and Jersey City at the present time. Ferns grew in the meadows, but no trees, and animal life was scarce. This accounts for the occurrence of shaley sandstone on the top of the red and white sandstone.

Now I have carried the Diatomaceæ down to the Newark period, which is much lower than the Lower Miocene, the Tertiary, to which Virginia, Maryland, New Jersey, and California belong, if indeed they be as old. And I wish to show they are in the Lower Silurian also, the oldest rocks except the pre-Cambrian and Laurentian, in which M. Cayeux found Radiolaria and Sir W. Dawson Foraminifera, viz., the Eozoon. In the Hudson River epoch of the Lower Silurian age I have found Diatomaceæ, and they are of the same forms as occur at the present time. I believe, of course, in evolution, but why certain Mollusca, Foraminifera, and Diatomaceæ have remained unchanged up to now I, of course, cannot tell.

They have been using for ballast and filling at Lyon's Farm, N.J., on the Lehigh Valley railroad, material brought from Jutland, N.J. It consists of shale mixed with slate. The shale is yellowish or reddish, and breaks down readily when exposed to the air; the slate is blue-black in colour. The shale sometimes passes into a yellowish clay, and in it occasionally are spots of white clay. I have examined the latter, and was delighted to find some Diatomaceæ in it. They are fresh-water forms corresponding with those growing in fresh water now, and the species enumerated below are identical with those now found in existing meadows which show no sign at all of evolution. It is well to remember then that as evolution has not affected the Diatomaceæ in all the millions of years since the Hudson River epoch shale was thrown down, we

cannot expect it to affect them now. And we must look for something into which they were developed if we believe in evolution at all. The diatoms here are in small quantity mixed with a high percentage of sand and clay, and in the white clay only; at least I have not been able to find them in the yellow.

I detail the method used in searching for the diatoms, so that observers may see that care has been exercised. Filtered water was always used. The rock is broken in pieces and washed with filtered aqua ammoniæ; this is nearly all poured off, and finely powdered bichromate of potassium added in excess. After a time sulphuric and a small quantity of hydrochloric acid is poured on and let stand for about a quarter of an hour. The whole is washed until colourless, treated with aqua ammoniæ, and again washed. A portion of the deposit is dried on a slide, and a freshly-prepared solution of gum Thus in wood spirit or alcohol added; the slide is then warmed to drive off the spirit, the cover glass imposed and pressed down.

I do not see how foreign diatoms can be introduced in this process unless by the acids, spirit, etc., used, but the forms are always fresh-water ones, and the same solutions and acids have been used to clean and mount marine Diatomaceæ, and no fresh-water forms have been detected amongst the latter. Moreover the valves are often seen involved in the clay. Species identified are:—

<i>Cymbella cistula</i> , Hemp.	<i>Navicula elliptica</i> , Ktz.
<i>Epithemia gibba</i> , Ehr.	„ <i>viridis</i> , Ktz.
„ <i>turgida</i> , Ehr.	<i>Nitzschia scalaris</i> , Ehr.
<i>Fragilaria striatula</i> , Grev.	<i>Stauroneis phœnicenteron</i> , Ehr.
<i>Melosira crenulata</i> , Ktz.	<i>Synedra ulna</i> , Ehr.
<i>Navicula dicephala</i> , Ehr.	Spicules of fresh-water sponge.

I have submitted this material to the examination of a well-known geologist, and he thinks the Diatomaceæ may have been washed in by percolation. I do not see, however, that this can be the case, for the clay was hard and came from the interior of the specimen.

In conclusion I believe the loess was formed in the same way as this, *i.e.*, on large meadows, and not by the wind, in spite of the opinion of Baron Von Richthofen to the contrary. The loess of Germany, China, and America belongs to the Iceberg period.



## SECOND NOTE ON A METHOD OF PRESERVING ROTATORIA.

BY CHARLES F. ROUSSELET, F.R.M.S.

*(Read January 18th, 1895.)*

It is now just two years ago ("Quekett Journal," 1893, Vol. v., p. 205) that I read before you a paper on preserving Rotifers as permanent objects. Since then I have continued my investigations, and have now made such progress and improvements in the method that a second communication on the subject becomes desirable.

The principle of the process, consisting of narcotizing, killing, fixing, and preserving in a watery fluid, not appreciably denser than water, as explained in my first note, remains the same, the improvements being chiefly made in the details of the process and the choice of the fluids.

The first defect which became apparent was a darkening of the specimens, due to the trace of osmic acid remaining in the dilute Flemming's fluid used for preserving; this was soon remedied by omitting the osmic acid in the preservative fluid, and the animals then kept their complexion very much better.

The yellow colour, however, produced by the chromic acid in some animals displeased me very much, as it gave an unnatural appearance to the usually perfectly white, glassy transparent bodies of Rotifers. I made many experiments with a number of different substances to get rid of the chromic acid. The most promising fluid for preserving seemed to be a  $\frac{1}{20}$  per cent. solution of bichloride of mercury, but owing to its liability of forming crystals, which could not be wholly prevented by the addition of a little common salt, I had finally to abandon it, except in a few special cases.

At the beginning of last year I noticed in the German periodical "Biologisches Centralblatt" an article by Dr. Blumm, on Formalin,\* which was said to fix and preserve vertebrate eyes and tissues without shrinkage and fairly transparent. I

\* Formalin, or formol, is a watery (40 per cent.) solution of formaldehyde ( $\text{CH}_2\text{O}$ ), a gaseous substance which is produced when methyl alcohol is subjected to oxidation. It is used as a disinfectant, and instead of alcohol,

procured some of this substance, and soon perceived that it would be very useful for my purpose. Formalin by itself, I find, does not fix the Rotifers at all well, as I was led to expect from the above article; it rather dissolves protoplasmic structures, such as cilia, more or less completely, but it preserves them remarkably well after they have first been fixed with Flemming's fluid or osmic acid, and crystals are never formed. It has the very valuable property of preserving the animals without the least shrinkage or turgescence, and as perfectly transparent as the fixing process leaves them. The thin and delicate lorica of some Rotifers, such as that of *Euchlanis triquetra*, which I had not been able to satisfactorily preserve in any other fluid tried, remains perfect in shape and transparency in formalin. The strength used is  $2\frac{1}{2}$  per cent. in distilled water.

For fixing the Rotifers I have found that osmic acid alone fixes as well as Flemming's fluid; when used strong it darkens the animals, but if a very weak solution of  $\frac{1}{4}$  per cent. or less be used, and allowed to act for a very short time only, half a minute at most, the animals remain white and transparent, excepting only the maturing ova, which become more or less darkened on account of the fat-like substance, lecithine, which they contain. Moreover, if the animals have become coloured a little by the osmic acid the colour can be removed by passing them for a few (1-3) minutes through peroxide of hydrogen.\*

For narcotizing I found the following mixture to give better results than 2 per cent. cocaïn alone:—

2 per cent. solution of cocaïn†	...	3	parts
Methylated spirit‡	...	1	„
Water	... ..	6	„

for preserving museum specimens, is non-poisonous, and very cheap. The solution obtainable in commerce being of the strength of 40 per cent., dilute  $2\frac{1}{2}$  volumes of this with  $37\frac{1}{2}$  volumes of distilled water in order to get the required solution of  $2\frac{1}{2}$  per cent.

\* Peroxide of hydrogen is simply water containing an excess of oxygen, either in loose combination or only in solution, or more probably both; the oxygen is readily given off and bleaches by oxidizing the reduced osmic acid to  $OsO_4$ . This substance does not keep good very long, and it is best to obtain a small quantity at a time and renew it after four or six months.

† Hydrochlorate of cocaïn is a very expensive drug; it is best to procure only one gramme at a time, and dissolve it in 50 c.c. of water, which will give a 2 per cent. solution. As this solution does not keep well I add at once 12 c.c. of methylated spirit, then four parts of this mixture and six parts of water will make the above narcotizing fluid.

‡ I mean the methylated spirit prepared with wood naphtha, not that now generally sold, which is prepared with mineral naphtha, and becomes milky when mixed with water.

It is used by adding first a few drops to the water in which the Rotifers have been placed, then more and more at intervals until the animals are sufficiently narcotized. The different species vary very much in the length of time they require for narcotization; some patients require to be treated very slowly, others very rapidly, to be able to kill and fix them fully extended, and for this reason it is best to treat each species separately. The general rule I follow is to add little of the fluid at first, and then, if the animals continue to expand or swim about, more and more at intervals of a few minutes, until their movements begin to slacken. Most free swimming species, I find, can be killed when still swimming about slowly, but with some it is necessary to wait until the cilia have just ceased beating. A few examples mentioned below will give some more details. In order to ascertain the right moment for killing an animal I have not before prepared, I usually separate one or two individuals, and if these can be killed fully extended with a drop of osmic acid, then the others are also ready. Of course, it is very important to kill and fix the animals before they are quite dead, as swelling and other post-mortem changes begin at once after death.

My process, then, now consists of narcotizing the Rotifers with above cocaïn-spirit mixture, killing and fixing with  $\frac{1}{4}$  per cent. osmic acid for half-a-minute or less, washing out immediately and thoroughly in water for a few minutes to half-an-hour, and finally preserving and mounting in  $2\frac{1}{2}$  per cent. formalin, or, in some cases, in bichloride of mercury and salt solution.

Rotifers with shells having high ridges or mouldings, such as *Euchlanis triquetra*, *Mastigocerca bicristata*, *Metopedia triptera* and *oxyterson*, some species of *Brachionus*, etc., must not be left long in water, as the lorica often swells a little and the ridges and mouldings become more or less obliterated; such species must be washed quickly in water and transferred at once to the formalin, which preserves the shell perfectly.

It is very necessary, in order to avoid greater trouble afterwards and make satisfactory mounts, to transfer the living Rotifers first of all into perfectly clean water, free from any particle of foreign matter, living or dead. I keep some clean filtered pond water, and pick out and transfer the Rotifers into clean cells as many times as may be necessary. Small particles

become readily attached to the cilia of Rotifers when dead, and it is then often very difficult to remove them; for the same reason it is not advisable to mount small species in the same cell with larger ones.

Instead of micro-troughs, as recommended in my first paper, I now use small square blocks of glass, with a hollow ground in and polished, as much more convenient for all the necessary manipulations. These blocks can be placed under the lens of the dissecting microscope,\* or the compound microscope, if necessary, and the animals can be watched more closely, which is indispensable with the smaller species. For the purpose of washing, etc., I transfer the Rotifers from one glass block to another by means of a small and very fine pipette, funnel-shaped at one end, the funnel covered with an india-rubber membrane. I have had such pipettes made of various sizes, and can recommend them as the best yet devised for picking up small animals of all kinds in water.

In killing it is merely necessary to introduce a drop of osmic acid on to the animals under water, and then almost immediately transfer them to some fresh water in another block kept ready, and then again to two or three more lots of distilled water, so as to get rid of all traces of the acid, and finally in  $2\frac{1}{2}$  per cent. formalin.

The following notes will give an idea of the treatment some Rotifers require, and serve in some measure as a guide to the treatment of other species:--

*Stephanoceros and Floscules.*—Although I had been occasionally successful in preparing a few of these Rotifers, I have only quite lately found the means of killing them fully extended with some degree of certainty. I will describe the *modus operandi* with regard to *Stephanoceros*; the *Floscules* must be treated similarly, but are more difficult. Before beginning the operation, cut and trim a very small piece of the weed to which *Stephanoceros* is attached, ready for mounting, and place it in a cell of perfectly clean water; then transfer the animal to a hollow-ground glass slip, the hollow of sufficient size and depth, in three drops of water, to which one drop of the narcotizing fluid has been added. After five minutes the

\* A dissecting microscope of some kind is necessary; my tank microscope, provided with an aplanatic lens of 6 or 10 power, can readily be adapted as a dissecting microscope by screwing it to a suitable stand with arm rests.

animal will have recovered from the first shock, and you can add one more drop of the cocaïn-spirit mixture, and so on, one drop every three minutes, until five drops have been added; wait then ten minutes longer, that is 25 to 30 minutes (not more) from the beginning of the process, and *Stephanoceros* will be ready to be killed with one good drop of  $\frac{1}{4}$  per cent. osmic acid, which is to be placed right on the animal, not run in at the side of the cell. The animal may contract into various shapes during the process, but at the end of the 25 minutes will generally be found fully extended. It is well to place your watch on the table and follow these directions somewhat closely. After half-a-minute, wash out the osmic acid, which must be done very carefully, and mount on the same slip in bichloride of mercury and salt solution. It is not advisable to mount more than one *Stephanoceros* on a slide, or, at least, only one small piece of weed, to which, of course, several animals may be attached.

It must here be stated that the gelatinous cases of *Stephanoceros*, the *Floscules*, and also of *Melicerta tubicolaria* seem to be about the only structures which are not well preserved by the formalin; these cases seem to swell out in length, not in width, squeezing the animals in the central opening. I had some very well prepared *Melicerta tubicolaria*, the tubes of which have grown to nearly three times their original lengths, showing the heads of the uncontracted animals about the centre. Unless the gelatinous cases are first removed, it will be better to preserve and mount these Rotifers in dilute Flemming's fluid without osmic acid, or in bichloride of mercury and salt solution.\*

*Melicerta ringens* is easier to prepare, but requires patience; little of the narcotizing fluid must be added at first, and the creature watched until the cilia move very slowly, then is the time for killing with a drop of osmic acid.

*Limnias* presents no difficulty. After the first dose more and more cocaïn mixture can be added rather quickly, and the animals may be killed fully extended while the cilia are still in motion.

*Conochilus volvox* must be narcotized very quickly. The first good dose of cocaïn-alcohol sends the colonies spinning round

\* I recommend that this solution be made as follows, as least likely to produce crystals:—Equal parts of bichloride of mercury,  $\frac{1}{10}$  per cent. solution, and common salt,  $\frac{1}{2}$  per cent. solution.

at a great rate. This must be followed after one or two minutes by continuous further doses until the cilia cease to move and the colonies become motionless, which is accomplished in five to ten minutes. They are then killed quickly with osmic acid, which must be allowed to act for half-a-minute, washing out in water rather quickly, otherwise the animals separate, although perfectly preserved. The gelatinous substance in which these Rotifers are embedded also swells somewhat in formalin, and it is, therefore, advisable to preserve the colonies in the sublimate and salt solution, and mount them in that fluid.

*Asplanchna priodonta* can be narcotized very quickly. Five minutes after the first dose the animals receive continually fresh doses until they swim very slowly, and are killed whilst still moving, all fully extended, almost without exception, the whole process being finished in about ten minutes.

*Asplanchnopus myrmeleo* must remain about half-an-hour under the influence of the narcotic, until the cilia beat very feebly, and the animals are hardly able to move.

*Notops brachionus* requires a good dose of cocaïn-alcohol mixture to begin with, and after ten minutes more and more doses until they gradually fall to the bottom and are unable to swim; but as long as the cilia beat with force they will contract, and they must, therefore, be closely watched and killed at the moment when the cilia have stopped moving in some of the animals.

*Euchlanis*. With cocaïn alone I had no success at all with the various species of *Euchlanis*, but with the cocaïn-alcohol mixture I have been able to prepare all the species without difficulty. They must be narcotized very quickly by adding large doses, and killed whilst still swimming about, otherwise they gradually contract.

*Brachionus pala* is readily killed fully extended, either by narcotizing quickly or slowly.

*Brachionus urceolaris*, on the other hand, is quite spoiled by the slow process, and must be narcotized as quickly as possible with large doses of the narcotic until the animals become motionless, when they are quickly killed and fixed with a drop of osmic acid.

*Synchaeta tremula* and similar illoricate free swimmers can be narcotized fairly quickly in 10 to 15 minutes, and killed whilst

still swimming about at a reduced speed; with a few only it is necessary to wait until the cilia have ceased beating.

*Notommatadæ*. Those members of this family which are possessed of a slightly stiffened skin can be preserved easily enough, but the very soft, larviform species present greater difficulties, as they wriggle about constantly from one shape into another when under the influence of the narcotic, and it requires patience to kill them well extended. By trying several times one succeeds in getting a few good ones, sufficient for a slide; so I have *Notommata aurita* with both auricles fully extended. It must here be mentioned that the formalin causes the black or opaque brain sac, which is so characteristic of some species of *Notommata*, to clear up and disappear. This is a drawback for these particular Rotifers, and I recommend that these species be preserved in the bichloride of mercury and salt solution, which preserves these structures.

The *Philodinadæ* also offer considerable difficulties on account of their very soft and contractile bodies. I think, however, these difficulties are not insurmountable, but have not yet had many opportunities, having been so much occupied with other species.

I may remark in passing that infusoria can be preserved by the same method. All those infusoria which have not the power of contraction are readily prepared, without narcotizing, by killing and fixing with  $\frac{1}{4}\%$  osmic acid, washing out immediately in water, and preserving in  $2\frac{1}{2}\%$  formalin. The contractile infusoria will have to be narcotized in some way, but owing to the absence of a differentiated nervous system this may prove somewhat difficult; I have not investigated how far this can be done with 2% cocaïn and the cocaïn-spirit mixture, but both these fluids should be tried.

A few hints and wrinkles on mounting Rotifers when killed and prepared may prove useful.

Instead of cement cells I now use hollowed out glass slips, which can be obtained of all sizes from  $\frac{1}{4}$  in. to  $\frac{3}{4}$  in. in diameter, and proportionately deep. These are always ready, and have the great advantage that the often very minute animals cannot go to the edge, where they cannot be properly seen in a cement cell. Some difficulty may be experienced at first in closing the cell with a cover glass without an air bubble. This will, however, soon be overcome by proceeding as follows:—Place a drop of the  $2\frac{1}{2}$  per cent. formalin solution in the cell, just filling it,

and transfer the prepared Rotifers with a pipette into the cell, then place another drop on the slip by the side of the cell, about half an inch to the left, lower your clean cover glass on to this last drop, which will present no difficulty, then with a needle push the cover glass slowly, and by little jerks, over the cell, stopping short for a moment if the Rotifers show a tendency to move to the edge of the cell. But before covering the cell examine it under the dissecting microscope, and remove every fibre and every particle of foreign matter, however small, with a mounted bristle. The superabundant fluid is then removed with blotting paper until none is left round the cover; the cover must not, however, stick too fast, and you must be able to move it with a needle, otherwise the cement will be forced in at the sides by atmospheric pressure. When ready the cover glass is sealed down by tipping some Miller's caoutchouc cement\* all round the edge with a fine sable brush. The cement must not be liquid, but thickened by exposure to the consistency of a very soft jelly. The edge of the cover-glass must be carefully looked over under the lens to see that the cement covers it everywhere, and that no air bubble has been left at the edge. Cover-glasses have frequently small cracks running inward some little distance; these must be carefully covered with cement to their ends, otherwise the fluid will slowly evaporate through these cracks, and in time an air bubble will appear in the mount. When the cement is dry, that is next day, the slide can be finished with a ring of asphalt, or any other ornamental cement.

In conclusion, I wish to say that my object in this method of preserving Rotifers is not to bring out any particular organs or structures, but to preserve the animal as a whole, white and transparent, and as life-like as possible, and suitable for identification and study at any time. The process as now explained certainly does this for the great majority of species, and the delicate organs even, such as the very fine flagella attached to the vibratile tags in *Asplanchna priodonta*, are perfectly preserved, and can be seen more distinctly than in the living animal. The red eyes and green food particles in the stomach

\* Miller's caoutchouc cement is very good, and the best I know for sealing all kinds of fluid mounts, except, of course, alcohol. Its composition is kept a profound secret by the inventor, but it probably consists of a mixture of shellac (buttonlac) dissolved in strong alcohol (or possibly Venetian turpentine) and caoutchouc dissolved in chloroform. The diluting fluid is a mixture of equal parts of chloroform and strong or absolute alcohol.



are also well preserved when weak osmic acid is used as the fixing agent, except perhaps when the eyes are only faint patches of red pigment, which then may disappear more or less in time.

So far I have prepared and possess slides of 130 different species of Rotifers, including some of all the families, which is sufficient proof that this "unpreparable" group, as Mr. Bolles Lee has styled the Rotifers, is now fairly conquered. It is my intention to prepare a similar series for the cabinet of our Club, to form in time a complete type collection, if possible, of all the known Rotatoria, and I trust the members will assist in this task. This will prevent in future the confusion which exists with regard to a number of species which have been described three or four times under as many different names.\* As a beginning, I have much pleasure in presenting to the Club 77 slides, which will form the nucleus of this collection; they contain 72 different species, of which the following is a list.—

<i>Stephanoceros eichhornii.</i>	<i>Notommata aurita.</i>	<i>Euchlanis hyalina.</i>
<i>Melicerta ringens.</i>	" <i>tripus.</i>	" <i>parva.</i>
" <i>tubicularia.</i>	" <i>cyrtopus.</i>	" <i>deflexa.</i>
" <i>conifera.</i>	<i>Cyrtonia tuba.</i>	" <i>pyriformis.</i>
<i>Limnias annulatus.</i>	<i>Proales decipiens.</i>	" <i>lyra.</i>
" <i>myriophylli.</i>	" <i>parasita,</i> in	<i>Cathypna ungulata.</i>
<i>Conochilus volvox.</i>	<i>volvox.</i>	<i>Monostyla cornuta.</i>
<i>Æcistes stygis.</i>	<i>Furcularia longiseta.</i>	<i>Distyla spinifera.</i>
<i>Asplanchna prodonta.</i>	<i>Diglena forcipata.</i>	<i>Metopedia solidus.</i>
" <i>amphora.</i>	<i>Plasoma lynceus.</i>	" <i>acuminata.</i>
<i>Asplanchnopus myrmeleo.</i>	" <i>Hudsoni.</i>	" <i>lepadella.</i>
<i>Synchata tremula.</i>	<i>Anapus ovalis.</i>	<i>Pompholyx sulcata.</i>
" <i>tavina.</i>	<i>Mastigocerca bicornis.</i>	<i>Brachionus pala.</i>
" <i>stylata.</i>	" <i>carinata.</i>	" <i>urceolaris.</i>
<i>Triarthra longiseta.</i>	" <i>bicristata.</i>	<i>Noteus quadricornis.</i>
" <i>mystacina.</i>	<i>Rattulus sejunctipes.</i>	<i>Schizocerca diversicornis.</i>
" <i>breviseta.</i>	<i>Cœlopus porcellus.</i>	" <i>nis.</i>
<i>Hydatina senta.</i>	" <i>brachiurus.</i>	<i>Anuræa aculeata.</i> var.
<i>Rhinops vitrea.</i>	<i>Dinocharis tetractis.</i>	<i>valga.</i>
<i>Rhinops (?) orbiculodiscus.</i>	<i>Stephanops longispinutus.</i>	<i>Anuræa cochlearis.</i>
<i>Notops brachionus.</i>	<i>Stephanops intermedius.</i>	" <i>serulata.</i>
" <i>pygmæus.</i>	<i>Diaschiza semiaperta.</i>	" <i>hypelasma.</i>
<i>Triphylus lacustris.</i>	" <i>exigua.</i>	<i>Notholca acuminata.</i>
<i>Notommata lacinulata.</i>	<i>Salpina brevispina.</i>	" <i>scapha.</i>
	" <i>marina.</i>	<i>Pedalion mirum.</i>
	<i>Euchlanis triquetra.</i>	

\* Members who do not wish to mount the specimen themselves can assist in this work by sending me living examples of rare species of Rotifers when they happen to find them. The above list may be taken as an indication of what is not required, but the following species are particularly wanted:—*Apsilus lentiformis*, *Cephalosiphon limnias*, *Asplanchna Ebbesbornii*, *Microcodon clavus*, *Pedetes saltator*, *Pterocæsa surda*, *Scaridium eudactylosum*, *Dinocharis Collinsii*, *Stephanops chlæna* and *unisetatus*, *Erethmia tetrathrix*, *Notogonia Ehrenbergii*, and many others.

## THE PRESIDENT'S ADDRESS.

BY EDWARD MILLES NELSON, F.R.M.S.

*(Delivered February 15th, 1895).*

GENTLEMEN,—I cannot proceed with the work of this evening without alluding to the great honour you have done me in again electing me your President in spite of my numerous absences from this chair during the past year. I had the comfort of knowing that you were in better hands than my own through the kindness of Mr. Michael, and to you and him I now give my best thanks.

In brass and glass the past year has been a busy one; it might, to use a cycling phrase, almost be called a record. The new inventions and improvements in brass work have been neither few nor unimportant, and although we have nothing further to discuss with regard to the glass portion of the subject, yet in the optical theory part we have had enough new matter put before us to occupy our minds for some time to come.

To proceed with the brass work from the point where we left off last year, we must go back to the latter part of 1893, when we find a microscope made by Leitz having a tripod (claw) foot and a horse-shoe stage. This instrument is interesting because of its divergence from the continental model, and of its convergence towards the English. The grooving of the substage focussing slide is peculiar, but as a special note on that point has already appeared in this Journal, we may pass on to Swift's four-legged microscope.

It is, however, difficult to follow the argument respecting this novelty, for past experience has shown that both the microscope and the telescope perform better the firmer their stands are. It has been repeatedly said, and no one has ever contradicted the statement, that the same optical lenses when used on a portable stand will not perform so well as on a rigid stand. With the same objective, eye-piece, and condenser the delicate points which can just be caught when using a Powell's

No. 1 will be invisible if the stand is changed for their portable. Leaving the portable instrument out of the question the image with a large massive stand is always superior to that obtained with a small and lighter stand, however well made it may be, the optical apparatus being the same in both cases. Now the objection to the claw foot is, first, insufficient spread, and secondly, the breadth of the back foot. The first fault makes the instrument easily capsizable sideways, and the second tends to make it rock on four points. The proper remedy for the first fault is to increase the base, and for the second is to make the stand a true tripod. My objection to the cutting and pivoting of the back leg is that it at once degrades the instrument to the level of a portable stand; but if the instrument is put forward as a new portable microscope it will probably be admitted that it is about the best form that has yet been devised.

There is another innovation with regard to this stand, and the former pattern brought forward by Messrs. Swift and Son, which suggests an important question for the consideration of microscopists, viz. : is it an advantage to make the legs of the tripod or tetrapod hollow? Lightness is of course gained, but then it is at the cost of a higher centre of gravity, and moreover how about rigidity? If these stands are intended for portable microscopes only, the lighter the better, and on that account one is prepared to sacrifice something. If on the other hand they are intended for the highest possible work, solid legs would perhaps be better; probably by filling up the tubes with lead the necessary weight and rigidity would be secured.

With regard to the next two instruments, you will know more about them than I, for they were exhibited here during my absence, so unfortunately I have not seen them; they are Curties' instantaneous photomicrographic shutter, and Leitz's low-power projection camera.

We now come to a great, and what we may venture to think will prove a most useful invention, viz., Swift's friction geared mechanical stage.\* It has since its first in-

\* Frictional gearing was first applied to the microscope by F. H. Wenham, who says that "he found it answer perfectly well in lieu of the ordinary rack-and-pinion of the body and stage of microscopes . . . it works very smoothly and lifts a weight of 16lbs. without slipping."—"Quart. Journ. Micro. Science," Vol. vii., p. 201, two woodcuts (1859).

roduction been improved by bringing the friction wheels nearer together, and also by fixing a milled head to each end of the pinion for the horizontal movement. This stage secures a maximum range of motion in each direction, and at the same time the whole apparatus can be removed, leaving the main stage perfectly plain. A copper ring is swedged on the wheels which impart the horizontal movement to the slide, and corundum powder is rubbed into it, which increases the grip on the lower edge of the slide. Next we have a series of microscopes, exhibited here by Messrs. Ross; they do not materially differ from the ordinary Anglo-Continental pattern of students' microscopes except in the foot. The limb is fixed by a compass joint to a pillar which is attached to the periphery of a circular foot; so far they are not unlike Salmon's microscope (1853) described by Dr. Beale. This pillar is, however, pivotted so that the foot may be turned backwards, which gives great steadiness to the instrument when in an inclined or horizontal position. This forms a simple, inexpensive and thoroughly practical foot, and it is strange that such an efficient design has not been oftener employed in the construction of students' microscopes. This idea was first suggested by Mr. A. McLaren.\*

We next come to Baker's photomicrographic instrument. Here we have a microscope which cannot be used in any other but the horizontal position. The focussing racks of the body and substage are all ploughed in the bed plate, and the foot and arm are dispensed with. This seems to me the most solidly-constructed photomicrographic instrument yet made. This excellent design is due to Mr. E. Hartley Turner, of Manchester. It is an instrument that will be much appreciated by those who do all their microscopical work on the photographic bench. Personally I work on different lines, the magnification, lens, adjustment, illumination, position, etc., of the object being all determined before it is placed on the photographic bench, so I naturally prefer to photograph with the same instrument by which those adjustments were made, and would find some inconvenience in changing to another instrument; but this is a mere matter of detail.

The last microscope is Watson's new model Van Heurck.

\* "Journal R. M. S.," 1884, p. 111, Fig. 9.

This in general resembles their older form, except that the distance between the optic axis and the limb has been increased, so that complete rotation is given to the stage. The foot is an equilateral tripod of 10-inch side, and its height is such that when the instrument is placed in a horizontal position the optic axis is ten inches from the table. The stage movements are similar to Powell's No. 1, and the instrument is thoroughly well made and sprung throughout. Leaving the microscopes, we pass on to apparatus, and we have Mr. R. Smith's rocker microtome. This is similar to the Cambridge rocker, but it is fitted with a movable knife-holder, which allows the edge of the blade to be placed at any desired angle to the cut. Another ingenious arrangement permits the instrument to assume a vertical position, so the cut can be made in a spirit trough. We have also from America clay wicks for microscope lamps, which are said to give a greater intensity of white light, and to be without smell. Finally there is my own camera, which has been already described here.

We must now notice the improvement in coloured screens, a very important branch of microscopy to which in the past it is to be feared that sufficient attention has not been given. The office of a screen in popular language is to improve the image with apochromatics, strengthen the resolution, and at the same time to soften the light when large illuminating cones are used. They are of special service with cheap lenses (*i.e.*, semi-apochromats), because they remove the secondary spectrum, making the lens as efficient as an apochromat. So markedly is this the case that with equal apertures it is impossible to say whether the objective on the nose-piece is an expensive apochromat or a cheap semi-apochromat. In photomicrography not only are the preceding remarks applicable, but also colours difficult to photograph are rendered neutral. My reason for dwelling at length again this year on the subject of screens is not only because its importance is not so fully recognized as it should be, but also because some improvements have been effected during this past session. Mr. Lovibond, of Salisbury, who has been both a member of this Club and also a Fellow of the Royal Microscopical Society for twenty-nine years, has given this subject much attention. He sent me a flashed glass screen of peacock blue and a fluid screen of methylin blue,

and Mr. J. W. Gifford, who has also done excellent work in this direction,\* sent me subsequently a very fine fluid screen of malachite green and picric acid. These were the screens you heard about last year. Since then Mr. Lovibond has sent me another sample of bluish green pot glass, which cuts the red out more thoroughly than the peacock blue glass. Mr. Gifford also has given me two more fluid screens, one a green and the other a violet.† The violet screen is too dark for visual purposes, and as yet I have not experimented with it photographically, but the green screen passes a large quantity of light. The results obtained with it are certainly up to, and probably superior to those with monochromatic light from my apparatus of the most approved pattern. There is one very important point with regard to the use of screens for visual purposes, viz., that if they are too dark they will obliterate fine detail, and it will be found better to pass a wider band, even should it contain some objectionable rays (*i.e.*, not so monochromatic), than cut down the intensity of the light too much. In fact, there is a happy medium between the monochromatism of the screen and the light intensity; for example, Mr. Gifford's new green screen, which passes all the green and a great deal of blue, is a much better screen than that of Prof. Zettnow, which is more monochromatic.

Before entering on the subject of the evening, a few words must be said regarding a pamphlet published last year by Mr. Allan Dick, entitled, "Additional Notes on the Polarizing Microscope."‡ Most of us are acquainted with his former excellent pamphlet, and with the improvements he has made in petrological microscopes. This new work, however, deals largely with the manipulation and management of an ordinary microscope, quite apart from petrological work. It is to this portion of the book that we must, therefore, confine our attention.

In the book is described a new method for measuring the aperture of a lens, which depends on the number of rings that can be counted in a biaxial crystal when viewed under a wide-angled axial cone of polarized light. The angles of the ring

\* "Journal R. M. S.," 1894, p. 164, and Pl. V., Fig. 4.

† An account of these will shortly appear in the "R. M. S. Journal."

‡ Published by Messrs. Swift & Son, 81, Tottenham Court Road, W.

distances are first measured by an apertometer, and when these have been tabulated, the crystal takes the place of an apertometer. The apparatus required, if one does not possess a petrological microscope, is a Nicol polarizer, of a size not less than that sufficient to fill the back lens of your condenser, (if that happens to be an Abbe it will be rather a costly item), an analyzer, a lens inside the tube of the microscope to convert the instrument into a telescope, and a properly cut crystal. Whether this extra apparatus is more costly than an ordinary apertometer I am unable to say, but it is claimed for the new method that it will measure the aplanatic aperture better than the Abbe apertometer. On page 14 a very pretty experiment is described by Mr. Dick, which visibly demonstrates in a most conclusive manner that a greater angle of light is grasped by an immersion than can possibly be by any dry objective.

Mr. Dick, it will be noticed, uses the sliders with his Abbe apertometer; these in my hands have always given very rough and, in the case of large angles, erroneous results.

A preferable method of using the Abbe apertometer is to rotate the hemispherical disc until the light is extinguished, read off the angle of rotation on both sides of zero, take the sine of the mean reading and multiply it by the refractive index of the apertometer; the result will be the N. A. of the lens. If in this manner you measure wide-angled condensers you will find curious effects. In some the flame image will disappear before the periphery of the back lens has been reached; this shows that the front lens has not sufficient aperture to fill the back lens of the combination. In others the light, after extinction, will become visible again. In some the image of the flame will continue to be in focus during its passage over a large area of the back of the objective, in others it will begin to go out of focus almost as soon as it has left the centre of the back lens.

Mr. Allan Dick has fallen foul of that dreadful nightmare of diatom structure interpreters, viz., images in the areolæ. Images in all kinds of areolations, whether of diatomic or other structures, follow the laws of those arising from minute perforations. As this is an important and often misunderstood subject, you will pardon me if it is treated at some length.

Procure a small piece of tinfoil and a fine-pointed needle,

place the tinfoil on a smooth piece of cork and make several fine punctures in the foil, then placing the foil in a compressor view it under a  $\frac{2}{3}$  objective. When the image of the edge of the flame is focussed by the substage condenser on the foil the only image that can be obtained will be that of the diaphragm at the back of the condenser. The image of this will be erect when the hole in the foil is beyond the focus of the objective, and inverted when within the focus of the objective. A better plan, however, is to rack the condenser so that its focus shall be either within or without the plane of the foil, because it will then be possible by altering the focus of the objective to obtain an image of the edge of the flame itself. If an opaque object, such as the flat of a paper-knife, be moved up and down in front of and near the flame it will then at once be seen whether the image is erect or inverted by watching the direction in which the image of the flame is extinguished; thus, if the paper-knife be moved upwards, and the image of the flame is extinguished in a downward direction, the image is an inverted one, and *vice-versâ*. The results obtained by the above method are given in the following table:—

<i>Condenser.</i>	<i>Objective.</i>	<i>Image.</i>
Beyond focus.	Beyond focus.	Inverted.
Beyond focus.	Within focus.	Erect.
Within focus.	Beyond focus.	Erect.
Within focus.	Within focus.	Inverted.

We see, therefore, that when the foci of both the condenser and the objective are either beyond or within the plane of the object the image will always be inverted, and that when one is within and the other beyond it will always be erect.

Now, if we examine other structures, such as the eye of a fly or beetle, diatomic structures, dry or in balsam, the bubbles in the fluid cavities in quartz sections, or the fluid cavities themselves, we shall always find that the images will follow the rules of those of minute perforations in an opaque substance as given in the above table. It is difficult, therefore, to see how the character of the image can decide the question as to whether the minute structure under consideration is acting as a positive or negative lens.

In the first paragraph of the appendix Mr. Allan Dick mentions a difficulty which has probably puzzled not a few. He



correctly remarks that "the hexagons are always turned  $30^\circ$ " to their positions in Fig. 63, in the last edition of "Carpenter on the Microscope," when the spectra at the back of the objective are represented as in Fig. 62.\*

I think an explanation of the phenomenon will be found by the examination of any hexagonal structure, such as a honeycomb, fly's eye, or diatom; by doing this we shall at once see that the three directions of the rows of hexagons are at right angles to the three directions of the sides of any particular hexagon. In the above-mentioned erroneous Abbe-Eichhorn figures the hexagons are turned, as Mr. Allan Dick has pointed out,  $30^\circ$  from their proper position. These figures are, as I have frequently remarked, incorrectly drawn. If you will examine Figs. 63 and 64 you will observe that the directions of the rows of hexagons are in an alignment with the angles of any particular hexagon; they are therefore  $30^\circ$  out of position.

With regard to the spectra, it is well known that the spectra assume a direction at right angles to those of the lines causing the interference. Now it is the rows of hexagons which cause the interference, and not the edges of the hexagons themselves. If, therefore, we draw three lines at right angles to the three directions of the edges of any particular hexagon, they will represent the three directions of the rows of hexagons; and if we draw a line at right angles to each of these, they will represent the proper position for the spectra. And also because the angle subtended by a side at the centre of a hexagon is  $60^\circ$ , and that angle and a half makes a right angle, the spectra will therefore lie in the same direction as the corners of the hexagon. The term used above, "rows of hexagons and not the edges of the hexagons themselves," requires explanation; it much simplifies this question by regarding in the first instance the inter-spaces rather than the lines. Of course it is the intercostal material that diffracts the light, and in the case of diatoms such intercostal silex has been isolated by our well-known member Mr. T. F. Smith. This intercostal material forms a wavy line, composed of short pieces inclined  $120^\circ$  to each other, being the sides of contiguous hexagons. It is therefore this long and continuous wavy line that determines the

\* These figures, together with 64, are similar to those in the "Journal R. M. S." for 1881, p. 353-4, Figs. 105, 106, and 107.

position of the spectra, and not the detached short pieces which form the sides of the hexagons; for every side of a hexagon is separated by twice its own length from the next side that is in a straight line with it. In order that a filament of this structure should break off and become separated, as in Mr. Smith's specimen, it is necessary that the silex forming the sides of the hexagons in the third direction should be weaker than that forming the other two.

We now pass on to the subject for the evening, and you will probably agree with me that the one selected for your kind consideration is the most important in the domain of microscopy that has appeared since 1875, when the Abbe diffraction theory of microscopic vision was first published in the "Monthly Microscopical Journal." I, of course, allude to the physical theory of microscopic vision written by my friend Mr. Lewis Wright in the "English Mechanic"\* during the months of September, October, and November of last year.

The questions at issue are very large, for if Mr. Wright's conclusions are correct the table of the "Limit of Resolving Power" in the "R. M. S. Journal" is incorrect, because it is only valid for spurious images, and the true limit for microscopic vision becomes reduced, as we shall see later on. But, before proceeding, we must first consider the Abbe theory, both as it first appeared, and also in its present position. In the first instance we had a dioptric image for structure larger than the  $\frac{1}{2500}$  of an inch, and after that a diffraction image. In accounting for other pictures recourse was had to a double theory, a dioptric one for one portion of the image and a diffraction one for another part. In simple words we were told that a cataclysm took place in the physical phenomena of light at a point denoted by the  $\frac{1}{2500}$  of an inch. And we were further taught that it was impossible to know anything of minute structures unless certain impossible conditions were fulfilled, such as the grasping of the entire diffracted fan.

There was also the Eichhorn theory with its alleged prediction of structure. This has been entirely refuted both practically and theoretically, and moreover it was shown to be quite at variance with the fundamental laws of the diffraction theory. The diffraction theory in its pristine condition was therefore both incorrect and illogical. As it now stands, however, with

\* "English Mechanic," Vol. lx. (1894), Nos. 1537-38-40-42-43-45-47.

those embellishments and errors removed, it is a consistent working theory, its limit of resolving power agrees very well with results practically obtained, and it also affords valuable information for checking the interpretation of periodic structures.

Our next point is a digression, which I trust you will pardon, for we must investigate the theory of telescopic vision before we can proceed.

Mr. Wright has given a very clear explanation of the theory of telescopic vision in the "English Mechanic."\* Very briefly stated it is this: Let  $A B W$  (Fig. 1) be a long isosceles triangle with a narrow base  $A W$ . Let  $B$  represent the focus, and  $A W$  the diameter of a telescope objective.

Then, if light having travelled along  $A B$  arrives at  $B$  in a certain phase, it will also arrive there in the same phase when it has come *viâ*  $W B$ , because  $W B$  is equal to  $A B$ . Now let us take another point  $D$ , at one side of and close to  $B$ , and let us draw lines from  $D$  to  $A$  and  $W$ , then it is clear that the triangle  $A D W$  will not be isosceles, for one side must be longer than the other, and the greater the distance of  $D$  from  $B$  the greater will be this inequality of the sides  $A D$ ,  $W D$  of the triangle  $A D W$ . Let the point  $D$  be placed at such a distance from  $B$  that the difference in the lengths of the two sides  $A D$  and  $W D$  of the triangle  $A D W$  amounts to half a wave-length, it is then obvious that light arriving at  $D$  *viâ*  $A D$  will differ in phase from that coming *viâ*  $W D$  by half a wave-length. In other words, to use a familiar figure, at the point  $B$  the crests of the waves will meet the crests, and the hollows will meet the hollows, consequently there will be a reinforcement of wave action, but at the point  $D$  the crests will meet the hollows, and *vice-versâ*, so that there the wave motion will be annihilated,

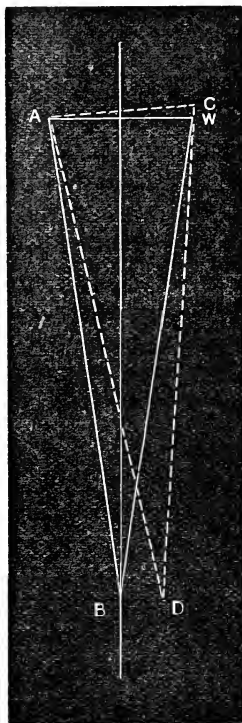

FIG. 1.

\* "English Mechanic," Vol. lx., No. 1540, p. 125.

*i.e.*, there will be darkness. If the point D is moved a little further from B, so that A D is longer than W D by one whole wave-length (see dotted isosceles triangle A D C), there will be another reinforcement of light at that point, and so on.

Hitherto we have only been considering the effect of the wave-action of light at a small spot on either edge of an



FIG. 2.

objective; we must now take into account its action over the whole area. Let us, in the first instance, suppose that the object-glass is square, and let us divide this square into equal rectangular spaces by drawing lines parallel to one of the sides of the square (Fig. 2); we can then easily see that the light passing through one rectangle will oppose that passing through

another; thus, if we divide our square objective into eight rectangles, and name them consecutively E F G H I K L M, E will oppose I, F will oppose K, G—L, and H—M. The case being that of the dotted triangle A D C (Fig. 1), where the light passing at the E or A edge of the object-glass to the point D has one wave-length further to travel than that passing at the M or W edge, therefore that passing at the centre of the square, *viz.*, at the line between H and I to the point D, will have half a wave-length less to travel than that at E, and half a wave-length more than at M. Moreover, the rectangles being all equal to each other, the opposition of the rays will consequently be equal in effect. From this we learn that the image of a bright point, such as a star, at the focus of a telescope is made up of a bright disc in the centre of a dark ring, encircled by a bright ring, etc. Now, so long as the objective is square, it is easy to calculate the distance the dark point D is from B. When F is the focal length of the objective, A its aperture, and  $\lambda$  the wave-length,

then the distance between D and B,  $\delta$  is equal to  $\frac{\lambda F^2}{A}$ . This

means that the least separable distance in the image at the focus bears the same proportion to the focal-length, as the wave-length does to the diameter of the objective. But the ratio of

the least separable distance in the image at the focus, to the focal-length, is the same as that of the least separable distance in the object itself to its distance from the telescope; therefore, the least separable distance in the object bears the same proportion to its distance from the telescope, as the wave-length does to the diameter of the object-glass.\*

\* As it is important that even our most junior members should thoroughly comprehend this exceedingly simple problem, which is a common rule-of-three sum, and which precisely resembles, and requires no more mathematical knowledge than, the well-known child's problem about the herring-and-a-half which cost three-halfpence, this note is appended. Cut out of a piece of paper two precisely equal triangles like A B W (Fig. 1), and placing one over the other, so that the lower is exactly covered by the upper, stick a pin through both their corners at A. Now take hold of the lower one at the point D and move it out at one side, as shown by the dotted triangle (Fig. 1). It will then be seen that as the point D is moved to one side, so the point C of the lower triangle will protrude beyond the point W of the upper one. A moment's thought will show that the displacement at D is proportional to the protrusion C W, and that this proportion is that of the length of the line A B or A D (the focus of the object-glass) to the length of the line A W (the diameter of the object-glass). For example, if the focal length A B is four times as great as the diameter A W, and if D is moved four-tenths of an inch from B, the point C of the lower piece will protrude one-tenth of an inch beyond W the upper. Stating this simple problem mathematically, let us call  $\delta$  the displacement of D from B, and  $\lambda$  the protrusion at W, let A C or A W, the aperture, be called A, and A B or A D the focal length, F. Then

$$\delta : \lambda :: F : A \quad \dots \quad \dots \quad \dots \quad \dots \quad \dots \quad (i)$$

and every school-boy knows that to find  $\delta$  we must multiply  $\lambda$  by F, and divide the product by A.

When the dotted line C D (Fig. 1) protrudes one wave-length beyond W, then the remainder, W D, must be shorter than A D by that one wave-length, and we have seen in Fig. 2 that when the distance from the M side of the object-glass to D is one wave-length shorter than that from the E side, the light will be extinguished at the point D. The distance B D, therefore, represents the minimum visible, when the protrusion of C D beyond W is one wave-length. Now, as the wave-length, the focal length, and the diameter of the object-glass are all known,  $\delta$ , the minimum visible, can be determined.

Now one word with regard to the proportion between the size of the image at the focus, which we have just been considering, and the size of the object to which the telescope is supposed to be directed.

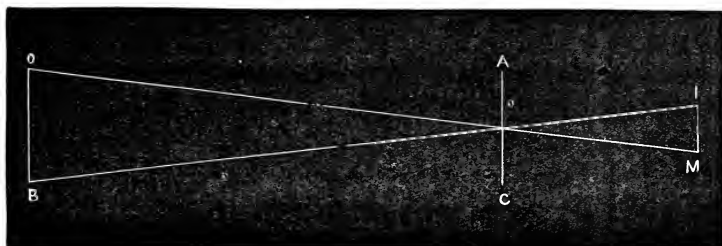

FIG. 3.

In order, however, to accurately represent the area of an objective we must inscribe a circle in our square (Fig. 2), and we shall see that the rectangles H and I in the centre of the circle very nearly represent the true area of that portion of the objective, but at the opposite sides of the square the rectangles E and M are ever so much larger than the corresponding portions of the circular object-glass, therefore the effect of the light passing through that portion of the objective represented by E is insufficient to neutralize the portion passing through I. The

In Fig. 3 let O B be the object, and I M the image, A C the object glass, A being the point where the lines O M and B I intersect. Because B I and O M are straight lines the alternate angles O A B, I A M are equal, and the triangles O A B, I A M are similar, therefore O B bears the same proportion to B A that I M does to M A. But B A is the distance of the object from the telescope, and A M is the focal length ; therefore we have

$$\text{object} : \text{distance} :: \text{image} : \text{focus.}$$

Let us call for brevity the object O, its distance D, the image (supposed to be a minimum visible)  $\delta$ , and the focal length F, then

$$\frac{O}{D} = \frac{\delta}{F}.$$

Next let us transpose our previous proportion (i.) thus—

$$\delta : F :: \lambda : A,$$

$$\text{that is } \frac{\delta}{F} = \frac{\lambda}{A}, \quad \dots \dots \dots \text{(ii)}$$

but we have just seen that  $\frac{\delta}{F} = \frac{O}{D},$

$$\text{therefore } \frac{\delta}{F} = \frac{\lambda}{A} = \frac{O}{D}. \quad \dots \dots \dots \text{(iii)}$$

Now because the angles in question are very small (about 5") these ratios express the angles themselves, therefore  $\frac{O}{D}$  becomes the angle the object subtends at the object-glass (D being the distance between the object and the telescope), and  $\frac{\lambda}{A}$  the angle one wave-length subtends at a distance equal to the diameter of the object-glass (*i.e.*, A the aperture), therefore the



FIG. 4

statement above is correct which says that the smallest object that can be seen with a telescope is that which subtends an angle at the object-glass equal to that subtended by one wave-length at a distance equal to the diameter of the object-glass.

In Fig. 4, A C or A W is the diameter of the objective, and C W is one wave-length, then equation (ii) shows that the angle C A W (Fig. 4) is equal to the angle I A M (Fig. 3) for a minimum visible, but the angle I A M is equal to the angle O A B, therefore the angle O A B is equal to the angle C A W, provided that the image is a minimum visible, equation (iii).

distance from B to D must, therefore, be increased. The calculation of the distance between D and B (Fig. 1), when the object-glass is circular, is a much more laborious and complicated problem. It was first solved in 1834 by Sir G. Airy,\* the late Astronomer Royal, who was the originator of this theory, of which the above is a mere outline. He found that with a circular objective,  $\delta$  the distance between D and B, was equal to  $\frac{1.2197 \lambda F}{A}$ . It is not my intention to trouble you this evening with any dry mathematical formulæ, or repeat what I have demonstrated elsewhere, but you may take it as correct that the formula for a square aperture given above, viz.,  $\delta = \frac{\lambda F}{A}$ , is practically the same, that it yields the same numerical values as Abbe's formula for microscopic vision, with which you are all well acquainted.

Unfortunately, however, the apertures of both telescope and

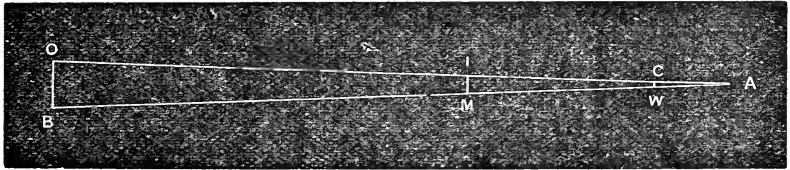

FIG. 5.

In Fig. 5 the three triangles are superimposed; it is a simple and easily remembered picture which contains the whole germ of the theory. Let AC be the diameter of the object-glass, AI its focal length, and AO the distance of the object. Then when CW is one wave-length, IM is the size of the minimum visible image at the focus, and OB is the size of the object.

This result I have expressed in a simpler and more handy form in another place thus:—"One unit of *Aperture* resolves one unit of *Interval* at a distance equal to the *Reciprocal* of the *Wave-length*." Example:—Let a wave-length be chosen between lines C and D, viz.,  $\frac{1}{332150}$  inch. Then

<i>Aperture</i> resolves <i>Interval</i> at <i>Distance</i> .		
1 inch	1 inch	42,260 inches.
$1\frac{1}{2}$ inch	1 inch	1 mile.
3 inches	1 inch	2 miles.
3 inches	$\frac{1}{2}$ inch	1 mile.

This table agrees with practical results obtained for terrestrial objects seen by reflected light with the best telescopes.

When a wave-length of  $\frac{1}{332150}$  (between lines D and E) is taken for bright celestial objects the above rule agrees with Dawes' empirical formula for the separating power of astronomical telescopes, viz.,  $4.56''$ , divided by the aperture of the object-glass in inches.

\* "Cambridge Philosophical Society's Transactions," Vol. v. (1835).

microscope objectives are not square, but circular, and referring to the formula for circular telescope objectives we see that it is a trifle more than one-fifth larger than that for square apertures. It therefore comes to this, that so long as the telescope objective is square, and the microscope objective is circular, the mathematical formulæ for both are numerically identical, although the reasonings by which those formulæ are obtained lie along wholly different paths; but when we have circular objectives in both cases, the resolving power of a telescope, according to the physical theory, is about one-fifth less than that of a microscope, according to the diffraction theory. Now, we know that it is impossible that light should act in one way in a tube because it is called a telescope, and in another way when it is called a microscope, and it was this glaring discrepancy between the telescopic and microscopical theories which led me to publish in 1893 a pamphlet on "The Theory of Telescopic Vision." Thus it was my endeavour to bring the theory of telescopic vision into harmony with that of the microscope. This evening you have before you the converse problem in Mr. Wright's articles, bringing the microscopical theory into consonance with that of the telescope. There is one thing for certain, that sooner or later either the Airy or the Abbe theory will be abandoned, for both cannot possibly be correct.

You must now know that with regard to these articles in the "English Mechanic" I am in a somewhat better position than you, because, in reply to some notes, Mr. Wright most kindly wrote to me at great length explaining several of his points, and giving me fuller information concerning others. What follows next with regard to the resolving limit will therefore have more reference to his letter than to what has appeared in print.

Lord Rayleigh, whose work on the undulatory theory is so well known and appreciated by all, made careful experiments with a telescope,\* and obtained a somewhat smaller limit for circular apertures, viz., one lying about half-way between those calculated by Airy for circular and square apertures.

\* "The Resolving Power of Telescopes," by Lord Rayleigh. "Philosophical Magazine," August, 1880.



We have therefore three limits, viz. :—

*Square aperture (same as Abbe) ..	...	$\delta = \frac{\lambda F}{A}$
Circular ,, (Rayleigh experimental)		$\delta = \frac{1.09 \lambda F}{A}$
Circular ,, (Airy calculated) ...		$\delta = \frac{1.2197 \lambda F}{A}$

It is stated that there are certain theoretical considerations which show that a star disc as seen in a telescope should be smaller than that calculated by Airy; this reference, however, I have not been able to look up. Now it is quite reasonable to expect that a limit obtained practically with instrumental appliances should fall short of a calculated theoretical limit, but it is difficult to understand how it can exceed it. This is certainly a point upon which more explanation is required. The actual resolving power of the microscope, therefore, according to Mr. Wright's theory, for a full cone, adopting the middle formula above, viz., that derived by Lord Rayleigh from actual experiment with a telescope, and employing the same wavelengths as those given in the tables in the "R. M. S. Journal" for white and monochromatic blue light, viz., for lines E and F, will be

88,450 multiplied by the N.A. for line E.  
and 95,880            "            "            "            F.

But, as before remarked, the line E is too high up the spectrum for visual purposes; it will be better to take one somewhat similar to that selected for my table in the "R. M. S. Journal" for 1893, p. 17, then the limit will be

85,630 multiplied by the N.A.

As, however, a full cone in practice can seldom be used, and because with a  $3/4$  cone spectra are present in the outer annulus, the table which is given presently will still hold good.

To reduce this question to its simplest terms, the resolving power of a microscope objective of N.A. 1.0, with a full cone,

\* My own experiments with telescopes on terrestrial objects, as well as those of Dawes on Double Stars, agree with this value.

and with white light (line E, the same as used in R. M. S. tables), will be

96,410	according to	Abbe theory.
88,450	„	Rayleigh experiment.
79,044	„	Airy theory.

Now the results from experiments both with full and  $3/4$  cones go largely to corroborate Mr. Wright's conclusions. It is common knowledge that when a full cone is employed the resolving power falls off, and it has been customary to account for this falling off in the resolving power by the outstanding spherical aberration in the objective. To test the accuracy of this current notion a critical image was set up, and matters arranged so that access could be obtained to the back lens of the objective without disturbing any of the adjustments. When a full cone of light was used the resolving power fell off, and when a  $3/4$  cone was employed it was as usual restored again; a stop was then placed at the back lens, cutting off the peripheral unilluminated annulus. We had, therefore, an objective of less aperture, but illuminated by a full cone. Under these circumstances one would have expected to see a critical image, but not so, and this is the crucial point. In order to obtain the maximum resolving power for that reduced aperture the illuminating cone had to be reduced until only three-quarters of the back lens was illuminated. This is a most important fact, because it shows that spherical aberration is not playing the rôle commonly assigned to it, and the blotting out of structure has a deeper meaning. Reading this in the light of the new theory we see that when a full cone is used the image comes under the physical or Airy limit, but the moment we use a  $3/4$  cone we have diffraction spectra in the peripheral annulus. The picture therefore obeys the Abbe limit with its greater resolving power.

Probably spherical aberration is present as well, and produces a certain amount of indistinctness of image which helps to obliterate the fine detail, but the above experiment proves that spherical aberration does not account for the whole phenomenon as it was previously thought to do. With regard to the  $3/4$  cone illumination, it should be remembered that the areas of circles are in the proportion of the squares of their diameters; therefore the area of the peripheral annulus where the spectra

pass is only  $12\frac{1}{2}$  per cent. less than the area of the central portion illuminated by the  $\frac{3}{4}$  cone. The numerical values are:—

Darkened annulus ... ..	43.75
Illuminated central portion ...	56.25

---

100

Because in practice we are bound to use a  $\frac{3}{4}$  cone we shall therefore have an image compounded of a true image in the central three-quarters of the whole aperture, according to Mr. Wright's theory, and an Abbe diffraction, or "true false" image, in the peripheral annulus, according to my nomenclature. The resolving limit will therefore, as stated above, agree with this table from the "R. M. S. Journal,"

*Table of Resolving Powers in Lines to an Inch with  $\frac{3}{4}$  Cone of Direct Illumination.*

N.A.	White Light. Between lines D and E 46,666 waves per inch.	Monochromatic Blue Light and Photo- graphy. Near line F 53,333 waves per inch.
0.1	7,000	8,000
0.2	14,000	16,000
0.3	21,000	24,000
0.4	28,000	32,000
0.5	35,000	40,000
0.6	42,000	48,000
0.7	49,000	56,000
0.8	56,000	64,000
0.9	63,000	The same as for white light.
1.0	70,000	
1.1	77,000	
1.2	84,000	
1.3	91,000	
1.4	98,000	
1.5	105,000	
1.6	112,000	

The above table agrees remarkably well with results actually obtained with the best lenses, and to show that this is so the following table gives the actual resolutions made on diatoms in

balsam with a  $3/4$  cone from a Powell fluorite apochromatic condenser ( $1/4$  of 0.95 N.A.) :—

Objective.	O.I.	N.A.	White Light.	Blue Light.
Apochromatic lin. ...	28.9	.32	22,000	25,000
1. Achromatic $1/10$ (1875) ...	20.0	.64	40,000 strong	49,000
2. Apochromatic $1/2$ ...	32.0	.66	46,000	53,500
3. Semi-apochromatic $1/4$ ...	18.6	.71	53,500	60,000 barely
Achromatic $1/4$ (1875) ...	16.5	.79	53,000 barely	60,000 barely
Semi-apochromatic $1/7$ ...	11.5	.86	60,000	65,000
4. Achromatic $1/5$ ...	16.3	.88	60,000	65,000 barely
Apochromatic $1/4$ ...	23.2	.95	65,000	—
5. Semi-apochromatic $1/12$ ...	9.7	1.26	90,000 barely	—
6. Apochromatic $1/8$ ...	17.0	1.43	94,000	—

1. Would resolve probably 42,000 with white light (construction same as achromatic  $1/4$ , viz., triple front and back, double middle).
2. A very fine lens.
3. A little more than  $3/4$  cone used; this lens is a very strong resolver, and stands blue light even better than some apochromatics.
4. A fine example of an achromatic by Gundlach.
5. Will not resolve the *Nitzschia curvula*, 90,000.
6. Resolves *Amphipleura pellucida*, 93,000-95,000. Less than  $3/4$  cone used.

To return to the diffraction theory, it has been recognized for some time past that there is more than one kind of image, and on a former occasion it was my endeavour to prove to you that there were three distinct kinds of images, one being a "true" image, which went in and out of focus as a daisy under a  $4in.$ , the other two being "false" images, one of these a "true-false" image, whose character was similar as regards the arrangement of the elements of the periodic structure to that of the object itself, but under focal alteration it passed into another kind, called a "false-false" image, whose character entirely differed from that of the "true" image. Now Mr. Wright's position, if I have interpreted him correctly, is this, that his new "true" image comes under the laws of the Airy or physical theory, but the other two images, viz., the "true-false" and the "false-false," conform to those of the Abbe or diffraction theory. With regard to this last image, it is admitted by all genuine microscopical workers that it is not only of no use, but is absolutely a hindrance to the interpretation of microscopical struc-

tures, and on this account it, as well as the small cone by which it is produced, ought to be got rid of as far as possible. Mr. Wright has assigned it to a class of physical phenomena known as Fresnel's interference bands. These images therefore will in the future be only regarded as interesting examples of experiments in physical optics. It is important to consider for a moment the "true-false" image and its influence on that obtained by the only correct method of microscopical illumination, viz., a  $3/4$  cone. It is, as we have seen, one of the components of the resultant image, and it is formed by spectra passing through the peripheral annulus. The new theory shows that this image also partakes of the nature of Fresnel's interference bands, but because it is a "true-false" image it strengthens, by its superior resolution, Mr. Wright's new "true" image, and as we must put up with it, full cones being impracticable, it is consoling to know that it is a "true-false" image that we have to deal with, which will assist, and not injure, our new "true" image.

Putting the case in another way we see that it is the image formed by the central three-quarter portion of the whole objective that definitely fixes the focus, and consequently we are unable to play upon focal adjustment for the formation by means of the Fresnel bands of various pictures, which, however beautiful they in themselves may be, yet have nothing whatever to do with the structure under the microscope. Some will say that we have at last come back to Abbe's original theory, which he has since abandoned, viz., that the microscopical image is compounded of two superimposed images, one a dioptric image and the other a diffraction image beginning at  $\frac{1}{2500}$  inch. To this we reply that, although in words it may be so, in meaning the case is far different. To mention two differences: Abbe's double image was the *essence* of the microscopical image, but now the double image is an *accident* arising from the impossibility of using full cones. Again the resolution in the centre conformed to the Abbe limit, whereas it now possesses less resolving power owing to its dependence on the Airy limit.

With regard to the action of the four kinds of illumination by means of axial cones, the following are from results obtained

in practical work. The order given is from the strongest to the weakest resolver :—

*Appearance at Back of Objective.*

1. Peripheral annulus bright,  $\frac{3}{4}$  centre dark.
2. Peripheral annulus dark,  $\frac{3}{4}$  centre bright.
3. The whole dark (dark ground).
4. The whole bright (full cone).

No. 1, which is made by placing an opaque central stop\* at the back of the condenser, is the strongest resolver of all symmetrical systems of illumination. (This stop at the back of the condenser must on no account be confused with a stop at the back of the objective for the purpose of cutting out a narrow central dioptric beam). It is nearly, but not quite, so strong a resolver as the asymmetrical method by light in one azimuth by means of a slotted stop. The resolving power of No. 1 does not come under the new theory, because spectra are formed in the  $\frac{3}{4}$  central portion; the theoretical limit is therefore 96,410 times the N.A. of the objective, the wave-length being the same as that used in the R. M. S. tables (line E.). No 1 cannot, however, be recommended for practical work, because it is so liable to produce false images, and especially to double the structure. Any structure near the limit for a lens of half the aperture is likely to be doubled, *e.g.*, an *Angulatum*, which can be resolved by an objective of N.A. .7, is likely to exhibit intercostals when examined by a lens of N.A. 1.4, and illuminated in this manner. This method will require a condenser whose aperture must be fully equal to that of the objective.

No. 2.—This, which is known as  $\frac{3}{4}$  cone illumination, is the best for general purposes, and because of the presence of spectra it also does not come under the new theory. The theoretical resolving limit for line E is 72,307 times the N.A. of the objective. The image, as we have seen above, is compounded of the new "true" image, and the "true false" image of the old diffraction theory. It may, therefore, be relied upon. The aperture of the condenser need only be  $\frac{3}{4}$  that of the objective.

\* It would be far better if the meaning of the word "stop" in microscopical literature were confined to the opaque central stops used at the back of the condenser for producing dark grounds, etc. The common stops, with central circular apertures, might be appropriately called "diaphragms."

No. 3.—Dark ground obtained by a condenser and a stop; this is only available for the lower powers; the apochromatic  $\frac{1}{2}$  or  $\frac{1}{3}$  of .65 N.A. may be said to exhaust this method of illumination. This case, in my opinion, comes wholly under the new theory, because all the aperture is uniformly utilized. To all intents and purposes an object such as a diatom may be said to be self-luminous; under these conditions the action of a microscope most closely resembles that of a celestial telescope. The practical resolving limit is only a trifle below that of No. 2; theory, however, demands that it should be higher. Taking the same wave-length the resolution for No. 3 should, according to the new theory, be 79,044 times the N.A. of the objective, against 72,307 times the N.A. for case No. 2. Practice, however, as we have seen, reverses the order, and gives No. 2 a slightly higher resolving power. The condenser must, of course, have far more aperture than the objective.

No. 4 comes entirely under the new theory, but resolution falls off considerably; there is also an indistinctness in the coarse structure. Theoretically the limit is the same as that of No. 3, viz., 79,044 times the N.A. of the objective. This mode of illumination is not practical. A condenser of larger aperture than that for No. 2 is required, because it must, of course, equal that of the objective.

It is interesting to notice that with No. 2, the  $\frac{3}{4}$  cone illumination, if the object is placed at the edge of the image of the side of the flame, especially if the edge is somewhat undefined by the condenser being brought a trifle within or without its focus, the resolving power is increased. This well-known illuminating dodge becomes an important confirmation of the new theory, for Mr. Wright, with reference to the action of the illumination from a wide-angled cone, says, in Art. 23, that a "plenum" of rays "in the same phase" diverge from each point in the structure, so that the points become centres of wave propagation, but along the edge of the cone diffraction phenomena arise. Does not, therefore, the above experiment fully confirm the statement in Art. 23, which should itself be read, as it is far better expressed than in my condensation.

In this connection it will be found that a curious effect is produced when examining fine-lined structures with the naked eye, if an obstacle is held somewhat nearer the eye and the lined

structures be viewed through the haze at the edges of the obstacle. For example, if the finger be held in front of the eye at a distance of about four inches, when the vision is normal, and if the eye be focussed on some object at a greater distance, a haze will be seen surrounding the out-of-focus finger. Now if a fine-lined object, nearly at the limit for resolution, be examined, the resolution will be found to be strengthened when it is viewed through the haze at the edge of the finger. A black-edged card might with advantage replace the finger. Some ridges, which counted 45 to the inch, on the black cover of a cloth-bound book were examined, and it was found that they became much more distinct when they were viewed through the haze at the edge of a card.

After this digression, let us see what Mr. Wright says about the Microscopic Image. In Art. 21 (*b*) he attacks the Eichhorn intercostals from a point of view different to that I have taken, and I heartily concur in all his conclusions. The next paragraph (*c*), with regard to the statement that the striæ of *A. Pellucida*, which Mr. Sollit measured as 120,000-130,000 per inch, were ghosts, is not so clear for the following reasons:—

First.—At that time there was no objective with a resolving limit approaching such figures.

Secondly.—A false ghost must always be within the resolving limit of the lens.

Thirdly.—A false ghost must always be an integral multiple of the true structure.

Therefore, assuming that Mr. Sollit had a coarse *A. Pellucida* of say 90,000 striæ per inch, the coarsest false ghost he could have made must have had 180,000 lines per inch, and the next one 270,000, and so on. Now, as 180,000 lines per inch was beyond the limit of any lens then constructed, no one had ever seen a ghost of the true striæ on *A. Pellucida*. In some dry mounts of this diatom, especially those burnt on cover, there are apparently coarse wrinklins of some outer membrane, which have nothing whatever to do with the striæ in question; these can easily be seen with any quarter-inch objective. It is more than probable that some running about 40,000 per inch were doubled and afterwards erroneously measured, for it is



only in comparatively recent years that accurate measurements of the so-called striæ on the diatomaceæ have been made.\*

The deductions which Mr. Wright has postulated in the next Art., No. 22, is a most important addition to microscopical literature. Speaking of the Fresnel interference bands, *i.e.*, microscopical images formed by a small cone or beam, centric or excentric, he says "that these lines are in no sense images, but mere interference bands or fringes with no definite focus; that whenever thus really produced they are a constant source of uncertainty and error, and to be got rid of as far as possible by the use of large aplanatic cones; that when we use such cones we lose such fringes altogether and get a real focussed image, true to the object so far as the aperture and correction of the lens permit of its definition; and that this image is a dioptric image."

Further on, he says "that the narrow cone and the diffraction theory stand or fall together." This statement is perfectly correct, provided that it is the diffraction theory as enunciated by Abbe and his exponents which is meant; and can this be wondered at, seeing the theory at its inception was not even a logically sound argument?

With regard to Abbe's statement, quoted in this article, *viz.*, "Strictly similar images cannot be expected, except with a central illumination with a narrow incident pencil, because this is the necessary condition for the possible admission of the whole of the diffracted light," let me put before you a simple experiment. Place a *P. Angulatum* under an objective of '65 N. A., and illuminate it by a narrow central incident pencil; you will see neither structure nor spectra. Enlarge the incident cone until it fills three-quarters of the objective, and you will now see both spectra and the angulatum pattern. This proves that the wide cone is a better condition than the narrow incident pencil for the admission of diffracted light.

I am perfectly aware of the imperfections of this brief review on Mr. Wright's important articles, but it has been my endeavour to discuss them fairly; neither have I consciously slurred over or omitted any difficulties or unexplained points for the purpose of making the case appear stronger than it really is. The sub-

\* "M. M. J.," Vol. xv. (1876), p. 223.

ject is so large that it would take a longer time than is at my disposal this evening to do it full justice, and I am also aware that although it is a momentous question in the interests of microscopy, it is, nevertheless—and from the nature of the case must be—dry as dust. An apology, therefore, is due to you for bringing it before you at an Annual Meeting, when it is naturally expected that the address should be of a lighter nature, but I felt that its importance was paramount, and therefore ventured to trespass on your good nature.

In conclusion, let me briefly sum up. In the first place, it will be conceded by those who have studied his articles without prejudice that Mr. Wright has been the first to give a correct theory of microscopic vision with large illuminating cones, and, secondly, that he has disproved the theory, generally accepted among microscopists for the past 20 years, with regard to spectral images, and has shown that they belong to a class of physical phenomena known as Fresnel's interference bands.

---

## ON A NEW CAMERA LUCIDA.

BY EDWARD M. NELSON, F.R.M.S.

*(Read November 16th, 1894.)*

The well-known neutral tint of Dr. Beale is such a simple and inexpensive form of camera that it seemed a pity that the only drawback to its coming into more general use, viz., that of transposing its erect image, should not be corrected. This drawback is a serious one, because a picture drawn by a Beale's camera only becomes similar to the original object when it is viewed as a transparency from the wrong side of the paper. For instance it is well known that some insects have one leg on one side of their bodies different to the corresponding leg on the other side, and it is necessarily important that such microscopic objects should be depicted correctly. Now all we have to do is to correct the transposition without altering the image in any other manner. Obviously this can be accomplished by adding a lateral reflection. If, therefore, we place over the eye-piece, at an angle of  $45^{\circ}$ , a small silvered mirror (a first surface mirror is unnecessary, a piece of ordinary silvered glass, such as is used in sextants, answers every purpose), so that when the microscope is placed in a horizontal position the image may be reflected at right angles to the body, either to the right or left hand of the microscope in a plane parallel to that of the table, and then if we intercept this horizontal beam by an ordinary Beale's neutral tint, an erect image, with its transposition corrected, will be reflected upwards to the eye, and seen on the table through the neutral tint in the usual way. In brief, the lateral reflection corrects the transposition, while the vertical reflection forms the first surface of the neutral tint, the inversion of the image. The resultant image is, therefore, precisely similar to the object on the stage of the microscope. Anyone possessing a right-angled prism can produce the same effect by placing it anywhere between the objective and the eye-piece, and by placing an ordinary neutral tint on the eye-piece; of course, the horizontal position of the right-angled body, when the microscope itself is in a horizontal position, must be maintained.

## PROCEEDINGS.

OCTOBER 5TH, 1894.—CONVERSATIONAL MEETING.

The following objects were exhibited:—

<i>Comatula rosacea</i> , pinnæ with ova	...	Mr. G. E. Mainland.
<i>Aulacodiscus excavatus</i>	... ..	Mr. H. Morland.
<i>Euchlanis triquetra</i> , ♂ ♀, mounted	...	Mr. C. Rousselet.

OCTOBER 19TH, 1894.—ORDINARY MEETING.

E. M. NELSON, Esq., F.R.M.S., President, in the Chair.

The minutes of the preceding meeting were read and confirmed.

The following gentlemen were balloted for and duly elected members of the Club:—Mr. R. W. Howard, Mr. F. Hughes.

The following additions to the library were announced:—

“Journal of the Royal Microscopical Society”	... ..	} From the Society.
“Proceedings of the Manchester Microscopical Society”	... ..	
“The Botanical Gazette”	... ..	In Exchange.
“Proceedings of the Belgian Microscopical Society”	... ..	} ”
“Annals of Natural History”	... ..	
Series of reprints on “Infusoria”	... ..	Purchased.
		Monsieur Certes.

The Secretary said it was well known to members that the specimens in the cabinet had for some long time been undergoing revision, but as it was a very tedious and laborious task, owing to the large number to be gone over, and still very far from completed, the Committee had deemed it advisable to print a catalogue of the Williams collection, which was a fairly representative and carefully-selected one, as a beginning, and this was now ready and obtainable from the Curator, price sixpence a copy. He thought it would prove a useful guide to such of their junior members who might be putting together a

general collection of their own, as it was a classified catalogue, and not merely a list of preparations.

Mr. Goodwin thought that some greater facilities might be afforded to the members of the Club for seeing what slides were in the cabinet. If some microscopes could be kept there as well as the slides it would enable them to do this without the trouble of bringing their instruments with them.

The President said there was a drawback to this idea on account of the high charges made for rental, and he really thought with regard to these preparations the best thing to be done was to select from the catalogue, and take the slides home and study them at leisure.

Mr. Vezey said that fresh regulations as to borrowing slides would be found printed inside the catalogue, which increased the facilities hitherto given, and were much more to the advantage of the members than those previously in force.

Mr. Watson exhibited a microscope which was similar in design to the Van Heurck microscope, but contained several alterations and improvements. The stage could be rotated completely either by the hands or by rack work. The milled heads were fixed on one centre, and did not travel with the stage. The optical centre was 10in. high from the table when horizontally placed, and the spread of the feet also 10in., giving great stability. There was also a centring motion which could be clamped when required.

The President thought they were to be congratulated upon having so fine an instrument upon the table before them. It was beautifully made, and he was satisfied it was capable of doing the highest work required to be done. The complete rotation of the stage was an advantage, and it should be remembered that none of the movements in the old microscope had been sacrificed in obtaining it.

Mr. Karop said he had received from Mr. Swift for exhibition a new mounting for an Abbe condenser, which was made to carry the usual iris diaphragm, but had a movement by which it could be made eccentric and rotated in that condition. He also exhibited a new pond weed grapnel which was made for conveniently carrying in the pocket.

The President thought the Abbe condenser was a very prettily contrived thing and thoroughly well made, but it was

designed for obtaining oblique light, and for making false images of diatom structure. The pond weed apparatus was just like a "centipede" used for grappling submarine cables.

Mr. Western thought it was a great improvement upon the ordinary drag hook, which was an extremely inconvenient thing to carry in the pocket and uncomfortable to sit upon.

Messrs. Ross and Co. sent also for exhibition a collection of their latest instruments, representing nearly every class of their work, from the small star microscope upwards.

The President said they were much indebted to Messrs. Ross for sending down these instruments. The chief novelty was the means for rotating the body on the round stand, by means of which very great stability was secured when the body was inclined or placed in the horizontal position. The second novelty seemed to be in the substage, which was made somewhat on the Reichert plan, turning out on one side in a manner which certainly had its advantages. He thought this arrangement of the foot would make it very good for photography, for though the base was circular it really rested on three points, and therefore it was steady.

Mr. Karop could not help thinking that the position of the iris diaphragm was a mistake, because it cut off the rays in the wrong place, viz., too near the apex of the cone.

Mr. Ingpen said with regard to the diaphragm not being used with the condenser, the old French plan was to have three apertures, and these were adopted and used in the old Zeiss instruments, but they were meant more to be used when the condenser was out of use. The origin of the plan was the old Varley dark chamber.

Mr. Western read a paper "On four Foreign Rotifers not previously recorded as found in Britain."

Mr. Bryce said he had an opportunity afforded him of seeing the form last mentioned by Mr. Western, and he came strongly to the conclusion that it was not *Rotifer mento*, i.e., if any reliance was to be placed upon Anderson's drawings. It was very like *Rotifer vulgaris*, and required very careful observation to distinguish it.

The thanks of the meeting were voted to Mr. Western for his communication.

Mr. Karop said that as the matter on the agenda paper was

somewhat short, he should like to read an interesting letter he had received from Mr. T. H. Buffham earlier in the year, relating to the organisms found in the estuary of the Thames at a certain period, and which gave rise to the phenomenon known as "foul" or "May-water." The subject was brought forward at the May meeting of the R.M.S., by Mr. Shrubsole, of Sheerness-on-Sea, who gave an interesting account of this peculiar state of the water, and distributed samples. Knowing Mr. Buffham's active concern with anything relating to marine algæ, to which these organisms presumably were related, and thinking he might be able to throw some light upon it, I wrote to him, and he, after examining material provided by Mr. Shrubsole, sent me this letter (read). The chief forms found in the water were spheres, about the size of small volvox, or cylindroids of transparent, gelatinous stuff, and containing large numbers of greenish-yellow or brown crescentic bodies imbedded in it. The exact nature of these organisms appears to be, at present, quite undetermined. The matter was of economic as well as of scientific importance, because Mr. Shrubsole states that during their apparition the whole of the fish precipitately retire from the mouth of the river and so put an end for a time to one of the chief industries of the locality. It seemed reasonable to suppose that the reason for this emigration of the fish was either that the organism was poisonous or unfitted for food, or, from its abundance and slimy consistence, it would choke up the breathing apparatus of the fish if they remained. I understand the phenomenon is of yearly recurrence and it certainly deserves careful study.

Notices of meetings, etc., for the ensuing month were then given, and the proceedings terminated. The following objects were exhibited:—

<i>Syringa</i> , section of flower bud	...	...	Mr. H. E. Freeman.
<i>Floscularia campanulata</i> , mounted	...	...	Mr. C. Rousselet.

---

NOVEMBER 2ND, 1894.—CONVERSATIONAL MEETING.

The following objects were exhibited:—

<i>Floscularia cornuta</i>	...	...	...	Mr. M. Allen.
<i>Rotifera</i> , various species	...	...	..	Mr. W. Burton.
<i>Corethra plumicornis</i>	...	...	...	Mr. J. A. Daniell.

Stem section of a Brazilian Liana	...	Mr. G. Dunning.
<i>Oscillaria</i> , sp.?	... ..	Mr. W. Goodwin.
<i>Peueroplis pertusus</i>	... ..	Mr. A. Jenkins.
<i>Alcyonium palmatum</i>	... ..	Mr. G. Mainland.
<i>Navicula tumescens</i>	... ..	Mr. H. Morland.
<i>Corallistes Bowerbankia</i> , Ceylon...	... ..	Mr. B. Priest.
<i>Euchlanis lyra</i> , mounted	... ..	Mr. C. Rousselet.
<i>Arrenurus buccinator</i>	... ..	Mr. C. D. Soar.

---

NOVEMBER 16TH, 1894.—ORDINARY MEETING.

E. M. NELSON, Esq., F.R.M.S., President, in the Chair.

The minutes of the preceding meeting were read and confirmed.

The following gentlemen were balloted for and duly elected members of the Club:—Mr. Walter P. Shadbolt, Mr. Edwin Wooderson, Mr. W. B. Stokes.

The following additions to the library were announced:—

“Nova Acta Car-Leopold Akademie Nat. Cur.,” two vols.	
“Proceedings of the Literary and Philosophical Society of Man- chester” ... ..	} From the Society.
“Annals of Natural History” ...	Purchased.
“Photomicrography” ... ..	Dr. Van Heurck.
“Synopsis of the Naviculoid Diatoms,” Part I.... ..	} Prof. Cleve.

The thanks of the Club were voted to the donors.

Mr. Karop said the last on the list of additions to the library deserved something more than a mere formal acknowledgment. This was Prof. Cleve's Synopsis, the first instalment of a very important work. He had taken one genus, the *Naviculæ*, which by the unnecessary and unscientific multiplication of species had grown to most unwieldy proportions, and endeavoured to reduce it to order. The literature was equally colossal and scattered, and, therefore, a revision necessarily involved very considerable labour and research, as well as special knowledge of the subject, and those who worked at diatoms would not be astonished to hear that it had occupied Prof. Cleve the best part of eight years. The present part



contained four plates, and he was informed the second would not be long before it appeared.

A special vote of thanks to Prof. Cleve for his valuable donation was unanimously passed.

The President said he had also received from a friend—Mr. Marryat—two beautiful series of photomicrographs of Karyo-Kinesis in *Lilium bulbiferum*. These were all taken by cheap lenses with peacock-blue glass screen, the sections being stained with blue hæmatoxylin.

The President said that he wished to make a remark with regard to a note of his which was read on March 16th last. In that note, in which he had made no claim to originality, he had referred to common optical formulæ, which could be found on the first page of elementary text-books on the subject; but the alternative formula (vi.) was, so far as he knew, not given in any text-book, and, therefore, might have been considered original. Last night, however, while searching some back volumes of the "R.M.S. Journal" for a reference on a totally different subject, he came across the same formula in a paper by Mr. C. R. Cross in the "M.M.J.," 1870, Vol. iv., p. 149, and in the "Journal of the Franklin Institute" for June, 1870, p. 401. So that to Mr. Cross must the honour be accorded for first publishing this simple and very useful formula.

The President said he had lately come across an article exhibited in a tobacconist's shop as a pipe cover. It was an iris diaphragm, which might be used for cheap microscopes. He had brought it to the meeting for inspection.

The Secretary said that at their last meeting Mr. Swift exhibited a little portable pond drag which could be carried in the pocket. Since then Mr. Allen had suggested a further improvement by adding a cap to one end to which an eye was fixed, so that a piece of string could be attached.

The President exhibited and described a new device which he thought might prove of service in microscopical work. It was an addition to the principle of Beale's neutral tint reflector, which, though possessing great advantage over the Wollaston camera or the Soemmering mirror, had the disadvantage of exhibiting the picture laterally inverted. By means of a second lateral reflector this inversion was got rid of and the image appeared erect in both directions.

Mr. J. E. Ingpen thought this would prove a very useful addition to the large number of drawing contrivances which existed. He remembered that many years ago when the subject was before the Club a number of these were exhibited, and if he had known the subject would be cropping up that evening he could have brought up a considerable number of examples.

Mr. Michael said it was difficult to estimate the importance of this contrivance, because a camera which did not distort and did not require the head to be held quite steady was what everybody who made drawings in that way was most anxious to possess, and if anything could be done to get rid of the fatal error of Dr. Beale's camera it would be a most valuable achievement.

The President said that Cook in 1865 tried a mirror for the purpose of casting the image down upon the paper, but with high powers there was insufficiency of light. With low powers, however, it worked very well.

Mr. Ingpen said that an interesting illustration of this method was found in the case of "Varley's Graphic Telescope," which was an instrument of about 6in. focus, with a mirror in front of the object glass. There was a large specially-constructed eye-piece, and then another mirror at an angle of 45 degrees coming half over the eye-piece. Varley wrote a book on drawing instruments, and was going to publish it in conjunction with Mr. Horne, but they quarrelled over it and destroyed all the copies except a very few, one of which he was fortunate enough to obtain through his friend Mr. Ackland.

Mr. Karop thought anyone who could draw hardly required any apparatus at all beyond cross-lines in the eye-piece and some sectional paper. Possibly a camera might be useful for making an outline, but all detail must be put in subsequently, and it was to be borne in mind that the use of any special appliance did not obviate inaccurate drawing in the least, although it was often stated as a sort of guarantee.

The President said that a great deal of the correctness depended upon the person who made the drawing. He remembered once seeing Mr. N. E. Green make a most perfect drawing from the microscope without once looking at the paper.

Mr. Michael thought there could be no doubt that drawing carefully upon square ruled paper gave more accurate results,

but a great deal of time was lost by this method, and a certain amount of rough detail as well as the outline could be done with the camera in a much shorter time. He thought, however, that this was a matter upon which one man could not be taken as a rule for another. Many persons had a difficulty in seeing the paper and the object equally well at the same time, and a man who was a good draughtsman would naturally do better than one who was not, and there was also a good deal in the idiosyncrasy of the individual eye. Personally he might say that he preferred the method with ruled lines.

Mr. Rousselet said he had a home-made camera, which he found to answer very well. A small mirror of speculum metal reflected the image upon a cover-glass, through which the paper was seen. The image in this case was not reversed. The plan was Mr. Usher's invention.

The thanks of the meeting were voted to the President for his communication.

The President intimated that there was nothing further upon the agenda paper, but as he saw Prof. Chas. Stewart present he ventured to ask if he would favour them with a few remarks.

Prof. Stewart said that when he came into the room he had no expectation of being called upon to speak, but as the President had done so he would in response say a few words upon what was to be seen in one particular section of the Museum with which he was more especially connected, and he thought it possible that some persons present might be interested in the structural varieties of fish bones. In the case of fish which had frames of rigid structure, they found these to be composed of a substance which was different in many respects from such bone as they found it in mammals, although it was rather difficult not to regard it as bone. When examined under the microscope it was found to be wanting in the familiar so-called bone-corpuscles; it had a somewhat fibrillated matrix, and in that matrix were rows of large spaces much larger than the ordinary haversian canals. These certainly were not blood-vessels, and they did not contain cells, but if they were hardened and sections were taken they were found to contain fine granular material, but in not one which he had examined had he ever succeeded in finding either a cell or a blood-vessel. The cod, haddock, and fish of that class all had this kind of bone. In other classes of fish a very different structure

was found. In the sword-fish the matrix was traversed by tubes which were no doubt Haversian canals containing blood-vessels, but around each canal were more or less defined lamellæ, but no corpuscles. In another group, which included nearly all the flat fish, the structure differed again, and a typical example was furnished by the "tobacco pipe fish," the bone of which was found to contain numerous fine tubes like those of dentine branching out, and usually terminating in two branches. It was composed of lamellæ, and had all the characters of a thoroughly dentine-like structure. Then in the salmonidæ a further development was found, the matrix being occupied by small spaces, lacunæ, each containing a single cell, but there were no canaliculi. In herrings, carps, and eels, etc., there were lacunæ with well developed canaliculi. As far as he was aware, since the time of Kolliker, there had been very little done in this direction. Most people seemed to be content to make sections of the dry bone and to examine them, but there was no paper, so far as he could ascertain, which treated of the soft parts with which the hard parts were associated. If, therefore, anyone having leisure to do it would undertake the investigation, he would be adding important information to their present knowledge of the subject. Prof. Stewart illustrated his remarks throughout by drawings of the structures upon the black-board, by means of which their peculiarities were made readily apparent.

The President thought they were greatly indebted to Prof. Stewart for his admirable and interesting lecture, for which he had great pleasure in proposing a hearty vote of thanks. This having been carried by acclamation,

Mr. E. T. Newton inquired if the dentine was found in all the bones of the pipe fish, or whether it was peculiar to those only which Prof. Stewart had described.

Prof. Stewart said it was stated that all the bones had that structure. Certainly this was the case with all those which he had himself examined, and he thought it would be a new observation if it was found that the other bones of the fish did not possess the same character.

Announcements of meetings, etc., for the ensuing month were then made, and the proceedings terminated with the usual conversazione. The following objects were exhibited:—

<i>Callidina vorax</i> , <i>C. plena</i> , <i>C. ligula</i>	...	Mr. D. Bryce.
<i>Atherix crassicornis</i> . Mouth organs	...	Mr. H. E. Freeman.
Alge (various fresh-water species)	...	Mr. W. Goodwin.
<i>Daphnia</i> (sp. ?)	... ..	Mr. G. Hind.
<i>Synchaeta tremula</i>	... ..	} Mr. C. Rousselet.
<i>Asplanchnopus myrmeleo</i>	... ..	

---

DECEMBER 7TH, 1894.

<i>Asplanchna priodonta</i>	... ..	Mr. J. M. Allen.
<i>Hydatina senta</i>	... ..	Mr. W. Burton.
Vespa. Mouth organs	... ..	Mr. W. Goodwin.
<i>Schizocerca diversicornia</i>	... ..	Mr. C. Rousselet.
<i>Polyxenus lagurus</i> ...	... ..	Mr. C. D. Soar.
Rock-section. Basalt dyke in lime-	} Mr. G. Smith.	
stone, Carlingford		

---

DECEMBER 21ST, 1894.—ORDINARY MEETING.

E. M. NELSON, Esq., F.R.M.S., President, in the Chair.

The minutes of the preceding meeting were read and confirmed.

The following gentlemen were balloted for and duly elected members of the Club:—Mr. Ferdinand Coles, Mr. Alfred Howard, and Mr. R. Traviss.

The following additions to the library were announced:—

“The Rotatoria of Greenland”	... ..	By Dr. Burgendal.
“La Nuova Notarisia”	... ..	In Exchange.
“The Botanical Gazette”	... ..	”
“Transactions of the Norfolk and Norwich Naturalists’ Society”	} From the Society.	
“Transactions of the Natural History Society of Northumberland”		
“Proceedings of the Nova-Scotian Institute of Science”	} ”	”
“The American Monthly Microscopical Journal”		

The Microscope "	...	...	...	In Exchange.
Le Diatomiste "	...	...	...	
Annals of Natural History "	...			Purchased.
Quarterly Journal of Microscopical Science "	...	...	...	}       "

The thanks of the Club were voted to the donors.

The Secretary said that the paper before them that evening was by Dr. A. M. Edwards, their oldest honorary member. It dealt with the discovery of diatoms in shales older than the Lower Miocene, and since this paper was written he believed Dr. Edwards had claimed to have found them in Silurian strata. He could not read the whole paper as received, some of the geological details being of purely local interest, but Dr. Edwards had given him permission to extract as much as he considered of value, and the salient points of the original paper were entirely preserved. Whether or no they agreed with Dr. Edwards' conclusions was a matter for them to decide when they had heard his views, but, personally, he must say that great caution should be exercised before judging on the presence of such ubiquitous organisms as fresh-water diatomaceæ. From their small size and general distribution in running water they were liable to be carried by percolation far from their place of origin, yet, as Prof. Cleve had lately pointed out, in some cases they might be of great value in geological determinations.

Dr. Edwards' paper was then read.

Mr. E. T. Newton said he had not made diatoms a special study, but it was a well-known fact that they had been found fossil, certainly in the Chalk, and possibly in the Coal Measures, but he did not think there was any record of their presence in the older rocks. He agreed with Mr. Karop that there was always a great probability of their getting washed in, and that the very greatest care was required before it would be safe to say that they really belonged to the rocks amongst which they were found. Still, there was nothing impossible about it. Certain old rocks in Scotland and Cornwall were largely made up of Radiolarians, and some chalky-looking rock from Australia seemed nearly composed of the same small organisms. In thin sections their structure could be very well seen. He thought the subject was one worth looking into,

because there was no reason why diatoms should not be found in the Silurian rocks, but, on the contrary, it might rather be expected that they would.

Mr. Karop thought that the need for care which Mr. Newton had insisted upon could not be too strongly enforced in making any investigations in this direction; everything used should be perfectly free from suspicion, and new pipettes must be used, because the diatoms would cling to anything which once contained them for an indefinite time.

The President said he remembered seeing some curious diatoms in some kind of rock which was sent to them by Mr. Shrubsole.

Mr. Karop said they were common enough in the Tertiary strata, but had not until quite recently been found in strata as old as the Silurian.

Mr. E. T. Newton said it was generally accepted that the higher the grade of an animal the shorter the distance it went back in time; and it was of course also true, on the contrary, that the lower the grade the farther back it was found to extend; if this were true they might expect to find diatoms in the Silurian.

Mr. Karop thought it was understood that their age was great, but being formed of colloid silica, which was soluble in alkaline water, it seemed rather doubtful if they would be able to persist in the manner expected.

Mr. Newton said that the evidences of their existence would not necessarily be destroyed even if they were dissolved, because they would leave their impress in the rocks, and this might be filled up with other matter.

Mr. Morland could quite corroborate what Mr. Karop had said as to the way diatoms had of clinging to tubes, etc. No one could ever be sure that a tube was quite clear from them, even after repeated washing and wiping.

The President made some remarks upon the subject of coloured screens for use with the microscope, and pointed out the advantages to be gained thereby. These could be of a variety of tints, but all would not be found to work equally well for all purposes. Colonel Woodward's screens were made with a solution of ammonio-sulphate of copper, whilst his own were of cobalt blue glass, and Mr. C. Haughton Gill used a Zettnow

screen of sulphate of copper and bichromate of potash. One of the best screens was of a green glass of such a tint as to cut out the red in a bright spectrum. Those who did not possess a spectroscope could get a good spectrum by means of any coarse diatom by using a narrow pencil, and viewing the spectra at the back of the objective when the eye-piece was removed.

Mr. Ingpen said that a splendid spectrum could be obtained in this way with a Cherryfield rhomboides.

The President said that when diatoms were examined on a dark ground colours were often seen, red indicating a coarse and blue a fine structure. In the early days of his microscopical work he had noticed a blue line on the girdle of a *Pinnularia major*, and he at once recognized this as indicating the presence of fine structure. It was not long before he had resolved it into 60,000 striæ per inch. It was an interesting question whether this consisted of rows of minutely perforated structure, if so it must wait for an objective of the future to resolve it, as it was beyond the reach of the best modern objectives. It would be more difficult than the longitudinal striæ on the *A. pellucida*, as there were no edges and raphæ for the manufacture of false ghosts.

Mr. Ingpen said that the medium piperine was irrational. There were some high refractive media he could recommend, among which he might specially mention that composed of one part of bromide of antimony, one part of bromide of arsenic, and one part of piperine. This mixture was rather yellow, but it melted easily at a low temperature.

The Secretary announced that nominations for members to serve on the Committee must be made at their next meeting.

Announcements of meetings, etc., for the ensuing month were then made, and the meeting terminated with the usual conversazione, the following objects being exhibited:—

<i>Stephanoceros Eichhornii</i> ...	...	...	Mr. W. Burton.
<i>Tardigrada</i> (sp.?)	...	...	Mr. C. Rousselet.

---



JANUARY 4TH, 1895.

Cypris-stage of <i>Balanus</i> ... ..	Mr. E. T. Browne.
<i>Conochilus unicornis</i> ... ..	Mr. W. Burton.
<i>Euchlanis pyriformis</i> (mounted) ...	Mr. C. Rousselet.

JANUARY 18TH, 1895.—ORDINARY MEETING.

E. M. NELSON, Esq., F.R.M.S., President, in the Chair.

The minutes of the preceding meeting were read and confirmed.

The following gentlemen were balloted for and duly elected members of the Club:—Mr. G. E. Awde, Mr. B. Cox, Mr. A. Harrison, and Mr. E. Hinton.

The following donations to the library were announced:—

The "Botanical Gazette" ... ..	In Exchange.
A series of reprints of papers by Herr Lauterborn, "On the Marine and Fresh Water Flora of Helgoland" )	Per Mr. Rousselet.
"Annals of Natural History"... ..	Purchased.

The Secretary read the list of nominations by the Committee for officers of the Club for the ensuing year.

The Secretary gave notice of an alteration of the Rules, proposed by the Committee, to be submitted at the next Annual General Meeting, viz., that an Hon. Editor be added to the list of officers in Rules 2, 3, and 9.

The President announced that there would be four vacancies for members of Committee, and invited the members present to nominate gentlemen to fill the same.

The following nominations were then made:—

Mr. Dadswell, proposed by Mr. Hardy, seconded by Mr. Kern.

Mr. Parsons, proposed by Mr. Burton, seconded by Mr. Hembry.

Mr. Bryce, proposed by Mr. Powell, seconded by Mr. Muiron.

Mr. Morland, proposed by Mr. Soar, seconded by Mr. Scourfield.

Mr. Freeman, proposed by Mr. West, seconded by Mr. Lloyd.

The President said these names would be printed on the ballot papers in the usual way, and the election would take place at the next—which would be their Annual Meeting. It

was necessary for two auditors to be selected that evening, and on behalf of the Committee they had appointed Mr. Bryce. He now asked the members to appoint another on behalf of the Club.

Mr. W. Chapman was proposed by Mr. Allen, and seconded by Mr. Burton, and unanimously elected.

Mr. C. Rousselet read a paper "On the Preparation of Rotifers as Permanent Microscopic Objects," supplementary to a communication on the same subject made about two years ago, and detailing the improved methods discovered and adopted in the meantime. The paper was illustrated by the exhibition of a large number of slides under microscopes in the room, and Mr. Rousselet announced his intention to present to the Cabinet of the Club a complete type collection of every species. Already he had successfully mounted 130 species, and he presented to the Club that evening 77 slides, representing 72 species, as a first instalment of his promised donation.

The President thought they were extremely fortunate in the possession of such an active member as Mr. Rousselet, who had thrashed out the subject of fixing and mounting these very difficult objects so thoroughly, and had given a description of the process in a way which would always associate it with the Club. It was hard work, like that which had been described, which would always do more than anything else to keep up their reputation. Their best thanks were due to Mr. Rousselet for his paper, and also for the valuable donation made that evening, and for the promise of a completion of the series in due course.

Thanks to Mr. Rousselet were unanimously voted.

Mr. Goodwin communicated a note on an Alga found at Wanstead Park on October 5th, at the edge of the pond, which seemed to him to be a new species of *Oscillaria*. The filaments were very small, and the endochrome appeared green by transmitted light, but under the microscope it was difficult to say exactly what colour it was, the endochrome being very much concentrated. So far as he could make out, it was a new species, but he had not yet taken the opinion of any specialist on this point, though he thought if it turned out to be new it was worth recording. No new features had been developed in it since the date on which it was found.

Mr. Karop said that if the object described by Mr. Goodwin was really a new species it would, of course, be interesting, but in such lowly plants as Oscillariæ, where reproduction was entirely asexual, they had only morphological characters to depend upon, and therefore he thought it would be wise to wait until it had been submitted to the judgment of an expert. There was such a superabundance of species amongst the protophyta that it was most undesirable to add to them unnecessarily.

The Secretary said that the publication of the list of members of the Club would be due this year, and asked that any alterations in addresses might be communicated to Mr. Vezey.

Announcements of meetings, etc., for the ensuing month were then made, and the proceedings terminated with the usual conversazione, at which the following objects were exhibited:—

*Melicerta ringens* ... .. Mr. J. M. Allen.

*Stycoptera contaminata* ... .. Mr. H. E. Freeman.

*Spirillum* ... .. Mr. G. Hind.

Mr. C. Rousselet exhibited the following mounted objects under several microscopes:—

*Asplanchna priodonta.*

*Noteus quadricornis.*

*Asplanchnopus myrmeleo.*

*Notommata aurita.*

*Brachionus pala.*

„ *laciniolata.*

*Conochilus volvox.*

*Notops brachionus.*

*Copeus caudatus.*

*Ploesoma Hudsoni.*

*Diglena forcipata.*

*Proales parasita* (in *Volvox globator*).

*Euchlanis hyalina.*

*Rhinops (?) orbiculodiscus.*

„ *pyriformis.*

*Succulus viridis.*

„ *triquetra.*

*Stephanoceros Eichhornii.*

*Hydatina senta.*

*Synchaeta tremula.*

*Limnias annulatus.*

*Triphylus lacustris.*

„ *ceratophylli.*

*Melicerta Ringens.*

---

FEBRUARY 1ST, 1895.

*Euchlanis diletata*... .. Mr. W. Burton.

*Surirella fastuosa* ... .. Mr. H. Morland.

*Cyclois in Nitella* ... .. Mr. W. R. Traviss.

---

FEBRUARY 15TH, 1895.—ANNUAL MEETING.

E. M. NELSON, Esq., President, in the Chair.

The minutes of the preceding meeting were read and confirmed.

The following gentlemen were balloted for and duly elected members of the Club:—Mr. H. Cheese, Mr. T. S. Davis, Mr. G. J. Harris, Mr. W. J. Marshall, Dr. J. W. Measures, Mr. W. J. Wonfor, Dr. Tatham.

The Secretary announced that the "Proceedings of the Smithsonian Institution" had been presented to the library.

Announcements of meetings, etc., for the ensuing month were made, and the business of the annual meeting was then proceeded with.

The Secretary said that at their last ordinary meeting notice was given that an amendment to Rules 2, 3, and 9 would be proposed, to the effect that in future the Hon. Editor of the Journal should be a member of the Committee. This could hardly be called an innovation, because practically the Editor had always attended, as he happened to be otherwise a member of Committee, but to meet the case of anyone becoming the Editor who was not one of the Committee this addition seemed necessary. Of course, the desirability of the Editor of the Journal being present at the meetings of the Committee would be obvious to all.

The proposal to add the words "Honorary Editor of the Journal" to Rules 2, 3, and 9 was then put from the chair and unanimously agreed to.

The President having appointed Messrs. J. M. Allen and C. L. Curties as scrutineers, the ballot was proceeded with for the election of officers and four members of Committee. The scrutineers subsequently reported that the whole of the officers in the list of nominations had been duly elected, and also that Messrs. Morland, Dadswell, Bryce, and Parsons had been elected members of Committee.

The Secretary read the report of the Committee for the past year.

The Treasurer read his annual statement of accounts for the same period.

The adoption of the report and balance sheet having been moved by Mr. Richard Smith and seconded by Mr. J. G. Waller, was put to the meeting and carried unanimously.

The President then delivered the customary annual address.

Mr. A. D. Michael said he rose to ask the members present to do something which he felt they were ready to do spontaneously, and that was to pass a very hearty vote of thanks to the President for the very able and learned address to which they had just had the pleasure of listening. The subject dealt with was one of first-class importance, for there could be nothing more important to a microscopist than to know the exact amount of light with which he could fill his objective in order to obtain the best possible results. It was also obvious that this ought to be intelligently done, and not by mere rule of thumb. Such an address as that, when they were able to read it carefully for themselves, would do much towards enabling them to decide as to what was the theory of microscopic vision which they could most confidently rely upon. Until they knew this they could not decide as to which was the best method for using their microscopes to the best advantage. The subject was one of leading importance to them as microscopists, and they would all agree that it had been most ably treated by their President in his address to them that evening.

Mr. W. Burton having seconded the motion, it was put to the meeting by Mr. Michael, and carried by acclamation.

The President thanked the members for this vote of thanks, and for the very kind way in which it had been received and carried. He also desired to thank them very heartily for the honour which they had conferred upon him by electing him as their President for another year.

A vote of thanks to the Auditors and Scrutineers was then moved by Mr. Western, seconded by Mr. Rousselet, and carried unanimously.

A vote of thanks to the President and Officers of the Club for their services during the year was similarly honoured.

Mr. Karop said—It is my pleasant duty on these occasions to reply, on behalf of the Committee and other officers, to the vote of thanks just moved. During the Club's career of nearly thirty years it is surprising to note how few changes, relatively speaking, have occurred in its executive, a fact creditable to both Club and officers. One reporter only—Mr. Lewis—has held his post continuously since 1867, and, with very few exceptions indeed, has attended every meeting. There have been three Treasurers, Mr. Hardwicke, who died in office, Mr.

Gay, and Mr. Vezey, who, he hoped, would long remain; two Librarians, Mr. Jaques and Mr. A. Smith; four Curators, Messrs. Ruffle, Hailes, Emery, and Browne; and four Secretaries, Messrs. Bywater, White, Ingpen, and Karop. In regard to the latter office, however, he thought it might be a mistake for a Secretary to continue much over ten years; he would be apt to get into a groove and let things take their own way too much. In all concerns probably, an infusion of fresh activity was occasionally beneficial, and if the members at any time were of opinion their present Secretary had held his post long enough, he trusted they would just say so, and he should at once be willing to make room for a more efficient successor. There was another matter he should like to be allowed to refer to. Some might have thought the penultimate paragraph of the Report, concerning the non-payment of subscriptions, was rather severe, and he did not suppose for a moment it applied to anyone present that evening. At the same time it was a hard fact, and one that had to be considered by those responsible for the maintenance of the Club, but as probably very few ever troubled about the balance sheet after hearing it read, he would endeavour to show its importance by a few figures. Up to the end of December, 1894, there were 345 members on the books, and if all pay their subscriptions, these total £172 10s. Our chief items of expenditure are for rent and attendance, and the Journal, which, taking last year's figures, together amount to £150, thus absorbing the subscriptions of 300 members, leaving about £22, which, with other assets from sale of Journal, advertisements, and investments, give us at the very utmost £65 to pay for printing, stationery, postage, books and binding, extra meeting, if held, and other petty expenses. But, unfortunately, there are always a large number of subscriptions in arrear, and considering the advantages the members possessed of meeting in one of the best rooms in London, well warmed and lighted, a Journal, and a Library and Cabinet at their disposal for the absurdly small sum of ten shillings per annum, it was not asking too much that at least it should be paid with reasonable promptitude. On behalf of the officers of the Club he thanked the members for the cordial manner in which they had passed the vote.

The proceedings then terminated.



TWENTY-NINTH ANNUAL REPORT OF THE  
COMMITTEE.

Taking all circumstances into account, your Committee is happy to state that the Club's career during the past year has been, on the whole, satisfactory.

The number of new members is not so large as could be desired, twenty-five only having been elected in the twelve months ending December, 1894. A considerable number of resignations have also been notified, and three have been lost by death, leaving the total on the list somewhat smaller than usual. Your Committee is of opinion that the advantages undoubtedly possessed by the Club, considering the extremely small amount of the subscription, might be made more widely known by members themselves, and so lead to an increase of numbers.

The attendances at the meetings, however, have been noticeably good, and much interest taken in the proceedings. The papers read, although perhaps falling somewhat short of the average in quantity, have been good and thoughtful contributions.

The following is a list of the chief:—

February.—The Presidential Address, by Mr. E. M. Nelson.

March.—“On the determination of the Foci of Microscopic Objectives,” by Mr. E. M. Nelson. “On *Amœba*,” by Mr. H. W. King.

May.—“Notes on Foreign Rotifers since found in Britain,” by Mr. G. Western.

June.—“On *Distyla spinifera*,” by Mr. G. Western. “On *Ilyocryptus agilis*” (n. sp.), by Mr. D. J. Scourfield.

September.—“On *Cyrtonia tuba*,” by Mr. C. Rousselet. “Further notes on *Macrotrachelous Callidineæ*,” by Mr. D. Bryce.

October.—“Notes on four Foreign Rotifers since found in Britain,” by Mr. G. Western.

November.—“An addition to Beale's Reflector,” by Mr. E. M. Nelson.

December.—“On the Diatomaceæ older than those of Virginia, etc.,” by Dr. A. M. Edwards.

A Special Exhibition Meeting was held at Freemasons' Tavern on May 4th, attended by 140 members and 390 visitors. The arrangements of the cloak-rooms and refreshment department were certainly very deficient, owing to the overcrowded state of the building generally on this occasion, but the inconvenience to many members and their friends, however unfortunate, could not be foreseen when the room was hired some four months in advance. The exhibits were generally good, and the excellent orchestra, under the direction of Dr. Dundas Grant, for whose services the Club is entirely indebted to the kind offices of Mr. J. W. Reed, was greatly appreciated by everyone present. The Committee desires to thank all who assisted at this meeting, and most particularly Mr. Reed, Dr. Grant, and the musicians. The expenses, as before decided, were defrayed by the Club.

Two Journals have been issued since the last Report, completing the Fifth Volume of the Second Series. The October Number was considerably delayed owing to the loss of a portion of the MSS. in the post. The advertisements on the covers have produced the sum of £15 19s. 6d., as will be seen in the balance-sheet. As it is more than might have been expected, it is only right to say this welcome addition to the Journal fund is solely due to the energy of Mr. C. Rousselet.

Aware of the long time which necessarily must elapse before the entire revision of the Cabinet can be completed, the Committee deemed it advisable to issue in the meantime a catalogue of the preparations in the Williams' bequest, a fairly representative collection of nearly 700 slides. The list of the Diatomaceæ in possession of the Club and the Foraminifera in the Hailes' Collection being also finished, a catalogue of these is in the press, and will shortly be ready. The thanks of the Committee are due, and hereby offered, to Messrs. Browne, Morland, and Priest, who severally undertook the whole labour, and it is no light one, of making these lists, and also to Mr. Nelson, who, in addition to the already long list of his benefactions to the Club, has most kindly undertaken the expenses of printing the catalogue of the Hailes' Collection.

The finances may be said to be in a fairly satisfactory con-



dition ; the receipts from subscriptions are about the same as for the previous year, while the sale of Journals has brought in nearly £10 more. The item for advertisements has already been referred to. The expenditure has been very carefully watched, and the Journal kept within the sum assigned to it. Several compounding fees have been paid during the past few years, and the Committee has therefore thought it wise to add a small amount to the investment in Consols, bringing up the total to £200.

Many members appear to be under the impression that payment of their subscription need not be made until they have received one or more applications for it. This entails an unnecessary outlay for printing and postage, to say nothing of the extra and disagreeable labour imposed on the Treasurer. Members are therefore reminded that subscriptions are due in advance on the 1st of January in each year, and should be remitted within a reasonable time from that date.

Your Committee desire to thank the officers for their valuable and indispensable services. In conclusion, they have every confidence in the prosperity of the Club, and that it will continue to meet the requirements of the amateur and further the advancement of microscopy, the objects for which it was constituted thirty years ago.

---

# QUEKETT MICROSCOPICAL CLUB.

*Treasurer's Statement of Accounts for the Year ending 31st December, 1894.*

	£ s. d.			£ s. d.		
<b>DR.</b> To Balance from 1893 ... .. " Subscriptions received in 1894 ... .. " Dividends on Investments ... .. " Sale of Journals ... .. " Sale of Tubes ... .. " Receipts for Advertisements ... ..	... .. ... .. ... .. ... .. ... .. ... ..	206 2 4 173 0 6 4 19 8 22 3 1 0 3 11 15 19 6	... .. ... .. ... .. ... .. ... .. ... ..	By Rent of Rooms and Bookcases ... .. " Expenses of Journal ... .. " Postage ... .. " Printing and Stationery ... .. " Attendance .. .. " Books purchased ... .. " Cost of Conversazione ... .. " Amount Invested in £2 15s. Consols ... .. " Petty Expenses ... .. " Balance at Bank ... ..	... .. ... .. ... .. ... .. ... .. ... .. ... .. ... .. ... .. ... .. ... ..	54 12 0 92 2 8 5 6 10 13 11 7 6 0 0 6 1 0 12 5 6 55 16 6 1 15 0 174 17 11 <hr style="width: 100%;"/> £422 9 0

Moneys invested in £2 15s. Per Cent. Consols, £200.

We, the undersigned, having examined the above statement of Income and Expenditure, and the Vouchers relating thereto, hereby certify the same to be correct.

DAVID BRYCE,  
 W. INGRAM CHAPMAN, } Auditors.

JANUARY 21st, 1895.

## Q.M.C. EXCURSIONS, 1894.

Reference Numbers.	Dates.	Localities.	Number of Members of the Q.M.C. attending.	Number of Members of other Societies attending.	Number of Visitors.	Totals.
1	April 7	Royal Botanic Gardens	44	14	22	80
2	„ 21	Chingford ... ..	13	1	—	14
3	May 5	Enfield ... ..	13	—	1	14
4	„ 19	Highams ... ..	9	—	—	9
5	June 2	Hertford Heath ... ..	6	1	1	8
6	„ 16	Whitstable ... ..	13	1	1	15
7	„ 30	Oxshott ... ..	9	—	1	10
8	July 14	Woking ... ..	7	1	—	8
9	„ 28	Richmond Park ... ..	5	—	—	5
10	Sept. 1	Keston ... ..	7	2	3	12
11	„ 15	Staines ... ..	4	—	—	4
12	„ 29	Snaresbrook... ..	10	2	—	12

Names of members who sent lists of objects found by them:—

B. Burton, W.	So. Southon, W. H.
D. Dunning, C. G.	Th. Thompson, Percy
P. Parsons, F. A.	T. Turner, C.
R. Rousselet, C. F.	Wb. Webb, J. C.
Sc. Scourfield, D. J.	W, Western, G.
S. Soar, Charles D.	

## LIST OF OBJECTS FOUND ON THE EXCURSIONS.

NOTE.—The numbers following the names of the objects indicate the excursions upon which they were found, and the letters indicate the names of the members recording the same. When an object is frequently recorded, the initials of the names of the members are omitted.

CRYPTOGAMIA. *ALGÆ.*

<i>Eudorina elegans</i>	. . . . .	1, 2, W.
<i>Gonium pectorale</i>	. . . . .	1, 2, 8, W.
<i>Nostoc verrucosum</i>	. . . . .	8, T.
<i>Pandorina morum</i>	. . . . .	2, 5, 8, 11, W.
<i>Prasiola calophylla</i>	. . . . .	10, 11, T.
<i>Raphidium falcatum</i>	. . . . .	10, 11, T.
<i>Volvox globator</i>	. . . . .	1, 2, 3, 5, 7, 8, 9, 10, 11.

## DESMIDIACEÆ.

<i>Arthrodesmus incus</i>	. . . . .	10, 11, T.
<i>Closterium lunula</i>	. . . . .	1, 2, 3, 5, 7, 8, 10, 11.
,, <i>rostratum</i>	. . . . .	7, 10, 11, T.
<i>Cosmarium margaritifera</i>	. . . . .	8, 10, 11, T.
<i>Docidium baculum</i>	. . . . .	8, T.
,, <i>Ehrenbergii</i>	. . . . .	11, T.
<i>Micrasterias denticulata</i>	. . . . .	10, W.
,, <i>rotata</i>	. . . . .	10, T.

## CHARACEÆ.

<i>Chara vulgaris</i>	. . . . .	3, B.
-----------------------	-----------	-------

## PROTOZOA.

<i>Acineta mystacina</i>	. . . . .	1, P.
<i>Actinophrys picta</i>	. . . . .	8, W.
,, <i>sol</i>	. . . . .	1, D.; 7, 10, 11, 12, T.
<i>Actinosphærium Eichhornii</i>	. . . . .	11, T.
<i>Ægyria oliva</i>	. . . . .	3, 12, P.
<i>Amphileptus anser</i>	. . . . .	11, P., W.
,, <i>flagellatus</i>	. . . . .	4, P.
,, <i>gigas</i>	. . . . .	8, W.
<i>Anthophysa vegetans</i>	. . . . .	5, W.; 8, P., W.; 11, 12, P.
<i>Arcella dentata</i>	. . . . .	3, 7, T.; 8, W.; 9, T., W.; 11, W.

<i>Arcella vulgaris</i>	. . . . .	3, 5, 7, 8, 9, 11.
<i>Bursaria truncatella</i>	. . . . .	1, T.; 3, B., P.
<i>Carchesium polypinum</i>	. . . . .	1, T.
<i>Centropyxis aculeata</i>	= <i>Arcella</i>	
<i>aculeata</i>	. . . . .	8, 9, 11, T.
<i>Clathrulina elegans</i>	. . . . .	11, P.
<i>Coleps hirtus</i>	. . . . .	1, 2, 11, 12, T.
<i>Condyllostoma stagnale</i>	. . . . .	1, 2, P.; 3, B.
<i>Cothurnia imberbis</i>	. . . . .	1, T.; 3, B.
<i>Didinium nasutum</i>	. . . . .	3, P.
,, n.s. (J. G. Grenfell)	. . . . .	1, W.
<i>Diffugia corona</i>	. . . . .	9, W.
,, <i>globulosa</i>	. . . . .	2, 8, 9, W.
,, <i>oblonga</i>	. . . . .	3, 11, T.
,, <i>proteiformis</i>	. . . . .	1, 3, 8, 10, 11, T.
,, <i>pyriformis</i>	. . . . .	3, B.; 8, W.; 9, T.
<i>Dimastigoaulax cornutum</i>	. . . . .	11, P., T., W.
<i>Dinobryon sertularia</i>	. . . . .	3, 4, 5, 10, 11, 12.
<i>Ephelota coronata</i> ?	. . . . .	6, P.
<i>Epistylis anastatica</i>	. . . . .	1, D., W.
,, <i>flavicans</i>	. . . . .	1, 4, P.
,, <i>plicatilis</i>	. . . . .	10, T.
<i>Euglena spirogyra</i>	. . . . .	8, 10, T.
,, <i>viridis</i>	. . . . .	8, 10, T.
<i>Euglypha alveolata</i>	. . . . .	8, W.
,, <i>ciliata</i>	. . . . .	8, 10, W.
<i>Euplotes patella</i>	. . . . .	1, 3, T.
<i>Litonotus fasciola</i> = <i>Dileptus folium</i>	. . . . .	1, D.
<i>Loxophyllum meleagris</i>	. . . . .	9, 11, P.
<i>Mallomonas Plosslii</i>	. . . . .	7, P.
<i>Nebela carinata</i>	. . . . .	8, W.
,, <i>collaris</i>	. . . . .	8, 10, W.
,, <i>flabellum</i>	. . . . .	10, W.
<i>Noctiluca miliaris</i>	. . . . .	6, Wb.
<i>Opercularia nutans</i>	. . . . .	1, 2, P.
<i>Ophrydium versatile</i>	. . . . .	9, P., T.
<i>Ophryodendron abietinum</i> *	. . . . .	6, P.
<i>Paramecium aurelia</i>	. . . . .	3, B., T., W.; 8, 11, T.

\* *Ophryodendron abietinum* had some of the tentacular filaments capitate.

<i>Peridinium tabulatum</i>	. . .	1, P.; 3, 5, 11, W.
<i>Phacus longicaudus</i>	. . .	1, 3, 8, 9, 10, 11.
<i>Phialina vermicularis</i> ?	. . .	1, P.
<i>Platycola decumbens</i>	. . .	2, P.
<i>Pleurotrichalanceolata</i> = <i>Stylonichia</i>		
<i>lanceolata</i>	. . .	3, T.
<i>Raphidiophrys elegans</i>	. . .	9, W.
<i>Rhabdostyla sertularium</i> ?	. . .	1, P.
<i>Rhipidodendron Huxleyi</i>	. . .	7, P.
" <i>splendidum</i>	. . .	5, W.
<i>Spirostomum ambiguum</i>	. . .	3, B.; 10, T., W.; 11, T.
<i>Stentor cæruleus</i>	. . .	3, W.; 4, 7, 8, P.
" <i>niger</i>	. . .	3, 4, P.; 5, P., W.; 9, P.; 11, P., T., W.
" <i>polymorphus</i>	. . .	1, 2, 3, 4, 9, 11.
" <i>Roeselii</i>	. . .	11, W.
<i>Stichotricha remex</i>	. . .	7, 11, P.
<i>Strombidium Claperedi</i>	. . .	8, 12, P.
<i>Stylonichia mytilus</i>	. . .	1, T.; 8, W.; 9, 11, T.
<i>Synura uvella</i>	. . .	8, 11, W.
<i>Trachelius ovum</i>	. . .	2, P., W.; 3, B., P., T., W.; 11, T., W.
<i>Trachelocerca olor</i>	. . .	11, T.
" <i>versatilis</i>	. . .	8, W.
<i>Trichodina pediculus</i>	. . .	11, T.
<i>Urocentrum turbo</i>	. . .	3, 11, P.
<i>Vaginicola crystallina</i>	. . .	1, 3, 8, 11, 12.
<i>Vorticella chlorostigma</i>	. . .	3, 4, 9, P.; 10, 11, W.
" <i>citrina</i> ?	. . .	11, P.
" <i>microstoma</i>	. . .	1, D.
" <i>nebulifera</i>	. . .	11, W.

## PORIFERA.

<i>Grantia ciliata</i>	. . .	6, D.
" <i>compressa</i>	. . .	6, D.

## CŒLEENTERATA. HYDROZOA.

<i>Eudendrium insigne</i>	. . .	6, P.
" <i>ramosum</i>	. . .	6, D.
<i>Obelia geniculata</i>	. . .	6, D., P.
<i>Plumularia halecioides</i>	. . .	6, P.

## Plumularia pinnata = Sertularia

- pinnata . . . . . 6, D.  
 Thaumantias hemisphærica . . . 6, Wb.  
 Tubularia indivisa . . . . . 6, D., P.

## ACTINOZOA. CORALLIGENA

## Actinoloba dianthus = Actinia

- plumosa . . . . . 6, Wb.

## CTENOPHORA.

- Pleurobrachia pileus . . . . . 6, Wb.

## VERMES. ROTIFERA.

- Adineta vaga . . . . . 7, 8, W.; 10, P., W.; 12, P.  
 „ „ var. . . . . 7, W.  
 Anuræa aculeata . . . . . 1, 2, 3, 4, 5, 7, 8, 9, 11.  
 „ „ var. valga . . . . . 5, R.; 7, P., T., W.; 8, P.  
 „ „ W.; 12, P.  
 „ brevispina . . . . . 3, 7, 10, 11, 12.  
 „ cochlearis . . . . . 1, 2, 3, 4, 7, 10, 11.  
 „ curvicornis . . . . . 3, 7, 8, 10.  
 „ hypelasma . . . . . 1, 9, 10, 11, W.  
 „ serrulata . . . . . 2, 5, 7, 8, 10.  
 „ tecta . . . . . 3, 11, P., W.  
 Anapus ovalis . . . . . 5, R.; 8, 11, W.; 12, R.  
 Ascomorpha ecaudis = Sacculus  
 viridis . . . . . 3, 4, 5, 7, 8, 9, 10, 11, 12.  
 Ascomorpha saltans = Sacculus  
 saltans . . . . . 8, 10, W.  
 Asplanchna Brightwellii . . . . . 1, R., So.; 10, P., W.; 11,  
 P.  
 „ priodonta . . . . . 1, R., So., Th., T., W.; 2,  
 So.; 4, R., W.; 10, W.  
 Asplanchnopus myrmeleo . . . . . 11, W.  
 Brachionus angularis . . . . . 1, So., W.; 2, R., So.; 3,  
 P., W.; 4, R.  
 „ Bakeri . . . . . 1, R., Th., T.; 3, 9, P.,  
 W.; 10, P.  
 „ pala . . . . . 1, R., So., W.; 3, P.; 4,  
 P., R.; 7, T.  
 „ „ var. ampiceros . . . . . 1, D., Th., T.  
 „ rubens . . . . . 2, So.; 3, 4, W.; 7, P.

<i>Brachionus urceolaris</i>	.	.	.	1, 2, 5, 6, 7, 8, 12.
„	„	var.	.	2, R.
<i>Callidina constricta</i>	.	.	.	7, W.
„	<i>elegans</i>	.	.	7, W.
„	<i>lata</i>	.	.	10, P., W.
„	<i>magna-calcarata</i>	.	.	11, P.
„	<i>musculosa</i>	.	.	2, 3, W.
„	<i>parasitica</i>	.	.	4, P., R.
„	<i>plicata</i>	.	.	7, 8, 10, W.; 12, P.
„	<i>quadricornifera</i>	.	.	8, 10, W.
„	<i>tridens</i>	.	.	8, W.
<i>Cathypna luna</i>	.	.	.	7, 8, 9, W.; 11, P., W.
„	<i>rusticula</i>	.	.	4, R.
„	<i>ungulata</i>	.	.	8, R., W.
<i>Cœlopus brachynrus</i>	.	.	.	3, R., W.; 4, 9, W.
„	<i>cavia</i>	.	.	5, 7, W.
„	<i>porcellus</i>	.	.	3, W.; 5, P., R., W.; 9, P., W.; 11, P.; 12, R.
„	<i>tenuior</i>	.	.	5, 10, W.
<i>Colurus bicuspidatus</i>	.	.	.	9, 10, W.
„	<i>caudatus</i>	.	.	3, B.
„	<i>deflexus</i>	.	.	11, W.
<i>Conochilus unicornis</i>	.	.	.	10, P., T., W.
„	<i>volvox</i>	.	.	5, R., W.; 7, P., T.; 8, P., So., W.
<i>Copeus caudatus</i>	.	.	.	8, W.
„	<i>cerberus</i>	.	.	1, P.; 4, P., R.; 10, W.
„	<i>Ehrenbergii</i> = <i>labiatus</i>	.	.	8, P., R., W.; 11, P. T.
„	<i>pachyurus</i>	.	.	5, W.; 7, P.; 9, W.; 10, P. W.
<i>Cyrtonia tuba</i> (Rousselet) = <i>Noto-</i> <i>mata tuba</i> (Ehr.)	.	.	.	11, P., W.
<i>Diaschiza exigua</i>	.	.	.	2, R., W.; 3, 7, 8, 9, W.
„	<i>globata</i>	.	.	11, W.
„	<i>pæta</i>	.	.	10, W.
„	<i>semi-aperta</i>	.	.	4, 7, W.; 8, R., W.; 9, 10, 11, W.; 12, R.
„	„	male	.	8, W.
„	<i>valga</i>	.	.	11, W.
<i>Diglena catellina</i>	.	.	.	1, R.



<i>Diglena forcipita</i> . . . . .	1, 3, P.; 4, W.; 5, P.; 10, W.
<i>Dinocharis pocillum</i> . . . . .	2, 3, 4, 5, 9, 10, 11, 12.
„ <i>tetractis</i> . . . . .	2, 3, 5, 7, 8, 9, 10, 11, 12.
<i>Diplax trigona</i> . . . . .	8, W.
<i>Distyla clara</i> . . . . .	8, W.
„ <i>flexilis</i> . . . . .	7, 8, 10, W.
„ <i>inermis</i> . . . . .	8, W.
<i>Elosa Worrallii</i> . . . . .	7, 8, W.
<i>Eosphora aurita</i> . . . . .	2, W.; 3, R.; 8, R., W.; 9, 10, W.; 11, P., W.
<i>Euchlanis deflexa</i> . . . . .	4, R.
„ <i>dilatata</i> . . . . .	3, B., T., W.; 8, R.; 11, T.
„ <i>hyalina</i> . . . . .	11 W.
„ <i>macrura</i> . . . . .	11, P.
„ <i>orapha</i> . . . . .	11, W.
„ <i>parva</i> . . . . .	4, R. W.
„ <i>pyriformis</i> . . . . .	1, 3, P.
„ <i>subversa</i> . . . . .	5, 7, W.
„ <i>triquetra</i> . . . . .	3, 5, 7, 8, 9, 10, 11, 12.
„ „ <i>male</i> * . . . . .	12, R.
„ <i>uniseta</i> . . . . .	3, B., P.
<i>Floscularia algicola</i> . . . . .	8, 11, P.
„ <i>campanulata</i> . . . . .	1, R., Th.; 3, P.; 8, R., W.; 9, P., T., W.; 12, P., R.
„ <i>cornuta</i> . . . . .	2, P., W.; 3, P.; 7, W.; 9, P., T.; 11, P.
„ <i>coronetta</i> . . . . .	9, W.; 11, P.
„ <i>cyclops</i> . . . . .	7, P.; 10, W.
„ <i>longicaudata</i> . . . . .	1, W.
„ <i>ornata</i> . . . . .	1, Th.; 2, So., T.; 3, R. 8, P.; 9, P., W.; 11, T.
„ <i>pelagica</i> . . . . .	10, P., W.
„ <i>regalis</i> . . . . .	9, P., W.; 11, P.
„ <i>trilobata</i> . . . . .	4, W.

\* *Euchlanis triquetra*, male. Mr. Rousselet describes it as loricate, of the same shape as the female, but only about one-third the size; it has no mastax and no digestive tract, the place of which is taken by the sperm sac. This is believed to be the first male of the *Euchlanidæ* observed.

<i>Furcularia forficula</i> . . . . .	1, Th. ; 9, 11, P.
" <i>gibba</i> . . . . .	7, 9, T.
" <i>gracilis</i> . . . . .	2, W.
" <i>longiseta</i> . . . . .	3, 5, 7, 8, 9, 11, 12.
" <i>melandocus</i> . . . . .	12, R.
<i>Lacinularia socialis</i> . . . . .	8, R., So., W.
<i>Limnias annulatus</i> . . . . .	1, R. ; 11, P.
"  "  ?*	1, Th., W.
" <i>ceratophylli</i> . . . . .	1, So. ; 9, W.
" <i>myriophylli</i> . . . . .	7, P., W. ; 8, R.
<i>Mastigocerca bicornis</i> . . . . .	3, B. ; 5, P., R., W. ; 7, W. ; 12, R.
" <i>bicristata</i> . . . . .	4, R. ; 11, P.
" <i>carinata</i> . . . . .	4, W. ; 11, T.
" <i>elongata</i> . . . . .	4, 8, R.
" <i>lophoessa</i> . . . . .	5, R. ; 8, 11, W.
" <i>rattus</i> . . . . .	3, P., R., W. ; 5, W. ; 8, P., W. ; 10, W. ; 11, P., W. ; 12, P.
<i>Melicerta conifera</i> . . . . .	7, P., W. ; 8, P. ; 9, P., W. ; 12, P.
" <i>ringens</i> . . . . .	1, 3, 4, 5, 7, 8, 9, 11, 12.
<i>Metopidia acuminata</i> . . . . .	1, T. ; 3, B., T. ; 5, P., R. ; 9, 10, 12, T.
" <i>lepadella</i> . . . . .	1, T., W. ; 2, T. ; 3, W. ; 5, R., W. ; 7, W. ; 8, So., T. ; 9, T., W.
" <i>oxysternum</i> . . . . .	3, P. ; 4, W. ; 10, T.
" <i>rhomboides</i> . . . . .	4, W.
" <i>solidus</i> . . . . .	3, P. ; 5, R., W. ; 8, 9, W. ; 11, P., W.
" <i>triptera</i> . . . . .	11, W.
<i>Microdides orbiculodiscus</i> . . . . .	8, W. ; 10, P., W. ; 12, P.
<i>Microcodon clavus</i> . . . . .	10, W.
<i>Monocerca rattus</i> . . . . .	9, T.
<i>Monostyla bulla</i> . . . . .	9, W.
" <i>lunaris</i> . . . . .	8, W. ; 12, R.
<i>Monura colurus</i> . . . . .	6, P.

\* *Limnias annulatus*? This is the *Limnias* described in the lists of 1892-3. It has seven dorsal knobs.

<i>Noteus quadricornis</i>	. . .	. 3, B., R., T.; 5, R.; 7, P.; 8, So.; 10, P., T.; 11, P.
<i>Notholca acuminata</i>	. . .	. 1, R., T.; 3, 5, W.
„ <i>scapha</i>	. . .	. 1, R.; 2, P.; 3, B.
<i>Notommata aurita</i>	. . .	. 1, P., T.; 3, B., R., T., W.; 5, P.; 8, 10, T.
„ <i>brachyota</i>	. . .	. 5, R.
„ <i>lacinulata</i>	. . .	. 3, 7, P.; 9, P., W.; 11, P.; 12, P., R.
„ <i>longiseta</i>	. . .	. 11, 12, T.
„ <i>tigris</i>	. . .	. 3, B., T.; 7, 9, T.
„ <i>tripus</i>	. . .	. 3, P.; 4, W.; 5, P., R.
„ <i>tuba</i> , see <i>Cyrtonia</i> .		
<i>Notops brachionus</i>	. . .	. 3, B., R., W.; 5, W.; 7, P.; 10, P., T., W.
„ <i>male</i>	. . .	. 10, P.
„ <i>hypopus</i>	. . .	. 2, 3, P.; 5, R.; 7, P., W.; 10, W.
„ <i>minor</i>	. . .	. 2, P.; 5, R.; 10, P., W.
<i>Ocistes crystallinus</i>	. . .	. 1, D., Th., T.; 3, P.; 4, 5, W.
„ „ var. ?	. . .	. 1, W.
„ <i>longicornis</i>	. . .	. 9, W.
„ <i>mucicola</i>	. . .	. 3, P.
„ <i>pilula</i>	. . .	. 7, P.; 8, So.; 12, P.
„ <i>socialis</i>	. . .	. 1, R.
<i>Pedalion mirum</i>	. . .	. 10, P., T., W.
<i>Philodina citrina</i>	. . .	. 3, P., W.; 7, W.
„ <i>erythrothalma</i>	. . .	. 1, W.
„ <i>macrostyla</i>	. . .	. 7, 8, P., W.
„ <i>megalotrocha</i>	. . .	. 2, 3, 9, P.
<i>Polyarthra platyptera</i>	. . .	. 1, 2, 3, 4, 5, 7, 8, 10, 11.
„ „ small form	. . .	. 10, P.
<i>Pompholyx sulcata</i>	. . .	. 4, R., W.; 10, P., W. 12, R.
<i>Proales decipiens</i>	. . .	. 1, 5, W.
„ <i>felis</i>	. . .	. 7, 8, 10, 11, W.
„ <i>parasita</i>	. . .	. 5, W.; 11, T.
„ <i>petromyzon</i>	. . .	. 1, P.

Proales sordida . . . . .	. 12, P.
Pterodina patina . . . . .	. 1, 3, 4, 7, 9, 11, 12.
"    reflexa . . . . .	. 11, P.
"    valvata . . . . .	. 7, W.; 11, P.
Rattulus cimolius . . . . .	. 2, So.
"    lunaris . . . . .	. 3, T.
"    tigris . . . . .	. 5, 8, W.
Rotifer citrinus . . . . .	. 3, 8, P.
"    macroceros . . . . .	. 1, Th.: 3, P.; 4, R. W.; 7, 8, P.; 9, W.; 12, P.
"    macrurus . . . . .	. 1, P., Th.; 3, 8, 10, 12, P.
"    mento? . . . . .	. 7, 8, 10, P., W.
"    Rœperi . . . . .	. 8, W.
"    tardus . . . . .	. 8, P.; 9, W.; 11, P.
"    vulgaris . . . . .	. 1, 2, 3, 7, 8, 9, 10.
Sacculus saltans } see Ascomorpha.	
"    viridis }	
Salpina brevispina . . . . .	. 4, P., W.; 5, R., W.; 9, W.; 11, T.
"    marina . . . . .	. 1, 3, R.
"    mucronata . . . . .	. 3, 5, 7, 8, 9, 10, 11, 12.
"    mutica . . . . .	. 8, R.
"    spinigera . . . . .	. 4, W.; 11, P.
"    ventralis . . . . .	. 11, T.
Scaridium longicaudum . . . . .	. 4, W.; 8, P., R., W.; 9, 11, P., T., W.
Stephanoceros Eichhornii . . . . .	. 3, P., R., W.; 4, W.
Stephanops lamellaris . . . . .	. 5, R.; 10, W.; 11, P.
"    muticus . . . . .	. 5, R.
"    unisetatus . . . . .	. 7, P.
Syncharta pectinata . . . . .	. 1, 2, 3, 4, 5, 7, 8, 10, 11, 12.
"    tremula . . . . .	. 1, 2, 3, 4, 5, 7, 10, 11, 12.
Taphrocampa annulosa . . . . .	. 9, 10, 11, 12, P.
"    Saundersia . . . . .	. 10, W.
Triarthra longiseta . . . . .	. 1, R., So., T., W.; 2, P., So., T.; 3, B., P., T.; 5, W.; 10, P.

<i>Triophthalmus dorsualis</i> *	. . . . .	11, W.
<i>Triphylus lacustris</i>	. . . . .	5, R., W.; 8, R., So., W.; 11, P., W.

*PLATYHELMINTHES.* TREMATODA.

Cercarian stage of a trematode worm 11, P.

*ANNELIDA.* OLIGOCHÆTA.

*Æolosoma variegatum*† . . . . . 8, P.

*POLYCHÆTA.*

*Polynœe squamata*? . . . . . 6, P.

*GASTROTRICHA.*

*Chætonotus acanthophoris* . . . . . 11, P.

„ *hystrix* . . . . . 9, 10, W.

„ *larus* . . . . . 2, 3, 7, T.; 9, 10, T., W.;  
11, 12, T.

„ *maximus* . . . . . 8, T.; 11, T., W.

*Dasydytes goniathrix* . . . . . 3, P., W.

*CRUSTACEA.*

*Carcina mænas* . . . . . 6, P.

*Pisa tetraodon* . . . . . 6, P.

*ENTOMOSTRACA.*

*Alona intermedia* . . . . . 4, Sc.

„ *quadrangularis* . . . . . 2, 4, Sc.

*Bosmina longirostris* . . . . . 1, 2, 4, 12, Sc.; 2, 3, T.

*Candona fabæformis* . . . . . 4

„ *lactea* . . . . . 4

„ *pubescens* . . . . . 1

*Canthocamptus crassus* . . . . . 1, 12 } Sc.

= *Attheyella spinosa*

*Canthocamptus pygmæus* . . . . . 12

= *Attheyella cryptorum* }

\* *Triophthalmus dorsualis*. Mr. Western remarks that this is undoubtedly the rotifer figured and described by Gosse. The orange eye-spots on top of front processes, mentioned by Eckstein, but not seen by H. and G., were plainly visible. Of the three cervical eyes described, the centre one only is a true eye-spot, the two outer ones being chalky masses on the brain lobes. The animal is therefore an *Eosphera*. Gosse's original drawing, with the above exception, is excellent.

Messrs. Rousselet and Western record from Hertford Heath an undescribed species belonging to the *Notommatadæ*.

† *Æolosoma variegatum* (Vejdovsky). New to England.

<i>Canthocamptus staphylinus</i> . . . . .	1, 2, 4, Sc. ; 3, B., T.	
= <i>C. minutus</i>		
<i>Ceriodaphnia quadrangula</i> . . . . .	4, Sc.	
,, <i>reticulata</i> . . . . .	9, 11, W.	
<i>Chydorus globosus</i> . . . . .	1, 4, Sc. ; 2, T.	
,, <i>sphericus</i> . . . . .	1, 2, 4, 12, Sc. ; 1, D. ; 2, T. ; 3, B., T. ; 9, W.	
<i>Cyclops bicuspidatus</i> = <i>C. Thomasi</i>	1, 2	} Sc.
,, <i>fimbriatus</i> . . . . .	2	
,, <i>Leuckarti</i> = <i>C. simplex</i>	1, 2, 4	
,, <i>oithonoides</i> = <i>C. hyalinus</i>	4	
,, <i>serrulatus</i> . . . . .	1, 2, 4	
,, <i>strenuus</i> . . . . .	2	
,,     ,, <i>vicinus form.</i>	1, 4	
,, <i>tenuicornis</i> . . . . .	2, 4	
,, <i>vernalis</i> * . . . . .	2, 12	
,, <i>viridis</i> , var. <i>brevicornis</i>	2, 12	
,,     ,,     ,, <i>gigas</i>	2, 4	
<i>Cypria ophthalmica</i> . . . . .	1, 4	
<i>Cypridopsis vidua</i> . . . . .	1, 12	
<i>Cypris fuscata</i> . . . . .	2, 12	
,, <i>virens</i> . . . . .	2	
<i>Daphnella brachyura</i> . . . . .	9, 11, W.	
<i>Daphnia hyalina</i> . . . . .	2, Sc.	
,, <i>longispina</i> . . . . .	1, 4, Sc.	
,, <i>pulex</i> . . . . .	2, 12, Sc. ; 3, T. ; 11, W.	
<i>Diaptomus castor</i> . . . . .	2, 12, Sc. ; 3, 8, T.	
,, <i>gracilis</i> . . . . .	1, 2, Sc.	
<i>Eurycercus lamellatus</i> . . . . .	9, W.	
<i>Ilyocryptus sordidus</i> . . . . .	4	} Sc.
<i>Leydigia acanthocercoides</i> . . . . .	1, 2, 4	
<i>Macrothrix laticornis</i> . . . . .	2, 4	
<i>Peracantha truncata</i> . . . . .	4	
<i>Pleuroxus trigonellus</i> . . . . .	1, 4	
<i>Polyphemus pediculus</i> . . . . .	8, P., T.	
<i>Scapholeberis mucronata</i> . . . . .	4, Sc.	
<i>Sida crystallina</i> . . . . .	8, P., T. ; 9, W.	
<i>Simocephalus vetulus</i> . . . . .	1, 2, 4, Sc.	

\* *Cyclops vernalis* has in previous years been included with *C. bicuspidatus*.

Simocephalus vetulus, exspinosus  
form . . . . . 12, Sc.

ARACHNIDA. ACARINA.

BDELLIDÆ.

Scirus insectorum *	. . . . .	}	8, So.
„ vulgaris	. . . . .		
HYDRACHNIDÆ.			
Arrenurus buccinator ♂ ♀	. . . . .	}	8, So.
„ globator ♂	. . . . .		
„ maculator ♀	. . . . .		
„ viridis ♀	. . . . .		

ARCTISCONIDÆ.

Macrobiotus Hufelandi . . . . . 1, T. ; 3, 10, 12, P.

INSECTA. DIPTERA.

Simulium sericium, lava of . . . . . 9, P.

MOLLUSCOIDA. POLYZOA.

Amathia lendigera . . . . . 6, D., P.  
 Bicellaria ciliata . . . . . 6, D., P.  
 Bowerbankia pustulosa . . . . . 6, P.  
 Crisia denticulata . . . . . 6, P.  
 „ eburnea . . . . . 6, D.  
 Cristatella mucedo . . . . . 8, R., W.  
 Fredericella sultana . . . . . 1, D. ; 8, W.  
 Membranipora pilosa . . . . . 6, P.  
 Paludicella Ehrenbergii . . . . . 1, R. T. ; 8, P., R., W.  
 Pedicellina cernua . . . . . 6, D., P.  
 „ „ var. glabra . . . . . 6, P.  
 Plumatella repens . . . . . 8, R.  
 Valkeria uva, var. cuscuta . . . . . 6, D. P.

TUNICATA.

Perophora Listeri . . . . . 6, D.

FREDK. A. PARSONS,

Hon. Sec. Excursions Sub-Committee.

\* *Scirus insectorum*, parasitic on a springtail.

OFFICERS AND COMMITTEE.  
(Elected February, 1895.)

President.

EDWARD MILLES NELSON, F.R.M.S

Vice-Presidents.

REV. W. H DALLINGER, LL.D., F.R.S., F.R.M.S., &c.  
 PROF. B. T. LOWNE, F.R.C.S., F.L.S., &c.  
 A. D. MICHAEL, Pres.R.M.S., F.L.S., &c.  
 PROF. C. STEWART, M.R.C.S., F.L.S., F.R.M.S., &c.

Committee.

F. W. HEMBRY, F.R.M.S.	J. W. REED.
G. WESTERN, F.R.M.S.	J. SPENCER, F.R.M.S.
E. T. NEWTON, F.R.S., F.G.S.	H. MORLAND.
J. E. INGPEN, F.R.M.S.	E DADSWELL, F.R.M.S.
G. MAINLAND, F.R.M.S.	D BRYCE.
B. W. PRIEST.	F. A. PARSONS

Hon. Treasurer.

J. J. VEZEY, F.R.M.S. 21, Mincing Lane E.C.

Hon. Secretary.

G. C. KAROP, M.R.C.S., F.R.M.S., 198, Holland Road, Kensington, W

Hon. Sec. for Foreign Correspondence.

C. ROUSSELET, F.R.M.S 27, Great Castle Street Regent Street, W.

Hon. Reporter.

R. T. LEWIS, F.R.M.S., 4, Lyndhurst Villa, The Park, Ealing, W.

Hon. Librarian.

ALPHEUS SMITH,  
8, Hanover Park, Peckham, S.E.

Hon. Curator.

F. T. BROWNE, F.R.M.S.  
141, Uxbridge Road, W.

Hon. Editor.

E. M. NELSON, F.R.M.S., 66, West End Lane, N.W.



## ON FLOSCULARIA TRIFIDLOBATA, SP. NOV.

By GEO. M. PITTOCK, M.B., F.R.M.S., of Margate.

Communicated by C. F. ROUSSELET, F.R.M.S.

(Read March 15th, 1895.)

## PLATE I.

Since the publication of Hudson and Gosse's great work on the Rotifera, many new species have been discovered and recorded. A list of new Rotifers found and described since that date (1889) has been furnished by Mr. C. F. Rousselet ("Journal Royal Microscopical Society," June, 1893). I have now to announce the addition of another Floscule to the list of new species given in Mr. Rousselet's catalogue.

I will endeavour to follow his advice, that "when a new species has been found, it should be figured and described in such a manner that the animal may readily be recognized when found again by a different observer, and a good figure is often worth more than a good description."

Any shortcomings in the following description will, I believe, be made up by the beautiful and characteristic drawing which accompanies this paper, for which I am indebted to my very kind friend Mr. Dixon-Nuttall, whose accurate sketches from life of many new forms are well known to many members of the Society.

This small, but very distinct species, was discovered early this year by my friend Mr. F. Daunou, of Margate, in hunting over some water moss from the Minster Marshes, Thanet, a locality which has already proved a very prolific hunting-ground to him and to myself during the past summer. (See a short paper on "Rotifer Hunting at Minster," in "Science Gossip," October, 1894.) At first sight this floscule somewhat resembles *F. longicaudata*, in the length of the foot, and in the shape of the long, pointed, dorsal lobe. Indeed, I sent a specimen to Mr. Hood, of Dundee, for identification, in January last, believing it to be an aberrant form of *F. longicaudata*.

More careful examination, however, showed that it has five lobes, of which the dorsal one is long, pointed, and trifid at the apex, and crowned with three brushes of short setæ. The other lobes are small, being little more than slight projections of the coronal rim, and not quite equi-distant from each other, and each crowned with a brush of short setæ. The two ventral lobes are close together, and the lateral lobes close to the base of the larger dorsal lobe, leaving a wider space than usual between the lateral and ventral lobes. The setæ are not continuous round the coronal rim.

Three very small antennæ can be made out, one dorsal and two lateral, and the space between the integument is filled with numerous brown granules.

Before attempting to describe or to name this floscule, I first submitted it to Mr. Rousselet, Mr. Western, and Mr. Hood of Dundee, all of whom pronounced it to be specifically distinct from any other known floscule, and especially differentiated by the trifid character of the dorsal lobe, which suggested the name *trifidlobata*.

*Spec. Char.*—Lobes five, the dorsal one long, pointed, trifid at apex, crowned with three brushes of short setæ, the other lobes small and inconspicuous, without knobs; not quite equi-distant round coronal disc, each with a brush of short setæ. Tube small and sometimes indistinct, antennæ three, each with tuft of short setæ. Jaws as in other floscules. Eyes absent. Length: total  $\frac{1}{60}$ , of body  $\frac{1}{180}$ , foot twice the length of body.

## WHAT WAS THE AMICIAN TEST ?

By GEORGE C. KAROP, F.R.M.S.

*(Read March 15th, 1895.)*

In reading the earlier papers on microscopy, that is to say in the modern sense of the word, when successive improvements were being made in the construction of objectives by enlargement of their aperture and hence in their defining power ; at a time when the dilettanti were vying with one another in the resolution of diatoms by the aid of condensers, prisms, oblique illuminators and what not, one frequently comes across the phrase " Amician test." It is used so definitely as a touchstone of excellence, either in object glass or manipulative skill, that one must assume the exact nature of this " test " was the common knowledge of every microscopist of the period, but I must confess, after some amount of search and personal inquiry from those most likely to remember, it still remains to me a matter of uncertainty. I do not wish it to be understood for a moment that I have made an exhaustive, or even an extended, investigation on the subject ; I have not been able to find any statement by Amici himself or by anyone whose authority might be accepted as final, but I have looked through the few text-books of the period and papers on manipulation in various transactions, etc. It is simply for my own instruction and with a view of eliciting information from others that I have ventured to put this interesting question before you to-night.

The first, or most probable, solution that presents itself is that Amici made use of several tests of increasing difficulty as he improved the construction and resolution of his lenses. Indeed it is certain, in his earlier efforts with specula and objectives, that he employed scales of various Lepidoptera, Poduræ and so forth, which were the first test objects whatsoever for comparing the quality of lenses. The use of these scales for the purpose of testing the aperture of objectives was discovered by Dr. C. R. Goring.

Harting, "Das Mikroskop," First German edit., p. 288, says : "Mohl particularly recommends the wing scales of ♀ *Hipparchia janira* as a test, which he got to know from Amici." Although Harting gives some information about diatoms as tests, and a good deal about Amici and his instruments, there is no mention of any specific "Amician test," a somewhat curious and rather suspicious omission in a work which I regard as by far the best of its day on the microscope. I say suspicious, for I am of opinion that the test called Amician, one particular diatom as understood later, was something got up, so to speak, for the English amateur at a time when there prevailed a kind of mania here for increased apertures solely for resolving the markings on certain diatoms, which was quite without parallel on the continent. I fully recognize the value of the diatom and its reaction on the wealthy dilettante; between them they are in great measure answerable for the modern microscope and its magnificent objectives; but the early continental worker who employed the microscope as any other tool, came to regard the Englishman's proceedings as childish trifling, and looked upon his great, shining, complicated stand with its wonderful accessory apparatus merely as "an expensive peepshow," while he was quite indifferent to the sempiternal checks, dots, lines and little else so painfully evolved by it. An "Amician test," apparently, was not for him.

Be this as it may, however, the question for us is, which was the particular diatom considered to be *the* Amician test par excellence? A large number, perhaps the majority, of authorities believe it to be *Navicula rhomboides*. This is first figured, naturally in outline only, in Ehrenberg's "America," 1843, according to Kützing, who copies it in his "Bacillarien." W. Smith records it in 1849, but it is doubtful if any lens of that date could have really resolved it, unless it chanced to be a very coarse-lined variety. Mr. Ingpen informs me that he possesses a slide of *rhomboides* thirty-five to forty years old, by C. M. Topping, the best mounter of his day, labelled simply "Amician Test," and Mr. T. Powell has kindly sent me a similar slide and also so named. On examination it appears to have been mounted as gathered, without any preliminary treatment with acids, between two thin covers, but from lapse of time it has almost perished, and the diatoms, chiefly a very small variety of *rhomboides*, are quite unresolvable by any optical means in my possession.

In a paper by Mr. J. Newton Tomkins "On Resolution of Diatoms by Double Prism Illumination,"\* he speaks of *N. rhomboides* as "the Amician test of the London, although, perhaps, not of the American microscopists," a very queer expression unless, indeed, as I suspect, the thing was a variable. Mr. E. G. Lobb, a very well-known microscopist in his day, in a paper entitled "Note on Illuminating Objects with High Powers," ("Trans. Mic. Soc.," Lond., N.S. xiv., 1866, pp. 39-41), gives minute directions for using a condenser of  $170^\circ$  (Powell's) in resolving tests, stating the apertures and stops suitable for quite a number of diatoms. He says: "To examine *N. cuspidata*, *N. rhomboides*, *P. fasciola*, *P. macrum*, etc., use No. 11 aperture and stop No. 2, which will require a slight alteration in position only, when the checks will appear distinctly. For the Amician test use the slots instead of No. 2 stop." From this it seems quite clear that Mr. Lobb's Amician test, at all events, was not *N. rhomboides*.

In the first three editions of the "Micrographic Dictionary," viz., 1856, 1860 and 1875, Amici's test is given as *N. gracilis*, Ehr., which Smith, "Syn.," p. 75, refers, with a query, to his *Pinnularia gracilis*. From the figure it appears to me very unlikely. In the latest edition of the Dictionary, 1883, *sub voce* Test Objects is given, "*N. affinis*, Amici's test object, that used at the Exhibition of 1862, mounted in balsam, the transverse lines."† Mr. Ingpen thinks this would now be considered a form of *rhomboides*, but both Van Heurck and Brun make it allied to *N. producta*, W. S. It is evidently a variable species, but I think the striation is coarser than any ordinary *rhomboides*; moreover, it is figured with the central and terminal nodules of a true *Navicula*.

I have a, more or less, distinct recollection of a *Grammatophora*, probably *subtillissima*, being given as the Amician test; possibly this is the American variant.

\* When and where this paper was published I have been unable to find, but it is quoted at some length in the Sixth Edition of Hogg, "The Microscope," etc., 1867, pp. 175-8, and Rev. J. B. Reade somewhere mentions that Tomkins used a double prism illumination in 1861.

† *Navicula affinis*, sous le nom de *Test d'Amici* a été employée d'après le Prof. Van Heurck à l'exposition de Londres à 1862 pour juger les Microscopes. Robin, "Traite du Micros. et des inject.," 1877, p. 312.

Obviously, therefore, I have not been able to satisfy myself that there was a fixed or standard Amician test. The matter is, of course, of archæological interest only at the present time; but it is certainly singular how a term which thirty or forty years ago was the common property of microscopists should have become so obscure and mysterious, and I trust some here will be able to explain it.

---



ROOTS AND SOME GROWTHS UPON THEM.

By E. B. GREEN, F.R.M.S.

(*Read April 19th, 1895.*)

PLATE V.

The drawings upon the table are intended to represent the structure and rate of growth of some roots.

Root hairs drawn to a uniform scale of 100 diameters, and Parasitical and other growths, which I have found upon them.

The seeds of a large number of plants were sown in pots filled with light soil, and put into a warm greenhouse, where the temperature varied from  $45^{\circ}$  to  $70^{\circ}$ , and the seedling plants were from time to time carefully taken up with a sufficient quantity of adherent soil, plunged into a tank of water, and after gentle washing floated on to a sheet of glass, or (if intended for microscopic examination) upon a glass slide rather larger than the ordinary size, and a covering glass was put on before the slide was removed from the water, care being taken to exclude air bubbles.

The specimen was put upon the stage of the microscope as soon as the outside of the covering glass was dry, and it was also examined when the specimen had dried. I found this double examination necessary, as some of the more delicate organisms which could be plainly made out when first put upon the slide lost all their characteristic form and structure when they became dry, whilst others which were colourless could not be seen till all the water had evaporated.

Some of the drawings, showing the rapidity with which roots grow under favourable circumstances, are made the natural size.

A seed of maize, eight days after planting, produced 20 roots of various lengths; the longest six inches. Another fourteen days from planting had upwards of 100 roots, and the longest of which was eight inches. A seed of barley produced 70 roots in eight days, and an oat upwards of 400 roots in 48 days; several of them were more than fourteen inches long, and all these roots were densely covered with root hairs.

Root hairs are extensions of the walls of the outer circle of the root cells, and continuous with them; they spread out at their base in some cases very considerably, but with this exception they are tolerably uniform. They do not branch, but in some instances divide into several short swollen projections at their extremities. The hairs upon the roots of many ferns are of a rich orange brown colour, but those of most plants are colourless or very slightly tinted; they are beautifully iridescent when viewed with a dark ground illumination; bright spots of organizable substance are seen abundantly in some and very sparsely in others.

They are very glutinous and attach themselves firmly to the glass slide. I have examples which have withstood much rough usage. They were put upon glass four or five years ago, and although they were uncovered they have suffered very little injury, but the roots from which they sprung have long since disappeared. They cling to grains of sand and other mineral and vegetable substances in the soil, and exercise a very powerful chemical action upon them. They differ greatly in character, dimensions, and quantity in various plants, being abundant and of considerable length in the grasses, ferns, and most annuals, and few and short in fleshy rooted plants.

The drawings of various hairs  $\times 70$  will give some idea of their different lengths, and others  $\times 500$  of their comparative diameters and other characters.

The dimensions of the longest hairs shown are as follows:—

Length.	Diameter.
<i>Erica</i> . . . . . $\frac{1}{70}$	<i>Leek</i> . . . . . $\frac{1}{450}$
<i>Leek</i> . . . . . $\frac{1}{70}$	<i>Pteris serrulata</i> . . . . . $\frac{1}{900}$
<i>Oxalis</i> . . . . . $\frac{1}{46}$	„ <i>longifolia</i> . . . . . $\frac{1}{1000}$
<i>Millet</i> . . . . . $\frac{1}{25}$	<i>Maize</i> . . . . . $\frac{1}{1100}$
<i>Achillea</i> . . . . . $\frac{1}{23}$	<i>Pelargonium</i> . . . . . $\frac{1}{1200}$
<i>Antirrhinum</i> . . . . . $\frac{1}{20}$	<i>Achillea</i> . . . . . $\frac{1}{1300}$
<i>Pteris serrulata</i> . . . . . $\frac{1}{20}$	<i>Stellaria</i> . . . . . $\frac{1}{1600}$
<i>Pelargonium</i> . . . . . $\frac{1}{17}$	<i>Pyrethrum</i> . . . . . $\frac{1}{2000}$
<i>Rye Grass</i> . . . . . $\frac{1}{17}$	<i>Antirrhinum</i> . . . . . $\frac{1}{2400}$
<i>Stellaria</i> . . . . . $\frac{1}{16}$	<i>Oxalis</i> . . . . . $\frac{1}{2800}$
<i>Rivina</i> . . . . . $\frac{1}{15}$	<i>Cereus</i> . . . . . $\frac{1}{2800}$
<i>Linum rubrum</i> . . . . . $\frac{1}{7}$	<i>Adiantum caudatum</i> . . . . . $\frac{1}{3360}$
<i>Pteris longifolia</i> . . . . . $\frac{1}{7}$	



In the course of my examination of root-hairs I thought that I had discovered branches springing from them, but a more careful study revealed the fact that they were distinct organisms, and upon further investigation I found that they were very numerous. Several distinct species were frequently attached to one specimen, and although different kinds were attached to plants differing in species, I have not studied the subject sufficiently to give an opinion as to whether certain forms are peculiar to certain plants. I have found that many of them are common to several, whilst some I have hitherto found only upon individual plants. They may be comprised in two divisions.

1st.—Those which are simply attached to and on the root or hair, and do not derive nourishment from it, and

2nd.—Parasitical growths which penetrate the roots and root-hairs and destroy their structure.

The first division comprises a variety of forms, many of them probably Algæ, some of which are of considerable length, a quarter of an inch or more, flat and tapelike, from  $\frac{1}{1000}$  to  $\frac{1}{2000}$  of an inch in the greatest diameter, divided into cells varying from 1 to 20 or 30 diameters in length, very brightly coloured, chiefly green or orange brown, and bearing variously coloured spores on lateral branches, short spurs or terminal joints, divided from the main stem by a distinct wall. Another group springs in the form of a single round thread, which divides in its progress amongst and upon the root hairs, until it becomes a dozen or more, and at intervals forms tangles, like those of a skein of silk. When freshly mounted the threads are beautifully iridescent, but after some time they lose their colour. I have not been able to detect any spores in them. The threads are from  $\frac{1}{1000}$  to  $\frac{1}{2000}$  of an inch in diameter; a third group is tubular, cylindrical or oval, transparent, divided at long irregular intervals, containing a bright green granular core, irregular and more or less interrupted.

Others are very curious in structure and markings; they appear to be solid, leathery, and flat-jointed, joints varying greatly in length,  $\frac{1}{1000}$  to  $\frac{1}{2000}$  wide, and about  $\frac{1}{1000}$  thick in one species, varying considerably in others, sometimes with numerous branches, diverging at a considerable angle, or few branches nearly parallel; in most examples the joints are connected at right angles like the links of a chain, colour bright freckled brown with bright spots.

The second division consists of gelatinous growths which in many respects resemble fungi; they grow from the root or hair, do not confine their attacks to the part from which they spring, but stretch from hair to hair, or from hair to root, and completely destroy the hair and greatly injure the root; some kinds traverse the root-hairs, filling them with delicate threads, which emerge at intervals from it, and others nearly fill the cavity with a single thread, and on emerging from the hair become branched.

In some cases they radiate in straight threads from a central point, and in others form a dense network. The spores are very minute and appear to be formed upon the threads, or in bunches of six or more upon short stalks.

Spores are produced abundantly, and are greatly varied in shape and colour. They are round, oval, disk-shaped, and sometimes almond-like, black, white, green, brown, red or yellow in colour, occasionally quoit-shaped, showing complementary colours (red and green) in the outer and inner rings; in some cases they appear to be enveloped in a gelatinous mass, with slight indications of a stalky attachment; in others, smaller bunches upon short pedicels attached to, or enclosed in, filmy branches quite distinct in substance and form from the stem, and divided from it by a well-marked wall; they are also seen in considerable groups upon the stem, or closely ranged in single file upon it, or at considerable and irregular intervals.

I have found crystals of three types upon the parasites of buckwheat, lunaria, and parsnip, each differing from the others.

The following is a list of some of the plants which I have examined, with the number of different growths upon them as shown in the drawings:—

<i>Achillea</i> . . . . .	2	<i>Cereus</i> . . . . .	1
<i>Adiantum caudatum</i> . . . . .	1	<i>Celandine</i> . . . . .	2
<i>Althea rosea</i> . . . . .	1	<i>Dactylis</i> . . . . .	1
<i>Antirrhinum</i> . . . . .	9	<i>Endive</i> . . . . .	1
<i>Beet</i> . . . . .	1	<i>Euphorbia</i> . . . . .	1
<i>Begonia</i> . . . . .	1	<i>Flax</i> . . . . .	1
<i>Buckwheat</i> . . . . .	2	<i>Gooseberry</i> . . . . .	2
<i>Cabbage</i> . . . . .	3	<i>Hemp</i> . . . . .	2
<i>Calendula</i> . . . . .	2	<i>Impatiens</i> . . . . .	1
<i>Cranesbill</i> . . . . .	2	<i>Linum rubrum</i> . . . . .	2
<i>Cardamine</i> . . . . .	1	<i>Leek</i> . . . . .	2

<i>Lettuce</i> . . . . .	4	<i>Poppy</i> . . . . .	4
<i>Liverwort</i> . . . . .	2	<i>Pteris</i> . . . . .	4
<i>Linaria</i> . . . . .	2	<i>Pyrethrum</i> . . . . .	1
<i>Lunaria</i> . . . . .	2	<i>Ricinus</i> . . . . .	3
<i>Lupin</i> . . . . .	2	<i>Rivina</i> . . . . .	1
<i>Maize</i> . . . . .	3	<i>Rush</i> . . . . .	1
<i>Millet</i> . . . . .	2	<i>Ryegrass</i> . . . . .	1
<i>Mullein</i> . . . . .	1	<i>Scabius</i> . . . . .	1
<i>Oxalis</i> . . . . .	3	<i>Silene</i> . . . . .	2
<i>Parsley</i> . . . . .	several	<i>Stellaria</i> . . . . .	4
<i>Parsnip</i> . . . . .	4	<i>Tobacco</i> . . . . .	1
<i>Pelargonium</i> . . . . .	3	<i>Tomato</i> . . . . .	1
<i>Phalaris</i> . . . . .	1	<i>Vetch</i> . . . . .	1
<i>Poa</i> . . . . .	1	<i>Wallflower</i> . . . . .	5

In conclusion the author hopes that he may be allowed to express a wish that this subject, which he thinks is novel and full of interest, may be taken up by some of your members.

#### EXPLANATION OF PLATE V.

- FIG. 1. Parasitical gelatinous growth with crystals upon roots of Parsnip,  $\times 300$ .
- FIG. 2. Part of the same, showing rectangular celled structure, interrupted by transparent crystals,  $\times 1,000$ .
- FIGS. 3, 4, 5. Epiphytal growths of considerable length upon roots of Antirrhinum,  $\times 150$ .
- FIG. 3. Cellular cells about  $\frac{1}{3000}$  in. diameter and from  $1\frac{1}{2}$  to 10 or more diameters long, walls distinct, colour bright brown, direct growth.
- FIG. 4. Much branched, branches united, without division, except those connected with the fructification, which is terminal; outer wall very thin, pale green, enclosing irregular bright green patches.
- FIG. 5. Tape like, greater diameter, about  $\frac{1}{6000}$  in., much twisted, no apparent cavity, colour light brown.
- FIGS. 3a, 4a, 5a. Parts of the above,  $\times 600$ .
-

## ON A NEW SPECIES OF ALEURODES.

By R. T. LEWIS, F.R.M.S.

(Read April 19th, 1895.)

## PLATES II., III.

In the autumn of 1892 I received from a correspondent in Natal a spray of asparagus infested with small scale insects of a kind which he did not remember to have previously met with. The plant in question was one cultivated for ornamental purposes in the verandah of a house at Byrne, and it had become freely covered with small white spots, which, to the naked eye, had somewhat the appearance of mould, and were regarded by the owner as a great disfigurement. It was noted, however, that similar plants growing out in the open were not affected in the same way. On examination under the microscope, the objects were seen to be the pupal forms of some species of scale insect, which, though themselves perfectly black, were covered with plumes of pure white wax symmetrically arranged and presenting a very ornate appearance, especially when seen under the binocular. The individual specimens varied as to size, but the arrangement of the waxen plumes was practically the same in each. I believe that I exhibited some specimens at one of the meetings of the Club soon after they were received, but was at the time unable either to give or to obtain much information concerning them, and on submitting them to one of our best English authorities on the subject of *Coccididæ*, I found they were entirely new to him.

Following up the search for information, I forwarded some specimens to Prof. W. M. Maskell, whose researches into the history of the scale insects of New Zealand are no doubt well-known to many of our members through the publication of his valuable work upon the subject, as well as his numerous communications to the New Zealand Institute and to the Royal Society of South Australia. Mr. Maskell had no difficulty in deciding that the creatures were not *Coccididæ*, as at first supposed, but that they belonged to the allied family of the *Aleurodidæ*, which may

be considered as intermediate between the *Coccididæ* and the *Aphidæ*. In the adult form they are distinguished at once from the *Coccididæ* by the fact that both males and females possess four wings, whereas the male Coccids have two only, and the females none whatever; they also, in both sexes, are furnished with two joints to the tarsus, and with two claws, whilst it is characteristic of the *Coccididæ* to have but one tarsal joint and a single claw. A further distinction is also insisted upon as peculiar to the adults of this family, namely, their possession of divided compound eyes, but although this is to some extent indicated in the new species, it is not so well seen as in some of the figures by Mr. Maskell of other species. In the pupa condition, however—with which alone up to that time I had become acquainted—the distinction between members of these two families is not so well-marked, since both are found attached to the leaves of the plants they affect, and both may also be covered with a floury secretion or with a more or less abundant coating of exuded wax; hence they are not infrequently mistaken, and Mr. Maskell himself tells us that in 1878 he inadvertently placed two species of *Aleurodes* amongst the *Coccididæ* under the generic name of *Asterochiton*. But on removing the wax and examining the dorsal surface under the microscope, with about a 1" objective, a well-defined sub-ovate orifice will be seen upon the last abdominal segment, and by this only identification is usually possible.

Still greater difficulty, however, attends the effort to distinguish between the various species of *Aleurodes* in their adult forms, and a comparison between the larvæ and pupæ is generally necessary before a conclusion can be correctly arrived at. In the present instance, the pupa alone had been found, and although it was tolerably certain that the species was new, it could not be properly described in the absence of the adult, and my correspondent in the Colony was therefore asked to keep the plant under observation, and specially to look out for the appearance of any quantity of minute four-winged flies in its immediate neighbourhood.

In the following February the owner of the plant in question reported that the white things on the leaves had turned into flies, and my friend took the earliest opportunity of going over to Byrne to investigate the matter. He found, as stated, that the asparagus plant was now covered with minute flies, which rose in a cloud when the leaves were touched, but settled again at once if not

further disturbed. Having no doubt that these were the adult *Aleurodes*, he captured a quantity and forwarded them to me, and although extremely dry and fragile on arrival, there was no difficulty in determining that they were what we desired, and that males and females were present in about equal numbers.

The condition in which they came to hand prevented any very good mounts from being made, but by the examination of a considerable number it has been possible to make out all necessary details, though I regret I am unable to exhibit any specimen this evening which shows all equally well.

The larval form I have not seen in its natural conditions, but a few specimens of various ages, sent over mounted in balsam, and, of course, with all trace of wax removed, lead to the inference that they are inactive and that, as is the case with others of the genus, they resemble the pupæ in shape.

Of the pupa, however, I can speak more confidently, having had the opportunity of examining some hundreds; these are elliptical in shape, measuring on an average  $\frac{1}{25}$ "  $\times$   $\frac{1}{30}$ ", with a thickness of  $\frac{1}{150}$ " in the middle of the central longitudinal ridge; in colour they are black when viewed by transmitted light, but when mounted in balsam and seen by reflected light they appear brown. The margin, as seen from above, appears to be beaded or corrugated, with the exception, in some specimens, of a small space at the posterior extremity (immediately behind the ovate orifice before mentioned), from which two fine setæ proceed. These apparent corrugations are, however, the extremities of a series of minute tubes, through which the wax is excreted which forms the delicate marginal fringe surrounding the pupa, but usually obscured from view by the overhanging plumes of the more copious secretions from the dorsal surface; the number of these marginal tubes is found to average about 245 on each specimen. Above these and along each side are several rows of pores from which a much more abundant supply of pure white wax is extruded at an angle of about  $45^\circ$  to the surface of the leaf to which the pupa is attached, the numerous filaments coalesce, and before their full length is attained their extremities bend over in graceful curves until they rest upon the leaf, entirely hiding the marginal fringe, but not touching it. From the pores at the posterior end the wax is thrown out horizontally in spiral curves, which meet and overlap

in a characteristic manner on a prolongation of the median line, those at the anterior end being projected in two parallel plumes for about the same distance as those behind. On either side of the elevated dorsal ridge other series of excretory pores are found, and from these the wax is discharged in a nearly vertical direction in parallel lines, forming an elegant double crest above the central line. The whole appearance of the pupa in its complete condition is thus exceedingly ornate, forming as beautiful an object under the binocular microscope as can well be desired.

The perfect insects, which I am now for the first time able to describe, are very minute, the female not measuring more than  $\frac{3}{100}$ ths" in length and the male being about  $\frac{1}{6}$ th less. In their natural condition they are apparently a dull grey colour, with wings of rather lighter shade, both body and wings being dusted freely over with a waxy powder; both sexes are furnished with four wings, those of the female when expanded measuring about  $\frac{1}{10}$ " from tip to tip, and those of the male being slightly less. The specimens sent to me were not quite in the condition which I could have desired for successful mounting or examination, having been caught in a paper bag, killed with tobacco smoke, and then sent through the post in a small box, dry. On arrival, they were so completely desiccated as to break to pieces with the least provocation, and though all attempts at relaxing them sufficiently to display in good positions proved fruitless, I secured about sixty, which, after saturation in benzole, were mounted in balsam, and, although all were of value for comparison, it is with difficulty that I am able to exhibit a presentable slide this evening. When mounted in this medium the insects became translucent and deep yellow in colour, all trace of the waxy powder had disappeared in the benzole, and the wings were perfectly transparent. The fore-wing exhibits one median vein, with a single basal branch, the hind-wing showing the median vein only with distinctness with a 1" power; the margin of each wing appears to be minutely beaded, and on examination with a power of about  $\times 400$  it is seen that this is due to a number of small hemispherical elevations  $\frac{1}{2} \frac{1}{700}$ " apart, each bearing three or four extremely fine hairs.

The eyes are compound, constricted—but not actually divided—across the middle, and there is one small ocellus above and immediately contiguous to each compound eye. The antennæ are

seven-jointed, the first two being short and thick, the others filiform and slender with many rings, the third being nearly as long as the last four. The feet are long in proportion to the body, tibia slender and twice as long as the femur, tarsus of two joints, claws two. The male and female generative organs are well made out and do not materially differ from those of other species already described. But a curious organ, apparently not hitherto noticed, is found upon the dorsal surface of the last abdominal segment in both males and females in a position corresponding to that of the oval orifice already mentioned as characteristic of the pupæ of this family. These, together with the distinctive features above-named, are shown in the illustrations which accompany this paper (Plates II., III.).

In his letter to me Mr. Maskell says: "I wish somebody would take up *Aleurodes* seriously; the study is difficult and has only been *scratched* as yet by Signoret and myself," and I venture to throw out this suggestion to members of the Club in search of a line of study a little off the beaten tracks of the diatoms and rotifers. There is but one genus in the family of *Aleurodidæ*, and as the various species known have, for the most part, been named from the plants upon which they are found, I propose to call the one which forms the subject of the present communication *Aleurodes asparagi*.

In conclusion, I desire again to express my indebtedness to Mr. Maskell for the information received from him upon this little known subject, and to my Natal correspondent, the Rev. J. R. Ward, for the trouble which he has taken in the matter of collecting and forwarding the specimens.

With regard to the fact that this scale was only found upon an asparagus plant cultivated for ornament, Mr. Ward makes the suggestion that possibly this may be due to the protection afforded by the verandah, and it seems extremely likely that the fragile waxen plumes would speedily be broken down and washed away by the heavy rains to which an infested plant growing out in the open would be periodically subjected. In the absence of the white wax, it would, of course, be very difficult to detect the presence of so small a scale with the naked eye, and a casual observer might readily, on that account, suppose an infested plant to be free.



## EXPLANATION OF PLATES.

*Aleurodes asparagi.*

## PLATE II.

- FIG. 1. Portion of leaf of asparagus with pupæ in situ.  $\times 20$ .  
 a, with wax intact; b, with dorsal wax removed,  
 showing marginal fringe.  
 ,, 2. Adult male.  $\times 45$ .  
 ,, 3. ,, female.  $\times 45$ .

## PLATE III.

- FIG. 1. Pupa with wax removed, dorsal surface.  $\times 25$ .  
 ,, 2. ,, ,, ventral ,, ,,  
 ,, 3. Transverse section, showing arrangement of wax.  
 ,, 4. Leg of adult.  
 ,, 5. Abdominal extremity of female, side view; d = dorsum.  
 $\times 300$ .  
 ,, 6. Abdominal extremity of male, dorsal view.  $\times 300$ .  
 ,, 7. ,, ,, ,, side view; d = dorsum.  
 $\times 300$ .  
 ,, 8. Tarsus of adult.  $\times 300$ .  
 ,, 9. Antenna of adult.  $\times 300$ .  
 ,, 10. Portion of margin of wing.  $\times 575$ .

## EXAMINATION OF "FOUL" SEA WATER.

(From a sample given by Mr. Shrubsole, in May, 1894.)

By WALTER P. SHADBOLT.

*(Read April 19th, 1895).*

Stroke and deep inoculations were made in agar and gelatine tubes, and kept at 19-20° C., at which temperature all the following observations were made. The growths were all aerobic, being visible along the stroke in 24 hours faintly. The organisms were found to be mixed, and plate cultivations on gelatine for purposes of isolation were made in the usual way. After several transfers from plates to tubes, and from tubes to plates, isolation was effected. Two kinds were occasional, and probably adventitious. Three kinds were persistent.

The two occasional kinds were :—

1. A straight rod, motile during the first day, rapidly liquefying gelatine ; soon becoming motionless, and breaking up into spores, with a putrid smell.

2. Small round organisms, motile to some extent, with a movement like Brownian movement, breaking up into spores, and liquefying gelatine rapidly, with a putrid smell.

These were not observed further.

The three persistent kinds were all rounded bodies, of which tube cultivations on agar are produced. They all liquefy gelatine slowly. The tubes are marked respectively "Star," "White," and "Yellow."

No 1, "Star," cultivated on a plate at 19-20°.

In 24 hours showed no visible growth. In 36 hours there appeared numerous whitish spots, plainly visible under a lin. glass. In two-and-a-half days the spots were visible to the naked eye, and in three days these had developed into star-shaped colonies, whitish, and so far without perceptibly liquefying the medium.

The colonies at first grow from one or two round organisms, which increase irregularly by budding. They are about  $\frac{1}{7000}$  in. in diameter, some as large as  $\frac{1}{5000}$ . As soon as these are numerous

enough to form a crowded cluster of perhaps 20-30, the colony throws out numerous arms of hyaline matter radially, and these keep on increasing in length. Along the arms appear many, (say a dozen or two), nuclear spots, not at regular intervals or in regular lines, but here and there, sometimes two or more side by side, and distributed in the direction of the length of the arm. These nuclei grow into round bodies like the parent, and of the same size, then arrange themselves gradually in the direction of the length of the arm or ray, and finally, as the medium liquefies, after about five to six days, or less, separate.

Neither in the resulting nor any other liquid medium have I seen the star-shaped colony. In liquid the organisms divide irregularly by fission or external budding, and in a few hours break up into masses of minute spores. This organism is at no time motile, and except in the case of the radial processes above described, retains, as an individual, its rounded form.

No. 2 "White" } These are not visible on the plate for  
 No. 3 "Yellow" } about 36 hours. The colonies then appear  
 as white or yellow rounded, (sometimes kidney-shaped), spots, which gradually increase in size. In some of them the edge is definitely marked by a surrounding ring of organisms, packed closely and regularly. In others the edge shows no such bounding ring, and is fissured. These do not break up, are not confluent, and consist of masses of extremely minute rounded bodies. On being placed in a liquid medium they multiply rapidly and irregularly.

These two kinds are so similar, except in colour, and the difference in colour is so slight in the earlier stages of growth, that it is not easy, especially by artificial light, to distinguish them. They are non-motile, aerobic, and liquefy gelatine but slowly.

A temporary absence during the growth on the plates when I had at last got them separated prevented my being ready with more than the above very incomplete observations as to these last two kinds. They are now, as will be seen, well differentiated in the tubes shown, and are ready for further investigation.

The hanging drop cultures, one of each of the three kinds shown herewith, are taken from the respective tubes, and are about 24 hours old.

The media have all been slightly alkaline. Trials were made on agar and gelatine media, in which fish was used instead of meat, but without any difference in the result.

ON SCALE EVOLUTION, AS SHOWN IN *ITHOMIA DIASIA*.

By J. E. INGPEN, F.R.M.S.

(Read May 17th, 1895.)

## PLATE IV.

Variation of form in insect scales, though not considered by systematic entomologists as of much importance, has always been a subject of interest to microscopists, and the question of the line of demarcation (if there be one) between scales and hairs has frequently been discussed. The description of a specimen showing an unusual number of gradations of form may therefore be not altogether useless or uninteresting.

While hunting for illustrations of iridescence, I came across some specimens of *Ithomia diasia*, a clear-winged Columbian butterfly. Though not a showy form, it is very delicate and pretty, the iridescence of the clear parts of the wings being set off by the black ribs and borders. On the underside there is a dull orange and yellow margin to the hind wings, and there are a few dusky white spots on both front and hind wings. On examining the clear parts to ascertain how far the iridescence might be due to plates, lines, dots, etc., I could not help noticing the hairs thinly scattered over them. Some of these were single, others forked, some white, most of them black, the white hairs becoming transparent when mounted in Canada balsam, the black ones a dark brown. These hairs were only present on the clear parts, the ribs and borders being thickly covered with well-defined scales, but close to the ribs and borders numerous transition forms between the hairs and the scales occurred, and it is to the illustration and description of these that I desire to call your attention.

1 and 2.—Single and forked hairs, white and black. Apparently tubular, as shown by the character of the air bubbles expelled in the course of mounting. No appearance of interior granulation or exterior marking.

3.—The part near the fork a little wider and thicker, showing a

few pigment granules. A more developed hair showed traces of longitudinal markings.

4.—A sharp, slender, swallow-tailed scale, with strong longitudinal lines, and short transverse lines between them.

5.—A wider scale, with the sides convex and the ends blunter.

6.—A shorter, wider scale, with two rounded ends.

7.—A similar one, with three rounded ends.

8.—A longer and narrower form, with two bluntly pointed ends.

9.—A leaf-shaped scale, with a sharp point.

10.—A paddle-shaped scale, longer and narrower than the last, and also sharply pointed.

11.—A scale longer, blunt at the end, and apparently thicker.

12.—Longer, narrower, and more solid in appearance.

13 and 14.—Scales or hairs at the margins of the wings, long, bifurcated or trifurcated. All these varieties show strong longitudinal markings.

The scales on the orange and yellow borders to the hind wings and on the white spots are of an ordinary type, similar to 6, 7, and 8, but they have not the strong longitudinal markings characteristic of the others.

15.—In a long oval depression on the upper front margin of the hind wings is a bundle of what I believe are considered to be scent hairs. These differ from any of those already described. They average a quarter of an inch in length, and the largest are nearly  $\frac{1}{1000}$  of an inch in diameter. They are brown, cylindrical, slightly tapering towards the rounded ends, and are firmly attached to the wing. They lie on a bed of cream-coloured scales, somewhat of the shape of No. 6, but with very obscure markings. These hairs have a cell structure suggestive, in miniature, of that of the deer, with a distinct medulla. This structure is probably well known to those who have studied the characteristics of scent hairs. On the under margin of the front wings are a number of scales, which, when the wings are closed, are in contact with the scent hairs, and appear to have a somewhat similar structure, but less developed. The striæ are only on one side, on the other are traces of cell-structure and pigment dots.

The attachment of the hairs first described, 1, 2, 3, etc., to the wing, is very pretty—the socket looking like the neck of a bottle with a thickened rim.

Many more transition forms could be shown, but those illustrated will, I think, be sufficient for the purposes of this paper.

I have used the terms lines, striæ, etc., in our ordinary microscopical sense, to indicate general appearances rather than the exact structure of the hairs and scales.

In conclusion, I must thank Mr. Karop for his kind assistance and admirable illustrations.

---

## ON SCALE EVOLUTION IN THE LEPIDOPTEROUS GENUS ITHOMIA.

By W. H. NUNNEY.

*(Communicated by J. E. Ingpen, May 17th, 1895.)*

In taking advantage of Mr. Ingpen's wish that I should supplement his paper from the comparative and systematic aspect in contradistinction to the purely histological, and his most interesting observations having apparently opened up a new field of inquiry, it was, of course, necessary for me to overlook a great number of butterflies and moths for purposes of comparison. My observations are, I believe, in the main correct, but it is possible from their extent, and the little time I was able to devote to the matter, that certain of them may need future modification, more especially as I did not intend to render them exhaustive.

The question of scale evolution is one which unfortunately has attracted little attention, notwithstanding its great interest. Nowhere can it be more effectively studied than in butterflies and moths. The occurrence in that order of every variety of scale form, from the almost filamentous to the broadened plate known as the "battledor," affords the widest possible scope for theory. Till of late we needed to search through numerous species to discover transition forms between hair and scale. The discovery of nearly all the varieties on the wings of a single species of *Ithomia* has, however, placed the matter in a better light, and gives additional verification to the theory of the evolution of the true scale from the simple hair.

The *Ithomiæ* are an exceedingly concrete group of American butterflies, characterized by the possession of clear or semi-transparent wings, the lower ones provided with scent pouches, as in the whole of the sub-family *Danainæ* to which they belong. These scent sacs during the insect's life diffuse an odour objectionable to most insect-eating birds and reptiles, the species being thus rendered less likely to be preyed upon. The whole group is usually placed in an intermediate position between the white tribe

of butterflies and a group of curious and evil-smelling forms (*Acreinæ*) almost confined to the African continent. Bates and some others have argued, and perhaps justly, that these insects, being well protected from the attacks of their greatest enemies, and being at the same time very frequently imitated by members of other groups without this means of defence, should be placed at the head of all the butterflies as possessing the highest organization. Such view, however, is by no means generally accepted, and the swallow-tailed species still hold their old place at the head of the entire order. It is to the somewhat isolated genus *Ithomia* to which the occurrence of the features mentioned in Mr. Ingpen's paper are almost entirely restricted. I have sought long and carefully for a parallel amongst the clear-winged species of all groups of macro-lepidoptera, and so far have been quite unable to find such. Each group—in fact, almost each species—has its own peculiarities of wing-covering, and the whole forms a most interesting and instructive study, but nowhere, even amongst *Ithomia*'s direct congeners, do we see the numerous variations of scale-shape to which Mr. Ingpen has drawn attention.

Commencing our comparison with the typical family of swallow-tailed butterflies, the clear-winged species of which are but few, we find in the curious little *Leptocircus* (said when at rest to mimic a dragon-fly) a peculiar disposition of the wing-covering. The fore-wings alone are provided with clear spaces. Over the whole upper surface of these long-stalked, bifid, wedge-shaped scales are sparsely arranged in rows, whilst the lower surface apparently has absolutely no scales, their place being occupied by long and curved finely-pointed hairs. The attachments of both to the wing membrane are so nearly coincident (in some cases exactly so) as to render it extremely difficult to convince oneself, even by the use of a good microscope, that both hair and scale do not actually proceed from an identical point of origin on the upper surface of the wing. The accompanying Figure 1 shows this appearance well.



Fig. 1.



Fig. 2.



A few bifid scales with shorter stems occur as in *Ithomia*. In the diaphanous *Eurycus* fan-shaped scales only occur, whilst in some of the Apollo butterflies (*Parnassius*) scale-hairs and true scales are found without connecting forms. Passing from the Papilioninæ we come now to the sub-family to which *Ithomia* itself belongs. With the exception of the pre-eminently clear-winged group of which *Ithomia* is an essential member, we find nothing remarkable in the character of the wing clothing. Excluding these, nearly the whole of the other species have wings well provided with scales of ordinary character. The typical genus *Danais* has oval scales, whilst its off-shoot *Amauris* has diaphanous scales of pronounced battledor type.

In the whole of the clear-winged genera to which *Ithomia* is closely allied much the same character of wing-covering obtains *inter se*, the members being mostly possessed of the bifurcate hairs so prominently displayed in *Ithomia*, transition forms between the hair and scale being rare.

The next following group of Heliconian butterflies from South America differs entirely from *Ithomia* in the wing-covering, for I have nowhere observed amongst them other than true scales. In the closely-allied and evil-smelling *Acreinæ* there are two main types, one possessed of wings having a wholly-coloured surface furnished with true scales only on the wing plane, with, however, spiny hairs on the wing margins; and another, the members of which have the greater portion of the wing semi-transparent. In these latter the clear positions are furnished with scale-hairs, whilst the coloured portions are provided, as is usual, with true scales.

Passing to the woodland species, almost the only representatives having the wings furnished with clear spaces are the wonderful leaf butterflies. In these, the clear spots are covered with highly-transparent true scales of an elongated oval form, notched very slightly at the extremity. In *Citherias*, the most diaphanous of all butterflies, the wing-covering exhibits none of that fine gradation of structure existing in *Ithomia*, the transparent parts of the wing being furnished with hairs pure and simple, no scales of any kind being developed until certain eye-like markings are reached. In fact, it may, I think, be taken as a fixed principle in Lepidoptera that true scales alone normally play any part in the chromatic ornamentation of the wing membranes, although *Citherias*

is in itself an exception, as in *C. aurora*, for instance, the rosy patch on the hind wings is caused entirely by the presence of pigmented hairs. These hairs are connected with the normal fan-shaped scales by a transition form of the shape shown in Figure 2.

In the members of this and the closely-allied genera *Hætera*, *Pierella*, and *Antirrhæa*, the wings of all of which are clothed more and more fully, the further we depart from *Citherias*, we also find, as might be expected, a slight increase of transition forms of scale and hair.

In *Zeonis sylphina*, an American butterfly, remotely allied to the "hairstreaks," and which, at first glance, has the appearance of a clearwing moth, we find on the hyaline portion of the wing no hairs, but singularly enough scales of the swallow-tail type so characteristic of *Ithomia*. This is explicable, notwithstanding the remoteness of the two groups, on the supposition that such form is a primitive type, probably having occurred anciently on all species alike, but now crowded out by later developments.

Turning from the butterflies to the moths, the most striking forms for our purpose are, of course, the mimicking "clearwings." The members of this group may be considered as comprising two sub-groups, in the first of which the wings where clear are absolutely so, as in some foreign and one or two British species, whilst the other, by far the most numerous in species, possesses various forms of scale, ranging from the peculiar strongly-ribbed, long-stalked kind on the wing fringe of the currant clearwing, through the fan-shaped to the almost circular and transparent form found commonly upon the clear portions of the wings. *Macroglossa marginalis*, a Columbian species, is peculiar, inasmuch as it combines the characters of these two groups; the forewings are moderately covered with true transparent scales, while the clear spaces of the hind wings are entirely destitute of either scales or hairs. The transition genus *Cocytia* has the glassy spaces of the wings, like the first group of true "clearwings," entirely devoid of covering.

In other of the moths, notably the larger silk-making species, clear spaces occur on the ordinarily thickly-covered wing membrane. These in the great Atlas Moth are haired only, and apparently no transition forms occur. Circular windowed species, like the Tussore silk moth, have apparently neither hairs nor scales on the clear portions of the wings, the "windows" being sharply defined by a thick growth of true scales on the periphery.

The foregoing comparisons lead us to the conclusion that numerous transitional forms of scale are very rare, such a phenomenon as occurs in *Ithomia* being unique in its own group. The question naturally arises, how is it that *Ithomiæ* alone show scale evolution more perfectly than do other insects? On the supposition that *Ithomia* is an extremely ancient type, if not indeed a truly primitive form, this may be satisfactorily answered. Palæontological evidence, however, by no means bears this out. The earliest occurrences of Lepidoptera in geological strata, excluding the disputed *Palæontina oolitica*, are of a very different group, the hawk moths or Sphingidæ, and in no way allied to *Ithomiæ*, although such evidence is from the imperfection of the record not at all conclusive. On structural evidence the primitive position may probably be assigned to the Swift moths or Hepialidæ. It is then all the more singular that with such comparatively high development in other respects, so many and curious transitional forms of hair and scale should occur in *Ithomia* and its allies, and it is worthy of passing note that the true battledor scale so characteristic of the butterfly known as the Azure blue does not occur in the *Ithomian* series. Perhaps we are altogether mistaken in assigning so high a development to the battledor scale. This negative view is apparently borne out by a reference to some of the lower scaled insects. Certain white-ants (admittedly a very ancient group), found only in a fossil state, are furnished, not as might be expected with coverings of the hair scale type or simple hair, but are clothed with near approaches to the battledor type. In *Perientomum* I believe this is markedly the case. Amongst the *Poduræ*, or springtails, the body covering is almost without exception composed of scales of the crenate battledor type possessing a high, possibly the highest development, notwithstanding that the creatures themselves are of the most lowly degree, on this account having been shelved from the insect series, and, indeed, considered as insect prototypes. The question of the evolution of true scales from simple hairs is thus thrown back immeasurably further into the past. That this battledor type is really a development and not a primitive form must, I think, be allowed when it is considered that beetles, which are undoubtedly of a higher type than even butterflies (Agassiz notwithstanding) possess hardly any other description of scale. By the facts relating to the *Poduræ* the reverse is of course implied. There are great difficulties in either

view, and that of evolution does not explain why, for instance, a lowly creature like *Polyxenus* amongst the Myriapods should be furnished with hairs so vastly more complicated than any that occur on the Ox fly, or many beetle larvæ. There are difficulties almost insurmountable in the holding of views other than those based on mere adaptation to circumstances, but it would certainly seem that although we cannot point to *Ithomia* as a positive example of scale evolution, yet the great number of intermediate forms between the simple hair and the true scale tends to impress the observer with the idea that we have here actually caught a glimpse into the heart of the developmental process, and I, at least, am unacquainted with any instance by which the subject is better illustrated.

## NOTES ON SOME PLANTS COLLECTED IN THE PYRENEES.

By J. W. REED.

*(Read June 21st, 1895.)\**

It has been thought that the series of plants exhibited this evening which were collected in the Central Pyrenees in June and July of 1894, and found at heights varying roughly from 5,000 to 9,000 feet, may be of scientific interest to some Members of the Club, and to others serve as a relaxation from the abstruse and severe researches which usually engage their attention. At any rate, the exhibit may more or less usefully help to fill up an evening not otherwise fully occupied. In no wise do these rough and imperfect notes aspire to the dignity of what is known as a "Paper," much less to a place in a Journal amongst critical discussions of the optical theories of the microscope, or of the relation of the refractive indices of mounting media to the resolution of diatoms.

The plants now exhibited were collected either in the upland meadows of and about Gavarnie, a tiny village in the heart of the great range of the Pyrenees, or on the loftier heights and wilder valleys in its neighbourhood. A few were collected during ascents of the snow-peaks which here abound, but the majority were the fruit of quiet though long rambles on days not devoted to laborious climbing. Our visit to the Pyrenees was mainly for mountaineering and photographic purposes; but, though we also had some botanical aims, no attempt was made to collect systematically. Whilst a number of plants very common in England were not pressed, those before us may, I suppose, be fairly considered as typical of the particular locality and of its early summer flora as it presents itself to the average traveller.

I am greatly indebted to Mr. G. Nicholson, the Curator of Kew Gardens, for the careful naming of the various species, for much

\* Mr. Reed wishes it to be understood that this paper was not written for publication, but merely as a running commentary on his exhibition of Pyrenean plants; nevertheless, at the earnest request of several members, he has consented to allow it to be published.—ED.

varied information with regard to many of them, and for his more than kind offices in getting them so beautifully mounted for me.

Their being so well dried and displayed is mainly due to the care and skill bestowed on them by Mr. F. H. Ward (my travelling companion), and to the use of an admirable botanical press designed by him, and described and figured in "Science Gossip," No. 280, April, 1888, page 80; it was also described and figured in the "Bulletin of the French Linnean Society" the same year.

My authorities for the number and distribution of the species are Bentham and Hooker, whose "Genera Plantarum" has been referred to throughout. It may be mentioned, also, that the "Mediterranean Region," for geographical and botanical purposes, includes all the South Coast of Europe, North Africa, and Asia Minor, and also the Isles.

Botanically, the Pyrenees is one of the most interesting regions of Europe, and a point of special interest to the British botanist is the existence of a colony of Pyrenean plants in the West of Ireland. It is no doubt another of the woes of that "distressful country" that even some of its plants appear "in a foreign garb." Amongst these plants may be mentioned *Arbutus unedo*, *Dabæcia polifolia*, *Neotinea intacta*, *Saxifraga Geum*, *Saxifraga umbrosa*, *Erica mediterranea*, and *Meconopsis cambrica*, and their presence at once opens up the wide and difficult, but profoundly interesting, question of plant distribution.

It has been suggested that this colony immigrated along a range of now submerged mountains, which extended from Spain to Ireland across the Bay of Biscay. Whilst the theory of this particular continental extension has not been supported by sufficient evidence to secure its general acceptance by geologists, it is believed that in Tertiary times Britain was connected with France, and Ireland was not so far removed from Great Britain as she is now. Whether or not our flora had a continental origin, having immigrated prior to the existence of the English Channel and the German Ocean, Mr. J. G. Baker, Keeper of the Herbarium at Kew, in his Presidential Address to the Yorkshire Naturalists' Union in 1883, said that "the most important general character of the British Flora is its utter want of any distinctive individuality. Leaving out of count a few doubtful hieracia, willows, rubi, and roses, I can give only two good instances of British plants that do not occur in continental Europe." The two plants mentioned by

Mr. Baker were *Potamogeton lanceolatus* and *Liriocaulon septangulare*. Nor, in the consideration of any general question of plant distribution, must we leave out the agencies of oceanic currents, winds, and birds. Sir Joseph D. Hooker has told us that seeds have germinated at Kew after floating in the sea for 3,000 miles, and Darwin that dust is blown 1,000 miles over the ocean—the dust of the Krakatoa explosion, as we all remember, was carried much further—and the extreme minuteness of many seeds is well known to everyone. Birds not only eat seeds directly, but also prey on fresh-water fishes which eat them too, and, as Darwin has also shown, carry seeds over the ocean “in their feet, beaks, and stomachs.”

This being so, it is not a matter for surprise that in many parts of the world what are clearly immigrant forms should be found side by side with an indigenous flora.

Whilst the interposition of seas, deserts, mountain ranges, and even forest regions has done much to differentiate the floras of the various portions of the earth's surface, climate has done more. Generally speaking climate becomes more rigorous as we ascend, and thus in climbing from the plain to the summits of mountains like Mont Perdu, the Vignemale, or the Marboré (all about 11,000 feet high), we find well-marked zones of vegetation. From the rich and fruitful one at the foot, we pass through fir forests, then over green alps with their northern flora, until nothing but mosses and lichens are seen—the latter at last appearing as splashes of colour only, on the higher wind-swept rocks; and finally on to the eternal snows, their surface reddened here and there by the lowly unicellular alga, *Protococcus nivalis*. In some parts of the Pyrenees, as in the Alps, it is possible to tell approximately the height to which we have ascended by observing the plants; but this is not always so, for from various causes not yet fully determined, many upland valleys and high passes of the same height have been found to vary greatly in their mean temperature.

There is also, without doubt, an intimate relation between the chemical composition of soils and distribution, but in this, as in other directions, there is much left to be worked out. It may here be stated as a fact which generally holds good that plants do not always grow where *primâ facie* they might be expected to flourish, such growth often being prevented by the presence of other forms of vegetation in some respects better equipped for the struggle

for existence. It would be an impertinence were I for one instant to suppose myself competent to deal critically with the complex problems of plant distribution, but I could scarcely forbear to mention as above and thus briefly the striking connection of a special portion of our flora with that of the Pyrenees.

In the Pyrenees we meet not only with plants well represented in Britain, and belonging to large orders widely distributed, but with others purely Pyrenean, or very rare, and of limited distribution. Some are seen which have been brought into general cultivation, and plants as familiar as the common "London Pride" of English gardens abound.

The following plants belong exclusively to the Pyrenean region, viz., *Ramondia pyrenaica*, *Galium pyrenaicum*, *Antirrhinum molle*, *Asperula hirta*, *Geum pyrenaicum*, *Viola cornuta*, and *Silene ciliata*. As to *Lonicera pyrenaica*, the type is probably confined to the Pyrenees.

I need scarcely add that, if one has travelled in Switzerland, many old Alpine friends will also be found in the Pyrenees, and here, as elsewhere, we cannot fail to notice the well-known tendency of the flora at high levels to become smaller and low growing, with stiff leaves and tough fibrous roots—the plants generally being bitter to the taste and resinous. The flowers also, in proportion to the size of the plants, are large and of brilliant colour, due doubtless to their unconfined situation, the pure air, and unobscured sunshine.

We notice also a certain correspondence between the flora of mountains and of high latitudes. As one ascends mountains the rule is that the forms of lower levels are replaced by Alpine forms. For instance, the birch trees of the lowlands are represented at high levels by *Betula nana*, often only three inches high, and the willows—trees or big bushes of the plains—are represented on our own mountains by *Salix herbacea* and *Salix reticulata*, prostrate shrubs only an inch or two high. These plants are, of course, found in the lowlands of high latitudes.

The rule referred to is not universal, for Sir Joseph D. Hooker, in a lecture on "Insular Floras," has dwelt on the curious facts that from a height of 4,000 feet on the mountains of Madeira to their summits of 6,000 feet there is "little or none of that replacement," and that the mountains of the Canaries, nearly 11,000 feet high, contain no Alpine plants—that, indeed, the



mountains of islets, however lofty, present few Alpine or sub-Alpine species.

Perhaps the plant which most attracted our attention in the Pyrenees was the *Ramondia pyrenaica*. Its hairy, primrose-like leaves and purple blossoms profusely adorned the rocks all around Gavarnie. Although largely cultivated in the rockeries of English gardens, the *Ramondia* has no near ally in our flora. Indeed, the order to which it belongs—the *Gesneraceæ* of Bentham and Hooker—although extensively represented by about 700 species, widely dispersed throughout the tropical and sub-tropical regions of both hemispheres, has only four species in Europe, three of the four being *Ramondias*. One species is Pyrenean, one Servian, and one Greek. The Greek species introduced into this country has not, up to the present, been successfully cultivated. It was introduced by Max Leichtlin, of Baden-Baden, who obtained living specimens from Mount Olympus, I believe at an expense of about £100, as, owing to the presence of brigands, an escort of soldiers had to accompany the botanist. The *Ramondia pyrenaica* grows from a height of 5,000 to 6,000 feet roughly.

The fourth species, *Haberlea rhodopensis*, is a native of Thrace, etc.

There is now in full flower at the south end of the rockery at Kew a beautiful group of the *Ramondia pyrenaica*, the colours varying from white to deep lilac. Local conditions have not been without effect, for the leaves are not as hairy nor the flowers as deep-coloured as those seen by us in the Pyrenees. Some plants of *Haberlea rhodopensis* are also in flower quite near to the *Ramondias*, and a plant nearly allied to the latter—*Saintpaulia ionantha*—recently introduced from the mountains of East Tropical Africa, is also in flower in one of the houses at Kew Gardens.

The high Alpine orchid, *Nigritella angustifolia*, found throughout Continental Europe, from Sweden and Norway to Greece, also grows abundantly near Gavarnie. Its head of blackish-purple flowers and strong vanilla-scent are very noticeable. This plant is now included by Bentham and Hooker under *Habenaria*. It too may now be seen in flower at Kew.

The Welsh poppy—*Meconopsis cambrica*—is found in Ireland, England, Central and Southern France, the Pyrenees, and Northern Spain. When doing a little collecting some years ago I got specimens from within the cliffs of the "Devil's Kitchen" in North

Wales, but have never seen its delicate yellow flowers displayed so freely as at Gavarnie. There are only about nine species in the genus *Meconopsis*, one belonging to Western Europe, two to N.W. America, and six Himalayan.

Our old friend—*Narcissus pseudo-narcissus*—daffodil or Lent lily, was found in myriads on the mountain slopes near the Col de Vignemâle. Of this species, about 200 forms are distinguished by names by English growers. The mucilage of this plant was formerly used as a violent emetic.

*Astrocarpus sesamoides*, belonging to the *Resedaceæ*, grows freely on the banks of the glacier stream which comes down from the mountains of the Cirque de Gavarnie. There are only five species in the genus *Astrocarpus*, all South European. Our garden mignonette belongs to the same order, but what was the origin of this favourite plant is a mystery no one has yet solved; it has nowhere been found wild. This question may yet be cleared up like that of the origin of the Common Onion (*Allium Cepa*). Though cultivated from the earliest times, being mentioned on the Pyramid of Cheops, where is inscribed, in Egyptian characters, an account of the quantity consumed by the workmen, it was not found wild until within quite recent years, when it was discovered in Western Siberia by Dr. Regel.

*Erinus alpinus*, the only species in the genus, sometimes occurs with white flowers, and it also is a favourite plant in cultivation in English rockeries.

*Iris xiphoides*, with which towards the middle of last July the meadows and pastures of Gavarnie were everywhere blue, is a native of the French and Spanish Pyrenees, and extends to Asturias. It is the well-known so-called English Iris of gardens, and of which several colour varieties were cultivated 250 years ago.

*Vincetoxicum officinale*, the milky juice of which has been used as an emetic, we had often seen in Switzerland. It belongs to the order *Asclepiadeæ*, which is not represented in the British Flora.

*Rhododendron ferrugineum*, the "Rose des Alpes," the leaf-scales of which are a beautiful microscopic object, is common in the Pyrenees, Alps, Appenines, etc. Its buds are still used by the natives of the Alps in preparing an anti-rheumatic liniment called "Marmot-oil." There are about 130 species of the genus distributed over the mountains of Europe, Asia, the Malay

Archipelago and North America—one is found in New Guinea. This is another of the Alpine plants now well in flower at Kew.

In crossing the mountains of the Val d'Héas to the Cirque de Trumouse, we found large areas quite rosy with the flowers of *Daphne Cneorum*, a charming glabrous and procumbent little shrub, the leaves and seeds of which, however, possess extremely acrid and objectionable properties. This plant and our own *Daphne Laureola* (or spurge laurel) were once regarded as of great medicinal value; but that was at a time when the efficacy of therapeutic agents appears to have been adjudged by their nastiness. No doubt these heroic medicines had their use, for their violent action would, at least, serve to distract the patient's attention from the rapidly approaching dissolution which the treatment of former days too often implied.

*Anemone Hepatica* is largely cultivated, and, in cultivation, the flowers vary from pure white, mauve and red, to deep blue; and there are many double forms.

*Hyacinthus amethystinus* is a beautiful little garden plant. There are about 30 species of *Hyacinthus*, with the exception of three South African, all natives of the Mediterranean region and the Orient.

The purely Pyrenean *Viola cornuta* has been largely propagated in gardens, and has given rise to some of the so-called Violas or Tufted Pansies. As we found it in its wild state, the flowers were lavender, but under cultivation all sorts of colours have been obtained by crossing.

*Arnica montana* is common on and near the rocks of the village of Gavarnie. It is a striking plant, and its flowers are supposed to contain a property stimulative of the action of the skin. The shepherds of the Alps may often be seen gathering the heads of Arnica, Hypochæris and other yellow-flowered compositæ, for the purpose of making tincture of Arnica.

The much-talked of "Edelweiss"—*Leontopodium alpinum*—is found freely distributed in the Alps, Pyrenees, Carpathians, and other mountains of Europe. The dangers of gathering this plant, though often the subject of much literary tail-lashing, are quite imaginary. Our specimens were found near the right bank of the stream known as the Ordesa, well down the Val d'Arras, on the Spanish side of the Pyrenees. Some we obtained were amongst the finest I had ever seen, and were growing at a height

of, I should guess, about 4,000 ft. or 4,500 ft. above sea-level. Edelweiss may grow as low down as that elsewhere, but I had never before collected it except at a much greater altitude.

*Globularia nana*, common enough in the Pyrenees, is not found in the Swiss Alps.

*Draba aizoides*, plentiful in the Pyrenees, and generally in the mountains of Central and Southern Europe and West Asia, is a doubtful British native. It is found only, I think, on the walls and rocks of Pennard Castle, in Glamorganshire.

*Dianthus plumarius* has been naturalized in Britain, being found on old walls in England and Wales. The origin of our garden pinks is to be traced to this species; *Dianthus Caryophyllus*, also naturalized, being the progenitor of our garden carnations.

*Helleborus viridis* I had never seen growing so freely before. In fact, the only spot where, up to last June, I had met with it in any quantity, was in a wood in Kent, to which a little party, including one whose name will long be held in kindly remembrance by members of this Club—I refer to our late friend Mr. W. W. Reeves—were guided by Mr. Carrington, now the editor of "Science Gossip." Its distribution is from Holland southward; but, according to Ball, it is not well established north of the Mediterranean region. This seems to point to this species being of southern origin.

Memories of our old comrade and friend came thick upon us as we collected *Gentiana verna*, *Primula farinosa*, *Bartsia alpina*, *Polygonum viviparum*, and other plants which had also been collected in his company during a short botanical tour in Teesdale some years ago. I well remember his delight in our Teesdale spoils. *Myosotis alpestris*, collected in the Pyrenees, was obtained in Teesdale on the same occasion, and it grows also on Ben Lawers in Scotland. It is, according to Bentham, the Alpine form of *M. sylvatica*; but most botanists regard it as a distinct species.

Whatever may be thought as to the northern derivation of the European flora generally, *Bartsia alpina* is one of the species which, it is pretty certain, has worked south from Scandinavia, which appears to have been and still is its home.

*Polygonum viviparum*, a circumpolar species, is found all through the Arctic zone, in both hemispheres. It too has travelled south from the Polar regions. Abundant in the North of Scotland, it

becomes distinctly scarcer in England, until south of Yorkshire and Carnarvon it entirely disappears.

A detailed list of all the species we collected is given below, with their classification, number of species in the genera, and distribution. In concluding I can only express my regret that my knowledge has not admitted of my making these botanical jottings more worthy of the occasion and of this Society.

List of Plants collected in the Central Pyrenees from June 19th to July 24th, 1894:—

**Ranunculaceæ.**

*Ranunculus Gouani*, Willd. Pyrenees. Species about 160.

*Helleborus viridis*, L. From Holland southward, but not well-established north of the Mediterranean region (Ball). Species 10. Two only British.

*Aquilegia vulgaris*, L. Europe, N. Africa, N. and W. Asia to W. Himalaya. Species 5 or 6.

*Anemone narcissiflora*, L. Central and S. Europe. About 70 species.

*Trollius europæus*, L. Europe (Arctic) to the Caucasus. Species about nine.

*Aconitum Napellus*, L. Mountains of Northern Hemisphere. Species about 18.

*Anemone Hepatica*, L. Europe.

**Papaveraceæ.**

*Meconopsis cambrica*, Vig. Say nine species in genus, one in Western Europe, two in N. W. America, six Himalayan.

**Cruciferae.**

*Brassica Cheiranthus*, Vill. W. and S. Europe, N. Africa. Species about 100.

*Nocca alpina*, Reichb. Alps of Europe. Species two.

*Draba aizoides*, L. Mountains of Central and Southern Europe, W. Asia. Species 80.

**Resedaceæ.**

*Astrocarpus sesamoides*, Gay. Five species. All South European.

**Violaceæ.**

*Viola sylvatica*, Fries. Species say 100. Europe, N. and W. Asia, N. America, etc.

*Viola cornuta*, L. Pyrenees.

*Viola biflora*, L. Pyrenees to Arctic Russia.

**Polygalaceæ.**

*Polygala amara*. Arctic Europe, and from Sweden southwards. Very rare British plant. About 200 species.

**Caryophyllaceæ.**

- Gypsophila repens*, L. Pyrenees to Carpathians. Species about 50.  
*Dianthus plumarius*, L. Var. Central Europe. Species about 70.  
*Dianthus deltoides*, L. Europe.  
*Silene acaulis*, L. All Arctic regions, Alps of Europe, W. Asia and N. America. Species 800.  
*Silene ciliata*, Pourr. Pyrenees.  
*Cerastium arvense*, L. Europe, N. Africa, Siberia, W. Asia to Himalaya, N. America, Chili, Fuegia. Say 40 species.

**Geraniaceæ.**

- Geranium cinereum*, Cav. Pyrenees and Italy. Species about 100.  
*Geranium phæum*, L. Central and W. Europe.  
*Geranium sylvaticum*, L. Europe (Britain), Siberia, W. Asia.

**Papilionaceæ.**

- Anthyllis montana*, L. Europe, N. Africa, W. Asia. Species 20.  
*Vicia pyrenaica*, Pourr. Spain, Pyrenees, Dauphiné. Species 100.  
*Ononis repens*, L. Europe, W. Asia, N. Africa. Species 60.  
*Astragalus monspessulanus*, L. Pyrenees to Dalmatia. Species 500.

**Rosaceæ.**

- Rosa pyrenaica*, Gouan. Pyrenees, etc. Species about 30, fide Hooker (sub-species of *R. alpina*).  
*Dryas octopetala*, L. Arctic and Alpine regions of N. temp. zone. Species two or three.  
*Alchemilla alpina*, L. Europe, N. and W. Asia, Greenland. Species 30.  
*Geum pyrenaicum*, Willd. N. and S. temp., and cold regions. Species 30.  
*Potentilla splendens*, Ram. Spain, W. and Central France, Pyrenees. Species 120.

**Saxifragaceæ.**

- Saxifraga granulata*, L. Say 160 species in genus. Principally Alpine plants, distributed chiefly in temp. and Arctic regions of Northern Hemisphere. Species few in Asia, very few in S. America. Nyman makes 107 species for Europe alone.  
*Saxifraga aizoon*, Jacq. Dis. widely throughout Europe. Some authors split up this species into about a dozen.  
*Saxifraga umbrosa*, L. Dis. W. Europe.  
*Saxifraga muscoides*, Wulf. W. Europe.  
*Parnassia palustris*, L. Say a dozen species in genus. Nearly all Europe. Natives of temp. and cold regions of the Northern Hemisphere and mountains of India. Often marsh-loving plants.

**Umbelliferae.**

- Eryngium Bourgati*, Gouan. About 150 species in genus. Dis. over warm and temp. regions of both Hemispheres. None in S. Africa.

*Astrantia major*, L. Five species represented in European flora.  
Dis. throughout Europe and Western Asia.

**Caprifoliaceæ.**

*Lonicera pyrenaica*, L. 80 species in genus. Natives of the temp. and sub-tropical regions of the Northern Hemisphere.

**Stellatæ** (Tribe of Rubiaceæ).

*Galium pyrenaicum*, Gouan. Pyrenees only. Nyman gives 94 species as European.

*Asperula hirta*, Ram. About 80 species described, but many badly defined. Pyrenees. Nyman gives 40 species as European.

**Valerianææ.**

*Valeriana montana*, L. About 150 species in genus. Dis. of *V. montana*, Mountains of Central, Southern, and Eastern Europe. Dis. of genus, temp. and cold regions, Northern Hemisphere, Old World, and in N. America and along Andes, in extra tropical S. America; a few in Brazil and India.

**Compositæ.**

*Aster alpinus*, L. Europe, etc. Species about 150.

*Erigeron alpinum*, L. Alps and Arctic Europe, Asia, N. America, S. Chili, Fuegia. Species about 80.

*Arnica montana*, L. Species about 10.

*Leontopodium alpinum*, Cass. Pyrenees, Alps, Carpathians, etc. Species five.

*Antennaria dioica*, Br. Temp. and Arctic Europe, N. Asia, N. America. Species about 10.

*Homogyne alpina*, Cass. Mountains of Europe. Species three.

**Campanulaceæ.**

*Phyteuma orbiculare*, L. Europe (Britain). 30 species. 19 in Europe

*Jasione perennis*, Lam. Europe (Britain). Species about 13.

*Campanula glomerata*, L. Europe (Britain) and N. and W. Asia. Species about 230. All temp. and most tropical climates.

**Ericaceæ.**

*Rhododendron ferrugineum*, L. Pyrenees, Alps, Appenines, etc. Species about 130.

**Plumbagineæ.**

*Armeria alpina*, Willd. Mountains of S. and Central Europe, etc. 30 species.

**Primulaceæ.**

*Primula viscosa*, Vill. Pyrenees to Tyrol. Say 100 species. 40 in Europe.

*Primula elatior*. Britain, from Gothland to Siberia and southwards.

*Primula integrifolia*, L. Pyrenees to Switzerland and Lombardy.

*Primula farinosa*, L. Arctic Europe, N. Asia, Thibet, Greenland, N. United States.

*Douglasia vitaliana*, Benth. and Hooker. Mountains of Central and W. Europe. Species four.

*Androsace carnea*, L. Pyrenees to Tyrol. Species 40. Half European.

*Androsace villosa*, L. Alps, Pyrenees, etc.

*Soldanella alpina*, L. Alps, Pyrenees, Tyrol. Species three or four.

#### **Asclepiadææ.**

*Vincetoxicum officinale*, Moench. Europe. About 70 species.

#### **Gentianaceæ.**

*Gentiana verna*, L. Say 180 species in genus. Teesdale, Ireland, Pyrenees, N. Italy, mountains of Central and E. Europe, Greece.

*Gentiana acaulis*, L. Nearly same distribution as last, except England and Ireland.

#### **Boragineæ.**

*Myosotis alpestris*, Schm. Alps, Pyrenees, etc. Species about 30. (Ben Lawers in Scotland).

#### **Scrophularineæ.**

*Linaria alpina*, L. Nyman enumerates 93 species as European. Mountains of Southern and Central Europe. Species 130. Europe and W. Asia.

*Pedicularis tuberosa*, L. 150 species. Nyman gives 42 species as European. Pyrenees to Tyrol.

*Veronica serpyllifolia*, L. 200 species. Nyman gives 60 species as European. Dis. Europe (Britain).

*Linaria supina*, Desf. S.W. Europe.

*Antirrhinum molle*, L. Species 95. Nyman gives 13 in Europe. Pyrenees.

*Erinus alpinus*, L. Only one species in genus. Pyrenees, Dauphiné, S. France, Switzerland, N. Italy.

*Scrophularia canina*, L. Species 120. Nyman gives 37 as European. Portugal to Montenegro, etc.

*Bartsia alpina*, L. Mountains of Europe (Britain). Species 60.

#### **Lentibularineæ.**

*Pinguicula grandiflora*, Lam. W. France, Alps, Pyrenees, Spain, Portugal (Ireland). About 20 species.

#### **Gesneraceæ.**

*Ramondia pyrenaica*, Lam. Three species in genus. One in Pyrenees, one in Servia, one in Greece.

#### **Selagineæ.**

*Globularia nana*, Lam. Pyrenees, etc. Not found in Swiss Alps. Species about 12.

*Globularia nudicaulis*, L. Pyrenees, Alps, etc.

#### **Labiataæ.**

*Teucrium pyrenaicum*, L. Pyrenees, Dauphiné. Species 300 (?).

*Sideritis scordioides*, L. S. France, etc. Species about 45.



*Thymus Serpyllum* L. Europe (Arctic), N. and W. Asia, Himalaya, Greenland. Species 40.

*Horminum pyrenaicum*, L. Pyrenees, Alps to Tyrol. Only species in genus.

*Lamium maculatum*, L. Unspotted var. Temp. Europe, Asia, and N. Africa. Species 40.

*Ajuga genevensis*. Europe, etc. Species 30.

**Polygoneæ.**

*Polygonum viviparum*, L. Europe (Britain). 50 species in genus.

**Thymeleæ.**

*Daphne Cneorum*, L. Mountains of S. and W. Europe. Species about 50.

*Daphne Laureola*, L. Europe (Britain), from Belgium southward, N. Africa, W. Asia.

**Salicineæ.**

*Salix incana*, L. Nyman, in "Conspectus Floræ Europæ," enumerates 51 species as European, and there are very numerous hybrids. A most intricate and difficult genus. 160 species.

**Euphorbiacæ.**

*Euphorbia Cyparissias*, L. Europe. Species 600. Nyman gives 107 as European.

**Santalaceæ.**

*Thesium alpinum*, L. Europe. Species 100.

**Orchideæ.**

*Nigritella angustifolia*, Rich. Dis. throughout Europe (Continental), from Sweden and Norway to Greece. Say 400 species.

**Irideæ.**

*Iris xiphoides*, Ehrh. Say 181 species. Genus is spread over Europe, N. Africa, temp. Asia, and N. America.

**Amaryllideæ.**

*Narcissus pseudo-narcissus*, L. Baker, in his "Amaryllideæ," makes 16 species. Nyman, in "Conspectus Floræ Europæ," 42.

**Liliaceæ.**

*Hyacinthus amethystinus*, L. Pyrenees, etc. Not Swiss. Species about 30; all but three Med. region and Orient.

*Scilla verna*, Huds. Coasts of Norway, France, Pyrenees, Spain. Species about 80.

*Asphodelus albus*, W. Central and Southern Europe. Species six or seven.

*Tofieldia calyculata*, Whlb. Europe. Species 14.

*Anthericum Liliago*, L. Europe, etc. Species about 50.

**Filices.**

*Asplenium septentrionale*, Hull. Europe, N. and W. Asia, Himalaya, N. America. Rare in Britain. Species 280.

- Asplenium Trichomanes*, L. Europe, N. Africa, N. and W. Asia  
N. America, S. temp. regions.
- Asplenium viride*, Huds. Europe (Arctic), N. and W. Asia, N  
America.
- Polypodium Robertianum*, Hoffm. Sub-species of *P. Dryopteris*.  
Extends to Thibet. Species 450.
- Aspidium Lonchitis*, Sw. Arctic Europe, N. and W. Asia, Himalaya  
and N. America. Species 55.
- Aspidium angulare*, Kit. Sub-species of *A. aculeatum*.
- Cystopteris fragilis*, Bernh. Arctic, N. and S. temp. regions. Species  
five.
-

## ON DIPLOÏS TRIGONA, N. SP., AND OTHER ROTIFERS.

By CHARLES F. ROUSSELET, F.R.M.S.

(Read September 20th, 1895.)

## PLATES VI., VII.

*Diploïis trigona*, n. sp. (Pl. VI., Fig. 2).

This new loricated Rotifer was found at our Club excursion to Ealing on the 6th April of this year. The shape of the animal is long and narrow, nearly parallel-sided, pointed behind, and higher than broad; the flat ventral plate is separated by a distinct lateral inangulation and is not excavated behind. The lorica is finely stippled, truncate in front with a deep ventral sulcus; behind it is cut off obliquely with a small sulcus on each side. Dorsally it is split down the middle, forming a double dorsal ridge, which may be parallel and close together, or separated and gaping, in the manner of a salpina. The foot is short, three-jointed; the toes, long, narrow, straight and parallel-sided, and finely pointed at the ends, about half as long as the lorica, and often carried turned upwards.

The head protrudes some distance and seems covered with fine thin, hyaline, chitinous plates, of which the dorsal is the stoutest; the whole head can be retracted within the lorica. The brain is a long, rounded hyaline sac, and carries two small red eyes close together on the very front. The dorsal antenna protrudes close above the eyes; the lateral antennæ were not seen. The remainder of the organs are quite normal; the shape of the jaws will best be seen from Fig. 2c.

In placing this animal in this genus I am guided by Mr. Gosse's figure of *Diploïis daviesiæ*. The characters of the genus, however, will have to be amended, especially as it has been established some time ago that Mr. Gosse made a mistake with regard to *D. propatula*, which is a true *Euchlanis*, and has been renamed *Euchlanis subversa* by Mr. D. Bryce (see "Science Gossip," 1890, pp. 77-8).

The specific characters may be summed up as follows:—Lorica

compressed, elongated, and narrow; dorsal cleft narrow, parallel-sided, and open throughout; ventral plate narrow and flat, separated by lateral inangulation; toes long, narrow, of uniform thickness; eyes two, frontal and close together.

Size, total  $\frac{1}{125}$ ; without toes,  $\frac{1}{175}$ ; toes alone,  $\frac{1}{350}$ .

*Microcodides doliaris*, n. sp. (Pl. VII., Fig. 4.)

This is another new Rotifer which has been discovered at one of the Club's excursions to Hertford Heath on the 6th July last.

In appearance it is very stout and plump, with a small head and prone ciliated face. The integument is soft and flexible, the body barrel-shaped, with the usual longitudinal and transverse muscular bands. The mastax is small, and contains jaws with broad sub-square-toothed rami, and broad unci with six or seven teeth and stout manubria (Fig. 4a.). The œsophagus is a thin, long tube, arising near the middle of the dorsal side of the mastax, and leading to the stomach and intestine of usual form. The brain is a stout square mass, carrying a fairly large red eye on its under surface. The dorsal antenna protrudes at the apex of a very obvious dorsal prominence, while the lateral antennæ are situated in the lumbar regions, rather small and difficult to see. The lateral canals with tags are normal; the contractile vesicle is large when fully extended; the ovary is a rounded mass with obvious germ cells.

The foot is peculiar; it is three-jointed, fairly long, the second joint with a distinct bend ventralwards, the third joint a little swollen, and ending in a single, soft, pointed toe; the foot is very flexible, and moves, or rather swings, from one side to the other somewhat like a pendulum. Although the toe is single there are two distinct and well-developed foot glands.

In swimming the animal moves about very leisurely, as if the small ciliary wreath were too weak for the large fat body behind; young specimens are somewhat less plump round the waist. Size, total  $\frac{1}{120}$  in., of which the foot is about one-fourth. A mounted slide of this new Rotifer will be placed in the cabinet of the Club.

In placing this Rotifer in Bergendal's genus *Microcodides* I do so because I really do not exactly know where to put it. Here it will be in company with two other illoricate Rotifers which have the common character of possessing a single toe, but differing in some other important particulars.

After careful consideration I have come to the conclusion that Gunson Thorpe's *Rhinops orbiculodiscus* \* and Bergendal's *Microcodides dubius* † are one and the same species. Unfortunately Surgeon Gunson Thorpe has made some errors in the description and figure of his species, some of which he has already corrected himself. I have often seen this animal of late, and can affirm that it resembles *M. dubius* much more closely than the published figure shows. My animals were identified by Surgeon Gunson Thorpe himself, to whom I sent a mounted slide on board his ship, cruising in Australian waters. The following are the points requiring correction in Gunson Thorpe's description:—First, *Rhinops orbiculodiscus* has a red cervical eye; secondly, the corona consists of a closed outer ciliary wreath, having a second wreath within it, leading to the mouth, which is situated in a depression a little below the centre of the Corona, as fairly well indicated by Bergendal's diagrammatic figure 11; thirdly, it has only one toe; the second toe-like structure is smaller, nearly always carried at right angles to the toe, and better termed a spur; fourthly, the lateral antennæ do not issue from the tip of the projecting lateral points in the lumbar regions of the body, but in the angle between these and the body; fifthly, the animal is not a Rhinops. These corrections in the description of *R. orbiculodiscus* practically effect a complete agreement with *M. dubius*. Adopting Bergendal's generic name the correct designation of this animal will therefore be *Microcodides orbiculodiscus*, and I have placed a mounted slide of it in the cabinet of the Club for reference.

*Microcodides robustus* (Glascott), Pl. VI., Fig. 1.

In her list of some of the Rotifera of Ireland (1892) Miss L. S. Glascott has described, under the name of *Microcodon robustus*, a new one-toed Rotifer, which, unfortunately, cannot be identified from her figures; the description of the animal, however, is much better, and by it I have been able to identify it with a Rotifer I have found in water received in December last from Mr. F. Daunou, of Margate, from his garden tub. I am, therefore, enabled to give a good figure of this pretty Rotifer, which had a few months previously been seen also in Germany by Mr. L. Bilfinger, of Stuttgart.

\* "Journal Royal. Micr., Soc.," 1891, p. 304.

† "Zur Rotatorien Fauna Grönlands," pp. 34-43, 1892.

The integument is smooth, soft, and flexible, but yet possesses a certain stiffness, so that a number of folds behind and along the sides of the body remain constant. In contraction the body is a perfect ball, but the foot is not retractile. The corona is as broad as the body, oblique, and consists, as in *M. orbiculodiscus*, of two concentric bands of cilia (Fig 1b); the outer wreath bends inwards on the frontal side, and seems to be continuous with the smaller inner wreath which surrounds the mouth. The middle part of the trochal disc rises into two elongated fleshy prominences, and between these the mouth is situated at the bottom of a funnel-shaped depression, clothed with very fine and dense cilia. When treated with a little cocaine-spirit mixture many Rotifers often swim for a long time with their heads closely pressed against the cover glass of the compressor, and in this way I obtained very good views of the front of the head, which is otherwise difficult to see. There is a gap in the frontal part of the ciliary wreath, and just there are two style-like setæ which do not vibrate. The brain is a large, rounded, clear cellular mass, carrying a crimson eye with a minute crystalline sphere on the under side; the sphere is turned towards the brain, so that all rays of light reaching it must pass through part of the transparent brain. The dorsal antenna protrudes from a well-marked prominence above the brain, and the lateral antennæ are readily seen in the usual position in a little fold of the skin in the lumbar region. The mastax is large, and the jaws of peculiar form, as will best be seen by the drawing (Fig. 1d and 1e). One maleus only has been drawn, but, of course, there are two of the same shape. A short, narrow œsophagus leads to a wide stomach and intestine, the former carrying the usual gastric glands. The stomach has thick walls, and the cells are mostly granular, which gives it a dark appearance. The contractile vesicle is large; the lateral canals, ovary, longitudinal, and transverse muscular bands are as usual in allied species. The foot is stout, three-jointed, ending in a single toe. With a high power, I was, however, able to see a line dividing the toe longitudinally in a larger ventral and smaller dorsal portion, as if there were present a small vanishing spur, closely appressed to the toe (Fig. 1c). Two foot-glands are present.

When swimming in the open water this Rotifer has usually an upright position and moves forward in frequent little jerks. The movements and mode of swimming are very constant in Rotifers,

and form valuable helps in the identification of obscure species. The little jerks forward, regular and without apparent reason, are very characteristic of this species.

Size  $\frac{1}{140}$ , of which the foot is a little less than one-third.

A mounted slide of this species will also be placed in the cabinet of the Club.

*Diaschiza megalcephala* (Glascott), Pl. VII., Fig. 5.

At the Club's excursion to Totteridge on the 4th of May last I found a Rotifer which I think I can identify with Miss Glascott's *Furcularia megalcephala*. Her description of the animal is good as far as it goes, but her figure is hardly sufficient for recognition.

The most prominent feature of this species is the very large head, which is larger and broader than the body. The body is compressed laterally, higher than broad; the face is very oblique, and the whole front densely ciliated; two bundles of larger cilia or styles are placed on the frontal part of the head. Behind the head the body becomes sensibly narrower, and tapers thence to the short two-jointed foot and toes, which are of moderate size, decurved and finely pointed. The body behind the head seems invested with a very thin and flexible, but distinct, lorica, slit dorsally and open ventrally. The possession of this lorica makes this species a *Diaschiza*, to which genus I therefore transfer it. The mastax is large and peculiar, the rami having the appearance of an angular forceps, and the jaws look as if they could be projected out of the centre of the face with a snap, as stated by Miss Glascott, but this I have not seen done. Having only a single specimen, which I mounted, I have not had an opportunity of dissolving out the jaws and making out all the details of their structure. There is a long tubular brain, but I could detect no eye. The alimentary canal, ovary, and contractile vesicle are all normal. The dorsal and lateral antennæ were not observed, and I neglected to search for them. The whole body of my animal was very white and hyaline, with no food in the stomach, and it may have been a young one, especially as the size was somewhat less than that given by Miss Glascott.

Size, according to Miss Glascott, about  $\frac{1}{130}$ , whilst my animal measured, total  $\frac{1}{162}$ , of which the toes formed about one-sixth.

*Furcularia longiseta*, var. *grandis* (Tessin-Bützow), Pl. VII.,  
Fig. 3.

*Furcularia longiseta* of Ehrenberg, with its long unequal glassy toes, twice to three times as long as the body, is a small Rotifer often met with, crawling, or rather stalking, amongst the water weeds. At our excursion to Hertford Heath, however, I came across a startling variety of this pretty Rotifer. Not only was the size of the animal fully twice as large, measuring  $\frac{1}{60}$  in. in total length, of which the longer toe formed exactly one-half, but it was adorned with two very large red spots in the lumbar regions, exactly where the lateral antennæ should be. The nature of these spots is a mystery, as they can hardly be supposed to have a visual function. A cervical eye situated on the under side of the brain, a little distance from the tip, was present as usual. The colour of the spots resides in two large vesicles, one on each side, apparently attached to the integument; these vesicles are clearly seen in the mounted specimen, though the red colour has disappeared, but I could not detect the lateral antennæ. I observed numerous examples; in some the colour of the spots was a dark crimson, in others a paler red, and in young forms the spots were very minute but distinctly red. The integument is very soft and flexible, and shows numerous close, longitudinal furrows when the animal is extended, but these furrows disappear with the least contraction. The toes are stout at the base, then tapering gradually. Two or three very distinctly striated muscles enter the hollow toes, traverse the wider part, and are attached to the sides where the toe becomes narrower; they do not traverse the whole toe from end to end as depicted by Tessin-Bützow. By means of these muscles the animal is able to make sudden skips forward or sideways out of the way of an enemy. The muscles are of course also present in the smaller species, and were observed by Ehrenberg, although he could not recognize the nature of these bands. With the exception of the large red spots and the size, this animal is exactly the same in structure as the smaller species, and I have adopted as a principle not to make a new species on account of size alone. I find, however, that Dr. G. Tessin-Bützow, in his pamphlet "Rotatorien der Umgegend von Rostock," describes and figures *F. longiseta* as *Monommata longiseta*, and another very similar, but much larger species,  $\frac{1}{60}$  in. long,



under the name of *Monommata grandis*. This animal had not the red spots, but Dr. Bützow figures the lateral antennæ exactly where the red spots are situated in my animal. The red colour of the spots disappeared at once upon treatment with osmic acid, whilst the colour of the cervical eye remained. This leads me to think that the colour of these spots is very unstable, and may sometimes be absent. I have no doubt that the two animals are the same, and as Dr. Tessin-Bützow has given it a specific name I have adopted it as a variety.

The rejected genus *Monommata* was formed by Bartsch for the reception of this and another very dissimilar species—*Notommata tigris*, and Bergendal, in his "Rotatoria of Greenland," strongly advocates the retention of this generic name for *Furcularia longiseta*. The genus *Furcularia* no doubt contains a number of dissimilar animals, some with a frontal eye, some with a cervical eye, and some with no eye at all. This, however, will be a question for the future, and in the present note I will describe my Rotifer by the name by which it is best known.

A mounted slide of both *F. longiseta* and of the var. *grandis* will be deposited in the cabinet of the Club.

*Anuræa cruciformis* (Thompson), Pl. VII., Fig. 6.

In the "Proceedings of the Liverpool Biological Society" for 1892 (p. 77) Mr. J. C. Thompson described this marine Rotifer, which was found in large numbers off the coast of Norway, but without giving a figure. Mr. Thompson has been good enough to send me a mounted slide of the lorica, from which I have made the drawing on Pl. VII., Fig. 6. The lorica is subovate and flat, armed in front with six short, equal, acute, nearly straight spines, and no spines behind, and tessellated so as to show a cruciform marking. The tessellation is formed by one central longitudinal line crossed by two transverse lines, dividing the lorica into six nearly equal parts; a number of smaller tessellations occur at the margin and behind. The shell of the animal, which was preserved in spirit, is thin, white, transparent, and very finely stippled.

Size,  $\frac{1}{130}$  in. by  $\frac{1}{162}$  in. wide; some specimens smaller.

Professor K. M. Levander in his recently published contribution to the Sea and Freshwater Fauna of the neighbourhood of

Helsingfors,\* describes a new Anuræa under the name of *A. eichwaldi*, which seems identical with the above species, but his figure does not show the two transverse lines. These ridges are very low and fine, and probably not readily visible until the shell is empty. Levander gives the size of his animal as  $\cdot 162$  mm. =  $\frac{1}{157}$  in.

EXPLANATION OF PLATES VI. AND VII.

- FIG. 1. *Microcodides robustus*, side view.  
 ,, 1a. ,, ,, dorsal view.  
 ,, 1b. ,, ,, corona, diagrammatical.  
 ,, 1c. ,, ,, the toe, exact shape.  
 ,, 1d. ,, ,, the jaws, front view.  
 ,, 1e. ,, ,, ditto, side view.  
 ,, 2. *Diploïis trigona*, dorsal view.  
 ,, 2a. ,, ,, side view.  
 ,, 2b. ,, ,, transverse section of lorica.  
 ,, 2c. ,, ,, the jaws.  
 ,, 3. *Furcularia longiseta*, var. *grandis*, side view.  
 ,, 3a. ,, ,, ,, dorsal view.  
 ,, 4. *Microcodides doliaris*, side view.  
 ,, 4a. ,, ,, the jaws.  
 ,, 5. *Diaschiza megalocéphala*, side view.  
 ,, 5a. ,, ,, ventral view.  
 ,, 6. *Anuræa cruciformis*.

\* K. M. Levander, "Materialien zur Kenntniss der Wasserfauna in der Umgebung von Helsingfors," "Acta Societatis pro Fauna et Flora Fennica," xii., No. 3, pp. 1-72, 3 Pl. Helsingfors, 1894 (published July, 1895).

A PRELIMINARY ACCOUNT OF THE ENTOMOSTRACA OF NORTH WALES.

By D. J. SCOURFIELD.

(Read September 20th, 1895.)

PLATE VIII.\*

The following list of fresh and brackish water Entomostraca is based mainly upon the results of a personal examination of some of the lakes, etc., of North Wales, principally in the Snowdon and Cader Idris districts, made during two short visits at the end of July and beginning of August last year and at the end of May and beginning of June of the present year. I have been enabled, however, to considerably increase the number of species recorded, through the kindness of Prof. G. S. Brady, F.R.S., who generously placed at my disposal several preserved collections obtained in 1888 and 1891, for which, and also for valuable assistance in connection with the identification of doubtful species, I wish to express my sincerest thanks. A few further species have been added on the authority of records in Prof. Brady's "Monograph of British Copepoda" and "Revision of the British Species of Freshwater Cyclopidæ and Calanidæ."

CLADOCERA.

**Sida crystallina**, O. F. Müller. This does not seem to be a very abundant species in North Wales. I only have notes of its occurrence in Llyn Ogwen, † Llyn Cwm-ffynnon, Llyn Creigenen, and Llyn Gwernan. In each of these it was obtained by working the net among clumps of horse-tails and other aquatic vegetation.

**Daphnella brachyura**, Liévin. (*D. Wingii*, Baird, "Nat. Hist. Brit. Ent.") Llyn Padarn, Llyn Peris, Llyn Cwm-ffynnon, and Bala Lake are the only places where this species has been found.

\* Plate VIII. is unavoidably held over for the next number.—ED.

† The lakes, etc., referred to throughout this paper can be identified by a reference to Baddeley and Ward's "North Wales." (Thorough Guide Series. Dulau and Co.).

It occurred in parts of Llyn Peris in August, 1894, in great abundance, and almost to the exclusion of everything else.

**Latona setifera**, O. F. Müller. Only seen from Llyn Padarn, where it was obtained in August, 1894, by bringing up sediment from the bottom of the lake at some distance from the shore.

This fine species (one of my specimens was  $\frac{1}{8}$  in. in length and most beautifully coloured) was first added to the British fauna by Mr. Conrad Beck, who found it in the Lake District in 1881. More recently Mr. T. Scott has reported its occurrence in Loch Morar, Inverness-shire. These are the only British records known to me.

**Ceriodaphnia pulchella**, G. O. Sars. (Plate VIII., Figs. 1 and 2.) The form here referred to is extremely close to that recorded by me as *C. quadrangula*, Müller (see the previous volume of this Journal, p. 65, Pl. IV., Figs. 4-7). It differs from that species, however, in that the post-abdomen lacks the two short inner rows of pre-anal spines. The head, too, is somewhat smaller than in the "quadrangula" form, and does not project so far ventrally, while the forehead in front of the antennules is produced into a more noticeable angle. Altogether, it seems to agree very well with Sars's *C. pulchella*, and that name has, therefore, been adopted. The following are the localities where it has been found: Reservoir-Pennaenmawr (G. S. B.),\* Llyn Cwm-ffynnon, Llyn Ogwen, Llyn Teyrn, and marsh near Barmouth Junction.

**Ceriodaphnia reticulata**, Jurine. (*Daphnia reticulata*, Baird, "Nat. Hist. Brit. Ent.") Only recorded from the marsh near Barmouth Junction.

**Simocephalus vetulus**, O. F. Müller. (*Daphnia vetula*, Baird, "Nat. Hist. Brit. Ent.") All the specimens of *Simocephalus* have been of the typical "vetulus" type. They have only occurred in marshes, ditches, and small tarns.

**Daphnia longispina**, O. F. Müller. Llyn Padarn is the only lake that has yielded this species in any abundance, but it has been seen in several other localities, including Bala Lake.

**Daphnia hyalina**, Leydig. Limited to Llyn Padarn so far as yet observed.

**Bosmina longispina**, Leydig. This large species is in a certain sense a characteristic of the North Welsh Entomostracan fauna, at least as contrasted with that of our south-eastern portion of

\* The records marked (G. S. B.) refer to Prof. Brady's collections.

England,\* for it occurs plentifully, and apparently to the complete exclusion of *B. longirostris*, which is the typical representative of the genus in the latter district.

**Acantholeberis curvirostris**, O. F. Müller. I have only seen this in a collection from Arthog Marsh (G. S. B.).

**Drepanothrix dentata**, Eurén. Two localities have yielded this peculiar species, viz., a tarn near the summit of Allt Wen (G. S. B.) and Llyn Padarn.

**Eurycercus lamellatus**, O. F. Müller. A fairly common species, but not usually found in the larger lakes.

**Acroperus harpæ**, Baird. Not very common, the rôle it plays in the south-eastern part of England being partly undertaken perhaps by *Alonopsis elongata*.

**Camptocercus macrurus**, O. F. Müller. The few examples seen were from Llyn Padarn. They were of the type called "rectirostris" by Schoedler, which is probably the common British form, for the drawings given by Baird and also by Norman and Brady seem to indicate this variety, and, so far as I can remember, it is the only one I have ever taken.

**Alonopsis elongata**, G. O. Sars. (*Lynceus elongatus*, Norman and Brady, "Mon. Brit. Ent.") This is one of the most abundant and most widely distributed of the Cladocera of North Wales, but it was not found either in Llyn Padarn or in Bala Lake. Most of the specimens seen were of a very dark colour, some, indeed being almost black.

**Leydigia acanthocercoides**, Fischer. Only one locality has yielded this species, viz., a tarn near the summit of Allt Wen (G. S. B.). The specific name *acanthocercoides* has been retained because it is believed that Fischer's species is the same as Leydig's *Alona quadrangularis*. If there is a genuine difference between the two, as asserted by some authors, then there is no doubt that the present, which is the common British form, should be called *L. quadrangularis*, Leydig.

**Alona quadrangularis**, O. F. Müller. Examples of this species have only been obtained from a "pool above high-water mark" east of Penmaenmawr (G. S. B.).

**Alona affinis**, Leydig. This species, which is probably the same as P. E. Müller's *A. oblonga*, has been noted in company

\* By this phrase is intended the whole district lying to the east of a line drawn from The Wash to the Isle of Wight.

with the foregoing and also from Conway Marsh (G. S. B.), Llyn Padarn, and Llyn Creigenen. As it has not previously been recorded as British, it may be useful to give a few of the details by which it can be distinguished from *A. quadrangularis*, the species to which it is most nearly related. In the first place, it is a somewhat larger animal, measuring  $\frac{1}{30}$ - $\frac{1}{25}$  in., while *A. quadrangularis* rarely reaches  $\frac{1}{30}$  in. Another difference is that it possesses, in addition to the coarser lines on the shell, a series of closely-set longitudinal striae, which, although very variable in intensity, are always extremely fine and difficult of detection, except with high magnification. The arrangement of the olfactory hairs on each Antennule is a further point of distinction, for while *A. affinis* has one of these hairs much longer than the others, and also one inserted a little farther back than the rest, in *A. quadrangularis* all these hairs are sub-equal and all are inserted on the end of the Antennule. Again, in *A. affinis* each of the two longest setæ on each branch of the swimming Antennæ is provided with a little thorn at the point where it is imperfectly jointed. These thorns are absent in *A. quadrangularis*. Lastly, each of the terminal claws, with its accessory basal tooth, is much more plainly setose in the present species than in *A. quadrangularis*.

**Alona guttata**, G. O. Sars. This little species has only been seen from Cwm Glas, Snowdon. It was there found inhabiting some masses of wet alga in company with *Canthocamptus pygmaeus* and *C. MacAndrewæ*.

**Alona intermedia**, G. O. Sars. Only recorded from Llyn Peris, where it was found in some alga taken from among clumps of horse-tails.

**Alonella excisa**, Fischer. I found this in several localities in May last, and it also occurs in three of Prof. Brady's collections, but I did not notice it in 1894. The living specimens seen by me were usually much darker than I find them here.

**Alonella nana**, Baird. (*Acroperus nanus*, Baird, "Nat. Hist. Brit. Ent.") "Tarn near the summit of Allt Wen" (G. S. B.) is the only place where this has been found.

**Pleuroxus trigonellus**, O. F. Müller. This also depends on a single record, viz., one from Llyn Padarn in August, 1894.

**Peracantha truncata**, O. F. Müller. A fairly common species. Very dark-coloured examples were taken in several of the lakes.

**Chydorus sphericus**, O. F. Müller. In North Wales, as in most other parts of the British Isles, this is probably the commonest of all the forms of Cladocera.

**Chydorus cælatus**, Schoedler. Seen only in two localities, viz., Llyn Padarn and Llyn Dwythweh.

This species was first recorded as British by Prof. G. S. Braly, in 1868, in the "Intellectual Observer," Vol. xii., p. 423, under the name of *Lynceus sphericus*, var. *fuosa*. It does not appear to have been subsequently noted, and has most probably been mistaken for the common *C. sphericus*. It is easily distinguished from the latter, however, by its shell sculpture, which consists of rows of deep pits (most plainly developed on the ventral and posterior portions of the valves) unaccompanied by any evident reticulation. The valves of typical *C. sphericus*, on the other hand, are never pitted, but always reticulated. In other respects the present form is extremely close to *C. sphericus*.

**Chydorus latus**, G. O. Sars. This is the same as recorded by me in 1892 as *C. ovalis*, Kurz. ("J. Q. M. C.," Ser. II., Vol. v., p. 68). I now think that this form agrees better with *C. latus* than *C. ovalis*, and I have, therefore, adopted the former name. The two species, however, seem to be very closely allied, and have even been considered identical, as by Hellich, for example. The records for this species have been Llyn y Cwn, Llyn Teyrn, and Bog near Llyn Peris. All the specimens seen were rather smaller than those recorded from Leytonstone in the above-mentioned paper.

**Polyphemus pediculus**, De Geer. During August, 1894, this species occurred pretty frequently in the Snowdon district, but I saw very few specimens in May last.

**Bythotrephes longimanus**, Leydig (*B. Cederströmi*, Beck—"Some New Cladocera," &c.) Recorded only from Llyn Padarn and Llyn Peris. It no doubt lives in many of the larger and deeper lakes, but owing to its exclusively pelagic habits it is not easily captured without the aid of a boat.

**Leptodora hyalina**, Lilljeborg. Like the foregoing, this species is difficult to capture from the shore, but I managed to get it in this way in Llyn Llydaw. The other localities where it has been noted are Llyn Padarn, Llyn Peris, and Bala Lake.

## OSTRACODA.\*

**Cypria ophthalmica**, Jurine. Only seen from Arthog Marsh (G. S. B.), Bala Lake, and Llyn Padarn.

**Cypria serena**, Koch. Apparently the commonest of the Ostracoda of North Wales. For all that, however, it is not particularly abundant, as it has only been seen in seven localities. Some of the specimens were exceptionally dark-coloured.

**Cypris obliqua**, G. S. Brady. Llyn Cwm-ffynnon and Barmouth Junction Marsh are the only places where this has been obtained.

**Cypris prasina**, Fischer. As a species having a decided preference for water with a trace of salt in it, this finds a congenial home in the Marsh near Barmouth Junction, and there it occurred plentifully in May last. It has not, however, been noted in any of the other brackish water collections.

**Herpetocypris reptans**, Baird. Recorded only from Conway Marsh (G. S. B.).

**Cypridopsis vidua**, O. F. Müller. This was found in the marsh below Llyn Padarn and also in the portion of the same lake which is cut off by the railway embankment.

**Cypridopsis aculeata**, Lilljeborg. A brackish water species, and found consequently in such places as Arthog Marsh (G. S. B.), pools near high-water, Llanfairfechan (G. S. B.), and Barmouth Junction Marsh.

**Notodromas monacha**, O. F. Müller. This was pretty abundant in the marsh and ditches near Barmouth Junction last May, and it also occurs in a gathering made by my friend, Mr. Soar, in July, from Llyn y Gader, Cader Idris.

**Limnocythere inopinata**, Baird. Pools above high-water, Llanfairfechan (G. S. B.).

**Cytheridea torosa**, Jones. Brackish pond, Pwllheli (G. S. B.).

In addition to the above a single, probably immature, specimen of a *Candona* was taken among alga, etc., near Llangollen, but the species is uncertain.

\* The nomenclature of this Order is in accordance with Brady and Norman's "Monograph of the Ostracoda of the N. Atlantic and N.W. Europe."



## COPEPODA.\*

**Eurytemora Clausii**, Hoek. Seen from one locality only, viz., Brackish pond, Pensarn, Merionethshire (G. S. B.).

**Diaptomus gracilis**, G. O. Sars. This is an extremely common form, and often occurs in enormous numbers. As a rule, according to my observations, specimens inhabiting the more elevated lakes (say 800 feet and upwards) are of a brilliant red colour, while those in the lower lakes are not abnormally coloured. Males with and males without a process on the antepenultimate joint of the right first antenna have been seen, but the former seem to be more abundant than the latter.

**Diaptomus hircus**, G. S. Brady. Presumably a rare species, specimens having been taken only from Llyn Padarn and possibly a few also from Llyn Idwal. Those from the latter lake were immature and could not be quite certainly identified.

**Cyclops fuscus**, Jurine. (*C. signatus*, Koch). Only recorded from the following localities: Llyn yr Afon (G. S. B.), pool above high-water east of Penmaenmawr (G. S. B.), Llyn y Cwn, Llyn Ogwen, and marsh at southern end of Llyn Cynwch, Dolgelly.

**Cyclops albidus**, Jurine. (*C. tenuicornis*, Claus.). Conway Marsh (G. S. B.), Llyn Padarn, Llyn Peris, and Llyn Dwythwch.

**Cyclops oithonoides**, G. O. Sars (*C. Scourfieldi*, var., G. S. Brady). Found only in marsh ditches near Cwm y Glo.

**Cyclops strenuus**, Fischer. This species is more capable of being "pelagic" in its habits than almost any other of the genus, and may be found, as in Llyn Padarn, in company with such forms as *Bythotrephes longimanus* and *Leptodora hyalina*. On the other hand, it may often be found in the smallest of pools. Corresponding to this diversity of habitat is its remarkable variation, which has led to the formation of several so-called species, e.g., *C. vicinus*, *C. abyssorum*, etc. In the present state of our knowledge, however, these cannot be considered as good species, scarcely even as permanent varieties, and it seems best, therefore, to group all these forms under the one name, *C. strenuus*, as is done by several recent writers, e.g., Schmeil, Richard, Mrázek, etc.

\* As far as possible the nomenclature used in Schmeil's "Deutschlands freilebende Süßwasser-Copepoden" has been adopted.

In North Wales this is a moderately common species in the mountain lakes and tarns.

**Cyclops viridis**, Jurine. All the examples seen, representing nine localities, were of the "gigas" type.

**Cyclops vernalis**, Fischer. With the exception of the mere mention of the name in this Journal among the lists of objects found at the excursions of the Club during 1894 (*ante*, p. 74), this species has not been previously recorded as British. It is, however, a fairly common species, but has hitherto been included under the comprehensive name of *C. bicuspidatus*. In North Wales it has been seen from five different localities.

**Cyclops bisetosus**, Rehberg (*C. bicuspidatus*, Brady, "Rev. Brit. Species of Cyclopidae and Calanidae"). This has only been recorded from a bog pool on Y Garn and from the margin of Bala Lake.

**Cyclops bicuspidatus**, Claus, var. **Lubbockii**, G. S. Brady (*C. insignis*, Brady, "Mon. Brit. Copepoda," and "Rev. Brit. Sp. Cyclopidae and Calanidae"). There can be no doubt that the *Cyclops* referred by Prof. Brady to *C. insignis*, Claus, is not really that species, but the variety of *C. bicuspidatus* (= *C. Thomasi*, Herrick), described by Rehberg as *C. helgolandicus* and by Schmankewitsch as *C. odessanus*. As, however, Prof. Brady had, as early as 1868, described the form under review as *C. Lubbockii* ("On the Crustacean Fauna of the Salt Marshes of Northumberland and Durham," in "Nat. Hist. Trans., North. and Dur.," Vol. iii.), it seems only right to use this name for the variety, instead of that of either Rehberg or Schmankewitsch. The importance of having a recognised varietal name in this instance depends upon the fact that the variety is exclusively a brackish water form, while the typical *bicuspidatus* is exclusively an inhabitant of fresh water.

The following are the places where this variety has been found in North Wales:—Brackish pond, Pwllheli (G. S. B.); brackish pond, Pensarn (G. S. B.), and the marsh near Barnouth Junction.

**Cyclops languidus**, G. O. Sars. This has only been previously noticed as British in lists of objects found at excursions given in the previous volume of this Journal, pp. 398 and 400. It has now been seen from a bog by side of Llyn Teyrn, and from Llyn y Gader, Cader Idris.

**Cyclops bicolor**, G. O. Sars. (*C. diaphanus*, Scourfield, "J. Q. M. C.," Vol. v., p. 407). Like the preceding this has only

previously been recorded as British in the lists given in the last volume of the Club's Journal.

The marsh below Llyn Padarn and the portion of the same lake cut off by the railway embankment are the only places where it has been obtained.

**Cyclops serrulatus**, Fischer. Undoubtedly the commonest Copepod of North Wales. It seems rarely to be absent from any piece of water whatever, whether large or small, high or low, brackish or fresh. In the case of Llyn du'r Arddu, Snowdon, it was the only species of Entomostraca that could be found after most diligent search.

**Cyclops affinis**, G. O. Sars. Only seen from the side portion of Llyn Padarn already referred to.

**Cyclops fimbriatus**, Fischer. Recorded in Prof. Brady's "Revision, etc.," from pools near high water, Penmaenmawr. No other record.

**Cyclops æquoreus**, Fischer. This is essentially a brackish water species. It has only been seen from brackish pools at Pensarn (G. S. B.) and Pwllheli (G. S. B.).

**Tachidius brevicornis**, O. F. Müller. This is another exclusively brackish water species. Brackish pond, Pensarn (G. S. B.), is the only record.

**Canthocamptus staphylinus**, Jurine. (*C. minutus*, Baird, Brady, etc.) Curiously enough this, which is usually considered to be a very common form, has only been seen in North Wales from the margin of Bala Lake.

**Canthocamptus minutus**, Claus. (Not *C. minutus*, Müller). Like the preceding this was taken from the margin of Bala Lake, and nowhere else.

My friend Mr. T. Scott, F.L.S., has quite recently announced the discovery of this little species in Scotland—"Annals of Scottish Nat. Hist.," July, 1895, p. 173)—otherwise it has not previously been placed on record as British.

**Canthocamptus hirticornis**, T. Scott. Full details of this new species will be published by Mr. Scott in the Annual Report of the Fishery Board for Scotland for the current year. In North Wales it was obtained from the marsh near Barmouth Junction. This does not necessarily indicate that it is a truly brackish water species, and Mr. Scott informs me that in nearly all the localities where he has found it (in Barra, North Uist, Shetland,

etc.) the water has been fresh. Nevertheless it is a noticeable fact that it has not yet been found far from the sea.

My specimens seemed to lack the "down" of fine setæ on the first and second joints of the first pair of antennæ, otherwise they agreed very well indeed with the original figures, proofs of which have been kindly sent to me by Mr. Scott.

**Canthocamptus crassus**, G. O. Sars. (*Attheyella spinosa*, Brady). Mentioned in the Monograph of British Copepoda as being found in the river a little west of Pwllheli.

**Canthocamptus pygmæus**, G. O. Sars. (*Attheyella cryptorum*, Brady). In wet mosses and bogs this is almost constantly present, though I have not often seen it in great numbers. It has also been recorded from the margins of several of the larger lakes.

**Canthocamptus MacAndrewæ**, T. and A. Scott. (*Attheyella MacAndrewæ*, T. and A. Scott, "Annals and Magazine of Nat. Hist.," Ser. VI., Vol. xv., June, 1895, p. 457). A few examples of this quite newly described species were found in wet alga from Cwm Glas, Snowdon.

**Mesochra Lilljeborgii**, Boeck. Brackish pond, Pensarn (G. S. B.).

**Laophonte Mohammed**, Blanchard and Richard. (Plate VIII., Figs. 3-9). Prof. Brady, who very kindly identified this species for me, says that it does not seem to have been met with since first described by MM. Blanchard and Richard from certain Salt Lakes in Algeria. ("Mém. Soc. Zool. France," Vol. iv., 1891, p. 526, Pl. VI., Figs. 1-15).

At the time of its description it was the only known brackish water species of the genus, but in 1893 a second brackish water species, *L. littorale*, was described by Messrs. T. and A. Scott from several localities in Scotland. ("On some New and Rare Crustacea from Scotland," "Annals and Magazine of Nat. Hist.," Ser. VI., Vol. xii., p. 238). All the other species are exclusively marine, except that, very rarely, *L. similis* has been taken in estuarine pools.

The figures given on the accompanying Plate will, I think, be sufficient to enable anyone to recognise this species without the aid of a long description. The lengths of my specimens were, ♀  $\frac{1}{38}$  in., ♂  $\frac{1}{45}$  in.

**Dactylopus tisboides**, Claus. This, although typically a marine species, is sometimes found in brackish water, when it

varies slightly from the marine form, as noticed by Prof. Brady in his Monograph of British Copepoda. Recorded only from pools near high water, Llanfairfechan (G. S. B.).

The foregoing list shows that up to the present the total number of Entomostraca recorded from North Wales has been 67, made up as follows :—Cladocera, 30 ; Ostracoda, 10 (of which three are brackish water forms) ; and Copepoda, 27 (of which seven are brackish). Considering the very moderate amount of work that has as yet been done, these figures, at least as regards the Cladocera and Copepoda, must, I think, be considered as satisfactory. The comparative smallness of the list of Ostracoda is no doubt somewhat surprising, but I am inclined to think that it corresponds to a real deficiency in the number of these animals actually living in the district.

The list also shows a more than usually large proportion of species which may reasonably be considered either as rare or specially interesting. Two of the Cladocera, *Ceriodaphnia pulchella* and *Alona affinis*, and one of the Copepods, *Laophonte Mohammed*, are new to the British fauna, while there are quite a number of species, e.g., *Latona setifera*, *Acantholeberis curvirostris*, *Drepanothrix dentata*, *Chydorus latus*, *C. cœlatus*, *Bythotrephes longimanus*, *Diaptomus hircus*, *Cyclops languidus*, *C. bicolor*, *Canthocamptus minutus*, Claus, *C. MacAndrewæ*, and *C. hirticornis*, which have at most only been recorded a few times in the British Isles.

It is certainly premature to make any serious attempt to compare the Entomostracan faunas of different districts of the United Kingdom, but in looking over this record from North Wales, I cannot help noticing a few points in which it differs from that of the district with which we are most familiar, viz., the South-east of England. Among the Cladocera, some eight species appear in the present list, i.e., more than one-fourth of the whole, that have never been seen, so far as I am aware, in this part of the country. These are *Latona setifera*, *Ceriodaphnia pulchella*, *Bosmina longispina*, *Acantholeberis curvirostris*, *Drepanothrix dentata*, *Alonopsis elongata*, *Bythotrephes longimanus*, and *Leptodora hyalina*. On the other

hand we have many forms living here which do not figure in the Welsh list, but of course it would be very unwise, looking to the large amount of collecting that has been done here compared with North Wales, to put these forward as evidence of the difference between the two faunas. Nevertheless one cannot help being struck by the fact that such familiar species to us as *Daphnia pulex*, *Bosmina longirostris*, etc., should be conspicuous only by their absence from the records from North Wales. It is also very strange, by the way, that the list of Cladocera should contain no representative of the so-called Hyalodaphnias, e.g., *Daphnia kahlbergensis*, etc. Of all places in the United Kingdom where I should have thought it perfectly safe to predict the occurrence of these typically "pelagic" creatures, it would have been the lakes of North Wales. The list of Ostracoda shows no peculiar forms, as every one of the species given has also been found in this part of the country. Of Copepoda, however, the present record contains three species that are characteristic so far as the present comparison is concerned, viz.: *Diaptomus hircus*, *Canthocamptus MacAndrewæ*, and *Canthocamptus hirticornis*. The essentially brackish water species have been left out of account, as I do not think they have been properly worked on our coasts. It may further be interesting to note that not a single characteristic species of Cyclops has been recorded.

I should have liked to have given some details as to the characteristic Entomostracan faunas of the larger lakes, of the high mountain tarns, of bog-pools, of mosses and algæ, etc., but my records from individual localities are necessarily for the most part so meagre that it is useless to attempt anything of the kind at present. The most that can be done will be to give an account of the fauna of the Llanberis Lakes, Llyn Padarn and Llyn Peris, which have been more worked than any of the others. They may probably be taken as typical examples of the larger Welsh Lakes, and, as they are so intimately connected, it will be quite good enough for present purposes to consider them together. I will attempt to classify the species according to whether they were found to belong to the "pelagic," "littoral," or "bottom" fauna. The phrase "bottom" fauna, it should be explained, includes those species collected from the bottom of the lakes at some distance from the shore, in depths varying from 25 to 100 feet, or thereabouts.

## ENTOMOSTRACAN FAUNA OF LLYN PADARN AND LLYN PERIS.

## PELAGIC FAUNA.

## CLADOCERA.

- Daphnella brachyura.*  
*Daphnia longispina.*  
 „ *hyalina.*  
*Bosmina longispina.*  
*Polyphemus pediculus.*  
*Bythotrephes longimanus.*  
*Leptodora hyalina.*

## OSTRACODA.

*Nil.*

## COPEPODA.

- Diaptomus gracilis.*  
 „ *hircus.*  
*Cyclops strenuus.*

## LITTORAL FAUNA.

## CLADOCERA.

- Eurycercus lamellatus.*  
*Acroperus harpœ.*  
*Alonopsis elongata.*  
*Alona intermedia.*  
*Alonella excisa.*  
*Pleuroxus trigonellus.*  
*Peracantha truncata.*  
*Chydorus sphericus.*  
 „ *calatus.*

## OSTRACODA.

- Cypria ophthalmica.*  
 „ *serena.*  
*Cypridopsis vidua.*

## COPEPODA.

- Cyclops albidus.*  
 „ *viridis (gigas).*  
 „ *bicolor.*  
 „ *serrulatus.*  
 „ *affinis.*  
*Canthocamptus pygmaeus.*

## BOTTOM FAUNA.

## CLADOCERA.

- Latona setifera.*  
*Drepanothrix dentata.*  
*Camptocercus macrurus.*  
*Alona affinis.*  
*Chydorus sphericus* (also  
 littoral).

## OSTRACODA.

*Cypria serena* (also littoral).

## COPEPODA.

- Cyclops serrulatus* (also lit-  
 toral).  
*Canthocamptus pygmaeus* (also  
 littoral).

It will be seen from the above, that these two lakes alone have yielded practically half of the recorded species, viz. 32 out of 67, and no doubt this falls considerably short of the number of species actually living in them.

I do not think my records and observations justify any further remarks directly dealing with the Entomostraca of North Wales, but before concluding I would like to say a few words on two points having an important, if indirect, bearing upon the subject in hand, viz., the general character of the lakes, and the methods of collecting.

As regards the first point, the most noticeable feature is that the lakes of North Wales are remarkably uniform in type, and in complete contrast to all those of this South-eastern part of England. They are almost without exception collections of the clearest and purest water, lodged in rocky basins of considerable depth, and surrounded by stony margins, which may, however, be more or less obscured by peat and bog-moss. They are, moreover, practically free from macro-vegetation. Micro-plants, especially free-swimming algæ, are probably not less common in the lakes of North Wales than they are here, but the luxuriant masses of *Myriophyllum*, *Elodea*, *Starwort*, *Duckweed*, etc., found in the majority of our lakes and ponds are quite without parallel there so far as my experience goes. Many of the lakes are absolutely destitute of any visible vegetation, except perhaps some bog-mosses or a rather weak growth of filamentous alga on the stones near the margin, and where higher forms of plant life do occur they are generally limited to horse-tails (*Equisetum*), *Lobelia* (*L. Dortmanna*), or more rarely buck-bean (*Menyanthes trifoliata*). Probably in the depths of many lakes members of the Characeæ flourish, but the only direct evidence I have of this is that I obtained a species of *Nitella* pretty plentifully from several parts of the bottom of Llyn Padarn.

Such being the general features of the lakes and their vegetation, it could not be expected that the littoral fauna, which in all branches of pond-life includes the bulk of the species, should be a very rich one, and this accounts, no doubt, for the absence of many of what are to us the commonest species. On the other hand, the lakes seem eminently suited to the pelagic forms, and these, as regards the Entomostraca, have already been shown to be well represented,\* for although the number of species recorded (10 or 11)

\* This is probably true also of the Rotifera. I have repeatedly found *Conochilus unicornis* in the lakes of North Wales, and *Asplanchna priodonta*, *Notholea longispina*, *Anuraea aculeata*, etc., have also been seen.



does not sound very formidable, it must be remembered that from the point of view of individuals these forms far outweigh all the others put together. It is the capture of these pelagic animals, too, which constitutes the chief peculiarity of "pond-hunting" in North Wales, and this leads to the consideration of the second point I wish to mention. It is quite useless to think that, with a net attached to a stick, worked by hand from the shore, any idea of the pelagic fauna of a lake can be obtained. The only really reliable method of getting the creatures belonging to this group is by the use of a boat. From this the net can be used not only at the surface, but by means of a line and plummet can also be lowered to various depths, or dragged along the bottom. It is absolutely necessary to be able to use the net in these various ways, for it often happens that while the surface is almost devoid of life, a rich collection of pelagic forms may be secured at a considerable depth. But boats are only to be had on a few lakes, and if we want to study the pelagic fauna in the others some different means of collection must be adopted.

Under favourable conditions some specimens of this fauna can usually be obtained by the simple means of attaching the net to a line and throwing it out as far as possible. Of course the net must be weighted in some way, and I found it a good plan to substitute for the usual glass tube at the end of the net a small cylindrical tin into which some molten lead had been run. With the majority of the higher lakes this method of throwing out the net is perhaps the only one open to a person who, like myself, simply does his collecting incidentally during a holiday. In North Wales, however, I found a most fatal objection to this method to be that, very commonly, even in lakes known to be of considerable depth, there was a margin of comparatively shallow water, extending well beyond the point to which the net could be thrown, and thus effectually preventing the examination of the deeper water. Several more complicated methods of collecting, by means of floats, etc., have been proposed for this kind of work, and have, I believe, proved fairly successful. At some future time I hope to be able to give some of these a trial, at least in the more accessible lakes. In the meantime if anyone interested should be willing to continue this subject of the Entomostraca of North Wales, in any of its branches, I shall be only too glad to do anything I can to help in the work.

Books and papers (British only, as far as possible) containing figures and descriptions of the species recorded.

BAIRD, W.—“The Nat. Hist. of the British Entomostraca.”—*Ray Society*, 1850.

BECK, C.—“On some new Cladocera of the English Lakes.”—*Journ. Royal Micro. Soc.*, Ser. II., Vol. iii., 1883, p. 777.

BLANCHARD, R., AND RICHARD, J.—“Faune des lacs salés d'Algérie, Cladocères et Copépodes.”—*Mémoires de la Société Zoologique de France*, Vol. iv., 1891, p. 512.

BRADY, G. S.—“Monograph of Recent British Ostracoda.”—*Trans. Linnean Soc.*, Vol. xxvi., 1868, p. 353.

BRADY, G. S.—“Monograph of British Copepoda.”—*Ray Society*, 1878-1880.

BRADY, G. S.—“Revision of the British Species of Fresh-water Cyclopidae and Calanidae.”—*Nat. Hist. Trans. of Northumberland, etc.*, Vol. xi., 1891, p. 68.

BRADY, G. S., AND NORMAN, A. M.—“Monograph of the Marine and Fresh-water Ostracoda of the North Atlantic and of North Western Europe.”—*Scientific Trans. of the Royal Dublin Society*, Ser. II., Vol. iv., 1889, p. 63.

FORREST, H. E.—“On the Anatomy of *Leptodora hyalina*.”—*Journ. Roy. Micro. Soc.*, 1879, p. 825.

NORMAN, A. M., AND BRADY, G. S.—“Monograph of the British Entomostraca belonging to the families Bosminidae, Macrothricidae, and Lynceidae.”—*Nat. Hist. Trans. of Northumberland and Durham*, Vol. i., 1865-7, p. 354.

SCHMEIL, O.—“Deutschlands freilebende Süßwasser-Copepoden.”—*Leuckart and Chun's Bibliotheka Zoologica*, Heft xi., 1892 (Cyclopidae), and Heft xv., 1893 (Harpacticidae).

SCOTT, T.—“The Invertebrate Fauna of the Inland Waters of Scotland,” Part V.—*Annual Report of the Fishery Board for Scotland*, 1895, Part III.

SCOTT, T. AND A.—“On some new and rare Crustacea from Scotland.”—*Annals and Magazine of Nat. Hist.*, Series VI., Vol. xv., 1895, p. 457.

SCOURFIELD, D. J.—“Some new records of British Cladocera.”—*Journal Quekett Micro. Club*, Ser. II., Vol. v., 1892, p. 63.

## EXPLANATION OF PLATE VIII.

- FIG. 1. *Ceriodaphnia pulchella*, ♀ × 80.  
 „ 2. „ „ Post-abdomen, ♀.  
 „ 3. *Laophonte Mohammed*, Antenna of 1st pair, ♀.  
 „ 4. „ „ „ „ „ ♂.  
 „ 5. „ „ Accessory branch of Antenna  
 of 2nd pair.  
 „ 6. „ „ Foot of 1st pair.  
 „ 7. „ „ Foot of 5th pair, ♀.  
 „ 8. „ „ „ „ „ ♂.  
 „ 9. „ „ End of abdomen and Furca,  
 ventral side, ♀, × 240.
-

## NOTE ON FINE MARKINGS ON NAVICULA MAJOR.

By EDWARD M. NELSON, F.R.M.S.

*(Read March 15th, 1895.)*

About twenty years ago I discovered two narrow bands of so-called striæ on the hoop of this diatom, and curiously these were noticed before they were resolved by perceiving their blue sheen, when the diatom was examined on a dark ground with an objective whose aperture was insufficient to resolve it into striæ.

At that time Messrs. Powell and Lealand had just brought out (December, 1874) their new formula water immersion  $\frac{1}{8}$ , and when that lens was tried on this test the so-called striæ were readily seen; subsequently they were resolved with a P. and L. dry  $\frac{1}{4}$  of  $90^\circ$ ; the diatom was then kept for many years as a test for lenses of about that aperture; afterwards the diatom yielded to the same  $\frac{1}{4}$  with central, and to a P. and L.  $\frac{4}{10}$  of  $80^\circ$ , with oblique light.

Coming to more recent times, Zeiss' apo.  $\frac{1}{2}$  of  $\cdot 65$  N.A. resolves it with a  $\frac{5}{8}$  cone of central light. These striæ will be found to be fairly constant at 60,000 per inch; they therefore resemble the so-called transverse striæ on a Cherryfield Rhomboides. Arguing by analogy we may conclude that these striæ are composed of rows of closely adjacent minute apertures; therefore for some time past this diatom has been examined with a view to the resolution of these smaller details when any new instrumental improvement appeared.

When the fluorite condenser was fitted with a correctional collar, this object was the first it was tried upon, and after a little perseverance the structure was at last fully resolved by the Zeiss apo.  $\frac{1}{8}$  of  $1\cdot 4$  N.A., using a  $\frac{5}{4}$  cone of central light.

You will notice that this diatom affords an exceedingly good test, because there is no raphæ present to yield false ghosts, and also a marked difference will be observed between this and other similar diatomic structures, inasmuch as the minute apertures are not in rows,\* so there are no so-called longitudinal striæ. On this

\* A rough sketch will be found in the "R.M.S. Journal" for 1895, page 231. (Notice the square appearance of the holes.)

account oblique light fails ; it is, therefore, exclusively a central light test, and one of the best, for the minute points form a test for the widest angled objectives of a modern microscope in its highest development, and the transverse striæ one for that most useful lens, the Zeiss apo.  $\frac{1}{2}$  N.A. .65, as well as one for cheap semi-apochromatic quarters on second-class instruments, central light being employed in both cases.

This diatom can be readily procured, as it is common in "Sozodont" tooth powder ; it should be mounted in quinidine, and Mr. Gifford's latest F line screen should be used.

NOTE ON SOME RECENT OBSERVATIONS OF THE FOOT OF THE  
HOUSE-FLY.

By A. C. E. MERLIN.

(Read April 19th, 1895.)

Since finding that the hairs of the *Pulvillus* of the house-fly's foot are terminated by a delicate scythe or sickle-shaped filament, and not by a knob or sucker as hitherto supposed, it occurred to me that it would be interesting to endeavour to confirm the existing theory that the hairs in question are the real agents by which flies attach themselves to and walk upon smooth glass surfaces.

For this purpose I imprisoned a fly in a Rousselet live box, leaving the insect plenty of room to walk over the large cover glass of the apparatus, intending merely to study its movements with a powerful aplanatic hand lens. While doing so I noticed that it suddenly appeared to have difficulty in removing one of its feet from the clean surface of the glass, and the next instant the leg gave a violent jerk and the foot was torn off at the fourth tarsal joint, and was left adhering to the under surface of the cover, while its owner walked off, apparently undisturbed by the accident. On releasing the fly and replacing the cover I was able to view the expanded *pulvillus* under the microscope exactly as left by the fly.

On examination with Zeiss's 16.0 mm. and 4.0 mm. objectives with 12 and 18 eye-pieces, using a  $\frac{3}{4}$  cone from an Abbe achromatic condenser, it was clearly seen that the end of each tenent hair was attached to the glass by a comparatively large globule of some transparent fluid which enveloped the sickle filament.

I secured a photograph of this object with the 4.0 mm. apochromatic objective, using a 12 compensating eye-piece for projection, and a  $\frac{3}{4}$  axial cone. The illumination was from the edge of the flame of a small paraffin lamp. Annexed hereto is a platinum print taken from the untouched negative thus obtained, showing some of the hairs adhering to the under surface of the cover. Near the edge of the print two hairs can be seen joined to each other at their extremities by a mass of the gummy fluid.

After carefully studying a fine specimen of the house-fly's foot, mounted in balsam, with a Powell and Lealand  $\frac{1}{1\frac{1}{2}}$  oil immersion of 1.28 N.A., I have come to the conclusion that the tenent hairs of the *pulvillus* show a marked appearance of being hollow or tubular, but it is difficult to decide whether the appearance is a mere optical effect or real.

---

## NOTE ON AN AQUATIC HYMENOPTEROUS INSECT.

By W. BURTON.

(Read May 17th, 1895.)

On looking over some weeds collected from a small pond at Totteridge, on the occasion of our last excursion, I saw a small fly threading its way amongst a tangled mass of conferva and rootlets at the bottom of a small stage tank. Thinking it strange that, although seemingly out of its proper element, it did not seem in any way distressed, I continued my observations. Shortly, on coming to a small open space in the water, I saw it very deliberately spread its tiny wings and fly. I say fly advisedly, for it was certainly more like flying than swimming. This enabled me to see that it bore some resemblance to the fairy flies (Mymaridæ), possessing, as usual with them, a pair of anterior club or battledore shaped wings, exquisitely fringed and covered with hairs, as were also the posterior, which are simply narrow bands, and also the slender waist and pointed extremity common to the Ichneumonidæ. I at once isolated it, and consulted our mutual friend, Mr. Fred. Enock, who at once identified it as the same form found by Sir John Lubbock, at Chiselhurst, in 1863, and described and figured by him in the Transactions of the Linnean Society in 1864 as *Polynema natans*, and which has rarely been found since. I am unfortunately not able to give you a scientific account of this find, as my entomological education has been somewhat neglected, but thought it my duty to bring it under the notice of our Club, as it was unearthed at one of our excursions, and in hopes that it might interest some of our members who are conversant with this form of insect life. I may mention that Mr. Enock and myself visited the pond on several occasions since, and have succeeded in obtaining many more specimens, both male and female, which he is now keeping under observation with the view of publishing the results later on.



## NOTE ON A SPIRIT-PROOF MICRO-CEMENT.

By CHARLES F. ROUSSELET, F.R.M.S.

*(Read June 21st, 1895.)*

Everyone here will know the great importance of a thoroughly reliable cement for fluid mounts. All cements which become quite dry and hard in time are then also slightly porous, and allow the fluid to evaporate slowly through the pores. Asphalt, on this account, is quite useless for fluid mounts, and even Miller's caoutchouc cement can only be depended upon for a time. After a few years it becomes quite dry, and sooner or later an air bubble appears in the mount.

It is my pleasure this evening to announce the discovery of a cement which is not only reliable for objects in watery fluids, but which will also keep in permanently strong and even absolute alcohol. I do not mean to imply, however, that I have myself discovered the cement in question. I have only discovered its existence, which seems almost as great a merit, for it has been used by some for the last fifteen or sixteen years, and yet the fact of its existence has not penetrated to our Microscopical Societies in London. Dr. Dallinger's "Carpenter" recommends the periodical addition of a layer of cement to prevent its becoming quite dry, and only knows Lovett's a very troublesome cement for spirit mounts. Mr. Bolles Lee, in his latest (1893) edition of the "Microtomist's Vade Mecum," says, in speaking of alcohol as a preservative fluid: "Not very recommendable for mounting, as if taken weak it is not a very efficient preservative, and if taken strong it attacks the cement of mounts."

The cement which I wish to bring before you is called Clarke's Cement, and has been used by Mr. Thos. Clarke, of Birmingham, for the last sixteen years for mounting objects in methylated spirit, and his slides are quite good and sound now. I have here a slide of *Leptodora hyalina* mounted in alcohol by this gentleman in 1887, or eight years ago, and it is perfect at present. This is sufficient proof that the cement is reliable for spirit mounts, and,

of course, also for all watery fluids. It is black, and used like asphalt. The diluting fluid is turpentine or benzole, both of which dissolve it very readily. It sets quickly, but takes two to three weeks to get sufficiently dry for handling the slides. It is very tenacious, and never becomes quite hard and brittle. I usually fix the cover glass of fluid-cells with thickened Miller's cement, and when dry make a ring of Clarke's cement over that. Of course with alcohol mounts Miller's cement cannot be used, and the cell can be made, and must be closed, with Clarke's cement alone. It is best to use the smallest oil-colour sable brush, putting on the cement very gradually and little at a time. The brush can be washed out from time to time in some benzole kept for the purpose in a separate little bottle.

The composition of the cement is quite unknown to me and is a trade secret. The cement itself can be obtained from Mr. Thos. Bolton, 25, Balsall Heath Road, Birmingham.

---

MESSRS. WATSON AND SONS' NEW CHEAP CENTRING SUBSTAGE  
FOR ELEMENTARY MICROSCOPES.

*(Exhibited June 21st, 1895.)*

This, as the cut shows, is a serviceable centring substage.

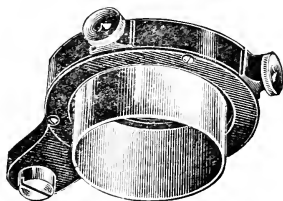

The screws acting against opposing springs enable the optic axis of the condenser to be aligned to that of the microscope with celerity and precision.

When we remember that it is not so many years ago when anything in the form of a centring substage cost £10, we shall the more readily appreciate this simple, yet efficient device.

It can be adapted to almost any form of student's microscope.

---

## In Memoriam.

FREDERIC KITTON.

It is with the greatest possible regret that we have to record the death of our esteemed Hon. Member Mr. F. Kitton, which occurred at his residence, 8, West Kensington Terrace, W., on July 22nd last. Born at Cambridge in April, 1827, as a youth he entered a lawyer's office; force of circumstances, however, compelled him to leave the University town for Norwich, and to associate himself with a wholesale and retail tobacco business, with which an uncle was also connected. The proprietor, Mr. Robert Wigham, was well known in Norwich as a practical botanist, and it was doubtless he who first inspired Mr. Kitton with a love of botany and kindred subjects, more particularly such as required the aid of the microscope, an instrument already beginning to take its place as an indispensable companion in such pursuits. Somewhat later he took up the special study of the Diatomaceæ, a field in which he soon distinguished himself, and became everywhere regarded as an expert in this department of microscopy. It is to be feared, indeed, that this peculiarly fascinating study somewhat interrupted, or caused him to neglect his ordinary business concerns, which really never possessed any attractions for Mr. Kitton; but, be this as it may, it is certain that his place of business in Norwich was frequented by many to whom the purchase of tobacco, either wholesale or retail, was of very subordinate importance to the views or opinions of the proprietor on matters which had no relation whatsoever with commerce. The activity of Mr. Kitton in his favourite pursuit is best shown by his numerous papers in various scientific publications and Transactions of Learned Societies, a complete list of which, we understand, will be put together by his son, Mr. F. G. Kitton, and also by his very large correspondence with almost every diatomist of eminence in all parts of the world. With advancing years, and latterly from

impaired vision, his microscopic studies naturally became somewhat intermittent, although they never really ceased until quite shortly before his death, which happily was painless and peaceful. Mr. Kitton was an Hon. Member of the Roy. Mic. Soc.; the Amer. Mic. Soc.; the Soc. Belge de Micros.; the Quek. Mic. Club; and of the Dublin Mic. Club.

---

## PROCEEDINGS.

MARCH 1ST, 1895.—CONVERSATIONAL MEETING.

<i>Stephanoceros eichhornii</i> ... ..	Mr. W. Burton.
<i>Sphærozoum punctatum</i> ... ..	Mr. Mainland.
<i>Navicula rectangulata</i> ... ..	Mr. H. Morland.
<i>Synchæta pectinata</i> (mounted) ... ..	Mr. C. Rousselet.
<i>Diatoms</i> (various species)... ..	Mr. J. C. Webb.

MARCH 15TH, 1895.—ORDINARY MEETING.

E. M. NELSON, Esq., F.R.M.S., President, in the Chair.

The minutes of the preceding meeting were read and confirmed.

The following new members were balloted for and duly elected :  
Mr. F. Daunou and Mr. John E. Shaw.

The following donations were announced :—

“Proceedings of the Manchester Literary and Philosophical Society” ... ..	} From the Society.
“The Botanical Gazette” ... ..	
Part VI. (concluding) “Anatomy of the Blow Fly” ... ..	} „ Editor.
Prof. Ray Lankester’s contributions to the “Encyclopædia Britannica” ... ..	} Subscription.
“The Microscope” ... ..	} Mr. J. J. Vezey.
“The Journal of the Royal Microscopical Society” ... ..	} In exchange.
“The American Monthly Microscopical Journal” ... ..	} „
“Transactions of the Eastbourne Natural History Society” ... ..	} „
“Journal of the Plön Biological Station” ... ..	} „

The thanks of the Society were voted to the donors.

Mr. Karop caused considerable amusement by reading an ex-

tract from the report in a newspaper of a lecture by Dr. Dallinger, the reporter referring to some wonderful creatures found in water which were possessed of stentors or living trumpets.

Mr. Hill brought down for exhibition a very small portable microscope made many years ago by Nachét, of Paris, which he thought the members might be interested in seeing.

The President thought this was an exceedingly ingenious and beautifully made little instrument, and, although so small, it seemed very complete and efficient so far as could be expected within its limits.

Dr. Measures exhibited a new Abbe-Czapski drawing instrument fitted to a microscope, together with a form of desk for use in connection with it, designed by Dr. Bernard. The apparatus would be found very efficient and reliable, as it was not necessary to keep the eye in position all the time until a drawing was completed. The work could be left, if desired, and resumed later on without the least difficulty arising.

Mr. Swift brought for exhibition a new half-inch objective of .5 N.A.

The President said he had the opportunity of seeing this objective a short time since, and was greatly pleased with its performance. It was beautifully corrected, and its resolution was very fine.

Mr. C. Rousselet read a paper "On a New Floscule," by Dr. Pittock, of Margate.

A vote of thanks to the author and to Mr. Rousselet were unanimously passed.

Mr. Karop read a paper entitled "What was the Amician test?"

Mr. J. E. Ingpen said that two test objects used commonly to have this name applied to them, one of which was *Grammatophora subtilissima*, and the other a form of *Rhomboides*; but the one that was generally regarded as the Amician test was the one introduced by Charles Topping, which was certainly a *Rhomboides*. He had seen this, and also another slide marked "Amician test," which belonged to Mr. Delferrier, upon which he had exercised his  $\frac{1}{16}$  in. objective, and found that this must certainly be regarded as very delicate.

The thanks of the meeting were voted to Mr. Karop for his communication.

Mr. E. B. Green exhibited his drawings of the root hairs of plants and their so-called parasites, all drawn to a uniform scale of  $\frac{1}{7}$ °, and explained the peculiarities observed.

Mr. Karop thought that the question as to whether the green colour referred to in these bodies was chlorophyll could readily be settled by the spectro-microscope, since the characteristic bands of that substance were easily recognized. It seemed so exceedingly doubtful whether chlorophyll was ever formed quite beyond the influence of light that it was very desirable to ascertain whether what Mr. Green thought was that substance really was so or whether these bodies were simply some green unicellular algæ or spores washed into the ground by rain.

The President thought the subject was full of interest and opened up many new lines of research, and he hoped one result of Mr. Green's communication might be that some of their members might feel interested in the questions raised, and start for themselves on some of these investigations.

The thanks of the members were, on the motion of the President, voted to Mr. Green.

The President mentioned that he had after many attempts succeeded at length in resolving some very minute structure on *Navicula major*.

The thanks of the meeting were voted to the President for his interesting communication.

Announcements for the ensuing month were made, and the meeting terminated with the usual conversazione.

---

APRIL 5TH, 1895.—CONVERSATIONAL MEETING.

<i>Brachionus urceolaris</i>	...	...	...	Mr. J. M. Allen.
<i>Callidina eremita</i>	...	...	...	} Mr. D. Bryce.
<i>Callidina alpium</i>	...	...	...	
<i>Nctops brachionus</i> ...	...	...	...	Mr. W. Burton.
<i>Vorticella</i> , fed with carmine	...	...	...	Mr. G. Hind.
<i>Triceratium divisum</i>	...	...	...	Mr. H. Morland.
<i>Synchæta</i> ...	...	...	...	Mr. C. Rousselet.

---



## APRIL 19TH, 1895.—ORDINARY MEETING.

E. M. NELSON, Esq., F.R.M.S., President, in the Chair.

The minutes of the preceding meeting were read and confirmed.

The following gentlemen were balloted for and duly elected members of the Club:—Mr. J. C. Wright, Mr. Thos. A Delcomyn, Mr. Jas. Neville.

The following additions to the library were announced:—

“Journal of the Royal Microscopical Society”	... ..	} From the Society.
“Bulletin of the Belgian Microscopical Society”	... ..	
“Journal of the Q.M.C.”	... ..	”
“British Moss Flora,” part 16	... ..	From the Author.
“Le Diatomiste”	... ..	Exchange.
“Annals of Natural History”	... ..	Purchased.
“La Nuova Notarisia”	... ..	From the Editor.
“The Botanical Gazette”	... ..	”
“Larvæ of British Beetles and Moths”	... ..	Subscription.

The thanks of the Club were voted to the donors.

The Secretary said they had received a communication with respect to a Photographic Exhibition which it was proposed to hold at the Imperial Institute from May to August next; any member of the Club desiring to exhibit was asked to communicate with the Secretary of the Institute, Sir Fredk. Abel.

The Secretary said there was a further important donation to announce, and that was the gift of two dozen lamps and a cabinet of slides from the Committee of the South London Microscopical and Natural History Society, which after 24 years had experienced the fate of some other kindred societies, and owing to the falling off of its members had been finally dissolved. The Committee had decided upon distributing their property amongst existent societies to whom it was likely to be of service, and the items before mentioned had fallen to the share of the Quekett Club. The lamps would no doubt be extremely useful, and the slides would be examined to see what use could be made of them. He proposed that they should pass a hearty vote of thanks to the Committee of the Club, and also to Mr. Dadswell, who he thought had been largely the means of securing this donation for them.

The vote of thanks was put to the meeting and carried unanimously.

Mr. Ingpen said he could not withhold an expression of regret that a Society like the South London had ceased to exist, and he felt as if he should like to propose a vote of condolence with those who had been connected with it, when he bore in mind the useful work it had done and the friendly relations which had always existed between it and the Quekett Club, from which it originally sprang. He had in former years been brought into close association with this Society, and being personally aware of the very friendly relationship which formerly existed, he could only now say how sorry he had been to hear of its demise.

Mr. Karop said he had another announcement to make which would be received with regret by many members of the Club, and that was the death of their old friend Mr. F. W. Gay, which had occurred since their last meeting. To many who had lately joined the Club Mr. Gay would not be known, as it was now some time since he had been able to attend any meetings, but he was one of its founders and was in office as their treasurer for nearly 16 years, resigning at length through failing health. Mr. Gay was one of those quiet men who never put himself forward, but whose work was done with a thoroughness only known to those who were closely associated with him. The Committee had that evening passed the following resolution of condolence to be forwarded to the family :—

“The Committee of the Q.M.C. have heard with great regret of the death of Mr. F. W. Gay, one of its earliest members, who held the responsible post of treasurer for more than 16 years. They beg to tender their most profound sympathy with his widow and family in their loss, a feeling which is shared by every member who knew and valued his long and faithful services to the Club.”

Mr. Ingpen said he should like to add to what Mr. Karop had said, one or two words of a personal character, since he was mainly instrumental in putting the burden of the treasurership upon his old friend Mr. Gay. He could bear testimony to the admirable way in which he carried out his work as regarded their finances, and to the interest taken in their earlier excursions, and his share in the work connected with them. Everyone who attended on such occasions was sure to find a ready helper in Mr. Gay, as well as a genial friend, for he was one of the most club-

able men that ever belonged to the Society. He had felt the loss of his old friend very much, although it was some years since he had been actively associated with him.

Mr. Terry exhibited to the meeting a large number of photomicrographs, which had been brought by his brother, who would be very pleased to give any information concerning them.

The President said they were greatly obliged to Mr. Terry for bringing these beautiful photographs. From the very slight glance he had been able to give them, he was sure they would be well worth careful study.

Mr. R. T. Lewis read a note "On a New Species of Aleurodes," which was illustrated by drawings, and by the exhibition of specimens under the microscope.

Mr. Hardy inquired if the wax with which the pupæ were covered was exuded in a liquid condition.

Mr. Lewis said it could hardly be liquid seeing the shapes assumed by some of the plumes, and the vertical position of others, but there could be little doubt that it was excreted in a more plastic condition than that in which it was found after exposure to the air.

The thanks of the meeting were voted to Mr. Lewis for his communication.

Mr. Shadbolt read a paper "On some Bacteria found in the Thames," illustrating the subject by diagrams and cultivations of the species described.

Mr. Karop said the Club was greatly indebted to Mr. Shadbolt for the trouble he had taken in connection with this matter. The water was some of what was termed "foul water" sent up by Mr. Shrubsole from Sheerness some time ago, and the small round bodies which chiefly contributed to that condition had been described in a paper by Mr. Buffham. Unfortunately Mr. Shrubsole had left Sheerness, so that they would not be able to get any more observations from him this year, which he regretted, as the time was now approaching when this condition of the water would again be noticed.

The thanks of the meeting were voted to Mr. Shadbolt for his paper.

Mr. Karop read a note from Mr. A. Merlin entitled "Some Recent Observations on the Pulvillus of the House-fly," a photograph being sent to show the specialities of structure referred to.

The President thought that there was yet a good deal to be done in the observation of the structure of the pulvilli of insects. Since he had read Mr. Merlin's interesting communication in the "English Mechanic" of March 8th, he had examined the pulvilli of many insects, and he could strongly recommend this fascinating subject to anyone in search of something to take up. The figure in "Carpenter on the Microscope," referred to by Mr. Merlin, was copied from Fig. 11, Pl. V., in Vol. ii. of the "Quarterly Journal of Microscopical Science" (1854),  $\times 225$  diameters, illustrating a paper by Mr. Hepworth, "On the Foot of the Fly." That figure was the origin of the knobbed or trumpet-shaped terminations of the hairs on the pulvillus, and the view put forward by the author that the sticky fluid which the insect secretes exudes through these trumpet-shaped hairs has been held up to the present time. Mr. Merlin has now, by first-rate microscopical observations, shown that the knobbed or trumpet-shaped appearance is an optical ghost, and that the terminations of the hairs are in reality filamentous. Out of a number of insects he had examined, the only one that had trumpet-shaped terminations to the hairs on its pulvillus was a male nettle fly, *Platystoma seminationis* ♂. The *Nycteribia Hopei* (parasite of the Indian flying fox) had large trumpet-shaped hairs which seemed more numerous on the male than on the female. This insect, however, could hardly be called a fly. The question then was, where did the sticky fluid exude? Minute tubules could be traced from the last joint of the tarsus to the terminal hairs of the pulvillus, but although he had examined these hairs with the highest powers he was unable to discover the orifice at which the fluid escaped, although their roots and shafts appeared, as Mr. Merlin had said, hollow or tubular. He was sure they would give Mr. Merlin a hearty vote of thanks for his very interesting communication.

The President said they had a number of photographs sent by Mr. Keevil, of Bath, who it would be remembered sent a curious specimen of flint section which was illustrated by Mr. Karop in No. 34 of the present series of the Journal. There was also another series by Mr. Marryat, of Salisbury, illustrating karyokinesis in the lily; these were remarkable because they were all taken with a cheap lens.

Mr. Karop said these were some of the finest of the kind he had ever seen; all the usual features were well shown. The diaster,

ribbons, connective and barrel-shaped forms were all well shown. Mr. Gilbert read a paper on this subject which appeared in the 1st volume of the Journal, 2nd series.

The President exhibited a form of lens mirror, combining the principles of the pocket lens and Lieberkühn. In its simplest form it was a plano-convex lens with the convex side silvered, and the silvering removed from the centre to form an aperture through which the object could be viewed—another lens of suitable form being added to it—it was held up towards the light and became its own illuminator by converging a strong beam upon the object. He had just computed an achromatic form which he hoped to show them at some future meeting.

He thought the members of the Club who were interested in optical matters would be glad to know of a new photographic camera lens which had recently been brought out. Of late years camera lenses had made enormous strides, chiefly owing to the introduction of the Jena glass, by the use of which astigmatism had been more perfectly corrected. The latest development came from Munich; this was a lens of  $8\frac{1}{2}$  focus, fitted with an iris diaphragm, and the price of the whole thing was 25s. It was about the same as the cost of an English iris diaphragm, and they got the lens thrown in. The novelty of the thing was that there were no compound lenses in it, and so far as the photographic results were concerned it was one of the sharpest lenses he ever saw. In use the lens was first focussed in the usual way for the visual rays, and then it was pushed back and turned into a slot which gave them the exact focus of the actinic rays, and then the picture was taken, which covered a  $\frac{1}{2}$  plate well. He brought the matter before the Club because of the novelty in the construction of this lens, and the question arose, could not this or some similar plan be adapted to photo-micrographic lenses?

Mr. E. B. Green again exhibited a number of specimens and drawings of his so-called parasitic growths on the root hairs of plants. The thanks of the Club were voted to Mr. Green for his beautiful exhibition.

The Secretary said that since their last meeting the Journal had been issued, and he hoped that every member had received his copy.

Announcements of excursions and meetings for the ensuing month were then made, and the meeting terminated with the usual conversazione.

## MAY 3RD, 1895.—CONVERSATIONAL MEETING.

<i>Noteus quadricornis</i>	...	...	}	Mr. W. Burton.
<i>Euchlanis deplexa</i> ...	...	...		
<i>Campylodiscus californicus</i>	...	...		Mr. H. Morland.
<i>Brachionus pala</i> , with eggs (mounted)	...			Mr. C. Rousselet.
<i>Asplanchna priodonta</i>	...	...	...	Mr. W. R. Traviss.

## MAY 17TH, 1895.—ORDINARY MEETING.

A. D. MICHAEL, Esq., P.R.M.S., Vice-President, in the Chair.

The minutes of the preceding meeting were read and confirmed.

The following gentlemen were balloted for and duly elected members of the Club:—Mr. F. R. Greg, Mr. Henry Groves, Mr. E. Macer, and Mr. Michael E. Swan.

The following donation to the Club was announced:—

“Journal of the Royal Society of Cornwall.”

The Chairman said he had to announce to the Club the death of a gentleman who was one of their past Presidents, and who—though not seen amongst them for some years, he thought not since he took the chair at one of their dinners—was at one time a very well-known figure at their meetings; he referred to the late Mr. Arthur E. Durham, F.R.C.S. It could scarcely be said of him, perhaps, that he was a great microscopist, but he was, no doubt, well remembered by all the older members of the Club, who would doubtless also hear of his death with considerable regret.

Mr. Swift exhibited a new form of the Nelson-Dallinger microscope lamp, fitted with mechanical movements in two directions, for the better adjustment of the position of the flame without disturbing the position of the stand.

Mr. Karop thought that lamps like that were only for the “great and good,” and were likely to be regarded as luxuries confined to the few specialists who were not content to move the lamp along the table in the ordinary way.

Dr. Tatham, having had some experience in the use of one of these lamps, found it to be remarkably well adapted to the purpose. It could be brought down to the level of the table or raised, if required, high enough to use with a full-sized microscope, and the rack and pinion were very well constructed. The metal

chimney was not fixed to the lamp fitting, but to the rod, and he thought that great credit was due to Messrs. Swift for bringing out this improved form.

Mr. Michael said he had used one of these lamps for some time, and certainly thought the rack was an advantage. He also found that the rod by which the chimney was attached conducted away a great deal of the heat which came down it for a certain distance, but not sufficiently to prevent the chimney from being removed by the rod as soon as the lamp was put out.

Mr. Randall exhibited an improved form of sounding apparatus, which was fitted with a valve instead of indiarubber, ensuring much greater certainty of bringing up samples of sea-bottom in good condition than the methods hitherto adopted.

The Chairman thought this would act admirably for bringing up specimens from moderate depths, but it would hardly be of much use as a deep-sea sounder, the essential requirements of which were that it must carry a heavy weight which would be released as soon as the bottom was touched. If the weight were not very heavy, it would be carried away by the currents, and if it were not detached it would prove too heavy to haul up. He thought the construction of this apparatus was extremely ingenious, and that it would be extremely useful in comparatively shallow water.

Mr. Karop said he held the same view as the Chairman; the reeling in of a weight sufficient to sink to great depths took a long time and caused enormous strain on the line. He believed the most perfect sounding apparatus was one invented by Commander Sigsbee, U.S.N., described in the voyages of the U.S. Coast Survey vessel *Blake*, where piano-wire was used instead of line, and the sinker, a 60lb. or 100lb. shot, was automatically detached as soon as it touched bottom. They were greatly obliged to Mr. Randall for bringing the apparatus for their inspection.

Mr. W. Burton read a note "On *Polynema natans*," found at the last excursion of the Club in a pond at Totteridge, a specimen being exhibited under the microscope in the room.

Mr. F. Enoch said he had very little at present to add to what Mr. Burton had told them about this very interesting find. This insect was one which he had been looking for without success for the last 19 years, but he found there was truth in the adage that everything came to him who knew how to wait. Sir John Lubbock was looking at some things in a basin of water in 1862.

and found about 24 of these insects in it, but though he himself had searched for them in the place where Sir John told him the water came from, he could not find one. It was next found by a Mr. Ditches, of Stepney, and in 1881 at Stone, in Staffordshire. He had no doubt that it did not belong to the genus *Polynema*, but felt almost sure it would prove to be identical with *Carafraactus cinctus*, Halliday's description of which he hoped shortly to get from Dublin. If anyone succeeded in discovering the eggs it would be a most important thing in connection with its life history.

The Chairman said this was certainly a very beautiful creature under the microscope. He recollected Mr. Bostock's specimen quite well. It was said to fly under water, but its movements were really true swimming, the wings being used as fins in the same way as those of a diving bird. It was an extremely interesting creature, but he was under the impression that it might not be so rare as had been thought.

Mr. Enoch said that the movements of the wings in the water were just the same as in flying; it just moved them up and down, but of course not so rapidly.

The thanks of the meeting were voted to Mr. Burton for his communication, and to Mr. Enoch for his remarks upon the subject.

Mr. J. E. Ingpen read a note "On the Scales of *Ithomia*," with regard to the gradations found between hairs and scales, the subject being illustrated by drawings on the board showing the gradations which had been found, and by specimens exhibited under the microscope.

Mr. Nunney said that he had taken considerable interest in the subject which had been brought before them by Mr. Ingpen. Many distinct forms were usually to be found upon the wings of the same insect, but he had not yet found any other than the one mentioned, upon which the whole series were to be met with.

The President inquired if the observations made gave any support to Mr. Wonfor's old idea that the battledore scales were indicative of sex? Receiving a reply in the negative, he proceeded to remark that when a person saw, for instance, an egg and an oak tree, there could be no mistake made as to the difference between them, but when they came near to the borders of the animal and vegetable kingdoms, it was not always an easy matter



to decide to which of these an object belonged. Precisely in the same way, if they took an extreme scale and an extreme hair, there could be little doubt as to the difference, but if they followed them down through the various forms met with, they came at last to a point where it was extremely difficult to say which was hair and which was scale. When they talked of hairs and scales, they should remember that both these terms were rather vaguely used—the hair of an insect was a totally different structure from the hair of a mammal, and there was an equal difference between the scale of an insect and the scale of a lizard, so that when they came to look into the question they would find far more analogy between the hairs and scales of an insect than between either the hairs or the scales of insects and those of other creatures. It was very interesting to find, as in the instance before them, a specimen upon which the whole course of the development could be worked out in the manner shown.

The thanks of the meeting were voted to Mr. Ingpen for his communication.

Announcements of meetings, etc., for the ensuing month were then made, and the proceedings terminated with the usual conversazione, at which the following objects were exhibited:—

<i>Polynema natans</i> ...	...	...	...	Mr. W. Burton.
<i>Ithomia diasia</i> —scales	...	...	...	Mr. J. E. Ingpen.
<i>Plæsoma hudsoni</i> ...	...	...	...	Mr. C. Rousselet.

---

JUNE 7TH, 1895.—CONVERSATIONAL MEETING.

<i>Melicerta tyro</i> ...	...	...	...	Mr. W. Burton.
<i>Aulacodiscus petersii</i>	...	...	...	Mr. H. Morland.
<i>Arenaceous Foraminifera</i> (sections)	...	...	...	Mr. G. Smith.

---

JUNE 21ST, 1895.—ORDINARY MEETING.

E. M. NELSON, Esq., F.R.M.S., President, in the chair.

The minutes of the preceding meeting were read and confirmed.

The following gentlemen were balloted for and duly elected Members of the Club:—Mr. F. Newstead and Mr. Christopher Poulter.

The following additions to the library were announced:—

“Annals of Natural History” ... .. Purchased.

"Le Diatomiste" ... ..	In exchange.
"Quarterly Journal of Microscopical Science"	Purchased.
"Journal of the Royal Microscopical Society"	From the Society.
"The American Monthly Microscopical Journal" ... ..	} From the Editor.
"The Microscope" ... ..	

The President exhibited and described an improved form of his new reflector loup, which he had now achromatised; it had a focus of nearly 1in. and a magnifying power of 12. The optical construction and principles of the lens were explained by reference to a diagram drawn upon the board. He also exhibited two new apochromatic low-power objectives, one of  $1\frac{1}{2}$ in. focus by Powell and Lealand, and the other a 36 mm. by Zeiss. He had not yet been able to test Messrs. Powell's, although he had not the least doubt that it was up to their usual standard, but his examination of Messrs. Zeiss's showed it to be a very excellent lens, and he was very glad to find that Continental makers were at last beginning to recognize the use of a good glass of low power.

Mr. Ingpen said that Zeiss many years ago made low-power objectives of 32 mm. focus, but gave them up soon afterwards, as they said there was no demand for them. He inferred from their bringing out another that they had discovered at last the value of it. As regarded the achromatic loup he felt sure this would prove to be of the greatest value. He was much reminded by these lenses of Zeiss's a\*, which it was intended should supersede all other low powers, say from 2in. to 3in.

Mr. Davis very much admired the reflector loup in its new form, but thought its usefulness would be much increased if it could be fitted with a reflector below the object, to obviate the necessity for holding it up to the light.

The President said that the idea of using it as a lens for field purposes was an after-thought, the original intention being to use it as a dissecting lens, with a small mirror below. The a\* was a most valuable lens, but the drawback to it with regard to its use with the microscope was that its aperture was absolutely nil, and, therefore, it was practically useless. This new lens of Zeiss's with a standard tube was a charming one to use, having a numerical aperture of .186, with a magnifying power of  $\times 6$  on a 10in. tube—its optical index was 31, and it quite equalled their old English objectives. The only other maker on the Continent who

made anything of the kind was Seibert, whose No. 0 was a little higher than a  $1\frac{1}{2}$  in.

Messrs. Watson and Sons exhibited an adaptation to the "Student" class of microscope of a centring under-stage fitting, conveniently worked by means of two screws and two opposing springs.

The President thought this was an addition much required, and supplied a want which he had himself tried to meet on two or three occasions. None of these cheaper microscopes could be regarded as complete without some kind of centring sub-stage fitting, and the one which Mr. Watson had shown appeared to be a simple and at the same time a very efficient form.

Mr. C. Rousselet described a spirit-proof micro-cement which he had found efficient, a slide exhibited having been mounted with it about eight years ago.

Mr. J. W. Reed read a paper on "The Flora of the Pyrenees," illustrating the subject by the exhibition of a large and extremely well-preserved and mounted collection of the plants described.

Mr. H. Groves thought all present must have listened with great interest to Mr. Reed's description of the flora of this district, with which everyone who had visited it was sure to have been delighted; and he was sure that all must have admired the beautiful collection of specimens exhibited upon the tables before them, more especially when they realized what were the difficulties met with in collecting and preserving during a holiday trip in such a district. This was not, of course, a representative collection, but it was certainly a very interesting one, and he had been rather struck by the fact that so many of the species were British—he thought that out of the 110 represented in this collection 43 were common to the British Islands. It was also curious to notice that many of our common genera when found so much further south were then found growing at a much greater altitude, seeming to indicate the remnants of a much wider distribution, and that an alteration of temperature had been taking place by the increase of which these plants had been driven more and more up the mountains. The remarks as to the British Flora, quoted from Mr. Baker, were very interesting, but were not very surprising, for, as geological time was reckoned, we had not been separated from the Continent long enough to have a distinct Flora of our own. The existence of plants in the West of Ireland common to

America had been noticed, and it was very interesting to note that many Scotch plants, such as *Dryas* and others, were to be found so far south as the Pyrenees. Of the ferns shown he found that there were seven species, all British. He was also somewhat struck with the absence of many plants from this collection, but this was certainly not a matter either for surprise or complaint, because he knew how impossible it was to get a representative collection during a visit of this kind. He felt very much obliged to Mr. Reed for the opportunity afforded of seeing this collection, and also for the very interesting way in which he had brought the subject before them.

Mr. E. T. Newton did not like to let the opportunity pass without expressing his and the Club's indebtedness to Mr. Reed for his paper and for the opportunity of seeing this beautiful collection of plants—for, putting on one side the labour of the collecting, Mr. Reed had taken a large amount of trouble in order that the members might have the pleasure and privilege of seeing the specimens. With regard to the botanical portion of the subject he had little to say, but the similarity of the flora of Ireland to that of Spain was of great interest to him. The idea that these two countries might in geological times have been united was not at all an impossibility, and that the British Islands were once a portion of what was now the main land of Europe was a supposition which did not rest upon mere conjecture. There was no doubt that England and Ireland were originally peopled from the East, and it seemed probable that, before all the animals made their way so far west, Ireland was first cut off from the main land and then England; hence they found that the fauna of Ireland was much poorer than that of this country, whilst England itself was poor by comparison with the Continent of Europe. When did this separation occur? This was a question not very easy to answer with certainty—some authorities claiming it for Pleistocene times whilst others contend for the Pliocene. The birds were, of course, not so restricted, but the animals must have come over when the countries were united, and the period could not have been much farther back than the earlier of these periods, because if beyond that limit the animals would have been different from those known to have inhabited the country. If it was so with the animals, might it not have been so also with the plants? There was, of course, the possibility of plants being introduced in other ways, but he thought the probability lay on the

side of the supposition that their distribution occurred chiefly in the same way as that of the animals. He felt sure that the members of the Club would feel greatly indebted to Mr. Reed and would derive great pleasure from an inspection of his very beautiful collection.

Mr. Reed expressed his indebtedness to Mr. Groves for coming down to the meeting and for the information and hints he had previously given. He regretted, of course, that the collection was not representative, but it must be borne in mind that the object of the trip was mainly mountaineering, and that they were only there for about five weeks; they could, however, have got more flowers, but their paper gave out, and no more could be pressed; and, as everyone knew who had made excursions of the kind, however good might be the resolutions made at starting, these were very apt to give out, too, under stress of circumstances. He thanked the members present for the kind attention which they had given to the paper.

The President said their thanks were heartily due to Mr. Reed for his paper and for bringing this very beautiful collection for their inspection. He hoped that as they had now reached the end of their session and were thinking of holidays some of their members might feel stimulated to follow Mr. Reed's example by collecting or doing something, and giving the Club the benefit of the results when they met again.

A hearty vote of thanks to Mr. Reed was unanimously carried.

The proceedings then terminated with the usual conversazione.

*Plasoma lynceus* ... .. Mr. C. Rousselet.

---

These objects were exhibited at the following Conversational Meetings:—

JULY 5TH, 1895.

<i>Pedalion mirum</i>	...	...	...	Mr. W. Burton.
<i>Lepidodiscus elegans</i>	...	...	...	Mr. H. Morland.
<i>Stephanops lamellaris</i>	...	...	...	Mr. W. R. Traviss.

JULY 19TH, 1895.

<i>Pedalion mirum</i>	...	...	...	Mr. W. Burton.
<i>Lacinularia socialis</i>	...	...	}	Mr. C. Rousselet.
<i>Notops clavulatus</i> (mounted)	...	...		

AUGUST 2ND, 1895.

<i>Hydatina senta</i>	...	...	...	...	Mr. W. Burton.
<i>Aulacodiscus sturtii</i> , with 3, 4, 5, and 6 } processes	...	...	...	}	Mr. H. Morland.

---

## ORDINARY MEETING.—SEPTEMBER 20TH, 1895.

E. M. NELSON, Esq., F.R.M.S., President, in the Chair.

In the absence of the Hon. Secretary, the minutes of the preceding meeting were read by Mr. J. J. Vesey and were duly confirmed.

Mr. Vezey said that Mr. Karop was away for a holiday in Germany, and had recently been visiting Jena, where he seemed to have met with a most pleasant and cordial reception from Dr. Zeiss and others, who took him all over their works and spared no pains to make his visit thoroughly enjoyable. He said in his letter that he felt the honour done to him was largely due to his official connection with the Club, and he wished to let the members know of the kind of feeling which had been manifested towards him on that account. No doubt when he returned they should hear more about his visit.

Mr. Vezey said they had also received a copy of the "Evening Observer" of Brisbane, from which he read an extract with reference to the work which was being done out there by their member Mr. C. J. Pound, who was Bacteriologist to the Stock Institute in Queensland. From this it appeared that the discovery of the bacillus of chicken cholera had been recently made in Australia, and it was expected that the knowledge gained would lead to an important and effective means of dealing with the rabbit plague in that country.

Mr. C. Rousselet's paper "On some New Species of Rotifers found at the Excursions of the Club," was, in the absence of the author, read by Mr. Western, who, having had the opportunity of examining the specimens, was able to speak to the accuracy both of the descriptions and of the drawings by which they were illustrated.

The President felt sure the members would join in according a hearty vote of thanks to Mr. Rousselet for his interesting paper and the plates which accompanied it, and also to Mr. Western for so kindly reading it on that occasion.

Mr. Scourfield read a paper entitled "A Preliminary Account of the Entomostraca of North Wales," in which he recited a list of sixty-seven species found either in fresh or brackish water.

The President, in proposing a vote of thanks to Mr. Scourfield for his paper, said he was very pleased to note that he had not forgotten the Club during his holidays, and he ventured to hope that other members had been similarly mindful.

Announcements of the meetings and excursions for the ensuing month were then made and the proceedings closed with the usual conversazione. Object exhibited:—

Flower of <i>Asparagus</i> , trans. and vert.	} Mr. H. E. Freeman.
sections ... ..	

OCTOBER 4TH, 1895.—CONVERSATIONAL MEETING.

<i>Melicerta ringens</i> ... ..	Mr. W. Burton.
<i>Auliscus mirabilis</i> , Grev. ... ..	Mr. H. Morland.
<i>Periphragella elisæ</i> (Japan) ... ..	Mr. R. W. Priest.
<i>Schizocerca diversicornis</i> ... ..	} Mr. C. Rousselet.
<i>Mastigocerca setifera</i> ... ..	
<i>Polyarthra platyptera</i> , var. <i>Euryptera</i>	

## NOTICES OF RECENT BOOKS.

THE ANATOMY, PHYSIOLOGY, AND DEVELOPMENT OF THE BLOW-FLY. By B. T. Lowne, F.R.C.S. 2 Vols. London: R. H. Porter. £3 3s. net.

Although it would be quite impossible in this place to give anything like a review of Prof. Lowne's great monograph, yet we cannot forbear making some remarks, however inadequate, on a work which has taken up five years of the author's time, and is the most copious and extensive work ever written on a single insect. Perhaps the best idea of the progress of biological science in recent times may be gained by a comparison of the present volumes with Prof. Lowne's original book on the blow-fly, a thin 8vo. of 120 pp. and ten plates, published in 1870, or exactly twenty-five years ago, while the one just completed occupies no less than 780 pp. and is illustrated by 52 plates and 108 figures in the text. The subject is treated in the fullest possible manner from beginning to end, and the conclusions arrived at are based on the author's own investigations into the most minute details of structure, yet it does not represent his personal views alone, as the book contains a very complete *résumé* of the labours of others and an extensive bibliography, which will be invaluable to every student of this department of biology. As is well known, Prof. Lowne holds certain opinions on some much-controverted subjects, notably on the structure and functions of the compound eye and on the homologies of the mouth-organs and the parts of the brain, which have not yet obtained universal assent; but it cannot be said that he has failed to do justice to those who differ from him, for the conclusions of his chief opponents are given at great length, and the reader must decide for himself on the evidence submitted to him on both sides of the questions at issue. A copious index and full reference to 370 memoirs combine to render it an invaluable work, and we recommend it most heartily to everyone who desires to obtain precise information in this important branch of science.

THE NATURAL HISTORY OF AQUATIC INSECTS. By Prof. Miall, F.R.S. London: Macmillan & Co. 6s.

In this work will be found a description of all the commoner and some of the rarer insects which pass either the whole or a part of



their existence in water, whether ponds, ditches, rivers, lakes, or the sea, with their structure, metamorphoses, and general life-history. Many of these, in one or other of their stages, are favourite microscopic objects, and the very complete account which Prof. Miall has given of the various aquatic beetles, flies, caddis-worms, Ephemeriidæ, stone-flies, dragon-flies, pond-skaters, water-boatmen, and other insects should render it extremely useful to all who take an interest in this fascinating branch of natural history. Besides the descriptions in the text there are pretty full references to special works, which undoubtedly increase its value. The illustrations are generally good, many of them being drawn by our former member, Mr. A. Hammond, F.L.S., whose skill as a draughtsman is well known. The book may confidently be recommended.

TEXTE ET TABLES DE LA COLLECTION DES DIATOMÉES DU MONDE ENTIER. Par MM. Tempère et H. Peragallo, Paris. Price 18 francs, or 14s. post free.

This work should certainly be of use to collectors of Diatoms. It is an analysis of the principal species and varieties contained in 625 gatherings and deposits obtained from all parts of the world, and the relative abundance of the various forms in each is indicated by different styles of type, which is a very convenient arrangement. There is also an alphabetical list of localities showing the nature of the Diatomaceæ in each, whether recent or fossil, freshwater, brackish or marine, and finally an index of species, with one to four references to the places where they will most frequently be met with, leaded figures indicating that the particular form is almost unmixed or preponderates, and italics that it is rare. It may be useful to know that either the cleaned material or mounted preparations as well as the book can be obtained of Monsieur Tempère, 168, Rue Saint-Antoine, Paris.

INTRODUCTION TO THE STUDY OF ZOOLOGY. B. Lindsay. London: Swan, Sonnenschein & Co. Price 6s.

This little book is chiefly intended for those who have taken up the study of Zoology for the first time in later life and who require an elementary and at the same time sufficiently reliable guide to put them on the right track. "The commercial man, the clerk, and the well-educated artisan help to make up the class of students I refer to—students whose enthusiasm for knowledge is such as to

lead them to seek it, self-taught and self-guided, in their short intervals of leisure" (Author's Preface). The book is divided into three parts—General Principles, Systematic Zoology, and Advice to Students, illustrated with 124 figures and diagrams, and is provided with a glossary and index. Naturally to deal with so much in such a comparatively small compass necessitates very considerable compression, but Miss Lindsay has contrived to give a very good idea of modern zoological notions, and if the class she appeals to will intelligently assimilate what the book is capable of affording they will not despise their own acquirements nor the able and industrious compiler of their first Introduction to Zoology.

**RAMBLES IN ALPINE VALLEYS.** J. W. Tutt, F.E.S. London: Swan, Sonnenschein & Co. Price 2s. 6d.

Although from its title this work would appear to be scarcely adapted for notice in this Journal, anyone acquainted with Mr. Tutt's many contributions to the literature of Natural History and Entomology would expect to find a large amount of reference to such topics in any book by him.

This expectation is fully realized in the present instance, and the reader will meet with botanical or, more particularly, entomological remarks on nearly every page, and if the descriptive part is perhaps of greater importance to those who have, or intend visiting these charming places, the stay-at-home naturalist will find plenty of suggestive matter treated in a popular and pleasant style.

**HIDDEN BEAUTIES OF NATURE.** By Richard Kerr, F.G.S. London: Religious Tract Society. Price 3s. 6d.

A little book written in a very simple manner, and only designed as a first introduction to such as are yet almost entirely ignorant of the beauties revealed by the microscope. As a gift for any young person who may show some inclination to know a little more about the marvels which surround him on sea and land the work will, no doubt, be acceptable, the more so as it is well illustrated by reproductions of photographs and other figures of Sponges, Radiolaria, Diatoms, etc.

**DAS MIKROSKOP. EIN LEITFADEN DER WISSENSCHAFTLICHEN MIKROSKOPIE.** Von Dr. A. Zimmermann. Leipzig: F. Deuticke. London: Williams and Norgate. Price 9s.

We much regret that, by an oversight, this extremely valuable work did not come into our hands until so nearly the time of

publication of the Journal as to preclude a notice of the length that its merits deserve. The optical part is written so clearly and without any parade of imposing mathematical formulæ, except where such are imperative or easily understood, that, instead of causing weariness, as is generally the case, it is a pleasure to read. The properties of lenses, the images formed by single and combined systems, angular and numerical aperture, aberration and the whole theory of secondary images, are all treated in a masterly way. The various details of the microscope, particularly the objectives and eyepieces, their construction and action, are exhaustively and practically described, but if it is allowable to indicate, from our point of view of course, one little blemish where nearly everything is excellent it is in the matter of the sub-stage condenser. Abbe's chromatic is the only apparatus of the kind mentioned, and it appears strange to us that, while the aperture of the objective is treated with such scientific insight and its value so thoroughly grasped, the equally important factor of the illumination is yoked to such a comparatively inefficient means of utilizing such aperture as is afforded by this widely-used but optically unsound condenser. Nevertheless, it must not be forgotten that Dr. Zimmermann is writing for German readers, and that up to quite recently they universally regarded the sub-stage condenser as a mere English 'fad,' so if they are content for the time with an inferior form it is still an advance on their former attitude, and we must not complain.

So far as we have had time to judge the practical portion of the book is equally good and to the point as the more theoretical, while space has not been wasted on a host of staining and chemical processes, which can easily be found elsewhere. It concludes with a chapter on Microscopical perception, dealing with the images given by an opaque reflecting sphere, as a globule of quicksilver, an air bubble, and a drop of oil in water. There is a short bibliography and index. For such microscopists as read German, and particularly those that employ German instruments, the work will be of very considerable service.

A POPULAR HANDBOOK TO THE MICROSCOPE. BY Lewis Wright. The Religious Tract Society. 2s. 6d.

This excellent work, which contains 256 pages, two plates, and 186 woodcuts in the text, can be strongly recommended to the rank and file of the ever-increasing army of microscopists as well

as to those beginners who are about to enlist therein, and who wish to know what kind of microscope and apparatus to buy, for they will find in it the unbiased opinion of a first-rate microscopist.

Chapters I. and II. deal with the optics of the microscope, a most important subject, for under the new conditions of things which have arisen during the past twenty years it is impossible for anyone to become a microscopist without some knowledge of the fundamental theories of microscopical optics. An acquaintance with these theories is the best safeguard against false interpretation of structure. The author has been most judicious in the selection of matter in these two chapters. He has given enough for all practical purposes without going too deep and beyond the scope of the book.

Passing over the simple, we come to the compound microscope in Chapter IV., of special interest to those about to purchase an instrument. Second and third class instruments only are dealt with, viz., those costing from £18 without objectives to three guineas with two. With almost the whole of the opinions expressed in these chapters we most fully concur; the only points of divergence would be with regard to the horse-shoe foot and the direct acting screw fine adjustment. As to this last point, any direct acting screw fine adjustment, however well made, will be found too quick for wide-angled objectives when illuminated by large cones; as regards its durability the new form, as now made by Zeiss, Reichert, and Leitz, is vastly superior to the old model, which was, after a little use, incapable of critically working a student's  $\frac{1}{4}$ -inch objective.

The latter part of this chapter deals with accessories, including objectives, eye-pieces, and condensers, etc. The reader will find it full of sound advice and practical hints. Chapter V. is full of excellent information on manipulation, but in the next we must notice a slight omission in not pointing out the inversion but non-transposition of an image drawn with a Beale's camera. The following chapter is on the preparing and mounting of objects, and the remaining half of the book is devoted to the objects themselves. With regard to this part we think the selection very appropriate; a careful study of it ought certainly to whet a student's appetite for more knowledge. The book is written in Mr. Lewis Wright's well-known lucid style, and the figures etc., are all that can be desired.







*Aleurodes asparagi*







2



4



5



6



7



8



9



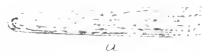
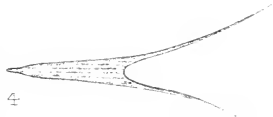
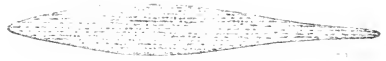

G.C. Karop del.

West. Newman. litt.

*Ithomia diasia*.







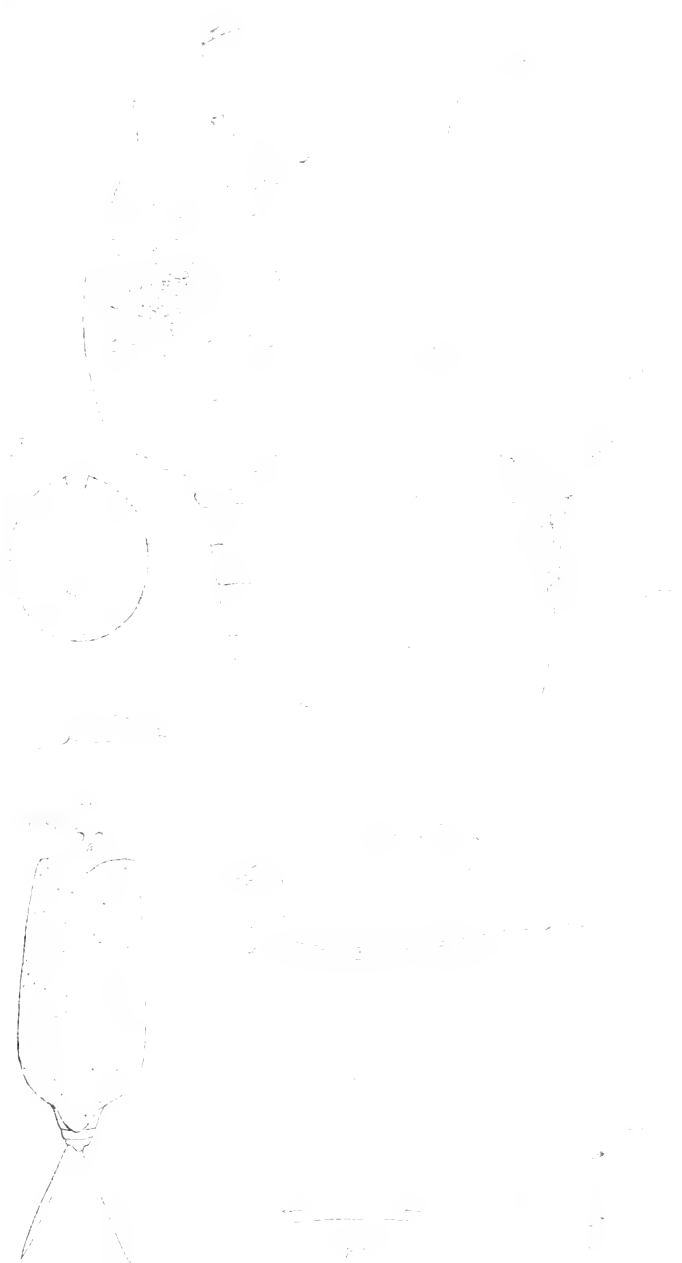

C.F. Rousselet del ad nat

New Zealand









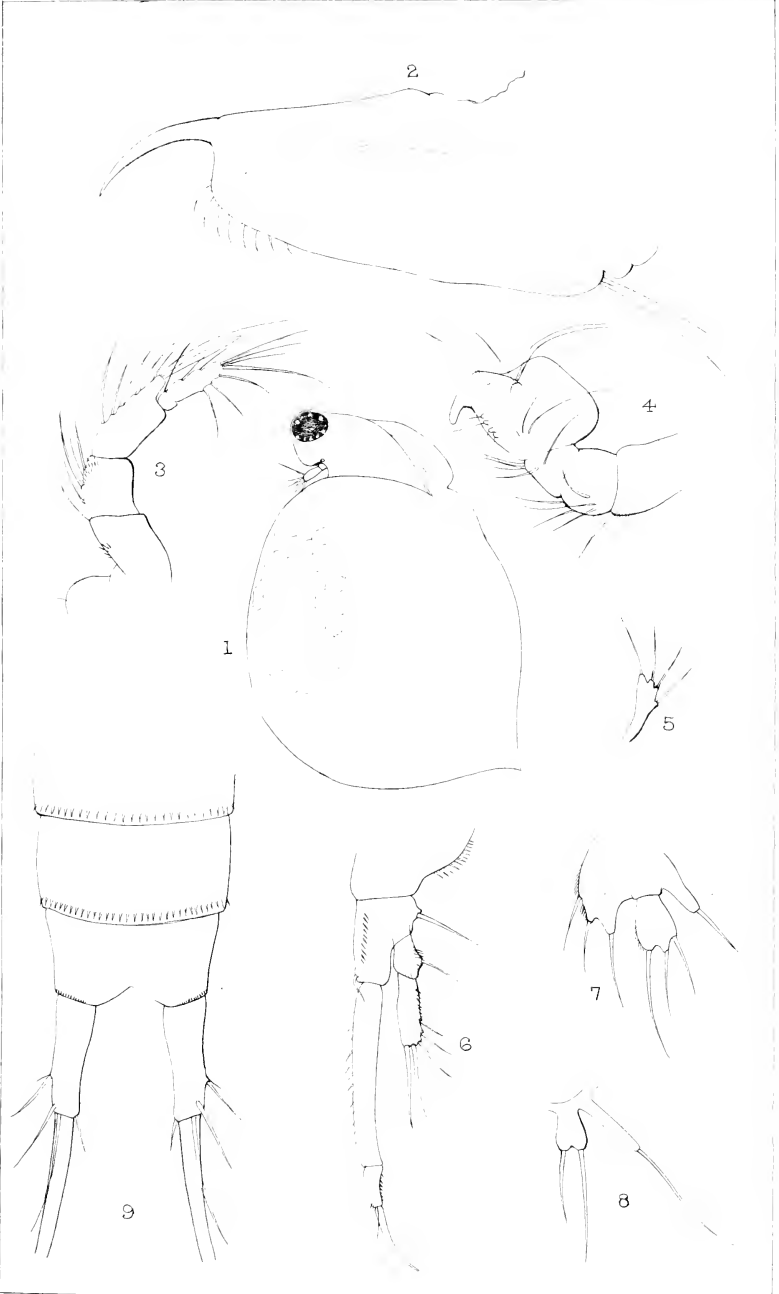

D.J. Scourfield del.

West, Newman sc.

*Ceriodaphnia pulchella* & *Laophonte* Mohammed.





T.H. Buffham del.

West, Newman lith.

*Bonnemaisonia hamifera*



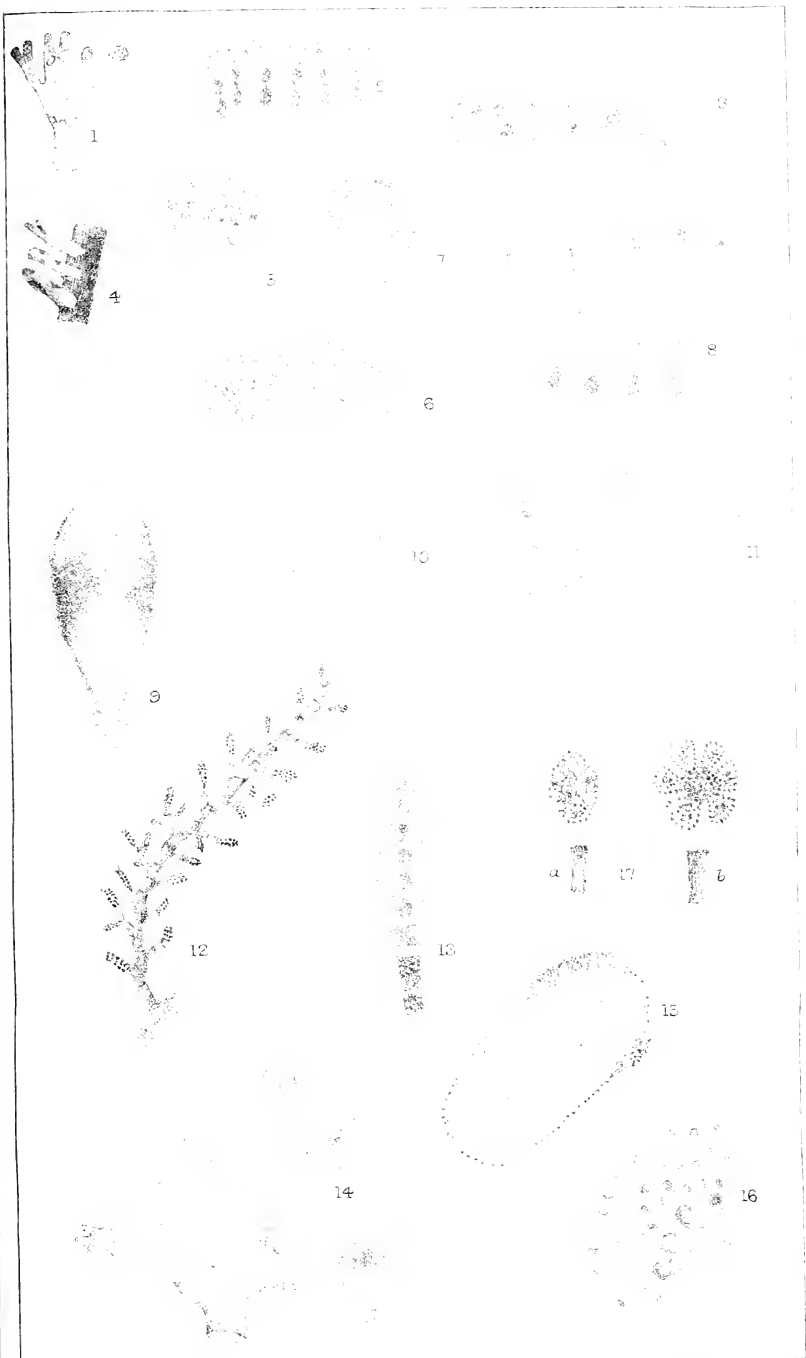

T.H. Buffham: Del.

West Newman Lith.

*Bonnemaisonia hamifera*.





ON *BONNEMAISONIA HAMIFERA*, HARIOI, IN CORNWALL.

By T. H. BUFFHAM, A.L.S.

(Read Nov. 15th, 1895.)

## PLATE IX.

I was collecting marine algæ at Falmouth, in Aug., 1893, when I found floating in the sea a red plant which I failed to identify on the shore. With the microscope, however, it was seen to be a specimen of *Bonnemaisonia*, but of such a *bizarre* appearance as to raise doubts of its relation to *B. asparagoides* Ag. Afterwards I picked up two other floating specimens similar in size and appearance, although differing slightly in the degree of development. The following notes are therefore applicable to the three specimens. They were extremely bushy, branching thickly, about 4 cm. ( $1\frac{1}{2}$  inches) high, and having a dense cortex of small cells. It was also noticed that the ultimate ramuli were not arranged in the regularly distichous order of *B. asparagoides*, although, as in that species, a reproductive organ was almost always opposite to a ramulus. The most noticeable feature, however, was the occurrence of pseudo-cystocarps, some being of the normal form, with a regular ostiole (*ceramidium* of the older authors), but many of abnormal growth, and considerably distorted. I failed to find any carpospores in these bodies, although procarps with trichogynes of quite normal character existed in abundance.

I have noted ("Quek. Jour.," Vol. v., ser. 2, p. 297) that in a considerable number of specimens of *B. asparagoides* every one was monœcious, and it appears doubtful if any unmutated specimen, purely female, has been found. In the Falmouth plants I could not detect any antheridia. I consequently leaned to the conclusion that these were abnormal female plants of *B. asparagoides* which had had no opportunity of becoming fecundated by the approach of pollinoids.

One specimen was preserved in a saturated solution of sodium chloride, one in glycerine, and one was dried. Pressure of other algological subjects of study postponed any re-exami-

nation until this year, when I became very doubtful that the circumstances just referred to could account for the ramification and dense cortex. At this juncture I sent a portion of a plant to Dr. Ed. Bornet, of Paris, who was kind enough to send me a small piece of *B. hamifera* Hariot from Japan, which he considered my plant much approached by its ramification, its mucronate ramuli, and its cortex. Later on he also lent me a dried specimen (see Fig. 1) on which are plainly seen the peculiar branches ending in a hook (*h*) which led M. Hariot to adopt the specific name. This induced me to search my specimens for similar branches. I found one almost exactly like the one shown in Fig. 2, but with the actual point broken off exposing the cells of the interior. All three specimens showed them, but of reduced size; evidently all my plants are younger than the Japanese specimen. Fig. 3 represents my dried plant, the smallest of the three, but a hamose branch can be detected a short distance from the bottom of the figure (indicated by *h*). Meantime I had detected on the perfectly developed ramuli near the growing summits of the branchlets of my plants some minute hyaline recurved spines—2-5 on a ramulus—and always secund near the pointed apices. These project only about 10  $\mu$  from the ramulus, and are consequently visible only when presented in profile (Fig. 5). I then found similar spines on the small portion originally received from Dr. Bornet. The Japanese plant has procarps and perfect cystocarps with carpospores, but no antheridia. These various features, notwithstanding that the Falmouth plants have not been fecundated, establish the specific identity of the Cornish plants with those of Japan.

I have been led into the foregoing rather prolix statement on account of the peculiar circumstances of the case.

*B. hamifera* was first published by Hariot in 1891.\* A few specimens were found in a collection of algæ made by Dr. Savatier at Yokoska in Japan. The diagnosis given by M. Hariot is very clear, and he adds some remarks upon the differences between it and *B. asparagoides*. He gives no figures, however, and I may be permitted to enlarge the original description.

\* "Mem. de la Soc. des Sci. Nat. et Mathematiques de Cherbourg," T. xxvii., p. 223.

The arrangement of the ramuli has already been referred to, and Fig. 4 shows a portion of a branchlet of a Falmouth plant below its summit where the axis is about .3 mm. thick, the ramuli being about .15 mm. thick at the base, and 2 mm. long. These are produced quadrifariously, and on these wholly female plants there is almost always either a procarp or (in the Japanese plant) a cystocarp exactly opposite to a ramulus. The larger bodies (*a*) at the lower part of the figure are pseudo-cystocarps in which only barren filaments exist instead of carpospores. It is remarkable that notwithstanding the absence of fecundation the pericarp should be so largely developed. I am not aware that any analogous case is known.

The hamose branches rapidly become thicker up to .6 mm., and are 3.5-5 mm. high. The structure and cortex are exactly like those of the part from which they are produced.

M. Hariot appears to have been unable from lack of material to describe the "root" which he indicates thus: "Radix . . ." The abrupt termination of the axis in Fig. 1 clearly shows its absence in this specimen. One of my plants has a base spirally coiled round a filament of *Ahnfeltia plicata* J. Ag. The coils of the spiral have coalesced, but the attachment to the *Ahnfeltia* was not close, for I took the *Bonnemaisonia* off without damage to either. Within 6 mm. from the spiral the branching commences (Fig. 6).

The cortical cells have a polygonal outline, and on both the ordinary and hamose branches vary in size from 10 to 27  $\mu$ , being generally 16  $\mu$ , and have richly-coloured contents (Fig. 7). I am unable to give more precise indications of the chromatophores. In the lowermost portions of the plant the cells are very irregular in form and size, and there are numerous narrow red filaments meandering just below them. Near the apex of a ramulus (Fig. 5)—which is frequently more decidedly mucronate than is shown in the figure—the cells are 10-15  $\mu$ . Beneath the cortex of the thicker axes there are larger cells up to 45  $\mu$  in diam., and possessing paler contents, the rest of the interior consists of very large cells up to 150  $\mu$ , devoid of coloured contents, amidst which is a stout articulated axis with granular contents.

The question will already have arisen: How came this alga, known only in Japan, to be found in Cornwall? Yokoska

(Yokosuka on the Admiralty charts) is on the south coast of Nipon (Japan), Long  $138^{\circ}$  E., and Lat.  $34^{\circ} 41'$  N. Undoubtedly in this latitude the sea would be warmer than any British waters. We do not know the limits within which *B. hamifera* can exist. It is noteworthy, however, that the gathering of Dr. Savatier, which comprised altogether only 54 species and varieties, contained 21 species which had not previously been recorded from Japan, and that these new records included some of our common British species, such as *Monostroma Lactuca*, *Ulva Linza* Harv., *Chorda Filum*, *Chordaria divaricata*, *Dictyota dichotoma*, *Padina Pavonia*, *Dictyopteris polypodioides*, *Asperococcus bullosus*, *Laminaria flexicaulis*, *Chylocladia kalifornis*, *Fastigiaria furcellata*, *Melobesia membranacea*, *M. corticiformis*, *Gracilaria compressa*, *Halurus equisetifolius*. This would rather indicate that, so far as temperature is concerned, the Japanese station may differ not considerably from our southernmost coasts.

It is impossible that the Falmouth specimens can have been brought from Japan, and it is certain that they grew near the station where they were found, for they were quite fresh (and anyone familiar with *Bonnemaisonia* will know how evanescent is its fresh beauty), of rich colour, and the delicate procarps with trichogynes were abundant and in perfect condition. Nevertheless I am disposed to think *B. hamifera* is not truly indigenous to Britain. It has frequently occurred to me that the algal flora of many parts may be temporarily, or even permanently, enriched by the unwitting agency of man. The common algæ which grow on the submerged portions of ships may very well harbour the spores of plants, although the plants themselves could not survive the voyage. Moreover, small portions of some algæ might possibly endure the changes. The spiral base of one of my specimens (Fig. 6) suggests the possibility that the curious hamose branches, in the absence of other means, may propagate the species. This is not altogether without analogy in the Florideæ. Dr. Bornet states that portions of the thallus of *Polysiphonia furcellata* Harv., and *P. atrorubescens* Grev., become detached and are capable of growing into plants.\*

\* "Les Algues de Schousboe" in "Mem de la Soc. des Sci. Nat. et Math. de Cherbourg," T. xxviii., p. 311.

M. Hariot refers (*loc. cit.*) to a specimen of a *Bonnemaisonia* from California, sent by Prof. Farlow, of Harvard University, in 1887. This plant was doubtfully referred by M. Hariot to *B. hamifera*. This specimen is in the possession of Dr. Bornet, who kindly lent me it, and I am therefore able to offer a figure of it (Fig. 8). Prof. Farlow marked this *B. asparagoides*? Near the base it bears two or three slender branches with hooked extremities, which certainly seem analogous to those of the typical *B. hamifera*. I have searched the herbaria at Kew and the British Museum for any specimens of *Bonnemaisonia* bearing hamose branches, with the result that I found none at Kew and only one plant at the Museum. This is almost exactly like two of the present fig. joined together near the base. On it also there are two or three hooked branches precisely similar to those in our fig. I have compared a small portion of this specimen with the preparation of Farlow's made by Dr. Bornet, and have no hesitation in concluding that they are one and the same species. The following remarks are equally applicable to the two specimens.

The branches (pinnæ) are in one plane, generally of linear form. These are almost regularly pectinate, the ramuli (pinnulæ) alternating with a cystocarp or procarp (occasionally two, as in Fig. 9), which are opposite to the ramuli. These ramuli are short, thorn-like in form, and taper quickly, not mucronate, and are devoid of spines; the cortical cells near the point being 15-20  $\mu$  in diam. (Fig. 10). No antheridia have been seen.

The British Museum specimen was received there in Dickie's herbarium in 1884. It appears to have been contained in a bundle of plants labelled "N. America." This specimen was marked by Dickie

*Ptilota Californica flicina*? N. America,  
but bears neither the date nor the collector's name. There can be little doubt that this was from California. Mr. G Murray had placed it with other specimens of *Bonnemaisonia*.

Here are its characters:—

*Bonnemaisonia Californica*. (*Ptilota Californica* in Herb. Dickie.)

Fronde 10 cm. high, with one or two principal axes, compressed, pinnate, the pinnæ 1-3 cm. long, erect, regularly

alternate, nearly linear, distichously pectinate with thorn-like ramuli alternating with one or two female organs, a ramulus always opposite to these organs. Ramuli tapering, acute. Some of the lower pinnae are prolonged into a hook bare of ramuli. Plant densely corticate. Cystocarps pedicellate. Antheridia unknown.

Hab. *California* (Dickie, Farlow).

EXPLANATION OF PLATE IX.

- FIG. 1. *Bonnemaisonia hamifera* Hariot. Portion of female plant from Japan. *h, h*, hamose branches. Nat. size.
- „ 2. Ditto. Hamose branch  $\times 5$ .
- „ 3. Ditto. Young unfecundated plant from Falmouth. *h, a* hamose branch. Nat. size.
- „ 4. Ditto. Part of branchlet with ultimate ramuli, procarps, and pseudo-cystocarps (*a*)  $\times 10$ .
- „ 5. Ditto. Apex of mucronate ultimate ramulus with secund spines  $\times 200$ .
- „ 6. Ditto. Spiral base coiled round *Ahnfeltia plicata*  $\times 5$ .
- „ 7. Ditto. Cortical cells of a portion of a branch  $\times 200$ .
- „ 8. *B. Californica* (Dickie) Buffham. Female plant from California. *h, h*, hamose branches. Nat. size.
- „ 9. Ditto. Portion of pinna with ultimate ramuli and young cystocarps  $\times 10$ .
- „ 10. Ditto. Apex of ultimate ramulus  $\times 200$ .

Figs. 1, 3, and 8 from photographs of dried specimens.

---

## NOTES ON SOME FLORIDEÆ.

By T. H. BUFFHAM, A.L.S.

*(Taken as read January 17th, 1896.)*

## PLATE X.

The following *Notes* may be considered as a continuation of a paper *On the Antheridia etc. of some Florideæ*, read in June, 1893 ("Journal," Vol. v., series ii., p. 241), as they refer chiefly to the male organs of some of the red marine algæ.

Since then I have not been able to make a large addition to the British records of these organs, but, such as they are, they may not be without interest. None of the species now figured have, to my knowledge, been drawn before, and most of them have apparently escaped notice hitherto. When the present names differ from those in Harvey's *Phycologia Britannica*, the latter are placed in parentheses.

*Chondrus crispus* Stackh. (Irish Moss) is one of our commonest species, and I have, through many years, unsuccessfully sought for the antheridia. The male plant in no way differs in habit from an ordinary barren specimen, and the only indication of the difference is a faint sinuous line crossing the frond a short distance below the apices, and seen most readily on a half-dried plant. This line is the oldest boundary of the antheridial layer which extends upwards in an irregular patch, with here and there smaller spots, and fades off towards the last divisions of the plant (Fig. 1). The surface view differs very slightly from that of the ordinary cells of the surface, and these male organs are certainly amongst the most difficult of detection. Careful examination with a moderate power at the edges of the frond where the layer occurs will show a very narrow gelatinous border, but even this might still leave the matter in some doubt. If a transverse section through both the antheridial layer and the unchanged thallus be taken the male organs are readily demonstrated. Fig. 2 shows the cells extraneous to the layer, and Fig. 3 those of the

antheridial layer itself. It will be seen that in the latter case there is an elongated gelatinous body about  $20 \mu$  high, and  $7 \mu$  thick, enclosing each male cell, near the apex of which the pollinoid—about  $3 \times 2 \mu$ —is formed. (Hastings, Oct., 1893, in a gathering by my wife.)

Another alga, *Gigartina mamillosa* J. Ag., is almost as abundant as the preceding species, but the male organs have escaped my search until recently. This is the more remarkable as, although tetraspores are unknown, cystocarps are seldom absent from any specimen. My male example was plucked from a rock by my wife. The appearance is strikingly different from that of the ordinary female plant, for it is thickly beset from near the base with flattened leaf-like branches arising just within the edges of the main portions of the frond, and with smaller ones from the other portions of the thallus. In short, the plant has some resemblance to *Chatangium ornatum* in G. Murray's recently published *Introduction to the Study of Seaweeds*, Fig. 68. It is on some of these leaf-like branches that the antheridia appear (Fig. 4). They may sometimes be just detected by the naked eye. They assume various forms: circular, dumb-bell, lobed; and the surface, with a low power, appears mottled as if made up of numerous rounded groups (Fig. 5). The layer when seen at the edge of the thallus projects noticeably, and portions seem slightly pushed outwards (Fig. 6). There is but a thin gelatinous covering, and on such a spot one may just see that the structure differs from that of *Chondrus*, although the opacity of the thallus makes it difficult. If a thin tangential slice of the layer be taken the view from above is that of small groups of darker bodies, about  $9 \mu$  from centre to centre (Fig. 7). A vertical section shows that the groups are the pollinoids in minute bunches at the extremities of articulated threads arising dichotomously from the coloured cells of the thallus (Fig. 8). The structure of this layer has some resemblance to that of *Choreocolax Polysiphoniæ* Reinsch, figured by me (*loc. cit.* Fig. 2), but *Gigartina mamillosa* is on a smaller scale, the pollinoids scarcely reaching  $2 \mu$ . (Salcombe, Sept, 1895.) Caution is requisite in examining this species as the antheridial layer is liable to be overlaid with young *Dermocarpa*. This is readily noticed when near the edge of a flattened branch.



The antheridia of *Rhodymenia Palmetta* Grev. of the normal character were figured (*loc. cit.*, Fig. 15). Since then a particularly fine male plant was collected, and at the same station another with antheridia having 3 or 4 small male proliferations on each, and some elongated antheridia of clavate form proceeded from near the lower portions of the thallus instead of forming the apices of the branches. (Hastings, Oct., 1893, Mrs. T. H. B.)

In *Chylocladia ovalis* Hook. the antheridia form irregular patches on the ultimate obovoid branchlets. Over the unchanged portions of the thallus there is always a hyaline coating of considerable thickness, and the male cells at the border are seen to project almost through this pellucid border (Fig. 9). The surface view shows the layer to be formed of a congeries of rounded groups (Fig. 10). In a vertical section the larger cells near the cortex are found to bud into smaller ones which put forth cells about  $25\ \mu$  high that emit the pollinoids. These are about  $4\ \mu$  in diam., and they and the elongated cells are loosely placed in the gelatinous investment just mentioned (Fig. 11). (Torquay, August, 1894.)

*Ptilothamnion Pluma* Thur. (*Callithamnion Pluma* Ag.) is a very minute plant, sometimes only 2 mm. high, growing on the stipes of *Laminaria*. It was separated from *Callithamnion* by Thuret on account of the difference of the procarp and fruit. The male organs are terminal on the branches, and consist of a short jointed axis surrounded by a gelatinous layer containing the pollinoids. The antheridia are  $50\text{--}70\ \mu$  long, and  $35\ \mu$  in diam. These bodies are drawn by Bornet in *Notes Algologiques*, Pl. 46. (Swanage, June, 1892. Also found by Mr. E. A. Batters at the same station, August, 1891.)

*Compsothamnion gracillimum* Schmitz (*Callithamnion gracillimum* Ag.) is an exceedingly beautiful alga which has been only recently removed from *Callithamnion*, and the antheridia are very different from those of the latter genus. In a male plant they are produced on a pedicel of one to several cells, a pedicel arising from almost every cell of a branchlet. In some cases there are several antheridia in a group (Fig. 12). Even with a low power the appearance is rather striking, for minute dots arranged transversely are seen along the antheridium giving a glistening appearance to the specimen. The repro-

ductive body is ellipsoidal, 40-45  $\mu$  long, and 25-28  $\mu$  diam. The cells of the axis destined to be changed begin by dividing longitudinally into four (generally three only of these are visible), and from these segments gelatinous extensions are made in which the pollinoids, which are about 2  $\mu$  in diam., are produced. The antheridium has a rather delicate and undefined outline outside the 6-8 transverse rows of cells (Fig. 13). (Torpoint, Sept., 1895.)

In *Ceramium acanthotum* Carm. the antheridia form small cushion-like projections round the nodes of the upper parts of the filaments. They have the character usual in this genus (in which I have recorded most of the British species, and figured several), and were seen in French specimens long ago by Thuret. (Paignton, Aug., 1894.)

*Microcladia glandulosa* Grev. is one of our rarest species, and even when found is too frequently barren. After a gale a considerable number of specimens were thrown up and amongst them some bearing male organs. These, without the microscope, are not distinguishable from quite barren specimens. Owing to the density of the thallus they are easily overlooked even with it. They form irregular patches on the uppermost portions of the frond, and are usually more developed on the inner edges of the dichotomous frond, where they project a little (Fig. 14). They are in character very similar to those of *Ceramium*, as might have been anticipated from the relations of the two genera. The "pile" is, of course, seen better in a transverse section of a division of the frond (Fig. 15). Where such a section falls near the irregular boundary of a patch it may be seen that a cell of the cortex buds into smaller ones which emit the long cells (about 20  $\mu$ ) which produce pollinoids about 3  $\mu$  in diam. There is no general gelatinous investment of the bodies, but these are free (Fig. 16). (Paignton, Aug., 1894.)

The early stages of the female organs will afford much interest to the student, and in some cases may tax his skill in dissection. Only the most cursory notes on some observed since the previous paper (*loc. cit.*) can be given here. When the procarps with trichogynes are observed the succeeding stages should be sought out and the development followed to the mature cystocarps. In most of the instances here given the

pollinoids attached to the trichogyne in the act of fecundation were noted.

*Ptilothamnion Pluma* Thur. The development of the female organs is fully described by Bornet in *Notes Algol.*, p. 179, Plate XLVI.

*Griffithsia setacea* Ag. The trichogyne is very slender and delicate.

*Halurus equisetifolius* Kütz. (*Griffithsia equisetifolia* Ag.). It is of a similar character in this species.

*Callithamnion fruticulosum* J. Ag. (Not in *Phyc. Brit.*)

*Compsothamnion gracillimum* Schmitz. A figure of this is given by Schmitz as *Callithamnion gracillimum* (*Untersuch über die Befruchtung der Florideæ*). The trichogyne is swollen near the base. The fruit differs considerably from that of the typical *Callithamnion*.

*Ptilota plumosa* Ag. The trichogyne is stout, but not very long.

*Dumontia filiformis* Grev. The trichogyne is long, stout, brown, and conspicuous. It arises from cells very little below the cortex. *Naccarria Wiggii* Endl.

I will conclude with a few notes including some observations of the association of two kinds of organs.

*Gonimophyllum Buffhami* Batt. I have a specimen where a male leaflet is growing laterally out of the pericarp of a nearly mature cystocarp. In another case there arise from the same basal cushion one leaflet covered with procarps, and three tetrasporic leaflets. When this curious parasitic alga was first published (*Journal of Botany*, 1892, March, Plate CCCXIX) it had not been observed on female specimens of *Nitophyllum laceratum*, and only from Deal. Since then I have seen it on cystocarpic specimens of that host, and also on the plant called *N. reptans* Crn., and have taken it myself at Torquay (Aug. 1894)

With regard to *N. reptans*, described and figured by the brothers Crouan (*Florule du Finistère*, p. 152, Plate XXI.), and distinguished by its prostrate habit and its adhering to the substratum by numerous root-like processes from its inferior face, I received from Mr. J. T. Neeve, of Deal (October, 1891), some specimens of *N. laceratum* Grev. *in situ*. It would appear that usually this species is torn from the substratum and thrown up

by the waves. This circumstance may have led to some uncertainty as to the base of the plant. Harvey says: "*Root a small disc, often throwing out creeping fibres.*" In the specimens just named several of them were unmistakably *N. reptans* below, and *N. laceratum* above. No one but Crouan seems to have observed reproductive organs on *N. reptans*, but his figures appear to enormously exaggerate the size of a cystocarp, and only *one* is shown on each specimen. In some cases, unless a previous acquaintance with the parasite has been made, *Goniomophyllum Buffhami* might be taken as a proper product of the *Nitophyllum*. Mdlle. N. Karsakoff has kindly sent me specimens of *G. Buffhami* collected at Roscoff, Finistère, and possibly the cystocarp drawn by Crouan was that of the parasite, but that would not explain the unprecedented size given in the figures. It might, however, account for the isolated body. Be that as it may, I am led to the conclusion that *N. reptans* is not of specific value, and further that it is not even a variety, but only the early stage of *N. laceratum*. Probably the *reptans* portion is less developed on a narrow substratum where it can more readily become free of contact. Reinsch founded a new genus—*Rhizophyllum*—on what appear to be only very young specimens of this early stage of *N. laceratum* (*Contributiones ad Algologiam* etc., p. 53). I have compared the dimensions he gives of the cells of his two species—*Rh. enervium* and *Rh. nervosum* (*Op. cit.*, pp. 53, 54, Rhodophyceæ, Tab. 38 and 39), and find both agree sufficiently with those of the so-called *N. reptans*. The absence or presence of "nerves" is not constant in all the lobes, and *Rh. enervium* is almost certainly "*N. reptans*," and if *Rh. nervosum* be not also the same it is, in my opinion, only a similar stage of some other species of *Nitophyllum*.

*Spermothamnion hermaphroditum* Näg. was referred to (p. 298) in the paper mentioned at the commencement of these *Notes*. I may add here another association of organs, namely, that of antheridia with tetraspores. The male organs are, like the usual specimens, terminal on a unicellular pedicel, and placed near tetraspores. (Swanage, June, 1892).

In *Compsothamnion gracillimum* Schmitz (*Callithamnion gracillimum* Ag.) Harvey shows the tetraspores of the usual tripartite character. In a recent gathering comprising a number of specimens I observed in all those that would be called tetra-

sporic the sporangia which approached maturity contained more than four spores. After immersion in either glycerine, or a saturated solution of sodium chloride, the appearance is like that of Fig. 17 *b*, where five or six spores are readily seen with a confused centre of the group. This central part appears to be the end of one or two other spores. The nearly mature sporangia are ellipsoidal, about  $65\ \mu$  long and  $55\ \mu$  thick. Even when much smaller the divisions can generally be traced (Fig. 17 *a*), but frequently the earlier stages assume the normal presentation of a tetrasporangium of the typical tripartite character. A scrutiny of the larger of these will, however, generally show a trace of the further division of each quarter visible, so that I am led to doubt the existence of true tetraspores in this species, and to regard the sporangia as *octosporangia*, and the production of eight spores as normal. (Torpoint, September, 1895).

In *Ptilota plumosa* Ag. some tetraspores have been seen on the same plant with procarps; and the involucre of an old cystocarp (or possibly of an unfecundated procarp) became branched near the tips, and developed tetrasporangia.

## EXPLANATION OF PLATE X.

- FIG. 1. *Chondrus crispus* Stackh. Portion of plant with antheridia, natural size.
- „ 2. Ditto. Transverse section of unchanged portion of thallus  $\times 400$ .
- „ 3. Ditto. Vertical section of antheridial layer  $\times 400$ .
- „ 4. *Gigartina mamillosa* J. Ag. Three branches bearing antheridia, natural size.
- „ 5. Ditto. Surface view of circular antheridial spot  $\times 50$ .
- „ 6. Ditto. Antheridia seen near the edge of thallus  $\times 200$ .
- „ 7. Ditto. Surface view of tangential section of antheridial layer  $\times 400$ .
- „ 8. Ditto. Vertical section of antheridial layer  $\times 400$ .
- „ 9. *Chylocladia ovalis* Hook. Antheridial patches on branchlet  $\times 20$ .
- „ 10. Ditto. Surface view of portion  $\times 50$ .
- „ 11. Ditto. Vertical section  $\times 400$ .

- FIG. 12. *Compsothamnion gracillimum* Schmitz. Branchlet bearing antheridia  $\times 50$ .
- „ 13. Ditto. Antheridium  $\times 400$ .
- „ 14. *Microcladia glandulosa* Grev. Portion of male plant  $\times 20$ .
- „ 15. Ditto. Transverse section of thallus showing two portions of antheridial layer  $\times 100$ .
- „ 16. Ditto. Portion of same  $\times 400$ .
- „ 17. *Compsothamnion gracillimum* Schmitz. a. Young Octosporangium. b. Mature ditto. Both  $\times 200$ .



## PRESIDENT'S ADDRESS.

By EDWARD MILLES NELSON, F.R.M.S.

*(Delivered February 21st, 1896.)*

Gentlemen,—In our customary review of the work of the past year, before my data had been collected, I thought that the list of those things which concern my own particular branch of microscopical work would be small, but when it was completed it was seen that that opinion could not be maintained. Although the work of the past year may be said to be up to an average, yet neither in amount nor novelty can it be compared with the previous year, which might justly be called phenomenal.

To begin with, we have a second valuable paper by Mr. Rousselet, "On the Preservation of Rotatoria;" also a note by the same author, "On a Spirit Proof Cement for Microscopical Purposes," a glue which many of us have long searched for in vain.

The improvements in the mechanical part of the microscope are the addition of the Powell-Tyrrell mechanical stage to Baker, Watson, and Zeiss microscopes.\* With regard to stage movements it is by no means certain that the best form has been devised yet, and we may look for further improvements in the near future.

A great deal of attention has been given to this portion of the microscope during the past two years. It will probably be conceded that the Powell-Tyrrell stage is the best that has been designed for first-class stands, which are intended more for the critical examination of a specimen than for rough work, and it would seem that for all such critical work sliding plates are necessary; but for smaller microscopes, on which more rough and ready work and the preliminary examination of objects is accomplished, it would appear that the better plan is

\* "Journ. R.M.S.," 1895, pp. 98, 688. The Tyrrell stage was used on Engiscopes in 1837.

to push the slide about on the fixed stage, much in the same way as is done by the fingers. It must be remembered that serial section cutting has made great strides during the past few years, and as further progress in this direction is to be expected in the future, the advanced student's microscope must be supplied with a good mechanical stage, giving a range of at least 2 inches transverse, and  $1\frac{1}{2}$  inch of vertical movement, if it is to keep pace with the times. Messrs. Zeiss have given attention to this subject and have fitted their large microscope with a mechanical stage \* possessing the above range of movement. It has, however, that which seems an objection, viz., the pinion for the transverse movement is placed nearly vertically on the stage, somewhat after the method employed by Tolles,† and which, it must be feared, proved a failure. The same firm have also introduced an improved Mayall stage which is of much practical merit.

In substages we have a cheap centring one by Watson.‡ As this can be fitted at small cost to the most elementary microscope it will supply a much needed want.

We have a new portable microscope by Swift on the lines of their new four-legged microscope, exhibited last year,§ only further portability is secured by folding up the stage and the front legs. The one Messrs. Swift and Son have made for me has my horse-shoe stage, no less than 5 inches wide by  $4\frac{1}{2}$  deep, the body being capable of extension from  $4\frac{1}{4}$  to  $12\frac{3}{4}$  inches, yet this packs in a case only 6 inches wide,  $5\frac{1}{2}$  deep, and 8 high. The weight of the instrument, with mechanical stage, all brass, is  $7\frac{3}{4}$  lbs.

A pretty little microscope,|| VI A, of the Hartnack type, is made by Messrs. Zeiss; it is supplied with a chromatic condenser and iris diaphragm. This stand seems to be the limit to which those built on the Hartnack plan should be carried. It is difficult to understand the advantage that arises from overloading a microscope built on defective lines with all kinds of elaborate and expensive movements which can never yield the

\* *Tom. cit.*, p. 99, 3 figs.

† "Journ. R.M.S.," 1881, p. 117, 2 figs.

‡ This Journal, 1895, p. 151, 1 fig.

§ "Journ. R.M.S.," 1894, p. 506, fig. 33.

|| "Journ. R.M.S.," 1895, p. 224, fig. 26.



highest results; but when this model is confined to small, unpretentious, well-built instruments, such as VIA, it serves the purpose very well indeed.

Messrs. Beck and Co. have brought out a petrological star microscope,\* as well as one of a more advanced type, and Messrs. Swift and Son have improved their Dick microscope.†

The Zeiss erecting prisms, which are used in the new binoculars, have been applied to a dissecting microscope,‡ which has also been made binocular after the plan of Chérubin d'Orléans, viz., by using two objectives.

There is an object-finder § by Herr R. Feuss, which is somewhat similar to that of Bridgman,|| and is for the purpose of scratching a small circle with a diamond point round any desired object. That of Bridgman fits on the objective itself, and must therefore be concentric to it; but this new device is a separate piece of apparatus, placed on the nose-piece when the objective is removed, and not necessarily concentric.

In the optical department we have an apochromatic  $1\frac{1}{2}$  inch objective by Powell, and a semi-apochromatic of the same power by Zeiss, their optical indices being 27 and 31 respectively.

Mr. J. W. Gifford has produced a beautiful F line screen, which far surpasses all previous attempts in this direction. It passes plenty of light, and while it does not interfere with vision, so far as the eye is concerned, it nevertheless sharpens up even apochromatic objectives, and brings the cheap semi-apochromats almost to the same degree of efficiency as apochromats. Finally, it slightly increases the resolving power by shortening the wave length, that is by filtering out the visually more luminous longer waves. I cannot too strongly urge members to supply themselves with so cheap and efficient piece of apparatus.

Two articles have appeared in the "Journal R.M.S." on "Brownian Movement."¶ Will not some member take up and

\* *Tom. cit.*, p. 226, 3 figs.

† *Id.*, p. 96, fig. 6.

‡ *Id.*, p. 580, 3 figs.

§ "Journ. R.M.S.," 1895, p. 587, 2 figs.

|| "Quart. Journ. Mic. Sci.," 1855, Vol. iii., p. 237.

¶ "Journ. R.M.S.," 1895, pp. 111, 591.

experiment on this still dimly understood phenomenon? The last in the list is the most bizarre piece of apparatus that has appeared in the microscopical world for many years. Of course, in the annals of a patent office, any number of the most mad and impossible inventions may be seen, but it is almost incredible that such a device as that of Herr A. van Delden should appear seriously in any scientific journal. Strange as it may seem, it has nevertheless been published in Germany, and is extracted without comment and inserted with three figures in the "Journal R.M.S."\* The title of the article is "An Auxiliary Apparatus for the Adjustment with Immersion Objectives." The appliance, in spite of its high-flown title, is of the nature of a safety stop to prevent the owner of the instrument either crashing through the slip or driving his front lens through a back combination while focussing an oil immersion objective. The following is a description of the manner in which this is effected:—A block is fastened to the body of the microscope above and in a line with the top of the limb. A 50-thread micrometer screw passes through this block in a vertical direction. The head of the screw is divided, and alongside there is a graduated post, on which can be read whole revolutions of the screw head. When the body is racked down by the coarse adjustment this micrometer screw comes in contact with the top of the limb and prevents the body being racked down any further. If it is required to lower the body still more the micrometer screw must be raised by unscrewing it, when of course the body can be racked down until the screw is again brought into contact with the top of the limb. Before the apparatus can be employed it is necessary to find the co-efficient of the instrument; this is arrived at in the following manner. A particular low-angled dry objective is placed on the nose-piece, and an object on the stage is brought into focus. The micrometer screw is now lowered until its point butts against the top of the limb, the number of revolutions and parts of a revolution of the micrometer screw are read off on the post and screw head respectively and noted, after which the fine adjustment of the microscope must not be touched. The dry objective is then removed and the oil immersion put in its place; this is now

\* *Tom. cit.*, p. 585, three figs.

brought into focus on the same object, and the micrometer screw is again made to butt on the top of the limb, its position read off on the scales and noted as before. The co-efficient of the instrument is the difference between these two readings, in other words it is a micrometrical measurement of the difference in position of the body with respect to the limb when a low-angled dry and a wide-angled oil immersion objectives are focussed on the same object by means of the coarse adjustment only. For instance, let us suppose that the first reading was 27·38 and the second 39·24, the difference is 11·86, the required co-efficient. The method of using the instrument is as follows :—Suppose we wish to examine an object with an oil immersion objective, the object is first focussed by the special low-angled lens mentioned above, and when that has been precisely arrived at the micrometer screw is turned until it butts against the top of the limb, the scales are then read, the co-efficient obtained above is then added to this reading, the micrometer screw is now turned until it registers the sum of these readings. The low-angled objective is then taken off, the oil immersion objective placed on the nose-piece, and the body racked down by the coarse adjustment until the micrometer screw butts against the limb. The oil immersion objective will now be in focus, provided that all the various steps have been accurately performed; the consequences would, however, be disastrous if one made a slip in addition or an error in the reading of one of the scales. Can anything be more ridiculous than this setting and reading of a micrometer screw, the application of a co-efficient, and the resetting of the micrometer screw merely for the purpose of focussing an oil immersion objective, an operation which a tyro in microscopy of a fortnight's standing could accomplish in a fourth of the time required for a single reading of the micrometer. All this throws a flood of light—first, on the state of microscopy on the Continent, and, secondly, on the inefficiency of the continental stage, with its small hole and spring clips.

Before proceeding to the other part of the address two further points may be considered. The first is, "How would you define the size of a microscope?" Obviously it is not its power, neither the length or diameter of the body; nor is it its weight or the size of its stage. What then is it? Practically the size

of a microscope depends on two things—first, the distance of the optic axis from the limb; and, secondly, its distance from the table when the microscope is placed in a horizontal position. Although a simple it is an important and suggestive question, which has not received much attention hitherto.

The second point has reference to the conversion of metric into English linear measures, and *vice versâ*.

The best determination of the length of the metre by Colonel Clarke in 1866 made it equal to 39·37043196 inches, but as few people can remember a numerical co-efficient for reduction, a well-known rough and ready substitute, sufficiently near for practical purposes, and with a memory catch in it, is used instead of the correct figure. It is as follows: One metre is equal to three feet, three inches, and one-third. If you work this out you will find that it is too short by five feet in a mile. Now could not a much nearer equivalent be found which, like the preceding, possesses some sort of memory catch? After a little search I succeeded in finding one that will probably meet most requirements. The number to be remembered is six and a half inches. This should not be difficult to a microscopist, because it is the length of the continental tube. Now all that is necessary to convert this into metrical measure is to write a one in front and a one behind it. Therefore 65 will become 1651, that is six and a half inches is equal to one hundred and sixty-five decimal one millimetres. The error in this co-efficient is only five and a half inches in ten miles; it is, therefore, about 110 times more accurate than the other memory co-efficient.

All microscopists who have to reduce metrical measures, or convert English measures, or to work with micrometers, should most certainly invest in a slide rule. With a slide rule any reduction becomes supremely easy; all that is required in the present case is to set 1651 on the slide in a line with 65 on the rule; when that is done any conversion of metric into English, or English into metric measure, is performed by inspection without any further movement of the slide. For example, when the slide is so set 3 on the slide will be in a line with 118 on the rule, therefore 3 mm. equals ·118 inch, or 30 mm. 1·18 inch; again, 315 on the rule is in a line with 8 on the slide, therefore 3·15 inch is equal to 80 mm., or ·315 to 8 mm., and

so on. In brief, when the slide is once set everything on the slide is metrical, and everything on the rule is inches.

The subject chosen for this evening is on the construction of lenses. I will endeavour to make it as interesting as the nature of the case will permit, and will leave out all mathematical formulæ.

We will first touch on spherical aberration in lenses, and in particular in that known as Herschel's doublet. There can be no reason or need for a chromatic doublet made of one kind of glass for visual purposes when an achromatic aplanat might be constructed for the same cost; nevertheless, for illuminating purposes the subject is of much importance. This doublet appears in the "Ency. Metrop." in that classical article on "Light" by Sir John Herschel, who was a Senior Wrangler. Coddington, also a Senior Wrangler, quotes it in his excellent treatise on "Optics," where he gives the radii but not the foci. Sir D. Brewster gives it in the "Ency. Brit.," 7th ed., and interpolates an error in one of the radii. Parkinson, a fellow and tutor of St. John's, quotes it in his "Optics." That it has attracted so much attention is therefore not to be wondered at. I have worked out the aberrations of both Herschel's doublets, and find that neither of them is free from aberration; the

aberration of the high power is —  $\cdot 296 \frac{y^2}{F}$  and the other has

just a trifle more. The focus of the high power combination is also wrong,\* and this mistake is copied both by Brewster and Parkinson.

There is no doubt that the aplanatism of this doublet cannot any longer be maintained. It is very easy to generalise on this subject and say that as both the lenses of which the doublet is composed are converging ones, therefore they both must have the same kind of aberration; the case, however, is not so simple. For example, let us suppose that a pencil is converging directly on the plane surface of a block of glass (refractive index  $\mu = 1\cdot5$ ) to a point on the axis inside the glass and one inch from that surface; on entering the glass these rays will be

\* This is, of course, a very serious error, for any optician constructing a lens of any given focus from this formula would use this erroneous focus as a divisor; the result would be that all his radii would be wrong.

refracted to another point on the axis  $\mu$  times further into the glass, viz., one-and-a-half inches from the surface; this second point is called the geometrical focus. This geometrical focus is only true for rays very close to the axis; rays that are more distant from the axis are aberrated. In this respect refraction differs from reflection, because there is no aberration in a ray reflected at a plane surface. The effect of aberration is to send the ray further into the glass than the position of the geometrical focus. If the point where any particular ray strikes the plane surface of the glass is distant  $y$  from the axis then the aberration of that ray will be  $\frac{5}{12} y^2$ ; therefore, if  $y$  in our example is one inch, then that ray will be refracted to a point  $\frac{5}{12}$  inch further into the glass than the geometrical focus, viz., 1.9167 inch from the surface.

This kind of aberration is called positive. Sometimes rays are brought to a focus less distant from the surface than the geometrical focus, in which case the aberration is known as negative.\*

Now let us suppose that instead of a plane surface we have a convex spherical surface of very long radius, the radius being so great that the surface is almost plane, we can see then that the aberration will be similar both in direction and nearly in amount to what it was before, but it will now be called spherical aberration. Next let us make the curve more convex by shortening the radius until the radius is equal to the focus of the incident light, viz., one inch. The incident light now falls on the glass normally or perpendicular to the surface; there is therefore neither refraction nor aberration; the rays pass through the glass and meet the axis aplanatically at the centre of curvature. So we see that the rays which were refracted nearly two inches into the glass block get nearer and nearer to the surface as the curvature is deepened until they arrive at the centre of curvature, which is also the point to which the incident light converges; at the same time the aberration, which

\* Some writers, however, reverse these terms. In hardly any other science does such a difference of nomenclature exist. In some works the focus of a converging, or common biconvex, lens, will be called negative. The utmost confusion prevails with regard to the signs attached to conjugate foci and radii of lenses. Changes are sometimes made in the nomenclature of the signs in the same book without any intimation in the text!

was  $+ .4167 y^2$ , gets gradually smaller until it vanishes. If we further deepen the curvature the focus of the refracted rays gets nearer the surface than that of the incident rays. But what about the aberration? you will naturally ask. As the calculation for the aberration at a spherical surface depends on the solution of an equation of the third degree, the subject can hardly be put in a popular form; all that can be said is that if you solve this cubic equation for our own particular example you will find that the aberration is still positive, and that it increases slowly until the radius is  $.526$  inch, when it arrives at a maximum of  $+ .0213 y^2$ ; it then rapidly declines until it vanishes for the second time. You will notice that the aberration at this second maximum is only a twentieth of that at a plane surface.

We now come to a very important point, viz., when the spherical surface has two aplanatic foci. You will remember that at our former aplanatic point both the foci coalesced at the centre of curvature; in this instance, however, they are separated. When the radius is equal to the focus of the incident light, divided by the refractive index plus one, then those incident rays will be aplanatically refracted to another point, whose focus will be equal to the same distance (*i.e.*, the focus of the incident rays), divided by the refractive index.

In simple words, in order to find the radius, we must divide the focus of the incident rays by the refractive index plus one; and to find the focus of the refracted rays, we must divide the focus of the incident rays by the refractive index. Therefore, in our example, the radius is one divided by two-and-a-half and equals  $\frac{2}{5}$  inch, and the focus of the refracted rays is one divided by one-and-a-half and equals  $\frac{2}{3}$  inch.

The reason why this rule is so important in microscopy is because it is the basis for the construction of homogeneous immersion objectives.\* The immersion front is made of such a radius that it will refract the rays proceeding from the object aplanatically to some other and longer focus, this longer focus being the focal point of the second lens. The radius is found, therefore, by dividing the distance from the apex of the front lens to the object by  $(\mu + 1)$ , and the longer focus by dividing the same distance by  $\mu$ .

\* "Journ. R.M.S.," 1878, p. 142, fig. 2.

Important as this may be, it is nevertheless a digression, so we must return to the example before us. We found that when the focus of the converging incident rays was an inch, and the radius of the convex surface four-tenths of an inch, that the aplanatic focus of the refracted rays was two-thirds of an inch.

Now, if we further increase the convexity of the surface, we shall find that the refracted rays are still brought nearer to the surface, but the aberration will now be no longer positive, but negative, and will increase rapidly; that is to say, the spherical aberration will bring the refracted rays nearer to the surface than the geometrical focus. Thus, with a radius of two-tenths, it amounts to no less than  $-.544 y^2$ , a quantity greater than any we have yet had. As it is so important, let me sum up the results concisely. Let us call the focus of the incident rays

$$P$$

$P$ , then if the radius is less than  $\frac{P}{\mu + 1}$ , the aberration is

$$P$$

negative and considerable. If the radius is equal to  $\frac{P}{\mu + 1}$ , there is no aberration, but there are two aplanatic foci. If the

$$P$$

radius is greater than  $\frac{P}{\mu + 1}$ , the aberration is positive: there is,

however, one exception to this last rule, viz., when the radius is equal to  $P$ , then there is no aberration. Finally, in our example, where  $P = 1$ , the positive aberration never exceeds  $+ .4167 y^2$ .

The next step is this. Having obtained positive aberration in a block of glass with a convex surface, how is it to be preserved when the block of glass is made into a lens? All that is necessary is to make the back curve of the lens a radius measured from the focal point of the refracted rays; the rays will then pass out of the glass normally to the surface, so there will be neither refraction nor aberration.

We see, therefore, that a meniscus constructed on this plan cannot have more positive aberration than  $.4167 y^2$ , and, moreover, the lens will be a diverging meniscus, because the convex front surface will have a much flatter curve than that of the concave back. We must now consider the first lens of the doublet upon which the parallel rays impinge. The best form



for this lens is that known as a crossed lens, and for the kind of glass we are using the radii will be in the proportion of 1 : 6 for minimum aberration. The lens must be of one inch focus, so that the rays may converge on the second lens to a focus one inch from the surface; the lenses are assumed to be in contact. If we now calculate the spherical aberration of this crossed lens, we shall find that it is  $-1.0714 y^2$ , but we have seen above that the utmost amount of positive aberration from one spherical surface that we can bring to oppose this is something less than  $+ .4167 y^2$ , a quantity insufficient to balance even half the negative aberration of the crossed lens, therefore a doublet of no aberration cannot be constructed on this plan.

Being baffled in our attempt to neutralise the negative aberration of the crossed lens by the positive aberration of a single surface, let us examine the conditions we shall obtain by placing an aplanatic meniscus behind a crossed lens, so that the longer focus of the meniscus shall be coincident with the focus of the crossed lens. Applying the law we have just investigated, and making the focus of the crossed lens unity, the front curve of our meniscus will be, as we have seen,  $\frac{2}{3}$ , and the back curve will be the same as the conjugate focus we found for the refracted rays, viz.,  $\frac{3}{2}$ . The meniscus by itself will have a focus of two inches, and as that of the crossed lens is one inch, the focus of the combination will be  $\frac{3}{2}$  inch. It is usually more convenient to transpose this into a combination of one inch focus, then we shall have the focus of the crossed lens  $\frac{2}{3}$  and that of the meniscus 3 inches.

Now, as the aberration of the second lens is 0, the aberration of the combination is that of the first lens in terms of the focus of the combination, thus the aberration of the first lens,

$-1.0714 \frac{y^2}{f}$ , becomes  $-.317 \frac{y^2}{F}$ , which is the aberration of the

doublet, a result a shade more than that of Herschel's.

You will probably by this time have had enough of the aberration of a single spherical surface, but the problem is important for two reasons: First, because it is the point on which those rely who say that an aplanatic doublet can be composed of two converging lenses; secondly, the calculation is so long that few attempt it.

The usual method of calculating the form of such a lens

would be by an ordinary affected quadratic equation, neither very long nor troublesome. If anyone goes through this they will find that when the second is a converging lens, *i.e.*, has a positive focus, the roots are imaginary. One should judge from this that it is impossible to construct an aplanatic doublet of this form; if, however, the second lens is allowed to have a negative focus, the roots become real and two forms of lenses are possible.

In the first doublet the second lens is a biconcave, the anterior curve being deeper than the posterior; the other doublet has a diverging meniscus for its second lens, with its posterior curve deeper than its anterior; but both these doublets have such steep curves that they are practically useless. We now come to the last case, *viz.*, that when the equation has no real root it can be solved for a minimum value. This is a very simple matter; the curves of a doublet so calculated are given in the appendix.

Having constructed our lens, we can compute the amount of its aberration, and it will be found to be  $-\cdot 214 \frac{y^2}{F}$  or 27 per cent. better than that of Herschel's. To sum up our work

1. We have seen that Herschel's doublet has an aberration of  $-\cdot 296 \frac{y^2}{F}$ .

2. We have investigated aberration at a single spherical surface, and have found that in our example it did not exceed  $+\cdot 4167 y^2$ .

3. We found that no lens thus constructed could neutralise the negative aberration of a crossed lens for parallel rays.

4. We have investigated the construction of an aplanatic front of a homogeneous immersion objective.

5. We have seen that an aplanatic meniscus, when combined with a crossed lens, yields a result somewhat similar to that of Herschel's doublet.

6. That the quadratic equation for aberration has no real roots for a lens of positive focus with the given conditions.

7. That two doublets of no aberration may be constructed when the second lenses have negative foci.

8. That when we are contented with a minimum of aberration

tion, a doublet may be very easily constructed with only —  $\cdot 214 \frac{y^2}{F}$  of aberration, a result 27 per cent. better than

anything hitherto realised in doublets of this form.

There can be no doubt that Sir John Herschel's doublets have played an important part in the evolution of the microscope, as evidenced by the references made to them in almost all microscopical text-books since their introduction in 1821 up to recent times, say, for example, "Ency. Brit.," 9th edition, art. "Microscope," p. 260. Although these doublets are now of no use for visual purposes, never having equalled the performance of a Brewster's grooved sphere, they are, and will probably continue to be, of service for Bull's eyes and condensing lenses. The so-called Herschel's doublets in the market are not made on Herschel's formula, nor, in fact, on any formula at all, but are for the most part composed of any two lenses chosen at haphazard, and consequently have far more aberration than two planos of proper foci. In the following Appendix there is

1st. Sir John Herschel's doublet transposed to a combination whose combined focus is 1·0.

2nd. A doublet of no aberration of the same focus. The second lens of this doublet is a bi-concave. You will observe the very small radius of the incident surface of the crossed lens. The arrangement has no practical value.

3rd. My new doublet of the same focus. You will notice that the deepest curve is the incident surface of the meniscus, but it is not so deep as that of the corresponding curve in Herschel's form.

4th. The curves of the best form of microscope Bull's eye, made of Boro-Silicate crown. It has  $62^\circ$  of aperture, and only a total aberration of —  $\cdot 103$ ; its working distance is 1·5.

I understand that some other microscopist before me has pointed out that Herschel's doublet was not free from aberration, but I am not aware if he proposed a better alternative form.

The authorities who have upheld the aplanatism of this doublet so long before the microscopical world, have done so because they have merely inspected the equations and have not

worked out a definite problem. By inspection you may see that the aberration is positive, but it is only when you work out an example that you find the smallness of the positive aberration at a single surface by the cubic equation, and this is what they have not done.

In conclusion, I must apologise for having, on this second occasion, brought such a dry subject before you.\*

---

APPENDIX.

Sir John Herschel's doublet (high power form), as given in "Ency. Metrop.," art. "Light," p. 391, transposed to a combination whose focus is + 1.0. Refractive index 1.50

1st lens crossed	$r = + 1.644$	
	$s = - 9.866$	$f = + 2.819$
2nd lens, meniscus	$r = + .579$	
	$s = + 2.291$	$f = + 1.55$
Aberration =	$- .296 \frac{y^2}{F}$	

---

\* The following information may be of service to those beginning to compute the curves of lenses :—

1st. One of the greatest labour-saving machines is a good slide rule. An ordinary 12-inch slide rule may be obtained for 10s. or 12s. These are accurate to two places, and the third may be approximated. By far the best slide rule is that of Prof. Fuller. It has a logarithmic scale nearly 42 feet long; its price is £3, and it is accurate to four places; a fifth may be approximated. A smaller one is made with a scale nearly 17 feet long; its price is £1. Both these are sold by Stanley, Turnstile, Lincoln's Inn Fields, W.C.

2nd. Logarithm Tables.—An excellent five-place logarithm table by E. Sang, published by Blackwood; price is, I think, 4d. A seven-place table, published by Chambers, price 2s. 6d.; this is sufficient for all purposes. A very fine table by Sang of numbers up to 200,000, to seven places, published by Williams and Norgate, price £1 1s.

3rd. One of the most useful books for optical work is Barlow's tables, published by Spon, price 4s. 6d. It contains squares, cubes, square roots, cube roots, and reciprocals of all numbers up to 10,000.

A very fine but more elaborate reciprocal table is that of Oake's of all numbers from 1 to 100,000 to seven places. Published by Layton, price £1 1s.

Of these the smaller Fuller slide rule, Chambers' and Barlow's tables are sufficient for most practical purposes. For accurate work the larger Fuller slide rule is best, and Oake's reciprocal tables are very useful.

Doublet of no aberration. Refractive index = 1.50

$$\begin{aligned} \text{1st lens, crossed} \quad r &= + \cdot 291 \\ & \quad s = - 1.750 \quad f = + \cdot 5 \\ \text{2nd lens, bi-concave} \quad r &= - \cdot 683 \\ & \quad s = + 1.865 \quad f = - 1.0 \end{aligned}$$

Focus of the combination = + 1.0. Aberration = 0.

New doublet of minimum aberration. Refractive index = 1.50

$$\begin{aligned} \text{1st lens, crossed} \quad r &= + 1.166 \\ & \quad s = - 7.000 \quad f = + 2.0 \\ \text{2nd lens, meniscus} \quad r &= + \cdot 636 \\ & \quad s = + 1.750 \quad f = + 2.0 \end{aligned}$$

Focus of combination = + 1.0

$$\text{Aberration} = - \cdot 214 \frac{y^2}{F}$$

Best form of chromatic doublet for a microscope Bull's eye. Boro-Silicate crown. Jena Catalogue O. 144. Refractive index 1.51

$$\begin{aligned} \text{1st lens, crossed} \quad r &= + 2.359 \\ & \quad s = - 15.078 \quad \text{diameter } 2.1 \\ \text{2nd lens, meniscus} \quad r &= + 1.280 \\ & \quad s = + 3.434 \quad \text{diameter } 1.8 \end{aligned}$$

Distance between lenses .05; equivalent focus 2.0; back focus 1.55; total aberration - .103; clear aperture 2.0; angle 62°. Note the second Gauss point of the combination is close to the posterior surface of the crossed lens.

This combination is eminently suitable for photomicrography in those cases where a Bull's eye is necessary.

## USE OF ORDINARY BINOCULAR FOR DISSECTING.

By JOHN TATHAM, M.A., M.D.

*(Read December 20, 1895.)*

For many years past I have been trying to hit upon some simple method of using the stereoscopic binocular instrument for purposes of dissection, and of mounting slides for the microscope, because I have repeatedly found that the use of the best simple microscope for long periods does seriously impair the sensitiveness of the retina for observation with the compound instrument.

I have brought with me the stand which I now employ. It is a very small binocular, on the Rousselet model, and is fitted with a rack-work substage. Into this substage is fitted a brass ring carrying a plate, or supplementary stage, of the form now shown. This supplementary stage is made of exactly the same width as the principal stage of the microscope, and the sliding object carrier of the latter is made to slide easily over the supplementary stage. The object of this arrangement will be shown hereafter. When used for dissecting or mounting, the instrument is placed in the vertical position, on a table only so high as is necessary to allow of work in a sitting posture. A low power, say an inch, two inch or three inch, is screwed into the nose-piece. The objective is then racked down through the aperture of the principal stage, and is focussed on the object lying on the supplementary stage already described, a bullseye condenser, of the aplanatic form suggested by Mr. Nelson, being used in the case of opaque objects.

Two wedges, or inclined planes of wood, are arranged as supports for the wrists, one on either side the microscope, or in default of these a couple of thick books can be similarly used.

It only remains to be said that with the above simple arrangement, which certainly is not an expensive one, any small binocular can readily be converted into a dissecting microscope, or a mounting instrument, or it can be used with a four-inch or lower power, for the examination of animal or vegetable forms

in sea water; and thus, the mechanical adjustments of one's larger and more delicate instrument are preserved from harm.

The advantages that may be claimed for this "adaptation," which by the way may possibly be as well known to some others as to myself, are as follows:—

1. The use of the *simple* form of microscope, with all the discomforts incidental thereto, is avoided, and the binocular is available in place of the single tube.

2. The same "hack" microscope may be used, either for ordinary high power work or for dissecting purposes, by simply transferring the object and the sliding clip from the ordinary to the supplementary stage.

3. An instrument of relatively small size, and consequently with short rack work, may be used with long focus lenses, which otherwise can only be used in connection with full-sized stands.

4. An instrument such as the one I show this evening can be used with very great comfort in the sitting posture, with the arms and wrists resting on the inclining planes above described. This would be impracticable with a full-sized stand racked up so as to focus a three or four-inch power on an object lying on the ordinary stage.

---

## NOTE ON AN OPTICAL RULE.

By EDWARD M. NELSON, F.R.M.S.

*(Read December 20th, 1895.)*

The rule is made of box, is 20 inches long and square in section. On one face there is a scale of inches and tenths, and on the opposite side centimetres and millimetres. On one of the sides at right angles to these is a scale of dioptrics marked D, and on the remaining side opposite to it is a new scale of powers marked P. All the scales read from the same end and are ruled on both edges of the rod. This is important, because any two contiguous scales can be read and compared together; thus dioptrics can be converted into inches by the inspection of one edge of the rod, and into centimetres by viewing the other, and *vice versâ*. On the opposite face of the rod the scale of powers can be treated in a similar manner. The following are some examples of the use of the rule:—

(1.) When the focus of a lens is measured on the P side of the rule, its magnifying power, when the eye is held at the back principal focus, is indicated. By adding one to this figure the power, when the eye is held close to the lens, is found; but if one be subtracted from it, the enlargement of an image on a screen distant 10 inches from the lens is given. Example: A lens measures four on the P side of the rule; this will be its magnifying power when the eye is held at the back principal focus of the lens. Its power, when the eye is held close to the lens, will therefore be five, and an image projected on a screen distant 10 inches from the lens will be enlarged three times.

(2.) When the power of any lens is known, its focal length can be determined by inspection, either in inches or mm. Thus a lens of two-power has a focal length of five inches or 127 mm.

(3.) The focal length of a diverging lens can be easily found by overpowering it with a converging lens and measuring the power of the combination; this power, less the power of the



converging lens, is the power of the diverging lens. Its focal length can then be determined in either inches or mm. by inspection. Example: The power of a double concave, when combined with a bi-convex, is 0.85, as measured on the P side of the rule. The power of the bi-convex alone is 3.0; then 0.85, minus 3.0, equals minus 2.15. The focal length of the double concave is therefore minus 4.65 inches or 118 mm., these being the figures in a line with 2.15 on the rod.

(4.) The rule is very useful as a ready reckoner. Example (a): A lens of  $8\frac{1}{2}$  inches focus is combined with one of 94 mm. focus—required the power and focus of the combination in inches and mm.;  $8\frac{1}{2}$  inches is in a line with 1.175 P, and 94 mm. in a line with 2.7 P. The power of the combination is, therefore, 1.175, plus 2.7, equals 3.875; this is in a line with 2.58 inches and 65.3 mm., the foci required. Example (b): I have a lens 178 mm. focus—what must be the focal length of the lens in inches that added to it will yield a power of 5? In a line with 178 mm. is 1.425 P; then 5 minus 1.425 equals 3.575, the power of the lens required; this is in a line with 2.8 inches, which is its focal length.

THOMAS HUGHES BUFFHAM.

BORN DECEMBER, 1840; DIED FEBRUARY, 1896.

Every member will, we are sure, learn with the utmost regret of the loss the Club has sustained by the death of Mr. T. H. Buffham, A.L.S., which occurred on February 9th.

Born and educated at Long Sutton, Lincolnshire, in early life he entered business in a small country town where he remained until he became manager of the concern. During this period he became greatly interested in Astronomy, and possessing a good telescope he did some excellent work on double and coloured stars, many of his observations being recorded in the "Astronomical Notices" and other periodicals. On removing to London his health began to fail, and he was compelled to give up night work with the telescope and turned his attention to the microscope, joining the Quekett Club in 1877. Starting, as most amateurs do, without any fixed plan he simply employed the instrument in a general way until on a visit to Teignmouth in 1881, when finding an alga with antheridia, not described in Harvey's work, he soon found how much remained unknown in this department, and took up the study of the marine algæ in earnest. Having received much help from the Club in his early microscopical days he considered that it had the first claim on anything he produced, and thus the larger part of his work has appeared in the pages of this Journal, some other papers being published in "Grevillea" and the "Journal of Botany." Mr. Buffham was a man of great intellectual capacity and wide reading, and when it is considered how much he accomplished, in spite of the anxieties involved in the management of a large business, joined to persistent bad health following a most serious illness, this affords the highest testimony to his unremitting energy, perseverance and strength of will. His removal is a serious loss to us all and will long be felt.

As an appendix to the above, I have been permitted to subjoin a few remarks upon the services rendered by our late regretted colleague, Mr. T. H. Buffham, to algological science, in which my chief purpose has been to make his labours in their entirety better known. It was the reproductive organs of the Florideæ which mainly attracted the attention of our deceased friend. In a large number of these algæ the fecundating organs, that is to say the antheridia or, as they are designated by Schmitz, the spermatangia, were either unknown or imperfectly described. Mr. Buffham had the repeated good fortune to collect many species provided with the male apparatus, and his descriptions of them are to be found in four memoirs published in the Journal of this Club between the years 1884 and 1893. ("Journ. Q.M.C.," Ser. II., Vol. i., p. 337-344, Plates X.-XII. [1884]; Vol. iii., p. 257-266, Plates XX.-XXII. [1888]; Vol. iv. p. 246-253, Plates XV.-XVI. [1891]; Vol. v., p. 291-305, Plates XIII. XIV. [1893].) Amongst the species in which Mr. Buffham has represented the spermatangia may be mentioned the following, arranged in the chronological order of the publications in which these organs are illustrated:—I. (1884). *Callithamnion tetricum*, *Callith. byssoides*, *Spermothamnion Turneri*, *Antithamnion plumula*, *Griffithsia corallina*, *Ptilota elegans*, *Ceramium diaphanum*, *Ceramium strictum*; II. (1888). *Helminthora divaricata*, *Callithamnion brachiatum*, *Ceramium tenuissimum*, *Spyridia filamentosa*, *Delesseria Hypoglossum*, *Catenella Opuntia*, *Lomentaria reflexa*, *Chondriopsis tenuissima*, *Rhodomela subfusca*, *Dasya coccinea*, *Bostrychia scorpioides*; III. (1890). *Griffithsia barbata*, *Lomentaria kalifornis*, *Chondriopsis dasyphylla*, *Plocamium coccineum*, *Phyllophora membranifolia*; IV. (1893). *Choreocolax polysiphonice*, *Harveyella mirabilis*, *Phyllophora rubens*, *Cystoclonium purpurascens*, *Sphærococcus coronopifolius*, *Gracilaria confervoides*, *Rhodymenia palmata*, *Rhodym. palmetta*, *Lomentaria articulata*, *Nitophyllum Gmelini*, *Delesseria alata*, *Deless. ruscifolia*, *Hydrolapathum sanguineum*, *Bonnemaisonia asparagoides*, *Odonthalia dentata*, *Halarachnion ligulatum*.

Besides the spermatangia of the species given above and figured by him, Mr. Buffham has furnished us with a description of the male organs (in a certain number of species), in which the morphological type corresponds with those of some of the forms illustrated. He succeeds perfectly in making us

recognise the extreme utility which an intimate acquaintance with the spermatangial form affords in facilitating the systematology of the red algæ, and this according to a method most nearly allied to nature. In another communication ("Journ. Q.M.C.," Ser. II., Vol. v., p. 24 26, Plate III. [1892]) Mr. Buffham described and figured a new species of *Chantransia* epiphytic on *Cladophora*—*Chantransia trifila*, which, he says, must be the smallest Floridean known, its height being only 27-30  $\mu$ . In the same number of the Journal our learned friend, who had already in 1885 studied the conjugation of *Rhabdonema arcuatum* ("Journ. Q.M.C.," Ser. II., Vol. ii., p. 131), described the phenomena of reproduction in another marine diatom, *Orthoneis binotata*, Grun., which, in its mode of multiplication, conforms to Smith's first type, in which "we have two parent frustles and two sporangia (*i.e.*, sporangial frustles) as the result of their conjugation" ("Brit. Diat.," II., p. xii.). Whatever doubts may still be entertained, in spite of the labours of Pfitzer, Petit, Schmitz,\* Castracane, Schuett, and others as to the physiology of reproduction in the Diatomaceæ, we are persuaded that these contributions on the subject by our late friend are of remarkable interest. Mr. Buffham has also given proofs of his activity as a conscientious observer of the brown sea-weeds. Here again it is to the reproductive organs that he has for the most part directed his investigations, giving us several notes on the plurilocular zoosporangia of *Asperococcus bullosus*, Lamour, and of a plant which he attributed to *Myriotrichia clavæformis*, Harv. ("Jour. of Botany," Nov., 1891, plate 314), but which Mr. Batters has recently found advisable to distinguish from the genuine species of Harvey. Our late colleague discovered a new species of *Ectocarpus* (Algol. Notes, "Grevillea," March, 1893), which has now been placed in the genus *Giffordia*, erected by Mr. Batters, as *Giffordia padinæ*; he has likewise given some details on the plurilocular sporangia of *Chorda filum*. Amongst the Chlorophyceæ he studied the conjugation of the zoogametes in *Cladophora lanosa*, Ktz., and the formation of the spermatia in *Prasiola stipitata*, Suhr., a most interesting observation, which has been brought into prominence by F. Schmitz ("Nuova

\* Cf. G. B. De-Toni, "Alla memoria di Federico Schmitz, Cenni biografici." "Nuova Notarisia," vi., 1895, p. 62-3.

Notarisia," v., 1894, p. 717). According to this latter author, who has also been unexpectedly removed by death, the formation of these spermatia greatly resemble those of the genera *Bangia*, *Porphyra* and *Wildemannia*, and appear to have a special bearing on the definitive systematic position of the Bangiaceæ.

This sketch of Mr. Buffham's career as an algologist, compressed as needs must be into a few lines, gives us the impression of great originality. Apart from the works here enumerated, the remembrance of our regretted colleague will survive by the dedication to him of a new genus, *Buffhamia*, which Mr. Batters has recently erected in honour of him whose loss we all deplore.

DR. G. B. DE-TONI, PADUA.

---

## PROCEEDINGS.

OCTOBER 18TH, 1895.—ORDINARY MEETING.

E. M. NELSON, Esq., F.R.M.S., President, in the Chair.

The minutes of the preceding meeting were read and confirmed.

The following gentlemen were balloted for and duly elected members of the Club:—Mr. Harold A. Baugh, Mr. William L. Bros.

The following donations were announced:—

- “Proceedings of the Manchester Microscopical Society.”
- “Proceedings of the Royal Society.”
- “Proceedings of the Belgian Microscopical Society.”
- ‘Proceedings of the Academy of Natural Sciences of Philadelphia.’
- “The Botanical Gazette.”
- The American Monthly Microscopical Journal.”
- ‘The Microscope.’
- ‘Proceedings of the Geologists’ Association.’
- “Proceedings of the Wagner Institute of Science.”
- “Studies in Artificial Cultures of Entomogenous Fungi.”
- ‘Manual of Histology,’ Scatterthwaite. }
- “Angiocarpous Lichens,” Ray Society. }
- “British Coleoptera,” Fowler. }
- “Microscopic Bacillaria,” Ehrenberg. }
- An account of the diatomaceæ from in and under the city of Mexico (copy formerly belonging to Dr. Bowerbank, and containing the autograph of Ehrenberg) } From the President.
- “Molluses and Brachiopoda,” Cambridge Natural History volume.
- “The Microscope, etc.,” by Lewis Wright.
- “Natural History of Aquatic Insects,” Prof. Miall.

The thanks of the meeting were voted to the donors, especially to the President for his valuable contribution to the library.

Mr. Swift exhibited a folding microscope made entirely of aluminium, the weight of which was about 2lb. as against 5½lb. for the same instrument in brass.

Mr. Goodwin inquired whether there was enough weight to keep the microscope steady.

The President said that he had often remarked that to ensure steadiness they must have a proper sized base. In continental instruments they got the steadiness by having a solid foot, and depended chiefly upon weight, but the one before them had such an enormous spread of foot that without being heavy it was absolutely steady.

Mr. Karop thought everyone would be pleased to see this microscope, which he believed was only the second which had been made entirely of aluminium. The difference in weight would be appreciated by those who wanted an instrument which they could carry about easily. He found that one of the chief donations to the Club that evening was one not mentioned in the list which had been read, and that was a further gift of 57 slides of Rotifers from Mr. Rousselet, bringing up the number already presented to 117. As a type series these slides would possess a unique value, and they were very greatly indebted to Mr. Rousselet for his valuable gift.

Mr. Karop exhibited on behalf of Mr. Curties a simple method of attaching microscope objectives, by which when the objective was placed in position a quarter turn sufficed to tighten it, or loosen it as the case might be. He felt sure the members would hear with very great regret that their friend Mr. Curties was at that moment lying very seriously ill.

Mr. Ingpen said he had used this method for some time, and found it extremely good; it sometimes happened that the three small projections did not at the moment catch the objective, but he had used a very similar contrivance designed by their President, and had found this also to be most satisfactory.

The President said he also had tried it, and thought it a useful nose-piece.

Mr. Richard Smith exhibited a microscope almost identical with that already shown by Mr. Swift except that the lower

portion was made of gun metal to ensure greater stability, whilst the upper part was of aluminium.

The President said it would be obvious that by making the lower part of a heavier metal the centre of gravity would be lowered and the steadiness consequently increased.

Mr. Goodwin exhibited a small microscope lamp, in which the chimney and reservoir were of metal. The chimney had two apertures, one closed by a coloured glass and the other by a piece of plain glass, either of which could be used by turning the lamp round. The weight of the lamp was only 3ozs., and though so small it was quite powerful enough for ordinary use, and held enough paraffin to burn about three hours. He found that for the wick nothing answered better than a piece of folded blotting-paper.

Mr. Karop inquired if the pieces of glass were turned into the metal of the chimney?

Mr. Goodwin said they were fitted into a small ring cap.

The President thought this was a charming little lamp; he suggested, however, that it would be improved by making the glass-covered apertures long shaped instead of round, so that a microscope could be worked direct without a mirror.

Mr. Ingpen thought the idea of using blotting-paper as a wick was an extremely good one. He had tried several thicknesses of tape with some success, but thought the blotting-paper likely to answer better.

The President said there was a new lamp just coming out, which was fitted with a carbon wick, one of the most extraordinary things about which was that if it was held at an angle of  $45^{\circ}$  it went out, so that under these conditions it was really a self-extinguishing lamp. Whilst on the subject of lamps, he might mention that the best he had ever met with was the Hitchcock mechanical lamp, which burnt without any chimney, the draught being supplied by the rotation of a rapidly revolving fan. It was supplied with a patent feeder, with which it could be filled without any risk of pouring over or of soiling the fingers, and the light it gave was most extraordinary; the wick was less than lin. wide, and as compared with one of Hink's duplex lamps the light was in the proportion of 14 to 18. It would be a great thing if they could get a lamp on this principle small enough for microscopical purposes.



Mr. R. T. Lewis said he had used these lamps for the last twenty years. They were made in New York, and he did his best to induce the maker to bring out one on a smaller scale, which he hoped to be able to adapt not only to the microscope but also as a miner's lamp. He had made designs for these about fifteen years ago, but could not get Hitchcock to take up the idea.

Mr. J. M. Offord said he had used one of these lamps for about fifteen years, and it was still in good order; for photomicrography it was a great success, certainly the best for the purpose he had ever made use of.

Mr. Goodwin inquired if the Welsbach incandescent gas light was of any use for this purpose.

The President said this was quite useless, since the image of it in the microscope was not a solid flame, but simply a number of red-hot lines. The incandescent electric lamp was also useless for the same reason, giving the image of the carbon filament.

The President gave an interesting account of some of the phenomena attending the production of false images in the microscope, and illustrated his remarks by drawings on the blackboard.

Mr. Ingpen inquired if the President had been able to get the same effects with the Abbe diffraction plate? He had been able himself to double and triple these images, but had never been able to halve them.

The President said he had never been able to halve them, although he had of course doubled them.

Mr. Vezey read an extract from a Brisbane newspaper relating to the bacteriological work carried on by their member, Mr. Pound, at the Stock Institute of S. Australia.

The usual announcements were then made, and the proceedings terminated.

---

OCTOBER 18TH, 1895.

Respiratory organs of <i>Dero</i>	...	...	Mr. W. Burton.
Dissections of <i>Linyphia</i> ..	...	...	Mr. H. Freeman.
<i>Pedalion mirum</i> (mounted)	...	...	Mr. C. Rousselet.

## NOVEMBER 1ST, 1895.

<i>Notommata collaris</i>	...	...	...	Mr. W. Burton.
<i>Nemesia strumosa</i> (seeds)	...	...	...	Mr. G. E. Mainland.
<i>Coscinodiscus elongus</i>	...	...	...	Mr. H. Morland.
<i>Cephalosiphon limnias</i>	...	...	...	Mr. C. F. Rousselet.

## NOVEMBER 15TH, 1895.—ORDINARY MEETING.

E. M. NELSON, Esq., F.R.M.S., President, in the Chair.

The minutes of the previous meeting were read and confirmed.

The following gentlemen were balloted for and elected members of the Club:—Mr. Alfred E. Hilton, Mr. J. Pillischer, Mr. Alfred J. Robertson.

The following donations to the Club were announced:—

Six Slides	...	...	...	...	From Mr. Hinton.
One Slide	...	...	...	...	From Mr. Dounou.
“The American Monthly Microscopical Journal”	...	...	...	}	In exchange.
“The Microscope”	...	...	...		
“Proceedings of the Portland (Maine) Society of Natural History”	...	...	...	}	”
“The Botanical Gazette”	...	...	...		
Recent Freshwater Diatoms from Lule Lappmark, Sweden	...	...	...	}	By Miss Cleve.

The thanks of the Club were unanimously voted to the donors.

Mr. Karop read a characteristic extract from the *Echo* on the natural history of Bats, in which, amongst other items, the vampire was referred to as a *reptile* having a stretch of wing of 5ft., and presumably penetrating the veins of its victim by the tip of its tongue.

Mr. Karop called attention to a Microtome by Reichert, which was exhibited in the room. So far as he had been able to examine it, he thought it seemed almost the same as Jung's, except that it was plated and got up in a somewhat better style. It was, no doubt, well adapted for cutting sections of frozen substances, but, as far as his experience went, it would not work well upon those which were imbedded in paraffin, for which a direct, rather than a sloping cut, was necessary.

Mr. Buffham read a paper "On a New Sea Weed found in Cornwall," *Bonnemaisonia hamifera*, Har., the subject being well illustrated by drawings and lantern slides.

The President being obliged to leave the meeting, the chair was taken by Mr. A. D. Michael, who expressed the hearty thanks of the Club to Mr. Buffham for his very interesting paper, furnished under difficult circumstances at short notice. How it was that these plants and even animals did somehow get across the seas and appear in places at great distances from their native habitats, was a matter which had often puzzled naturalists. As Mr. Buffham had suggested, it was quite possible that the spores might be carried with other things upon the bottoms of ships, and eventually get deposited in places which were favourable to their development, and he also thought it was very probable that they might sometimes be brought upon the feet of wading migratory birds, which often came from great distances. But whatever the cause might be, there could be no doubt that plants did sometimes turn up in a very remarkable manner at great distances from their known habitats, an instance of which occurred to him in the case of a spotted Arum, which was found growing in some profusion on a small rocky island off the coast of Corsica, and nowhere else nearer than South America.

The thanks of the meeting were unanimously voted to Mr. Buffham for his paper.

Mr. J. E. Ingpen read a note "On the Scent Hairs of Lepidoptera," illustrating the subject by drawings upon the board and specimens exhibited.

Mr. Karop said he should like to know upon what grounds these modified scales were regarded as scent-emitting organs. It was certainly true that on emerging from the chrysalis some few lepidoptera, sometimes the ♂, sometimes the ♀, were known to emit an evanescent odour which was reasonably supposed to attract the opposite sex. The phenomenon of "assembling," well-known to all entomologists, showed that in some cases at least there was an attractive influence which was very powerful and appeared to act at considerable distance, but were these hairs or scent patches found in every case where "assembling" was known to occur? Fritz Müller, he believed, was the first who drew attention to these hairs and indicated

their possible function, whilst Scudder had described some glandular structures which might produce the scent, but there did not seem much in either case which amounted to a proof. A *résumé* of the matter was given in a paper entitled "Secondary Sexual Characters in Lepidoptera," by J. W. Tutt, F.E.S. The subject was highly interesting and he should like to hear more from any entomologist who might have studied it.

Mr. Ingpen suggested that as the attractive scent seemed only to last a short time, might it not be due to something analogous to the pith found in the feathers of birds, which after a time became dried up.

Mr. Karop said there could be no possible homology between the structure of a bird's feather and that of an insect's scale.

The Chairman said the subject of insects' scales was a very elaborate question and too wide for them to go into on that occasion; indeed, he thought it was one which had been so well thrashed out that they would be likely to get very little to add to what was already known.

Mr. J. D. Hardy described a form of *Melicerta* found in his aquarium, the peculiarities of which he illustrated upon the board. He would be glad to hear from any of the members present if the species was new, as in that case he would try to find some more of the same kind.

Mr. Rousset had not seen anything similar to it, and should, therefore, be very glad to have a specimen for examination.

Mr. Neville said it was a common thing for *Melicerta* to have the lobes presented in the horizontal position described, and the condition of the tube was often due to the surroundings. As this specimen was found in an aquarium, it was possible that the difference observed in the pellets might in some way be due to a deficiency of ordinary material in the water.

Mr. Hardy said this was clearly not so in the present case, as he had a quantity of *Melicerta* in the aquarium of the common kind which were building their tubes quite in the ordinary way.

The thanks of the Club were voted to Mr. Ingpen and to Mr. Hardy for their communications.

Announcement of meetings for the ensuing month were made by the Secretary, and the proceedings terminated with the usual conversazione.

## NOVEMBER 15TH, 1895.

## Marine Algæ—

<i>Bonnemaisonia hamifera</i> , with procarps and abnormal cystocarps, from Fal- mouth, and a specimen with normal cystocarps, from Japan ...	}	Mr. T. H. Buffham.
— <i>Californica</i> , with procarps and cystocarps, from California...		
<i>Brachionus bidens</i> ... ..		Mr. W. Burton.
<i>Scaridium eudactylosum</i> ... ..		Mr. C. Rousselet.
<i>Arremurus globator</i> ... ..		Mr. C. D. Soar.

## DECEMBER 6TH, 1895.

<i>Trachelius ovum</i> ... ..		Mr. J. M. Allen.
<i>Euchlanis lyra</i> ... ..		Mr. W. Burton.
<i>Polysiphonia</i> , from Cromer ... ..		Mr. W. Goodwin.
Diatoms, Atlantic Ocean ... ..		Mr. G. E. Mainland.
<i>Coscinodiscus oblongus</i> ... ..		Mr. H. Morland.
<i>Microcodon clavus</i> ... ..		Mr. C. F. Rousselet.
<i>Nesæa decorata</i> ... ..		Mr. C. D. Soar.
<i>Euchlanis dilatata</i> ... ..		Mr. W. R. Traviss.

## DECEMBER 20TH, 1895.—ORDINARY MEETING.

E. M. NELSON, ESQ., F.R.M.S., President, in the Chair.

The minutes of the preceding meeting were read and confirmed.

The following gentlemen were balloted for and duly elected members of the Club:—Mr. W. C. Fullicks, Mr. Walter J. Wood.

The following donations were announced:—

“The Microscope” ... ..		From the Editor.
“The American Monthly Microscopical Journal” ... ..	}	” ”
“Le Diatomiste” ... ..		” ”
“Proceedings of the Belgian Micro- scopical Society” ... ..	}	” Society.
Three Slides of Mounted Rotifiers ...		Mr. Bilfinger per Mr. Rousselet.

The thanks of the Club were voted to the donors.

The Secretary said it would no doubt be remembered he had announced at a previous meeting that two nieces of the late Mr. J. G. Tatem had presented the Club with 1,000 slides of insect preparations in memory of their uncle. These had now been received, and the cabinet containing the slides was before the members in the room that evening. He felt they were greatly indebted to the Misses Harman for this very handsome donation.

Mr. C. L. Curties said the slides were preparations of the kind usually made by Mr. Tatem—entomological specimens and dissections—selected from a total number of about 3,000.

On the motion of the President a hearty vote of thanks was unanimously passed to the Misses Harman for their gift.

The President said there was at present no catalogue of these slides, but if anyone would volunteer to make one it would be rendering a very useful service.

Dr. Tatham exhibited a device for rendering the stereoscopic binocular microscope available for dissecting purposes, the advantage of which would be at once obvious. A brass ring with a plate formed a supplementary stage sufficiently large for the purpose.

Mr. Rousselet inquired if the principal stage could be removed so as to facilitate getting at the other.

Dr. Tatham said that this was hardly necessary as it could be got at quite readily.

Mr. Michael said he had very considerable experience in dissecting with the binocular, but the instrument before them would, he feared, be practically useless to him, owing to the fatal objection interposed by the principal stage which would block out the light and interfere with the hands, and for dissecting purposes the stage provided was inconveniently small. He entirely agreed with Dr. Tatham that a binocular must be used if there was much work to be done, but it must of necessity be used upright, and that meant a craning of the neck which was soon felt to be irksome. All this was avoided by using the Stephenson form, with which the head could be upright and the stage at the same time flat, but what was really wanted was a means by which they could dissect under a  $\frac{1}{2}$  in. in the case of delicate dissections. It was of course a great improvement to be able to use a binocular of this kind for dis-

secting purposes, because it so greatly relieved the strain upon the eyes, and his own view was that if anyone wanted to do practical dissection for serious work the Stephenson binocular was the most convenient form. He must, however, express his admiration at the ingenuity of this invention and of the way in which it had been carried out.

Mr. Karop thought the great obstacle to using an ordinary compound microscope for dissecting purposes was the inversion of the object and the transposition of the hands, which required considerable practice to overcome. The Stephenson form at least did away with this.

The President said that he gathered that Dr. Tatham did not put forward this device as an invention of a new dissecting microscope, but he brought it there as a makeshift, and he showed how an ordinary Rousselet portable travelling binocular might be pressed into service for dissecting purposes. Dr. Tatham's idea as far as he understood it was to supplement and not in any way to supersede existing dissecting microscopes which had been designed as such. For his own part he thought the Stephenson binocular on the whole the best designed form they could have for the purpose, because of its large stage and the comfortable position in which it could be used, but on the other hand he never saw a really good image with it, for this there was nothing like the Wenham up to  $\frac{2}{3}$  in. or  $\frac{1}{2}$  in. There were probably too many reflecting surfaces in the Stephenson form to give the same quality of image as they got in the Wenham. The main fault of the one before them seemed to be the non-removability of the upper stage, but he did not see why it should not be made removable.

Mr. Michael thought the greater objection was the reversal of the image. Some people did not appear to notice this, but to him the erect image was of the utmost importance.

Dr. Tatham said his object in bringing this design before the members was to show them something which he thought was likely to be of practical value. He did not pretend it to be in any way a substitute for Stephenson's, which was amongst other things very expensive. Personally he preferred the Wenham because he had always found that the increased number of surfaces had the effect of blurring the image, and for this reason he had never been able to enjoy using the

Stephenson. What he had brought before them was a simple adaptation to an ordinary microscope which only cost a few shillings and therefore was within reach of all. The objection taken by Mr. Michael would be of force if the stage was one of the ordinary kind, but this was so small, and of the horse-shoe form, so that any amount of light could get at the object. He had found it a very great convenience as a special adaptation to an ordinary microscope.

Mr. Swift said he made a Stephenson binocular for the late Mr. Tarn, which worked exceedingly well up to  $\frac{1}{8}$  in. Mr. Stephenson gave him the formula for two sets of prisms, one for high and one for low powers.

The President moved a vote of thanks to Dr. Tatham for bringing this matter before them. He was glad to hear that the Stephenson form had been made with two sets of prisms, as this would probably greatly improve its performance. His own experience with it had been unfortunately not very satisfactory; he had seen a good many binoculars, but never one so good as Wenham's.

Mr. Michael would not like to say that even in the finest instruments the Wenham was not the best, but when the Stephenson form was made as well as the Wenham, the result was far from unsatisfactory. The highest definition was not perhaps to be had with the Stephenson form, but for its working properties it was beyond all comparison the most desirable.

Mr. Nelson exhibited a Swift's portable microscope, and said that he would not detain the meeting by going over the points in this excellent design, which had been brought to their notice on a former occasion. He would, therefore, confine his remarks to what was novel in the instrument before them. The stage has been increased to a size of 5 in. in width and  $4\frac{1}{2}$  in. in depth. This extra depth allows the use of a long guide on the left hand side of the frictional mechanical stage. The body being fitted with three draw-tubes gives a range of adjustment of 8 in., namely, from  $4\frac{3}{4}$  in. to  $12\frac{3}{4}$  in. The case is not much increased in size, being 6 in. by  $5\frac{1}{2}$  in. by  $7\frac{3}{4}$  in. The fine adjustment is on the Campbell differential plan. The threads are cut to foreign gauges, on the metrical system, so that a revolution of the head indicates some integral fraction



of a millimetre of movement. The mirrors are burnished loosely in their settings, which allows them to be turned round to get rid of the multiple images. The weight of the instrument in its case is  $9\frac{3}{4}$  lbs.

Mr. Ingpen said he did not often refer to anything which Dr. Pigott did, but he certainly did achieve something in this direction, for he had a tube cut down to 3in. and had some sections of tube which fitted into it so that he got tube lengths of 3in., 6in., 9in., 12in., and 15in. on a Powell stand. It would be impossible to do this on many stands, but with a Powell it was done quite easily.

The President said he had a short and a long body which he could exchange as desired. He liked this telescopic arrangement of the tube with two draws and had found it perfectly satisfactory. He then read a note on a new optical rule which he had designed, and exhibited the same to the meeting and explained the way in which it was used.

A vote of thanks to the President for his communication was unanimously passed.

Mr. Goodwin inquired if the President would tell them what parts were measured to ascertain the tube length.

The President, by means of a drawing on the black-board, explained the difference between the mechanical and optical tube lengths.

Mr. Karop said they were to have had a lantern exhibition of photomicrographs by Mr. T. C. White, but he was unfortunately too unwell to be with them that evening as promised.

Announcements of meetings for the ensuing month were then made, special attention being called to the fact that at their next ordinary meeting nominations to fill vacancies upon the Committee would be asked for and an Auditor would have to be elected.

---

DECEMBER 20TH, 1895.

<i>Hydra viridis</i>	...	...	...	...	Mr. J. M. Allen.
<i>Euchlanis lyra</i>	...	...	...	...	Mr. W. Burton.
JOURN. Q. M. C., SERIES II., No. 38.					16

JANUARY 3RD, 1896.

<i>Asplanchna prodonta</i>	...	...	...	Mr. J. M. Allen.
<i>Plumularia similis</i>	...	...	...	Mr. F. Bedford.
<i>Perophora listeri</i>	...	...	...	"
<i>Palæmon</i> (Zoea)	...	...	...	Mr. G. T. Harris.
Foraminifera (type slides)	...	...	...	Mr. A. J. Jenkins.
<i>Pterotheca aculeifera</i>	...	...	...	Mr. H. Morland.

JANUARY 17TH, 1896.—ORDINARY MEETING.

E. M. NELSON, Esq., F.R.M.S., President, in the chair.

The minutes of the preceding meeting were read and confirmed.

Mr. Robert Sillar was balloted for and duly elected a member of the Club

The following additions to the library were announced:—

"The Cambridge Natural History,"	}	Purchased.
Vol. v., Peripatas—Myriapods— and Insects, Part I. ... ..		
"Proceedings of the Croydon Micro- scopical Society" ... ..	}	Purchased.
"Annals of Natural History" ... ..		
"The American Monthly Micro- scopical Journal" ... ..	}	Purchased.

The Secretary gave notice, on behalf of the Committee, that at the ensuing Annual Meeting it would be proposed to make a slight alteration in Rule VII., so far as regarded the last clause, which at present reads as follows:—"That any member omitting to pay his subscription six months after the same shall have become due (two applications in writing having been made by the Treasurer) shall cease to be a member of the Club." It was found that as no distinct power was given to remove the names from the list they often remained for a considerable time, and when arrears were applied for the Treasurer was told, "Oh, I did not know my name was still on the list as I had not paid my subscription," although Journals had been supplied as usual. It was therefore proposed to insert the words "That the Committee shall have power to remove the name of any member" omitting to pay his subscriptions, etc.

Mr. Hardy said it struck him that there might be some reason occasionally why a member had not paid. He might be away from home for instance, and it would be rather hard to have his name struck off in that case.

The President said the Committee would be able to use their discretion in such cases. What was desired was to give them the power of removing names if necessary.

Mr. Goodwin thought it would be well to suspend a member who had not paid up—without removing the name—so that he might be reinstated afterwards if he sent in his subscription.

The President pointed out that the rules already provided for the suspension of a member, but this was a notice of a proposed alteration that was before the meeting at present, and members were not in order in raising a discussion on the alteration of a Rule which was not before the meeting; they could, of course, discuss it when it came before them at the Annual Meeting.

The Secretary said that as the Annual Meeting would be held next month it would be necessary for the members to nominate four gentlemen to fill vacancies on the Committee, and also to elect one auditor.

The nominations made by the Committee were as follows:—As President, Mr. J. G. Waller; as Vice-Presidents, Messrs. Nelson, Dallinger, Michael, and Newton; the other officers as before; and as Auditor on behalf of the Committee, Mr. Chapman.

The following nominations were then made for members of Committee:—

Mr. J. E. Ingpen, proposed by Mr. T. C. White, seconded by Mr. R. T. Lewis.

Mr. Hembrey, proposed by Mr. Dunning, seconded by Mr. Powell.

Mr. Western, proposed by Mr. Allen, seconded by Mr. Jacques.

Mr. Scourfield, proposed by Mr. Southon, seconded by Mr. Tabor.

Mr. J. M. Allen was proposed by Mr. Burton, seconded by Mr. Soar, and duly elected Auditor on behalf of the members.

Mr. Orfeur exhibited and described a combination substage, which contained polariscope, selenites, iris diaphragm, tinted glasses, etc., fitted in such a way that either could be used with-

out removing any portion from the stage, whilst the whole fitting could be removed from the ring whenever this was desired.

Mr. Karop inquired what was the weight of this combination fitting. The object of it was, no doubt, a very useful one, to avoid the trouble and time usually required in changing the apparatus when fitted into the substage in the ordinary way; but he thought the difficulty here, as in some other cases, would be to get the stops as near as was desirable to the lower combination of the condenser.

Mr. Orfeur did not know what the weight of the whole fitting was, but it was in its present form the outcome of several attempts to carry out the idea he had in view. The weight could possibly be reduced if it were found necessary.

The President thought it was certainly a great advantage to have these things together, especially as regarded the stops, because it would prevent them from being lost or from getting left at home. They were greatly obliged to Mr. Orfeur for bringing the new arrangement to the meeting and showing it to the members.

The President exhibited another of his series of lenses, a triple achromatic with great working distance, extremely sharp in definition and flat in the field. It was made by Mr. Watson, and was a cemented Steinheil triplet.

Mr. Karop said it was really a splendid lens, sharp up to the very edge, and certainly one of the very best of the series.

A paper by Mr. Buffham was, owing to the unavoidable absence of the author, taken as read.

Mr. T. C. White exhibited on the screen a large number of photo-micrographs, giving a short explanation of the methods by which they had been taken, and pointing out anything of special interest in each picture as they were somewhat rapidly passed in review.

The President expressed the hearty thanks of the meeting to Mr. White for bringing down these slides and showing them in such a very beautiful and interesting way, the vote of thanks being carried by acclamation.

The following objects, etc., were afterwards exhibited.

<i>Plumatella repens</i> ...	...	...	...	Mr. W. Burton.
<i>Limnesia fulgida</i> (Koch)...	..	...	...	Mr. C. D. Soar.

FEBRUARY 7TH, 1896.

<i>Euchlanis pyriformis</i>	...	...	...	Mr. J. M. Allen.
<i>Stephanoceros Eichhornii</i>	...	...	...	Mr. W. Burton.
Section of an eye of a Butterfly	...	...	...	Mr. W. Goodwin.
<i>Corethra plumicornis</i> (pupa)	...	...	...	Mr. G. E. Mainland.
<i>Biddulphia rhombus</i> , var. <i>trigona</i>	...	...	...	Mr. H. Morland.
<i>Aulacodiscus orientalis</i>	...	...	...	Mr. J. C. Webb.

FEBRUARY 21ST, 1896.—ANNUAL MEETING.

E. M. NELSON, Esq., F.R.M.S., President, in the Chair.

The minutes of the preceding meeting were read and confirmed.

The following donations were announced:—

“La Nuova Notarisia”	...	...	...	In exchange.
“Proceedings of the Belgian Microscopical Society”	...	...	...	} ”
“Syllogie Algarum,” a complete list of the whole of the Fucaceæ up to the present time	...	...	...	

Mr. Karop said he had with very great regret to announce the death of one of their members, Mr. Buffham, which had occurred since their last meeting. It would be remembered that Mr. Buffham had been announced to read a paper, but that he was unable to be present at the last meeting, and consequently his communication was taken as read. There was no idea at the time that he was so near his end. His loss would be greatly felt, as he was recognised as one of the best workers they had upon the subject of the red seaweeds.

The President said they were very sorry to hear of Mr. Buffham's death. He had received the corrected proofs from him of the paper taken as read at the last meeting only a day or two before his death. He might also mention the death of Mr. Marryat, of Salisbury, who was an extremely good worker with the microscope, although not directly connected with any society. He had a letter from him only a short time ago enclosing some very beautiful photographs which he would hand round for inspection as the best memorial of the skill of his late friend; all these were taken with a  $\frac{1}{2}$  in. dry lens, and he thought it would be agreed that they were a great deal better done than many which

had been taken with the best oil immersions. Mr. Marryat was a man who never kept anything to himself, and no one ever approached him in vain who wanted any kind of information which it was in his power to afford.

Mr. Karop reminded the members that at their last meeting notice was given of a proposed alteration to Rule XII., so as to give the Council power to remove from the list of members the name of anyone whose subscription was in arrear, and to whom repeated applications had been unsuccessfully made. Having read the rule as it stood and also the proposed alteration, he moved that the alteration be made as suggested.

Mr. J. E. Ingpen seconded the proposal, and said that during his rather long experience of secretarial work in the Club he had found this was a weak spot in the rules, and did not at the time see his way to remedy it. He thought the difficulty would now be met by this alteration in a very satisfactory and happy manner.

The President then put the motion to the meeting and declared it carried unanimously.

The President having appointed Messrs. R. Macer and W. Burton to act as scrutineers, the ballot for Officers and Council for the ensuing year took place. The scrutineers having subsequently handed in their report, the President announced that the following gentlemen had been duly elected:—

<i>As President</i> ... ..	J. G. WALLER, F.S.A.
, <i>Four Vice-Presidents</i> {	E. M. NELSON, F.R.M.S.
	REV. W. H. DALLINGER, LL.D., F.R.S.
	A. D. MICHAEL, PRES. R.M.S.
	E. T. NEWTON, F.R.S.
, <i>Treasurer</i> ... ..	J. J. VEZEY, F.R.M.S.
, <i>Secretary</i> ... ..	G. C. KAROP, M.R.C.S., F.R.M.S.
, <i>Foreign Secretary</i> ...	C. ROUSSELET, F.R.M.S.
, <i>Reporter</i> ... ..	R. T. LEWIS, F.R.M.S.
, <i>Librarian</i> ... ..	ALPHEUS SMITH.
, <i>Curator</i> ... ..	E. T. BROWNE, B.A., F.R.M.S.
, <i>Editor</i> ... ..	E. M. NELSON, F.R.M.S.
<i>Four Members to fill Vacancies on the Committee.</i> {	F. W. HEMERY, F.R.M.S.
	J. E. INGPEN, F.R.M.S.
	D. J. SCOURFIELD.
	G. WESTERN, F.R.M.S.

The Secretary then read the 30th annual report.

The Treasurer read his annual statement of accounts, and presented the duly audited balance sheet, pointing out at the same time the difference in some items as compared with former years, and showing that some additional expense on account of the Journal had arisen from the greater number as well as the improved character of the plates.

Mr. Ingpen thought that no regret need be expressed as to the small additional cost of the Journal, which was well worth what had been spent upon it.

Mr. Measures having moved that the report and balance sheet be received and adopted,

Mr. Neville seconded the motion, and as representing those who had recently joined the Club, he wished to say how greatly they appreciated the advantages which it afforded them, and the pleasure they had derived from attendance at the meetings. In spite of the rival attractions of photography and cycling he had no fear that their hobby would become neglected, or their Club deserted. He thought it was also of great advantage to the members to have such a Journal as they possessed, and he entirely agreed that any money spent in that direction was well spent.

The motion was then put from the chair and carried unanimously.

The President then read his annual address (see p. 191).

Mr. A. D. Michael said he rose to express their thanks to their President for the interesting and valuable address to which they had just had the pleasure of listening. At the same time, as this was the last occasion on which they would have a Presidential Address from Mr. Nelson, he should like to couple with this a vote of thanks to him for his highly efficient services to the Club during the whole of the period that he had occupied the chair, and with an expression of regret that these services were not to be longer continued. He was not in any way intending to disparage an old friend who had been elected to succeed to the chair; they welcomed him cordially and would serve under him with pleasure, but they could not see the President of the last three years leave the chair without regret, and more especially that they were unable to see him leave it in better health than was the case at the present time. Their

thanks were heartily due to him for the ability with which he had managed their proceedings, and for the able way in which he had conducted the Journal, as well as for the many communications he had made in addition to his address that evening.

Mr. J. D. Hardy had very great pleasure in seconding the vote of thanks to the President, not only for his address, but also for the great efficiency of his services during his period of office. Looking upon what Mr. Nelson had done for microscopy he might say that no one had done more towards making it a science than he had by the character of the papers he had read, and the demonstrations he had given. He should like to suggest that it would be well if the whole of Mr. Nelson's communications on the subject could be collected and printed together in a separate form.

Mr. Michael said the President could not put this motion to the meeting himself; he therefore called upon them to carry it with hearty acclamation.

Mr. E. M. Nelson said he was extremely obliged to Mr. Michael and to Mr. Hardy and to all who had joined so cordially in carrying this vote of thanks, for the very kind way in which they had referred to the manner in which he had endeavoured to carry out duties which he only wished had been better performed. They knew quite well how fond he was of the pursuits which chiefly engaged their attention there, and his only desire had been to do all he could to promote an increased interest in the microscope, and to induce others to carry on the work in the most efficient possible ways. He felt quite sure that in the advances which had been made in this direction the Q.M.C. had been a great centre of influence in this country.

Mr. Nelson, in resigning his position to his successor, said:— I cannot vacate this chair without thanking both your officers and yourselves for the kindness and assistance I have received during the three years I have occupied it. Next month I enter my twentieth year of membership, and, looking back, I can see a steady and continuous improvement in the work done by this Club. A few years ago we passed through very hard times, but owing to the tact and management of your able Secretary, Mr. Karop, aided by the sound judgment of that veteran microscopist, Mr. Michael, who at the time was President, they were tided over. After this the affairs of the Club began to improve,



and the brilliant presidency of my predecessor, Dr. Dallinger, completely put an end to our period of depression. It was therefore in auspicious times that I took my seat here, and I trust that no act of mine has in any way retarded this forward current. It is with great pleasure that I now hand over the chair to my friend Mr. Waller. Mr. Waller, you must know, became a member of this Club three years after it was started; he therefore requires no introduction from me, but as a member of your Committee I can witness that for many years this Club has greatly benefited by his counsel and advice, no less than by his ever ready assistance. It was Mr. Waller who housed a large part of your library when we were turned out at Gower Street, thereby relieving your Librarian and Committee of much anxiety. In bidding you adieu, let me say that the prosperity of this Club is in your hands; your officers may do all they can, but it is the effort of each individual member that has achieved what has been done in the past, and to which the future must be entrusted.

Mr. J. G. Waller then took his seat as President, and was heartily cheered by the members on so doing. He said he must express to them his thanks for the honour they had done him, and his desire to do all that he could to further the interests of the Club. He must also express his thanks to Mr. Nelson for the very kind way in which he had referred to him, and was only sorry to note the condition of his health, which he sincerely hoped would be speedily restored.

A vote of thanks to the Auditors and Scrutineers was moved by Mr. Powell, seconded by Mr. Southon, and carried unanimously.

Mr. H. Groves then moved that the best thanks of the Club be given to the Officers and Committee for their services during the past year, and in a humorous speech recounted the indebtedness of the members to the various officers, to whom he referred seriatim. To their Secretary he felt sure all would feel specially indebted for the arduous work he had performed for the benefit of all, and whose tact and skill were, perhaps, best manifested by the general smoothness with which everything had worked. He had seen something of what these duties involved, and sincerely hoped that the success of the Club would continue to be assured by the continued performance of these

duties by their indefatigable friend Mr. Karop, to whom they owed so much.

Mr. J. M. Allen having seconded the motion, it was put to the meeting by the President, and unanimously carried.

Mr. Karop said it always fell to his lot to return thanks on behalf of the Officers and Committee, and in doing so he could only assure the members of the Club that it was a matter of the greatest pleasure to do all they could to advance its interests, and so long as they were able to do this to the satisfaction of the members it would give them great pleasure to continue their efforts in this direction.

---

## THIRTIETH ANNUAL REPORT OF COMMITTEE.

At the end of another year your Committee is again in a position to present a favourable account of the Club's affairs

During the twelve months ending December, 1895, twenty-nine new members were elected, a slight increase on the number for the previous year. By resignation and death our losses amount to twenty-five. Amongst the latter are two past Presidents, viz., Prof. Huxley and Mr. A. Durham, and two distinguished Honorary Members, Prof. Williamson and Mr. F. Kitton, and our former esteemed Treasurer, Mr. F. W. Gay.

The attendance at the meetings has been remarkably good, showing an average at the ordinary business nights of 52, and at the conversational meetings of 27. This is distinctly encouraging and goes to prove that, in spite of the recent popularity of certain other branches of science and art, microscopy still holds attractions for many.

The chief communications at the meetings have been as follows :—

Jan.	“ On the Preservation of Rotifers,” 2nd } paper... ..	Mr. Rousselet.
Feb.	“ President's Address ”... ..	Mr. Nelson.
Mar.	“ On a New Floscule ”... ..	Dr. Pittock.
„	“ What was the Amician Test ? ”	Mr. Karop.
Apr.	“ On a New Species of Aleurodes ”	Mr. Lewis.
„	“ On Bacteria from Thames Foul-water ”	Mr. Shadbolt.
„	“ Roots and Growths upon them ”	Mr. Green.
May	“ On an Aquatic Hymenopterous Insect ”	Mr. Burton.
„	“ On Scale Evolution ”... ..	Mr. Inghen.
„	“ Idem ”... ..	Mr. Nunney.
June	“ On Pyrenean Plants ”	Mr. Reed.
Sept.	“ On Diplois Trigona, etc. ” ... ..	Mr. Rousselet.
„	“ On the Entomostraca of North Wales ”	Mr. Scourfield.
Nov.	“ On Bonnemaisonia hamifera, Har. ”	Mr. Buffham.

Besides these papers a number of informal communications

were given on specimens, methods, and apparatus which provoked useful discussions and comments. An abstract of these will be found in the Proceedings.

The Cabinet has been enriched by the following donations :—

Mr. Rousselet...	...	...	...	66
Mr. Hinton ...	...	...	...	6
Mr. Daunou ...	...	...	...	1
Mr. Bilfinger ...	...	...	...	6
—				
Total ...			...	79

Deserving particular mention is the series of mounted Rotifers presented mainly by Mr. Rousselet. As every member knows, the art of preserving these fragile organisms in a life-like manner is the discovery of this gentleman, and in course of time we may now look forward to possessing a more or less complete collection which will be invaluable for reference and study. The chief addition, however, is the gift by the Misses Harman of a handsome cabinet containing 1,000 specimens, mostly entomological, prepared by their uncle, the late Mr. J. G. Tatem of Reading, who was for twenty years a member of the Club. His skill as a mounter was very considerable, and when arranged and catalogued this extensive collection will be of great service. The best thanks of the Club are due to the Misses Harman for their most kind and valuable benefaction, which was intended and will be kept as a memorial of their late relative.

The following books and periodicals, acquired by gift, purchase, or exchange, have been added to the library :—

Wright, L., "Handbook to the Microscope"	From the Author.
Braithwaite, Dr. R., "British Moss Flora,"	} " "
Part 16 ... ..	
Lankester, Prof. Ray, Zoological articles	} Mr. J. J. Vesey.
contributed to "Encyclopædia Britan-	
nica" (reprint) ... ..	
Latterthwaite's "Manual of Histology"...	Mr. E. M. Nelson.
Leighton's "Angiocarpous Lichens" ...	"
Fowler's "British Coleoptera" ... ..	"
Ehrenberg's "Microscopic Bacillaria" ...	"
Miall, Prof., "Natural History of Aquatic	} Publishers.
Insects" .. ..	

Lowie, Prof. B. T., "Anatomy, etc., of the Blow Fly," Part 6 ... ..	}	Purchased.
"Cambridge Natural History—Mollusca"		"
"Cambridge Natural History—Insects," Part 1 ... ..	}	"
"Quarterly Journal of Microscopical Science" ... ..		"
"Annals and Magazine of Natural History"		"
"Grevillea" ... ..		"
Buckton's "Larvæ of British Butterflies and Moths," Vol. vi. ... ..	}	Ray Society.
"Journal of the Royal Microscopical Society" ... ..		}
"Proceedings of the Royal Society" ...		
"La Nuova Notarisia" ... ..		"
"Le Diatomiste" ... ..		"
"International Journal of Microscopy" ...		"
"American Botanical Gazette" ... ..		"
"American Monthly Microscopical Journal"		"
"The Microscope" ... ..		"
"Essex Naturalist" ... ..		"
Proceedings of various Societies and sundry Pamphlets ... ..	}	"
		"

The usual two numbers of the Journal have been issued and posted to all members whose subscriptions are not in arrear. The October part was exceptionally heavy in both letterpress and plates, and the expenses of its production for the year have therefore somewhat exceeded the average. On the other hand the revenue accruing from advertisements has increased, being £24 4s., as compared with £15 19s. 6d. last year. For this welcome addition the Club is chiefly indebted to the kind offices of Mr. Rousselet.

The financial position of the Club does not call for any detailed reference, though attention may be drawn to one or two items. The subscriptions received last year amount to only £152, as against £173 in 1894. This is partly accounted for by the fact of there being a large sum collected for arrears in the latter year, but a great part of the difference is due to non-payment. This is greatly to be regretted, and with a merely nominal subscription like ours should not occur. It is sincerely

hoped that the good sense of members will not allow this state of things to continue, as, putting it on no higher grounds, it imposes a very heavy task on the Hon. Treasurer, as well as considerable expense to the Club itself for postage and stationery. The other items of extra expenditure over the previous year are in the Journal account and for bookbinding, which is included in the amount for purchase of property.

The excursions last season were very well attended, and although the dry weather had somewhat reduced the water in the ponds, a few new, rare, or interesting organisms were obtained, which will be found recorded in the November Journal.

Your Committee beg to thank the officers of the Club for their continued and indispensable services in their several departments.

In conclusion the Committee venture to express the hope and belief that in spite of periods of elevation and depression, which appear to be inevitable in scientific matters as in other human concerns, the Quekett Club will continue to carry on its work in the present year based upon the best traditions of the thirty which have preceded it.

# QUEKETT MICROSCOPICAL CLUB.

*Treasurer's Statement of Accounts for the Year ending 31st December, 1895.*

Dr.	£	s.	d.	Cr.	£	s.	d.		
To Balance from 1894	...	...	174	17	11	...	54	12	0
" Subscriptions received in 1895	...	...	152	0	0	...	116	14	7
" Dividends on Investments	...	...	5	6	4	...	4	19	11
" Sale of Journals	...	...	20	14	7	...	6	9	2
" Sale of Catalogues	...	...	2	1	0	...	6	0	0
" Receipts for Advertisements	...	...	24	4	0	...	17	7	8
			£379	3	10		170	3	6
							£379	3	10

Moneys invested in £2 15s. Per Cent. Consols, £200.

We have examined the above statement of Income and Expenditure, and compared the same with the Vouchers in the possession of the Treasurer, and find the same to be correct.

24th JANUARY, 1896.

J. J. VEZEY,  
Hon. Treasurer.

W. INGRAM CHAPMAN, }  
J. MASON ALLEN, }  
Auditors.

## Q.M.C. EXCURSIONS, 1895.

Reference Numbers.	Dates.	Localities.	Number of Members of the Q.M.C. attending.	Number of Members of other Societies attending.	Number of Visitors.	Totals.
1	March 23	Snaresbrook... ..	21	1	—	22
2	April 6	Ealing ... ..	11	1	—	12
3	„ 20	Royal Botanic Gardens ...	42	5	18	65
4	May 4	Totteridge ... ..	18	—	2	20
5	„ 18	Staines .. ..	9	—	1	10
6	June 8	Enfield ... ..	15	—	—	15
7	„ 22	Woking ... ..	8	1	—	9
8	July 6	Hertford Heath ... ..	9	—	1	10
9	„ 20	Whitstable ... ..	10	—	2	12
10	Sept. 7	Chingford ... ..	5	—	—	5
11	„ 21	Oxshott ... ..	9	1	2	12
12	Oct. 5	Keston ... ..	11	—	1	12

Names of members who sent lists of objects found by them:—

B. Burton, W.	Sch. Scherren, H.
C. Culshaw, Rev. Geo. H.	Sc. Scourfield, D. J.
Da. Dadswell, Ed.	S. Soar, C. D.
Dk. Dick, J.	So. Southon, W. H.
M. Measures, J. W.	T. Turner, C.
P. Parsons, F. A.	Wb. Webb, J. C.
R. Rousselet, C. F.	W. Western, G.



## LIST OF OBJECTS FOUND ON THE EXCURSIONS.

NOTE.—The numbers following the names of the objects indicate the excursions upon which they were found, and the letters indicate the names of the members recording the same. When an object is frequently recorded the names of the members are omitted.

CRYPTOGAMIA. *ALGÆ.*

<i>Chætophora elegans</i> . . . . .	4, Dk.
„ <i>endivæfolia</i> . . . . .	5, W.
<i>Draparnaldia glomerata</i> . . . . .	4, W.
<i>Eudorina elegans</i> . . . . .	1, 2, 3, 4, W.
<i>Gloiotrichia pisum</i> . . . . .	5, W.
<i>Gonium pectorale</i> . . . . .	1, W.; 3, Dk.; 4, B., Dk.; 6, 7, Dk.
<i>Nostoc commune</i> . . . . .	4, 5, W.
<i>Oscillaria tenuis</i> . . . . .	7, T.
<i>Pandorina morum</i> . . . . .	3, Dk.; 4, B.; 5, W.; 6, 7, Dk.
<i>Pediastrum Boryanum</i> . . . . .	1, C.; 3, 4, 7, Dk.
„ <i>granulatum</i> . . . . .	7, T.; 12, B.
„ <i>pertusum</i> . . . . .	10, P.
<i>Protococcus viridis</i> . . . . .	12, B.
<i>Raphidium falcatum</i> = <i>Ankistrodes-</i> <i>mus falcatus</i> . . . . .	3, Dk.
<i>Scenedesmus acutus</i> . . . . .	10, P.
„ <i>quadricauda</i> . . . . .	3, Dk., Sch.; 4, Dk.; 7, T.; 10, P.
<i>Spirogyra nitida</i> . . . . .	3, 4, Dk.
<i>Spirulina oscillariodes</i> . . . . .	12, B.
<i>Staurospermum quadratum</i> (in conj.)	4, B.
<i>Volvox aureus</i> , Ehr. = <i>V. minor</i> . Stein. . . . .	11, M.
<i>Volvox globator</i> . . . . .	1, 3, 4, 5, 11.
<i>Zygnema cruciatum</i> . . . . .	3, 4, Dk.

## DESMIDIACEÆ.

<i>Closterium lunula</i> . . . . .	3, 4, 6, 8, 11, 12.
„ <i>moniliferum</i> . . . . .	3, 6, Dk.; 11, M.
„ <i>setaceum</i> . . . . .	1, C.; 11, M.

<i>Closterium striolatum</i>	. . .	. 1, C.
<i>Docidium baculum</i>	. . .	. 8, T.; 12 B.
<i>Micrasterias denticulata</i>	. . .	. 1, W.; 11, M.
,, <i>rotata</i>	. . .	. 1, C.; 4, Dk.; 8, T.
<i>Staurastrum gracile</i>	. . .	. 1, W.

## DIATOMACEÆ.

<i>Cocconema lanceolatum</i>	. . .	. 3, 4, 6, Dk.
<i>Diatoma vulgare</i>	. . .	. 3, 4, 6, Dk.
<i>Epithemia turgida</i>	. . .	. 1, W.
<i>Gomphonema acuminatum</i>	. . .	. 3, 4, Dk.
<i>Meridion circulare</i>	. . .	. 2, W.
<i>Navicula rhomboides</i>	. . .	. 4, Dk.
<i>Pinnularia nobilis</i>	. . .	. 3, 4, Dk.
<i>Pleurosigma attenuatum</i>	. . .	. 4, Dk.
<i>Synedra radians</i>	. . .	. 3, 4, Dk.

## CHARACEÆ.

<i>Chara fragilis</i>	. . .	. 6, Da.
<i>Nitella flexilis</i>	. . .	. 6, 7, Da.

## PROTOZOA.

<i>Acineta mystacina</i>	. . .	. 3, Dk., Sch.; 6, Dk.
<i>Actinophrys sol.</i>	. . .	. 1, 2, 3, 4, 6, 7.
<i>Actinosphærium Eichhornii</i>	. . .	. 1, 2, W.; 3, Dk., Sch., W.; 4, 7, Dk.
<i>Ægyria oliva</i>	. . .	. 2, W.
<i>Amœba diffluens</i>	. . .	. 3, Dk.
,, <i>radiosa</i>	. . .	. 3, B.
<i>Amphileptus anuser</i>	. . .	. 2, W.; 4, Dk.
,, <i>flagellatus</i>	. . .	. 1, C.; 7, Dk., 12, P.
,, <i>gigas</i>	. . .	. 3, Sch.
,, <i>meleagris</i>	. . .	. 7, Dk.
<i>Anthophysa vegetans</i>	. . .	. 3, B.; 5, P.; 12, B.
<i>Arcella dentata</i>	. . .	. 6, Dk., T.; 8, T.; 11, W.
,, <i>vulgaris</i>	. . .	. 1, 3, 4, 5, 6, 7, 11, 12.
<i>Archerina Boltoni</i>	. . .	. 11, W.
<i>Blepharisma lateritia</i>	. . .	. 2, W.
<i>Bursaria truncatella</i>	. . .	. 1, T.; 3, Sch., T.; 4, T.; 11, P.; 12, B., T.
<i>Carchesium polypinum</i>	. . .	. 1, B.; 3, B., Dk., Sch.; 6, 7, Dk.

<i>Centropyxis aculeata</i> = <i>Arcella</i>	
<i>aculeata</i> . . . . .	7, Dk. ; 11, W.
<i>Coleps amphacanthus</i> . . . . .	8, T.
„ <i>hirtus</i> . . . . .	1, 2, 3, 4, 6, 7, 8.
<i>Condylostoma patens</i> . . . . .	2, 3, W.
„ <i>stagnale</i> . . . . .	1, W. ; 3, B. ; 4, T. ; 11, P.
<i>Cothurnia imberbis</i> . . . . .	1, C. ; 3, B., Dk. Sch., T. ; 4, Dk. ; 6, Dk., T. ; 7, Dk.
<i>Dendrosoma radians</i> . . . . .	11, W.
<i>Diffugia globulosa</i> . . . . .	5, W. ; 6, 8, T. ; 11, M.
„ <i>oblonga</i> . . . . .	6, 8, T.
„ <i>proteiformis</i> . . . . .	1, C. ; 6, 7, Dk.
„ <i>pyriformis</i> . . . . .	4, Dk. ; 6, Dk., T. ; 11, M. ; 12, B.
„ <i>spiralis</i> . . . . .	11, W.
<i>Didinium nasutum</i> . . . . .	4, P.
<i>Dimastigoaulax cornutus</i> . . . . .	5, 11, W.
<i>Dinobryon sertularia</i> . . . . .	1, 2, 3, 4, 5, 6, 7, 8.
<i>Enchelys pupa</i> . . . . .	7, Dk.
<i>Epipyxis utriculus</i> . . . . .	3, 6, Dk.
<i>Epistylis anastatica</i> . . . . .	1, C. ; 7, Dk.
„ <i>flavicans</i> = <i>E. grandis</i> . . . . .	2, W. ; 3, B., Sch. ; 6, Dk.
<i>Euglena acus</i> . . . . .	4, P.
„ <i>viridis</i> . . . . .	1, 3, 4, 6, 7, 12.
<i>Euglypha ciliata</i> . . . . .	11, M.
<i>Euplotes patella</i> . . . . .	1, C. ; 2, W. ; 3, B., W. ; 6, 7, Dk.
<i>Gymnodinium fuscum</i> = <i>Peridinium</i>	
<i>fuscum</i> . . . . .	3, 4, 12, B.
<i>Gyrocoris oxyura</i> . . . . .	6, P.
<i>Litonotus fasciola</i> = <i>Amphileptus</i>	
<i>fasciola</i> , and <i>Dileptus folium</i> . . . . .	6, Dk., T.
<i>Loxophyllum meleagris</i> . . . . .	1, 2, W. ; 3, Sch., W. ; 5, P.
<i>Nassula ornata</i> . . . . .	11, W.
<i>Noctiluca miliaris</i> . . . . .	9, P.
<i>Opercularia nutans</i> . . . . .	3, Sch.
<i>Ophrydium versatile</i> . . . . .	5, W. ; 6, T.
<i>Paramecium aurelia</i> . . . . .	3, Sch., Wb. ; 4, W. ; 6, T. ; 11, W.

<i>Pelomyxa palustris</i> . . . . .	12, P.
<i>Peridinium tabulatum</i> = <i>P. cinctum</i> .	1, B., W.; 4, 5, W.; 11, M., W.
<i>Phacus longicaudus</i> . . . . .	3, B.; 7, Dk.; 8, P.
„ <i>pyrum</i> . . . . .	7, Dk.
<i>Pyxicola affinis</i> . . . . .	3, P.
„ <i>Carteri</i> . . . . .	3, P.
<i>Raphidiophrys elegans</i> . . . . .	8, P.
<i>Rhipododendron Huxleyi</i> . . . . .	11, P.
<i>Spirostomum ambiguum</i> . . . . .	4, 6, T.; 12, B.
<i>Stentor Barretti</i> . . . . .	4, P.
„ <i>cæruleus</i> . . . . .	5, P.
„ <i>niger</i> . . . . .	1, B., T.; 2, T., W.; 6, 8, T.
„ <i>polymorphus</i> = <i>S. Mülleri</i>	1, 2, 3, 4, 5, 6, 8, 12.
<i>Stichotricha remex</i> . . . . .	1, P.; 2, W.; 3, P.; 12, B.
<i>Stylonichia mytilus</i> . . . . .	2, W.; 3, Dk., Sch.; 7, Dk.; 11, P.
<i>Synura uvella</i> . . . . .	1, 2, 4, 5, W.
<i>Thuricola valvata</i> . . . . .	3, Sch.
<i>Trachelius ovum</i> . . . . .	2, W.; 3, Sch.; 6, Dk.; 8, T.; 10, 11, P.
<i>Trachelocerca olor</i> = <i>T. viridis</i> .	2, P.; 3, Dk., Sch. 4, 7, Dk.
<i>Trichodina pediculus</i> . . . . .	4, 6, Dk.; 11, P.*
<i>Urocentrum turbo</i> . . . . .	6, P.
<i>Uroglena volvox</i> . . . . .	1, 2, W.
<i>Uroleptus piscis</i> . . . . .	1, W.
<i>Uronechia transfuga</i> . . . . .	9, P.
<i>Vaginicola crystallina</i> . . . . .	1, 3, 4, 5, 6, 12.
<i>Vorticella campanula</i> . . . . .	5, W.
„ <i>chlorostigma</i> . . . . .	5, W.; 11, T.
„ <i>microstoma</i> . . . . .	3, 4, 6, 7, Dk.
„ <i>nebulifera</i> . . . . .	1, 3, 4, 6, 7, 12.
„ <i>striata</i> . . . . .	11, P.
<i>Zoothamnium arbuscula</i> . . . . .	1, B.; 11, T.
<b>CŒLEENTERATA. HYDROZOA.</b>	
<i>Coryne pusilla</i> . . . . .	9, P.
„ <i>vaginata</i> . . . . .	9, P.

\* *Trichodina pediculus* on *Synchæta pectinata*.

- Hydra fusca . . . . . 10, P.  
 „ viridis . . . . . 10, P.; 12, B.  
 „ vulgaris . . . . . 12, B.  
 Plumularia similis . . . . . 9, P.
- CTENOPHORA.*
- Beroe fulgens . . . . . 9, P.  
 Pleurobrachia pileus . . . . . 9, P.
- VERMES. ROTIFERA.*
- Actinurus neptunius . . . . . 4, 6, T.  
 Adineta vaga . . . . . 1, W.; 7, T., W.  
 Anuræa aculeata . . . . . 1, 3, 4, 5, 6, 8, 10.  
 „ „ var. brevispina . . . . . 1, 2, 4, 5, 6, 8, 10, 12.  
 „ „ „ valga . . . . . 1, R., W.; 5, W.; 7, R.;  
 8, R., W.; 12, W.  
 „ cochlearis . . . . . 1, 3, 4, 5, 6, 7, 8, 10, 11.  
 „ curvicornis . . . . . 1, 2, 3, 4, 8, 11, 12.  
 „ hypelasma . . . . . 6, R.; 8, R., W.; 11,  
 12, W.  
 „ schista . . . . . 5, T.  
 „ serrulata . . . . . 1, R., T., W.; 11, W.  
 „ tecta . . . . . 1, T.; 4, So., W.; 6, R.;  
 7, W.; 8, So.
- Anapus ovalis . . . . . 5, R.  
 Ascomorpha ecaudis = Sacculus viridis 1, R., T.; 4, B., T., W.;  
 8, R., T., W.; 12, T.  
 „ saltans = „ saltans 8, R.
- Asplanchna Brightwellii . . . . . 1, R.; 3, R., Sch., So.,  
 W.; 5, R.; 8, P.; 11,  
 W.  
 „ „ ♂ . . . . . 3, So.  
 „ priodonta . . . . . 2, 3, 5, 6, 7, 10, 11.  
 „ „ ♂ . . . . . 10, P.
- Brachionus angularis . . . . . 1, 2, 3, 4, 5, 6, 8, 10, 11.  
 „ „ ♂ . . . . . 3, R.  
 „ Bakeri . . . . . 6, R., T.; 8, R., W.; 11,  
 W.  
 „ pala . . . . . 1, 3, 4, 6, 11.  
 „ „ ♂ . . . . . 3, R., So.  
 „ „ var. amphiceros . . . . . 3, P.; 7, Dk.; 11, P.

<i>Brachionus quadratus</i>	. . . . .	3, W.
„ <i>rubens</i>	. . . . .	3, 5, 7, 8, 10, 11.
„ <i>urceolaris</i>	. . . . .	2, 3, 4, 5, 6, 7, 8, 11.
<i>Callidina elegans</i>	. . . . .	7, W.
„ <i>parasitica</i>	. . . . .	11, W.
<i>Cathypna luna</i>	. . . . .	5, 6, 7, 8, 11, 12.
„ <i>rusticula</i>	. . . . .	6, R.
„ <i>sulcata</i>	. . . . .	7, P.
<i>Cephalosiphon limnias</i>	. . . . .	3, Sch.; 8, P.
<i>Chromogaster testudo</i>	. . . . .	4, 5, W.; 8, R., W.; 11, W.
<i>Cœlopus brachyurus</i>	. . . . .	1, R.; 2, W.; 4, R. W. 8, 11, 12, W.
„ <i>porcellus</i>	. . . . .	2, 4, P.; 5, W.
„ <i>tenuior</i>	. . . . .	4, B.; 11, W.
<i>Colurus bicuspidatus</i>	. . . . .	1, 2, 4, 5, 6, 8.
„ <i>caudatus</i>	. . . . .	4, B.
„ <i>deflexus</i>	. . . . .	6, R.*; 12, B.
„ <i>obtusus</i>	. . . . .	2, 11, W.
<i>Conochilus dossuarius</i>	. . . . .	12, P.
„ <i>unicornis</i>	. . . . .	12, B., T.
„ <i>volvox</i>	. . . . .	7, P.; 11, M., T., W.
<i>Copeus caudatus</i>	. . . . .	4, B.
„ <i>cerberus</i>	. . . . .	8, R.; 11, W.
„ <i>Ehrenbergii</i> = <i>C. labiatus</i> (Gosse)	. . . . .	4, So.
<i>Copeus pachyurus</i>	. . . . .	2, P.; 4, 8, R.; 10, P.; 11, T., W.
<i>Diaschiza exigua</i>	. . . . .	1, R., W.; 5, 7, W.
„ <i>globata</i>	. . . . .	1, 2, W.
„ <i>Hoodii</i>	. . . . .	4, R.
„ <i>pæta</i>	. . . . .	12, W.
„ <i>semi-aperta</i>	. . . . .	1, 4, R., W.; 5, W.
„ „ ♂	. . . . .	1, W.
<i>Diglena biraphis</i>	. . . . .	11, W.
„ <i>catellina</i>	. . . . .	1, T.; 8, W.
„ <i>caudata</i>	. . . . .	12, B.
„ <i>dromius</i> (Glascott)	. . . . .	11, W.

\* *C. lurus deflexus*, with two frontal eyes.

<i>Diglena forcipita</i>	. . . . .	. 1, T. ; 2, W. ; 3, T. ; 5, 11, W.
„ <i>grandis</i>	. . . . .	. 2, W.
„ <i>rosa</i>	. . . . .	. 1, T.
„ <i>uncinata</i>	. . . . .	. 11, W.
<i>Dinocharis pocillum</i>	. . . . .	. 2, 4, 5, 6, 7, 8.
„ <i>tetractis</i>	. . . . .	. 1, 2, 4, 5, 6, 8, 10, 11.
<i>Diplois trigona</i> (Rousselet) n.s.	. . . . .	. 2, R., W.
<i>Distyla flexilis</i>	. . . . .	. 1, 3, 11, W.
„ <i>striata</i>	. . . . .	. 11, W.
<i>Elosa Worrallii</i>	. . . . .	. 7, W.
<i>Eosphora aurita</i>	. . . . .	. 1, 2, 5, 8, 11, 12.
<i>Euchlanis deflexa</i>	. . . . .	. 3, 4, B. ; 8, So.
„ <i>dilatata</i>	. . . . .	. 2, T. ; 3, Sch., T. ; 5, So., T. ; 7, T.
„ <i>hyalina</i>	. . . . .	. 5, R.
„ <i>parva</i>	. . . . .	. 4, 5, 6, R.
„ <i>pyriformis</i>	. . . . .	. 3, T.
„ <i>subversa</i> (Bryce) = <i>Dip-</i> <i>lois propatula</i> (Gosse)	. . . . .	. 3, B.
„ <i>triquetra</i>	. . . . .	. 1, R., W. ; 3, B. ; 4, T. ; 5, R., So., T., W.
<i>Floscularia ambigua</i>	. . . . .	. 4, R. ; 11, W.
„ <i>campanulata</i>	. . . . .	. 1, C., W. ; 5, W.
„ <i>cornuta</i>	. . . . .	. 1, 2, 3, 4, 5, 10, 11.
„ <i>coronetta</i>	. . . . .	. 1, 11, W.
„ <i>cyclops</i>	. . . . .	. 11, W.
„ <i>edentata</i>	. . . . .	. 11, P.
„ <i>ornata</i>	. . . . .	. 1, B. ; 3, B., Dk., T. ; 4, 7, Dk. ; 11, W.
„ <i>trilobata</i>	. . . . .	. 11, P.
<i>Furcularia ensifera</i>	. . . . .	. 2, T.
„ <i>forficula</i>	. . . . .	. 1, T. ; 3, T. W. ; 6, P.
„ <i>gracilis</i>	. . . . .	. 2, 5, W. ; 8, R., W. ; 12, W.
„ <i>longiseta</i>	. . . . .	. 1, 2, T., W. ; 3, R. ; 4, W. ; 5, R. ; 8, T. ; 11, W.
„ „ <i>var. grandis</i> (Tessin-Butzow)	. . . . .	. 8, R., W.
„ <i>megalocephala</i> (Glascott)	. . . . .	. 4, R.

<i>Furcularia micropus</i>	. . . . .	12, B.
<i>Hydatina senta</i>	. . . . .	2, W.
<i>Lacinularia socialis</i>	. . . . .	7, Da.
<i>Limnias annulatus</i>	. . . . .	3, W.
„ <i>ceratophylli</i>	. . . . .	3, B., Dk., Sch.; 6, Dk., T.; 7, Da.; 12, B.
„ <i>myriophylli</i> (Western) =		
<i>Limnioides myriophylli</i> (Tatem)	. . . . .	11, M., W.
<i>Mastigocerca bicornis</i>	. . . . .	1, R.; 4, T., W.; 5, W.; 12, B.
„ <i>bicristata</i>	. . . . .	4, 5, 11, W.
„ <i>carinata</i>	. . . . .	4, T.; 5, R., T., W.; 8, So.
„ <i>elongata</i>	. . . . .	8, T.
„ <i>rattus</i>	. . . . .	1, 2, 3, 4, 5, 6, 8, 11.
„ <i>scipio</i>	. . . . .	11, W.
„ <i>stylata</i>	. . . . .	4, 8, So.
<i>Melicerta conifera</i>	. . . . .	1, B., C., R., T.; 2, W.; 8, T., W.; 10, P.; 11, W.
„ <i>janus</i>	. . . . .	11, W.
„ <i>ringens</i>	. . . . .	1, 3, 4, 6, 7.
„ <i>tubicolaria</i>	. . . . .	8, W.
<i>Metopidia acuminata</i>	. . . . .	1, 3, 4, 5, 8, 11.
„ <i>lepadella</i>	. . . . .	1, T.; 2, W.; 4, So.; 5, T., W.; 6, R.; 8, W.
„ <i>oxysternum</i>	. . . . .	2, R., W.; 4, So., T., W.; 6, R.
„ <i>solidus</i>	. . . . .	1, W.; 2, R.; 3, B.; 4, B., R.; 5, 8, R.; 11, W.
„ <i>triptera</i>	. . . . .	5, W.
<i>Microcodides doliaris</i> (Rousselet) n. s.	. . . . .	8, R., W.; 11, W.
„ <i>orbiculodiscus</i>	. . . . .	1, W.; 4, P.
<i>Monostyla bulla</i>	. . . . .	6, R.
„ <i>cornuta</i>	. . . . .	4, So.
„ <i>lunaris</i>	. . . . .	1, W.; 8, So.
„ <i>quadridentata</i>	. . . . .	3, So.
<i>Noteus quadricornis</i>	. . . . .	4, So., T.; 5, R.; 6, T.; 8, P.; 12, B.
<i>Notholca acuminata</i>	. . . . .	2, T., W.; 5, R., T., W.
„ <i>heptodon</i>	. . . . .	5, W.



Notholca scapha . . . . .	. 1, 2, R., W. ; 3, B., R., W.
Notommata ansata . . . . .	. 1, T.
"    aurita . . . . .	. 1, T. ; 3, R. ; 4, B., R., W. ; 5, P. ; 6, R.
"    brachyota . . . . .	. 1, W.
"    cyrtopus . . . . .	. 1, R.
"    forcipita . . . . .	. 2, W.
"    lacinulata . . . . .	. 1, R., W. ; 2, T., W. ; 3, Sch., W. ; 4, 5, T., W. ; 7, T.
"    naïas . . . . .	. 2, R., W.
"    saccigera . . . . .	. 1, R., W. ; 11, T.
"    tripus . . . . .	. 1, T. ; 5, P.
Notops brachionus . . . . .	. 1, B., R. ; 4, R., So., W. ; 8, R., So., T., W. ; 10, P. ; 12, W.
"    clavulatus . . . . .	. 8, R.
"    hyptopus . . . . .	. 1, B., R., T. W. ; 2, R., W. ; 4, B., R., So., T., W. ; 8, R., T., W. ; 11, W.
"    "    ♂ . . . . .	. 1, R.
"    minor . . . . .	. 1, R., W. ; 2, T. ; 4, 11, W.
Œcistes crystallinus . . . . .	. 3, B., Sch, So.
"    longicornis . . . . .	. 1, W. ; 3, P.
"    mucicola . . . . .	. 6, R.
"    pilula . . . . .	. 11, M., T., W.
"    stygis . . . . .	. 1, R., W.
Pedalion mirum . . . . .	. 8, R., So., W. ; 11, W. 12, B. W.
Philodina aculeata . . . . .	. 2, W.
"    citrina . . . . .	. 2, W. ; 3, T., W., 6, P. ; 7, W. ; 11, P.
"    macrostyla . . . . .	. 7, W.
"    megalotrocha . . . . .	. 3, B., So., W. ; 6, P. ; 7, W.
Polyarthra platyptera . . . . .	. 1, 2, 3, 4, 5, 6, R.* ; 7, 8, 10, 11, 12.
Pompholyx complanata . . . . .	. 4, W.

\* Polyarthra platyptera, with fertilised resting eggs.

<i>Pompholyx sulcata</i> . . . . .	10, P. ; 12, B.
<i>Proales decipiens</i> . . . . .	3, R.
„ <i>felis</i> . . . . .	1, W. ; 2, T. ; 11, W.
„ <i>gibba</i> . . . . .	1, T.
„ <i>parasita</i> . . . . .	3, Dk. ; 4, B., Dk., So.
„ <i>petromyzon</i> . . . . .	1, 3, T. ; 5, R.*
„ <i>sordida</i> . . . . .	8, W.
„ <i>tigridia</i> . . . . .	11, T.
<i>Pterodina patina</i> . . . . .	3, Dk. ; 4, W. ; 5, P ; 6, Dk., R., T. ; 8, T. W. ; 11, M.
„ <i>reflexa</i> . . . . .	2, W.
„ <i>truncata</i> . . . . .	3, R.
<i>Rattulus bicornis</i> (Western) . . . . .	7, W.
<i>Rhinops vitrea</i> . . . . .	4, R., W.
<i>Rotifer macroceros</i> . . . . .	1, R., W. ; 5, W. ; 6, P. ; 8, W. ; 11, T., W.
„ <i>macrurus</i> . . . . .	1, W. ; 3, So., W. ; 4, So. ; 8, R.
„ <i>mento</i> ? . . . . .	11, P.
„ <i>tardus</i> . . . . .	2, T., W. ; 8, T. ; 11, W. ; 12, B.
„ <i>vulgaris</i> . . . . .	1, 2, 3, 4, 5, 6, 7, 8, 11.
<i>Salpina brevispina</i> . . . . .	4, R. ; 5, R., So., W. ; 6, R. ; 11, P.
„ <i>eustala</i> . . . . .	8, W.
„ <i>macracantha</i> . . . . .	6, T.
„ <i>marina</i> . . . . .	1, W.
„ <i>mucronata</i> . . . . .	2, 4, 5, 6, 8, 11.
„ <i>mutica</i> . . . . .	1, 2, R.
„ <i>spinigera</i> . . . . .	4, B.
„ <i>sulcata</i> . . . . .	8, W.
<i>Scaridium longicaudum</i> . . . . .	2, T., W.
<i>Stephanoceros Eichhornii</i> . . . . .	1, B., C., R., W. ; 3, W. ; 4, Dk.
<i>Stephanops lamellaris</i> . . . . .	2, 3, T. ; 4, R. T.
<i>Synchaeta longipes</i> . . . . .	7, W.
„ <i>pectinata</i> . . . . .	1, 2, 3, 4, 5, 6, 7, 8, 10, 11.

\* *Proales petromyzon* in *volvax*.

Synchaeta tremula . . . . .	1, 2, 3, 4, 5, 6, 7, 8.
Taphrocampa annulosa . . . . .	1, 5, 11, W.
„ Saundersiæ . . . . .	2, 4, W.; 8, P.; 11, 12, W.
Triarthra breviseta . . . . .	11, M.
„ longiseta . . . . .	3, 4, 6, 8, 10, 11, 12.
Triphylus lacustris . . . . .	8, R.; 11, W.
<i>GASTROTRICHA.</i>	
Chaetonotus hystrix . . . . .	11, W.
„ larus . . . . .	3, 4, B.; 6, Dk.; 8, T.; 12, B.
„ maximus . . . . .	8, T.
Dasydytes fusiformis . . . . .	12, B.
„ goniathrix . . . . .	6, T.; 11, W.; 12, B.
<i>PLATYHELMINTHES, Turbellaria.</i>	
Planaria lactea . . . . .	1, 12, B.
„ nigra . . . . .	1, B.
<i>ANNELIDA.</i>	
Leucodore ciliatus . . . . .	9, P.
<i>ARTHROPODA. CRUSTACEA.</i>	
Gammarus locusta . . . . .	9, P.
Jæra Nordmanni . . . . .	9, P.
<i>ENTOMOSTRACA.</i>	
Alona guttata . . . . .	1, 11.
„ intermedia . . . . .	10, 11.
„ quadrangularis . . . . .	1.
Alonella excisa . . . . .	10, 11.
„ nana . . . . .	1, 10.
Bosmina cornuta* . . . . .	3, 10.
„ longirostris . . . . .	1, B., Sc.; 3, B., Dk., Sch., Sc.; 12, B.
Candona pubescens . . . . .	3, Sc.
Canthocamptus pygmæus . . . . .	11, Sc.
„ staphylinus = C.	
„ minutus . . . . .	1, C., Sc.; 3, B., Dk., Sch., Sc.; 4, B.; 5, W.; 11, Sc.; 12, B.

\* *Bosmina cornuta* has been included in former lists with *B. longirostris*.

<i>Ceriodaphnia megops</i>	. . .	. 10, 11, Sc.	
„ <i>quadrangula</i>	. . .	. 10, 11, Sc.	
„ <i>reticulata</i> = <i>Daphnia</i>			
<i>reticulata</i>	. . .	. 5, W. ; 11, Sc. ; 12, B.	
<i>Chydorus latus</i> = <i>C. ovalis</i>	. . .	. 11, Sc.	
„ <i>sphericus</i>	. . .	. 1, Sc. ; 3, B., Sch., Sc. ; 4,	
		B. ; 10, 11, Sc. ; 12, B.	
<i>Cyclops albidus</i> = <i>C. tenuicornis</i>	. . .	. 1, C. ; 3, 11, Sc.	
„ <i>bicuspidatus</i>	. . .	. 1, 3, 11.	} Sc.
„ <i>bisetosus</i>	. . .	. 1.	
„ <i>fimbriatus</i>	. . .	. 1.	
„ <i>languidus</i>	. . .	. 1.	
„ <i>Leuckarti</i> = <i>C. simplex</i>	. . .	. 3, 10, 11.	
„ <i>prasinus</i> = <i>C. magnoctavus</i>	. . .	. 10.	
„ <i>phaleratus</i>	. . .	. 3.	
„ <i>serrulatus</i>	. . .	. 1, 3, 10, 11.	
„ <i>strenuus</i>	. . .	. 10.	
„ „ <i>vicinus form</i>	. . .	. 3.	
„ <i>vernalis</i>	. . .	. 1, 11.	
„ <i>viridis</i> , var. <i>brevicornis</i>	. . .	. 1, 10.	
„ „ „ <i>gigas</i>	. . .	. 1, Sc. ; 3, B. ; 10, 11, Sc.	
<i>Cypria ophthalmica</i>	. . .	. 1, 10.	} Sc.
„ <i>serena</i>	. . .	. 1, 3, 11.	
<i>Cypridopsis vidua</i>	. . .	. 1.	
<i>Cypris fuscata</i>	. . .	. 1, 11.	
„ <i>vireus</i> = <i>tristriata</i>	. . .	. 1, C. ; 5, W. ; 10, Sc.	
<i>Daphnella brachyura</i> = <i>D. Wingii</i>	. . .	. 5, W.	
<i>Daphnia hyalina</i>	. . .	. 10, Sc.	
„ <i>longispina</i>	. . .	. 3, Sc.	
„ <i>pulex</i>	. . .	. 1, C., Sc. ; 3, Dk., Wb. ;	
		4, Dk. ; 11, Sc.	
„ <i>Schæfferi</i>	. . .	. 4, Dk. ; 10, Sc.	
<i>Diaptomus castor</i>	. . .	. 1, B., C., Sc. ; 4, B. W. ;	
		5, W. ; 12, B.	
„ <i>gracilis</i>	. . .	. 3, Sch., Sc. ; 10, Sc.	
<i>Eurycerus lamellatus</i>	. . .	. 12, B.	
<i>Graptoleberis testudinaria</i>	. . .	. 11, Sc.	
<i>Hyoeryptus sordidus</i>	. . .	. 1, Sc. ; 3, B., Sc. : 10, Sc.	
<i>Hyoeypris gibba</i>	. . .	. 3, 10.	} Sc.
<i>Leydigia acanthocercoides</i>	. . .	. 1, 3.	
<i>Macrothrix laticornis</i>	. . .	. 1, 10.	

Polyphemus pediculus . . . . .	7, P.
Scapholeberis mucronata = Daphnia	
mucronata . . . . .	10, Sc.
Sida crystallina . . . . .	7, P.
Simocephalus exspinosus . . . . .	10, 11, Sc.
,,    vetulus . . . . .	3, 11, Sc.

## ARACHNIDA. Acarina.

## HYDRACHNIDÆ.

Arrenurus caudatus ♂ . . . . .	5.	} So.
,,    ,,    ♀ . . . . .	1.	
,,    emarginator ♂ ♀ . . . . .	6.	
,,    globator ♂ . . . . .	4, 5, 6, 11.	
,,    ,,    ♀ . . . . .	4, 6, 11.	
,,    maculator ♂ ♀ . . . . .	1, 11.	
,,    sinuator ♂ . . . . .	11.	
,,    tubulator ♀ . . . . .	2.	
Atax, sp. . . . .	6.	
Axona versicolor ♂ ♀ . . . . .	4, 5, 7.	
Diplodontus, sp. . . . .	5.	
Eylais extendens . . . . .	6.	
Hydrachna geographica ♂ ♀ . . . . .	1.	
Hydrodroma umbrata . . . . .	11.	
Hygrobates rufifrons ♀ . . . . .	7.	
Limnesia fulgida ♀ . . . . .	4, 6, 11.	
,,    sp. ♀ and nymph . . . . .	11.	
Limnochares holosericeus . . . . .	5.	
Marica musculus . . . . .	11.	
Nesæa carnea ♀ . . . . .	5.	
,,    decorata ♂ . . . . .	11.	
,,    longicornis ♂ ♀ . . . . .	5.	
,,    mirabilis ♀ . . . . .	6.	
Piona affinis ♂ ♀ . . . . .	5.	
,,    ovata ♀ . . . . .	5.	

## ARTISCONIDÆ.

Macrobiotus Hufelandi . . . . .	2, 4, 5, 7, 8, P.
---------------------------------	-------------------

## INSECTA. Diptera.

Corethra plumicornis, larva of . . . . .	1, B.; 4, Dk.; 12, B.
Tanypus maculatus, ,, . . . . .	12, B.

## HYMENOPTERA.

*Polynema natans* (Lubbock) . . . 4, B.

## NEUROPTERA

*Sialis lutaris*, larva of . . . 12, B.

## MOLLUSCOIDA. Polyzoa.

*Bowerbankia citrina* . . . 9, P.

*Fredericella sultana* . . . 1, W.; 3, B., Dk., Wb.,  
W.; 7, Da.

*Membranipora pilosa* . . . 9, P.

*Paludicella Ehrenbergii* . . . 3, B.

*Plumatella repens* . . . 3, B., Sch., Wb.; 11, M.

*Valkeria uva*, var. *cuscuta* . . . 9, P.

## MOLLUSCA.

*Chiton*, sp. . . . 9, P.

*Scyllæa pelagica* . . . 9, P.

FREDK. A. PARSONS,

Hon. Sec. Excursions Sub-Committee.

# Quekett Microscopical Club.

---

## R U L E S .

I.—That the Quekett Microscopical Club hold its Meetings at 20, Hanover Square, W., on the third Friday Evening in every month, except July and August, at Eight o'clock precisely, or at such other time or place as the Committee may appoint.

II.—That the business of the Club be conducted by a Committee, consisting of a President, four Vice-Presidents, an Honorary Treasurer, one or more Honorary Secretaries, an Honorary Secretary for Foreign Correspondence, an Honorary Reporter, an Honorary Librarian, an Honorary Curator, an Honorary Editor, and twelve other Members—six to form a quorum. That the President, Vice-Presidents, Treasurer, Secretaries, Reporter, Librarian, Curator, Editor, and the four senior Members of the Committee (by election) retire annually, but be eligible for re-election. That the Committee may appoint a stipendiary Assistant-Secretary, who shall be subject to its direction.

III.—That at the ordinary Meeting in January nominations be made of Candidates to fill the offices of President, Vice-Presidents, Treasurer, Secretaries, Reporter, Librarian, Curator, Editor, and vacancies on the Committee. That the President, Vice-Presidents, Treasurer, Secretaries, Reporter, Librarian, Curator, and Editor be nominated by the Committee. That the nominations for Members of Committee be made by the Members on resolutions duly moved and seconded, no Member being entitled to propose more than one Candidate. That a list of all nominations made as above be printed upon the ballot paper; the nominations for vacancies upon the Committee being arranged in such order as shall be determined by lot, as drawn by the President and Secretary. That at the Annual General Meeting in February all the above Officers be elected by ballot from the Candidates named in the lists, but any Member is at liberty to substitute on his ballot paper any other name or names in lieu of those nominated for the offices of President, Vice-Presidents, Treasurer, Secretaries, Reporter, Librarian, Curator, and Editor,

IV.—That in the absence of the President and Vice-Presidents the Members present at any ordinary Meeting of the Club elect a Chairman for that evening.

V.—That every Candidate for Membership be proposed by two or more Members, who shall sign a certificate (see Appendix) in recommendation of him—one of the proposers from personal knowledge. The certificate shall be read from the chair, and the Candidate therein recommended balloted for at the following Meeting. Three black balls to exclude.

VI.—That the Club include not more than twenty Honorary Members, elected by the Members by ballot upon the recommendation of the Committee.

VII.—That the Annual Subscription be Ten Shillings, payable in advance on the 1st of January, but that any Member elected in November or December be exempt from subscription until the following January. That any Member desirous of compounding for his future subscription may do so at any time by payment of the sum of Ten Pounds; all such sums to be duly invested in such manner as the Committee shall think fit. That no person be entitled to the full privileges of the Club until his subscription shall have been paid; and the Committee shall have power to remove from the List of Members the name of any Member who shall have omitted to pay his subscription six months after the same shall have become due (two applications in writing having been made by the Treasurer).

VIII.—That the accounts of the Club be audited by two Members, to be appointed at the ordinary Meeting in January.

IX.—That the Annual General Meeting be held on the third Friday in February, at which the Report of the Committee on the affairs of the Club, and the Balance Sheet, duly signed by the Auditors, shall be read. Printed lists of Members nominated for election as President, Vice-Presidents, Treasurer, Secretaries, Reporter, Librarian, Curator, Editor, and Members of the Committee having been distributed, and the Chairman having appointed two or more Members to act as Scrutineers, the Meeting shall then proceed to ballot. If from any cause these elections, or any of them, do not take place at this Meeting, they shall be made at the next ordinary Meeting of the Club.



X.—That at the ordinary Meetings the following business be transacted:—The minutes of the last Meeting shall be read and confirmed; donations to the Club since the last Meeting announced and exhibited; ballots for new Members taken; papers read and discussed; and certificates for new Members read; after which the Meeting shall resolve itself into a *Conversazione*.

XI.—That any Member may introduce a Visitor at any ordinary Meeting, who shall enter his name with that of the Member by whom he is introduced in a book to be kept for the purpose.

XII.—That no alteration be made in these Rules, except at an Annual General Meeting, or a special General Meeting called for that purpose; and that notice in writing of any proposed alteration be given to the Committee, and read at the ordinary Meeting at least a month previous to the Annual or Special Meeting at which the subject of such alteration is to be considered.

---

## APPENDIX.

### FORM OF PROPOSAL FOR MEMBERSHIP.

QUEKETT MICROSCOPICAL CLUB,

20, HANOVER SQUARE, LONDON, W.

I desire to become a Member of this Club. In the event of my being elected, I hereby undertake, so long as I remain a Member, to submit to and be bound by the Rules and Regulations now or at any future time made and provided; and I further undertake to pay to the Treasurer for the time being the Annual Subscription as it becomes due in each year.

Full Christian and Surname \_\_\_\_\_

Occupation \_\_\_\_\_

Postal Address \_\_\_\_\_

We recommend the above Candidate for Election.

\_\_\_\_\_ (*On my personal knowledge.*)

This Certificate was read \_\_\_\_\_ 18

The Ballot taken \_\_\_\_\_ 18

## NOTICES OF RECENT BOOKS.

THE CAMBRIDGE NATURAL HISTORY. Vol. v. Peripatus, by Adam Sedgwick, M.A. Myriapoda, by F. G. Sinclair, M.A. Insects, part 1, by David Sharp, M.A., M.B. London: Macmillan. 17s. net.

This volume, the second of the series already published, is one the value of which, as a text-book and work of reference for students, and also for more advanced naturalists, can hardly be overstated.

To the microscopist the first section, comprising 26 pages, is likely to be of special interest from the excellence of the descriptions and of the illustrations of the minute structure and anatomy, as well as what is known of the life history of that most remarkable of creatures, Peripatus, so different in its characters from the Anthropods on the one side and the Annelids on the other, that a separate class had to be created for the sole occupancy of its single genus.

The species most particularly described is *P. Capensis*, with which the author is from personal examination thoroughly acquainted, but a list of the other recorded species is given, together with a map showing their geographical distribution.

The 50 pages devoted to the Myriapods are, perhaps, somewhat less satisfactory, the first 20 pages on classification being mainly derived from Koch, the 11 illustrations being copied from his figures in "*Die Myriapoden*," some of which—notably that of *Polyxenus Lagurus*—are sadly deficient in detail, and neither in these nor in the subsequent illustrations of the internal structure and embryology is any indication given of the scale to which they are drawn.

The third section of the volume—Insects, part 1—consisting of nearly 500 pages, illustrated by more than 300 figures, is in every way worthy of the reputation of its author, and is, indeed, a work which no true entomologist can afford to be without. Its value will, perhaps, not be very great to the mere

collector—*i.e.*, the man who does his best to exterminate species by filling his cases with rows of impaled specimens of the same kind in the vain attempt to show to what extent variety exists in Nature—but the student will find it a text-book such as he has hitherto yearned for in vain.

The first three chapters deal in a remarkably lucid manner with the general characteristics of insects, their external features, the structure and functions of their internal organs, their embryology, development, and metamorphosis; the fourth chapter treats of classification, and the remainder are devoted to the natural history of the Aptera, Orthoptera, Neuroptera, and a portion of the Hymenoptera.

The system of classification adopted is mainly that of Linnaeus, “based primarily upon the nature of the organs of flight and of the appendages by which the food is introduced to the body of the insect.” The author, however, “does not attempt to disguise the fact that this method is open to most serious objections, but nevertheless believes it to be at present the most simple and useful one, and likely to remain such as long as knowledge of development is in process of attainment.” The systems of classification proposed by Packard and by Brauer are, however, well summarised. Whilst agreeing with the author in the main upon this point, we can hardly help regretting that some revision was not attempted where ample justification would appear to exist. Surely a definition of *Locustidæ* which excludes all the locusts will, to the beginner, appear as great an anomaly as would be a definition of the *Felidæ* which excluded cats. The definitions which precede the descriptions of each family are, however, stated with remarkable clearness, and are in themselves by no means the least valuable portions of the book.

The illustrations are well chosen and executed, many of them being from original drawings of type specimens of the genera described. Many singular forms not frequently met with are also brought under the notice of the reader, but here, as in the preceding section, the student would be greatly helped had the magnifying power been indicated in *all* cases where the object is not depicted of the natural size.

An excellent index facilitates reference to any special portion which it may be desired to consult. We shall look forward

with great interest to the appearance of Vol. vi., in which the remaining orders of insects are to be described.

EVENINGS AT THE MICROSCOPE. By P. H. Gosse, F.R.S. A new edition, revised by Prof. F. J. Bell, M.A. 8vo. London: S.P.C.K. Price 5s.

Although not one of the most successful works of the late Mr. Gosse, yet it has long held a place in popular estimation on account of a certain charm of style which all his writings possess, and also because some of the objects described were ones he had particularly studied and made, as it were, his own. In bringing up the book to a more modern standpoint, Prof. Bell has been careful to alter it as little as possible, and, except where changed zoological views rendered a revision imperative, it remains much as before. For the information of those to whom the book is unknown, it may be as well to state that its subject matter is entirely confined to the animal kingdom; but the microscopist will find in its pages delightful descriptions of an extensive series of animate objects, with all their beauties of structure and marvels of function dealt with in the fresh, vigorous, and independent manner which was peculiar to the author.

MODERN MICROSCOPY. By M. I. Cross and M. J. Cole. Second edition. 8vo. London: Baillière, Tindall, and Cox. Price 3s. 6d.

We are very pleased to welcome a second edition of this excellent manual, which has been enlarged by about 80 pages. The first part, by Mr. Cross, deals with the microscope and its accessories, and although comparatively brief, nothing of importance has been omitted in treating of the instrument itself, the objectives, eye-pieces, and methods of illumination. In any future editions we would, however, recommend either the deletion of Fig. 6 or that the makers be applied to for a new block, for the illustration, while professing to be a *modèle de luxe*, is of a stand that is now surely obsolete, in this country at least, as a glance at the fine adjustment alone will prove, to say nothing of the various swinging movements of body, stage, and sub-stage. We note, too, a few misspellings of proper names, such as *Steinboil* and *Kelner*, which small, but irritating blemishes are carried over from the first edition. A short

appendix of three pages has been added to this part by Dr. G. Johnstone Stoney, F.R.S., dealing with the influence of diffraction on the resolving power of microscopical objectives.

The second portion of the work, by Mr. Martin Cole, is supplemented by a table of organs and tissues, giving the hardening agent, staining fluid, and mounting medium appropriate to each; Mr. Hopewell Smith's process of preparing sections of teeth; Mr. Rousselet's method of preserving Rotifers; Golgi's nitrate of silver process for nerve cells, and numerous other additions or improvements. Short of actual demonstration, this section of the work will serve as the best possible guide to the would-be preparer and mounter of microscopic objects of whatever class, as might be expected from such an able manipulator as Mr. Cole (How is it that nearly all the text-books and manuals, the present included, will write "Farrant's medium?" Mr. R. Farrants, F.R.C.S., was Quekett's successor in the Presidential chair of the R.M.S., but he might have lived in the middle-ages from the way in which his name is, and has always been, mutilated.) On its merits "Modern Microscopy" is cordially to be recommended.

FREDERIC KITTON: A MEMOIR. London: G. Redway, 9, Hart Street, W.C. Price 2s.

A brightly written memoir of our late esteemed Hon. Member by his son, Mr. F. G. Kitton, the well-known artist and illustrator of the haunts of Dickens, containing such an account as is possible of a quiet life spent partly and reluctantly in an uncongenial commercial pursuit and largely in scientific recreation and research. A simple, uneventful career, devoted mainly to the study of Diatoms, things invisible to ordinary sight, can have no meaning or message to the crowd, but those among us who knew him and appreciated his kindly, retiring nature, and had a pass to his store of knowledge on the subjects that he loved, will be glad to possess this filial tribute to his memory. It contains a complete list of Mr. Kitton's contributions to standard works and scientific periodicals, besides an excellent portrait, copies of which, on India paper, may be obtained from Mr. F. G. Kitton, Pré Mill House, St. Albans, price 1s. 6d.

SYLLOGE ALGARUM. Vol. III. Fucoideæ. 638 pp. Patavii, 1895.

This instalment of Prof. De-Toni's monumental work contains a description, in Latin, of over 1,000 species of brown and olive sea-weeds, the Fucaceæ and Phæophyceæ. To every systematic student of the marine algæ it must prove invaluable.

AN INTRODUCTION TO THE STUDY OF SEaweEDS. By G. Murray, F.R.S.E., etc. 8vo, pp. 271, with eight coloured plates and 88 other illustrations. London: Macmillan. Price 7s. 6d.

It has often been a subject of remark that the Marine Algæ have received so little attention, comparatively speaking, from microscopists in general. So far as we are aware the late Mr. Buffham was the only member of this Club who devoted himself to their study, or, at all events, the only one who contributed the results of his investigations to our Proceedings. The necessary material is both abundant and accessible, and the most probable reason for the apparent neglect of this interesting branch has been the want of some reliable guide, treating the subject scientifically and systematically, and at the same time within the means of ordinary students. This want has now been completely satisfied by Mr. Murray's Introduction, which is concise, accurate, well illustrated and inexpensive, and it will, indeed, be strange if, with this book at hand, some of the many problems of reproduction waiting solution among these plants are not attacked with some measure of success by microscopists desirous of new fields for their energy. It contains a complete index and bibliography, systematic and morphological.

TABLE FOR THE CONVERSION OF ENGLISH AND METRICAL LINEAR MEASURES.

1 ÷	mm.	1 ÷	MICRA.	1 ÷	MICRA.	1 ÷	MICRA.
2	12.70	33	770	66	385	99	256
3	8.47	34	747	67	379	100	254
4	6.35	35	726	68	374	105	242
5	5.08	36	706	69	368	110	231
6	4.23	37	686	70	363	115	221
7	3.63	38	668	71	358	120	212
8	3.17	39	651	72	353	125	203
9	2.82	40	635	73	348	130	195
10	2.54	41	619	74	343	135	188
11	2.31	42	605	75	339	140	181
12	2.12	43	591	76	334	145	175
13	1.95	44	577	77	330	150	169
14	1.81	45	564	78	326	155	164
15	1.69	46	552	79	321	160	159
16	1.59	47	540	80	317	165	154
17	1.49	48	529	81	314	170	149
18	1.41	49	518	82	310	175	145
19	1.34	50	508	83	306	180	141
20	1.27	51	498	84	302	185	137
21	1.21	52	488	85	299	190	134
22	1.15	53	479	86	295	195	130
23	1.10	54	470	87	292	200	127
24	1.06	55	462	88	289	205	124
25	1.02	56	454	89	285	210	121
		57	445	90	282	215	118
	MICRA.	58	438	91	279	220	115
26	977	59	430	92	276	225	113
27	941	60	423	93	273	230	110
28	907	61	416	94	270	235	108
29	876	62	410	95	267	240	106
30	847	63	403	96	265	245	104
31	819	64	397	97	262	250	102
32	794	65	391	98	259		

As the measurements of many microscopical objects (especially the rotatoria) are given in fractions of an inch in English literature, and in metrical measure in foreign works, the above table has been drawn up to facilitate comparison. Its use is obvious. Examples:  $\frac{1}{7}$  inch = 3.63 mm.,  $\frac{1}{58}$  inch = 438 micra, or .438 mm. For fractions smaller than  $\frac{1}{250}$  inch that portion of the table between the figures 26 and 99 may be used, by cutting off the last figure for hundredths, and the two last figures for thousandths. Examples:  $\frac{1}{270}$  inch = 94.1 micra, or .0941 mm.;  $\frac{1}{7900}$  inch = 3.21 micra, or .00321 mm. When that portion of the table between the figures 100 and 250 is used it is only necessary to cut off the last figure for thousandths and the two last figures for ten thousandths. Examples:  $\frac{1}{1350}$  inch = 18.8 micra, or .0188 mm.,  $\frac{1}{6500}$  inch = 1.54 micra, or .00155 mm. The conversion of mm. into fractions of an inch is performed in the same manner; thus, 529 micra or .529 mm. =  $\frac{1}{48}$  inch; 39.7 micra or .0397 mm. =  $\frac{1}{640}$  inch; 2.62 micra or .00262 mm. =  $\frac{1}{9700}$  inch; 1.04 micra or .00104 mm. =  $\frac{1}{24500}$  inch; .977 micron or .000977 mm. =  $\frac{1}{26000}$  inch, and so on.

One millimetre contains 1000 micra, and one inch 25399.772 micra.

When a slide rule is employed put 63 on the Slide (B line) in a line with 1600 on the Rule (A line); then everything on the Rule (A line) is inches, and everything on the Slide (B line) is metrical.

A micron is very nearly equivalent to 4 trans. striæ of an average *Amphipleura pellucida*, and to  $2\frac{1}{2}$  trans. striæ of the large *Navicula rhomboides* in Cherryfield and Sozodont gatherings. Micra are usually denoted by the symbol  $\mu$ .—[E.D.]



2



3



3a



3b





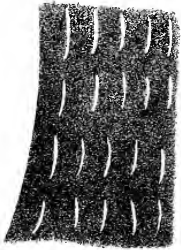
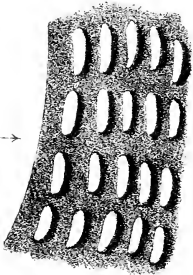
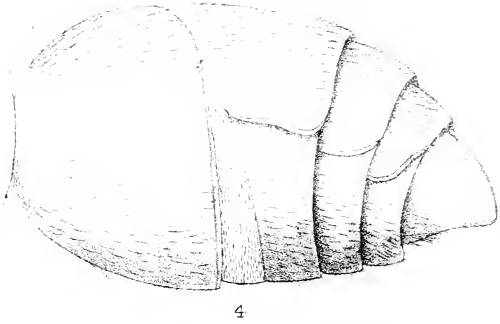



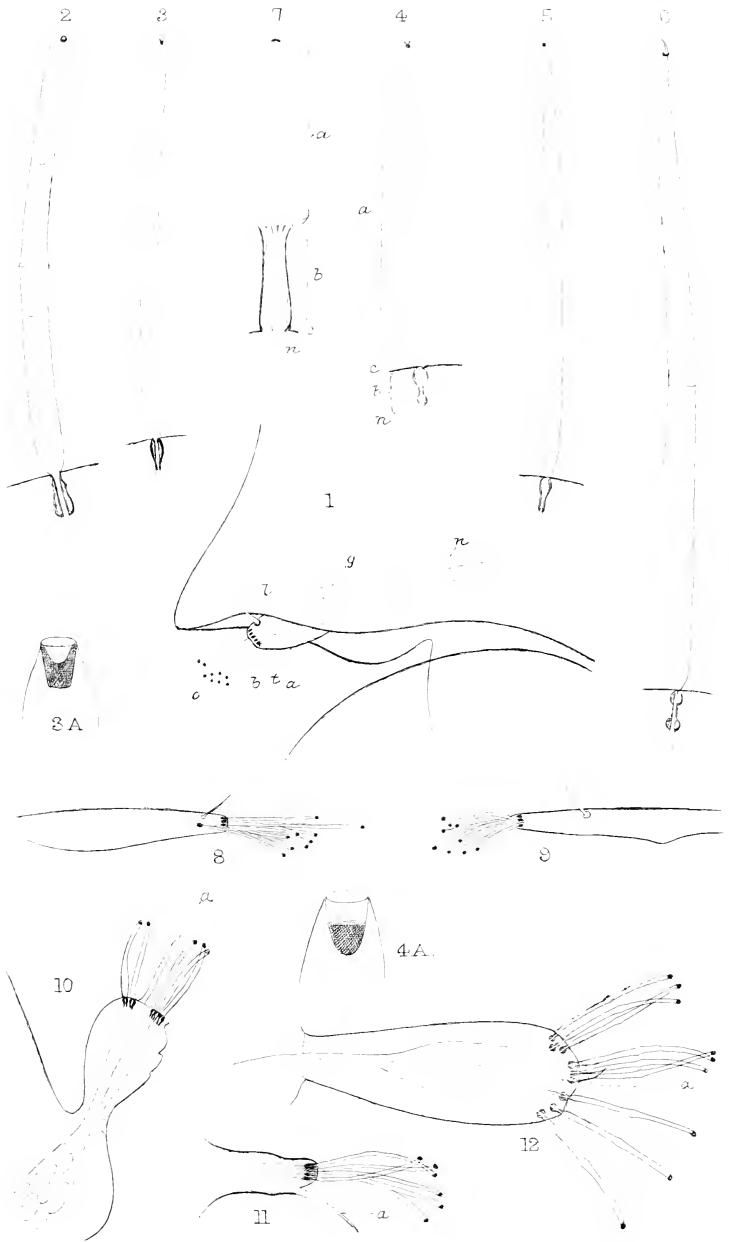

D.J. Scurfield del.

West, Newman sc.

Olfactory Setæ of Cladocera.



## RATTULUS COLLARIS SP. N. AND SOME OTHER ROTIFERS.

By CHARLES F. ROUSSELET, F.R.M.S.

*(Read March 20th, 1896.)*

## PLATE XI.

In November of last year I paid a visit to the bog ponds near Sandhurst, which many years ago yielded such an abundance of new and rare Rotifers to the patient researches of Dr. Collins and Mr. Gosse. These small ponds, averaging only about a square yard or two in extent, and quite filled with sphagnum moss, are still as prolific now as they were thirty years ago, and I obtained therefrom quite a number of rare Rotifers, including *Copeus spicatus*, *Microcodon clavus*, *Æcistes velatus*, with two red eyes near the edge of the corona, and Mr. Gosse's *Diplois propatula*, which Dr. Collins originally discovered in these ponds. This animal is identical with the *Euchlanis subversa* described by Mr. D. Bryce in "Science Gossip," 1890, p. 77. Dr. Collins' figure, which is reproduced in Hudson and Gosse's book, Pl. XXIV., Fig. 2, is perfectly correct, and represents the animal when focussed on the inangulation formed by the dorsal and ventral plates. Unfortunately Mr. Gosse has misinterpreted the structure of the lorica, which certainly is very unusual, and in fact closely approximates that of an ordinary *Euchlanis* turned upside down. There can be no doubt, however, that the dorsal plate is small and concave, and the ventral plate much larger and convex, with a deep inangulation between them, and there is no dorsal cleft. This makes the animal a *Euchlanis*, as pointed out by Mr. Bryce, and as it is now ascertained that these two names refer to one and the same animal the proper name for it must be *Euchlanis propatula* (Gosse). I sent some specimens to Dr. Collins, who at once recognised them as the animals he had figured in his sketch book thirty years ago, and this removes all possible doubt on the subject. Dr.

Collins has even sent me some copies of his original sketches, including a transverse section, which shows that he, at the time, understood the lorica quite correctly, and it is surprising that Mr. Gosse, with this figure to guide him, interpreted it differently. It is necessary to point out all these facts to prevent further misunderstanding, and I shall place a mounted slide of this Rotifer in the cabinet of the Club for reference.

*Rattulus Collaris*, sp. n. (Fig. 1).

In the Sandhurst ponds I also found a new *Rattulus* which I have named *R. Collaris*, and which forms the principal subject of this paper.

In shape the body is roughly cylindric, slightly curved behind; the lorica is finely pitted or stippled, giving it a roughened appearance; it has no dorsal ridge and is fairly stiff, except in the neck region, where the integument is more flexible and frequently forms a thickened collar when the animal is bending or retracting, and from this characteristic peculiarity the animal derives its specific name. The foot opening is oblique, nearly ventral, and the lorica overhangs the foot dorsally in a marked degree. The head is elongated, truncate in front, and somewhat tapering anteriorly, and it is furnished with a simple wreath of cilia; it contains a conical brain mass with a red eye at the tip and a large mastax with long jaws of the *Rattulus* type. The long thin cesophagus is attached to the antero-dorsal part of the mastax and widens into the large saccate stomach and intestine. Rounded gastric glands are attached to the anterior part of the stomach in the usual way. The ovary is an oval plate with large nuclei imbedded in its granular substance, and it has generally a large maturing egg attached to it. Lateral canals, with flame cells attached, and a contractile vesicle are present. The dorsal antenna emerges from a small depression in the head, just behind the tip of the brain, and the lateral antennæ are situated in the lumbar region, on each side of the body. The foot emerges nearly ventrally; it consists of two short joints and is furnished with two very long, thin, narrow, glassy toes, about half the size of the body in length. The toes are nearly straight for about half their length, then they are decurved; one, or two, very small substyles are present at the base of each toe.



In swimming the animal moves slowly, as if the small ciliary wreath were not powerful enough to move the comparatively large body, and I always found it at the bottom of my tanks among the sediment.

Length, total, with toes,  $\frac{1}{80}$  in. (0.317 mm.); of body alone,  $\frac{1}{120}$  in. (0.212 mm.); of toes alone,  $\frac{1}{42}$  in. (0.105 mm.).  
Habitat : Sandhurst, Berks.

I take this opportunity to describe two Rotifers which I found in Germany in September of last year, and which, although not new to science, have not yet been found nor figured in England.

*Polyarthra platyptera*, var. *euryptera* (Wierzejski), (Fig. 2).

I obtained this large and fine *Polyarthra* in abundance in a small forest lake situated at Dornholzhausen near Bad-Homburg, associated with another stranger to England: *Mastigocerca setifera* (Lauterborn). This *Polyarthra* is a well-marked variety of, and much larger than our common *P. platyptera*. Its chief peculiarity consists in having very broad, leaf-like paddles, instead of the narrow blades of *platyptera*; there are six paddles on each side in two groups of three, which evidently are much more effective in propelling the animal when danger is near. Otherwise the structure and anatomy of both animals are alike, but the female eggs of *euryptera* are much more pointed at one end, while in the common form they are regularly oval. Fig. 2 shows a dorsal view with a cluster of small spherical male eggs, and Fig. 2a a side view with a large female egg attached. This species was first discovered by Professor A. Wierzejski in Galicia, and figured by him in his work, "Rotatoria Galicyi," in 1893. Its size is  $\frac{1}{40}$  in. (0.181 mm.).

I am indebted to Mr. F. R. Dixon-Nuttall's kindness and facile pencil for the very good figures of this difficult animal; they were drawn from my mounted specimen, and a slide of them will be placed in the cabinet of the Club.

*Schizocerca diversicornis* (Daday), Fig 3.

I found this fine and very peculiar Rotifer of the family Brachionadæ living in a large fountain basin in the gardens of

Ballenstedt Castle in the Harz Mountains. It was first discovered by Dr. Daday in Hungary, and figured and described by him in 1885 in the Publications of Budapest University, but the text is in Hungarian and therefore scarcely available outside Hungary; it has since been found in various parts of Germany, but not yet in England. The animals found by Dr. Daday had the left posterior spine quite short, a mere thorn, and hence the specific name; those found by me had also the same character, but some that I previously received from Mr Lauterborn, which had been collected near Ludwigshafen, have both posterior spines of quite equal length, as represented in the figure; in a few individuals, however, the left posterior spine is somewhat shorter, to even half its normal size. Similar animals had been found before by Professor Wierzejski, who named this variety "Homoceros"; it is well-known, however, that the posterior spines in the Brachionadae are very variable, so that this point is insufficient to make even a variety. The shape of the animal will best be seen from the figures. The lorica is compressed as a whole, but arched dorsally; it has four spines anteriorly: two very short straight median spines, between which the dorsal antenna protrudes, and two very long ones at the outer corners. Posteriorly, the lorica becomes narrowed and carries two long diverging spines, the left of which may be more or less reduced in size, or represented only by a short thorn. The shell is quite smooth and glassy transparent. The corona consists of a number of well-marked lobes with long cilia; the jaws and whole internal anatomy are of Brachionus type. Dr. Daday seems to have attached great importance to the structure of the foot, and to have created a new genus merely on that account. The foot is certainly very peculiar; it is extremely long, very flexible, wrinkled, and appears at first sight bifurcate at the end, with two toe-like structures at each termination. A bifurcate foot would be a quite unique feature amongst Rotifers, but in reality I do not consider that the foot of Schizocerca is bifurcate; I consider the bifurcation to be simply the greatly elongated toes, shouldered at the end, each terminating in two soft fleshy points, at the base of which is situated the aperture for the escape of the secretion of the foot-glands. As in all species of Brachionus, the long toes can be wholly withdrawn into the terminal

segment of the foot to which they are jointed, and which is not wrinkled; this segment again telescopes into the preceding portion of the foot, which after that becomes wrinkled. The whole foot can be withdrawn inside the lorica, and in life is generally so carried by the animal when swimming. In the majority of the species of *Brachionus* the toes are conical, with a minute opening at the very tip of the cone, but in *Brachionus angularis* the toes have a very similar structure to those of *Schizocerca*, except, of course, that they are not so long; they are shouldered, that is, drawn out on the outer side into a thin fleshy "toe-nail"-like structure, at the base of which the foot-gland opening is situated. This structure of the toes of *B. angularis* seems to have escaped Dr. Hudson and Mr. Gosse, although Dr. Plate's drawing in 1885 of *B. bidens*, which is the same species, shows it quite distinctly, and he mentions it in the text. It will be seen therefore that the peculiar structure of the foot and toes of *Schizocerca* is hardly of sufficient importance to justify the formation of a new genus for its reception. In a recent paper on Syrian Rotifers Dr. Daday and Dr. Barrois figure an empty lorica under the name *Brachionus caudatus*, n. sp., which has the greatest possible resemblance to *Schizocerca*, except that the two large frontal spines are quite absent, and the posterior spines only half as long as those of *Schizocerca*.

I will not omit to mention that Dr. Hudson's summary of the generic characters of *Schizocerca*, given in the supplement to the Rotifera, as follows: "With a long foot ending in a fork of two unequal branches, each terminated by a pair of unequal toes," is not quite correct, and is based on Dr. Daday's figure, which certainly shows such characters, but in his Latin diagnosis of the species he mentions only that the toes are unequal, not the branches of the fork.

Size: Length of lorica, including the spines,  $\frac{1}{65}$  in. (0.39 mm.).

A mounted slide of *Schizocerca diversicornis* will also be placed in the collection of the Club, and here again I am indebted to Mr. F. R. Dixon-Nuttall for the accurate figures of this animal reproduced in the plate.

## EXPLANATION OF PLATE XI.

FIG. 1. *Rattulus collaris*.

- ., 2. *Polyarthra platyptera*, var. *euryptera*, with male eggs,  
dorsal view.  
., 2a. " " " " with a female egg,  
side view.  
., 3. *Schizocerca diversicornis*, dorsal view.  
., 3a. " " " side view.  
., 3b. " " " extremity of foot, enlarged.

## NOTE ON A STRIDULATING ORGAN IN A SOUTH AFRICAN ANT.

*Streblognathus Æthiopicus.*

By R. T. LEWIS, F.R.M.S.

*(Read April 17th, 1896.)*

## PLATE XII.

About three years ago I received from a correspondent in Natal a black ant of large size, which was said to be capable of squeaking when captured or otherwise irritated, and I was asked to examine it under the microscope with a view to ascertain if there was anything in the structure of the insect which rendered this possible. The specimen was strongly curled up and extremely hard and dry, and such examination as I then gave it failed to disclose any competent stridulating organ, but my attention was attracted by a curious pectenated spine or comb upon the apex of the tibia of the 2nd and 3rd pairs of legs in addition to the usual brushlike arrangement found in a similar position on the 1st pair of legs and obviously used for cleaning the antennæ (Figs. 1, 2, 3). The use of these additional combs was not apparent, as the insect was but sparsely covered with hairs, but as no complementary structure could be found within reach, which by friction on the combs was capable of producing the sound referred to, it was assumed that these, at least, were not the organs concerned in its production. They were, however, sufficiently curious and interesting in themselves to warrant some description, and members now present will no doubt recollect that I exhibited them under the binocular microscope at one of the soirées of the Club held at the Freemasons' Hall.

On referring the question back to my friend I learned from him that he had not himself heard the ant make any noise, but was told by the natives that it did so, and he promised to verify the matter at the first opportunity which presented itself. Last

year he was able to secure some further specimens, one of which he could personally vouch for as having produced certain squeaking sounds during and after its capture. I found on examination that the species was the same as that formerly sent, but although the insects were extremely dry, and so hard that an entomological pin bent under the pressure applied without being able to penetrate the thorax, the abdomen was this time fully extended, and the first glance revealed the existence of an extremely perfect and competent stridulating organ (Fig. 4) which had escaped notice before through having been completely retracted within the preceding segment.

The general colour of the abdomen of this ant under ordinary light is black; it is also highly polished and covered sparsely with soft brown hairs with the exception of the 2nd ventral segment counting from the stalk. This is seen at once to differ entirely in appearance and surface structure from all the others, being free from hairs and apparently striated or ribbed from end to end. Under a very moderate power it is seen that these striations are not continuous lines, but that they are broken up into numerous distinctly separate sections of slightly unequal length, so that whilst the longitudinal parallelism of the striæ is maintained, the rows of which they are composed present a somewhat zigzag arrangement transversely. The average number of striæ across the band is 26, which gives them a closeness of about 1,650 to the inch. Under a  $\frac{1}{2}$  in. power, however, the structure of the band becomes more apparent, and it is then perceived that the surface is not really furrowed, but that it is set with rows of minute elevations not unlike the cogs or teeth of a ratchet, their anterior face being slightly concave and rising at an angle of about  $30^\circ$ , whilst the posterior face is almost perpendicular to the general surface of the band. The ridge of each tooth is narrow, but nearly level for more than  $\frac{3}{4}$  of its length, the ends being rounded off and every angle smoothed and polished in a high degree, the formation of the teeth presenting a similarity to some analogous structures met with amongst the Orthoptera. The shape and arrangement of these teeth causes them to assume a remarkably different appearance according to the direction in which the light is allowed to fall upon them. If obliquely illuminated from the posterior side they appear as rows of extremely fine lines (Fig. 7), the light

being then reflected from the narrow upper edges of the teeth alone; but if the light is allowed to fall upon them from the opposite direction (Fig. 6) it is reflected from the concave anterior surface of each, giving them the appearance of so many elongated oval patches shining like mirrors upon the dark background in which they are set.

This stridulating band is firmly fused by its posterior margin to the succeeding ventral abdominal segment, but it is free to slide within the segment which precedes it, so that when the extremity of the abdomen is curled under and forward, the band is entirely overlapped and the edges of the 1st and 3rd segments (as reckoned from the stalk) are approximately in contact. The preceding segment is very large and rigid and is formed of extremely hard chitine, but its posterior margin is readily seen to be incurved and to be reduced in thickness to a knife-like edge, which presses in gentle contact upon the stridulating band. The action of the whole apparatus will now be obvious (Fig. 5); as the apex of the abdomen is depressed and curled the band slides under the knife edge referred to, which passes easily over the inclined faces of the rows of teeth, but when the abdomen is extended again with a sudden jerk, the teeth pass under the hard incurved edge in the opposite direction, striking the perpendicular face of each against it and causing it to spring down with some force upon each row in rapid succession, each such jerk of the abdomen being thus necessarily accompanied by a very perceptible chirp or squeak, the pitch of which will depend upon the rate at which the resulting vibrations succeed each other.

Stridulation in ants is not at all new, having frequently engaged the attention of entomologists and been made the subject of many communications to Societies at home and abroad. A paper by Dr. David Sharp read before the Entomological Society in June, 1893, and published in their Proceedings, describes these organs in about 20 species belonging to four genera, of which two at least are British. Figures are also given, but there is nothing amongst these which corresponds to the one which is the subject of the present paper, and Dr. Sharp, to whom I submitted some drawings, informed me that he had not yet seen one like it.

The specimen exhibited under the microscope in the room

was sent to me by the Rev J. R. Ward, of Richmond, Natal, to whom I am indebted for many objects of microscopic interest which have furnished material for previous communications to the Club, but the species seems to be rather widely distributed in South Africa, and the very perfect example which I have also brought for exhibition was captured by my daughter at Uitenhage, in Cape Colony, about four months ago. It has been identified as *Streblognathus Æthiopicus*.

#### EXPLANATION OF PLATE XII.

- FIGS. 1, 2, and 3. Combs on apex of tibia of 1st, 2nd, and 3rd leg respectively  $\times 20$ .
- FIG. 4. Abdomen of ant showing stridulating band  $\times 10$ .
- FIG. 5. Section of band and adjacent segments  $\times 30$ .
- FIGS. 6 and 7. Portions of band as seen by oblique illumination  $\times 75$ --the arrows indicating the direction of the incident light.
- FIG. 8. *Streblognathus Æthiopicus*, natural size--dorsal aspect.
-



NOTES ON AQUATIC HYMENOPTERA AND REDISCOVERY OF *PRESTICHIA AQUATICA* (LUBBOCK).

By FRED. ENOCK, F.L.S., F.E.S.

(*Read May 15th, 1896.*)

It is with no small amount of pleasure that I am able to announce to the Quekett Club my success in at last finding this most peculiar Hymenopteron which has for so many years eluded my search.

The pond from whence Sir John Lubbock obtained the original specimens thirty-four years ago has long since disappeared and been filled up. Those that now remain in proximity to the locality are not noted for their sweetness, being anything but desirable or even convenient ponds in which to dabble or occasionally paddle.

I have worked most of them in the neighbourhood of Chislehurst, but without success so far as concerns aquatic Hymenoptera.

In my journeying by rail from London I have always noted the ponds skirting the line, and in fact any pond I could see, the position of which could be easily ascertained by counting the fields to the next station. One of these struck me as being a very "likely" one, to which in due time I found my way, the long grass and shelter of a hedge protecting me from the vulgar gaze of the owner, of whom I had been warned, but whose acquaintance I had not yet made. The pond is a particularly good one, and from which I hope to obtain some useful information. Another large wayside horse pond attracted my attention, and was duly visited in the early spring time, when the winding lanes were in their beauty, causing the eye to linger over the flowers and one's footsteps to move slowly, but the pond was not forgotten, and soon I commenced "dipping" and examining the contents of each net or phial. After a few hours' work I noticed a minute insect in the net endeavouring to

struggle to its feet, but it was evidently out of its element. My magnifier revealed a hymenopteron, but not the one I had expected to find; for after carefully transferring it to a phial of clear water it at once revealed its identity to my delighted vision, and I realised that I was looking upon *Prestwichia aquatica*. Operations were at once suspended so that I might feast my eyes upon my prize, and also make a few sketches upon the spot, noting down particulars as to attitude at rest and in action. I watched it paddle itself about, with the aid of its *legs* alone, the wings being kept closely lapped over its abdomen. Going to work again for another hour, I dipped up another specimen which was much smaller than the first, and both being females. Another hour or more dipping and I landed an insect whose identity I at once recognised from my experience of last year, a *very* fine female *Caraphractus cinctus*.

Having now almost exhausted the day, I packed up my precious finds and wended my way to the far-off station.

A few days after I paid another visit and found that some one had completely cleared the pond of every bit of weed, and so fouling the water that all my hopes of obtaining the unknown *male* *Prestwichia* were ruined for some time to come. I kept my first captures alive for some few days, during which time they paddled about, minutely examining the weed with their antennæ, evidently searching for a nidus wherein to oviposit.

I mounted these specimens, which are now under my microscope. Careful examination proves that the tarsi are composed of three joints and *not* four, as stated by Sir John Lubbock.

The ovipositor is of great length, from which fact I incline to think that it is used for piercing through some considerable thickness of material before reaching the egg in which it is supposed to oviposit.

This insect does *not* belong to the family Mymaridæ, though the Rev. T. A. Marshall has so placed it, in his list of British Hymenoptera—the structure of the antennæ and wings exclude it from that family. No doubt, when all details have been worked out, the right relatives will be found.

Last year, when speaking of *Polynema natans*, I expressed an opinion that it would prove to be identical with Haliday's *Caraphractus cinctus*, from the unique characteristic of the

keeled thorax. Through the kindness of Dr. R. F. Scharff, Director of Dublin Museum, I have been enabled to examine the type collection of Haliday's Mymaridæ, but regret to say that the types of Caraphractus and one or two other genera are not in the collection. There is no doubt that this *is* identical with the insect (Caraphractus) which Haliday captured "on long grass in a ditch." In all probability, when sweeping this long grass, the net was just dipped into the water and brought up Caraphractus.

I felt the responsibility of altering the name of *Polynema natans* to Caraphractus, but had the pleasure of showing my specimens at the Conversazione of the Royal Society, when Lord Kelvin, Sir John Lubbock, and Professor Poulton fully agreed with my opinion. During May this has been confirmed in a somewhat remarkable manner. On reading some "Notes on the Mymaridæ" by the late Francis Walker, given in "The Entomologist" for 1873, I came across the following remarks, viz., "Sir John Lubbock has described two species—*Polynema natans* and *Prestwichia aquatica* ("Linn. Trans.," xxiv., 138-140, pl. 23) that live occasionally under water and are able to swim. *Polynema natans* according to Haliday = *Caraphractus cinctus*." This seems to have entirely escaped the notice of Sir John Lubbock and the late Professor Westwood, and all others who have copied their remarks.

In the July number of "Science Gossip," I expressed an opinion that I quite expected ere long to discover the unknown male *Prestwichia*, which I thought might prove to be an apterous insect.

Since giving my notes at the Quekett Club in May, I have fully realised these expectations in capturing a number of micropterous males, which I hope at some future meeting to exhibit to the members, my appeal to whom, to keep a careful look out for these aquatic insects has borne fruit, Mr Scourfield having very kindly sent a specimen of a female *Prestwichia* which he had "quite by chance" dipped up when searching for Entomostraca. I am indebted to him for thus helping me and enabling me to discover the male.

During the past season I have made some remarkable discoveries concerning several of these minute "Egg Parasites."

ON A SIMPLE MEANS OF ILLUMINATING OBJECTS WITH LOW  
POWERS BY ARTIFICIAL LIGHT.

By G. C. KAROP, M.R.C.S., F.R.M.S.

(*Read May 15th, 1896.*)

Some little time back I was asked the best way to examine microscopical specimens, requiring only low powers, by artificial illumination. What exactly the *best* way may be is, of course, a matter of opinion; but judging from the very inefficient, not to say bad manner in which such objects frequently are exhibited, even at this Club, it might be profitable if I were permitted to describe a simple means of obtaining a pleasant equably lighted field with sufficient intensity and of such a tone as to permit of a prolonged examination of low power specimens without fatigue.

Such an illumination was felt to be a desideratum in quite early microscopical days, and in all the older text-books will be found descriptions of apparatus to serve this end, ranging from simple contrivances like waxed paper, ground glass and plaster-of-Paris mirrors to light modifiers, reflector screens, white-cloud condensers, double parabolic specula, and many more elaborate devices. It is pretty obvious, therefore, that nothing very new or striking is likely to be invented for the purpose now, when the tendency is to diminish rather than multiply apparatus; so without any pretence of novelty I will merely describe the simple affair I myself have found very useful, and this will probably be the means of educing other, and perhaps better methods, from those who have felt the same want and have encompassed it in other ways.

The idea is firstly to intensify the light and then spread it over a large surface. For the intensification I use the lower, crossed lens of the Abbe condenser, but any suitable fairly large lens of about one inch focus will do as well, either a double convex or the field lens of an eye-piece. This is screwed into

the lower end of a piece of tube fitting the sub-stage, or under stage ring, which tube should be a little longer than the focal length of the lens employed. Just below the upper end of the tube is a split ring serving as a ledge, and on this, in the focal plane of the lens, rests a circle of thinnish glass lightly ground on one surface. The light from the flat of the lamp flame is condensed by the bull's-eye on the mirror, thrown up through the lens and focussed on the ground glass, which is racked or pushed up until almost in contact with the slide. The image of the flame being broken up at every possible angle by the ground glass, with a little manipulation one can fill any sized field with a most pleasant soft light, which can be employed for a long time without detriment to vision. It was long ago discovered, I believe by the late Mr. Slack, that freshly-ground glass possessed a peculiar property of soft brilliancy which the commercial product did not, and I get circles of the required size from the glass-cutter and grind them myself with a little fine emery and water on another piece of glass until just sufficiently abraded to stop any direct pencils. Besides the ordinary white glass it is a great advantage to get some circles cut from different tints of blue or smoked glass, and either grind these on one surface in the same way, or temporarily cement them to the un-abraded surface of the ground glass, by a drop of cedar oil or glycerine; one thus obtains a series of tones suited to all sorts of objects.

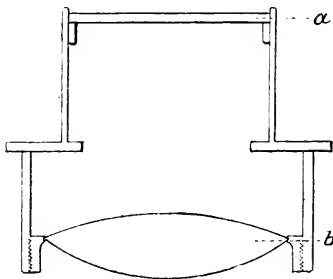

*a.* Ground glass.

*b.* Lower crossed lens of condenser.

## THE OLFACTORY SETÆ OF THE CLADOCERA.

By D. J. SCOURFIELD.

*(Read September 18th, 1896.)*

## PLATE XIII.

The antennules, or first pair of antennæ, of the Cladocera, although for the most part organs of small size and simple structure, nevertheless exhibit a very considerable range of variation in form in various species, while the differences between these organs in the two sexes of the same species are in nearly all cases well marked, and not infrequently become quite striking. But to whatever extent an antennule may be modified it is always provided with a tuft of minute characteristic setæ, the so-called olfactory setæ. This tuft of setæ is so essentially part and parcel of the antennule that it is found to persist even when the latter is altogether absent as a distinct outgrowth, as occurs in the marine genera *Podon* and *Evadne*. About two years ago my attention was specially attracted to these peculiar little setæ through having accidentally noticed that, in many species, the number in each tuft, *i.e.*, on each antennule, was constant. Since that time I have examined, as opportunity offered, a great many specimens from this point of view, and it is proposed in the present paper to bring forward the results so obtained, together with a review of the principal facts hitherto recorded, which, it is almost needless to say, lie scattered in the most diverse publications.

Notwithstanding many earlier allusions to the setæ in question by writers on the Entomostraca, Leydig was the first to really appreciate their special nature and to give satisfactory descriptions of them. In his "Lehrbuch der Histologie" (1857), "Naturgeschichte der Daphniden" (1860), and a paper "Ueber Geruchs- und Gehörorgane der Krebse und Insekten" ("Archiv für Anatomie," 1860), he not only gave a good account of the histology of these setæ, but also made known the wide distribution of closely similar structures

among the Crustacea, and in the last-named paper at least considered them to be probable organs of smell. Claus, in a paper "Ueber die blassen Kolben und Cylinder an den Antennen der Copepoden und Ostracoden" ("Naturwissenschaftliche Zeitschrift," 1860), showed that similar setæ are present on the antennæ of Copepods and Ostracods, and in various more recent papers he has incidentally added to our knowledge of the subject. Weismann gave a good drawing of a single seta in his paper on "Leptodora" ("Zeitschrift f. Wiss. Zoologie," Vol xxvii., 1876), and he also brought forward a number of interesting details on the subject at the end of his paper "Ueber die Schmuckfarben der Daphnoiden" ("Zeit. f. Wiss. Zool.," Supplement, Vol. xxx., 1878). Several other authors have from time to time added isolated details to the facts already known, but these scarcely call for detailed reference.

Considering first of all the essential structure of the olfactory setæ of the Cladocera, it will be found that each seta consists of an extremely hyaline and perfectly smooth rod, either cylindrical or somewhat tapering towards its tip (see Figs. 2-6). The walls of the rod seem to be but very slightly chitinised and very thin, whilst the internal protoplasm is either homogeneous or, as is more usual, contains a number of vacuoles and granules. The tip of the seta is always furnished with a small highly refracting pellet, presumably of chitin, and it may be useful to note that it is this pellet which forms the most easily recognised mark of a cladoceran olfactory seta. At its point of insertion on the antennule the hyaline rod joins a strongly chitinised more or less elongated bead of variable shape (Figs. 2-6), which is completely imbedded in the antennule. This elongated bead is, at its innermost extremity, joined by a delicate nerve-thread, or rather, perhaps, series of nerve-threads, which can be traced back to the large ganglion of nerve-cells forming such a prominent feature of the antennule, and from the ganglion again it is easy to trace back the nerve coming from the brain.

To the foregoing facts of the essential structure, which were practically all worked out by Leydig, and have not since been materially augmented, I am now inclined to add, on the strength of a large number of observations, that the hyaline

rod is always divided into two almost equal portions, either by a slightly projecting ridge (Figs. 2 and 3), or by a shoulder (Fig. 4), or at least by a faint line (Figs. 5 and 6). It is true that, owing to the extreme minuteness and delicacy of these setæ, I have not been able to satisfactorily make out the division into two parts in some cases, but it can be demonstrated in so many others that there seems little doubt that it is really a constant feature. The importance of this character is that it enables us to correlate with certainty the whole of the hyaline rod, *i.e.*, the whole of the external portion of the seta, with the distal hyaline portion of very similar sense-hairs on the antennæ of other crustaceans, as for example *Asellus aquaticus* (Fig. 7) and *Astacus fluviatilis*, for in these cases also the division of the hyaline portion into two parts is present.

Leaving the essential structure, a few words may next be devoted to some of the principal variations noticeable in different species. As regards the shape of the main, *i.e.*, the hyaline, portion of the seta, there is not much to be said, for in the vast majority of cases it is little more than a straight or slightly curved rod of nearly uniform diameter. In the case of *Eurycerus lamellatus* (Fig. 4), however, the distal half of the rod is only about half the diameter of the proximal half, and in *Acantholeberis curvirostris* (Fig. 6) the sudden diminution in diameter towards the tip produces rather a characteristic appearance. The tip of the seta itself may be either rounded, truncated, or produced into two little points, although in some cases the latter appearance is possibly due to an optical illusion caused by the highly refracting pellet (see Figs. 4 and 4a). In other cases, however, *e.g.*, *Acantholeberis* (Fig. 6) and *Macrothrix*, the two projections from the tip are so large as to form veritable hooks, about which no question of optical illusion can arise. The pellet of chitin at or quite near the tip of the seta, although such a noticeable feature, is difficult to examine on account of its small size and highly refracting nature. It usually appears as a simple spherical granule, but sometimes gives one the impression that it may be a ring, and in yet other cases I am inclined to think that it has a cup-like form (Fig. 3a) or at least that it forms a solid button at the bottom of a cup-like depression in the tip of the seta (Fig. 4a). But the most variable part of the seta is undoubtedly the chitinous basal piece to which the hyaline rod



is attached, and which lies wholly within the antennule. The fundamental form of this seems to be a hollow cylinder. In most, if not all cases, however, some departure from this simple form is shown. Occasionally the proximal end is enlarged whilst the remaining portion retains the cylindrical shape, or nearly so, as in *Leptodora*. Much more frequently it is the distal end which is enlarged, and perhaps still more often both ends are enlarged, producing the appearance of a dumb-bell. From these three main types a very great number of different and characteristic shapes are produced, owing to the various degrees of enlargement of the ends and the length of the whole structure.

Comparing the olfactory setæ as above described with those from other groups of the Crustacea (the typical Crustacean olfactory seta is well shown by *Asellus aquaticus*, Fig. 7), the most noticeable difference is the absence of the strongly chitinised stalk or handle in the former. This absence is, I believe, more apparent than real, however, for it is more reasonable to suppose that this part of the seta is really represented by the elongated basal bead than that the latter is an entirely new structure. It is true Leydig was of the opinion that the highly chitinised beads within the antennule were really depressions in the epidermis, and it is very probable that they were actually formed in this way in the first instance, although they do not show much trace of such a structure now. However this may be, it is still highly probable that the beads in the cladoceran antennule represent the stalks of the olfactory setæ in most other forms of Crustacea, for the setæ would necessarily arise from the bottom of the pits when such existed.

Taking next the question of the number of olfactory setæ in each tuft it must be noted that hitherto no definite rule appears to have been observed, although in numerous descriptions of species the number of setæ has been alluded to. Statements may be found in papers by Kurz, Hellich, Weismann, and others, that from 5 to 10, 6 to 7, 6 to 8, 7 to 9, 8 to 10 such setæ are present in various cases. Even in one of the most recent works on the Cladocera ("Révision des Cladocères," by J. Richard, "Annales des Sciences Naturelles, Zoologie," Vol. xviii., 1895) it is said that the anterior antenna carries "un nombre de soies spéciales qui oscille autour de 6. Il y en a

souvent 7 ou 8." Limiting our attention to the females, it will be found, however, that not only is the number of setæ constant for each species and genus, but that it is also characteristic of whole families and groups of families. In fact in the whole range of the Cladocera there are, among the females, only three variations in the number of setæ forming each tuft. It may be useful to summarise the facts as follows:—

The olfactory tuft on each antennule in the females of

<b>Polyphemidæ,</b> e.g., <i>Polyphemus</i> , <i>Bythotrephes</i> , <i>Podon</i> , <i>Eradne</i> ,	}	consists of <b>5</b> setæ.
<b>Holopedidæ,</b> e.g., <i>Holopedium</i> ,		
<b>Sididæ,</b> e.g., <i>Sida</i> , <i>Diaphanosoma</i> , <i>Latona</i> ,	}	
<b>Daphnidæ,</b> e.g., <i>Daphnia</i> , <i>Simocephalus</i> , <i>Ceriodaphnia</i> , <i>Scapholeberis</i> , <i>Moina</i> .		
<b>Bosminidæ,</b> e.g., <i>Bosmina</i> .	}	
<b>Lyncodaphnidæ,</b> e.g., <i>Macrothrix</i> , <i>Drepanothrix</i> , <i>Acantholeberis</i> , <i>Ilyocryptus</i> , <i>Streblocerus</i> .		
<b>Lynceidæ,</b> e.g., <i>Eurycerus</i> , <i>Acroperus</i> , <i>Cumptocercus</i> , <i>Alonopsis</i> , <i>Leydigia</i> , <i>Graptoleberis</i> , <i>Alona</i> , <i>Alonella</i> , <i>Pleurocus</i> , <i>Harporhynchus</i> , <i>Chydorus</i> , <i>Monospilus</i> ,	}	
<b>Leptodoriidæ,</b> e.g., <i>Leptodora</i> ,		

The presence of a generic name in the foregoing statement indicates that at least one species of the genus has been examined from the point of view of the number of olfactory setæ.

It will be recognised at once that the possession of nine olfactory setæ on each antennule is almost typical for the whole of the Cladocera, the two families showing variations from this number, Polyphemidæ and Holopedidæ, being very poor in species. Is it a mere accident that this is also the number of

closely similar olfactory setæ on each joint of the outer branch of the antennule of the crayfish? (See figures given by Leydig, "Archiv f. Anat.," 1860, Plate VII., and Huxley, "The Crayfish," 1880, p. 114).

As regards the number of olfactory setæ present in the males of the Cladocera, I have not been able to examine a sufficiently representative series of specimens to make any generalisations. It seems quite certain, however, that among the Daphnidæ the males have the same number of setæ as the females, namely, nine. The same is probably true also of the Sididæ. The males of the Lynceidæ, on the other hand, very often possess twelve olfactory setæ on each antennule, although occasionally only nine are present, as in the female. The male of *Graptoleberis testudinaria* is somewhat anomalous in this respect, as it seems to have eleven setæ.

Before leaving this part of the subject it may be well to call attention to two sources of error which are liable to lead to false results in counting the number of olfactory setæ. The first is that some of these delicate setæ may be accidentally torn off the antennule, thus apparently reducing the total number. The error arising from this cause can be avoided by counting the number of elongated beads within the antennule. The second source of error is that setæ of various descriptions other than olfactory setæ are often most intimately associated with the latter. (See Figs. 10, 11 and 12.) The only way to avoid counting these is obviously to make sure that each seta possesses the little terminal pellet and the basal bead of chitin.

There now remain for consideration a few facts in connection with the arrangement of the olfactory setæ on the antennule and the variations in the length of the setæ themselves.

As already remarked the tuft of setæ usually originates at or very near to the tip of the antennule, but it sometimes happens that the tuft appears to be shifted nearer to the base of the latter. An extreme case is to be found in *Latona setifera*, where, owing to an enormous development of the structure homologous with the so-called flagellum in the genera *Sida* and *Diaphanosoma* (*Daphnella*), the tuft of olfactory setæ seems to originate quite close to the base of the antennule. Species of *Bosmina* also show the olfactory setæ nearer the base

than the tip of the antennule, and in many males somewhat similar alterations in the position of the tuft of olfactory setæ occur.

The variation in position is not, however, confined to the tuft as a whole, but also occurs among the individual setæ. In most species the setæ have their bases close together, but cases are also to be found in which one or more setæ are separated somewhat from their fellows. Good examples of such an arrangement are exhibited by *Acroperus harpæ* and *Alonopsis elongata* where one of the nine olfactory setæ is shifted back from the main group about one-third the length of the antennule. In yet another case, *Chydorus latus*, two of the setæ are moved back a little from the remaining seven.

Differences of length among the setæ of the same tuft are most numerous in the Lyncodaphnidæ and Lynceidæ. Some of these are very characteristic, and combined with differences of position can often be relied upon for the determination of species. For instance *Alona quadrangularis* and *A. affinis* are so much alike that they have doubtless been mistaken one for the other times without number. Yet it is quite easy to distinguish them merely by looking at the arrangement and comparative lengths of the setæ on the antennules. (Compare Figs. 8 and 9). It must be understood that these remarks apply only to the same sex, for the two sexes of the same species often differ in this respect very considerably. Kurz, I believe, was the first to bring forward a case of this kind, for in his paper "Ueber limicole Cladoceren" ("Zeit. f. Wiss. Zool.," Supplement, Vol. xxx., 1878) he showed that the positions of two setæ much longer than the rest are arranged in quite a characteristic way in the three species *Ilyocryptus sordidus*, *I. agilis*, and *I. acutifrons*.

Many other examples might be given, but enough has been said to show that a careful study of even minute details of structure is not usually thrown away even from the merely systematic point of view.

In the course of the preceding remarks the term "olfactory setæ" has been used quite freely, and it seems only right that in concluding this paper a word or two should be devoted to the question, How do we know that these setæ are organs of smell? Unfortunately it must be admitted that we really do

not know that they are olfactory setæ at all. No experiments have ever been made, nor is it hardly conceivable how experiments could be made, to test the matter. Leydig, however, judging from the analogy of these setæ to the micro-structure of known organs of smell, came to the conclusion that they also possessed an olfactory function, and his opinion has been adopted practically by all the zoologists who have alluded to the subject. This is to be sure not a very strong position, but it receives support from negative evidence. Thus the setæ cannot be organs of sight, for the animals are provided with evident compound and simple eyes. They cannot be merely organs of touch because of their peculiar structure. It is extremely improbable that they are organs of hearing, because in some of the higher crustacea (*e.g.*, the crayfish) similar setæ occur on the antennules, while much more probable organs of hearing are also present. Lastly they cannot be considered as the seat of the sense of taste owing to their position, which is often far removed from the mouth organs. It appears tolerably certain, therefore, that unless the setæ under consideration minister to some sense unknown to us, they must be olfactory organs.

## EXPLANATION OF PLATE XIII.

- FIG. 1. Rostrum of *Daphnia pulex* showing antennule and olfactory setæ, etc.,  $\times 75$ . *a.* Antennule. *b.* Chitinous beads at bases of olfactory setæ. *g.* Ganglion. *l.* Lateral pointed seta. *n.* Nerve from brain. *o.* Tuft of nine olfactory setæ. *t.* Nerve threads from olfactory setæ to ganglion.
- „ 2. An olfactory seta from *Leptodora hyalina*  $\times 400$ .
- „ 3. „ „ „ „ *Simocephalus vetulus*  $\times 600$ . 3A. Tip of seta.
- „ 4. „ „ „ „ *Eurycercus lamellatus*  $\times 600$ . 4A. Tip of seta. Homologous parts are lettered as in Fig. 7.
- „ 5. „ „ „ „ *Daphnia pulex*  $\times 700$ .
- „ 6. „ „ „ „ *Acantholeberis curvirostris*  $\times 400$ .

- FIG. 7. An olfactory setæ from *Asellus aquaticus*  $\times 1,000$ .  
 Given for comparison. *a.* Hyaline distal portion of seta divided into two sections by a slight difference in diameter. *b.* Stalk with strongly chitinised walls. *c.* Epidermis of antennule. *d.* Nerve thread to ganglion.
- „ 8. Antennule of *Alona affinis*  $\times 275$ .
- „ 9. „ „ *Alona quadrangularis*  $\times 275$ .
- „ 10. „ „ *Bythotrephes longimanus*. Example of an antennule with 5 olfactory setæ. *a.* Accessory simple seta.
- „ 11. „ „ *Holopedium gibberum*  $\times 450$ . Example of an antennule with 6 olfactory setæ. *a.* Accessory simple seta.
- „ 12. „ „ *Leptodora hyalina*  $\times 120$ . Example of an antennule with 9 olfactory setæ. *a.* Accessory simple seta.

TABLES FOR CORRECTING ERRORS IN CAMERA DRAWINGS AND  
PHOTOMICROGRAPHS.

By EDWARD M. NELSON, F.R.M.S.

(Read May 15th, 1896.)

It is well known that in drawings made with a camera distortion will be present unless the whole surface of the paper be kept at a uniform distance from the centre of the eye lens; in other words, the picture to be accurate must be drawn in the hollow of a spherical shell whose radius is the distance of the centre of the eye lens.\* As this process is not very practical the following tables show the errors in drawings made on a plane surface, the distance of the centre of the eye lens from the paper being 10 inches, or 254 mm. By applying the corrections given in the tables to any drawing made on a plane surface an accurate picture can be very easily obtained. It will be seen that the error is not so great as is generally supposed, for it only amounts to 5 per cent. in an image which is about 8.0 inches in diameter, or 4.0 inches on either side of the vertical from the eye lens to the centre of the drawing. A drawing intended for illustration in scientific works seldom attains 5 inches in length; the first table shows that the error for that size is only 2 per cent. Thus, if the true magnification were 100 diameters the distortion would correspond to a magnification of 102 diameters. Therefore, in accurately measuring magnifying powers the images of the micrometer scale should never exceed  $2\frac{1}{2}$  inches, or 62 mm.

The first table gives the percentages of the errors with various *diameters* of images; the second table the actual amount to be subtracted from a drawing made on a plane surface to make it similar to one drawn in the hollow spherical shell. The figures in the first and third columns of the second table are *radii*, viz., the distances of the images from the point where a perpendicular from the centre of the eye lens would meet the paper; the second and fourth columns show the amount to be *subtracted* from the lengths in the first column to correct the errors on one side of a drawing; therefore in correcting the whole drawing proper amounts must be taken from the other sides as well.

\* An ordinary camera drawing on a plane surface, 10 inches from the eye lens, is a gnomonic projection of a sphere 20 inches in diameter, hence the distortion follows the law of that method of projection.

The above rules apply equally to photomicrography when the projection distance is 10 inches. The percentages in the 3rd column of Table I., and the errors in the 2nd and 4th columns of Table II., may be found for projection distances other than 10 inches, as they are inversely proportional; thus at projection distances of 20 inches the percentages and errors will be half, and of 5 inches double the amounts given in the following tables.

If a camera of the form designed by Mr G. Burch and exhibited here in 1878, now known as Abbe's camera, be used the distance of the paper from the mirror must be 10 inches minus the distance of the mirror from the centre of the eye lens.

*Example.*—The image of .01 inch projected by Dr. Beale's camera on a rule distant 10 inches from the eye lens measures 8 inches. What is the true magnifying power?

Ans.:—800 less 5 per cent. = 760 diameters.

I.  
Diameters.

Inches.	MM.	Per cent.
2.46	62	0.5
3.48	88	1.0
4.28	109	1.5
5.00	127	2.0
5.62	143	2.5
6.16	156	3.0
6.68	170	3.5
7.18	182	4.0
7.66	195	4.5
8.10	206	5.0

II.

Radii. Inches.	Error. Inches.	Radii. MM.	Error MM
1.0	.0033	25	.084
1.25	.0065	32	.165
1.5	.011	38	.28
1.75	.018	44	.46
2.0	.026	51	.66
2.25	.037	57	.94
2.5	.050	63	1.27
2.75	.066	70	1.68
3.0	.085	76	2.16
3.25	.108	83	2.74
3.5	.133	89	3.38
3.75	.162	95	4.11
4.0	.195	102	4.95



## PROCEEDINGS.

MARCH 6TH, 1896.—CONVERSATIONAL MEETING.

<i>Amurea aculeata</i> ... ..	Mr. J. M. Allen.
<i>Adineta barbara</i> ... ..	Mr. D. Bryce.
<i>Callidina cuticularis</i> , n. sp. ... ..	Mr. D. Bryce.
<i>Trachelius</i> , sp. ? ... ..	Mr. W. Burton.
<i>Tingis cardui</i> ... ..	Mr. R. T. Nevins.
Cyclosis in <i>Closterium</i> ... ..	Mr. W. R. Travers.

MARCH 20TH, 1896.—ORDINARY MEETING.

J. G. WALLER, ESQ., F.S.A., President, in the Chair.

The minutes of the preceding meeting were read and confirmed.

The following gentlemen were balloted for and duly elected members of the Club:—Mr. Laurence Galsworthy, Mr. C. P. Lucas, Mr. S. R. Micklewood, Mr. Henry Pantin, Mr. Herbert S. Martin, Mr. S. W. Fletcher, M.D., and Mr. J. Rheinberg.

The following donations to the Club were announced:—

“Proceedings of the Belgian Micro- scopical Society” ... ..	} From the Society.
“Proceedings of the Eastbourne Natural History Society” ... ..	
4 Vols. “Nova Acta” of the Leopold Caroline Academy ... ..	} “ ”
“Introduction to the Study of Seaweeds,” by Mr Murray ... ..	
Slides of mounted Rotifers ... ..	Mr. C. Rousselet.
Drawings of plant root hairs, &c. ... ..	Mr. E. B. Green.

The thanks of the Club were voted to the donors.

Mr. C. Rousselet read a paper “On *Rattulus Collaris* and other Rotifers,” illustrated by drawings and specimens, exhibited

in the room. Mounted specimens were also presented to the Cabinet of the Club.

The thanks of the Club were unanimously voted to Mr. Rousselet for his communication and donation.

Mr. E. B. Green exhibited some drawings of root hairs with parasitical growths upon them. He found some time ago what he thought was organisable matter on many of these root hairs, but had since found that they were spores, some of which were conjugating. Thinking that the subject was worth studying he had made a case in which about 40 pots could be placed and 40 varieties grown under favourable conditions by any person not possessed of a greenhouse.

In reply to a question from Mr. Karop, Mr. Green said that the drawings exhibited were made with Chinese White on black paper.

On the motion of the President the thanks of the Club were voted to Mr. Green for his communication and for the very beautiful drawings presented to the Club in illustration.

Mr. Neville inquired what vegetables Mr. Green had experimented upon; he was not able to be present when Mr. Green's paper was read.

Mr. Green said he had experimented with all those mentioned in the paper which was printed in the last number of the Journal.

Mr. Karop gave an interesting resumé of the Natural History of the Mycetozoa, illustrating the subject by coloured diagrams and by drawings upon the board. In concluding he strongly recommended to the attention of those who were interested in the subject a little guide book, lately published by the British Museum authorities, and prepared by Mr. A. Lister. It contained descriptions of all the known British species, was well illustrated, and could be obtained at the Museum for 3d.

The President felt sure that the members would pass a very hearty vote of thanks to Mr. Karop for his very interesting account of this group of fungi.—Put and carried.

Mr. Karop said that in case the next number of the Journal was not out in time to let members have their cards of the excursions he would announce that the first excursion of the season was arranged to take place on March 28th to Chingford, members to meet at Liverpool Street Station. There would be

no gossip night on the first Friday in April, as that would be Good Friday. The next meeting of the Club would therefore be the ordinary meeting on April 17th.

The proceedings then terminated with the usual conversazione, the following objects being exhibited:—

<i>Euchlanis triquetra</i>	...	...	...	Mr. W. Burton.
Mouth of a Dipterous larva	...	...	...	Mr. H. E. Freeman.
<i>Podura</i> scale	...	...	...	Mr. W. Goodwin.
<i>Polyarthra platyptera</i> , var. <i>euryptera</i>	...	...	...	} Mr. C. Rousselet.
<i>Rattulus collaris</i>	...	...	...	
<i>Schizocerca diversicornis</i>	...	...	...	

APRIL 17TH, 1896.—ORDINARY MEETING.

MR. J. G. WALLER, F.S.A., President, in the Chair.

The minutes of the preceding meeting were read and confirmed.

Mr. S. Haskew and Mr. F. Enock were balloted for and duly elected members of the Club.

The following donations to the Library were announced:—

“Journal of the Royal Microscopical Society”	...	...	...	} From the Society.
“Proceedings of the Manchester Microscopical Society”	...	...	...	
“Proceedings of the Portland Society of Natural History”	...	...	...	} “ ”
“The Botanical Gazette”	...	...	...	} “ ”
“Proceedings of the Belgian Microscopical Society”	...	...	...	} In exchange.
“Proceedings of the Royal Society”	...	...	...	} “ ”
“Proceedings of the Geologists’ Association”	...	...	...	} “ ”
“Le Diatomiste”	...	...	...	} The Editor.
“The Wonders of the Microscope”	...	...	...	} Mr. E. Poulson.

The thanks of the Club were unanimously voted to the donors.

Mr. E. M. Nelson exhibited his latest form of Doublet Bull’s-eye, the construction of which he had referred to in his Presidential Address. Some further explanations were now

given by means of diagrams on the board, and the superiority of the combination for illuminating purposes was practically demonstrated.

The thanks of the meeting were given to Mr. Nelson for his communication.

Mr. R. T. Lewis read a "Note on a Stridulating Organ in a South African Ant," illustrating the subject by drawings and by a specimen exhibited under the microscope.

Mr. E. T. Newton said this appeared to be a new form of stridulating organ to be added to the number already known, and it was very curious to notice how many different forms there were, not only in different orders of insects, but sometimes also in the same family, for producing a like effect.

Mr. Karop suggested that an organ of this kind for producing special sounds seemed to imply also the existence of an auditory organ for the perception of the sounds. These were very highly developed in some of the grasshopper tribe, but he was not aware that much was known about them in the *Hymenoptera*. It seemed a point of interest worth looking up.

The thanks of the meeting were voted to Mr. Lewis for his paper.

Mr. Karop regretted that the omission of the last gossip night in consequence of Easter had prevented him from meeting with members on that occasion and obtaining any further papers for the present meeting; and there being nothing further upon the agenda,

Announcements of meetings and excursions for the ensuing month were made, and the proceedings terminated with the usual conversazione, at which the following objects were exhibited:—

<i>Asplanchna priodonta</i>	...	...	...	Mr. J. M. Allen.
<i>Acineta</i> , sp. ?	...	...	...	Mr. W. Burton.
Head of Lace-wing Fly	...	...	...	Mr. W. Goodwin.
Stridulating band on abdomen of an Ant				Mr. R. Lewis.
<i>Corethra plumicornis</i> (mounted)	...	...	...	Mr. R. T. Nevins.

---

## MAY 1ST, 1896.—CONVERSATIONAL MEETING.

<i>Plumatella repens</i>	...	...	...	Mr. W. Burton.
<i>Bugula turbinata</i>	...	...	...	Mr. G. E. Mainland.
<i>Anopheles bifurcatus</i>	...	...	...	Mr. R. T. Nevins.

## Sections—

Mica-Hornblende	Pikrite, Sutherland	}	Mr. G. Smith.
Dolerite,	Portrush, Antrim		
Leucite in larva,	Reeden, Eifel		
<i>Corethra plumicornis</i>	(mounted)	...	Mr. A. J. Swanson.
<i>Hydatina senta</i>	...	...	Mr. W. R. Traviss.
<i>Pulex irritans</i>	(larva)	...	Mr. J. C. Webb.

## ORDINARY MEETING.—MAY 15TH, 1896.

J. G. WALLER, Esq., F.S.A., President, in the chair.

The minutes of the preceding meeting were read and confirmed.

The following gentlemen were balloted for and duly elected members of the Club :—Mr. Arthur H. Coote, Mr. J. W. Dadd, Mr. Edward Poulson.

The following donations were announced :—

“Proceedings of the Royal Society”	...	From the Society.
“La Nuova Notarisia”	...	.. Editor.
“Transactions of the Natural History Society of Glasgow”	...	} „ Society.
“Synopsis of the Naviculoid Diatoms,” part ii.	...	
	...	Prof. P. T. Cleve.

The thanks of the Club were voted to the donors.

Mr. Miles exhibited a specimen of *Aulacodiscus gigas* from the Sendai, the first perfect one he had yet seen.

Mr. Karop regretted the absence of Mr. Morland, who might have been able to say something interesting regarding this diatom and the Sendai deposits in general, which contained many fine forms.

Mr. F. Enock read a note “On two New Aquatic Hymenoptera,” *Prestwichia aquatica* and *Caraphractus cinctus*, specimens of which he exhibited under microscopes in the room.

The thanks of the Club were unanimously voted to Mr. Enock for his communication.

Mr. Nunney read a note "On certain Discs found on the Stigmal Veins of a Chalcid Fly."

Mr. Ingpen said that the specimens were amongst a number of insects he received some time ago as examples of iridescence. He was rather struck by the appearance of these discs, and the question was suggested whether there was a nerve connected with them, and if so what was its character. It seemed to him that there was a well-developed nerve there, and he thought there could be little doubt that so large a nerve would have some important function beyond that of merely supporting the framework.

Mr. A. D. Michael said it was difficult to say anything about a thing which he had not had any opportunity of examining. It was, however, well known that there existed a more or less vibratile disc within the stigma, and that this being more or less in the air passage was supposed to be capable of closing the stigma; and he did not know that there was any inherent impossibility in there being an auditory organ in such a position. It would also appear to follow that if the vibratile disc was constantly in use the nerve would be large. It was, however, very important to see if the nerve ended in a nerve terminal, for only this would give the impression that it was a sense organ. It was quite possible that it was one, and that these vibratile discs had the function of closing the stigma on fitting occasions.

The thanks of the meeting were voted to Mr. Nunney for his note on this subject.

Mr. E. M. Nelson exhibited a small and extremely pretty portable microscope, which had been made by Mr. Baker. It was remarkably firm in use, having a large spreading tripod foot 6in. to 7in. wide. It was fitted with a rack-work coarse and a direct acting screw fine adjustment—a chromatic doublet substage condenser, with an iris diaphragm attached, focussing by a sliding tube—and it had both plane and concave mirrors. The body extended to 6½in. by a draw tube, and its weight altogether was 2lb. He was sure that this would be found a very useful travelling microscope. He also read a note "On Correcting the Errors in Camera Lucida Drawings." The picture drawn in this way, in order to be accurate, should be drawn on the inside of a spherical shell; and if drawn on a plane

it would be distorted towards the edges, and the corrections given must be applied in order to reduce it to accuracy. The amount of the distortion was, however, not very serious, being only five per cent. in a drawing of 8in. in diameter, and two per cent. in one of 5in., but in  $2\frac{1}{2}$ in. the distortion was so slight as to be practically *nil*.

Mr. Ingpen inquired if Mr. Nelson had ever tried to remedy the distortion by an adjustment of the eyepiece? If they took two plane convex lenses and placed them back to back it would be possible to shift them so as to get an image which would hardly be distorted at all.

Mr. Nelson said he had worked at something of this sort, but did not do it in the same way, although his idea was similar. He put a lens below the camera to correct the distortion in such a way that whilst it had no magnifying power it distorted the margins.

Mr. Ingpen said that in the course of some experiments on eyepieces he found out the variations which could be produced, and he thought the principle could very likely be applied to meet the case by the exercise of Mr. Nelson's well-known skill.

Mr. Enock inquired how a Camera lucida could be fitted over the eyepiece of such a pattern as the one on the table?

Mr. Nelson said it could be done by Zeiss's plan by passing it over the rim and fixing it with three set screws, which he thought was a very clumsy method.

Mr. Enock thought so too. Certainly it was a method which tried the temper very much.

Mr. Karop read a paper "On the Illumination of Objects with Artificial Light under Low Powers."

Mr. Ingpen said that with higher powers it was easy to use the whole aperture of the object glass, but the great advantage of this plan was that it enabled the whole aperture of a low power lens to be utilised.

Mr. Nelson thought the point brought out by this paper was an extremely valuable one, especially for low and medium powers.

The President said their Secretary was always ready to come forward and help in any emergency, and they had now to thank him not only for doing this, but also for the very excellent paper he had given them.

The thanks of the meeting were unanimously voted to Mr. Karop for his paper.

Mr. Nelson remarked upon the curious fact that whilst the older observers saw such very delicate objects as the cilia on volvox they seemed to have missed larger things, such as the cilia of floscularia. He found on some old illustrations dated 1797 cilia figured on volvox.

Mr. Karop thought that from the currents caused they might have inferred the existence of cilia, but in the case of opaque objects their means of illumination were very primitive.

Meetings for the ensuing month having been announced, the proceedings terminated.

The following objects were exhibited:—

<i>Plumatella repens</i> ...	...	...	...	Mr. J. M. Allen.
<i>Conochilus unicornis</i>	...	...	...	Mr. W. Burton.
<i>Prestwichia aquatica</i> (Lubbock)...	...	...	...	Mr. F. Enock.
<i>Leptogaster cylindricus</i>	...	...	...	Mr. H. E. Freeman.
<i>Pulex</i> . brain	...	...	...	Mr. W. Goodman.
<i>Callimone flavipes</i> ...	...	...	...	Mr. J. E. Ingpen.
<i>Aulocodiscus giganteus</i> , Japan	...	...	...	Mr. J. Miles.
<i>Hydrobius</i> , sp. ?	...	...	...	Mr. R. T. Nevins.
<i>Rhinops vitrea</i> ♂	...	...	...	Mr. C. Rousselet.
<i>Asplanchna priodonta</i>	...	...	...	Mr. W. R. Traviss.

---

#### JUNE 5TH, 1896.—CONVERSATIONAL MEETING.

<i>Pedalion mirum</i>	...	...	...	Mr. W. Burton.
<i>Discorbina</i> , sp. ? Greenland	...	...	...	Mr. A. Earland.
Scales of Clothes Moth	...	...	...	Mr. J. Holder.
<i>Craspedoporus coscinodiscus</i>	...	...	...	Mr. H. Morland.
<i>Ascilius sulcatus</i> (larva)	...	...	...	Mr. R. T. Nevins.

---

#### ORDINARY MEETING.—JUNE 19TH, 1896.

J. G. WALLER, Esq., F.S.A., President, in the Chair.

The minutes of the preceding meeting were read and confirmed.

Messrs. Clark, McNeill, Sidwell, and Theobald were balloted for and duly elected members of the Club.



The following donations to the Club were announced :—

“Proceedings of the Royal Institution,” part 3 ... ..	} In exchange.
“Proceedings of the Belgian Microscopical Society” ... ..	} From the Society.
“Proceedings of the Royal Institution of Cornwall” ... ..	} ”
“The American Monthly Microscopical Journal” ... ..	} In exchange.
“The Microscope” ... ..	} ”
“Annals of Natural History” ... ..	} Purchased.
“Proceedings of the Royal Society” ... ..	} In exchange.

The thanks of the Club were voted to the donors.

The Secretary said they had also received from their old friend Mr. Andrew a bottle containing sea water and mud from the bottom, dredged up by the *Challenger* expedition. This was of course by this time rather ancient, and if it had contained many living organisms it might be advisable not to open it in the room. It would, however, be handed over to their Curator to deal with, and if found of interest the contents would be at the disposal of any members of the Club who desired to have any. Meanwhile they would express their thanks to Mr. Andrew, who, though not now able to come amongst them as he once did with such regularity—and never without his microscope and something interesting to exhibit—still showed a practical interest in the well-being of the Club.

Mr. Ingpen said he was sure all present would be pleased to hear from their old member and friend Mr. Andrew, who whilst able to do so was one of the most regular attendants at their meetings, and who always exhibited something when he came, considering this to be his duty to the Club. If all the members endeavoured to fulfil their duties as well as Mr. Andrew it would no doubt be very greatly to the advantage of the Club.

Surgeon V. Gunson Thorpe, R.N., said it had been his good fortune during his five years' absence from the meetings of the Club to visit several countries of the East. For one year he was on the China station on board H.M.S. *Peacock*, and was for some time in the neighbourhood of Woo-hoo, 260 miles up the Yangtse Kiang, the largest river of China, and one of the largest in the world, ranking perhaps next to the Amazon. At

the part mentioned, although so far from its mouth, the river was about three miles wide; it passed through the great central plain of China, which was the great rice-growing country. The rice fields were irrigated by numerous canals, from which the surplus water collected into pools in which the sacred lotus lily grew abundantly. These pools teemed with life, especially Rotifers; the sides of the weeds were frequently covered with a kind of fluff on which could be seen new species of *Melicerta*, *Lacinularia*, and *Trochosphaera*. The species which had been described — *Trochosphaera Equatorialis* — was originally found in the Phillipine Islands, and was so named because of the row of cilia which formed a ring round it, dividing its globular body into two hemispheres. In addition to this he had found one which he had called *T. solstitialis*, because the ring of cilia was situated about in the position of one of the tropics, or about midway between the equator and the pole. Another new Rotifer found both in China and Australia was *Megalotrocha spinosa*, a specimen of which he was showing under one of the microscopes on the table, and both at Brisbane and in China he had found two species together, *Spinosa* and *Semilobata*. He also visited the Solomon Islands in H.M.S. *Penguin*, which was carrying on a survey of New Georgia, and on landing upon one of the islands he found a hole cut by the natives in the stem of a cocoa-nut tree for the purpose of catching rain-water, which contained about twelve or eighteen inches of water, and in this he found *Pedalion*; how it got there was certainly a very curious puzzle. *Brachionus militaris* was quite common in China. He had also found a *Ploscule* which was first found by Mr. Whitelegge of Sydney, and thought by Dr. Hudson to be a variety of *P. coronetta*. Dr. Hudson had, however, described it from a drawing only, and he thought he should be able to show that it had a specific value; at first sight it looked very much like a *Stephanoceros*. He had tried hard to get a specimen of *Lacinularia pedunculata* in which the colony was attached to the stem of a plant by a peduncle apparently formed of the feet of the various individuals twisted together, but the only one he was able to show was not mounted by Mr. Rousselet's method, although the peduncle could be seen. Another of the Rotifers which he had procured was a species of *Rhinops*, which was first found in the bogs of Ireland; it appeared to be common both in China and Ceylon.

Mr. Ingpen could only say how very much he welcomed communications such as the one they had just heard, which seemed to keep them in touch with all parts of the world with which they were glad to keep up communication, and he had never failed to impress upon members going abroad the desirability of sending home something for the interest and benefit of the Club. The value of methods of preparing and mounting as that introduced by Mr. Rousselet could hardly be overstated, because if they could get a gentleman who had several months to spare in China to preserve Rotifers in that way, specimens could be brought home in a condition which put them beyond all doubt or question, whereas drawings and observations were sometimes apt to be questioned.

Mr. Neville thought the Society was very much indebted to Mr. Gunson Thorpe for his very interesting description, and felt that many of the members must have envied him his opportunities. He had been able to work in a scientific spirit, and to give them some results of which they might feel proud as having a member able to carry on these observations under such circumstances, and from whom they might expect still greater things in years to come.

Mr. Karop said he should like to inquire of Surgeon Gunson Thorpe on one point, although personally he knew very little indeed about Rotifers. He did know, however, that Chinamen were about the most dirty creatures on the face of the earth, but at the same time they were the most splendid gardeners, and as it was their habit to save up every particle of excrement in order to distribute it over their gardens, he thought that these canals which Mr. Thorpe had spoken of must to a large extent be contaminated with sewage matter. He believed that it was found here that as soon as water became so contaminated very many of these forms disappeared. If this was so he thought it was curious that Rotifers should be found in such abundance in these waters.

Mr. Hardy thought that the facts were rather the other way, and that a dead dog in the water was generally a sign that there would be plenty of Rotifers.

Mr. Chapman used to know a pond on Clapham Common where there were some most beautiful Rotifers to be found and *Stephanoceros* were abundant. This pond not only had sewage flowing into it, but there were generally a number of dead cats

and dogs there. He thought this condition of things was conducive to Rotifer life rather than otherwise.

Mr. Hardy said that when the New River was at its worst, then was the best time to find these organisms.

Mr. Ingpen said he went dredging some time ago to Leigh, near Southend, and got a lot of common marine organisms, which he brought up to London in a quantity of water from the place, but he found they all died when he put them into his aquarium. The water in which he found them was practically sewage water, and they lived in that all right, but as soon as they got into other water they died.

Mr. Bryce thought an important point in keeping these things alive was to have plenty of weed of some kind in the water, for directly they put a lot of creatures into the water they began to exhaust the oxygen, but if there was some weed growing there it kept up the supply and purified the water. With plenty of weed in the bottles there was no trouble, and he had kept a fish in water in this way for three months, and he had all sorts of Entomostraca, etc., but directly he took the plants out the fish died and he kept nothing.

Mr. V. Gunson Thorpe said the whole of this discussion seemed to be based upon the assumption that the water in the pools and ditches he had referred to was sewage water, whereas the water was pure. If the sewage got into the water this would be regarded as waste, and the Chinese never wasted anything. They collected and preserved all sewage in wells or receptacles made for the purpose. No doubt plant life helped to keep water pure, and the abundance of plant life here was remarkable. The extremes of temperature in these parts were very great, for whilst the summer heat was very great, in winter these ponds were thickly frozen over. Of course, when he spoke of the water being pure he did not mean fit to drink, for China was the home of cholera, and the deaths from that disease every year might almost be reckoned by millions. The cholera bacillus seemed to abound, and probably the country would be decimated if it were not that the Chinese almost invariably drank things hot—indeed, if a great Mandarin invited a number of distinguished persons to visit him he would probably offer them boiling champagne. In the plains of China the ponds were kept from being polluted by being so far from any houses, but there would be ponds all around, so

that from a low hill it would be possible to count perhaps 40. When speaking of Rotifers earlier in the meeting he had not mentioned one very beautiful Rotifer which he found. This was a Melicertian with eight lobes, described some time since in the "R. M. S. Journal." This was a very beautiful creature, very large, and by no means shy, expanding again in all its beauty almost immediately after it had been shut up. When Mr. Rousselet sent him the notes of his method he was just on the point of leaving China, so that all the specimens which he had been able to preserve in this manner had been met with on his way home.

Mr. Ingpen said on the question of the Chinese not drinking cold water, it occurred to him that some years ago when the late Dr. Cobbold was with them he read some papers on Filaria, and he then attributed the prevalence of the disease caused by them in China to the fact of the Chinese drinking cold water containing them.

The President said they were extremely indebted to Mr. Gunson Thorpe for his very interesting communication, and he only hoped that they might at some future time be favoured with some further description of these very interesting Rotifers.

A hearty vote of thanks was then put to the meeting and carried unanimously.

The Secretary reminded the members that this was their last ordinary meeting for the present season, and that the next would be held on September 18th.

Announcements of excursions during the next three months were then made, special attention being called to the day excursion to Whitstable on September 5th.

The following objects, etc., were afterwards exhibited:—

<i>Dendrosoma</i> , sp. ? ... ..	Mr. W. Burton.
<i>Cosmocomma fumipennis</i> ♀ (Haliday) ...	Mr. F. Enock.
<i>Actinurus neptunius</i> (mounted) ... ..	Mr. C. Rousselet.
<i>Melicerta ringens</i> ... ..	Mr. W. R. Traviss.

---

AUGUST 7TH, 1896.—CONVERSATIONAL MEETING.

<i>Cerataphis latania</i> with surrounding cur- tain of wax ... ..	} Mr. W. Burton.
<i>Surirella ovalis</i> , Bréb., frustules and several mal-formed valves ...	
	} Mr. H. Morland.

## AUGUST 21ST, 1896.—CONVERSATIONAL MEETING.

*Noteus quadricornis* ... .. Mr. W. Burton.

---

## ORDINARY MEETING.—SEPTEMBER 18TH, 1896.

J. G. WALLER, Esq., F.S.A., President, in the Chair.

The minutes of the preceding meeting were read and confirmed.

The following donations were announced:—

“The Botanical Gazette” ... ..	
“The American Monthly Microscopical Journal” ... ..	} From the Editor.
“The Microscope” ... ..	
“Proceedings of the Geologists’ Association” ... ..	} From the Society.
“Transactions of the Manchester Microscopical Society” ... ..	
“Transactions of the Hertfordshire Natural History Society” ... ..	} ”
“Transactions of the Belgian Microscopical Society” ... ..	

The thanks of the Club were voted to the donors.

Mr. Scourfield read a paper “On the Olfactory Setæ of the Cladocera,” illustrating the subject by drawings upon the black-board.

The President, in moving a cordial vote of thanks to Mr. Scourfield for his paper, said they were especially indebted to him for bringing it forward on that occasion, as owing to the holiday season not being yet over, very many of their members were still absent, and it was therefore very difficult to fill up the agenda paper.

A vote of thanks to Mr. Scourfield was unanimously carried.

A letter was read from the Secretary of the Ealing Natural Science and Microscopical Society asking the assistance of members of the Quekett Club at the Soiree to be held on October 17th.

Announcements of meetings and excursions for the ensuing month were then made, and the proceedings terminated with the usual conversazione.

---

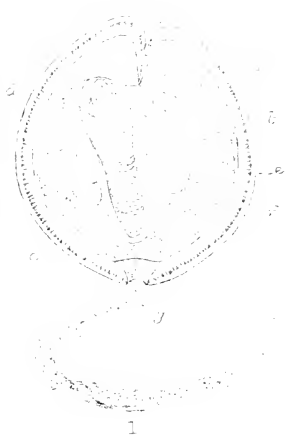
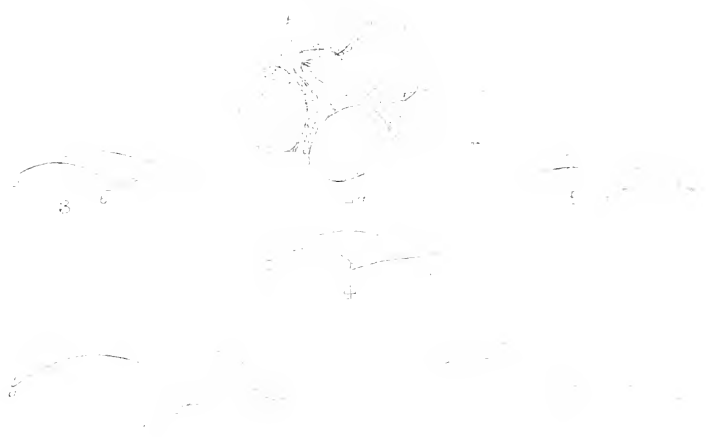

1

12





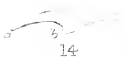
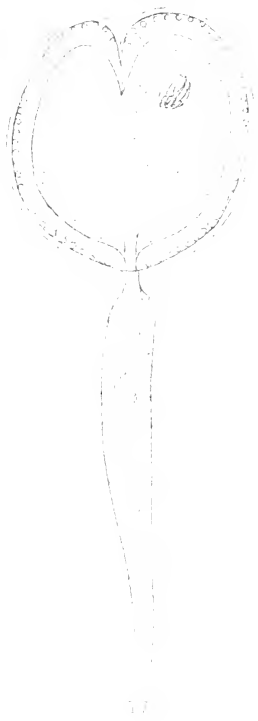

14



15

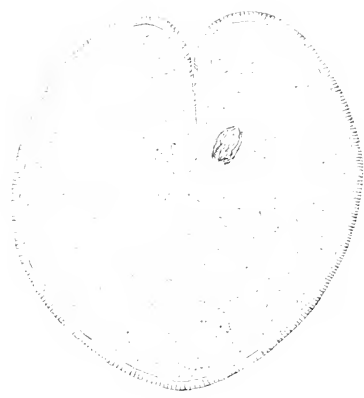

13

2a



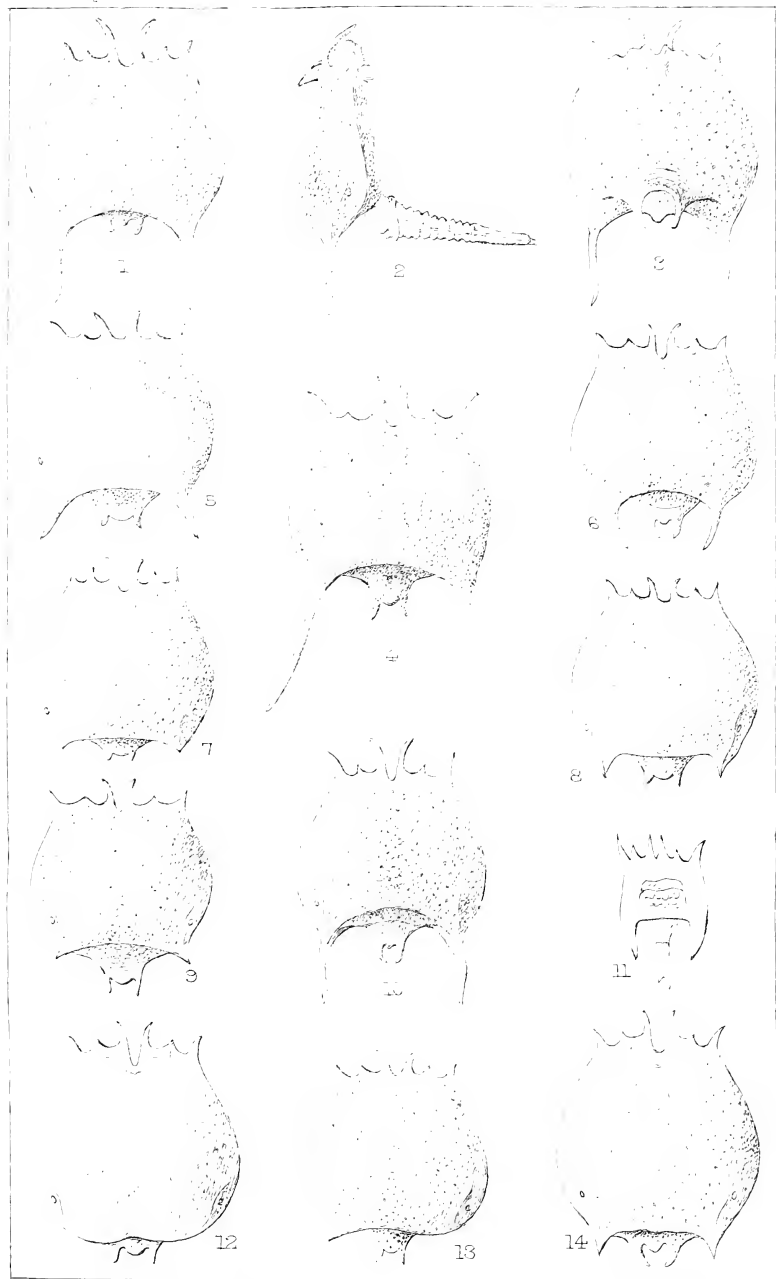

FR Dixon-Nuttall del ad nat.

West, Newman sc.

Varieties of *Brachionus bakeri*.



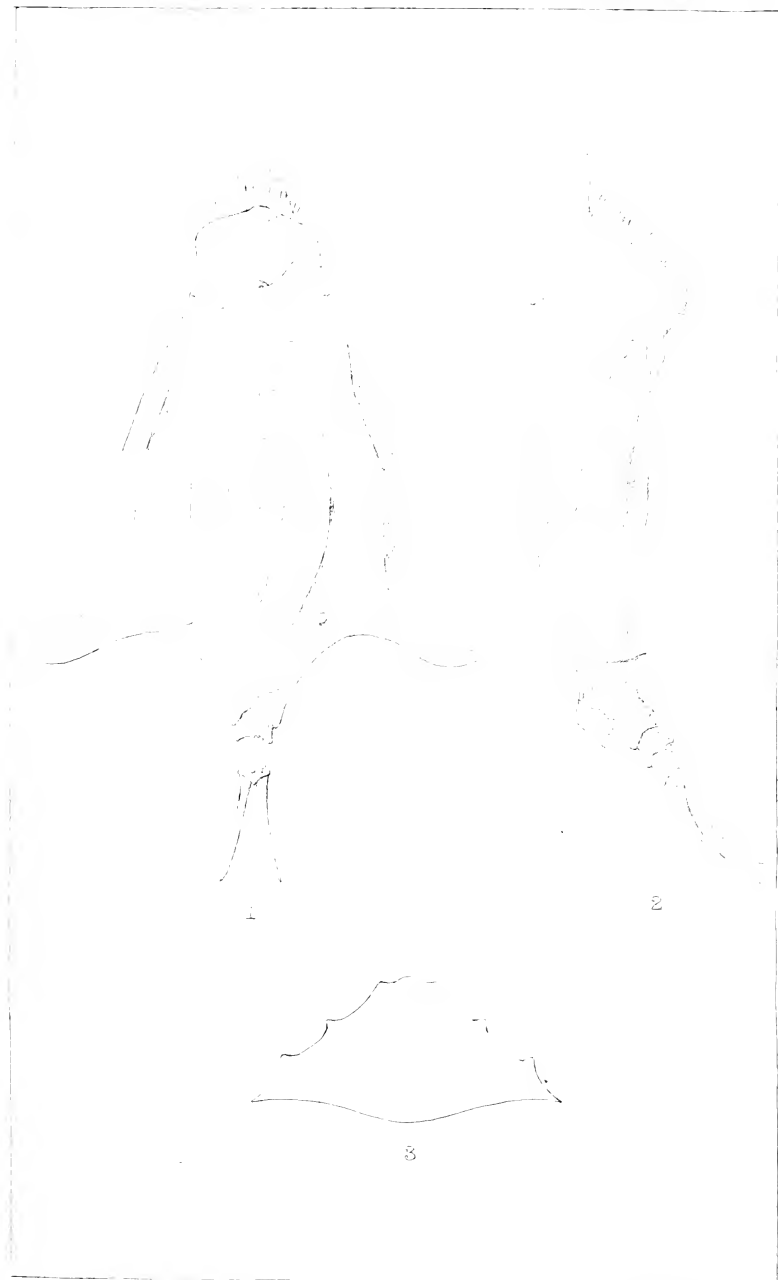



CYSTICERCUS VENUSTA (*Rosseter*).

BY T. B. ROSSETER, F.R.M.S.

*(Read November 20th, 1896).*

I took this *Cysticercus* from Langham House Pond in Gorstly Wood, near Bishopsbourne, five miles from Canterbury, the same pond from which I took *Cysticercus liophallus*, and, as in the former case, it was making *Cypris cinerea* its "nurse." It was parasitic in about 6 per mille of the *Cypris*, and was commensal with *Cysticercus gracilis* and *C. coronula*.

This number, small as it may seem, warranted me in trying to produce the mature tape-worm by feeding, or rather injecting, ducks for that purpose. Accordingly in the latter part of May I purchased some ducks, and one of these I isolated and fed every other day for twenty-one days. At the end of the twenty-one days I killed the duck, and carefully examined with the aid of a 2in. and a  $\frac{1}{2}$ in. objective the contents of the gizzard and intestine by washing and precipitating the undigested food and excreta. The duodenum, more especially, was carefully searched, knowing from past experience that they, the tape-worms, bury their scolices in the soft mucous membrane; but, although I found specimens of *Tænia tenuirostris*, *T. gracilis*, and an abundance of *T. coronula*, yet I failed to find a single specimen of the perfect *Tænia* of this *Cysticercus*.

In the first week of August I again isolated another duck, or rather a young this-year's drake, and commenced feeding it with strainings from this particular pond; but on the twenty-second of the same month I bargained with the man at the lodge to sell me the two remaining ducks he had on the pond. One of these was killed immediately on arrival home, and the alimentary tract thoroughly and carefully examined in a similar manner to that described above, but beyond a few specimens of *T. tenuirostris* and *T. gracilis*—six in all—the experiment was helminthologically a total failure. This was remarkable, as these two ducks had been on the pond over two years, and the

pond was teeming with organic life. The other duck I turned down with the drake on his run, and systematically fed them both with strainings from the pond, which I procured by weekly visitations; and on Saturday, the 26th September, I killed the remaining duck from Gorstly Pond. The same evening, whilst the body was still warm, I took out the whole of the viscera, and on examining it found a cyst as large as a boy's marble growing on the duodenum; it was adhering to the mesentery and the outer wall of the duodenum, and it was enveloped with a thin membrane. I at once placed it in a hardening medium to prepare it for cutting into sections.

I first examined the contents of the duodenum. There were a great number of *T. tenuirostris*, in various stages of growth, making it their abode. As I proceeded down the alimentary tract *T. tenuirostris* became more scarce and *T. gracilis* took its place, and then as I drew near to that part of the tract where the cæcum is situated—in the ducks it is double or paired—*T. gracilis* vanished, and not only the contents of the intestine, but likewise the wall of the same was one mass of *T. coronula* in various stages of growth, but beyond this the remaining portion of the intestine was entirely free from the scolices of these parasites.

I spent eighteen hours in the examination of the viscera of this duck, and the failure to produce the mature tape-worm of this *Cysticercus*, for I did not find a single specimen, was disappointing and somewhat disheartening, as each of the other species of *Cysticercus* that were injected were looked upon in the light of a control experiment, because they were not only taken from the same pond, but, as I have said above, both *gracilis* and *coronula* were commensal with it in the body cavity of the Cypris. *T. tenuirostris* seems to exclusively make the Copepods its host, as I have never seen it being nursed by any other crustacean.

Thus the third duck was a complete failure!

On Saturday, 18th October, I killed the drake isolated in August, and fed from that date with this *Cysticercus*. On examination neither gizzard nor duodenum contained *Tæniæ* of any description, but about two inches further down the intestine I was fortunate enough to discover four specimens of tape-worm, the product of, and identical with, my new



Cysticercus; and, although I carefully examined the whole of the intestine, I did not find another specimen of this Tænia. I also found in the same localities specimens of the same Tæniæ I have mentioned as being parasitic in the other ducks.

Having related the method pursued in the production, or rather rearing, of this tape-worm from the Cysticercus, I shall proceed to describe them both, prove their identity one with the other, and contrast and show on what points they differ from other species of Tænia, in the category of which they will have to be placed.

*Description of Cysticercus (Fig. 1).*

The cyst is oval in its formation. Its long diameter is 0·27 mm., its median diameter 0·24 mm. In the majority of instances of those examined, the embryonic scolex (Fig. 1a) was well formed. The four suckers (Fig. 1) have the appearance of being strong muscular organs, their length in this the intermediate stage is approximately 0·098 mm. long and 0·065 mm. wide. The rostrum (Fig. 1c) is, like the rostrum of *C. gracilis*, vermiform or annulated. This vermiform body is, in my opinion, analogous with that which exists in the growth and development of the head of *Cysticercus pisiformis*, and the same peristaltic action is to be seen in these cystic bodies, even when detached from their nurse. These annulations appear to be strong muscular bands, and are more clearly perceptible when the rostrum is invaginated, or embedded in the soft plasma of the embryonic scolex. The base or crown of the rostrum forms a dome, it then narrows as it descends, and is, as will be seen on reference to Fig. 1, club-shaped in form. Its length is 0·144 mm., width at dome 0·050 mm., and its narrowest part, that is to say at its termination, 0·021 mm. Around the dome of the rostrum are eight well-defined characteristic hooks (Fig. 1d), whose length is 0·051 mm., and divisible thus: *a-b*, 0·024 mm.; *a-c*, 0·051 mm.\*

*The Tapeworm (Fig. 2a, 2b, 2c, 2d).*

It is not my purpose to give a minute account of this tapeworm, as a special paper will be written describing it in detail,

\* These notes on this Cysticercus were written previous to finding the tapeworm.

more especially the construction and formation of the genital organs. My object is to establish the species; I shall therefore confine myself to what I consider is of more vital interest in proving the identity of this tape-worm with the *Cysticercus*, and the specific character of the *Tænia* itself. I feel sure it will facilitate reference and assist criticism if, before I pass on to my opinions and enunciate my views, I place before you in a tabulated form the measurement of these hooks as I found them, both in the *Cysticeroid* stage in the body cavity of the *Cypris*; and when as prehensile organs of the mature tape-worm, in the intestine of the duck. In both cases the number of hooks on the rostrum is eight (Fig. 1d).

Hook of *Cysticercus*, *a-b*, 0.024; *a-c*, 0.051 mm.

„ „ Tape-worm, *a-b*, 0.024; *a-c*, 0.051 mm.

Here then we have demonstrable proof that these hooks, according to measurement, are identical; but this would scarcely be sufficient evidence to rely on if it were not for the fact that these hooks are the fac-simile of each other in their formation. If Figs. 3 and 4 are compared, it will readily be conceded that these two hooks are identically the same in both these stages of the life-history of the creature; and not only do these hooks correspond with each other, but so also does the rostellum, which in the adult or perfect scolex still maintains its characteristic club-shaped, annulated formation, which I have mentioned above in describing the *Cysticercus*.

Having thus demonstrated that this *Cysticercus* and tape-worm are identical, and that the *Tænia* from the drake is the perfected scolex of the *Cysticercus* from Gorstly Wood Pond, I shall now proceed to compare and contrast this tape-worm with those *Tæniæ* whose rostrum bears eight hooks, but it must be borne in mind that the conclusions arrived at in connection with the hooks of this tape-worm apply also to the hooks of the *Cysticercus*.

There are, according to Krabbe, 165 species of tape-worms parasitic in birds, and of this number, less the one I am describing, there are only six whose rostellum bears eight hooks, and of these six up to the present time we are only acquainted with the *Cysticeri* of two, viz., *C. gracilis* (Von Linstow) and *C. fasciata* (Mavazek).

Name.	Number of Hooks.	Size of Hooks in Tenia.	Size of Hooks in Cysticercus.	Description of Hook.	Size of known Cyst.		Description of Cysticercus.
					Diameter.	Median—Long.	
<i>Tenia lanceolata</i> ...	8	0.035 mm.	×	a-b a-c 0.006—0.035 mm.	×		×
" <i>gracilis</i> ...	8	0.077 "	0.077 mm.	0.050—0.077 "	0.109—0.211 mm.		Oval indented at sides
" <i>fasciata</i> ...	8	0.057 "	0.056 "	0.034—0.057 "	0.16—0.14 "		Lenticular
" <i>fragilis</i> ...	8	0.056 "	×	0.034—0.056 "	×		×
" <i>octacantha</i> ...	8	0.036 "	×	0.012—0.036 "	×		×
" <i>obvelata</i> ...	8	0.076 "	×	0.036—0.076 "	×		×
(?)							
" <i>cysticercus</i> ...	8	0.051 "	0.051 mm.	0.024—0.051 "	0.24—0.27 mm.		Oval

The cross indicates that the Cysticercus is at present unknown.—T. B. R.

I will first consider and discuss the hooks of those tape-worms whose *Cysticercus* is up to the present time undiscovered.

The hooks of *T. lanceolata* are, as will be seen by Fig. 6, both in size and formation totally at variance with those of this *Tænia*. The whole length is smaller by 0.016 mm., and the same objection applies also to *T. octacantha* (Fig. 7), which is 0.015 mm. less. A casual observer of *T. obvelata* (Fig. 8) might be disposed to think that there was, by the contour and formation of this hook, some affinity between it and this *Tænia*, but the objections applied to the two previous species apply also, but in the opposite direction, to the hooks of *T. obvelata*, which are 0.025 mm. longer than those of this tape-worm, consequently this is not the *Cysticercus* of either of these species of *Tænia*. *T. gracilis* (Fig. 9), with its *Cysticercus*, found by Von Linstow amongst débris of crustaceans in the intestine of the perch, calls for but few remarks from me, as its hooks, which measure in both instances 0.077 mm.-0.080, are not only in excess in length by at least 0.026 mm., but the whole form of the hook is totally different in comparison with the hook of this *Tænia*, and the *Cysticercus* has a distinguishing characteristic in connection with it, for, like no other *Cysticercus* with which I am acquainted, the cuticle of the cyst is indented towards the apex, or point of invagination, which gives it the aspect of being gibbous.

The two remaining *Tæniæ* of this class are *T. fasciata* (Fig. 10), whose *Cysticercus* was found by Mavazek in the body cavity of *Cyclops agilis*, and *T. fragilis* (Fig. 11), whose *Cysticercus* is at present undiscovered. I have taken these two *Tæniæ* together because, both in measurement and formation, there is a great similarity between their hooks; but there are a few points in which they differ, which are distinguishable, and enable us to identify them. The hooks of the former measure, according to Krabbe, 0.051 mm., the latter 0.056-0.059 mm. My own measurement, from specimens of the former in my cabinet, corroborates that of Krabbe. *T. fragilis* I have not seen. On reference to Table (page 309), it will be seen that the division of the hooks from *a-b* and *a-c* are in both instances nearly alike; but the difference lies in the formation of the hook. In *T. fasciata*, from *a-b* the point of the hook *a* is sharp, and gracefully sweeps

round, forming a deep concavity under the anterior root; which, jutting out, forms a prominent, attenuated, anterior root *b*. Still following the face of the hook *b-c*, the back of the anterior root curves inwards rather sharply, with a deep curve, then bulges out—convex—at the posterior root *c*, which is blunt, as if sharply cut off; the back of the hook from *c-a* forms a beautiful continuous bow. A thin line runs from *b-c* which leaves a wide semi-opaque space. The hook of *T. fragilis* thickens immediately it leaves the point *a*, and thus the curve from *a-b* is shallow, more especially at the face of the anterior root *b*, which is blunt, or bossed; and, although it, like *Fasciata*, curves inwards, yet the curvature is shallow, and becomes convex towards the posterior root, it then curves to form a miniature hook of the posterior root *c*. A thin line also runs from *b-c* as in *Fasciata*, but the semi-opaque space is very limited.

These, then, are the characteristic features of the hooks of these two *Tæniæ*. whose measurement approaches so nearly to that of the new *Tæniæ*. I will now contrast them with the hooks of this latter.

In the first place the hooks measure 0·051 mm.; in some instances in the Cysticercoid stage they are a little in excess of this measurement, thus they are 0·005 mm. less in length than either *Fasciata* or *Fragilis*. Again, the division of the hook from *a-b* is 0·010 mm. less in either case, whilst *b-c* is 0·004 mm. longer; in other words, the hook is shorter, and the posterior root or shank longer than either *T. fasciata* or *T. fragilis*. The formation of the hook, moreover, is different to those in the latter two species, for it is somewhat obtusely pointed at *a* and slightly curves inwards to form the anterior root *b*, which is stout, or bossed somewhat similar to the anterior root of *T. liophallus*.—In a few instances it runs downwards in a straight line for about 0·007 mm., then, instead of curving, it follows a course almost parallel with the back of the hook, until it arrives at the posterior root *c*, where it abruptly makes a short right angle, then circles round with a smooth surface to meet the back of the posterior root, which pursues a straight course past the anterior root, where it becomes convex to form the claw. The width of the hook at the anterior root is 0·010 mm.; and there is no semi-opaque space from *b-c*. In some cases the posterior root *b-c* is tuberculated (Fig. 5).

I think I have clearly shown the differences that exist between the hooks of *T. fragilis*, *T. fasciata*, and the hooks of this new *Tænia*; and that although the rostrum of the latter, like the former, bears eight hooks, and must be classed with them numerically, still it must be admitted that they, both of the *Tænia* and *Cysticercus*, are totally distinct from *Fasciata* and *Fragilis* in their specific character. This decision is likewise supported by the differences existing between the two *Cysticerci* (Figs. 1 and 12), the long diameter of *C. fasciata* being 0.13 mm. less than that of the new *Cysticercus*.

Having thus made it clear that this *Cysticercus* is not identical with that of either of these "six" species of tape-worm with "eight hooks" on the rostellum, and that the tape-worm in question is the perfected scolex of this *Cysticercus*, I consider I have proved it to be, both by experiment and demonstration, an entirely new tape-worm and *Cysticercus*, and therefore I feel justified in giving them a specific value, viz.,

*Tænia venusta*, n. sp. (Rosseter).

= E =

*Cysticercus venusta*, n. sp. (Rosseter).

#### TÆNIA.

Number of hooks on Rostrum, 8, arranged in a single row.

Size of hooks, 0.051 mm.-0.054 mm. *a-b*, 0.024 mm.; *a-c*, 0.051 mm.

Length of *a-b*, constant.

Habitat, intestine of domestic duck.

#### CYSTICERCUS.

Number and size of hooks same as in *Tænia*.

Diameter of cyst—long axis, 0.27 mm.; median, 0.24 mm.

Parasitic in body cavity of *Cypris cinerea*.

Locality, Langham House Pond, Gorstly Wood, Bishopsbourne, near Canterbury, Kent.

#### REFERENCE TO FIGS. ON PLATES XIV., XV.

FIG. 1. *Cysticercus*, *a*, Embryonic Scolex; *b*, Suckers; *c*, Rostrum; *d*, Hooks; *e*, Cuticle; *f*, Fluid-cavity; *g*, Caudal appendage.  $\times 175$ .

FIG. 2. *Tænia*, 2*a*, Head and portion of neck  $\times 35$ ; 2*b*, Proglottides from middle third  $\times 28$ ; 2*c*, Eight Proglottides, termination of Strobila  $\times 28$ ; 2*d*, Natural size of *Tænia*  $\frac{5}{8}$  inch. This was a young tape-worm, not sexually mature. As will be seen by the terminating proglottides it had not shed or cast off any portion of the Strobila.

FIGS. 3 and 5. Hooks of *Cysticercus*  $\times 700$ . The posterior root of Fig. 5 is tuberculated.

FIG. 4. Hook of mature Tape-worm  $\times 700$ .

.. 6. Hook of <i>Tænia lanceolata</i>	} After Krabbe, $\times 460$ .
.. 7. " " " <i>octacantha</i>	
.. 8. " " " <i>obvelata</i>	
.. 9. " " " <i>gracilis</i>	
.. 10. " " " <i>fasciata</i>	
.. 11. " " " <i>fragilis</i>	

.. 12. *Cysticercus* of *T. fasciata*  $\times 350$ . The cyst has been emptied of its contents owing to rupture by pressure. From prepared specimen in my cabinet.

.. 13. *Cysticercus* of *Tænia liophallus*  $\times 233$ .

.. 14. Hook of *Cysticercus liophallus*  $\times 700$ .

.. 15. " " *Tænia liophallus*, Krabbe,  $\times 460$ .

.. 16. " " *Cysticercus setigera*  $\times 700$  } From specimen in

.. 17. *Cysticercus setigera*  $\times 350$  } my cabinet.

.. 18. Embryonic rostellum of *C. setigera*  $\times 350$ .

.. 19. Section of cyst of *C. setigera*.

CYSTICERCUS OF *TÆNIA LIOPHALLUS*.

BY T. B. ROSSETER, F.R.M.S.

(Read November 20th, 1896.)

Number of hooks, 10; length of hooks, 0·035 mm.; *a-b*, 0·007 mm.; *a-c*, 0·035 mm.; form of cyst, globular; diameter of cyst, 0·290 mm.; habitat, *Cypris cinerea*; locality, Gorstly Wood, Bishopsbourne, Kent.

Krabbe tells us in his work "Bidrag til Kundskab om Fuglenes Baendelorme," No. XLV., page 43, that an example of *Tænia liophallus*, n. sp., is in Leuckart's collection; that this specimen is 12 mm. long and 0·8 mm. wide; that it possesses 10 hooks, whose individual length measured 0·035-0·038 mm. I must state that I have never in my investigations had the good fortune to find this tape-worm in the viscera of those ducks I have examined. This *Tænia* was discovered by Leuckart as being parasitic in *Cygnus atratus*, but Krabbe gives no date of the discovery.

At the time Krabbe wrote his work but little was known of the existence of the intermediate stage of the Cestodes applicable to birds; yet so accurately are the particular points in connection with these lowly organisms figured, more especially the hooks, that there need be no doubt in the mind of anyone in accurately diagnosing any specimen of any species from his drawings of these lowly and aberrant creatures.

In many cases, and this was the cause of Dujardin forming his genus "Proglottidina," but fragmentary portions of a Strobila are found in the viscera of the host, and then the case becomes more difficult and requires greater care in its elucidation; still, even under such circumstances the distinctive marks of the proglottides and the conformation of the genital organs enable one to arrive at an accurate decision of the nomenclature of the portion of Strobila under our observation. On the other hand but very little doubt need arise in the mind when the scolex with its appendages has been successfully



taken from the mucous membrane of the intestine and is occupying our attention. This observation is more applicable to the hooks with which the scolex is furnished. There are cases in which the scolex is inerme, although amongst those Cestodes, or rather tape-worms, who make the class "Avis" their host the inerme scolex is rare, and we have not those familiar landmarks, the hooks, to guide us. In such a case we fall back on the contour and formation of the suckers, the rostellum, if it exists, or the histology of the scolex itself. But when the scolex is furnished with hooks we are then enabled to deduce or formulate our ideas, and can build up, so to speak, one of these lowly organisms, and accurately, by the aid of the hooks, define its species.

This observation is more especially applicable to the Cysticercoid stage of these tape-worms, for here the hooks are the chief factors in forming our decision.

Krabbe, who has given us a beautiful monograph of the known Tæniæ of birds, has also given us what may be called a "Book of Reference" in his drawings of the different parts of each known species of tape-worm, more especially with respect to the hooks of the scolex. Although beyond the dimensions given by him of the hooks, I am unacquainted with the text of his work—being unacquainted with Danish—yet so beautifully are they, the hooks, drawn, and so accurately are they portrayed, that they literally speak for themselves, and the helminthologist needs no textual description to define his specimen of tape-worm or allocate the species of Cestode to which his Cysticercus is affiliated. And thus it is I am enabled to define and place in its true position Fig. 13 as being the Cysticercus, or intermediate stage, of *Tænia liophallus*.

The Cysticercus of this Tænia I found making *Cypris cinerea* its intermediate host or nurse. The Cypris was taken from a pond in Gorstly Wood, one and a half miles from the village of Bishopsbourne on the Elham Valley Railway, about five miles S.E. from Canterbury. It is a very old pond, and the man who resides in the cottage close to the pond has kept ducks on it for years past, so one naturally infers that the duck as well as the swan must be its—*Tænia liophallus*—final host.

There is a great similarity between the hooks of the scolices of *T. liophallus* (Figs. 14 and 15) and those of *T. setigera* (Figs.

16 and 17); in fact so much are they alike that the casual observer could easily be led into the error of a wrong diagnosis of the species. My reason for selecting the hook is, as I have said before, because in the Cysticeroid stage it is the chief object we have for comparison with those of the mature tape-worm so as to define and affiliate the species. The hooks of each of these species are the same in number—ten—and the same measurement in length, viz., 0·035 mm.—0·038 mm., and there is but little dissimilarity in their conformation, but to a critical observer these trifling dissimilarities soon make themselves apparent. In the first place the end of the posterior root or shank—this is the portion of the hook which is towards the apex of the rostellum—of *Tænia setigera* is drawn out to a finer point and more deeply curved than that of *T. liophallus*; the anterior root, too, is somewhat finely pointed, whereas that of *Liophallus* is bossed or thickened; the concavity or incurving of the hook in the region of the anterior root is deeper in *Setigera* than in that of *Liophallus*, whereas the whole hook of *Liophallus* is gracefully curved from point of claw to anterior root, and much stouter in consistency than that of *Setigera*. In the second place, as I have said above, the hooks of both these species of tape-worm, whether in the perfect scolex or Cysticeroid stage, measure the same, viz., 0·035 mm., and are ten in number. Yet there is even in this respect a factor to be taken into consideration, as will be seen and understood by the following discrepancies in the measurement. For convenience sake we divide the hook into two parts—from tip of hook to anterior root, and from tip of hook to posterior root or shank. The former is written *a-b*, and the latter *a-c*, and reads thus:—

Hook of <i>C. liophallus</i> ...	<i>a-b</i> , 0·010 mm.—	<i>a-c</i> , 0·035 mm.
,, <i>C. setigera</i> ...	<i>a-b</i> , 0·007 mm.—	<i>a-c</i> , 0·035 mm.
	0·003 mm.	

Thus the hook of *Liophallus* is 0·003 mm. longer from *a-b*, and 0·003 mm. shorter from *a-c* than that of *Setigera*.

These facts serve to enable us to distinguish the hooks of the two species, both in their *Tænia* as well as in their Cysticeroid stage, and must be taken into consideration in judging, forming a conclusion, and arriving at a decision as to

which species of tape-worm the hook of the *Cysticercus* belongs in its final stage, and it is on such demonstrable proofs that we mainly rely in classifying our *Cysticercoids*. In this instance we have another point to guide us, and which of itself serves to sharply define the two species of *Cysticerci*, viz., the diameter of the cyst (Figs. 13 and 17).

<i>Cysticercus liophallus</i> , diameter of cyst ...	0.290 mm.
„ <i>setigera</i> „ „ ...	0.125 mm.
	0.165 mm.

This measurement shows that the cyst of *C. liophallus* is 0.165 mm. larger than that of *C. setigera*. This, in my opinion, together with the difference that exists between the hooks of each species, establishes this *Cysticercus* as being the *Cysticercus* of *Tenia liophallus*.

This is the first recorded instance of the finding of the *Cysticercus* or intermediate stage of the above tape-worm.

When the *Cysticercus* extruded itself from the body cavity of the *Cypris* owing to the pressure applied to this and other *Ostracoda* and *Copepoda*, the caudal appendage was wanting; evidently it had been severed from the cyst by the sudden pressure applied. When the carapace of the *Cypris* is crushed the *Cysticercus* shoots out from the body cavity of its nurse, and is held in check by the caudal appendage. It is marvellous how great is the tension of the caudal appendage before the breaking-strain, which severs the caudal appendage from the *Cypris*, is reached.

I can give no information as to the formation of the scolex, suckers or rostrum in this, the *Cysticercoid* stage, as I accidentally crushed the cyst during examination, and the plasmic substance exuded was of such a diffuent, undefinable character that it was impossible to trace anything distinctive. Evidently it was in an early stage of formation. I only found one specimen of this *Cysticercus*.

## SOME NOTES ON HYDRACHNIDÆ.

BY C. D. SOAR.

*(Read November 20th, 1896.)*

The drawings on the table illustrate (so far as my own knowledge goes) the different species of water mites taken at our excursions this year. The Quekett Club have had twelve excursions in all, eleven being for fresh-water collecting and one for salt-water. Ten of these I have personally attended, but through press of business was unable to be present at the fifth on the list, viz., that to Loughton on May 30th; on this occasion Messrs. Burton and Turner kindly collected for me, and by posting the mites on, enabled me to make the list for the year complete. There are forty-one sheets in all, each sheet being devoted to one species. Sometimes the male and female are on the same sheet, and sometimes they are on separate ones. All were not drawn this year; some were drawn in 1894, and some in 1895; they are, however, intended to represent the species that have been taken this year only. The coloured drawings were made direct from life, but those in black and white were drawn after the death of the mite. There are thirty-two distinct species in all, which is rather a small number considering the large number of known species of some genera. Take *Arrenurus* for example, which has over fifty described species; here only five are recorded. The result is a little disappointing, nevertheless the list is richer in genera than it is in species, for there are representatives of fifteen distinct genera, and this is satisfactory. I know of only twenty-two British genera; the finding therefore of fifteen within a radius of twenty miles round London, in one season, may be considered very good, and speaks well for the Quekett collecting grounds.

The names of twenty-seven species are probably correctly given; of five species, however, the specific names have for the present been left in abeyance.

Although most of the time was taken up in collecting, examin-

ing, and drawing these insects, the study of their life history has not been altogether neglected. Notwithstanding the small progress made with this part of the subject, a few words on some points, personally observed, may not be without interest.

To begin at the beginning, it is no doubt well known to all present that the Hydrachnidæ like other acarina have their life history divided into four stages, viz., the egg, the larva, the nymph, and the imago. These stages then will be taken in order. First, the egg. In the window of my room there is a row of glass tubes, about four inches by one in size. In each of these is growing a piece of pond weed to keep the water fresh, then when a number of water mites of one species have been taken they are put into one of these tubes, the date recorded, and a daily examination of them made. In several instances ova were fortunately deposited in the tubes. *Hydrodroma rubra* (De Geer) deposited eggs in batches, loose in the water, not being anchored anywhere. They had so nearly the same specific gravity as the water, that the movement in the water due to the adults was sufficient to cause the eggs to rise now and again nearly to the top of the tube. All the other mites, which deposited eggs, attached them, either to the water weeds or on the sides of the tube, by a gelatinous film; the eggs were always in clusters of ten, twenty, or thirty at a time, but there seemed to be no rule as regards the numbers. To watch the gradual alterations in these eggs, from the time of laying until the larva broke through the gelatinous envelope, was very interesting; but the time the eggs took to develop varied very much in different genera, for instance:—

*Arrenurus caudatus* (De Geer) took twenty-four days.

*Nesæa carnea* (Koch), twelve days.

*Diploodontus despiciens* (Müll), twelve days.

*Eylais extendens* (Müll), thirty-eight days.

*Hydrodroma rubra* (De Geer), twenty-six days.

These developments took place at different dates from March to October, so it will be interesting to note, if these great differences are peculiar to the species, or to the time of year.

*Secondly, the larva.*—The larva is hexapod when hatched. The larva of the different genera showed, as it was to be expected, different forms; they also exhibited a great difference in disposition. The larval forms of *Nesæa* and *Arrenurus* kept

in the water swam about, and appeared to make no attempt to get out. The larva of *Hydrodroma* always remained in a sluggish, sleepy sort of way at the bottom of the tube. *Eylais extendens* did not seem to trouble very much, and appeared quite as much at home outside the water as in; but with *Diplo-dontus despiciens* it was quite different. Its first object in life appeared to be to get out of the water and away somewhere else as soon as possible. It was with great difficulty that one was secured under the microscope for drawing, so quick and sudden were its movements. It is in this form that they probably become parasitic on some other forms of pond life.

My aim this year has been to make myself familiar with the different forms of larvæ as far as possible, and next year I hope, by a systematic search among all kinds of pond life that are likely or unlikely to be the hosts of these creatures during this stage, to see if the same species of *Hydrachnidæ* are always parasitic on the same hosts. The drawings of the larvæ mentioned are on the table.

*Third stage, the Nymph.*—In this stage they attain their full complement of legs, viz., eight, and they are very much like the adults, so much so that in the majority of cases it is quite easy to tell to what species they belong. The genital area and the size constitute the principal difference, the genital suckers being as a rule only two on each side of the fissure. They are free swimming, and are as freely taken in the net as the adults. How long they remain in this stage I cannot say. I took a large quantity in Wales this year of a species of *Nesæa*, and some are still alive. Some specimens of *Nesæa pulchra* (Koch) were also found in the inert stage, which constitutes the change from the Nymph to the Imago. Two specimens only were obtained on a piece of pond weed in the Warren at Folkestone. This is the only time I found Hydrachnids in this form, but no doubt all the species go through similar changes. Nymphs of several genera were kept for a long time in confinement, but they never showed the least signs of going into the inert stage, neither were they observed changing their skin. Next season I hope to be able to carry these observations further.

*Fourth stage, the Imago.*—This is the adult stage, when these interesting creatures attain all their brilliant colouring. These colours, which in some cases are quite metallic, as for example

the hard-skinned *Arrenurus*, can never be imitated with the palette. Bright as some of the colours may appear on the table, they are tame when compared with the vivid colouring exhibited by these mites when in their best state.

Once this season, on June 22nd, the Hertford Heath Excursion afforded a very good opportunity for observing that these mites were not nearly so brilliantly coloured when they first came out from the inert stage. A quantity of *Arrenurus*, both male and female, of a pale yellow colour and with soft skins, such as I had never met with before, were taken.

At first I thought they were another species, but after examining about a dozen or so they were found to be *Arrenurus caudatus*, Imago stage, but not fully developed. The males were nearly oval in shape, except that the tail portion projected slightly, and in different specimens the tail projected more and more, until the perfect form was reached. The colouring at the same time got more marked and beautiful, going from the yellow to the deep slate-blue. This I have endeavoured to show in the drawing. The spur on the fourth pair of legs was present from the first. The female was yellow and soft bodied, but she also grew and hardened at the same time, and attained her beautiful colouring when fully grown. The female seemed to grow in the body portion only, that is to say, the genital plates and the epimera remained the size they were in the least developed specimen, but the other parts gradually swelled up and hardened, and also assumed at the same time the beautiful colour they are so well known to possess. (*Arrenurus caudatus* is probably one of the most beautiful mites known.) There is another important feature in this genus which also developed itself as the growing process went on. In the early adult stages the depressed line on the dorsal side, which is one of its chief characteristics, was not seen; but subsequently this gradually came out distinctly.

In conclusion, enough has been said to show how little I know and how much more I have yet to learn about these beautiful creatures, but I shall have much pleasure in answering, so far as lies in my power, any questions on the subject.

## MULTIPLE IMAGES IN MIRRORS

BY WM. BALFOUR STOKES.

(Read December 18th, 1896.)

The origin of multiple images in plate-glass mirrors, and their behaviour, seem to have attracted but little notice among microscopists. They have been noted, and a partial remedy has been prescribed, but their origin seems to have been either too simple or too complex for explanation.\*

When attention has been called to these images, simple, and I believe efficient reasons have been given; but their authors did not explain the behaviour of the images when the mirror is revolved.

A figure will best show my own idea as to their origin. In Fig. 1, A is the glass surface, B the silver surface, O the object, and E the eye.

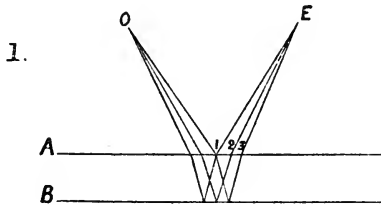

In the direction 1, 2, 3, appear the first three images. No. 1 is from the glass surface, No. 2 is from the silver surface, and No. 3 is from the silver and *air* surfaces.

Move a card along A towards 1, and No. 3 disappears first, No. 2 immediately after, and No. 1 when the card reaches that point.

So much for their origin.

It will be asked, perhaps, how the images can alter their

\* Dallinger's "Carpenter," 1891, p. 171.



position when the mirror is revolved in the plane of A. They cannot. The mirror A B has parallel surfaces. Microscope mirrors and most plate-glass mirrors are not parallelised, but are, at the best, "optically" flattened, and may be regarded as wedges.

It is then easily seen how images approximate and retire when the mirror is revolved.

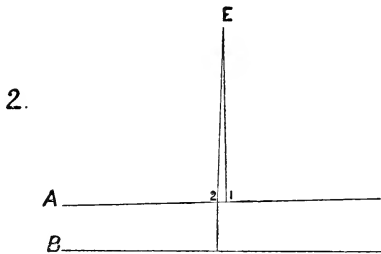

Let us give surfaces A and B an inclination of  $1^\circ$  (Fig. 2). Then viewing a small object at E (close to the eye) one image appears towards 1, *i.e.*, at right angles to A, and another in the direction E 2— $1\frac{1}{2}^\circ$  from E 1, which, after being refracted to  $1^\circ$  in the glass, is reflected at right angles from surface B.

There is another image nearer the letter A, but, as it follows the same laws apparently as the others, save that it is a real double reflection, we need not consider it.

If this mirror is revolved in the plane of A, of course No. 1 image will remain still, and No. 2 and subsequent images will revolve with the mirror round No. 1.

If we exaggerate this wedge shape of our mirror, we can see that at a particular angle these images can be made to superimpose.

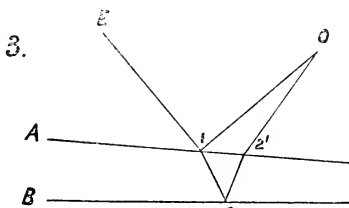

Let the signs be as before (Fig. 3) and the images whose

rays pass respectively from O to 1 and  $2^1$  will be reflected to E as one image.

I should imagine the 3rd image to arrive at E through 1, but I have not yet worked this out.

Of course, placing the eye at O and the object at E would be equivalent to revolving the mirror.

The images vary slightly in size owing to their various distances.

No. 2 is the brightest except at great obliquity.

## ON METOPIDIA PTERYGOIDA, A NEW ROTIFER.

BY M. F. DUNLOP, OF GREENOCK.

*Communicated by C. F. ROUSSELET, F.R.M.S.**(Read January 15th, 1897.)*

## PLATE XVII.

At the end of July last, when leaving the Island of Arran (Scotland), where I had been enjoying a few weeks' holiday, I brought with me from a small mossy pool, in a Moorland district about 500 feet above the level of the sea, a gathering which I intended to examine carefully at home. I was unable to investigate the gathering till September, when I found in considerable numbers a Rotifer which I take to be *Stephanops longispinatus*. I had shaken, in a large cell, a spray of sphagnum, where *Stephanops* seemed to congregate, and was watching the sprightly Rotifer when I noticed a strange form smoothly and slowly gliding out from the moss, and then in like manner moving back to what appeared to be its favourite haunt. On the stranger emerging again, instead of studying its behaviour and getting an idea of its form from different aspects, I anxiously dipped out the then only visible specimen in case it should be lost amongst the débris, and proceeded to mount it. But, alas! on letting down the cover glass the minute speck slipped on to the ring of the cell and, to my great disappointment, was crushed. Another search brought to view a second specimen, which was nervously dipped out and speedily mounted in the expectation that I should surely find another for observation. But while the *Stephanops*, after the lapse of nearly five months, continues in evidence, I have failed to get another specimen of the "stranger"—not even a lorica! This is unfortunate, as details which might have been obtained from a lateral and ventral view cannot be given.

All who have seen the mounted slide—including Mr. Hood, Mr. Dixon-Nuttall, and Mr. Rousselet—agree that the new

Rotifer belongs to the genus *Metopidia*; and, as the first thing which attracted my attention to the Rotifer was the peculiar shape—suggesting the appearance of wings—I propose that it might be called *Metopidia pterygoïda*.

The lorica is depressed, and, when viewed dorsally, is pyramidal in form, with sinuous outline both laterally and posteriorly; there is a slight gap or notch in the posterior dorsal border, and a much deeper one in the ventral edge; there is a dorsal ridge, the outline of which, I think, is seen by careful focussing; a longitudinal rib-like line runs down either side of the ridge to near the posterior end of the lorica, and another rib along the sides of the wing-like extensions; a third and shorter rib-like elevation runs close along each side of the centre portion of the median ridge. The foot is three-jointed, with two slender decurved toes; there is a frontal hood; two minute eye specks wide apart, and two lateral antennæ in the lumbar regions; the dorsal antenna is situated over the centre of the head. Size, total  $\frac{1}{2}\frac{1}{50}$  in. (0·102 mm.), of lorica alone  $\frac{1}{3}\frac{1}{00}$  in.; the extreme width of the lorica is also  $\frac{1}{3}\frac{1}{00}$  (0·084 mm.).

The Rotifer at first sight suggests Perty's *Notogonia Ehrenbergii* (Hudson and Gosse's Supplement, Plate XXXIII., Fig. 38); but, when the plate is referred to, a considerable difference is observed. *Notogonia* is broad with four angular projections posteriorly, and besides is nearly double the size. Mr. Rousselet says this new species is nearly allied to *Notogonia*. He adds in a letter to me: "Perty's work 'zur Kenntniss kleinster Lebensformen' dates from 1852. Since then his species seems to have been seen twice. In 1889, just before the publication of the Supplement (Hudson and Gosse's), Mr. Anderson of Calcutta wrote a paper (published in 1891) 'Notes on Indian Rotifers' in which he describes *Notogonia* as new, under the name *Metopidia angulata*; his figure is rough but it agrees in the main with *Notogonia*. In 1892 Mr. C. Ternetz, in his paper 'Rotatorien der Umgebung Basels,' mentions that he has found Perty's *Notogonia Ehrenbergii* and renames it *Metopidia notogonia* as belonging to that genus. Ternetz is a good observer; and, if the shape of the lorica had at all differed from Perty's drawing, he would certainly have seen and mentioned it." It may be concluded from this that *Notogonia*, as seen at various times and in different places, is

constant in form, and that the Rotifer now described is a distinct species.

I am much indebted to Mr. Hood, Mr. Dixon-Nuttall, and Mr. Rousselet for the interest they have taken in this discovery, and the aid they have afforded in identifying it; and especially to Mr. Dixon-Nuttall for the beautiful and faithful delineation of the new *Metopidia*, a reproduction of which accompanies this paper.

P.S., by C. F. Rousselet.—After the reading of the above paper, and after having exhibited Mr. Dunlop's slide at the meeting, I tried and succeeded in remounting the tiny Rotifer in a shallow cell where it can be rolled over on its side. A lateral view thus obtained has been drawn by Mr. Dixon-Nuttall and added to the plate; it shows that the median dorsal ridge is rounded and not very high, whilst over the head there is a large rounded projection directed backwards, from the apex of which the dorsal antenna protrudes. A transverse section across the middle of the body has also been added to the plate.

#### EXPLANATION OF PLATE XVII.

- FIG. 1. *Metopidia pterygoida*, dorsal view.  
 „ 2. „ „ side view.  
 „ 3. „ „ section across centre of body.
-

## BRACHIONUS BAKERI AND ITS VARIETIES.

BY CHARLES F. ROUSSELET, F.R.M.S.

## PLATE XVI.

(Read January 15th, 1897.)

It is now a well-known fact that many species of Rotifers are liable to considerable variation, and none more so than the different members of the genus *Brachionus*. This variation has given rise to a great amount of species making, not less than eight specific names having lately been given to varieties of a single form.

The object of this paper is to show to what extent variation occurs in *Brachionus bakeri*, and so to prevent, if possible, the making of new species and avoid the confusion arising therefrom.

*Brachionus bakeri* was named by O. F. Müller (1786) in honour of Henry Baker, the English microscopist, who flourished about the middle of last century, and who, in 1764, published a work, "Employment for the Microscope," in which, amongst many other curious things, he described and figured several Rotifers. In Fig. 11 I give an exact copy of Baker's illustration of the animal which now bears his name. He says in the text that he found it first in 1745, "together with two other sorts of wheel animals having shells, in the water of the cistern in the garden of Somerset House." Ehrenberg's figures of *B. bakeri* are very good, and like my Fig. 10, with slightly larger anterior and posterior spines. In his description Ehrenberg mentions some characteristic features which unfortunately have not been repeated by Mr. Gosse, whose diagnosis of this species in *The Rotifera* is singularly incomplete, and in part inaccurate. Mr. Gosse mentions two small spines bounding the orifice of the foot, which are not spines at all in any sense.

The two most characteristic features of *B. bakeri*, common to

all its varieties, and absent in all other species of *Brachionus*, are the following:—

1. The ventro-posterior part of the lorica is prolonged, and forms a tubular sheath round the base of the foot as shown in the side and ventral views, Figs. 2 and 3. This sheath stands out nearly at right angle to the ventral plate, and its length is subject to variation, but it is always distinctly present in all the varieties of this species. On the dorsal side of this sheath a sub-square piece is cut out, the edges of which form the so-called spines bounding the orifice of the foot described by Mr. Gosse. This shelly tube or foot-sheath is mentioned by Ehrenberg, but is omitted in Gosse's description. In all other known species of *Brachionus* the foot opening is merely a rounded hole in the ventral plate, with often a sub-square piece cut out of the dorso-posterior plate, but there is no approach to a tube.

2. The median anterior spines, or antlers, curve outwards, and, when long enough, are in addition bent downwards over the head of the animal. This character again is mentioned by Ehrenberg and omitted by Gosse. The anterior spines vary very much in size; they may be as long as represented in Fig. 4, or as short as in Fig. 8, but they have always a distinct tendency to curve outwards, whilst they are merely straight in the other species of *Brachionus*.

3. Another important character, and one which most observers would place first, are the two postero-lateral spines of the lorica. As will be seen by the figures on Plate XVI., these spines are subject to the greatest possible variations; they may be extremely long and narrow, or very short and stout, or even absent altogether, divergent, parallel, or convergent. These differences in shape, size, and direction of the posterior spines have given rise to a number of specific names which cannot be admitted; even Ehrenberg's *B. brevispinus* is but a variety of *bakeri* as he states himself. Gosse's figure of *B. bakeri* on Plate XXVII., Fig. 8, of the monograph shows abnormally broad posterior spines; no doubt such a variety exists, but I have not yet seen it, and it is certainly not the ordinary type. The anterior median spines are drawn as forming a very sharp angle between them, which I consider can hardly be correct. The stout dorsal antenna projects between these spines,

and in my experience this antenna has always a nicely rounded recess to lie in, and not a sharp angle as shown in Gosse's figure.

The shell of *B. bakeri* is more or less stippled all over (usually closer and more strongly marked than the figures indicate), sometimes very prominently, and in regular lines and patterns, and sometimes very faintly and hardly visible; as a rule the stippling is strongest in the long-spined varieties and weakest in the short-spined animals, which may be called *var. brevispinus*, the only additional name which I would admit.

The lorica is compressed dorso-ventrally, more so than in most other species of *Brachionus*, and as a consequence the internal organs, and especially the gastric glands, are spread out and lie flatter. Otherwise there is hardly any distinctive feature in its internal anatomy.

All the figures in Plate XVI., except Fig. 11, have been very carefully drawn by Mr. F. R. Dixon-Nuttall from mounted specimens in my possession. Figs. 1, 2, and 3 represent a dorsal, side, and ventral view respectively of the more common, and what may be considered the type species. The animal represented in Fig. 4 I obtained from a gathering sent me from America, and collected in the Illinois River; the spines are all very long and the posterior spines diverging. In the same gathering were also numbers of similar animals with shorter and straighter spines. A similar long spined variety has been reported from Lake Yamouneh, in Syria, by Mr. Barrois, who has called it *B. melhemi*. The animals figured in Figs. 7 and 8 were obtained at the Commercial Docks, the spines are short and stout, and some specimens had the merest indication of posterior spines, as seen in Fig. 7. The shells represented in Figs. 5 and 9 come from the Victoria Regia tank in the Royal Botanic Gardens in Regent's Park, where this variety can almost always be found; the lorica is very transparent with hardly any stippling. The animal drawn in Fig. 12 was obtained at the Club's excursion to Hanwell. When I first saw it I was for a moment in doubt what to call it, as there is not a trace of posterior spines, the lorica being perfectly round with a long sweeping curve, very slightly indented in the middle.\* I could find only this single

\* This appears to be the variety found by Mr. A. S. Scorikow, near Kharkov, in Russia, and named by him *B. cluniorbicularis*.



specimen in my bottles, but fortunately Dr. Measures, who had collected at the same spot, had obtained a number of specimens showing in varying degrees indications of posterior spines. Fig. 14 represents one of these animals, possessing the longest spines found in this gathering, but every degree between this and no spines at all is represented; in some specimens even the shell has a very short spine on one, the left, side, and is rounded off on the other as represented in Fig. 13.

The mental edge of *B. bakeri* is a wavy line as seen in Fig. 3, showing three rounded elevations and three depressions on each side, with a deeper depression in the centre, but the exact outline of the margin varies somewhat.

One of the functions of spines in the Rotifera is protective. Animals having long spines cannot be so easily swallowed by aquatic larvæ, worms, and the larger Rotifers, such as Asplanchnæ. I have often observed how the spines have saved its possessor from such an awful fate. It is, however, not easy to conceive what can be the factors at work to produce so much variety in the size and shape of the spines in the same species. No doubt food supply, climate, environments, and constitution of the water are some of the factors of variation, but what conditions in the environments or exact composition of the water will produce, for instance, long spines, it is at present impossible to say. Certain it is that all these varieties are never found together; as a rule each locality has one or two varieties which may be very abundant for a time and then disappear altogether; after a time the same variety may reappear, or it may be replaced by a different variety.

The males of the different varieties cannot, I think, be distinguished from each other; I have mounted specimens of some of them. They have all a very thin spineless lorica as figured by Mr. Gosse.

The following older species I consider to be varieties of *B. bakeri*:—

- Brachionus brevispinus*, Ehrbg.
- „ *polyceros*, Schmarda.
- „ *ancylognathus*, Schmarda.
- „ *chiliensis*, „
- „ *pustulatus*, „

and of the more recently described species the following will

all correspond with or fit in between the forms illustrated in the accompanying plate, and must be considered mere varieties of this very variable species:—

- Brachionus bidentata*, Anderson.  
 „ *rhenanus*, Lauterborn.  
 „ *tuberculus*, Turner.  
 „ *melhemi*, Barrois and Daday.  
 „ *obesus*, „  
 „ *granulatus*, Kertész.  
 „ *entzii*, Francé.  
 „ *cluniorbicularis*, Scorikow.

I may add here that *B. quadratus*, which has been mentioned as a link in the series of varieties of *B. bakeri*, does not belong to this group. The whole type and character of the shell is different; it is very high and square behind, has no foot sheath, and the structure of the shell shows a kind of closely reticulated lacework, which is not found in any other species of *Brachionus*, besides having a semi-jointed foot.

The size of *B. bakeri* varies also greatly; the largest specimens, with longest spines, measure  $\frac{1}{75}$  in. (0.339 mm.) from the point of the anterior to the tip of the posterior spines, the more ordinary forms are  $\frac{1}{90}$  in. to  $\frac{1}{80}$  in. long (0.282 mm. to 0.317 mm.), whilst the very short spined varieties often do not exceed  $\frac{1}{100}$  in. (0.254 mm.).

#### EXPLANATION OF PLATE XVI.

- FIG. 1. *Brachionus bakeri*, type species, dorsal view.  
 „ 2. „ „ „ side view.  
 „ 3. „ „ „ ventral view.  
 „ 4. „ „ variety from Illinois River, America.  
 „ 5 & 9. „ „ Victoria Regia tank in Botanic Gardens.  
 „ 6 & 10. „ „ lake in Botanic Gardens.  
 „ 7 & 8. „ „ Commercial Docks.  
 „ 11. „ „ Henry Baker's figure of 1764.  
 „ 12, 13, & 14. „ Varieties from the Canal at Hanwell.

## THE PRESIDENT'S ADDRESS.

BY J. G. WALLER, F.S.A.

*(Delivered February 19th, 1897.)*

GENTLEMEN,—My year of office having terminated, a duty, the result of a time-honoured custom, devolves upon me to address a few words unto you. Nor can I think lightly of a task which I, a mere amateur, am called upon to perform, following, as I do, men of high repute, who have left the results of special work behind them. But, as you have done me the honour of placing me in this chair, I will endeavour to do my duty towards you, relying upon that kind consideration which has always been shown unto me. And here, let me express my obligations to the worthy officers of the Club, who have made my position an easy one, and thus have earned my best thanks.

Being then an amateur, I must address you as one of the brotherhood, and, if I ramble hither and thither in devious ways, which has been my course in science, I hope that you will pardon me if I enter a little into my own personality, and glance to the advances made in my time, and to some aberrations inevitable in all inquiries. It is good for all, however much employed in the purposes of life, to have a hobby, that is, an intellectual occupation for leisure hours. It is as if the eyes weary of one view seek relief in another. It thus becomes a recreation of a most healthy character, and has a moral influence upon the understanding. It is not usual for one in my profession, though specially one for the study of nature, to seek it further in natural history by the microscope, as one of our hobbies. But the popularity of this mode of intellectual recreation in England was particularly noted some years ago by two German professors of the University of Freiburg—Herr Doctor Weismann and Herr Weidesheim—whom a friend of mine, and a member of our Club, met at a meeting of the British Association. He invited them to his house at Sidcup,

and they attended a meeting of the local Society. They expressed considerable surprise at the display of microscopes in a suburb, as well as the interest shown in matters of science by the middle classes in England, whereas in Germany it was chiefly left to professors. I consider this as a great compliment to us, and we are not accustomed to such very often from our German friends.

Association has much to do with our habits, and it often happens that these, if not formed, yet have their direction given by our friendships. It is not improbable, therefore, that in my case, an early acquaintance with Dr. Mantell, and still more with Dr. Lee, the amiable but eccentric owner of Hartwell House, in Buckinghamshire, to whom all men of science or art were welcome, may have influenced me. I met there Mr. Read, Vicar of Stone, one of the founders of the Royal Microscopical Society, members of the Astronomical Society, geologists, and many others. All visitors were expected to have some walk in science or to be in initiation. Now the period, to which I am alluding, was notable for the awakening up of interest in the antiquity of man on this earth by a discovery made in the valley of the Somme of numerous implements of flint. I call it an awakening, because long before, viz., in 1797, an hundred years ago, similar objects were found in strata at Hoxne, in Suffolk, a village well known to me as my mother's birth-place, and for its legendary traditions respecting the martyrdom of Edmund, King of the East Angles, which are not quite effaced, though nearly a thousand years have passed away. It seems almost like irony to think that, in such a place, objects should be found, and first recorded, which involved a new walk in human history. Mr. Frere, the discoverer, sent an account in 1800 to the Society of Antiquaries, full of intelligence and a correct appreciation of its geology, in which he was quite before his time.

But the time was not yet ripe to set aside the accepted Jewish chronology for one that was indefinite. Besides that, the political horizon of the day was so full of dark clouds that the discovery in a remote village, though well recorded, was soon forgotten. It was in 1847 that M. Boucher de Perthes, of Abbeville, issued his volume entitled "*Antiquités Celtiques*," in which he gave an account of his discovery in the drift of the

valley of the Somme of flint implements, which were well illustrated. An old friend of mine, an eminent antiquary, Charles Roach Smith, F.S.A., also a close personal friend of the discoverer, showed the book to me, expressing his perfect belief in the genuineness of the objects represented. But it would be inaccurate to suppose that this view was general, as the following anecdote may show. A year or two later, I was at Hartwell House in company with a banker of Aylesbury, with whom I was staying, and amongst others was an active professor of geology, who had recently visited M. de Perthes. A conversation took place between them, in which I noted considerable reserve on the part of the professor; and at the same time it was depreciatory, showing that he doubted to some extent what he had seen. Upon which my host said to him, "Is he a rogue?" "No," he replied, "he is not a rogue." "Well, then," was the rejoinder, "Is he a fool?" The answer was "Yes; perhaps he may be a fool." But we were now in days of inquiry. The subject was taken up by those qualified both as antiquaries and geologists, the localities in the valley of the Somme were thoroughly examined, with a verdict that was absolutely conclusive. Subsequently we know that large collections of flint implements, from all sorts of deposits, have been made, all of them declaring the same problem, which cannot be approached without some solemnity.

One cannot, however, be without sympathy for those who hesitate to take up with ideas that are new to them. Few, indeed, are the minds that, thinking themselves safe in old traditions, like to leave that shore for the boundless sea of inquiry. But when science has advanced as in these days, and has been so universally acknowledged, one was startled by the issue of such a work as that entitled "Prochronism," and by one who did good service on marine organisms by the microscope, wherein fossil remains of extinct creatures are pronounced to be delusive, as having had no real existence; and also, that another should go about lecturing to prove that the world was not globular, one can only apply what Luther is said to have uttered, "that the human mind was like a drunken man on horseback, prop him up on one side and he tumbles on the other." But, indeed, the received truth of to-day may be the error of to-morrow, and the converse. To many its pursuit is that of an

*ignis fatuus*, a glimmering vision that eludes or deceives the senses, and history is full of such experiences in all departments of the province of thought.

But I must not forget microscopy. So let me take you back to my early days of its study, when, in summer evenings, my favourite walk was across Primrose Hill by Belsize, through green fields, over country stiles, up to the western slope of Hampstead. Then we come to Shepherd's Well, a spring of repute for the purity of its water, and water carriers are moving to it and from it, illustrating the mode of supply once in vogue in the City of London. It is engraved in Hone's "Every Day Book," and is the source of the Tye-bourne, a stream which has a history, receiving its prefix from the bifurcation of its outpour into the Thames which formed the Isle of Thorney, where stand our Houses of Parliament and the venerable Abbey of Westminster—a spot from its associations the most sacred in our annals. As early as the 13th century its waters were sought for by the citizens, and collected in conduits in Oxford Street, near Stratford Place, by which was a banqueting-house for the mayor and aldermen who, coming to inspect them, regaled themselves in true city fashion. I have told the history of this brook in another place; my former pleasant walk through green fields has passed into the usual uninteresting assemblages of suburban dwellings and the spring into a sewer.

At Shepherd's Well I made a gathering of minute algæ, the microscopic examination of which gave me a delightful spectacle. It seemed as if I had before me chains of gold and emerald gems, so looked the Diatomaceæ and Desmideæ, and I thought of the old Greek lyric who begins his ode by telling us "That water is the best thing,"\* whether, if he had seen what I did, he might not have imagined it was the jewel case of the goddess Nymph of the spring. Such would have been in accord with the beautiful mythology of his day. Then, seeing for the first time conjugation of the Spirogyra from beginning to end, I had a lesson on the mystery of life. Nor was this all by a long way, that I learnt from the water of Shepherd's Well, and, as a young microscopist it spurred me on to the examination of the pools on the heath.

Thus the ominous name of Tyburn may have a better memory

\* Pindar, Olympia Ode, "Ἄριστον μὴν ὕδωρ."

than of the hideous scenes that once took place at the corner of Edgware Road, in microscopic beauty at its source, and the associations at its outpour.

But when we speak of Diatomaceæ, we cannot do otherwise than remember the part they play in microscopical history. They are ubiquitous, found everywhere in water, whether in the ocean, or river, or the merest trickling rill. It is an interesting fact, that you can, in many instances, predicate the character of what you will find, according to the conditions under which they exist, and they have more than any other organism been favoured by constant research. The development of the microscope itself has gone on coincidentally with our knowledge. Some diatoms have long been test objects wherewith to examine the highest powers. At the time when Ehrenberg wrote, probably most observers considered with him that they belonged to the animal kingdom; and this view lingered on, finding its supporters even when Andrew Prichard, in 1861, published his admirable compilation on the "Infusoria." Although this is now quite given up, one must not condemn too readily views that were partly suggested by the movements of certain species. Truth is a growth, the result of observation, but it is slow in progress, as the history of opinion on the most important of subjects declares unto us. But, if we assumed that the movement of the Naviculaceæ was due to animal nature, the next step was to tell us how this was accomplished. So some observers distinctly saw a ciliated apparatus. This, however, is the old story; you can always see what you wish to see, that which your mind has determined; and it is not agreeable to many, perhaps to most minds, to think that your eyes may deceive you. Yet this is a lesson that the microscopist must learn, and it is an important one. The study of the Diatomaceæ continually imposes this upon us. One species has especially exercised all the faculties required in minute examination—the *Pleurosigma angulatum*—which has in itself a history singular in the various waves of opinion and attempted demonstration. The markings of its silicious envelope at first presented striæ, which further magnification determined into a series of semi-circular bosses, or at other times, according to other views, so many depressions or apertures. The first was once attempted to be illustrated by a glass tumbler, the sides of which consisted of so many raised

bulbs. It was thought that a similar material would be similarly affected by the action of light, and thus would prove, or tend to prove, the true construction of the valve. In the theory of elevations, it is not so long ago that arrangements were made in side illuminations by a pencil of light, thus supposing to give a true and artistic light and shade. But, in both these experiments, it seemed to be forgotten that they were begun in a foregone conclusion; and, as I have previously said, you naturally, in such a case, see what you wish to see. Certain accidents, fractures, and peculiarities inconsistent with the above-named views, assisted by careful illumination, seem now to have tolerably settled the question to be on the side of apertures, and my predecessor has worked most successfully thereto. That this must be the general consent on such markings throughout the Diatomaceæ must probably be entertained, though it would be dangerous to affirm that there was no variation from it in the multiform changes of nature.

But the subject has been so admirably worked out and recorded by two papers in our Journal, one by Mr. C. Haughton Gill, April, 1890, in which he has well described his mode of preparation of the objects wherewith to determine the structure. Another by Mr. Nelson, in May, 1891, goes into the same matter by the use of high powers, and these papers, showing a working on different lines, yet arriving at the same result, commend themselves to us as conclusive. Nor can we forget the eminent services on diatom structure rendered by our Secretary, Mr. Karop, associated with further ideas on their development. But the diatom will never cease to be of primary importance to the microscopist, as the abundance and variety of its forms even exhaust our imagination, and the volumes written upon it, though numerous, seem to be only forerunners of more to come.

I have alluded to the movements which were once thought to be one of the reasons to indicate animal life, as seen in the Naviculaceæ; but in these forms it is by no means so remarkable as in one less commonly met with, viz., the *Bacillaria paradoxa*, wherein a number of parallel rods slide out side by side on each other, in a manner so curious as to challenge all hypotheses to clearly explain them to us.

But movement can in no way of itself be recognised as a



distinction of animal nature, and many examples of the *Algæ*, notably that of *Folvox globator*, go far beyond what is seen in any of the *Diatomaceæ*, and sometimes there is a lingering of opinion here, as to which order the latter should belong. Hesitation of this kind has its value, as it directs attention to the subject, and, finally, to a decision. Sponges are now relegated to the animal kingdom, but it is singular that doubts on this point should have belonged to modern science; for Pliny, who wrote at the beginning of the Christian era, in his curious compilation, entitled "Natural History," distinctly saw the true place they should occupy, though his allusion to their having blood would not be accepted in the way he has expressed it; but one can understand what he means.\*

One might quote eminent names near to our own time who have taken a different view, and it is remarkable, that one of such large experience as the late Dr. Gray, of the British Museum, should have been once on this side, and considered the spicules the analogues of the hairs of plants. This comes out in a passage of arms between him and Dr. Bowerbank, who could not avoid giving so home a thrust as to remind him of it. Even after it was generally allowed that they belonged to the animal kingdom, a reservation was made for some time before the fresh-water sponges were placed in the same position. Observers could not have seen, as I have, the blow-fly hovering over and depositing its eggs, attracted, doubtless, by the offensive odour of decomposing flesh. We may thus call it a scientific observer.

My allusion to the fresh-water sponges brings me to the consideration of the law of variation which affects all organised life. It is to this law we owe the beauty in nature by which we are surrounded. Science steps in to assist our observation, to name the various objects, to classify them, to note the divergencies one from another, thus making genera and species. As regards the latter, it is the variation from a supposed typical form which has become fixed, and thus well understood. In the higher organisations this is not so difficult, as differentiation is more easily seen. But, even here, the great law of variation is constantly making itself visible, and types may be found

\* C. Plinii, "Nat. Hist." Lib. cxxxi., xi., "Animal esse docuimus, etiam cruore inhærente."

changing or passing into decay. When we descend in the scale of living things, animal or vegetable, our difficulties are constant, and it is extremely doubtful, whether in many cases what we make into species is but variation. That this was formerly done, to a greater extent than at present, we all know, but the tendency still exists, and the multiplication of names to overloaded vocabularies is a serious evil. In all cases, it is most important to take note of the conditions under which an organism is found; and we may then see the value of slight changes from what we call the type form, but it does not follow that these changes make species, but, on the contrary, are mere varieties, consequent on the special conditions in which they are found.

Many years ago, I had the pleasure of communicating to you a paper "On Variation in *Spongilla fluviatilis*." My study of this was chiefly made in the Thames. Referring to the Spongiadæ of Dr. Bowerbank, I found that his type form was from the West Country Timber Dock at Rotherhithe, of which he describes the skeleton spicule as acerate, viz., sharp at both ends, and he represents it as quite smooth. Now Mr. Edward Parfitt, of Exeter, an ardent naturalist, discovered a specimen at the Salmon Pool of the River Exe, and he detected some differences between it and the type form; and this was chiefly in having one half, or nearly so, of the skeleton spicules incipiently spinous, though these were less in number. Dr. Bowerbank made it into a distinct species, calling it *Spongilla Parfitti*. A portion was sent to that eminent observer in this department of natural history, Mr. H. J. Carter, F.R.S., who described it in the "Ann. and Mag. of Natural History" for April, 1868, as a variety of *Spongilla Meyeni*, calling it *S. Meyeni*, var. Parfitti. It must here be noted that the term "Meyeni" was given by Mr. Carter, and it has been generally adopted. Dr. Bowerbank at once criticised Mr. Carter, saying "How this British *Spongilla* can be a variety of a species that does not exist in England, is past my comprehension."

But, in my own opinion, both were sinning in making too much of a trifling variation which also I found in the Thames at Teddington Lock, and variations of a much more positive character in the same river; and it seems improbable that Dr. Bowerbank knew much of the *Spongilla* of the Thames, or he

could not have failed to note the changes from his type. Molesey Lock became my next place of examination, where I found *S. fluviatilis* in large masses. A variation again is shown, and half of the spicules are smooth, the other entirely spined and arranged with some order, rather than intermingled one with the other. At another time, being compelled by stress of weather to take refuge on the floating-boat barge at Surbiton, I turned it to account in a special gathering off the barge itself between it and the wharfing boards, and I was interested to a degree when I found that in this example nearly all the spicules were entirely spined acutely.

Now it will be seen, that the variations I have noted are so far remarkable, that the smooth spicule of the type has gone a complete course of alteration of a very interesting character, and had I followed the example of the eminent men I have quoted, I might have made two more species much more pronounced than that they recorded. But it is my contention, that science is better served by marking well the conditions under which the examples are found, and if we append numerals or letters of the alphabet it is a sufficient distinction in declaring the variation to which this *Spongilla* is subject. We may be a long way yet from being able to point out the laws by which such is produced, but I may at least record that as far as my observation goes, where the *Spongilla* is developed in still water the skeleton spicule is smooth; but when there is agitation, and perhaps according to its extent, now suspended, now renewed, as in locks; and where it is constant, as was the case with the example from Surbiton, the spicules were spinous. I put forward this theory as a suggestion for further observation, as it would be interesting to discover the law by which such changes as are alluded to are produced. Mr. Carter has expressed a similar view.\*

There is yet another variation, of which I gave an account, the example being taken from a large pond at the Manor of Ditchleys, near North Weald, Essex. It was found growing upon the stems of submerged plants, and thus had a very narrow basis on which to develop. This would naturally affect its

\* In my paper referred to, I opposed to Mr. Carter's view the fact of finding smooth spicules in a sponge from a mill-dam. confounding this with the agitation of the outpour. I was therefore in error.

growth, but would not produce a specific change of character. Nevertheless, there were certain differences in the details of its skeleton which separated it from that assumed as the type. The spicule was smooth, in this agreeing with the theory I have propounded, and there were slight differences in the proportions and character of the birotulates of the stato-blast. But I maintained again that, though an interesting variation, it was not entitled to be set down as a species. How my views were received elsewhere will now be seen.

When Professor Hitchcock, of the United States, was over here a few years ago I gave him a specimen of the Ditchleys *Spongilla* for his collection, and others also distributed by or through me found their way to America, and I sent a slide to Mr. Carter. After some time had elapsed, I heard that Mr. B. W. Thomas, an earnest worker of Chicago, had found the same variety in the river Calumet, and seeing its identity with that of Ditchleys, and finding that, in my description, I had declined specially naming it, he proposed to call it *Meyenia Calumetica*. Then Mr. Carter, who had received a specimen from Mr. Thomas, saw that it was identical with that he had received from me, turned his attention to the subject, and in an elaborate article in "Ann. and Mag. of Natural History" gave it the name of *Meyenia angustibirotulata*, which title Mr. Edward Potts, in his admirable "Monograph of the Fresh-water Sponges of America," has accepted. Mr. Thomas then feels annoyed that he should thus be superseded, as Mr. Carter had, in the first instance, declared against its being a variety. For myself, who first discovered it 19 years ago, and might have claimed some voice in the matter, I could not be otherwise than amused at the little quarrel amongst my friends, I having decided against giving the variation any separate name, my views leading me in another direction. One satisfaction I have, however, gained in the knowledge that the *Spongilla* of the river Calumet is also found growing upon the stems of aquatic plants, as it tends to establish, what one would naturally feel, that similar conditions produce similar results.

The more we survey the material world the more the law of variation presents itself, and it ought at all times to sway our judgment, when we imagine we have arrived at sufficient differentiation from a supposed type, and seek to declare it a species. When the variations are slight, as in the cases to which

I have referred, it surely best serves the interests of science to group them together under one name, and not adding another, whether of qualification or otherwise, which tends to produce the same evil of adding unnecessarily to our over abundant vocabularies, when by using numerals or letters of the alphabet the same end may be attained.

In pursuing my criticism let me bring to your notice a series of names collected in Mr. Potts' monograph. First Meyenia, by Carter, superseding Spongilla, which is so intelligible and venerable, as it was given by Linnæus. Dr. Johnston, an able writer on the subject, added "Fluviatilis." Why should we thus, to honour an eminent German, make up a new name without an absolute necessity? Do these names, Meyenia Leidyi, Millsii, Mülleri, Baileyi, Capewelli, Ramsayi, Everetti, give us more information than letters of the alphabet, or do they not add to our confusion? Some of the illustrations in this monograph show only slight variations, and the five examples given by me, in the paper referred to, declare greater variation in that of Ditchleys, even including the Spongilla from the Bombay tanks.

In drawing your attention to what has come under my own notice in a special organism which I have studied, I infer that in others similar variations are found, and have been too readily marked off as species, or have the variety specially named. But the law of variation has been so ably treated by A. R. Wallace in "Darwinism" that what I place before you must only be regarded as an episode.

In giving names I cannot but remember how much more happy were our forefathers, as, for instance, Heartsease, Pansy, Love in Idleness, that "little western flower" as our poet tells us, "Before, milk white; now purple with love's wound."\* But what poet could use Hutchinsonia, Griffithsia, Battersbya Bucklandi? Names we dedicate to an organism or to a species are surely best when they hint, if no more, at character or structure. Dr. Bowerbank, in some instances, has been happy in this particular, and has given to two genera of sponges, closely allied to each other, viz., Raphiodesma and Desmacidon, names that are equally allied in their combinations. We want more simplicity, to be less overburdened with species,

\* *Midsummer Night's Dream*, Act ii., sc. 1.

or with classifications, which multiply names, but scarcely enlighten us by them.

If I now review the past of the Quekett Club, to which I have so long been connected, to think of what it was and what it is, it is impossible not to be gratified by the obvious advance in all directions. The earnestness of the workers, the work going on in groups, studying the same organism as now in the Rotiferæ, which is such an advantage for the dissemination of knowledge, as each one is necessarily critical on the other; and I have already alluded to the many workers, both past and present, on the Diatomaceæ, whose researches have produced such eminent results.

But one can scarcely look back on the past of the Club and not remember the beginnings of what has resulted in the admirable monograph on the blow-fly, by Mr. Lowne, which teaches us, that to study truly one living object it is necessary to study all that are cognate; for nature is obedient to the law of development, though the paths are devious, separating one from another.

It is gratifying to observe the continuous and constant interest shown in the Club, which can claim to be the parent of other kindred societies. But the microscope is an instrument to awaken our enthusiasm. By it we can realise the poet's dream that

"The dust we tread upon was once alive."

We know by it, that our chalk cliffs were formed in a deep sea,\* its materials being composed of organisms still familiar to us as living under similar conditions. Its rows of flint, that geological problem, the name a synonym for that which is hard, we can prove must have been once soft, coagulating with decomposing sponges, zoophites, &c. Our London footpaving we can show, to have been once a sandy shore of an ancient sea, its component parts largely consisting of triturated quartz, one of the most beautiful of crystalline productions. Sections of our metamorphic rocks take us far back in time, but show us even here the eternal law, building up, decay, rebuilding. Thus, then, I may conclude, that by the microscope you may find, in our poet's words—

"Sermons in stones and good in everything." †

\* The term "deep sea" may not be geologically correct if by that we think of the Atlantic depths.

† *As You Like It*, Act ii., sc. 1.

## A PORTABLE MICROSCOPE LAMP.

(*Exhibited October 16th, 1896.*)

This microscope lamp, made by Mr. Hinton, was designed and exhibited by Mr. Goodwin. The chimney is of metal and has in it two circular apertures one inch in diameter, one of which is glazed with signal green and the other with steel blue glass. The cylindrical reservoir is two inches in diameter. The burner takes a  $\frac{3}{8}$  wick, but Mr. Goodwin uses blotting paper in preference to cotton. The chimney is sprung on to the gallery; this simple plan obviates the necessity for the use of the ordinary little screw. The lamp with its attached chimney is seven inches high, and both are nickel plated. It forms not only a portable but also an efficient lamp, and one that will be found specially useful for exhibition and other purposes.

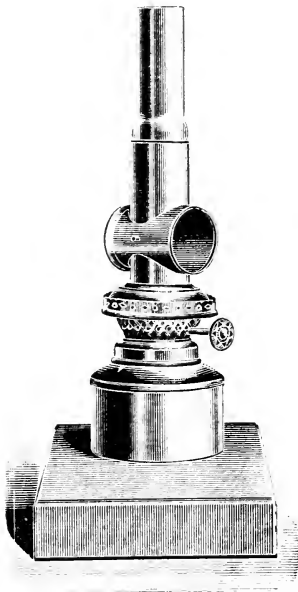

## NOTE ON COLOURED ILLUMINATION.

BY JULIUS RHEINBERG.

*(Read December 15th, 1896.)*

I have the honour and pleasure of bringing before you this evening a new form of substage differential colour illuminator which I have designed in order to simplify and facilitate the use of colour discs and other stops in the substage of the microscope.

You will see that it consists essentially of a box, or slide carrier fitted under the condenser, in which there are a number of metal slides which can be pulled out or pushed in quite independently of one another by means of little handles on both sides of the carrier. Each slide has two circular apertures, the one being fitted with a colour disc or other stop, the other one being left free. The kind of stop is indicated on the handle. The openings in the slides are so arranged that when the apparatus is closed all the free openings coincide, so that illumination can be effected in the ordinary way. When any other illumination is required it is only necessary to pull out the particular stop, or combination of stops, each stop being in accurate position when pulled out as far as it will go.

In the apparatus I have here there are 19 stops, viz., a dark ground stop, four stops which cause the background to assume various colours, four which cause the object to assume various colours, stops causing the object to be illuminated in different colours from opposite sides in various colours (for showing striations), and one causing the object to be illuminated in different colours at right angles to each other, for showing striations etc., similarly situated. There are also stops for oblique light, several annuli, and a ground glass stop, making a compendium no doubt somewhat too great for the general worker, but which is very serviceable to the experimentalist.

As far as colour discs are concerned the stops are so arranged that all those which can be pulled out from the left side of the



carrier cause the background to be coloured, whilst those which can be pulled out from the right side cause the object to be coloured.

The number of effects which can be obtained with such an apparatus is unlimited. Mr. Rousselet showed us some weeks ago an ingenious colour illuminator, by which, according to a little mathematical calculation, 36 effects could be obtained. By applying a similar calculation to this arrangement it would give  $19^{18}$  power, or some few hundred millions of combinations. This number may be too much even for an enthusiast, and I prefer to pass over from the quantitative to the qualitative use of the arrangement.

I venture to think, Mr. President, that for simplicity in use it cannot be excelled, as it allows of every kind of illumination and stop being automatically brought into action whilst the object is under examination. The best result can, therefore, be obtained with far greater rapidity than ordinarily, and comparisons can be effected without having to bother about taking stops in and out, as in the ordinary way. The apparatus in my hand, although efficient, is of course needlessly clumsy and heavy. Apart from the brass box, I made it myself, to fit my own instrument. I believe, however, the principle can be easily adopted in a neater form, and made to fit any condenser.

---

FURTHER NOTE ON SOME RECENT OBSERVATIONS ON THE FOOT  
OF THE HOUSE FLY.

BY A. A. C. ELIOT MERLIN.

(Read January 15th, 1897.)

With reference to my note read April 19th, 1895, I have now succeeded in mounting specimens of the fly's foot with the *pulvilli* and tennent hairs stained, and showing, adhering to the ends of the hairs, the viscid globules by means of which the insect is enabled to attach itself to smooth surfaces.

I forward with this note a specimen of a fly's foot so mounted and stained with fuchsin, which may be fairly well shown under a good dry lens. The details, however, are seen better with an oil immersion. Some of the hairs on this slide show the sickle filaments deeply stained and devoid of any adhering substance, others have a small quantity of the gummy fluid held within the hollow of the sickle, while the majority of the hairs are tipped with large globules that could easily be mistaken for permanent knobs or suckers.

The specimen also distinctly shows that the shafts of the hairs fringing the *pulvillus* do not spring separately from it, but each root or stem forks off near the base, forming two hairs. I believe Mr. Nelson first drew attention to this fact in his letter to the "English Mechanic" of March 22nd, 1895.

I had hoped that the staining would have rendered visible the orifice from which the adhering substance exudes, as the opening should be large, considering the size of the attached globules, but no such orifice has been detected. Judging, however, from the way the viscid substance seems in most cases to be held within the hollow of the sickle, it appears possible that a slit may exist along the filament capable of expanding and allowing the substance to exude freely.

The foot in question has been subjected to no cleaning process. Any attempt at such would inevitably clear away the globules adhering to the hairs, as is the case in ordinary preparations.

## ON THE EVOLUTION OF THE MICROSCOPE.

BY EDWARD M. NELSON, P.R.M.S.

YOUR Committee, having thought that an impartial account of microscopes and apparatus published in your Journal from time to time would, by enabling students to thoroughly understand and scientifically appreciate the various parts and movements of modern microscopes, not only benefit the members, but also fulfil one of the primary intentions in the foundation of this Club, have appointed a Sub-Committee to report on the matter.

The Sub-Committee have come to a unanimous conclusion that as one of the means of guidance for the future is a study of the errors of the past, the end will be best served by (*a*) a thorough investigation of a good type of instrument designed at some period subsequent to the introduction of achromatism, tracing the development of its various parts from the earliest times. (*b*) A study of modern instruments, showing wherein and why they either follow or depart from the selected type. (*c*) The collation of other material bearing on the development of modern microscopes though not falling within the limits of *a* and *b*.

The first step, then, was the choice of a type; in this the Sub-Committee had little difficulty, for the type must obviously fulfil two conditions. (1) It must be that towards which the modern microscope is tending. (2) It must be a permanent form.

There is only one microscope in which both these necessary conditions are to be found, and that is Powell's No. 1, for it requires the slightest observation to perceive (1) that the best modern microscopes are more and more conforming to that type, and (2) that it has remained in its present form for upwards of twenty years.

Our first duty, then, is to lay before you all the causes accumulated since the invention of the microscope, that

have probably influenced the design of Powell's No. 1. We say probably, because it is possible that Powell's No. 1, or any other form of microscope or apparatus, might have been designed by an inventor wholly unacquainted with any preceding form, though in the absence of any evidence to the contrary such a hypothesis would be highly improbable.

Those parts of this paper which treat of old microscopes are not intended to be a history of the microscope; many interesting old forms will not even be mentioned. For the most part attention will be drawn to only those instruments that have been rungs in the ladder of evolution.

To begin, then, neither the name of the inventor nor the date of the first compound microscope has been with certainty determined. There is an extensive literature on the subject, and the conclusion arrived at is that the first microscope was probably made by Jansen, a spectacle maker, of Middelburg, in Holland, about the year 1660. An old microscope, supposed to be a Jansen, was exhibited at the loan collection of scientific instruments at South Kensington in 1876 (catalogue No. 3,510), the date of it given in the catalogue being 1590. This instrument had neither stand, object-holder, nor stage; the only mechanical movement with which it was furnished was a draw tube for separating the two convex lenses which formed the optical part of the instrument (Fig. 1).

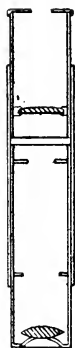

Fig. 1.

The next step is to be found in a drawing of a simple microscope by Descartes in his "Dioptrique" in 1637. This shows a plano convex lens placed at the vertex of a concave mirror; in short it is an instrument now known as a Lieberkuhn. It is curious to note that while Descartes is very particular about the parabolic curves of his mirrors and the hyperbolic curves of his lenses the figures show the lenses turned the

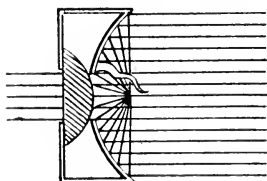

Fig. 2.

wrong way, which would cause the spherical aberration to be increased four-fold. Now as the difference between the aberrations arising from the spherical and hyperbolic curves is for the purposes under consideration insignificant, the

above is a remarkable instance of straining out a gnat and swallowing a camel (Fig. 2).

The next important step is the application of a field lens to the eye-piece by Monconys and Hooke. Monconys' microscope was made in 1660, an account of it being published in 1665. The application of a field lens was also claimed by Hooke, who in 1665 published an account of his microscope.\* Hooke's microscope is a very important one, for in it we find several new features, such as the inclination of the body, a screw focussing adjustment, a movable object-holder, and an entirely

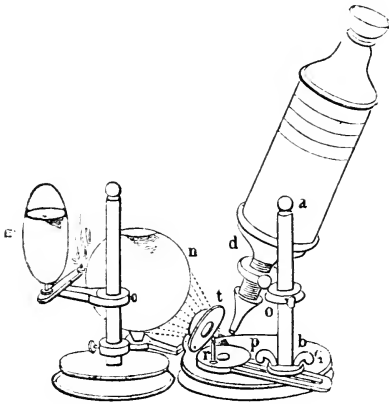

Fig. 3.

novel illuminating apparatus. In Fig. 3 we see a heavy circular foot, *p*, with an upright post, *b*, fixed excentrically to it. The limb which holds the body of the microscope is attached to the post by a sliding ring, *o*, and screw clamp. The limb is also jointed by a ball and socket. At the other end of the limb is a ring, *d*, into which the body screws with a coarse thread. This forms the fine adjustment. The body, *a*, was fitted with four draw tubes. This form of mounting for the body of a microscope I call the "telescope mount," for the microscope is pointed at the object precisely in the same manner as a telescope would be. There is an ingenious object-holder, *r*, consisting of a spike capable of rotation, held by a short pillar attached excentrically to a rotating disc. This disc is held in position

\* Mr. Mayall, jun., was of opinion that Monconys' invention preceded that of Hooke. Cantor Lecture, Society of Arts, Feb. 27th, 1888.

by a link and butterfly nut,  $q$ ; obviously, therefore, the object can be placed in any desired position by these combined movements.

The lamp also was attached to a separate upright support by a ring and screw nut, very much in the same way as it is fixed at the present time. There was an engraver's globe,  $n$ , filled with water for a primary condensing bull's eye, and a plano-convex lens, turned in its proper position,  $t$ , as a secondary condensing lens was fitted to a double-jointed arm. The illuminating apparatus was therefore suitable for opaque objects, and must be regarded as being very complete and efficient in its day.

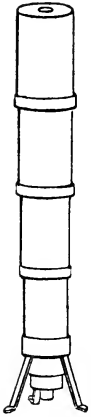

Fig. 4.

Fig. 4 shows Divini's microscope (1667). The interest in this instrument is not in the mount, which is of the crudest form, but in the optical part, for in place of the biconvex eye lens two plano-convex lenses, with their convex surfaces in contact, were used. This plan would halve the amount of the spherical aberration.

Fig. 5 exhibits an improvement on the preceding form, by Chérubin d'Orléans (1671). The body was more rigidly mounted by the enlargement of the tripod foot. A screw movement was fitted to the stage for focussing. In the optical part there is an erector. Chérubin d'Orléans was the first to apply an erector to his monocular microscope, and he was also the first to construct a binocular microscope. The binocular instrument would, according to the drawing, have given a pseudo-stereoscopic image.

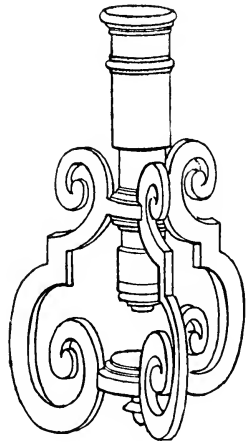

Fig. 5.

In 1672 Sir Isaac Newton suggested a reflecting microscope of the form of a Herschelian telescope. It probably was never made.

Leeuwenhoek's microscopes, constructed in 1673, are remarkable more on account of the man who used them than for their

design, which was crude in the extreme. It is indeed difficult to understand how the discoveries he made could have been carried out with such rude apparatus.

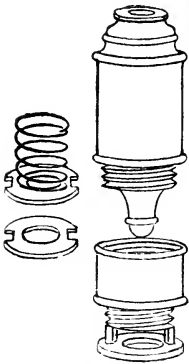

Fig. 6.

In 1687 we find a microscope by Grindl very similar to Fig. 5. The optical part, however, consisted of three pairs of plano-convex lenses.

In 1691 several new features appear. Fig. 6 shows a screw-barrel compound microscope by Bonanni. The slider placed between two plates pressed together by a spiral spring, was made to approach or recede from the objective by a screw. This simple arrangement, known as the "screw barrel," played an important part in the history of the

microscope for upwards of 100 years.

To Bonanni we are also indebted for a horizontal microscope in 1691 (Fig. 7). This instrument is noteworthy, first for the

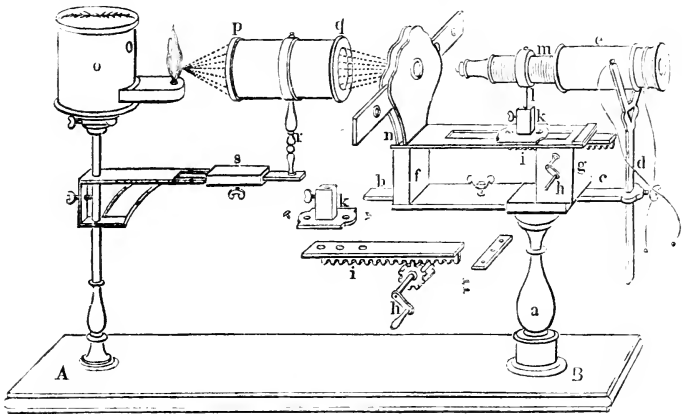

Fig. 7.

double support to the body. A glance at Hooke's (Fig. 3) will convince anyone how rickety the body must have been when only held by its focussing screw, so here we have a decided improvement. Secondly, we have a rack, *i*, and pinion, *h*, coarse adjustment, in addition to the usual screw fine adjustment, *m*, of that period. There is also an improvement in the stage, and the

last, and perhaps the most important novelty, is the compound substage condenser, *p, q*. Hooke's illuminating apparatus was, as we have seen, more suitable for opaque objects; this, on the

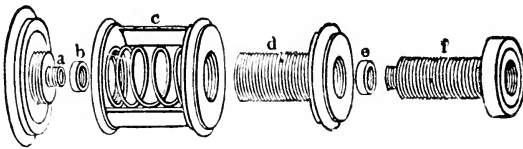

Fig. 8.

other hand, is more adapted for the illumination of transparent objects. We now come to an excellent simple microscope by Hartsoeker, in 1694 (Fig. 8). It will be observed that the Bonanni screw-barrel focussing arrangement, *c, d*, is maintained. The novelty, however, consists in the substage condensing lens, *e*, which can be focussed on the object by screwing, *f*, into the screw focussing tube. The important point in this arrangement is that the focus of the condenser is not disturbed while the object is being focussed to or from the magnifying lens. To Hartsoeker we are also indebted for a compressor.

Wilson's screw barrel, of 1702, then known as the pocket microscope, was a popular form of simple microscope in the 18th century; it was very similar to Hartsoeker's, the main difference being that the substage condensing lens had no separate focussing adjustment. Culpeper subsequently mounted these microscopes on a pillar rising from a flat folding tripod foot, a mirror and condensing lens being attached; he also added a compound body to them. Later, in 1742, the Wilson screw barrel was mounted on a brass scroll fixed to a circular wooden foot, to which was attached a concave mirror.\* In this same year it is also stated that two diaphragms were supplied with the ordinary hand Wilson screw barrel simple microscope, to fit in a cell close to the substage condenser, to reduce its aperture when high powers were used. This is the earliest notice of diaphragms for regulating the illumination.

In the year, 1702, we find a crude form of simple microscope by Mussenbroek. The only point of interest it possesses is to be found in a sector of graduated diaphragm holes. The pur-

\* Henry Baker "On the Microscope," 1st Edition, 1742.



pose of these diaphragms was for diminishing the spherical aberration by cutting down the *apertures of the observing lens* and not for regulating the *illumination*. The next model, that of John Marshall, 1704, takes us on several steps in the evolution of the microscope (Fig. 9). Here we first meet with the box-foot,

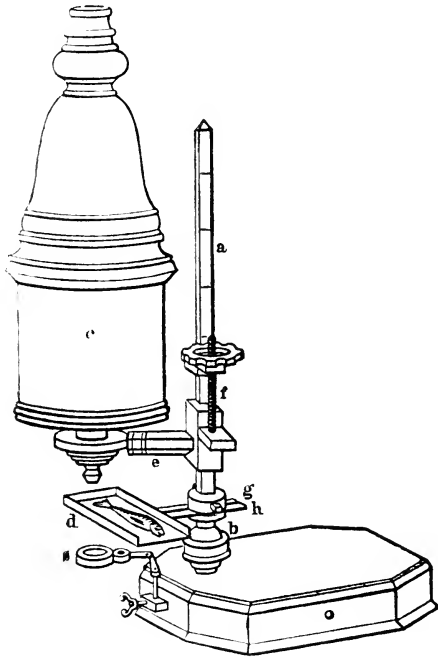

Fig. 9.

a distinctive feature which lasted for nearly 130 years. The coarse adjustment is effected by a collar and jamb-screw sliding on a square bar, the fine adjustment by a direct acting screw, *f*. It is hardly correct to speak of the sliding arrangement as a coarse adjustment because the post, *a*, was marked with numbers corresponding with similar numbers marked on the objectives; the body remained clamped at the given mark until the objective was changed, all the necessary focussing being performed by means of the direct acting screw. The great advance made in this model consists in the pivoting of the lower end of the bar, *a*, on a ball and socket joint, *b*. As the stage, *d*, is also fixed to this

bar it is obvious that when the instrument is inclined the stage is also inclined with it. This feature is totally distinct from the "telescope mount," and is one specially important in the evolution of the microscope.

*(To be continued.)*

[The Editor expresses his obligation to the publishers of the German edition of "Harting on the Microscope" for Figs. 3, 7, 8 and 9.]

---

## PROCEEDINGS.

3RD JULY, 1896.

<i>Acineta grandis</i>	...	...	...	...	Mr. W. Burton.
Foraminifera	...	...	...	...	Mr. E. Earland.
<i>Hydra viridis</i>	...	...	...	...	Mr. J. Holder.
<i>Triceratium curvato-vittatum</i>	...	...	...	...	Mr. H. Morland.
Radiolaria...	...	...	...	...	Mr. J. Neville.
<i>Forcepia colonensis</i>	...	...	...	...	} Mr. B. W. Priest.
<i>Corticum kittonii</i>	...	...	...	...	
Cyclosis in <i>Nitella</i>	...	...	...	...	Mr. W. Traviss.

17TH JULY, 1896.

<i>Limnias ceratophylli</i>	...	...	...	...	Mr. J. M. Allen.
<i>Orthezia insignis</i>	...	...	...	...	Mr. W. Burton.
Chelifer	...	...	...	...	Mr. A. Earland.
Genital organs of the Drone Fly	...	...	...	...	Mr. W. Goodwin.
Foraminifera, etc.	...	...	...	...	Mr. B. W. Priest.
<i>Degeeria</i> scales	...	...	...	...	Mr. W. Stokes.

18TH SEPTEMBER, 1896.

<i>Coryne vaginata</i>	...	...	...	...	Mr. W. Burton.
<i>Stephanoceros</i>	...	...	...	...	Mr. W. R. Traviss.

2ND OCTOBER, 1896.

<i>Plumatella repens</i> ...	...	...	...	...	Mr. W. Burton.
<i>Ortalis vibrans</i>	...	...	...	...	Mr. H. E. Freeman.
Larval stage of a Gnat	..	...	...	...	Mr. W. Goodwin.
<i>Aulacodiscus comberi</i>	...	...	...	...	Mr. H. Morland.

## OCTOBER 16TH, 1896.—ORDINARY MEETING.

J. G. WALLER, Esq., F.S.A., President, in the Chair.

The minutes of the preceding meeting were read and confirmed.

Mr. Henry Tavenor was balloted for and duly elected a member of the Club.

The following donations were announced :—

“The International Journal of Micro- scopy” ... ..	} From the Editor.
“The Microscope” ... ..	” ”
“The American Monthly Micro- scopical Journal” ... ..	} In exchange.
“Transactions of the Ealing Micro- scopical Society” ... ..	} From the Society.
“Proceedings of the Bristol Natural History Society” ... ..	} ” ”
“Proceedings of the Royal Society” ...	” ”
“Proceedings of the Croydon Micro- scopical Society” ... ..	} ” ”
“Reprint of a Paper on Rotifers” ...	From Mr. Hempel.
Forty-nine Slides of Rotifers ... ..	” Mr. Rousselet.
Five Slides of Rotifers ... ..	{ ” Surgeon V. Gunson Thorpe.

The attention of the members was specially called to this further donation by Mr. Rousselet of examples of Rotifers towards the completion of a type series, and the special thanks of the meeting were voted to him for this very valuable addition to the cabinet of the Club.

Mr. Karop described on the board a new device by Messrs. Swift for obtaining coloured ground illumination, consisting of a plano-convex lens placed below the object, the central portion of the plane surface being of one colour and the periphery another. He regretted that through oversight he had omitted to bring to the meeting the lens which Messrs. Swift had sent to him during the vacation.

Mr. Swift said he had a similar lens exhibiting in the room.

Mr. Rousselet said he had with him a small device which effected the same result, but in a different way. It consisted of a series of coloured discs which could be used in combination,

and would give altogether 36 changes. The chief point to be noted in order to ensure success was to have the central colour very dark and the margin very light.

Mr. Rheinberg said he had found a very simple way of obtaining one colour was to have a ring of black between the two colours. This ensured a ground of one colour only.

A vote of thanks to Mr. Karop and those who had spoken on the subject was passed on the motion of the President.

Mr. Goodwin exhibited and described the perfected form of his small microscope lamp, which had been improved in various ways since last brought before the Club. He still used the paper wick, but found it ensured a more regular supply of oil to have this attached to some cotton in a glass tube passing to the bottom of the reservoir; this entirely obviated the inconvenience of too much oil rising and flowing over.

Mr. E. M. Nelson said he had seen many lamps which had been brought out from time to time, but had discarded the small ones because they were imperfectly made, and they all leaked. He thought, however, that a good small lamp for exhibition work was much wanted. The one which Mr. Goodwin had shown them was very nicely made, and it was quite equal to those requirements; the blotting-paper wick was a very good idea, and he certainly thought Mr. Goodwin had "scored one."

Mr. Karop said that next to the capabilities of a lamp the thing of most importance about it was to know what was its commercial value. Could Mr. Goodwin tell them about what it would be likely to cost?

Mr. Goodwin believed that it would be sold at about 10s., or if made with the best glass, about 2s. more.

Mr. Karop said the blotting-paper wick was very ingenious, but he believed there was one to be had which never required attention, either cutting or cleaning. It was called the simplex wick, and was used by cyclists. He thought the suggestion might be worth trying.

The thanks of the Club were voted to Mr. Goodwin for his communication.

Mr. E. M. Nelson made some further remarks upon drawings made from the microscope with a camera lucida, showing by means of diagrams on the board how the distortion towards the

edge of the field was produced, and suggesting some plans to modify or remedy it. One of these was by the use of a thick plate of glass, which would, by refracting the rays, cause a greater displacement of the image at the periphery than at the centre of the field, but for other reasons the idea was abandoned.

Mr. Hardy was sure the members of the Club would be very much indebted to Mr. Nelson for letting them know just what the error was ; but the mention of the subject brought to his mind a method of drawing which he had used himself, and thought would be found a very good one. When a person was using the microscope and wanted to draw an object he of course wanted to draw it as it was seen, and it required a great deal of practice to draw direct from the microscope ; but by using a neutral tint reflector and turning it at right angles they would find it corrected the false views, and that if the drawing board was placed parallel to the reflector there must be very little error indeed ; indeed he doubted very much if there would be any error at all. Mr. Hardy explained further what he meant by a drawing upon the board.

Mr. Nelson pointed out that they must always have the same error in whatever position the drawing-board was placed, because they were projecting a portion of a sphere upon a plane surface, and this surface always formed a tangent to the arc. The problem to be solved was how correctly to project part of a spherical image upon a plane. By a further diagram he showed that the plan suggested by Mr. Hardy did not in any way alter the conditions.

Mr. Morland asked if Mr. Nelson's calculations of error were based upon the assumption of a distance of ten inches ?

Mr. Nelson said that was so.

Mr. Hardy thought that if an aplanatic lens was used there would be very little distortion to correct ; but apart from this there was really so little curve that there would be very little error to be corrected.

Mr. Nelson said that Mr. Hardy's supposition was quite erroneous, and that aplanatism had nothing whatever to do with the subject. Mr. Hardy by his method did not remove any portion of the error, but only altered its position.

Mr. Ingpen said if they took a drawing of an object ruled in squares the whole of the error would be at once made clear.

There could be no possible doubt as to the aberration, and their thanks were due to Mr. Nelson for this further contribution to their knowledge of the subject.

Announcements of meetings and excursions for the ensuing month were then made, and the proceedings terminated with the usual conversazione.

Infusoria and Rotifera ... ..	Mr. W. Burton.
<i>Asplanchna ebbesbornii</i> (mounted) ...	Mr. C. Rousselet.
<i>Hydatina senta</i> ... ..	Mr. W. Traviss.

---

6TH NOVEMBER, 1896.

<i>Cordylophora</i> ... ..	Mr. A. W. Bird.
Rotifers ... ..	Mr. W. Burton.
<i>Tegeocranus latus</i> (Koch.) ... ..	Mr. A. Earland.
<i>Spirobis communis</i> ... ..	Mr. W. Goodwin.
Freshwater Algæ, from St. Ives ...	Mr. G. Mainland.
<i>Camphylodiscus californicus</i> ... ..	Mr. H. Morland.
Karyokinesis of <i>Fritillaria</i> .. ..	Mr. E. M. Nelson.
<i>Echinus miliaris</i> ... ..	Mr. B. W. Priest.
<i>Brachionus militaris</i> (America) ... ..	Mr. C. Rousselet.

---

NOVEMBER 20TH, 1896.—ORDINARY MEETING.

J. G. WALLER, Esq., F.S.A., President, in the Chair.

The minutes of the preceding meeting were read and confirmed.

The following donations to the Club were announced :—

“Proceedings of the Royal Society of N.S. Wales” ... ..	}	From the Society.]
“The Botanical Gazette” .. ..		„ the Publisher.
“The American Monthly Microscopical Journal” ... ..	}	„ ”
“The Microscope” ... ..		„ ”
“Proceedings of the Royal Society” ...		„ the Society.
“Proceedings of the Historical Society of Montreal” ... ..	}	„ ”
“Annals of Natural History” ... ..		Purchased.

The thanks of the Club were unanimously voted to the donors.

Mr. T. B. Rosseter read a paper "On some new Species of *Tænia* and *Cysticercus*," illustrating the subject by diagrams and drawings on the black-board, and also by specimens exhibited under the microscope in the room.

The President said they were greatly indebted to Mr. Rosseter for giving them the results of his observations upon these new species of entozoa, and for the very interesting paper which he had read. Unfortunately for any chance of discussion Mr. Rosseter seemed to be the only member present who had devoted attention to the subject, but he was quite sure that all would admire the industry and perseverance with which the study had been pursued, and would join in a hearty vote of thanks to Mr. Rosseter for his communication.

A vote of thanks was then put from the chair, and carried unanimously.

Mr. Rosseter said he was much obliged to the members for the way in which they had received his paper, for although he had been a member of the Club for the last twelve years this was the first time he had been able to be present at one of the meetings, and he could only regret that his acquaintance with the faces of the members was so slight in comparison with his familiarity with their names. He was almost surprised to find that with all their acquaintance with the inhabitants of ponds so little attention had been given to the creature he had been describing, because in the early stage it was found inhabiting the *Cypris*, and this not in solitary instances. He had seen as many as five in one individual, and had a specimen containing three. Much still remained to be done in order to ascertain the complete life history of these creatures. They wanted to know, for instance, how they got into the *Cypris*. Were they taken in as food, or did they bore their way through? He felt sure that the subject was one which would afford plenty of employment to anyone who would take it up.

Mr. Soar read a paper "On some Species of *Hydrachnidæ* found at the Q.M.C. Excursions." The illustrations to this paper were a series of coloured drawings on 41 sheets, each devoted to one species—15 genera and 32 distinct species being represented.

On the motion of the President a hearty vote of thanks was passed to Mr. Soar for this very interesting exhibition.



Announcements of meetings for the ensuing month were then made, and the proceedings terminated with the usual conversation.

<i>Bacillaria paradoxa</i>	...	...	...	Mr. W. Burton.
Diatoms	...	...	...	Mr. W. Goodwin.
Young Cattle Ticks	...	...	...	Mr. R. Lewis.
<i>Urocentrum turbo</i>	...	...	...	Mr. W. Traviss.

---

4TH DECEMBER, 1896.

<i>Dinops longipes</i>	...	...	...	} Mr. W. Burton.
<i>Stephanoceros eichhornii</i>	...	...	...	
Foraminifera	...	...	...	Mr. A. Earland.
<i>Phthirus inguinalis</i>	...	...	...	Mr. H. E. Freeman.
<i>Campanularia fragilis</i>	...	...	...	Mr. G. T. Harris.
<i>Aulacodiscus kittonii</i> (abnormal form)	...	...	...	} Mr. E. M. Nelson.
Hepatica (elaters and spores)	...	...	...	
<i>Spongilla inglosformis</i> (statoblasts)	...	...	...	Mr. B. W. Priest.

---

DECEMBER 18TH, 1896.—ORDINARY MEETING.

J. G. WALLER, Esq., F.S.A., President, in the Chair.

The minutes of the preceding meeting were read and confirmed.

The following gentlemen were balloted for and duly elected members of the Club:—Mr. Humphrey B. Chamberlin, Mr. Alexander R. Tweedie, Mr. F. W. Chipps.

The following donations to the Club were announced:—

“The Victorian Naturalist”	...	...	From the Editor.
“Proceedings of the Literary and Philosophical Society of Liverpool”	}	..	Society.
“Proceedings of the Geologists’ Association”		...	..
“Proceedings of the Manchester Literary and Philosophical Society”	}	..	..
“The Botanical Gazette”		...	..
“Annals of Natural History”	...	..	Purchased.

The thanks of the Club were unanimously voted to the donors.

Mr. Karop exhibited and described a little stop which had been brought to the meeting by Mr. Swift, and made to fit the diaphragm carrier of an Abbe condenser, for affixing coloured gelatine in colour-ground illumination.

Mr. W. Stokes read a note on "The Cause of Multiple Images from Mirrors," the subject being illustrated by diagrams drawn upon the board.

Mr. E. M. Nelson thought they were to be congratulated on having this matter brought before a meeting of the Club, for so far as he was aware it had never been satisfactorily cleared up before. He thought the author of this paper had succeeded in showing the cause of all the trouble.

Mr. Hardy inquired if a mirror silvered on the upper surface in the same way as the mirror of a reflecting telescope had ever been tried?

Mr. Ingpen said this had been done, but it had been found impossible to keep the surface good for any length of time.

Mr. Michael remarked that many persons used a prism which came to the same thing.

Mr. Stokes said he could see no great advantage in having the surfaces parallel.

Mr. Rousselet thought it was to be inferred from the paper that to get rid of the defect it was necessary that the two surfaces should not be parallel.

Mr. Stokes said they certainly got the multiple images when they were parallel.

Mr. Nelson said he had rather a curious form in an old microscope, a concave mirror with an exceedingly long focus; so long, indeed, that it did not practically affect the image; this did not show a multiple image.

Mr. Michael thought there was nothing equal to a prism for the purpose.

Mr. Ingpen said these mirrors used to be made at one time with a very slight curve, because they could not make them truly flat.

The thanks of the meeting were voted to Mr. Stokes for his paper.

Mr. Rheinberg's paper "On a New Differential Coloured Sub-stage Illuminator" was read by Dr. Measures, and the

apparatus was exhibited as described, the Secretary asking members to be as careful as possible in handling it.

Mr. Orfeur said that some months ago he exhibited a stage for producing similar effects and had since been experimenting upon the advantages of various colours for the discs, and had devised some, which when put into the stops gave the best possible results for all purposes. He found that red for the object and blue for the ground—blue and dark amber—and pale saffron on dark green—practically gave all the varieties wanted, whilst the mode of introducing them into the field without any alteration of the adjustments was a great advantage. He did not think there could be anything more simple, durable, or effective.

Mr. Nelson inquired where the coloured gelatine could be obtained?

Mr. Orfeur said he got it from Mr. Green at Dalston. It was sold in packets at 1s. 6d.

Mr. Karop thought it would be a convenience if some member would obtain some for distribution to others in smaller quantities; no one would, of course, want to use so much as was contained in a packet.

Mr. Mainland said he had tried Mr. Rheinberg's plan, and found that with a low power objective the effects were very fine, especially with a malachite green ground, but he found he got the finest effects by using plain light on the object.

Mr. Nelson said there was no doubt that very important effects could be obtained by the use of these gelatine colours if only the right ones were employed. Monochromatic screens were of great use in almost all departments, and those hitherto made were of two kinds. One of these was Mr. Gifford's plan by a coloured fluid in a glass cell. The other form was made by mixing up the colour in some compound and smearing it on the green glass. This was not so good as the other, because it was apt to be cloudy, but if they could get suitable colours in gelatine such as they had with crackers they would be able to make a cheap and efficient screen.

A Member observed that the gelatine of crackers was not deep enough in colour, so that it was necessary to use it in several

layers. This did not answer so well; what was wanted was clear gelatine of greater thickness.

Mr. Karop had no doubt that if there was any demand, and the particular colours were ascertained, the gelatine could be manufactured of the right quality.

The thanks of the Club were voted to Mr. Rheinberg for his paper and exhibit, and to Dr. Measures for reading the paper.

Mr. Nelson read a note "On some New Lenses."

Mr. Ingpen remembered the first instance met with of a lens in which the flints were put outside in the form of a sphere of crown in a shell of flint. This was the construction of some old Steinheils which were a great puzzle at the time to many, but he was able at once to explain their construction in that way. He had also a small telescope with a lens made on this principle, and the definition of which was extremely good. The difficulty in construction was, of course, due to the violent curves, which required so much care in adjustment. These lenses were made a long time ago, but Steinheil got over the whole difficulty felt at the time in this way.

The thanks of the meeting were voted to Mr. Nelson for his communication.

The Secretary announced that at the next meeting the members would be asked to nominate gentlemen to fill vacancies upon the committee at the Annual Meeting in February. They would also be called upon to elect an auditor of the treasurer's accounts for the past year, to be submitted to the Annual Meeting. He also said that an application had been received for any help which members were able to render by the exhibition of objects under their microscopes at a series of conversazioni to be held at the Borough Polytechnic on the evenings of December 28th to January 2nd inclusive.

Announcements of meetings, &c., for the ensuing month were then made, and the usual conversazione followed, at which the undermentioned objects were exhibited.

<i>Ophrydium</i> , sp. ?	...	...	...	Mr. J. W. Allen.
<i>Volvox globator</i>	...	...	...	Mr. W. Burton.
Head of an Earwig	...	...	..	Mr. W. Goodwin.
<i>Sertularia pumila</i> ...	...	...	...	Mr. G. T. Harris.
Cyclosis in the root of <i>Nitella</i>	...	...	...	Mr. W. R. Traviss.

1ST JANUARY, 1897.

<i>Volvox globator</i>	...	...	...	...	Mr. J. M. Allen.
Rotifers	...	...	...	...	Mr. W. Burton.
<i>Lagena</i> (various species)	...	...	...	...	Mr. A. Earland.
<i>Bougainvillea muscus</i>	...	...	...	...	Mr. G. T. Harris.
<i>Cysticercus</i> ...	...	...	...	...	Mr. E. M. Nelson.
<i>Metopeira</i> (new species)	...	...	...	...	Mr. C. Rousselet.
Ocelli of Blow fly, sections	...	...	...	...	{ Brigade-Surgeon J. B. Scriven.

JANUARY 15TH, 1897.—ORDINARY MEETING.

J. G. WALLER, ESQ., F.S.A., President, in the Chair.

The minutes of the preceding meeting were read and confirmed.

The following gentlemen were balloted for and duly elected members of the Club:—Mr. E. T. East, Mr. J. Moorcock, Mr. Walter Smith, Mr B. W. Williams, Mr. J. Mottram.

The following donations were announced:—

“Proceedings of the Royal Society”	...	From the Society.
“The Botanical Gazette”	... ..	„ Editor.
“Report of the Zoological Station at Plön”	... ..	} „ Director.

The thanks of the Club were voted to the donors.

The Secretary said that, acting upon a suggestion made by himself at the last meeting, Mr. Orfeur had very kindly procured some coloured gelatine, and had given him a number of envelopes—each containing six pieces of different colours—for distribution to such members as desired to have them, and he should be very pleased to give these out, so far as they would go, at the close of the meeting. No doubt there was more than enough for the use of one person in each envelope, so that those who obtained samples would be able to share them with others. Their thanks were due to Mr. Orfeur for his very useful donation.

The Secretary reminded the members that the next meeting would be their Annual Meeting, at which the election of officers and Committee for the ensuing year would take place, and in

view of this the nominations must be made at the present meeting. They would also be asked to elect an Auditor to act with the gentleman who would be appointed in that capacity by the Committee. The nominations for officers made by the Committee would be as follows:—As President, Mr. J. G. Waller ; as Vice-Presidents, Messrs. Dallinger, Michael, Newton, and Dadswell ; as officers, those who had acted during the current year. The Committee also appointed Mr. J. M. Allen to be the Auditor on behalf of the Committee. There would be this time five vacancies to fill up on the Committee caused by the retirement by rotation of Messrs. Mainland, Priest, Reed, and Spencer, and by the nomination of Mr. Dadswell as one of the Vice-Presidents. All the members of Committee now retiring would of course be eligible for re-election, but he thought he might mention that it would be practically useless to re-elect Mr. Spencer, seeing that on account of ill health he had been unable to attend any meeting of the Committee throughout the year.

The following nominations for members of Committee were then made:—Mr. B. W. Priest, proposed by Mr. Dunning, seconded by Mr. Swift ; the Hon. Sir Ford North, proposed by Mr. Allen, seconded by Mr. Goodwin ; Dr. Tatem, proposed by Dr. Measures, seconded by Mr. Daniell ; Mr. Mainland, proposed by Mr. Burton, seconded by Mr. Lloyd ; Mr. Turner, proposed by Mr. West, seconded by Mr. Murion ; Mr. Slade, proposed by Mr. Newton, seconded by Mr. Reed.

Mr. J. W. Reed was also nominated, but asked that his name might be withdrawn.

As Auditor on behalf of the members, Mr. W. J. Chapman was proposed by Mr. Goodwin, seconded by Mr. West, and unanimously elected.

A paper by Mr. Dunlop on a new species of Rotifer, which it was proposed to call *Metopidia pterygoida*, was read by Mr. Scourfield. The distinctive features of this Rotifer were shown by a diagram drawn upon the board, and a specimen was exhibited under a microscope in the room.

Mr. Rousselet said he could add nothing to the information supplied by this paper. The slide exhibited contained the only specimen yet mounted, and this was in a cell so shallow that the object could not be turned round, and therefore he was

unable to see if it had a dorsal ridge. He would, however, endeavour to remount it so as to be able to turn it round.

The thanks of the meeting were voted to Mr. Dunlop and Mr. Scourfield.

Mr. C. F. Rousselet read a paper on the varieties of *Brachionus Bakeri*, specimens of which were exhibited under microscopes in the room.

Mr. Western thought this paper would be very useful as tending to clear up the difficulties which were found in descriptions of this genus, the varieties of which had tended greatly to a confusion between different species. These variations were by no means restricted to this species, but equally applied to *Brachionus pala*, *B. angularis*, etc., all of which showed the same kind of variety. If such drawings as Mr. Rousselet had shown them could be obtained of other species they would be very useful for reference in the determination of the species.

Mr. Bryce thought that a very useful mode of reference might be the size of the egg, which he had found to be quite a characteristic of species.

Mr. Scourfield inquired if Mr. Rousselet had seen the males of the varieties he had described ?

Mr. Rousselet said he had not seen the males of all the varieties, but he had seen some of them, and they could not be distinguished from each other.

Mr. Karop asked if Mr. Rousselet could tell him what was the origin of the man's face which was shown in many of the earlier illustrations of *Brachionus*. It was of course a comment upon the quality of the instruments used in those days for such investigations, but it appeared in various authors' books, and he supposed therefore it had some common origin. He saw a figure in an old book by Dr. Dick of a creature which might or might not have been intended for a *Brachionus*, but was drawn with six legs, and had a most distinct representation of a man's face on its body. It was said to be something found in an infusion of pepper.

Mr. Rousselet said he believed these were copied from Eichhorn, who drew a figure of a water animal which had that which looked like a man's face upon it.

Mr. E. T. Newton inquired if Mr. Rousselet had observed

any relation between the variations and the habitats of these Rotifers.

Mr. Rousselet had no doubt the varieties had to do with their surroundings, because he had noticed that the *Brachionus* found at the same time were usually of the same varieties, although other varieties might be found at the same place at different times. In the tank at the Botanic Gardens there were constantly two varieties.

Dr. Measures said the slide exhibited by him contained three specimens showing the extent of the variations of those found at Hanwell during the Club excursion on July 25th. He had much pleasure in presenting this slide to the Club.

The President thought papers of this kind were extremely useful, since all the information they could obtain as to variations of species was of importance. He proposed a cordial vote of thanks to Mr. Rousselet for his paper.—Carried unanimously.

Mr. Merlin's paper, "On the Hairs of a Fly's Foot," was read by Mr. Karop, who remarked that in many cases, no doubt, globules at the ends of hairs had been mistaken for trumpet-shaped hairs. It was curious, however, to note that even in these advanced days an old question like this was still unsolved. The slide which accompanied the paper had been handed over to Mr. Nelson for examination.

Mr. Nelson said he had great pleasure in examining this slide, and would suggest that members should go over some of their old slides of insects' feet, because they were very interesting objects. In connection with the questions raised by the paper, he did not see why someone should not inject these hairs, because there was certainly a pipe running down the leg and branching off into smaller pipes, each of which went to one of these hairs, and he thought, therefore, that some of their entomologists who did such wonderful things might be able to do this also.

Mr. Karop read a letter from Mr. Earland describing the contents of a bottle given to the Club some time since by Mr. Andrew, and said at the time to be dredgings from the *Challenger* expedition. It appeared, however, to have come from Port Darwin.

Announcements of meetings for the ensuing month were then made, and the proceedings terminated.



<i>Acineta tuberosa</i> ... ..	Mr. W. Burton.
<i>Campanularia flexuosa</i> ... ..	Mr. G. Harris.
<i>Brachionus bakeri</i> ... ..	} Dr. F. Measures.
„ <i>mülleri</i> ... ..	
„ <i>bakeri</i> (America) ... ..	
<i>Metopidia pterygoida</i> (n. sp.), Isle of Arran	} Mr. C. F. Rousselet.
Hairs of a Pencil-Tail ... ..	Mr. W. Stokes.
<i>Pendicellina cornua</i> , var. <i>glabra</i> (from Bognor) ... ..	} Mr. W. R. Traviss.

---

5TH FEBRUARY, 1897.

Foraminifera ... ..	Mr. A. Jenkins.
The eye of a fish ... ..	} Brigade-Surgeon J. B. Scriven.
Nucleus showing Karyokinesis ... ..	
	Mr. E. M. Nelson.

---

ANNUAL MEETING.—FEBRUARY 19TH, 1897.

J. G. WALLER, Esq., F.S.A., President, in the chair.

The minutes of the preceding meeting were read and confirmed.

Mr. Walter Dendy was balloted for and duly elected a member of the Club.

The President also notified that the Committee had nominated Dr. B. T. Lowne as an honorary member of the Club.

The following donations to the Club were announced:—

“The Botanical Gazette” ... ..	From the Publishers.
“Bulletin of the University of Wisconsin”—descriptive of North American Mosses ... ..	} From the University.
“Proceedings of the Belgian Microscopical Society” ... ..	
“The Noxious Insects of Illinois	} From U.S. Bureau of Agriculture.
“Larvæ of British Butterflies,” Vol. vii.—Ray Society’s publication	
“La Nuova Notarisia ... ..	In exchange.
“The American Monthly Microscopical Journal” ... ..	”

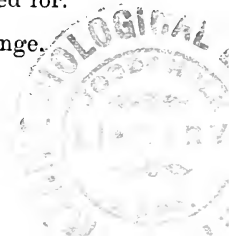

“ The Microscope ” ... .. In exchange.  
 “ The Cambridge Natural History,” }  
 Vol. ii. ... .. Purchased.

The President appointed Dr. Measures and Mr. J. M. Allen to act as scrutineers of the ballot.

The Secretary, in reference to the ballot papers, said it would be noticed that although six members were nominated for the five vacancies on the Committee at their last meeting, only five names were printed on the lists, as Mr. W. B. Priest had asked that his name might be withdrawn.

The Annual Report of the Committee was then read by the Secretary.

The Treasurer also read his annual statement of accounts, and submitted the balance-sheet for 1896 duly audited.

Dr. Measures had great pleasure in moving that the report as presented by the Secretary, and also the balance-sheet just read by the Treasurer, be received and adopted. The report was one of the most gratifying it was possible for the members of any Society to listen to, and he felt sure those present would agree with him that for the high character maintained by the Club they were largely indebted to their Secretary. The able way, also, in which the Treasurer had discharged his duties was also equally well known, and the financial condition indicated by the balance-sheet needed no remark from him.

Mr. Swift having seconded the motion, it was put to the meeting by the President and carried unanimously.

The President said they had next to bring forward a matter which he felt sure would be a cause of equal satisfaction to the members present. The report had referred to the prosperous condition of the Club, and they were most of them aware how much of that prosperity was due to the energy of their Secretary, who had brought them through a very trying period in their history, with the results they had before them. It was felt by many that they owed Mr. Karop a debt of gratitude, and it was thought that the time had come when this should be practically recognised. It had, therefore, been proposed that some kind of testimonial should be presented to him—not of course in any way as a payment for services rendered, but as an expression of personal regard and appreciation in connection with the way in which his duties had for so long a time been

carried out. He had great pleasure in calling upon Mr. Vezey, the Treasurer of the Testimonial Fund, to make a statement as to what the Committee had done.

Mr. Vezey then read the following address which had been prepared for presentation to Mr. Karop:—

“DEAR MR. KAROP,—On behalf of a large number of the members, whose names are appended, we desire to avail ourselves of the opportunity afforded by the 31st Annual Meeting to express to you our highest appreciation of the invaluable services you have rendered to the Club as its Honorary Secretary for the past twelve years.

“We acknowledge with the warmest gratitude the unwearying attention you have given to the Club’s affairs during that period, and the valuable time you have spared from your professional duties to attend to its interests. Your courteous readiness to assist all those needing instruction in the various branches of microscopy has been the means of providing a continued supply of new members, and the proud position the Club now holds, and the intelligent interest manifested in all its meetings, is largely due to your efforts. We ask you to accept the accompanying purse of 60 sovereigns, not in any way as a measure of our gratitude, but as a small token of our esteem and regard for you, and of our good wishes for your future health and prosperity. We trust the ‘Quekett Microscopical Club’ may long have the benefit of your invaluable assistance.

“We are, dear Mr. Karop,

“Yours faithfully,

“J. G. WALLER, President.

“J. J. VEZEY, Treasurer.

“F. A. PARSONS, Hon. Sec. Testimonial Committee.”

The President having handed to Mr. Karop the copy of the address, and presented a purse containing £60:

Mr. Karop said he was sure he should have their sympathy, as he found himself literally without words to express his feelings in reply to the very kind words in which the President and the Treasurer had seen fit to take notice of his services, and the very handsome way in which the members of the Club had thought proper to recognise them. The address which had been read referred to his official connection with the Club as extending over twelve years—he rather thought it was thirteen

—a long, and perhaps too long, a period of continuous service, but he hoped it was true that he had always done his best to further the interest of the Club, and the knowledge that he had received their approbation for so long a time had rendered the work nothing but a pleasure. There was, however, sometimes a possible impression in his mind that he might after all be getting a little mouldy, for he quite thought it was possible for a Secretary to be in office too long, and if they thought that this applied in any degree to his own case he hoped that they would not fail kindly to give him the hint. When he took over the duties from Mr. Ingpen he found everything in such order, and had always received so much assistance from him that the trouble was scarcely to be thought of. The help also which had always been afforded to him by the seven Presidents who had held office during the period, and the consideration always shown by the Officers and Committee, and by the members generally, had contributed largely to render his work a pleasant one. He thought, perhaps, he ought to say something as to the rather mercenary form which he had chosen for this testimonial. It was, of course, difficult to suggest anything original in this way—a portrait was sometimes presented; this would hardly be useful—a piece of plate; having inherited a little he did not want more—a watch he had, and he also had microscopes—but when working at any particular branch one often wanted a book or a piece of apparatus which one had to do without, because they cost more than could be conveniently given at the time, and he had therefore asked them to allow him to make use of their gift in that way. He could only again tender to them his hearty and sincere thanks both for what they had done and for the kind way in which it had been done.

Mr. Ingpen said that Mr. Karop had made some reference to the time he had been in office, whether twelve or thirteen years, and he might explain this by saying that during the last year, when he was himself the Secretary of the Club, he was able, through his failing eyesight, to do very little of the work, and that this was therefore done for him by Mr. Karop. He was glad to be able to mention this, as he very greatly appreciated this kindness.

The President said that the Scrutineers had handed in their

report of the result of the ballot, from which it appeared that the whole of the gentlemen whose names were printed on the lists had been elected to the offices for which they were nominated, the list being as follows:—

<i>President</i>	...	...	J. G. WALLER, F.S.A.
<i>Four Vice-Presidents</i>	...	...	REV. W. H. DALLINGER, LL.D., F.R.S.
			A. D. MICHAEL, F.R.M.S.
			E. T. NEWTON, F.R.S.
			E. DADSWELL, F.R.M.S.
<i>Treasurer</i>	...	...	J. J. VEZEY, F.R.M.S.
<i>Secretary</i>	...	...	G. C. KAROP, M.R.C.S., F.R.M.S.
<i>Foreign Secretary</i>	...	...	C. ROUSSELET, F.R.M.S.
<i>Reporter</i>	...	...	R. T. LEWIS, F.R.M.S.
<i>Librarian</i>	...	...	ALPHEUS SMITH.
<i>Curator</i>	...	...	E. T. BROWNE, B.A., F.R.M.S.
<i>Editor</i>	...	...	E. M. NELSON, PRES. R.M.S.
<i>Five Members of Committee</i>	...	...	THE HON. SIR FORD NORTH, F.R.M.S.
			J. F. TATHAM, M.A., M.D., F.R.M.S.
			G. E. MAINLAND, F.R.M.S.
			C. TURNER.
			J. SLADE, F.G.S.

The President then read his Annual Address.

Mr. E. T. Newton said he rose with very great pleasure to ask them to return their warmest thanks to the President for his valuable Address. It contained so many points of interest which they would like to think over, that he hoped they would not only return their thanks but would also ask the President to allow the Address to be printed and circulated in the usual manner.

Mr. J. Slade having seconded the motion, it was put to the meeting by the mover and carried by acclamation.

The President thanked the members for the way in which his Address had been received, and had great pleasure in acceding to the request that it should be printed. He also thanked them very heartily for the honour they had done him in again electing him as President of the Club.

A vote of thanks to the Auditors and Scrutineers was proposed by Mr. Neville, seconded by Mr. Burton, and unanimously carried.

Mr. J. D. Hardy then proposed a vote of thanks to the

Officers and Committee of the Club for their services during the past year. This motion was seconded by Mr. Soar, and being put to the meeting by the President, was unanimously carried.

Mr. Vezey, on behalf of the Officers, suitably acknowledged the compliment, and expressed the pleasure they felt in doing their duty, and in observing as the result the growing prosperity of the Club.

The Secretary thought the members would be glad to know that the Committee had decided to hold a soirée this year, and had fixed the date as Tuesday, May 4th, and the place Queen's Hall, Langham Place.

<i>Hydra viridis</i>	...	...	...	...	Mr. J. M. Allen.
<i>Actinospherium eichhornii</i>	...	...	...	...	Mr. W. Burton.

---

## THIRTY-FIRST REPORT OF COMMITTEE.

Your Committee is again in a position to give a satisfactory account of the Club's affairs during the past year.

In the twelve months up to December last twenty-one new members were elected and 47 lost by resignation or death. The former is rather below and the latter considerably above the averages for some years, and although both are necessarily fluctuating quantities, members are reminded it is by individual effort on their part to introduce new entries that the numerical efficiency of the Club can alone be maintained.

The Club has suffered a great loss by the death of Mr. T. H. Buffham, a most valued member and contributor of some of the best original work ever brought before it. A brief memoir and an appreciative estimate of his scientific labours, written by Dr. De-Toni, of Padua, was given in the Journal. Death has also removed several old friends, amongst whom may be mentioned Mr. F. C. S. Roper, Dr. Tulk, Dr. Hilton, Mr. H. B. Preston, Mr. Steward, and Mr. C. Tyler.

The chief communications at the meetings are as follows:—

Jan.	“Notes on some Floridæ”	...	Mr. T. H. Buffham.
Mar.	“On <i>Rattulus collaris</i> ,” &c.	...	Mr. Rousselet.
„	“On Root-hairs”	... ..	Mr. E. B. Green.
Apr.	“On a Stridulating Organ in an Ant”		Mr. R. T. Lewis.
May.	“Note on two Aquatic Hymenoptera”		Mr. F. Enock.
„	“Note on certain discs on Stigmal	} ... ..	Mr. Nunney.
	vein of a Chalcid”		
„	“On Illuminating Objects with	} ... ..	Mr. Karop.
	Low Powers, &c.”		
„	“On correcting Camera Drawings”		Mr. Nelson.
Sept.	“On the Olfactory Setæ of	} ... ..	Mr. Scourfield.
	Cladocera”		
Nov.	“On a new <i>Cysticercus</i> and <i>Tænia</i> ”		Mr. Rosseter.
Dec.	“On Multiple Images in Mirrors”		Mr. W. Stokes.
„	“On a new Sub-stage Colour	} ... ..	Mr. Rheinberg.
	Illuminator”		

Besides these there were numerous exhibits of apparatus and discussions on various subjects, notices of which will be found in the Proceedings. Although it cannot be said that anything very startling or novel has been produced during the year, great interest evidently continues to be taken in the meetings, as shown by the high average attendance, viz., 62 on the ordinary and 34 on the conversational evenings.

Only a few specimens have been added to the Cabinet, the most noteworthy being the Rotifers presented by Mr. Rousselet and others. The value of the Tatem entomological collection is at present diminished by the want of a properly classified list of its contents, and the Committee will be much gratified if some member or members, having the requisite knowledge and leisure, will undertake to render this service to the Club. The Botanical and Lithological preparations have now been catalogued by the Curator and will shortly be printed.

The following is a list of books acquired by the Library by gift, purchase, or exchange.

"Sylloge Algarum." Vol. iii. ... ..	From the Author.
Braithwaite, Dr. R., "British Moss Flora." Part xvii. (commencing the Pleuro-carpous Mosses) ... ..	"
Murray's "Introduction to the Study of Sea Weeds" ... ..	Purchased.
Murray's "Phycological Memoirs." } Parts ii.-iii. ... ..	"
"Cambridge Natural History." Vol. ii.	
"Quarterly Journal of Microscopical Science" ... ..	"
"Annals and Magazine of Natural His- tory" ... ..	"
"Grevillea" ... ..	"
"Journal of the Royal Microscopical Society" ... ..	In exchange.
"Proceedings of the Royal Society" ...	"
"La Nuova Notarisia" ... ..	"
"Le Diatomiste" ... ..	"
"International Journal of Microscopy" ...	"
"American Monthly Microscopical Journal" ... ..	"



“The Microscope” ... ..	In exchange.
“American Botanical Gazette” ... ..	”
“Essex Naturalist” ... ..	”
“Proceedings of the Geologists’ Association” ... ..	} ”
Transactions and Proceedings of various Societies and sundry Pamphlets.	

The work of the Hon. Librarian is rendered more onerous as time goes on by the inexpansiveness of the shelf area at his disposal. The bookcases rented by the Club are perhaps sufficient for the ordinary literature in greatest demand, but the constant accession of periodical matters, mostly exchanges, a part only of which is germane to the special pursuit of the Club, will necessitate some revision and rejection in the near future unless additional storage space can be obtained. The matter will receive the careful attention of the Committee.

The Journal under the able editorship of Mr. Nelson has well maintained its useful character. Owing to certain difficulties its issue has been somewhat delayed, and it is found convenient to alter the date of publication in future from March and October to April and November.

The usual two-yearly list of members being due in 1897 it is essential that the Treasurer be advised of any change of address, as many Journals have been returned as “not known” or “gone away.”

The Committee has decided to hold a Special Exhibition Meeting in May. When the necessary arrangements are completed due notice will be sent to all members, and the Committee trust that no individual effort will be spared to render it a success and so maintain the prestige of the Club.

The financial position calls for no special mention beyond the figures given in the Balance-sheet. The amounts received for advertisements and sale of Journal are somewhat less than last year, but the difference is more than compensated by the diminished expenditure on the Journal. The balance in hand being larger than is required for current expenses, the Committee has considered it advisable to invest a further sum of £50.

Your Committee desire to thank the officers for their long continued and valuable services in their several departments.

Finally, and in view of the undoubted fact that microscopy as a recreative pursuit, apart from the special relations it has acquired with nearly every branch of science, is less popular than it was some twenty years ago; from the active interest manifestly shown at all the meetings, the good-fellowship which unites its members, and the careful way its affairs are administered, your Committee can only augur well of the future of the Club. It has met the requirements of a large class of earnest workers for thirty-one years, and may it long continue to flourish.

---

# QUEKETT MICROSCOPICAL CLUB.

*Treasurer's Statement of Accounts for the Year ending 31st December, 1896.*

Dr.	£	s.	d.	Cr.	£	s.	d.
To Balance from 1895	...	...	...	By Rent of Rooms and Bookcases	...	...	...
" Subscriptions received in 1896	170	3	6	" Expenses of Journal	...	...	...
" Dividends on Investments	...	...	...	" Postage	...	...	...
" Sale of Journals	...	...	...	" Printing and Stationery	...	...	...
" Sale of Catalogues	...	...	...	" Attendance	...	...	...
" Receipts for Advertisements	...	...	...	" Books, etc., purchased	...	...	...
	...	...	...	" Petty Expenses	...	...	...
	...	...	...	" Balance in hand	...	...	...
	21	18	6		...	...	...
	14	14	11		...	...	...
	5	6	4		...	...	...
	166	0	0		...	...	...
	170	3	6		...	...	...
	21	18	6		...	...	...
	14	14	11		...	...	...
	5	6	4		...	...	...
	166	0	0		...	...	...
	170	3	6		...	...	...
	21	18	6		...	...	...
	14	14	11		...	...	...
	5	6	4		...	...	...
	166	0	0		...	...	...
	170	3	6		...	...	...
	21	18	6		...	...	...
	14	14	11		...	...	...
	5	6	4		...	...	...
	166	0	0		...	...	...
	170	3	6		...	...	...
	21	18	6		...	...	...
	14	14	11		...	...	...
	5	6	4		...	...	...
	166	0	0		...	...	...
	170	3	6		...	...	...
	21	18	6		...	...	...
	14	14	11		...	...	...
	5	6	4		...	...	...
	166	0	0		...	...	...
	170	3	6		...	...	...
	21	18	6		...	...	...
	14	14	11		...	...	...
	5	6	4		...	...	...
	166	0	0		...	...	...
	170	3	6		...	...	...
	21	18	6		...	...	...
	14	14	11		...	...	...
	5	6	4		...	...	...
	166	0	0		...	...	...
	170	3	6		...	...	...
	21	18	6		...	...	...
	14	14	11		...	...	...
	5	6	4		...	...	...
	166	0	0		...	...	...
	170	3	6		...	...	...
	21	18	6		...	...	...
	14	14	11		...	...	...
	5	6	4		...	...	...
	166	0	0		...	...	...
	170	3	6		...	...	...
	21	18	6		...	...	...
	14	14	11		...	...	...
	5	6	4		...	...	...
	166	0	0		...	...	...
	170	3	6		...	...	...
	21	18	6		...	...	...
	14	14	11		...	...	...
	5	6	4		...	...	...
	166	0	0		...	...	...
	170	3	6		...	...	...
	21	18	6		...	...	...
	14	14	11		...	...	...
	5	6	4		...	...	...
	166	0	0		...	...	...
	170	3	6		...	...	...
	21	18	6		...	...	...
	14	14	11		...	...	...
	5	6	4		...	...	...
	166	0	0		...	...	...
	170	3	6		...	...	...
	21	18	6		...	...	...
	14	14	11		...	...	...
	5	6	4		...	...	...
	166	0	0		...	...	...
	170	3	6		...	...	...
	21	18	6		...	...	...
	14	14	11		...	...	...
	5	6	4		...	...	...
	166	0	0		...	...	...
	170	3	6		...	...	...
	21	18	6		...	...	...
	14	14	11		...	...	...
	5	6	4		...	...	...
	166	0	0		...	...	...
	170	3	6		...	...	...
	21	18	6		...	...	...
	14	14	11		...	...	...
	5	6	4		...	...	...
	166	0	0		...	...	...
	170	3	6		...	...	...
	21	18	6		...	...	...
	14	14	11		...	...	...
	5	6	4		...	...	...
	166	0	0		...	...	...
	170	3	6		...	...	...
	21	18	6		...	...	...
	14	14	11		...	...	...
	5	6	4		...	...	...
	166	0	0		...	...	...
	170	3	6		...	...	...
	21	18	6		...	...	...
	14	14	11		...	...	...
	5	6	4		...	...	...
	166	0	0		...	...	...
	170	3	6		...	...	...
	21	18	6		...	...	...
	14	14	11		...	...	...
	5	6	4		...	...	...
	166	0	0		...	...	...
	170	3	6		...	...	...
	21	18	6		...	...	...
	14	14	11		...	...	...
	5	6	4		...	...	...
	166	0	0		...	...	...
	170	3	6		...	...	...
	21	18	6		...	...	...
	14	14	11		...	...	...
	5	6	4		...	...	...
	166	0	0		...	...	...
	170	3	6		...	...	...
	21	18	6				

## Q.M.C. EXCURSIONS, 1896.

Reference Numbers,	Dates.	Localities.	Number of Members of the Q.M.C. attending.	Number of Members of other Societies attending.	Number of Visitors.	Totals.
1	March 28	Chingford ... ..	9			9
2	April 18	Royal Botanic Gardens ...	40	9	11	60
3	May 2	Esher... ..	18			18
4	„ 16	Totteridge ... ..	21			21
5	„ 30	Loughton (Goldings Hill) ...	16		3	19
6	June 13	Staines ... ..	5			5
7	„ 27	Hertford Heath ... ..	6			6
8	July 11	Oxshott ... ..	7		1	8
9	„ 25	Hanwell ... ..	8		1	9
10	Sept. 5	Whitstable ... ..	10		3	13
11	„ 19	Snaresbrook ... ..	10		1	11
12	Oct. 3	Keston ... ..	10	1	2	13

Names of members who sent lists of objects found by them:—

B. Burton, W.	R. Rousselet, C. F.
D. Dunning, C. G.	Sc. Scourfield, D. J.
Hm. Hembry, F. W.	S. Soar, C. D.
Ho. Holder, J. T.	So. Southon, W. H.
M. Measures, J. W.	T. Turner, C.
P. Parsons, F. A.	W. Western, Geo.
Pr. Priest, B. W.	

## LIST OF OBJECTS FOUND ON THE EXCURSIONS.

NOTE.—The numbers following the names of the objects indicate the excursions upon which they were found, and the letters indicate the names of the members recording the same. When an object is frequently recorded the letters are omitted.

CRYPTOGAMIA. *ALGÆ.*

Bryopsis plumosa . . . . .	. 10, Hm.
Characium ornithocephalum . . . . .	. 11, P.
Dictyosphærium Ehrenbergianum . . . . .	. 1, B.
Eudorina elegans . . . . .	. 3, P.
Gonium pectorale . . . . .	. 1, 2, 3, 4, 5, 7, 9, 11.
Nostoc commune . . . . .	. 8, T.
Oscillaria tenuis . . . . .	. 8, T.
Pandorina morum . . . . .	. 1, B., M.; 2, B.; 4, B., W.
Pediastrum Boryanum . . . . .	. 9, T.; 11, P.
Protococcus viridis . . . . .	. 2, B.
Scenedesmus quadricauda . . . . .	. 8, 9, T.; 11, P.
Spirulina Jenneri . . . . .	. 12, P.
Staurospermum viride (Kutz.) = Staurocarpus gracilis (Hass.) . . . . .	. 1, T.
Stephanosphæra pluvialis . . . . .	. 8, M.
Volvox aureus . . . . .	. 7, 11, 12, M.
„ globator . . . . .	. 1, 3, 4, 5, 7, 8, 11.

## DESMIDIACEÆ.

Closterium lunula . . . . .	. 1, 4, B. T.; 7, 8, T.; 9, B.; 11, B., T.
„ moniliferum . . . . .	. 11, B.
„ rostratum . . . . .	. 4, 7, T.
„ striolatum . . . . .	. 8, T.
Docidium baculum . . . . .	. 4, 11, T.

## DIATOMACEÆ.

Asterionella formosa . . . . .	. 5, B.
Synedra radians . . . . .	. 1, B.

*CHARACEÆ.*

Nitella flexilis . . . . .	. 11, B.
----------------------------	----------

## PROTOZOA.

Acineta mystacina . . . . .	. 2, P.
-----------------------------	---------

<i>Actinophrys sol</i>	. . . . .	2, M., T.; 9, T.; 11, P.; 12, M.
<i>Actinosphaerium Eichhorni</i>	. . . . .	1, P.; 2, B., M., T.; 6, 7, T.; 9, B., M.
<i>Amœba radiosa</i>	. . . . .	1, 8, M.
<i>Amphileptus flagellatus</i>	. . . . .	3, W.; 5, B.; 12, P.
<i>Anthophysa vegetans</i>	. . . . .	1, 11, P.
<i>Arcella dentata</i>	. . . . .	4, B.; 7, T.
„ <i>vulgaris</i>	. . . . .	4, B., W.; 7, 8, M.; 9, B., T.
<i>Aspidisca costata</i>	. . . . .	4, B., P.
<i>Bursaria truncatella</i>	. . . . .	1, B., T.; 4, B.; 12, T.
<i>Carchesium polypinum</i>	. . . . .	1, M.; 2, B.; 6, T.; 11, B.; 12, P.
<i>Centropyxis aculeata</i>	= <i>Arcella</i>	
<i>aculeata</i>	. . . . .	9, M., T.
<i>Ceratium furca</i>	. . . . .	10, P.
<i>Codonella</i> sp.	. . . . .	10, P.
<i>Coleps hirtus</i>	. . . . .	1, B., T.; 2, 3, P.; 5, B.; 8, T.
<i>Condylostoma stagnale</i>	. . . . .	1, B.; 2, B., T.; 3, T.; 4, B., T.; 9, T.; 11, B.
<i>Cothurnia imberbis</i>	. . . . .	2, B., T.; 4, 12, T.
<i>Didinium nasutum</i>	. . . . .	4, P.
<i>Diffugia acuminata</i>	. . . . .	1, 7, M.
„ <i>denticulata</i>	. . . . .	9, M.
„ <i>globulosa</i>	. . . . .	1, 2, 3, 7, 8, M.; 9, M., T.; 11, M.; 12, M., T.
„ <i>oblonga</i>	. . . . .	8, T.
„ <i>proteiformis</i>	. . . . .	4, 11, B.
„ <i>pyriformis</i>	. . . . .	12, T.
<i>Dinobryon sertularia</i>	. . . . .	1, B.; 2, 3, T.; 4, P.; 5, B.; 7, P.; 11, B.
<i>Epistylis anastatica</i>	. . . . .	9, M.
„ <i>flavicans</i>	. . . . .	2, B.
<i>Euglena viridis</i>	. . . . .	4, B.; 5, P.; 9, 11, B.
<i>Euglypha ciliata</i>	. . . . .	12, M.
<i>Euplotes charon</i>	. . . . .	4, W.
„ <i>patella</i>	. . . . .	2, B.; 4, 11, B.
<i>Gymnodinium fuscum</i>	= <i>Peridinium</i>	
<i>fuscum</i>	. . . . .	2, 5, B.

<i>Litonotus fasciola</i> = <i>Dileptus folium</i>	1, P.; 2, 4, B.
„ <i>Wrzesniowski</i>	. . . . . 1, P.
<i>Nassula ornata</i>	. . . . . 3, W.
<i>Noctiluca miliaris</i>	. . . . . 10, Hm.
<i>Ophrydium versatile</i>	. . . . . 6, P.
<i>Paramecium aurelia</i>	. . . . . 1, T.; 11, B.
<i>Peridinium tabulatum</i>	. . . . . 1, 2, P.; 4, W.; 6, 7, 11, P.
<i>Phacus longicaudus</i>	. . . . . 1, B.; 2, B., T.; 3, 11, P.
<i>Platycola decumbens</i>	. . . . . 4, P.
<i>Pleurotricha lanceolata</i> =	
<i>Stylonichia lanceolata</i>	. . . . . 4, B.
<i>Pyxicola Carteri</i>	. . . . . 2, P.
<i>Rhipidodendron Huxleyi</i>	. . . . . 1, 12, P.
<i>Spirostomum ambiguum</i>	. . . . . 1, B.; 2, T.; 4, B.; 7, 8, 11, T.; 12, P.
„ <i>teres</i>	. . . . . 3, W.
<i>Stentor caeruleus</i>	. . . . . 1, P.
„ <i>niger</i>	. . . . . 6, T.; 7, M.
„ <i>polymorphus</i> = <i>S. Mülleri</i>	. . . . . 1, 2, 4, 6, 7, 8, 11.
„ <i>Roeselli</i>	. . . . . 1, P.
<i>Stichotricha remex</i>	. . . . . 7, P.
„ <i>secunda</i>	. . . . . 11, P.; 12, T.
<i>Strombidium Claperedi</i>	. . . . . 5, P.
<i>Stylonichia mytilus</i>	. . . . . 4, W.; 11, T.
<i>Synura uvella</i>	. . . . . 1, 3, P.; 4, W.; 7, P.
<i>Thuricola valvata</i>	. . . . . 2, P.
<i>Tintinidium fluviatile</i>	. . . . . 3, P.
<i>Trachelius ovum</i>	. . . . . 1, 2, 8, 11, 12.
<i>Trachelocerca olor</i>	. . . . . 6, 12, T.
<i>Trichodina pediculus</i>	. . . . . 11, T.
<i>Urocentrum turbo</i>	. . . . . 6, 11, P.
<i>Uroleptus gibbus</i> = <i>Oxytricha</i>	
<i>gibba</i>	. . . . . 4, B.
<i>Uvella virescens</i>	. . . . . 2, 3, P.
<i>Vaginicola crystallina</i>	. . . . . 2, 4, 5, 6, 8, 11.
<i>Vorticella chlorostigma</i>	. . . . . 6, P.; 7, T.; 11, P.
„ <i>nebulifera</i>	. . . . . 2, 7, 8, M.; 11, B., M.
<i>Zoothamnium arbuscula</i>	. . . . . 2, B., T.; 4, B.; 9, T.

## PORIFERA.

Grantia ciliata . . . . .	10, D., Pr.
„ compressa . . . . .	10, D., Pr.
Halichondria panicea . . . . .	10, Pr.
Leucosolenia botryoides . . . . .	10, Pr.

CCELENTERATA. *HYDROZOA.*

Coryne pusilla . . . . .	10, D., Hm.
Hydra fusca . . . . .	8, 9, M.
„ viridis . . . . .	1, 2, 12, M.
„ vulgaris . . . . .	3, 11, M.
Limnocoedium Sowerbii, polyp stage.	2, B.
Plumularia pinnata . . . . .	10, Hm.
Tubularia indivisa . . . . .	10, P.

## ECHINODERMATA.

Ophiocoma rosula . . . . .	10, Pr.
Solaster papposa . . . . .	10, Hm., Pr.

VERMES. *ROTIFERA.*

Actinurus neptunius . . . . .	7, T.
Adineta vaga . . . . .	1, 8, T.
Anuræa aculeata . . . . .	1, 2, 3, 4, 5, 6, 7, 8, 9, 11, 12.
„ „ var. brevispina . . . . .	1, 3, 4, 7, 8, 11.
„ „ var. valga . . . . .	1, M.; 6, R.; 8, T.; 12, M., R.
„ cochlearis . . . . .	1, 2, 3, 4, 5, 7, 9, 12.
„ curvicornis . . . . .	3, 4, 7, 8, 9.
„ hypelasma . . . . .	4, R., W.; 9, M., R.
„ serrulata . . . . .	1, 3, 7, T.; 12, M.
„ tecta . . . . .	3, T.; 5, R., T.; 9, M., R., T.; 11, T.

Ascomorpha ecaudis = Sacculus viridis 4, 7, T.; 8, 12, M.

Asplanchna Brightwelli . . . . .	1, 2, 3, 5, 7, 9.
„ „ male . . . . .	2, M., T.; 3, M.
„ intermedia . . . . .	7, M., T.
„ „ male . . . . .	7, M., T.
„ priodonta . . . . .	2, 3, 5, 7, 12.

Asplanchnopus myrmeleo . . . . . 6, R.

Brachionus angularis . . . . . 1, 2, 3, 4, 5, 7, 9.



<i>Brachionus Bakeri</i>	. . . . .	. 2, 7, 8, 9, 11.
„ <i>pala</i>	. . . . .	. 1, 2, 3, 4, 5, 9, 11.
„ „ <i>var. amphiceros</i>	. . . . .	. 1, 2, 3, M.
„ <i>punctatus*</i> (Hempel)	. . . . .	. 9, M., R.
„ <i>quadratus</i>	. . . . .	. 2, R.; 4, B.
„ <i>rubens</i>	. . . . .	. 1, M.; 3, W.; 5, B.; 6, R., 7, T.
„ <i>ureolaris</i>	. . . . .	. 1, 2, 3, 4, 7, 9, 11, 12.
<i>Cathypna luna</i>	. . . . .	. 2, 4, 7, 8, 9.
„ <i>rusticula</i>	. . . . .	. 4, 6, R.; 9, M., R.
<i>Chromogaster testudo</i>	. . . . .	. 7, P.
<i>Cœlopus brachyurus</i>	. . . . .	. 3, W.; 4, R., W.
„ <i>porcellus</i>	. . . . .	. 1, B.; 4, T.
„ <i>tenuior</i>	. . . . .	. 5, R.
<i>Colurus bicuspidatus</i>	. . . . .	. 2, 7, 8, 9, T.; 12, P.
„ <i>caudatus</i>	. . . . .	. 11, B.
„ <i>deflexus</i>	. . . . .	. 1, P.
„ <i>leptus</i>	. . . . .	. 2, B.
<i>Conochilus unicornis</i>	. . . . .	. 5, B.; 12, M., P.
„ <i>volvox</i>	. . . . .	. 1, B., M., T.; 12, M., R., T.
<i>Copeus caudatus</i>	. . . . .	. 1, R., T.; 12, T.
„ <i>pachyurus</i>	. . . . .	. 1, R.; 8, M., T.; 12, R.
<i>Cyrtonia (Notommata) tuba</i>	. . . . .	. 6, P.
<i>Diaschiza exigua</i>	. . . . .	. 2, R.; 4, W.; 12, T.
„ <i>Hoodi</i>	. . . . .	. 1, R.
„ <i>pœta</i>	. . . . .	. 12, R.
„ <i>semi-aperta</i>	. . . . .	. 9, R.
<i>Diglena catellina</i>	. . . . .	. 2, R.
„ <i>forcipita</i>	. . . . .	. 2, M.; 4, 9, T.
„ <i>grandis</i>	. . . . .	. 4, W.; 9, M.
„ <i>rosa</i>	. . . . .	. 2, R.
<i>Dinocharis pocillum</i>	. . . . .	. 1, 4, 5, 6, 9.
„ <i>tetractis</i>	. . . . .	. 1, 3, 4, 6, 7, 8, 11.
<i>Distyla flexilis</i>	. . . . .	. 1, 2, P.
<i>Eosphora aurita</i>	. . . . .	. 1, M.; 4, B., W.; 8, M.
<i>Euchlanis deflexa</i>	. . . . .	. 1, M.; 2, B., M.; 3, So.
„ <i>dilatata</i>	. . . . .	. 1, 2, 3, 4, 6, 11, 12.

\* Described by Adolph Hempel in the "Bulletin of the Illinois State Laboratory of Natural History," Vol. iv., 1896, pp. 310-317.

<i>Euchlanis hyalina</i> (Leydig)*	. . . . .	6, R. ; 11, P.
„ <i>lyra</i>	. . . . .	2, T. ; 12, M., R., T.
„ <i>macrura</i>	. . . . .	3, P.
„ <i>oropha</i> = <i>E. parva</i>	. . . . .	3, M., R., W. ; 4, R., W. ; 6, R. ; 9, M., R. ; 12, P.
„ <i>pyriformis</i>	. . . . .	12, M.
„ <i>propatula</i> = <i>Diplois propatula</i> (Gosse) = <i>Euchlanis subversa</i> (Bryce)	. . . . .	12, M., R.
„ <i>triquetra</i> (Ehr.)	. . . . .	1, T. ; 3, So. ; 6, T. ; 7, M. ; 8, M., T. ; 11, B., M., T.
<i>Floscularia ambigua</i>	. . . . .	8, M. ; 11, P.
„ <i>campanulata</i>	. . . . .	2, B. ; 8, 11, T.
„ <i>cornuta</i>	. . . . .	1, M., T. ; 5, P. ; 8, M. ; 11, P.
„ <i>ornata</i>	. . . . .	2, 4, B., T. ; 8, M. ; 11, P.
<i>Furcularia æqualis</i>	. . . . .	4, P. ; 8, M.
„ <i>forficula</i>	. . . . .	1, M., R. ; 2, R., T. ; 6, 11, T.
„ <i>gracilis</i>	. . . . .	8, M.
„ <i>longisetata</i>	. . . . .	1, M., T. ; 7, P. ; 8, T.
„ „ <i>var. grandis</i> (Tessin-Butzow)	. . . . .	1, R. ; 7, P.
<i>Limnias annulatus</i>	. . . . .	2, M.
„ <i>ceratophylli</i>	. . . . .	2, B., R. ; 9, M.
„ <i>cornuella</i>	. . . . .	2, M.
<i>Mastigocerca bicornis</i>	. . . . .	1, M., R., T. ; 4, T. ; 5, B.
„ <i>bicristata</i>	. . . . .	6, R., T.
„ <i>carinata</i>	. . . . .	1, M. ; 3, So. ; 4, R., T., W. ; 5, 6, R. ; 9, T.
„ <i>elongata</i>	. . . . .	1, M.
„ <i>macera</i>	. . . . .	5, R.
„ <i>rattus</i>	. . . . .	1, 3, 4, 6, 8, 9, 12.
<i>Melicerta conifera</i>	. . . . .	4, W. ; 7, P. ; 11, B., M., T.
„ <i>janus</i>	. . . . .	11, M.
„ <i>ringens</i>	. . . . .	2, 4, 5, 6, 7, 9, 11.

\* This is figured and described in "Hudson and Gosse" as *E. triquetra* (Ehr.), but the mistake is noticed in the Supplement to that work, p. 39.

Metopidia acuminata . . . . .	1, R. ; 2, P. ; 12, R.
„ lepadella . . . . .	1, 2, 3, 4, 5, 6, 8, 9.
„ oxysternum . . . . .	6, T. ; 7, M. ; 9, T.
„ rhomboides . . . . .	7, T. ; 8, M.
„ solidus . . . . .	1, M. ; 2, P. ; 4, W. ; 5, R. ; 12, P.
Microcodides orbiculodiscus . . . . .	4, P. ; 7, 8, M. ; 12, M., R.
„ robustus . . . . .	12, R.
Monostyla bulla . . . . .	4, W. ; 8, T.
„ cornuta . . . . .	1, B. ; 4, R.
„ lunaris . . . . .	5, B. ; 8, 9, M. ; 12, P.
„ quadridentata . . . . .	9, R., T.
Noteus quadricornis . . . . .	6, T. ; 7, M. ; 9, M., R., T. ; 11, B., M. ; 12, P.
Notholca acuminata . . . . .	2, M., R., So., T. ; 3, So., T. ; 6, R.
„ labis . . . . .	5, T.
„ scapha . . . . .	1, B., R., T. ; 2, B., M., R., T. ; 3, R.
Notommata aurita . . . . .	2, M. ; 4, W. ; 5, B., R. ; 12, T.
„ lacinulata . . . . .	1, M. ; 2, T. ; 3, W. ; 4, T.
„ pilarius . . . . .	11, T.
„ saccigera . . . . .	12, R.
„ tripus . . . . .	1, R. ; 4, T. ; 11, P.
Notops brachionus . . . . .	1, 4, 7, 8, 11, 12.
„ hyptopus . . . . .	1, B., M., T. ; 6, R. ; 7, M., T. ; 12, M.
„ minor . . . . .	1, M., R. ; 7, 8, 12, M.
Ocistes crystallinus . . . . .	4, T. ; 7, M. ; 11, T.
„ intermedius . . . . .	2, T.
Pedalion mirum . . . . .	5, R., T. ; 7, M., T. ; 12, M., R.
Philodina aculeata . . . . .	6, P.
„ citrina . . . . .	2, T. ; 3, 4, W. ; 9, B. ; 12 P.
„ macrostyla . . . . .	1, P.
„ megalotrocha . . . . .	2, B., So., T. ; 4, P. ; 5, T.
Polyarthra aptera . . . . .	1, R.
„ platyptera . . . . .	1, 2, 3, 4, 5, 6, 7, 8, 9, 11, 12.

<i>Pompholyx complanata</i>	. . . . .	5, 9, R., T.
„ <i>sulcata</i>	. . . . .	1, M.; 5, B.; 11, T.; 12, M., R.
<i>Proales decipiens</i>	. . . . .	12, R.
„ <i>parasita</i>	. . . . .	4, T.; 5, B., R.
„ <i>petromyzon</i>	. . . . .	1, 2, R., T.; 5, R.
<i>Pterodina elliptica</i>	. . . . .	2, P.; 8, M.
„ <i>patina</i>	. . . . .	2, 4, 6, 7, 8, 9, 11.
<i>Rattulus bicornis</i> (Western)	. . . . .	12, R.
„ <i>tigris</i>	. . . . .	8, M.
<i>Rhinops vitrea</i>	. . . . .	1, M., R., T.; 3, Ho., M., R., So., T., W.; 4, B., T.
„ „ <i>male</i>	. . . . .	3, R., W.; 4, B.
<i>Rotifer citrinus</i>	. . . . .	4, B.; 6, P.
„ <i>macroceros</i>	. . . . .	8, M.; 11, P.
„ <i>maerurus</i>	. . . . .	2, 4, 7, 8, 9, 11, 12.
„ <i>tardus</i>	. . . . .	3, W.; 12, P.
„ <i>vulgaris</i>	. . . . .	1, P.; 3, W.; 4, 5, 11, B.
<i>Salpina brevispina</i>	. . . . .	3, So.; 4, W.; 6, R.; 9, M., R., T.; 11, B., M.
„ <i>macracantha</i>	. . . . .	4, R.; 9, M., R.
„ <i>marina</i>	. . . . .	4, P., R.
„ <i>mucronata</i>	. . . . .	2, 3, 4, 5, 6, 7, 8, 9, 12.
„ <i>mutica</i>	. . . . .	12, M.
„ <i>spinigera</i>	. . . . .	4, B.
„ <i>ventralis</i>	. . . . .	6, 8, 9, T.
<i>Scaridium longicaudum</i>	. . . . .	4, B., T., W.; 6, T.; 11, B.
<i>Stephanoceros Eichhorni</i>	. . . . .	4, B. T.; 11, B.
<i>Stephanops lamellaris</i>	. . . . .	4, R., W.; 6, T.
<i>Synchaeta gyrina</i>	. . . . .	3, M., R.
„ <i>longipes</i>	. . . . .	9, R.
„ <i>pectinata</i>	. . . . .	1, 2, 3, 4, 5, 6, 7, 9, 11, 12.
„ <i>stylata</i> (Wierzijski)	. . . . .	9, M, R.*
„ <i>tremula</i>	. . . . .	1, 2, 3, 4, 5, 6, 7, 11, 12.
<i>Taphrocampa annulosa</i>	. . . . .	1, 4, B.; 11, T.
„ <i>Saundersiae</i>	. . . . .	12, P., T.

\* *Synchaeta stylata*, new to Britain. Described by Dr. A. Wierzijski in "Rotatoria Galicyi," Cracow, 1893.

Triarthra breviseta . . . . .	1, B. ; 7, T.
.. longiseta . . . . .	1, 2, 3, 4, 5, 7, 9, 11, 12.
.. mystacina . . . . .	3, Ho., R., T., W. ; 4, R. T. ; 9, R.

Triphylus lacustris . . . . .	6, R. ; 8, T.
-------------------------------	---------------

### GASTROTRICHA.

Chætonotus larus . . . . .	4, B. ; 8, M., T. ; 9, 11, B.
.. maximus . . . . .	8, T.
Dasydytes goniathrix . . . . .	8, T. ; 12, P.

### PLATYHELMINTHES. TURBELLARIA.

Planaria lactea . . . . .	11, B.
Tetrastemma variegatum . . . . .	10, P.

### ANNELLIDA. OLIGOCHÆTA.

Nais proboscidea . . . . .	11, B.
----------------------------	--------

### ARTHROPODA. CRUSTACEA.

Caprella linearis . . . . .	10, P.
Microdeutopus anomalus ? . . . . .	10, P.
Pandalus annulicornis . . . . .	10, Hm.
Stenorhynchus tenuirostris . . . . .	10, P.

### ENTOMOSTRACA.

Acroperus harpæ . . . . .	4, 5	} Sc.
Alona affinis . . . . .	11	
.. costata . . . . .	11	} Sc.
.. guttata . . . . .	2, Sc. ; 4, 5, B. ; 11, Sc.	
.. intermedia . . . . .	11	} Sc.
.. quadrangularis . . . . .	2, 11	
Alonella nana . . . . .	2, 4	} Sc.
.. rostrata . . . . .	11	
Bosmina cornuta . . . . .	2, 11	} Sc.
.. longirostris . . . . .	2, B., Sc. ; 4, Sc. ; 5, 11, B.	
Camptocercus macrurus (rectirostris form) . . . . .	11	} Sc.
Candona candida . . . . .	3	
.. lactea, var. detecta . . . . .	3	} Sc.
Canthocamptus crassus . . . . .	2	
.. minutus (Claus) . . . . .	3	
.. pygmaeus . . . . .	3, 4, 11	

<i>Canthocamptus staphylinus</i> = <i>C. minutus</i> (Muller)	. 1, B.; 2, B., Sc.; 3, 4, Sc.; 5, B.; 11, Sc.	
„ <i>trispinosus</i>	. . . 3, 4, 5, Sc.	
<i>Ceriodaphnia megops</i>	. . . 5, Sc.	
„ <i>quadrangula</i>	. . . 4, Sc.	
„ <i>reticulata</i> = <i>Daphnia reticulata</i>	. . . 1, B.; 4, Sc.	
„ <i>rotunda</i>	. . . 11, Sc.	
<i>Chydorus cœlatus</i>	. . . 3, Sc.	
„ <i>sphericus</i>	. . . 2, 3, 4, Sc.; 5, B. Sc.; 11, B., Sc.	
<i>Cycloocypris serena</i> = <i>Cypria serena</i>	. 2, 3, 4, 11	} Sc.
<i>Cyclops affinis</i>	. . . 11	
„ <i>albidus</i> = <i>C. tenuicornis</i>	. 2, 3, 4, 5	
„ <i>bicuspidatus</i>	. . . 2, 4, 11	
„ <i>bisetosus</i>	. . . 11	
„ <i>Dybowskii</i> *	. . . 4	
„ <i>fimbriatus</i>	. . . 11	
„ <i>fuscus</i> = <i>C. signatus</i>	. . . 4, 5, 11	
„ <i>Leuckarti</i>	. . . 2, 3, 4, 5	
„ <i>phaleratus</i>	. . . 4, 5, 11	
„ <i>serrulatus</i>	. . . 2, 3, 4, 5, 11	
„ <i>strenuus</i>	. . . 2, 3, 4, 11	
„ „ <i>vicinus</i> form	. . . 2, 3, 4	
„ <i>vernalis</i>	. . . 2, 3, 11	
„ <i>viridis</i> , var. <i>brevicornis</i>	. 3, 11	
„ „ „ <i>gigas</i>	. . . 2, 3, 4, 11	
<i>Cypria ophthalmica</i>	. . . 2, 3, 11	
<i>Cypris fuscata</i>	. . . 4, 11	
„ <i>pubera</i>	. . . 3	
„ <i>virens</i> = <i>C. tristriata</i>	. . . 1, B.; 3, Sc.; 4, B.; 11, Sc.	
<i>Daphnella brachyura</i> = <i>D. Wingi</i>	. 1, B.	
„ „ <i>Brandtiana</i> , form 5		} Sc.
<i>Daphnia cucullata</i>	. . . 11	
„ <i>longispina</i>	. . . 3	
„ <i>obtusa</i>	. . . 11	

\* New to Britain.

<i>Daphnia pulex</i> . . . . .	. 3, Sc. ; 4, B., Sc. ; 11, Sc.
"    "    var. <i>Schoedleri</i> ? . . . . .	. 4, Sc.
"    " <i>Schæfferi</i> . . . . .	. 3, Sc. ; 4, B., Sc.
<i>Diaptomus castor</i> . . . . .	. 3, 11, Sc.
" <i>gracilis</i> . . . . .	. 2, 3, 4, 5, 11, Sc.
<i>Eurycercus lamellatus</i> . . . . .	. 1, 4, B. ; 5, B. Sc. ; 11, B.
<i>Graptoleberis testudinaria</i> . . . . .	. 4, 5, Sc.
<i>Ilyocryptus sordidus</i> . . . . .	. 2, B. ; 3, 4, Sc. ; 5, B. ; 11, Sc

<i>Ilyocypris gibba</i> . . . . .	. 11	} Sc.
<i>Leydigia quadrangularis</i> = <i>L. acanthocercoides</i> of previous lists . . . . .	. 3, 4, 11	
<i>Limnocythere inopinata</i> . . . . .	. 3, 11	
<i>Macrothrix laticornis</i> . . . . .	. 2, 3, 5	
<i>Monospilus tenuirostris</i> . . . . .	. 11	
<i>Nitocra hibernica</i> . . . . .	. 11	
<i>Peracantha truncata</i> . . . . .	. 4, 11	
<i>Pionocypris vidua</i> = <i>Cypridopsis vidua</i> . . . . .	. 4, 5, 11	
<i>Pleuroxus uncinatus</i> . . . . .	. 11	
<i>Simocephalus exspinosus</i> . . . . .	. 4, 11	
" <i>vetulus</i> . . . . .	. 3, 4, 5, 11	

## CIRRIPELIA.

<i>Balanus balanoides</i> . . . . .	. 10, Hm.
"    "    larvæ of . . . . .	. 10, P.

## ARACHNIDA. Acarina.

## HYDRACHNIDE.

<i>Arrenurus caudatus</i> (De Geer) . . . . .	. 4, 7, 8, 9, 11	} S.*
" <i>globator</i> (Müller) . . . . .	. 3, 4, 5, 6, 7, 8, 9	
" <i>maculator</i> (Müller) . . . . .	. 8	
" <i>sinuator</i> (Müller) . . . . .	. 12	
<i>Atax crassipes</i> (Müller) . . . . .	. 11	
" <i>simulans</i> (Koenike) . . . . .	. 4, 6, 7	
<i>Axona versicolor</i> (Müller) . . . . .	. 7, 12	
<i>Bradybates truncatus</i> (Neuman) . . . . .	. 1	
<i>Diplodontus despiciens</i> (Müller) . . . . .	. 4, 5, 9	

\* Erratum in the list of Hydrachnidae published last year, "Journ. Q.M.C." Vol. vi., No. 38, p. 253, for So, read S.

<i>Eylais extendens</i> (Müller)	. . . 4, 5, 6
<i>Hydrachna globosa</i> (De Geer)	. . . 4, 6
<i>Hydrochoreutes cruciger</i> (Koch)	. . . 5
<i>Hydrodroma rubra</i> (De Geer)	. . . 4, 5, 6
<i>Hygrobates hemisphaericus</i> (Koch)	. . . 6
,, <i>rotundatus</i> (Koch)	. . . 12
<i>Limnesia fenestrata</i> (Koch)	. . . 12
,, <i>fulgida</i> (Koch)	. . . 5
,, <i>maculata</i> (Müller)	. . . 4
<i>Marica musculus</i> (Müller)	. . . 4
<i>Nesæa carnea</i> (Koch)	. . . 6
,, <i>decorator</i> (Neuman) var. I.,	
red . . . . .	. . . 8
,,    ,,    (Neuman) .. II.,	
blue . . . . .	. . . 9
,, <i>pulchra</i> (Koch)	. . . 3, 4, 5, 6, 11
,, <i>punctata</i> (Neuman)	. . . 5, 7
<i>Piona affinis</i> (Koch)	. . . 4
,, <i>fasciata</i> (Koch)	. . . 3
,, <i>ovata</i> (Koch)	. . . 4, 5
<i>Thyas venusta</i> (Koch)	. . . 8

} S.

## ARCTISCONIDE.

*Macrobiotus Hufelandi* . . . . . 1, 11, P.

## INSECTA.

## COLEOPTERA.

*Acilius sulcatus*, larva of . . . . . 4, B.*Dytiscus marginalis*, larva of . . . . . 4, B.

## HYMENOPTERA.

*Prestwichia aquatica* . . . . . 5, Sc.

## DIPTERA.

*Corethra plumicornis*, larva of . . . . . 4, 5, B.*Culex pipiens*, larva of . . . . . 4, B.

## HEMIPTERA.

*Notonecta glauca* . . . . . 4, B.

## NEUROPTERA.

*Ephemera vulgata*, larva of . . . . . 4, B.



MOLLUSCOIDA. *POLYZOIA*.

<i>Alcyonidium gelatinosum</i> . . . . .	. 10, Pr.
<i>Amathia leudigera</i> = <i>Serialaria</i> l. . . . .	. 10, D., Hm., Pr.
<i>Bicellaria ciliata</i> = <i>Cellularia</i> c. . . . .	. 10, D., Pr.
<i>Bowerbankia imbricata</i> . . . . .	. 10, Pr.
,, <i>pustulosa</i> ? . . . . .	. 10, D.
<i>Crisia cornuta</i> . . . . .	} 10, Pr.
,, <i>denticulata</i> . . . . .	
,, <i>eburnea</i> . . . . .	
<i>Fredericella sultana</i> . . . . .	. 2, B. T. ; 11, M.
<i>Membranipora pilosa</i> , var. <i>dentata</i> . . . . .	. 10, P.
<i>Paludicella Ehrenbergi</i> . . . . .	. 2, P.
<i>Pedicellaria cernua</i> . . . . .	. 10, D.
<i>Plumatella repens</i> . . . . .	. 2, B., M., T. ; 11, M.

MOLLUSCA. *TUNICATA*.

<i>Botryllus violaceus</i> . . . . .	. 10, Pr.
<i>Cynthia grossularia</i> . . . . .	. 10, Hm.

FREDK. A. PARSONS,  
Hon. Sec. Excursions Sub-Committee.

---

## NOTICES OF RECENT BOOKS.

A TEXT BOOK OF HISTOLOGY. By Arthur Clarkson, M.B.Edin. Pp. 554, and 174 original coloured illustrations. Bristol: J. Wright and Co. Price 21s. net.

Although probably but few of our members require an elaborate treatise on Human Histology, it might, on occasion, be desirable to know of a work to consult in a difficulty, that is both authoritative as to matter and at the same time well illustrated. Such a work, undoubtedly, is Dr. Clarkson's text-book. In it will be found a full account of the latest, well-authenticated discoveries in the microscopic anatomy of the human body, and a very complete description of the preliminary processes necessary for making either temporary or permanent microscopical preparations of the various tissues. The coloured illustrations form a prominent feature of the book, and although perhaps in a few cases somewhat diagrammatic, it must be conceded that for the most part they show extremely well the principal features visible in successfully stained histological specimens. From all points it is an excellent work, and creditable alike to author and publisher.

LIFE IN PONDS AND STREAMS. By W. Furneaux, F.R.G.S. Pp. 406, with plates and numerous illustrations. London: Longmans and Co. Price 12s. 6d.

This, like previous works by the same author, is mainly intended for the use of juvenile naturalists, and a better book on the lines it covers could not be put in such hands. It is divided into two parts; the first, dealing with the work of the collector, viz., methods, implements, preservation of specimens, management of fresh-water aquaria, and so on; the second with the natural history of animals inhabiting ponds and streams, during either the whole or part of their lives. It is well and brightly written, and forms with its 300 or more excellent illustrations, including eight coloured plates, a concise encyclopædia of animate pond-life. By a curious oversight a common triple pocket magnifier is called a "Coddington" lens, and the definition of Arthropods is only partly correct; otherwise, errors appear but few and unimportant.

OFFICERS AND COMMITTEE.  
(Elected February, 1897.)

---

President.

J. G. WALLER, F.S.A.

Vice-Presidents.

REV. W. H. DALLINGER, LL.D., F.R.S., F.R.M.S., &c.

A. D. MICHAEL, F.R.M.S., F.L.S., &c.

E. T. NEWTON, F.R.S., F.G.S.

E. DADSWELL, F.R.M.S.

Committee.

H MORLAND.

D. BRYCE.

F. A. PARSONS.

F. W. HEMBRY, C.C., F.R.M.S.

J. E. INGPEN, F.R.M.S.

D. J. SCOURFIELD.

G. WESTERN, F.R.M.S.

The Hon. Sir FORD NORTH,  
F.R.M.S.

J. F. TATHAM, M.A., M.D.,  
F.R.M.S.

G. MAINLAND, F.R.M.S.

C. TURNER.

J. SLADE, F.G.S.

Hon. Treasurer.

J. J. VEZEY, F.R.M.S., 21, Mincing Lane, E.C.

Hon. Secretary.

G. C. KAROP, M.R.C.S., F.R.M.S., 198, Holland Road, Kensington, W.

Hon. Sec. for Foreign Correspondence.

C. F. ROUSSELET, F.R.M.S., 27, Great Castle Street Regent Street, W.

Hon. Reporter.

R. T. LEWIS, F.R.M.S., 4, Lyndhurst Villas, The Park, Ealing, W.

Hon. Librarian.

ALPHEUS SMITH,  
14, Leigham Vale, Streatham, S.W.

Hon. Curator.

E. T. BROWNE, B.A., F.R.M.S.  
141, Uxbridge Road, W.

Hon. Editor.

E. M. NELSON, P.R.M.S., 66, West End Lane, N.W.

## P A S T P R E S I D E N T S .



	Elected.
*EDWIN LANKESTER, M.D., F.R.S. - -	July, 1865.
ERNEST HART- - - - -	,, 1866.
*ARTHUR E. DURHAM, F.R.C.S., F.L.S., &c. ,,	1867-8.
*PETER LE NEVE FOSTER, M.A. - -	,, 1869.
LIONEL S. BEALE, M.B., F.R.S., &c. -	,, 1870-1.
ROBERT BRAITHWAITE, M.D., F.L.S., &c. ,,	1872-3.
*JOHN MATTHEWS, M.D., F.R.M.S. - -	,, 1874-5.
*HENRY LEE, F.L.S., F.G.S., F.R.M.S., F.Z.S. ,,	1876-7.
*THOS. H. HUXLEY, LL.D., F.R.S., &c. -	,, 1878.
*T. SPENCER COBBOLD, M.D., F.R.S., F.L.S., &c.	1879.
T. CHARTERS WHITE, M.R.C.S., L.D.S., F.R.M.S.	1880-1.
M. C. COOKE, M.A., LL.D., A.L.S. - -	,, 1882-3.
*W. B. CARPENTER, C.B., F.R.S., &c., &c. -	,, 1884.
A. D. MICHAEL, F.L.S., F.R.M.S., &c. -	,, 1885-6-7.
B. T. LOWNE, F.R.C.S., F.L.S., &c. - -	Feb., 1888-9.
REV. W. H. DALLINGER, LL.D., F.R.S.,	
F.R.M.S., &c., &c. - - -	,, 1890-1-2.
EDWARD MILLES NELSON, F.R.M.S. -	,, 1893-4-5.
J. G. WALLER, F.S.A. - - -	,, 1896-7.

\* Deceased.

## HONORARY MEMBERS.



- Date of Election.
- Jan. 24, 1868. Arthur Mead Edwards, M.D., 11, Washington street, Newark, New Jersey, U.S.A.
- Mar. 19, 1869. The Rev. E. C. Bolles, Salem, Mass., U.S.A.
- July 26, 1872. Professor Hamilton L. Smith, Hon. F.R.M.S., President of Hobart College, Geneva, New York, U.S.A.
- July 23, 1875. Lionel S. Beale, M.B., F.R.S., F.R.M.S., &c. (*Past President*), 61, Lower Grosvenor street, W.
- July 25, 1879. Dr. E. Abbe, Hon.F.R.M.S., Jena, Saxe Weimar, Germany.
- July 23, 1880. F. H. Wenham, C.E., 112, New Bond street, W.
- Nov. 24, 1882. Dr. Veit B. Wittrock, Professor at the Royal Academy of Sciences, and Director of the Museum of Natural History, Stockholm, Sweden.
- Feb. 17, 1893. Robert Braithwaite, M.D., F.L.S., F.R.M.S. (*Past President*), The Ferns, 303, Clapham road, S.W.
- Feb. 17, 1893. M. C. Cooke, M.A., LL.D., A.L.S. (*Past President*), 146, Junction road, Upper Holloway, N.
- Feb. 17, 1893. T. Charters White, M.R.C.S., L.D.S., F.R.M.S. (*Past President*), 26, Belgrave road, S.W.
- Mar. 19, 1897. B. T. Lowne, M.D., F.R.C.S., F.L.S., etc., The Cedars, Crondall, near Farnham, Surrey.

## LIST OF MEMBERS.

---

- Date of Election.
- Feb. 20, 1891. Addis, W., 44, Herbert street, New North road,  
N.
- April 18, 1890. Allen, J. M., F.R.M.S., 11, Gray's Inn square,  
W.C.
- Dec. 22, 1865. Andrew, F. W., 57, Weston Park, Crouch  
End, N.
- Feb. 22, 1889. Ashe, A., Roman villa, Laurie square, Romford,  
Essex.
- Jan. 18, 1895. Awde, George Edward, 32, Queen's terrace,  
Southampton.
- Dec. 27, 1867. Bailey, J. W., 75, Broke road, Dalston, E.
- Sept. 28, 1877. Baker, F. W. W., F.R.M.S., 313, High Holborn  
W.C.
- April 22, 1870. Barnes, C. B., Florencedale, Selhurst road, South  
Norwood, S.E., and 27, Clement's lane, E.C.
- Oct. 20, 1893. Barnes, John W., The Willows, Harold Wood,  
Essex.
- Mar. 19, 1897. Barnes, W., 41, Frederick street, Gray's Inn  
Road, W.C.
- May 25, 1883. Barratt, Thomas J., Bell Moor house, Upper  
Heath, Hampstead, N.W.
- Sept. 27, 1872. Bartlett, Edward, L.D.S., M.R.C.S.E., 38, Con-  
naught square, W.
- June 17, 1892. Bates, C., 94, Rectory road, Stoke Newington, N.
- June 19, 1891. Bates, W., 98, Wickham road, Brockley, S.E.
- Oct. 18, 1895. Baugh, J. H. A., 63, Cambridge Road, Hammer-  
smith, W.
- Jan. 16, 1891. Baxter, W. E., F.R.M.S., 170, Church street,  
Stoke Newington, N.
- June 19, 1891. Baxter, F. W., 170, Church street, Stoke  
Newington, N.

<u>Date of Election.</u>	
Nov. 26, 1875.	Beulah, John, Raventhorpe, Brigg.
July 25, 1884.	Beck, C., F.R.M.S., 68, Cornhill, E.C.
June 19, 1891.	Beck, Horace C., 233, Albion road, Stoke Newington, N.
Mar. 28, 1884.	Beetham, A., The Warren Lodge, Old Shirley, Southampton.
Oct., 23, 1868.	Bevington, W. A., F.R.M.S., "Avondale," Coleraine road, Blackheath, S.E.
Mar. 16, 1894.	Bird, Archibald, W., 26, Chancer road, Herne Hill, S.E.
July 27, 1877.	Blenkinsop, B., Shord hill, Kenley, Surrey.
Nov. 23, 1883.	Bostock, E., F.R.M.S., "The Radfords," Stone, Staffordshire.
Oct. 20, 1893.	Boyes, William Benjamin, P.O. Box 34, Johannesburg, S.A.R.
Feb. 19, 1892.	Brooke, W. R., Norbury house, 37, Fountayne road, Clapton, N.
Oct. 18, 1895.	Bros, W. L., Camera Club, Charing Cross, W.C.
Dec. 19, 1890.	Brough, J. R., 29, Alexandra villas, Finsbury park, N.
May 22, 1868.	Brown, W. J., 17, Maple road, Anerley, S.E.
Jan. 28, 1887.	Browne, E. T., B.A., F.R.M.S. ( <i>Hon. Curator</i> ), 141, Uxbridge road, W.
Jan. 15, 1892.	Bryce, D., 37, Brooke road, Stoke Newington Common, N.
Aug. 22, 1879.	Burton, William, 21, Manor gardens, Upper Holloway, N.
June 14, 1865.	Bywater, W. M., F.R.M.S., 5, Hanover square, W.
May 26, 1882.	Chapman, W. Ingram, 24, Dalebury road, Upper Tooting, S.W.
June 17, 1892.	Chaloner, G., F.C.S., 30, Weston Park, Crouch End, N.
Dec. 18, 1896.	Chamberlin, H. B., 4, Queen Victoria street, E.C.
Dec. 27, 1878.	Chatto, Andrew, 214, Piccadilly, W.
Feb. 15, 1895.	Cheese, Herbert F., 58, Cornwall Gardens, S.W.
Mar. 22, 1878.	Chester, The Very Rev. the Dean of, The Deanery, Chester.

## Date of Election.

- Dec. 18, 1891. Cheyne, A. M., 16, Coleman street, E.C.
- Nov. 27, 1874. Chippendale, George, 104, Hoe street, Walthamstow, N.
- Dec. 18, 1896. Chipps, F. W., 201, Castelnau, Barnes, S.W.
- Dec. 27, 1881. Claremont, Claude Clarke, M.R.C.S., Millbrooke house, Hampstead road, N.W.
- June 19, 1896. Clark, Latimer, F.R.S., 31, The Grove, Boltons, South Kensington, S.W.
- Dec. 21, 1894. Coles, Ferdinand, 53, Brooke road, Stoke Newington Common, N.
- Dec. 18, 1891. Collins, H. S., 31, Endymion road, Brixton Hill, S.W.
- May 28, 1869. Cottam, Arthur, F.R.A.S., H.M. Office of Woods, 1, Whitehall place, S.W.
- Aug. 28, 1868. Crisp, Frank, LL.B., B.A., F.R.M.S., *V.P. and Treas. Linnean Society*; 5, Lansdowne road, Notting hill, W.
- Feb. 23, 1877. Crofton, Edward, M.A. Oxon., F.R.M.S., 45, West Cromwell road, Earl's Court, S.W.
- May 15, 1891. Croger, T. R., 8, Marquess road, Canonbury, N.
- Mar. 16, 1894. Culshaw, Rev. George H., M.A., Eblana, Village road, Enfield.
- June 25, 1880. Curties, C. Lees, 244, High Holborn, W.C.
- May 25, 1866. Curties, Thomas, F.R.M.S., 244, High Holborn, W.C.
- May 15, 1896. Dadd, John W., 1, St. Paul's villas, Waldenshaw road, Forest hill, S.E.
- Jan. 22, 1875. Dadswell, E., F.R.M.S. (*Vice-President*), 313, Clapham road, S.W.
- Feb. 23, 1883. DALLINGER, Rev. W. H., LL.D., F.R.S., F.R.M.S., &c. (*Past President*), Ingleside, Newstead road, Lee, S.E.
- Mar. 18, 1892. Daniell, J. A., 23, Queen Victoria street, E.C.
- May 22, 1878. Darke, Edward, 16, Rochester terrace, Camden road, N.W.
- Mar. 15, 1895. Daunou, F., 1, Shirley villas, Westbrook, Margate.
- Nov. 23, 1888. Davis, H. R., Thistleton house, 1, Clissold road, Stoke Newington.



## Date of Election.

- Feb. 15, 1895. Davis, T. Sebastian, 199, South Lambeth road, S.W.
- May 23, 1879. Dawson, W., F.R.M.S., Mustow house, Bury St. Edmunds, Suffolk.
- May 28, 1875. Dean, Arthur (*Hon. Sec. East Lond. Mic. Soc.*), 69, Lauriston road, South Hackney, E.
- April 19, 1895. Delcomyn, Theo. A., Feldheim, Wimbledon common.
- Feb. 19, 1897. Dendy, W., Hornchurch, Essex.
- Nov. 17, 1893. Dennis, A. W., 48, Mansfield street, N.E.
- Mar. 22, 1889. Dick, J., 39, Lowman road, Holloway, N.
- Jan. 20, 1893. Dineen, George Peter, 62, Strode road, Willesden Green, N.W.
- June 17, 1892. Dixon-Nuttall, F. R., F.R.M.S., Ingleholme, Eccleston park, near Prescott, Lancashire.
- May 25, 1883. Drake, C. A., The Distillery, Three Mill lane, Bromley-by-Bow.
- Oct. 25, 1872. Dunning, C. G., 55, Camden park road, N.W.
- June 19, 1891. Earland, Arthur, 10, Glenwood road, Catford, S.E.
- Jan. 15, 1897. East, Edwin T., 15, Westover road, Wandsworth common, S.W.
- Sept. 25, 1868. Eddy, J. R., F.R.M.S., F.G.S., The Grange, Carleton, Skipton, Yorkshire.
- May 26, 1876. Emery, Charles, 10, Barrington road, Crouch end, N.
- April 17, 1896. Enock, F., F.L.S., F.E.S., 21, Manor Gardens, Holloway, N.
- Feb. 28, 1879. Epps, Hahnemann, 95, Upper Tulse hill, Brixton, S.W.
- Feb. 21, 1884. Epps, J., jun., Norfolk house, Beulah hill, Upper Norwood, S.E.
- May 18, 1894. Evans, John Henry, 71, Lambton road, Cottenham park, Wimbledon.
- July 25, 1873. Fase, Rev. H. J., M.A., Broadview, Beachcroft road, Upper Tooting, S.W.
- Aug. 25, 1882. Field, W. H., St. Helier's, Avenue road, Highgate, N.

## Date of Election.

- June 16, 1898. Filer, Frank E., 58, Southwark Bridge road, S.E.
- June 17, 1892. Finlayson, D., 97, High Holborn, W.C.
- July 26, 1867. Fitch, Frederick, F.R.G.S., F.R.M.S., Hadleigh house, Highbury New park, N.
- Mar. 20, 1896. Fletcher, S. W., M.D., Pepperill, Massachusetts, U.S.A.
- Nov. 23, 1888. Flood, W. C., 55, Aubert park, Highbury, N.
- June 23, 1871. Freeman, H. E., 104, Shaftesbury road, Crouch hill, N.
- Dec. 20, 1895. Fullicks, W. C., 18, North street, Wandsworth, S.W.
- Mar. 20, 1896. Galsworthy, Laurence, 26, Sussex place, Regent's Park, N.W.
- July 26, 1867. George, Edward, F.R.M.S., Vernon house, Westward park, Forest hill, S.E.
- April 17, 1891. Gladstone, C. E., Commander R.N., H.M.S. "Fearless," Mediterranean.
- Jan. 15, 1892. Goffi, G., Carlyle, The Grove, Earlsfield, S.W.
- April 26, 1872. Goodinge, J. W., F.R.G.S., F.R.M.S., 10, Gower street, Bedford square, W.
- Nov. 23, 1877. Goodwin, William, 65, Calverley Grove, Upper Holloway, N.
- Aug. 24, 1885. Greenhough, D. W., 12, Brandram road, Lee, S.E.
- Oct. 23, 1868. Greenish, Thomas, F.R.M.S., 20, New street, Dorset square, N.W.
- Jan. 28, 1887. Grove, E., F.R.M.S., Norlington, Preston, Brighton.
- May 17, 1895. Groves, H., F.L.S., 41, Union road, Clapham Rise, S.W.
- July 24, 1868. Groves, Prof. J. W., F.R.M.S., Wargrave Lodge, Wargrave-on-Thames.
- July 24, 1868. Grubbe, E. W., C.E., 5, Chepstow place, Bayswater, W.
- Jan. 27, 1871. Guimaraens, A. de Souza, F.R.M.S., 2, Florence villas, Milton road, Herne hill, S.E.
- Feb. 3, 1867. Hainworth, William, 105, Darenth road, Stamford hill, N.

## Date of Election.

- Sept. 28, 1888. Hall, T. F., 39, Gloucester square, Hyde Park, W.
- Dec. 28, 1866. Hallett, R. J., 5, Churchill road, Brighton road, South Croydon.
- Feb. 22, 1869. Hammond, A., F.L.S., 30, Versailles road, Anerley, S.E.
- Oct. 22, 1886. Hampton, W., 38, Lichfield street, Hanley, Staffordshire.
- Jan. 23, 1874. Hardy, J. D., 73, Clarence road, Clapton, E., and 4, Lombard street, E.C.
- Sept. 28, 1866. Harkness, W., F.R.M.S., Laboratory, Somerset house, W.C.
- Feb. 15, 1895. Harris, George T., 33, Lindore road, New Wandsworth, S.W.
- Jan. 18, 1895. Harrison, A., F.R.M.S., 72, Windsor road, Forest Gate, E.
- April 23, 1875. Harrison, James, 95, Beechdale road, Brixton hill, S.W.
- April 17, 1896. Haskew, Selwyn, Hale End, Chingford, Essex.
- Mar. 28, 1879. Hawkins, C. E., 28, Jermyn street, S.W.
- June 28, 1867. Hawksley, T. P., 11, Primrose Hill road, N.W.
- Aug. 23, 1872. Hembry, F. W., C.C., F.R.M.S., Langford, Sidcup, Kent.
- Feb. 26, 1886. Hewlett, R. T., 36, Battersea Rise, Clapham Common, S.W.
- April 25, 1884. Higgins, J., London University, Burlington gardens, W.
- Nov. 17, 1893. Hill, Edwin Ernest, 3, Trevor Villas, Horn lane, Woodford.
- Nov. 15, 1895. Hilton, A. E., 14, Tremlett Grove, Junction road, N.
- May 22, 1874. Hind, George, 244, High Holborn, W.C.
- Jan. 18, 1895. Hinton, E., 12, Vorley road, Upper Holloway, N.
- Jan. 15, 1892. Hogan, H. L., The Parade, Epsom.
- Dec. 15, 1893. Holder, J. T., 77, Erlanger road, St. Catherine's Park, S.E.
- Feb. 26, 1875. Holford, Christopher, Preston house, Surbiton.

## Date of Election.

- Nov. 26, 1880. Hopkins, Robert, Shearn villa, Walthamstow, Essex.
- Oct. 26, 1866. Horncastle, Henry, "Lindisaye," Woodham road, Woking.
- April 21, 1893. Hornsby, E. W., jun., Branscombe, Putney, S.W.
- June 17, 1892. Hoskins, A. B., A.M.Inst.C.E., 7, Northbrook road, Lee, S.E.
- May 22, 1874. Hovenden, C. W., F.R.M.S., Chester house, Mount Ephraim road, Streatham, S.W.
- April 26, 1867. Hovenden, Frederick, F.R.M.S., Glenlea, Thurlow park road, Dulwich, S.E.
- Oct. 19, 1894. Howard, R. N., M.R.C.S., F.R.M.S., The Cape Copper Co., Port Nolloth, Namaqualand, Cape Colony, South Africa.
- Oct. 19, 1894. Hughes, F., 28, Threadneedle street, E.C.
- May 28, 1886. Hughes, W., 32, Heathland road, Stoke Newington, N.
- July 25, 1873. Hurst, J. T., 1, Raymond villas, Geraldine road, Wandsworth, S.W.
- May 24, 1867. Ingpen, J. E., F.R.M.S., 7, The Hill, Putney, S.W.
- Mar. 19, 1897. Isenberg, A. L., 26, Lower Sloane street, S.W.
- Aug. 25, 1882. Jakeman, Christopher, Bouldner Lodge, Lewisham hill, S.E.
- June 14, 1865. Jaques, Edward, B.A., 28, Ashley road, Crouch hill, N.
- Nov. 23, 1888. Jefferys, T. G., 11, Edith road, St. Mary's road, Peckham, S.E.
- Oct. 26, 1888. Jenkins, A. J., 6, Douglas terrace, Douglas street, Deptford, S.E.
- Sept. 18, 1891. Johnson, W., F.R.M.S., 188, Tottenham Court road, W.C.
- May 23, 1873. Karop, G. C., M.R.C.S., F.R.M.S., etc. (*Hon. Secretary*), 198, Holland road, Kensington, W.
- July 25, 1884. Kern, J. J., Fern Glen, Selhurst park, South Norwood, S.E.

## Date of Election.

- Feb. 20, 1891. King, H. W., Stanford, Muswell avenue, Muswell hill, N.
- Feb. 28, 1873. Kitsell, F. J., 24, St. Stephen's avenue, Goldhawk road, Shepherd's Bush, W.
- Mar. 22, 1889. Klein, S. T., F.R.A.S., F.L.S., F.R.M.S., The Red House, Stanmore.
- Dec. 15, 1893. Lampson, Sir George, Bart., Albert House, Albert Gate, S.W.
- May 28, 1875. Larkin, J., Delrow, Aldenham, near Watford.
- Feb. 24, 1888. Lathangue, R., 83, Cranwich road, Stamford hill, N.
- June 25, 1869. Layton, C. E., 17, Cornwall terrace, Regent's Park, N.W.
- Aug. 28, 1868. Leaf, C. J., F.L.S., F.R.M.S., etc., Beechwood, Pembury road, Tunbridge Wells.
- Nov. 25, 1887. Lewer, J. J., 20, Crossfield road, Belsize park, N.W.
- April 27, 1866. Lewis, R. T., F.R.M.S. (*Hon. Reporter*), 4, Lyndhurst villas, The Park, Ealing, W.
- June 26, 1868. Lindley, W. H., jun., 29, Blittersdorffs platz, Frankfort-on-Maine.
- Mar. 20, 1891. Lloyd, H. W., 51, Camden square, N.W.
- Nov. 24, 1866. Lovibond, J. W., F.R.M.S., St. Anne street, Salisbury.
- Mar. 20, 1896. Lucas, C. Phipps, The Elms, Mottingham, Eltham, Kent.
- May 17, 1895. Macer, R., F.R.M.S., 23, Wingmore road, Loughborough Junction, S.E.
- Mar. 22, 1889. Machin, C. J., "Rosenfeld," Widmore road, Bromley, Kent.
- May 25, 1883. Mainland, G. E., F.R.M.S., Terrace house, Woodside lane, North Finchley, N.
- Feb. 15, 1895. Marshall, William John, F.R.M.S., 3, Ellingham road, Shepherd's Bush, W.
- Mar. 20, 1896. Martin, Herbert Sydney, F.R.M.S., Rosemount, Gleneagle Road, Streatham, S.W.

## Date of Election.

- April 26, 1867. Matthews, G. K., St. John's lodge, Beckenham, Kent.
- Jan. 15, 1892. Maw, W. H., F.R.M.S., F.R.A.S., 18, Addison road, Kensington, W.
- May 26, 1871. May, J. W., F.R.M.S., Arundel house, Percy cross, Fulham, S.W.
- June 19, 1896. McNeill, Capt. A., 37, Cathcart road, S.W.
- Feb. 15, 1895. Measures, John W., M.R.C.S., L.S.A., 62, Burgoyne road, Haringay, N.
- May 19, 1893. Merlin, A. A. C. Eliot, British Vice-Consulate, Volo, Greece.
- July 27, 1877. MICHAEL, A. D., F.L.S., F.R.M.S. (*Past President*), Cadogan Mansions, Sloane square, Chelsea, S.W.
- Mar. 20, 1896. Micklewood, S. R., 65, Oakfield road, Stroud Green, N.
- May 18, 1894. Miles, Lawrence, F.R.M.S., 59, St. Dunstan's road, West Kensington, W.
- July 7, 1865. Millett, F. W., F.R.M.S., Marazion, Cornwall.
- Jan. 15, 1897. Moorcock, Joseph, 24, Peckham Grove, S.E.
- Jan. 15, 1892. More, J., jun., F.R.M.S., 13, Drummond place, Edinburgh.
- July 26, 1878. Morland, Henry, Cranford, near Hounslow.
- June 15, 1894. Morton, W. J., 38, Wingate road, Ravenscourt park, W.
- Jan. 15, 1897. Mottram, James, Bank street, Norwich.
- Jan. 16, 1891. Muiron, C., F.R.M.S., 2, Agamemnon road, West Hampstead, N.W.
- June 19, 1891. Mummery, J. Howard, M.R.C.S., F.R.M.S., The Manor House, Southall, Middlesex.
- Mar. 24, 1876. NELSON, E. M., P.R.M.S. (*Past President and Hon. Editor*), 66, West End lane, West Hampstead, N.W.
- April 19, 1895. Neville, James, 15, Geneva road, Brixton, S.W.
- Nov. 25, 1881. Nevins, R. T. G., F.R.M.S., Pembroke lodge, Hildenborough, Tonbridge.

- Date of Election.
- June 21, 1895. Newstead, F., 124, Wightman road, Haringgay, N.
- Jan. 26, 1872. Newton, E. T., F.R.S., F.G.S. (*Vice-President*), Geological Museum, Jermyn street, S.W.
- June 15, 1894. North, The Honble. Sir Ford, F.R.M.S., 76, Queensborough terrace, Bayswater, W.
- Jan. 24, 1879. Offord, J. M., F.R.M.S., 62, Gordon road, Ealing, W.
- Dec. 22, 1876. Ogilvy, C. P., F.L.S., Sizewell house, Leiston, near Saxmundham, Suffolk.
- Nov. 18, 1892. Orfeur, Frank, 91, Effra road, Brixton, S.W.
- Dec. 27, 1867. Oxley, Frederick, F.R.M.S., 8, Crosby square, Bishopsgate street, E.C.
- June 16, 1893. Pannoll, H., 12, Sutherland square, S.E.
- Mar. 20, 1896. Pantin, Henry, Staplegrove, The Avenue, Beckenham.
- Nov. 17, 1893. Parker, F. St. John, Gladstone terrace, South Woodford.
- Oct. 27, 1871. Parsons, F. A., 15, Osborne road, Finsbury park, N.
- July 23, 1886. Paul, R., Holmbush, Cyprus road, Exmouth, Devon.
- April 23, 1875. Peal, C. N., F.R.M.S., F.L.S., Fernhurst, Mattock lane, Ealing, W.
- July 22, 1887. Pearce, G., F.R.M.S., Brabourne Lees, West Cliff road, Bournemouth.
- May 24, 1867. Pearson, John, 3, Westbourne grove, W.
- July 22, 1881. Perigal, Henry, F.R.M.S., F.R.A.S., 9, North crescent, Bedford square, W.C.
- Jan. 15, 1892. Pierce, W. J., 30, Arthur road, Brixton, S.W.
- Nov. 15, 1895. Pillischer, J., 88, New Bond street, W.
- Nov. 23, 1883. Plowman, T., Nystuen lodge, Bycullah park, Enfield.
- Sept. 28, 1877. Pocklington, Henry, F.R.M.S., 20, Park road, Leeds.
- Sept. 21, 1894. Pollard, John, 103, Lisson grove, N.W.
- May 15, 1896. Poulson, E., 135, St. George's street East, E.

- Date of Election.
- June 21, 1895. Poulter, Christopher, S., 57, Belvedere road, Upper Norwood, S.E.
- Mar. 21, 1890. Pound, C. J., F.R.M.S., Queensland Stock Institute, Brisbane.
- July 7, 1865. Powell, Thomas H., F.R.M.S., 12, Highbury terrace, N.
- Feb. 16, 1894. Praill, Edward, 3, Park road, Hampstead, N.W.
- Oct. 20, 1893. Preston, The Rev. G. H., Fleet Vicarage, Hants.
- June 27, 1873. Priest, B. W., 22, Parliament street, S.W.
- May 23, 1879. Pritchard, J. D., Crymlyn Burrows, near Swansea.
- Feb. 25, 1881. Probyn, Clifford, 55, Grosvenor street, W.
- May 16, 1890. Pyman, F. H., Raithwaite, Old Park estate, Enfield, N.
- Oct. 26, 1866. Rabbits, W. T., F.L.S., 6, Cadogan gardens, S.W.
- Oct. 26, 1866. Ramsden, Hildebrand, M.A.Cantab., F.L.S., F.R.M.S., 26, Upper Bedford place, Russell square, W.C.
- Nov. 17, 1893. Randell, George J., 6, Haycroft road, Brixton hill, S.W.
- June 24, 1881. Ransom, F., 12, Bancroft, Hitchin.
- June 22, 1877. Reed, J. W., 17, Colebrook row, Islington, N.
- June 27, 1873. Reeve, Frederick, 113, Clapham road, S.W.
- Mar. 20, 1896. Rheinberg, Julius, 64, Pyrland road, Canonbury, N.
- Sept. 18, 1891. Richards, F. W., 252, St. James's street, Montreal, Canada.
- Jan. 19, 1894. Roberts, Charles Philip, 26, Alma road, Canonbury, N.
- May 20, 1892. Robinson, J., F.C.S., F.I.C., 2, Ornan Mansions, Hampstead, N.W.
- Mar. 19, 1897. Robinson, J. G., Cragdale, Settle, Yorkshire.
- May 22, 1868. Rogers, John, F.R.M.S., 4, Tennyson street, Nottingham.
- Jan. 24, 1884. Rosseter, T. B., F.R.M.S., Fleur de Lis, Canterbury.
- Jan. 26, 1883. Rousselet, Charles F. (*Hon. Secretary for Foreign Correspondence*), F.R.M.S., 27, Great Castle street, Regent street, W.



## Date of Election.

- April 27, 1888. Russell, J., 13, Salisbury road, Newington, Edinburgh.
- Oct. 27, 1865. Russell, James, Merton lodge, Freeland road, Ealing Common, W.
- Feb. 19, 1892. Samson, W. E., 55, Bensham Manor road, Thornton heath.
- Nov. 18, 1892. Sandall, Leonard, 80, Landcroft road, East Dulwich, S.E.
- Jan. 16, 1890. Scherren, H., F.Z.S., 9, Cavendish road, Haringay, N.
- June 20, 1890. Scourfield, D. J., Spezia house, Fillebrook road, Leytonstone, E.
- Mar. 22, 1889. Scriven, J. B., Brigade Surgeon, 95, Oxford gardens, North Kensington, W.
- Mar. 18, 1892. Seligmann, C. G., F.R.M.S., 82, Shaftesbury avenue, W.
- Nov. 16, 1894. Shadbolt, W. P., Minatitlan, Estado de Vera Cruz, Mexico.
- July 23, 1880. Shaw, H. V., Woodville, Inglemere road, Forest hill, S.E.
- Mar. 15, 1895. Shaw, John Edward, 23, Culford road, Southgate road, N.
- May 26, 1876. Shephard, Thomas, F.R.M.S., Kingsley, Bournemouth West.
- June 19, 1896. Sidwell, Clarence J. H., 46, Ashbourne grove, Dulwich, S.E.
- May 26, 1871. Sigsworth, J. C., 20, Tedworth square, Chelsea, S.W.
- Jan. 17, 1896. Sillar, R. G., Dunallie, The Avenue, Surbiton.
- Oct. 28, 1881. Simons, W. V., Nilgiri house, 5, Baldwin crescent, Camberwell, S.E.
- Nov. 23, 1877. Simpson, T., Fernymere, Castlebar, Ealing, W.
- Dec. 28, 1866. Slade, J., F.G.S., 3, Chappel road, Bexley heath, Kent.
- Oct. 23, 1868. Smart, William, 27, Aldgate, E.C.
- May 25, 1866. Smith, Alpheus (*Hon. Librarian*), 14, Leigham Streatham, S.W.

## Date of Election.

- Mar. 25, 1870. Smith, F. L., London Institution, Finsbury Circus, E.C.
- June 27, 1873. Smith, G. J., F.R.M.S., 6, Malvern road, Hornsey, N.
- Dec. 16, 1892. Smith, Richard, F.R.M.S., 6, Marlborough Hill, N.W.
- April 22, 1887. Smith, T. F., F.R.M.S., 185, Brecknock road, N.W.
- Jan. 15, 1897. Smith, Walter G., 49, Kyverdale road, Stoke Newington, N.
- Aug. 23, 1872. Smith, W. S., 30, Loraine road, Holloway, N.
- Aug. 22, 1884. Smithson, T. S., Facit, Rochdale.
- Jan. 15, 1892. Soar, C. D., 20, Cortayne road, Hurlingham, S.W.
- May 19, 1893. Southon, W. H., 5, Carmalt terrace, Putney, S.W.
- May 22, 1874. Spencer, James, F.R.M.S., 121, Lewisham road, Lewisham, S.E.
- Mar. 16, 1894. Spink, John, Vine lodge, Sevenoaks, Kent.
- Sept. 25, 1885. Spriggs, A. T., Bank of England, E.C.
- Mar. 27, 1885. Squire, P. W., F.L.S., F.C.S., 413, Oxford street, W.
- April 17, 1891. Stevens, Col. L., F.R.M.S., 237, Southwark Bridge road, S.E.
- Nov. 27, 1885. Stevenson, G. T., Glencairn, Castelnau, Barnes, S.W.
- June 22, 1877. STEWART, CHARLES, F.R.S., M.R.C.S., F.L.S., F.R.M.S., etc., Royal College of Surgeons, Lincoln's Inn Fields, W.C.
- Jan. 25, 1889. Stocks, H., Guildford street, Chertsey.
- June 24, 1881. Stokes, A. W., F.C.S., 60, Park road, Haverstock hill, N.W.
- Nov. 16, 1894. Stokes, William B., Hale End, Chingford, Essex.
- Dec. 15, 1893. Sturt, Gerald, St. Helen's, Waldegrave Park, Strawberry hill, S.W.
- July 7, 1865. Suffolk, W. T., F.R.M.S., 143, Beulah hill, Norwood, S.E.
- May 18, 1894. Sutton, William, 121, West End lane, N.W.
- June 24, 1870. Swain, Ernest, Little Nalders, Broekhurst, Chesham, Bucks.

## Date of Election.

- May 17, 1895. Swan, Michael Edward, 55, Sheriff road, West Hampstead, N.W.
- Feb. 26, 1886. Swanson, A. J., 112, Cheapside, E.C.
- Dec. 17, 1875. Swift, M. J., 81, Tottenham court road, W.C.
- April 17, 1891. Tabor, C. J., The White House, Knott's Green, Leyton, Essex.
- July 27, 1877. Tanqueray, A. C., Reid's Brewery, Clerkenwell road, E.C.
- Nov. 28, 1879. Tasker, J. G., 30, Junction road, Upper Holloway, N.
- Feb. 15, 1895. Tatham, John, M.A., M.D., F.R.M.S., Rathronan lodge, The Avenue, Berryland, Surbiton.
- Oct. 16, 1896. Taverner, Henry, 43, Amhurst park, Stamford hill, N.
- Feb. 24, 1888. Taylor, W. W., "The Buttercups," Sutton, Surrey.
- Aug. 23, 1878. Teasdale, Washington, F.R.M.S., Headingley, Leeds.
- Dec. 22, 1865. Terry, John, F.R.M.S., 8, Hopton road, Coventry park, Streatham, S.W.
- Mar. 16, 1894. Teversham, Fred. W., 11, Effingham road, Hornsey, N.
- Feb. 17, 1872. Thorpe, V. Gunson, Surgeon R.N., F.R.M.S., 2, Naval terrace, Sheerness.
- Dec. 21, 1894. Traviss, Will. R., 35, Parkfield road, Willesden Green, N.W.
- June 27, 1884. Tress, S. C., West lodge, Clapham park, S.W.
- June 17, 1892. Turner, C., Glencoe, Agamemnon road, West Hampstead, N.W.
- July 26, 1867. Turnbull, J., Laurel house, North hill, Highgate, N.
- Dec. 18, 1896. Tweedie, Alex R., St. Bartholomew's Hospital, E.C.
- Nov. 18, 1892. Ussher, A. S., the Inland Revenue Department, Somerset House, W.C.
- Feb. 27, 1880. Vereker, the Hon. J. G. P., Hamsterley hall, Lintz green, Newcastle-on-Tyne.

## Date of Election.

- May 23, 1879. Vezey, J. J., F.R.M.S. (*Hon. Treasurer*), 188, Lewisham High road, St. John's, S.E., and 21, Mincing Lane, E.C.
- Feb. 16, 1894. Wade, H., 134, High street, Chatham, Kent.
- July 25, 1873. Walker, J. S., 6, Warwick road, Upper Clapton, E.
- May 22, 1868. WALLER, J. G., F.S.A. (*President*), 68, Bolsover street, Portland road, W.
- Nov. 22, 1867. Ward, F. H., M.R.C.S., F.R.M.S., 8, Lyndhurst villas, The Park, Ealing, W.
- June 28, 1878. Ward, R. J., Silver street, Lincoln.
- Feb. 17, 1893. Ward, W. Cleveland cottage, Hill, Southampton.
- Aug. 24, 1877. Watson, T. P., 313, High Holborn, W.C.
- Dec. 16, 1892. Watts, Christopher C., Kensworth, Dunstable, Beds.
- July 24, 1874. Webb, C. E., Wildwood lodge, North end, Hampstead, N.W.
- May 24, 1867. Weeks, A. W. G., 36, Gunter grove, West Brompton, S.W.
- April 17, 1891. West, C., Fernville, Fortis green, N.
- May 26, 1882. Western, G., F.R.M.S., 1, Schubert road, Putney, S.W.
- Feb. 25, 1876. Wheeler, George, 64, Canonbury Park South, N.
- Feb. 26, 1886. White, R., 43, Devonshire street, Islington, N.
- Aug. 22, 1879. Whittell, H. T., M.D., F.R.M.S., Board of Health, Adelaide, South Australia.
- June 25, 1880. Wickes, W. D., F.L.S., 32, Burlington gardens, Acton, W.
- Mar. 25, 1881. Wildy, Arthur, 47, Belsize square, N.W.
- Jan. 15, 1897. Williams, B. W., 120, Ackerman road, S.W.
- Nov. 23, 1877. Williams, G. S., 20, Oxford road, Kilburn, N.W.
- May 22, 1885. Williams, T., 10, Pitt street, Campden Hill, Kensington, W.
- Feb. 22, 1867. Wilson, Frank, 110, Long acre, W.C.
- Dec. 20, 1895. Wood, Walter J., 10, Hainton avenue, Grimsby.
- Nov. 16, 1894. Wooderson, Edwin, 17, Tavistock street, Strand, W.C.

## Date of Election.

- Mar. 19, 1897. Woodley, Ernest, 84, Jerningham road, New Cross, S.E.
- Feb. 19, 1892. Wright, L., 52, Cromwell avenue, Highgate, N.
- Nov. 23, 1888. Young, G. W., 82, Bridge road west, Battersea.
- April 19, 1895. Young, Johnstone Christie, F.R.S.E., 12, Prince's square, Bayswater, W.
- June 22, 1888. Young, William Martin, 48, Sinclair road, West Kensington, W.
- 

## NOTICE.

Members are requested to give early information to the Treasurer of any change of residence, so as to prevent miscarriage of Journals and Circulars.

LIST OF EXCHANGES AND OF SOCIETIES WHICH RECEIVE THE  
JOURNAL.

---

The Society of Arts, John Street, Adelphi, W.C.

The Editor of "Athenæum," Breams Buildings, Chancery Lane, W.C.

Chas. W. Smiley, Esq., "American Monthly Microscopical Journal," Washington, D.C., U.S.A.

F. C. Kenyon, Esq., Philadelphia Academy of Science, Philadelphia, Pa., U.S.A.

Dr. Otto Zacharias, Biologische Station, Plön, Holstein, Germany.

The Curator, Botanical Society of Edinburgh, The Botanic Gardens, Edinburgh.

"Botanical Gazette," University of Chicago, Chicago, Ill., U.S.A.

Birkbeck Literary and Scientific Institution, Breams Buildings, Chancery Lane, W.C.

La Société Botanique Italienne, Florence, Italy.

J. F. Cornet, Esq., Secretary, Société Belge de Microscopie, 259, Ixelles, Bruxelles.

D. E. Caush, Esq., Hon. Librarian, Brighton and Sussex Natural History Society, Royal Pavilion, Brighton.

C. King Rudge, Esq., Hon. Librarian, Bristol Naturalist Society, Ashgrove House, 145, Whiteladies Road, Redland, Bristol.

W. H. Vandersmitten, Esq., Secretary, Canadian Institute, 46, Richmond Street East, Toronto, Canada.

Henry Crowther, Esq., Royal Institution of Cornwall, Truro.

R. F. Grundy, Esq., Hon. Secretary, Croydon Microscopical and Nat. Hist. Society, 112, Lower Addiscombe road, Croydon.

The Entomological Society, 11, Chandos Street, Cavendish Square, W.

"The English Mechanic," 332, Strand, W.C.

A. P. Wire, Esq., Librarian, Essex Field Club, Buckhurst Hill, Essex.

The Librarian, Geologists' Association, University College, Gower Street, W.C.

James J. King, Esq., Librarian, Natural History Society of Glasgow, 207, Bath Street, Glasgow.

Daniel Hill, Esq., Herts Natural History Society, Herga, Watford, Herts.

Imperial Leopold-Caroline Academy, Halle-on-the-Saale, Germany.

Hon. Secretary, Microscopical Society of Liverpool, Royal Institution, Colquitt Street, Liverpool.

The Linnean Society, Burlington House, Piccadilly, W.

The Librarian, London Institution, Finsbury Circus, E.C.

F. Nicholson, Esq., Librarian, Literary and Philosophical Society of Manchester, 36, George Street, Manchester.

E. W. Badger, Esq., Editor, "Midland Naturalist," *Midland Counties Herald* Office, Union Street, Birmingham.

W. H. Hughan, Esq., Secretary, Historical and Scientific Society of Manitoba, Winnipeg, Canada.

The Editor, "The Microscope," Washington, D.C., U.S.A.

The Royal Society of New South Wales, care of Messrs. Trübner & Co., Paternoster House, Charing Cross Road, W.C.

Rev. J. L. Zabuskie, New York Microscopical Society, Waverley Avenue, Flatbush, L.L., New York, U.S.A.

The Patent Office Library, 25, Southampton Buildings, Chancery Lane, W.C.

Alfred Allen, Esq., Hon. Secretary, Postal Microscopical Society, 1, Cambridge Place, Bath.

Quekett Microscopical Club, 20, Hanover Square, W.

The Royal Society, Burlington House, Piccadilly, W.

The Royal Microscopical Society, 20, Hanover Square, W.

The Royal Medical and Chirurgical Society, 20, Hanover Square, W.

The Royal Dublin Society, Leinster House, Dublin.

The Editor of "Science Gossip," Messrs. Simpkin, Marshall, and Co., 4, Stationers' Hall Court, E.C.

Sibert Saunders, Esq., The Bank, Whitstable, Kent.

James Wright, Esq., Librarian, Tyne Side Field Club and Natural History Society, Newcastle-on-Tyne.

Mons. J. Tempère, 168, Rue St. Antoine, Paris.

Prof. G. B. De Toni, via Rogati, 2236, Padova, Italy.

The Wagner Free Institute, Montgomery Avenue and 17th Street, Philadelphia, U.S.A.

Dr. Anton Dohrn, The Zoological Station, Naples.

The Editor of "Knowledge," 326, High Holborn, W.C.

Prof. Antonio Berlese, R. Scuola di Agricoltura, Portici, Italy.

---



# Quekett Microscopical Club.

---

## R U L E S .

I.—That the Quekett Microscopical Club hold its Meetings at 20, Hanover Square, W., on the third Friday Evening in every month, except July and August, at Eight o'clock precisely, or at such other time or place as the Committee may appoint.

II.—That the business of the Club be conducted by a Committee, consisting of a President, four Vice-Presidents, an Honorary Treasurer, one or more Honorary Secretaries, an Honorary Secretary for Foreign Correspondence, an Honorary Reporter, an Honorary Librarian, an Honorary Curator, an Honorary Editor, and twelve other Members—six to form a quorum. That the President, Vice-Presidents, Treasurer, Secretaries, Reporter, Librarian, Curator, Editor, and the four senior Members of the Committee (by election) retire annually, but be eligible for re-election. That the Committee may appoint a stipendiary Assistant-Secretary, who shall be subject to its direction.

III.—That at the ordinary Meeting in January nominations be made of Candidates to fill the offices of President, Vice-Presidents, Treasurer, Secretaries, Reporter, Librarian, Curator, Editor, and vacancies on the Committee. That the President, Vice-Presidents, Treasurer, Secretaries, Reporter, Librarian, Curator, and Editor be nominated by the Committee. That the nominations for Members of Committee be made by the Members on resolutions duly moved and seconded, no Member being entitled to propose more than one Candidate. That a list of all nominations made as above be printed upon the ballot paper; the nominations for vacancies upon the Committee being arranged in such order as shall be determined by lot, as drawn by the President and Secretary. That at the Annual General Meeting in February all the above Officers be elected by ballot from the Candidates named in the lists, but any Member is at liberty to substitute on his ballot paper any other name or names in lieu of those nominated for the offices of President, Vice-Presidents, Treasurer, Secretaries, Reporter, Librarian, Curator, and Editor.

IV.—That in the absence of the President and Vice-Presidents the Members present at any ordinary Meeting of the Club elect a Chairman for that evening.

V.—That every Candidate for Membership be proposed by two or more Members, who shall sign a certificate (see Appendix) in recommendation of him—one of the proposers from personal knowledge. The certificate shall be read from the chair, and the Candidate therein recommended balloted for at the following Meeting. Three black balls to exclude.

VI.—That the Club include not more than twenty Honorary Members, elected by the Members by ballot upon the recommendation of the Committee.

VII.—That the Annual Subscription be Ten Shillings, payable in advance on the 1st of January, but that any Member elected in November or December be exempt from subscription until the following January. That any Member desirous of compounding for his future subscription may do so at any time by payment of the sum of Ten Pounds; all such sums to be duly invested in such manner as the Committee shall think fit. That no person be entitled to the full privileges of the Club until his subscription shall have been paid; and the Committee shall have power to remove from the List of Members the name of any Member who shall have omitted to pay his subscription six months after the same shall have become due (two applications in writing having been made by the Treasurer).

VIII.—That the accounts of the Club be audited by two Members, to be appointed at the ordinary Meeting in January.

IX.—That the Annual General Meeting be held on the third Friday in February, at which the Report of the Committee on the affairs of the Club, and the Balance Sheet, duly signed by the Auditors, shall be read. Printed lists of Members nominated for election as President, Vice-Presidents, Treasurer, Secretaries, Reporter, Librarian, Curator, Editor, and Members of the Committee having been distributed, and the Chairman having appointed two or more Members to act as Scrutineers, the Meeting shall then proceed to ballot. If from any cause these elections, or any of them, do not take place at this Meeting, they shall be made at the next ordinary Meeting of the Club.

X.—That at the ordinary Meetings the following business be transacted:—The minutes of the last Meeting shall be read and confirmed; donations to the Club since the last Meeting announced and exhibited; ballots for new Members taken; papers read and discussed; and certificates for new Members read; after which the Meeting shall resolve itself into a *Conversazione*.

XI.—That any Member may introduce a Visitor at any ordinary Meeting, who shall enter his name with that of the Member by whom he is introduced in a book to be kept for the purpose.

XII.—That no alteration be made in these Rules, except at an Annual General Meeting, or a special General Meeting called for that purpose; and that notice in writing of any proposed alteration be given to the Committee, and read at the ordinary Meeting at least a month previous to the Annual or Special Meeting at which the subject of such alteration is to be considered.

## APPENDIX.

### FORM OF PROPOSAL FOR MEMBERSHIP.

QUEKETT MICROSCOPICAL CLUB,

20, HANOVER SQUARE, LONDON, W.

I desire to become a Member of this Club. In the event of my being elected, I hereby undertake, so long as I remain a Member, to submit to and be bound by the Rules and Regulations now or at any future time made and provided; and I further undertake to pay to the Treasurer for the time being the Annual Subscription as it becomes due in each year.

Full Christian and Surname \_\_\_\_\_

Occupation \_\_\_\_\_

Postal Address \_\_\_\_\_

We recommend the above Candidate for Election.

\_\_\_\_\_ (*On my personal knowledge.*)

This Certificate was read \_\_\_\_\_ 18

The Ballot taken \_\_\_\_\_ 18



ON EXPERIMENTAL INFECTION OF DUCKS WITH CYSTICERCUS  
CORONULA MARAZEK (*Rosseter*), CYSTICERCUS GRACILIS (*Von*  
*Linstow*), CYSTICERCUS TENUIROSTRIS (*Von Hamann*).

BY T. B. ROSSETER, F.R.M.S.

(*Read March 19th, 1897.*)

PLATE XVIII.

My intention this evening is to lay before you a few facts in connection with the experimental infection of ducks (*Anas boschas dom.*) with the Cysticercus, or intermediate stage of *Dicranotenia coronula*, *Drepanidotenia gracilis*, and *Drepanidotenia tenuirostris*. Each of these three tapeworms I have found parasitic in the intestine of the domestic duck, they having become infected, no doubt, from their feeding on the crustaceans which nursed these cystic bodies and which existed in the pond which the ducks daily frequented, and from which my specimens, both of the Cysticercoids and the specific nurse, were taken; and with which I artificially infested, experimentally, my ducks so as to reproduce the adult tapeworm.

My reason for doing so is because of certain statements made by Dr. Stiles in his recent work on the "Tapeworms of Poultry," Washington, 1896, Bulletin No. 12, issued under the direction of Dr. Salmon, Chief of the Bureau of Animal Industry, U.S. Department of Agriculture. This is a work which must commend itself to helminthologists, especially those who are working exclusively on Avian helminths. In this work he casts a doubt on the accuracy of these cysticercoids, mentioned above, as being the larval form of these specific tapeworms, owing to the want of production of the final stage, or Tania, from the direct infestation of the duck with the cysticercus. In this publication Dr. Stiles has collected the scattered works of those European helminthologists who, during the present century, have investigated, and published their researches, in connection with Avian Tania; and a speciality is made of the known life-history, or otherwise, of those tapeworms which are particularly applicable to poultry. Hitherto it has been usual to classify, indiscriminately, all tape-

worms as *Tænia*. This has been caused by the absence of a definite plan, or mutual system, which would meet the varied ideas and views of helminthologists; and Dr. Railliet, in conjunction with Dr. Blanchard of Paris, formulated the idea, with a view, no doubt, of bringing order out of chaos, and of describing the genus according to the character of the hooks of the Scolex. Thus, taking *Tænia coronula* as a type, they propose to call it "Dicranotænia" or the "forked-hooked *Tænia*," Figs. 1 and 2; and *Tænia gracilis*, *Drepanidotænia*, or the "sickle-shaped hooked *Tænia*," Figs. 5 and 6. I have long held the opinion that the hooks of the Scolex, so variably constituted as they are in form and size in each species of tapeworm, should play an important part, as a distinctive feature, in classifying the armed *Tænia* in the cysticeroid stage; and this division of Railliet and Blanchard cannot but meet with approval, as it in some measure meets the case, and Dr. Stiles, so far as the hooks of the tapeworm are in question, adopts their views in his work.

Stiles cites four different methods of work—*i.e.*,

1st. Experimental infection of poultry by feeding to them known larval stages found in invertebrates, and thus raising the adult stage.

2nd. Experimental infection of invertebrates by feeding to them the eggs of tapeworms found in birds, and thus raising the larval stage.

3rd. Comparison of the hooks upon the heads of adult tapeworms of birds with the hooks of larvæ found in invertebrates, and thus associating the young and the old stages.

4th. Wild speculation as to the intermediate hosts, based upon negative results, and totally devoid of any scientific foundation.

The first two give positive proof of the life history when the experiments are successful; the third gives, according to Stiles, a probability, but not a proof; and, to use his (Stiles') words, the less said about the fourth the better.

Grassi and Rovelli (1888, 1889, 1892), by feeding chicken with slugs—*Limax*—containing Larvæ or Cysticercus, produced *Davainea proglottina*; and myself in 1891, by feeding ducks with Cypris containing Cysticercoids of an undescribed tapeworm, produced *Echinocotyle Rosseteri*, and thus fulfilled the requirements of Stiles' first proposition; and these, at the time he published his work, were the only "two" instances of direct infestation known

to him. I hope by my mounted specimens, drawings and statements in this paper, to convince you, and through the medium of the Transactions of the Quekett Club, Dr. Stiles as well, that these particular Cysticercoïds which he overshadows by "probability" and "possibility," are the actual Cysticercoïds, or as he calls it the larval stage of the above-named tapeworms.

I will first briefly describe these Cysticercoïds from my own collection, and afterwards quote the remarks passed by Dr. Stiles in his work in connection with them.

1. *Dicranotænia Coronula* (Dujardin, 1845); Railliet, 1892 (1845, *Tænia coronula* Dujardin).  
*Cysticercus coronula* Marazek, 1890; Rosseter, 1890 and 1896.

*Description of Cysticercus.*

Cyst	...	...	...	...	...	...	Globular
Diameter	...	...	...	...	...	...	0.172 mm.
Number of hooks on embryonic rostellum	...						20—24
Size of hooks	...	...	...	...	...	...	0.014 mm.

Character of hooks: bifurcated or pitchfork-shaped.

Habitat: Cypridæ and Cyclopida.

Final-host (*Anas boschas dom.*), figs. 1, 2, 3, 4.

"Several authors have found larval cestodes in fresh-water mussel-crabs, which they look upon as the young stage of *Dicranotænia coronula*.

"Marazek has found a Cysticercoïd in *Cypris ovum* Jur., and in *Cypris compressa* Baird, whose hooks correspond in form, dimensions, and numbers to those figured by Krabbe; the tail is 3.5 times as long as the body, and bears the six hooks—8  $\mu$  long—of the Oncosphere."

"Rosseter describes and figures the Cysticercoïd of *Dicr. coronula* from *Cypris cinerea* in Kent, England.

"While this Cysticercoïd is very similar to *Dicr. coronula*, and that in all probability it represented its larval stage, it must not be forgotten that the experimental proof of the relationship of these organisms has *not* yet been forthcoming; and, furthermore, that even the adult form is very imperfectly described."—*Stiles, loc. cit.*

2. *Drepanidotænia gracilis* ([? Zeder, 1803]; Krabbe, 1869); Railliet, 1893 (1869, *Tænia gracilis*, Krabbe.)  
*Cysticercus gracilis* (Von Linstow, 1872); Rosseter, 1896.

*Description of Cysticercus.*

Cyst : oval.

Diameter of cyst : length, 0·211 ; width, 0·109 mm.\*

Number of hooks on embryonic rostellum, 8.

Size of hooks : 0·075—0·078 mm.

Character of hooks : sickle-shaped.

Habitat : Cypridæ and Cyclopidaë.

Final-host : domestic duck (*Anas boschas*), figs. 5, 6, 7, 8.

“ Von Linstow, 1872, found a Cysticercoid in the intestine of a perch (*Perca fluviatilis*), which he looked upon as the young of *Tænia gracilis*. The larva has also been found in certain fresh-water crustaceans, which probably represent the regular intermediate host. Thus Scott, 1891, noticed an object in a mounted slide of *Candona prostrata* (Brady & Norman). Blanchard, 1891, examined Scott's preparations, and, after careful comparison of the hooks of the Cysticercoid, concluded that this larva belonged to the life-cycle of *Tænia gracilis*. Marazek cites the larva for *Cypris compressa* and *Cyclops viridis*.

“ The larva referred to is in all probability the true larva of this species, but no infestations have as yet been made.”—*Stiles, loc. cit.*

*Drepanidotænia tenuirostris* (Rudolphi, 1819) ; Railliet, 1893 (1819, *Tænia tenuirostris*, Rudolphi).

*Cysticercus tenuirostris* (Hamann, 1889 ; Von Linstow, 1892) ; Rosseter, 1896.

*Description of Cysticercus.*

Cyst : oval, at times globular.

Diameter of cyst : length, 0·211 ; breadth, 0·180 mm.†

Number of hooks on embryonic scolex, 10.

Size of hooks : 0·023 mm.

Character of hooks : sickle-shaped.

Habitat : *Gammarus pulex* ; *Cyclops agilis*.

Final-host : domestic duck (*Anas boschas*), figs. 9, 10, 11, 12, 13, 14.

\* This *Cysticercus* varies very much in size.

† This is the mean of six specimens. I have some perfectly globular, whose diameter is 0·230 mm., and another 0·211 mm. These cysts vary in size, but their characteristics are unmistakable, owing to the depth of the fluid cavity, which is 0·026 mm.



“Hamann found a Cysticeroid in *Gammarus pulex* which he looks upon as the larval stage of this worm, and he assumes that, as the domestic duck is the only bird (*i.e.* so far as Hamann knows) which visits the water in which the larval stage was found, this tapeworm is also found in domesticated ducks. An argument like this has value in science only in order to place us on our guard for the parasite; but it would be altogether going too far to accept this worm as a parasite of domesticated ducks until it is found in that host. Hamann made no infections with his larval forms, and accordingly the demonstration that this *Cysticercus* represents the larval stage of *Dre. tenuirostris*, is still lacking.

“Von Linstow, 1892, observed the same larva in the same host, and Marazek describes it from *Cyclops agilis*.”—*Stiles, loc. cit.*

These, then, are the three Cysticeroids with which I have successfully infested ducks, and produced, as you have seen by the mounted specimens which I have placed before you this evening for your inspection microscopically, the perfect *Tenia* of each of them; and thus have fulfilled, though unknown to Stiles, the primary, and, in his opinion, the most important method of rearing the adult stage.

Respecting *Cysticercus coronula*. Both Marazek and myself found this Cysticeroid in 1890—I really discovered it in 1888, but was ignorant at the time of its true character—parasitic in *Cypris ovum* and *Cypris cinerea*; and, although working independently, and at so great a distance from each other (*viz.*, Preban, Bohemia, and Canterbury, England), we both diagnosed it as the *Cysticercus* of *Tenia coronula*. I formed this opinion, and my conclusions were verified, by finding, on the edge of a pond, an aggregation of tapeworms, which proved to be *T. coronula* Duj., amongst the fæcal matter of a duck which frequented the pond from which the nurse, *Cypris cinerea*, was taken. For particulars I must refer you to *Journ. Micro. and Nat. Science*, 1890 and 1891.

*Cysticercus gracilis* is one of the earliest Cysticeroids I became acquainted with, as in 1888 I found it making *Notodromus monachus* its nurse. Singularly, I took the Notodromidæ from the intestine of a stickleback (*Gasteroserus aculeatus*); and in the same year I found it being nursed by *Cypris cinerea* and *C. viriens*. It is by no means rare in the duckponds of this

district (Canterbury), and is frequently commensal with *C. coronula*.

Unlike Hamann and Von Linstow, I have never seen *Cysticercus tenuirostris* making *Gammarus pulex* its resting stage; and I did not discover it being nursed by *Cyclops agilis* until 1894; in fact, I have never found it parasitic in any other crustacean. It is far from being common in duckponds in this district.

So far as regards *Cyst. gracilis* and *Cyst. tenuirostris*, like my colleagues, Drs. Blanchard, Von Hamann, and Von Linstow, I diagnosed them by comparing the hooks and their dimensions with the description and figures given by Krabbe of the hooks of the *Tænia*, as being the larval form of these specific tapeworms; and my feeding experiments with these two Cysticercoïds and that of *C. coronula* have proved both them and myself to have been correct in our decision. I have never experienced any difficulty in producing, by infestation, the mature tapeworm from these Cysticercoïds in ducks.

For my method of infestation of ducks I must refer you to my paper read before you in November last (1896), when I explained to you that all three of these Cysticercoïds had been used by me in feeding ducks with Cysticercoïds so as to produce *Drepanidotænia venusta* (Rosseter), somewhat in the light of a "control experiment" so far as production by direct infestation was concerned, and I have in that paper stated and given a *resumé* of the localisation of these *Tænia* in the alimentary tract of the domestic duck. By "control experiment" I do not mean to assert that influence was exercised to facilitate or retard the production of the tapeworm by using these Cysticercoïds as a factor in the development of the unknown *Tænia* from its *Cysticercus*; but the *Cysticercus* being nursed by the same crustacean as the Cysticercoïds (?) of *Dic. Coronula* and *Drep. gracilis* and communal with them, it was assumed, and rightly, that their presence in the nurse being known and their development in the duck ascertained, feeding them to the duck would furnish a clue to the solution of the problem of "Infestation," and serve also as an index in examining the alimentary tract for the *Tænia*, the product of the new *Cysticercus*—*C. venusta*. *Cyst. tenuirostris*, with its exclusively selected nurse *Cyclops agilis*, was also added, and by this means direct infestation was produced with these three Cysticercoïds, and the results in each instance, with their respective

localities in the intestine, demonstrated. A comparison of the hooks of each of these species of tapeworms, Figs. 2, 6, 12, with those of the *Cysticercus*, Figs. 4, 8, 14, which are in each instance a facsimile of my mounted specimens, place it beyond a doubt, more especially in this instance, as they (the hooks of the mature scolices) are the product of direct infestation, that they are not only similar, but, in conjunction with the embryonic rostellum which foreshadows that in the mature scolex, an exact counterpart of each other; and thus their identity is proved.

The itinerary or life-cycle of these tapeworms is governed by what Steenstrup denominated the "law of alternation of generations," that is to say the *Cysticercoid* stage, which is evolved from the *Oncosphere*, has to be "nursed," and its nurse must become the food of the vertebrate, which is, or will be, the final host of the specific tapeworm; and in which the *Tænia* will be perfected and propagate its species. This is in the regular course of nature, and is performed in a natural manner and governed by a natural law; and if this law is subverted by the nurse becoming the food of a creature other than the specified final host, as in the above case of *Cysticercus gracilis* in the perch and stickleback, of the species of tapeworm to which the *Cysticercoid* is affiliated; it (the *Cysticercoid*) has then wandered or strayed; and, following the course of nature under these circumstances, it perishes. Thus, if we find a *Cysticercus* in which a doubt exists as to its affinity with any known tapeworm which has been described or figured by a previous investigator, and we wish to feed experimentally with the *Cysticercoid* in question so as to produce the mature tapeworm and elucidate the subject as to its probable final host, then we have to consider the environment of its nurse and thus form our judgment of the class of creature it (the nurse) would in all probability fall a prey to as its food, and thus cause, in its intestine, the final development of the parasite of which it (the nurse) was but the intermediate stage. It is not always the case that the selection of the final host, for experimental infestation, is facilitated as it was in these three instances, because their *Tænia* was known, and the *Cysticercoids*, with their nurse, were plentiful in the pond, and the artificial infestation of the ducks with the infected crustaceans was prolific in its action, as the results proved. It is when the percentage is small, or, as in

the case of my *Cysticercus liophallus*, or *C. quadricurvatus n. sp.*, that a solitary specimen is found (although as regards the former the *Tænia* and its final host was known), that direct infestation, by feeding, to determine the species of tapeworm of which it is the larva becomes difficult, in fact out of the question, because one does not care to risk—I would not—so valuable a specimen as a solitary *Cysticercus* which I knew by comparison, and the accuracy of the measurement of the hooks with those of the known tapeworm, were one and the selfsame thing; neither should I feel justified in risking infestation with a single specimen of a *Cysticercus* of an unknown tapeworm—*e.g.* *C. quadricurvatus*; whose final host might, or might not perchance, be one of the *Anatinidæ*, to produce its *Tænia*—until I had found another specimen.

But Stiles insists on it as a *sine quâ non* that, until we have produced the tapeworm by “direct infestation” from the *Cysticercus*, we have no right to say, even by comparison of the hooks of the *Cysticercus* with those of the mature tapeworm, however accurately they may coincide, that this or that *Cysticercoid* is the intermediate or larval stage of this or that tapeworm, until we have fed with the *Cysticercus*, and can prove that from that *Cysticercus* we have produced its like. This he calls “direct infestation.” It is logical, and no one can disagree with him; and it is this want of feeding or direct infestation of ducks with *Cysticercus coronula* so as to produce *Dicranotænia coronula*, *Cysticercus gracilis* to produce *Drepanidotænia gracilis*, and *Cysticercus tenuirostris* to produce *Drepanidotænia tenuirostris*, that makes him cast a doubt and use the terms “possible” and “probable” on the decisions arrived at by Blanchard, Linstow, Hamann, and Marazek, after careful comparison and measurement of the hooks of these *Cysticercoids* with those of the known tapeworms, that they were the *Cysticercoids* of these *Tænia*; and to show how accurate were these conclusions of my colleagues, and that this Club may have the opportunity of hearing, and, I hope, placing on record in its “Transactions” the “first” recorded instance of the production of these three tapeworms by direct infestation with their *Cysticercoids* or larval stage, that I have come from Canterbury this evening to exhibit my specimen of these *Tænia* and their *Cysticercoids*, and to explain to you more fully the passing remark I made in connection with them in my paper of last November.

Should an epizooty of these entozoöns occur in our poultry-yards—which is by no means improbable, more especially as regards the Anseridæ and Anatinidæ—we now know authoritatively, by experiment and demonstration, the source of the infection; and measures could easily be devised to arrest the spread of the disease, a disease which has played sad havoc at different periods amongst the flocks of breeders of poultry on the Continent of Europe.

ADDENDUM.—I had hoped to have added *Cysticercus sinuosa* to this list, as I am feeding this *Cysticercus* to ducks so as to produce *Drepanidotenia sinuosa*; but my experimental infestations are not yet sufficiently matured.

REFERENCE TO FIGS. ON PLATE XVIII.

- FIG. 1. *Dicranotenia coronula* × 28.  
 ,, 2. Hook from rostellum × 900.  
 ,, 3. *Cysticercus coronula* × 140.  
 ,, 4. Hook from embryonic rostellum × 900.  
 ,, 5. *Drepanidotenia gracilis* × 140.  
 ,, 6. Hook from rostellum × 340.  
 ,, 7. *Cysticercus gracilis* × 140.  
 ,, 8. Hook from embryonic rostellum × 340.  
 ,, 9. *Drepanidotenia tenuirostris* with rostellum everted  
 × 62.  
 ,, 10. Same with rostellum inverted × 62.  
 ,, 11. Rostrum of *Drepanidotenia tenuirostris* × 230.  
 ,, 12. Hook from same × 930.  
 ,, 13. *Cysticercus tenuirostris* × 140.  
 ,, 14. Hook from embryonic rostellum × 930.

## ON FORAMINIFERA.

BY A. EARLAND.

*(Read June 18th, 1897.)*

“There are not more than twenty or twenty-two species of Pelagic Foraminifera, yet so numerous are the individuals of the species that they usually make up over 90 per cent. of the carbonate of lime present in the calcareous oozes of the abysmal regions of the ocean. The individuals belonging to even a dozen of these species far outnumber the individuals belonging to all the other known genera and species of Foraminifera. This is true not only with regard to their abundance and great importance in the now forming deep-sea deposits, but also to their great development in Tertiary and other geological formations.”—Murray, “Deep Sea Deposits”: *Challenger Report*, page 263.

When exhibiting slides of Foraminifera at the Club, I have frequently been asked by members for directions as to the best method of collecting and preparing foraminiferous material. I have therefore put together a short paper, in the hope that it may induce some of you to take a practical interest in these beautiful but somewhat neglected forms. As I have had very little practical knowledge of dredging, I shall confine my remarks to the collecting of shore sands and fossil material. The general treatment which I shall describe is necessarily the same as recommended by various writers on the subject, but I have added a few minor details and methods, some of which I believe are new, which I have found advantageous in practical work.

With the exception of some members of the first family, the Gromidæ, the Foraminifera are exclusively marine; and of the hundreds of species known to science, some or other are to be found in every quarter of the world, and at all depths, from tide-pools to several thousand\* fathoms. They may be roughly divided into two groups, the Pelagic and non-Pelagic Foraminifera. The first or Pelagic group is a very small one, consisting of only twenty-one species, about 1 per cent. of the total species known, fourteen only of which are commonly found in the pelagic state.

\* At *Challenger* Station 238, 3,950 fathoms, *Miliolina*, *Reophax*, *Haplophragmium*, and *Gaudryina*, all bottom-living forms, were recorded.

It is, however, of great importance, owing to the fact that these few forms constitute a large proportion of the "Plankton" surface life of the ocean. They swarm in infinite numbers at or near the sea surface, forming a staple food supply for the higher forms of life; and their dead shells, falling in an incessant rain to the sea bottom, are there building up those deep-sea deposits which have of late years attracted so much attention. Some idea of their enormous numbers can be gathered from the fact that their dead shells form as much as 80 per cent. of some specimens of Globigerina ooze (the average in 118 specimens of Globigerina ooze examined by the *Challenger* expedition being 53.10 per cent.), and that it is estimated that the deposits of Globigerina ooze alone have an area of over forty-nine million square miles, while their thickness cannot even be conjectured, as the process has probably been in operation for several geological epochs. They are seldom found in any numbers in the neighbourhood of land in these latitudes, and are consequently of rare occurrence in our shore gatherings.

The second or non-Pelagic group contains all the remaining Foraminifera, or 99 per cent. of the known species, and includes the whole of the Porcellaneous and Arenaceous subdivisions which are entirely unrepresented in the Pelagic group. They are all, normally, inhabitants of the sea bottom, having little power of motion; and, although some of the species have an almost universal range both in latitude and depth of water, they are, as a rule, confined to particular zones of temperature and depth. In dealing with shore gatherings we shall be most concerned with those species which flourish in and immediately below the "littoral" zone, and I will now try and explain how their shells are to be found between tide marks. The majority of the tests are those of dead foraminifera. When the sarcodite body dies it decomposes, and the chambered tests, filled with the gases of decomposition, rise, and drift with the currents until they come ashore. Being lighter than the sand, they take longer to settle after the wave has retreated, and are consequently retained in the troughs or ripple marks in the sand, where they can be detected with the naked eye as faint white lines on the sand, running parallel with the retreating tide, or in white patches of greater or less extent when the shells have been caught in an eddy. The prominence of these markings depends,

of course, upon the abundance of the foraminifera. I have rarely seen a piece of sandy beach where they were not present, but in most localities they are not sufficiently numerous to repay the trouble of collection. Where the beach is of shingle, the foraminifera can generally be found on the sands exposed below the shingle line at low-tide mark. This is the case at Bognor, where last year I made a splendid gathering, which contained many rare forms. The material was very abundant round the groynes to the west of the pier, while east of the pier there was hardly any. But the best localities for shore gatherings I know of are the bays on the coast of Jersey. Their extreme richness is best shown by the fact that Mr. Halkyard, in his paper on the Foraminifera of that island, furnishes a list of no less than 127 species. I have myself on several occasions obtained quite a quart of material in St. Brelade's Bay within a couple of hours, and some of the smaller bays are equally rich. It is rather a curious fact in connection with this locality that the shallow-water dredgings contain very few specimens, while in Guernsey, only twenty miles away, the converse is the case. The shallow-water dredgings are, in Guernsey, rich in specimens, while shore gatherings can hardly be obtained at all, so poor are the sands in foraminifera. This is no doubt owing to the fact that the water round the Guernsey coast is much deeper than it is round Jersey, and the set of the currents is also towards the latter island.

In the neighbourhood of estuaries, and where the water is brackish and muddy, the foraminifera are not so easily discovered, owing to the comparative scarcity of those porcellaneous forms whose white tests are so conspicuous in most gatherings. The commonest form in such gatherings is *Polystomella striatopunctata* (Fichtel and Moll), which sometimes forms 60 to 70 per cent. of the whole; and this species, when wet, is scarcely noticeable, owing to its colour harmonising with the sand. In such localities the collector must note the points at which other drifted matter has collected, and here he will also find the foraminifera, which can then be collected in the usual manner.

The first object of the shore collector should be to study the "set" of the tidal currents and the contour of the beach, as it will be seen that everything depends upon them. They alter almost from day to day with the tides; so that a spot which yields abundant material at one visit may be quite barren a short



time later. For instance, in August 1895 I made a careful search of the foreshore for several miles on each side of Herne Bay, in Kent, without result, until I discovered a spot, on the Whitstable side of the Hampton jetty, where the material was most abundant and nearly pure. In August 1896 the same spot yielded nothing, and a prolonged search in the immediate neighbourhood gave no result. At the same time, I have no doubt that if I could have spared time for a thorough search in each direction, I should have discovered some fresh collecting ground which had taken the place of Hampton as the focus of the local currents.

The apparatus required for the collection of shore gatherings is very simple. It consists of a metal spoon, a piece of metal such as the lid of a tobacco tin, having three sides bent up, and a broad glass slip ( $3 \times 1\frac{1}{2}$ " ); also some linen bags, or a metal canister, to contain the gatherings. The spoon is used for scraping ripple marks, and for lifting sand from the bottom of shallow pools. The tin and slip are for gathering the floats when they lie on the surface of the sand, the tin being used as a dustpan into which the material is swept with the slip. If material is abundant and rich, I seldom trouble to make any preliminary cleaning at the seaside; but if the gathering is poor and mixed with a large proportion of sand, it is as well to lessen its bulk and weight by a preliminary washing, which will eliminate most of the sand. This can be done on the beach as the material is gathered, using water from one of the pools. The only requisite is a shallow tin dish, or if possible a photographic developing dish with a lip at one corner. A handful of the gathering is placed in the dish, which is then nearly filled with water. The tin is then shaken with a circular rocking motion, which causes the forams to collect in a loose pile in the centre of the tin. By a sudden tilt they can then be emptied into a strainer, which can be improvised out of one of the bags, leaving the sand at the bottom of the tin. The gatherings should be slowly dried by a very gentle heat. Excessive heat will crack the delicate specimens, and turn the hyaline foraminifera dull and opaque. The dried material can then be packed away until it is convenient to finish the cleaning process.

This cleaning process is practically the same whether the material is clean sand or coze from the dredge. The apparatus

required consists of a retort stand to hold the sieves, a photographic developing dish, or a tin dish with a lip, some sieves, and a tall glass jar without a neck. I myself use one of those long glass jars sold for egg beaters (the "Lightning" Egg Beater, Grafton's patent), and find it answers admirably. The sieves are made of sheet copper, 4 inches high and 4 inches across at the top. The bottom is smaller, being only 3 inches in diameter, and a piece of brass wire gauze is soldered across it. The gauze can be obtained of various meshes, but the gauze 120 meshes to the inch is the finest easily procurable, and is quite sufficient for ordinary material. The size of the opening in this gauze is about  $\frac{1}{200}$  inch square, and as a rule nothing but immature or broken tests will pass through it. At the same time I make a practice of examining what passes through before throwing it away, and if necessary I wash it again on a special sieve made of the 120-mesh gauze, thickly plated with silver to diminish the size of the holes. Silk gauze made for the use of millers can be bought having 200 meshes to the inch, but I have never tried it, as it is very expensive, and I find the plated sieve answers my purpose.

Besides the sieve of 120 meshes it is advisable to have a few others of larger aperture, although this may depend upon the purse of the collector. I have found the most useful sizes to be 80 and 40 meshes to the inch, with two larger sieves of 12 and 20 meshes, chiefly useful for removing stones and foreign *débris* from gatherings. It is also advisable to have a copper sieve made without a bottom, as muslin of different degrees of fineness can then be stretched across it by means of a rubber band, and it makes a very handy utensil for sifting the dried material into different grades.

To wash the material, whether it is shore sand or dredgings, put a few spoonfuls in the 120 sieve, and let a gentle stream of water run through it until all sand and mud has been washed away, and the water passes clear. If the sieve gets clogged, as it soon will if there is much mud in the gathering, it should be dipped up and down in a basin of water until the meshes clear. All circular motion of the sieve must be avoided, as the slender forams will get entangled in the meshes and be broken. Be careful that the water in the sieve does not overflow, or you will lose the floatings which have risen to the top, and which generally include the finest specimens. After the material has been

thoroughly cleaned it can be tipped out into a plate and the operation renewed with a fresh supply.

The cleaned dredgings can now be thoroughly dried with a very gentle heat, and if the amount of material is small, it can be examined under the microscope as it is. If, however, material is abundant, or if you desire to separate the lighter and more delicate forms from the heavy, it must be floated. The glass jar must be nearly filled with water, and a few spoonfuls of the sand sprinkled slowly on the top. The lighter specimens, especially the *Miliolidaë*, the *Lagenidaë*, and the *Globigerinidaë*, will float, and can be poured off into a sieve of very fine muslin. The heavy forms, with the sand, etc., will sink; but if desired the lightest of these heavy forms can be to some extent separated from the others by filling the jar with water and pouring it off again into a sieve before they have time to settle. The floatings and washings must then be dried separately and sifted into different sizes.

When I am washing small quantities of material I generally remove the floatings as I wash the material. This is done not so much to save trouble as to secure delicate forms, which might get broken or lost in the process of washing. They can be removed from the surface of the water in the sieve by means of a cigarette paper, to which the forams adhere when it is dropped on the water. The papers can be dried on a plate, and the forams can then be brushed off with a camel-hair brush, and collected in a tube. By this means I have frequently obtained perfect specimens of spinous and other delicate forms, which are otherwise nearly always broken in the washing.

Fossil materials, such as sands and earths, may be prepared in the same way as I have described; but in the case of clays and shales the material requires preliminary treatment to ensure its disintegration. The material should be obtained in lumps of not more than one inch cube, and these must be slowly and thoroughly dried, avoiding great heat, which would harden the material. The lumps must then be placed in a basin, covered with boiling water, and allowed to stand until thoroughly broken up. This may take a day or more. The soft material is then cleaned in the usual manner, care being taken not to put too much at a time into the sieves. In selecting material, samples should be taken from various horizons, as the fauna is often very

different at various levels in the same deposit. Some years ago I brought a lot of material from the Gault of Folkestone, but not being a geologist I was obliged to take the specimens at random, and they did not prove very good. Since then, however, Mr. Chapman has published his valuable papers on the Gault Foraminifera in the "Transactions" of the R.M.S., and it should be comparatively easy for any one to procure good material there. The London Clay is, as a rule, barren of foraminifera, but there is a zone running under London which is sometimes exposed in excavations, from which they can be obtained.

Some of the hard clays and shales, and a few of the softer limestones which resist disintegration in every other way, can be disintegrated by repeated boilings in a saturated solution of common soda. I found this very effectual with some grey Miocene marls from Malta, and have also used it for reducing Radiolarian earths from Barbadoes.

Very fine foraminifera can be obtained from Chalk. Except for systematic study, the collector will do well to confine himself to the Upper Chalk, where the flints will furnish him with abundant material. This is to be obtained in two ways: Firstly, from hollow flints, the cavities in which are generally filled with a white powder, consisting principally of sponge *débris* and spicules with amorphous carbonate of lime, but foraminifera are more or less abundant. Sometimes the specimens are extremely large and perfect, and occasionally they are chalcedonised, while retaining their perfect form. As a rule, however, when the foraminifera are chalcedonised they are more or less corroded and distorted in the process.

In collecting the flints, those of a rounded form should be tried first, as they are more frequently hollow than the others, and with a little practice it is possible to judge by the weight whether a flint is hollow or not.

The second source of material is from the pockets or hollows on the outside of the large nodular flints. The chalk in these hollows, not having been subjected to the same pressure as the surrounding beds, is softer, and the foraminifera are better preserved.

The material, from whichever source, should be carefully dried, and the flint splinters removed as far as possible. It can then be cleaned in the usual manner.

I will now conclude with a few hints as to working the cleaned material. After being thoroughly dried it should be sifted into various degrees of fineness, and each kept in a separate tube. For examination I prefer a binocular microscope, carrying a nose-piece with  $1\frac{1}{2}$ " and 1" objectives. The glass stage fixed on Beck's "Economic" microscopes is excellent for this work, as it can be adjusted to move more or less easily, and can be shifted with the left hand, leaving the right hand disengaged for the brush. Also there is no rack and pinion or mechanical movement to get damaged with any scattered sand. A small amount of material should be scattered on the surface of a special slip, made by stretching black ribbed silk over the surface of a piece of card, and surrounding three sides with a wooden ledge in order to prevent the material from slipping off when the microscope is tilted. The ribs of silk should, of course, run across the field, as they serve as ledges against which the foraminifera rest on the slip. I have two or three trays covered with silk of various degrees of coarseness to suit different materials. The foraminifera are easily picked out with a sable brush, which is moistened between the lips and drawn to a point. At the reverse end of the brush handle I mount a short stiff bristle, which is useful for turning over material on the slip. When picked out the forams may either be mounted at once or transferred to a covered cell for future mounting. The best fixative medium is gum tragacanth, which I prefer to gum arabic, as it becomes nearly invisible when dry, and it is also less subject to the influence of those changes in the weather which often cause foraminifera mounted with gum arabic to crack and break. The gum should be made from the finest powdered gum tragacanth, and should be partially dissolved in sufficient spirits of wine to cover the powder. A small crystal of thymol added to the spirit at this stage will sterilise and preserve the mucilage from mould. Distilled water can then be added to dilute it to a proper consistency, which I find to be a very thin jelly, which does not run when the bottle is tilted. The gum need not be used too sparingly in mounting, as it contracts and disappears in drying.

For mounting foraminifera in balsam, a little of the same gum may be diluted with distilled water until it forms a perfectly clear liquid. A drop of this on the glass slip will be sufficiently strong to hold the foraminifera in position, and at the same time will

not show, provided the mount is thoroughly dried before the balsam is added.

When searching for specimens of a particular form known to occur in a gathering, much labour may often be saved by recourse to some mechanical process for separating it from its fellows. For instance, if the form required is of a more or less spherical shape, it is possible to obtain all the rounded foraminifera in a gathering by sprinkling the material on the surface of a sheet of glass or highly glazed paper, which is then gradually tilted until they roll off into another sheet prepared for their reception. If the process is carried farther, the less rounded forms will roll away, until at last only the very flat forms, such as *Cornuspira*, *Planorbulina*, etc., are left. This process naturally answers best with the coarse material containing large forms, but if carefully done it is possible even with the finest material—although in this case it is more useful as a means of separating the flat forms only, such as *Spirillina*, etc.

In the case of fossil foraminifera from many strata, and more rarely in the case of recent foraminifera, the internal chambers have become filled with mineral matter, thus furnishing perfect internal casts showing the shape of the sarcode body of the living animal. In fossils the mineral is usually pyrites, while in recent casts it is usually glauconite. The cast can be obtained by removing the calcareous shell of the foram by means of very dilute nitric acid, which should be so weak as to be barely perceptible to the taste. If the process of decalcification proceeds too rapidly, the effervescence will destroy the cast. When all the carbonate of lime is removed, the casts, which are extremely fragile, can be removed with a pipette and mounted in the ordinary manner.

In conclusion, I may add that the sarcode body may be observed and studied in the living animals, which may be obtained by washing algæ, etc., from lowest tide pools in a basin of water. The washings should be placed in a bottle, and the foraminifera will in a few hours be seen attached to the sides near the bottom. They can be removed with a pipette, and if the water is properly aerated, a supply can be preserved in a bottle for some time, keeping the bottle in a rather dark corner.

---

## ON THE MALE OF PROALES WERNECKI.

BY CHARLES F. ROUSSELET, F.R.M.S.

(Read June 18th, 1897.)

## PLATE XIX.

Up to last year the male Rotifers were all considered sadly neglected by nature, being diminutive in size compared with the females, and wanting in many essential organs necessary for a comfortable existence of some duration, such as a mouth, jaws, œsophagus, a stomach and intestine. The only recorded exception seemed to prove the rule, as it occurred in the very aberrant and parasitic rotifers of the genus *Seison* living as ectoparasites on *Nebaliæ*.

In the spring of last year, however, I discovered the male of *Rhinops vitrea*, which, while small in size, possesses fully developed jaws and functional digestive organs. A description of this male, with figures, will be found in the *Journal of the Royal Microscopical Society*, 1897, pp. 4-9, and Pl. I.

In the early part of the same year Professor W. Rothert, of Kazan in Russia, discovered another male rotifer: that of *Proales* (*Notommata*) *wernecki*, possessing fully developed jaws and mastax, and a somewhat rudimentary stomach and intestine. A very full account of this discovery and description of both male and female was published by Professor Rothert in the *Zool. Jahrbücher*, Bd. IX., Heft 5, 1896, pp. 673—713, but without any figures of the male. This male of *Proales wernecki* was also discovered early this spring both by Mr. F. R. Dixon-Nuttall and by myself, quite independently, and before we knew of Professor Rothert's paper.

At the conversational meeting of the Quekett Club of April 2nd Mr. W. R. Traviss exhibited some *Vaucheria* with numerous galls inhabited by this well-known rotifer, which he had found in a ditch close to his house at Willesden. A few days later Mr. Traviss sent me some of this *Vaucheria*, part of which I at once forwarded to Mr. Dixon-Nuttall. On examining the galls containing the enormously distended females of *P. wernecki*, surrounded by large

numbers of eggs, I noticed swimming in the water a few small and very slim rotifers, which I isolated and found to be males (Figs. 2 and 3), with a large sperm sac and usual copulatory organ, and also possessed of fully formed jaws; the stomach, with small gastric glands attached, is also present, but takes up a very small portion of the body cavity; the intestine could not be seen; the cesophagus is very long, and is moved about with a snake-like motion. The salivary glands attached to the mastax are very large and conspicuous in the young female; in the male they are also present, though smaller. The toes and foot-glands are large and strong in the male, but a contractile vesicle could not be found.

The jaws, which are the most peculiar feature of this male, are like those of the female in shape, and represented in Fig. 4. All the usual parts are well developed, and, in addition, there is a small triangular plate on each side articulated between the ramus and uncus. I have made the drawing of these jaws very carefully from a good view obtained by dissolving them out with caustic potash. It will be noticed that Dr. Rothert's figure of the rami differs somewhat from the same parts in my drawing. The exact delineation of these very minute jaws is very difficult, however, and a correct interpretation is almost impossible without dissolving out with potash.

The young female (Fig. 1), when first hatched, is much of the same size and appearance as the male; but the large white rounded salivary glands attached by a narrow neck to the mastax, and the large and full gastric glands, as well as the ovary and stomach, which together fill up the whole body cavity, serve to distinguish it at once.

Both the young male and female escape from the galls in which they have been hatched by an opening which is formed at the apex. They swim about in the open water for a time, and the young female then again enters a *Vaucheria* filament, but where and by what means is not exactly known yet. Having entered the filament, it causes the plant to produce a rounded or elongated gall of considerable size, where the rotifer can move about, and spends the rest of its life eating the green cell contents of the walls of the gall, and laying eggs to the number of forty to sixty. The female, it appears, is unable to develop and lay eggs outside the *Vaucheria* filament or gall. The adult female is extremely



stout, almost globular, pointed at both ends (figured by Hudson and Gosse, Pl. XXXII., Fig. 18c). The ovary is greatly distended with a large number of immature eggs, and the stomach filled with a very large mass of dark brown granulated undigested matter. It is probable that the intestine and rectum have become inactive, as no excrements are found in the galls, and the animal has not been seen to discharge any. The experiments I have made in this direction have all been negative.

Some galls contain all female eggs, and others both female and male eggs. The male eggs are somewhat smaller and far less numerous than the female eggs. Fertilised resting eggs, slightly larger, with double walls and smooth surface, are also found, but I have not seen them. Professor Rothert figures the resting egg, and states that he found as many as thirty to fifty-four of such eggs in one gall, all laid by a single female. He is inclined to think that the resting eggs are not the fertilised eggs because they are nearly as numerous as the ordinary female eggs, and because he saw them produced both when males were about and when there were none. This, however, is not conclusive, as a few males may have been present even if they were not seen. M. Maupas' \* experiments and researches a few years ago on *Hydatina senta* went to show that the resting eggs were fertilised male eggs (that is, eggs which, if they remained unfertilised, would have produced males), that male eggs only were capable of being fertilised, and that the ordinary parthenogenetic female eggs were never affected by the presence of males. Fertilisation takes place at an early stage, when the eggs are still in the oviduct or even ovary. M. Maupas has further shown that each female *Hydatina* lays one kind of eggs only, either female or male eggs, and if the latter have been fertilised, instead of producing males they become resting eggs. The animals issuing from the resting eggs, after a period of rest more or less prolonged, are ordinary females. The determining factor, according to M. Maupas, which will produce a *Hydatina* laying male or female eggs is heat; a high temperature in the water, above 26° C., producing females laying male eggs, and a low temperature females laying female eggs. According to the same authority the egg is neuter quite at the beginning of the oogenesis, and by lowering or raising the tem-

\* Maupas, "Comptes Rendus," tome cix. (1889), p. 270; tome cxi. (1890), pp. 310 and 505; tome cxiii. (1891), p. 388.<sup>2</sup>

perature it is possible to impart at will to the embryo the sexual character one may desire. It is probable, however, that there are other factors at work, such as scarcity of food, drying up of the water, and generally when the conditions become unfavourable to the life of the rotifers; for it is a well-known fact that males and resting eggs are produced at all seasons of the year, including the winter when the temperature is low, though the summer is no doubt the more favourable season for their production.

Professor Rothert has found both female and male eggs, and also female and resting eggs of *P. wernecki* in the same *Vaucheria* gall, but it does not necessarily follow that these were laid by the same female, as I have seen two or three females in the same gall. A more important observation of his is that resting eggs undergo segmentation and partial development before the second egg membrane is formed, and before the period of rest begins, so that the resting eggs contain embryos in an advanced state of development; this is probably true of resting eggs of all rotifers.

The *Vaucheria* I had received degenerated rather quickly, after a fortnight, and the rotifers went with it; and no more could be obtained, as the ditch had meanwhile dried up. My opportunities of further study were therefore cut short.

My friend Mr. F. R. Dixon-Nuttall soon informed me that he also had found the male; and the figures on the accompanying plate are his drawings of the male and of a very young female just hatched, showing the differences between the two. The dorsal antenna is small, but can always be seen in both the male and female, whilst the lateral antennæ have so far escaped detection.

Size of male fully extended	$\frac{1}{170}$ in. (149 $\mu$ ).
„ „ young female	„ $\frac{1}{160}$ in. (159 $\mu$ ).
„ „ adult female	„ $\frac{1}{150}$ in. (195 $\mu$ ),

#### EXPLANATION OF PLATE XIX.

- FIG. 1. *Proales wernecki*, young female, dorsal view.  
 „ 2. „ „ male, side view.  
 „ 3. „ „ male, dorsal view.  
 „ 4. „ „ jaws of male.

## THE LOGARITHMIC PLOTTING OF CERTAIN BIOLOGICAL DATA.

BY D. J. SCOURFIELD.

*(Read October 15th, 1897.)*

## PLATE XX.

No one will dispute the great value of the graphic representation or plotting of many classes of facts by means of curves drawn upon sectional paper. The great advantage of being able by means of such curves to grasp at one view not only the relation existing between the members of one series of numbers, but also their relation to another series, is so evident that, in the words of a well-known authority, "it needs no demonstration."

It sometimes happens, however, that the ordinary sectional paper, when used in the ordinary way, is quite powerless to cope with the enormous range of figures with which one has to deal. The increase in numbers of many of the lower animals and plants, for example, runs up in a few weeks, or even days, from units or tens to many millions. In such cases it is evidently quite impossible to plot curves showing the course of development, in the usual way. If it is desired to get a graphic representation of such data, some other method of plotting must be found; and the suggestion now brought forward is that for such work biologists should use sectional paper ruled logarithmically, or, what comes to the same thing, should use the ordinary sectional paper as if the distances at which the lines are drawn represented the logarithms of numbers and not the numbers themselves.

The idea of logarithmically ruled paper is not new, but the use made of it, even by mathematicians and physicists, appears to be very limited. Nevertheless its great value, at least in certain classes of physical work, has been fully acknowledged. (See Professor Boys's article "Scale Lines on the Logarithmic Chart," *Nature*, vol. lii., 1895, p. 272.) So far as I know, such paper has not hitherto been employed in biological work.

Logarithmically ruled sectional paper is produced by first of all drawing a series of lines at *equal* distances apart, according to any convenient scale, representing say the series of numbers

1, 10, 100, 1,000, 10,000, etc., the logarithms of which are 0, 1, 2, 3, 4, etc., respectively, and then dividing the spaces so obtained *unequally* by lines drawn at distances equal to  $\cdot 3010$ ,  $\cdot 4771$ ,  $\cdot 6021$ ,  $\cdot 6990$ ,  $\cdot 7781$ , etc., which are the logarithms of the numbers 2, 3, 4, 5, 6, etc.

Ordinary sectional paper, ruled say in inches and tenths, can be adapted to logarithmic plotting by considering the bolder lines to represent the numbers 1, 10, 100, 1,000, 10,000, etc., as before, and by applying to the intermediate lines the numbers of which the logarithms are  $\cdot 1$ ,  $\cdot 2$ ,  $\cdot 3$ ,  $\cdot 4$ , etc. The values of the lines, commencing with the first above the base line, will therefore be approximately as follows :—

1·259	3·981	12·589	39·811
1·585	5·012	15·849	50·119
1·995	6·310	19·953	63·096
2·512	7·943	25·119	79·433
3·162	<b>10·000</b>	31·623	<b>100·000</b> etc.

Typical logarithmic sectional paper should of course be ruled or taken logarithmically in both directions. This, however, is not required in plotting biological data as a rule, although it is possible that it might be useful in certain kinds of work—perhaps, for example, for data connected with the variations exhibited by a rapidly increasing number of organisms. But it is only proposed to consider the use of paper ruled or taken logarithmically in one direction—namely, horizontally, the ruling in the other direction proceeding in arithmetical progression as usual.

On the accompanying Plate (XX.) will be seen a chart which has been ruled in the manner above suggested. The horizontal lines represent tenfold changes in the numbers (individuals) for each unit of measurement (one inch), whilst the vertical lines represent equal divisions of time (months). The latter have been ruled at half-inch instead of one-inch intervals, as would perhaps have seemed more natural, because in this way steeper curves are produced, and also because the angles representing the various changes are separated from one another more than they would otherwise be.

In addition to the advantage already referred to—namely, that the graphic representation of an enormous range in the numbers is rendered possible—logarithmically ruled paper as described above, or ordinary sectional paper taken logarithmically, has the

further useful peculiarity that it shows the same proportionate changes in these numbers by lines having the same angle of slope in whatever part of the chart they may be situated, and this necessarily implies that similar-shaped curves denote the same relative course of events. A very little consideration will show that this must be so. As the horizontal lines are drawn at distances equal to the logarithms of the numbers, similar proportionate changes, whether increases or decreases, will always be represented by the addition or subtraction of the logarithm of the *same* number, *i.e.*, of the number representing the change. Thus, if two numbers, the one high and the other low, both become doubled, the result is shown on the chart by a shifting up equal to the logarithm of 2 in each case. But as the distances representing equal periods of time are equal, it follows that, if the doubling takes place in each case in the same time, the lines showing the change must be inclined at the same angle. The angle for any particular change, say per month, can be easily obtained from its trigonometrical tangent, which is evidently the logarithm of the number representing the change, divided (in the present instance) by  $\cdot 5$ , *i.e.*, the distance allotted to each month. The following table gives the tangents and the corresponding approximate angles for various changes per month:—

2-fold	=	$\frac{\log. 2}{\cdot 5}$	=	$\cdot 602$	=	tan. $31^{\circ} 3'$
3- "	=	$\frac{\log. 3}{\cdot 5}$	=	$\cdot 954$	=	" $43^{\circ} 39'$
4- "	=	$\frac{\log. 4}{\cdot 5}$	=	$1\cdot 204$	=	" $50^{\circ} 17'$
5- "	=	$\frac{\log. 5}{\cdot 5}$	=	$1\cdot 398$	=	" $54^{\circ} 25'$
6- "	=	$\frac{\log. 6}{\cdot 5}$	=	$1\cdot 556$	=	" $57^{\circ} 17'$
7- "	=	$\frac{\log. 7}{\cdot 5}$	=	$1\cdot 690$	=	" $59^{\circ} 23'$
8- "	=	$\frac{\log. 8}{\cdot 5}$	=	$1\cdot 806$	=	" $61^{\circ} 2'$
9- "	=	$\frac{\log. 9}{\cdot 5}$	=	$1\cdot 908$	=	" $62^{\circ} 21'$
10- "	=	$\frac{\log. 10}{\cdot 5}$	=	$2\cdot 000$	=	" $63^{\circ} 26'$
100- "	=	$\frac{\log. 100}{\cdot 5}$	=	$4\cdot 000$	=	" $75^{\circ} 58'$
1000- "	=	$\frac{\log. 1000}{\cdot 5}$	=	$6\cdot 000$	=	" $80^{\circ} 32'$

The oblique lines ruled across the accompanying plate have been drawn at the above angles, and serve as standards of comparison in estimating the increase represented by any part of a curve shown on the same plate. Changes due to decreases in the numbers are of course represented by lines at the same angles, but inclined in the opposite direction.

In illustration of the use of logarithmic sectional paper for biological purposes, some figures taken from C. Apstein's "Das Süßwasserplankton" (Kiel, 1896), have been plotted on the plate. The figures in all cases represent the number of individuals present under each square metre of surface of the Grosser Plöner See in Holstein, from the 8th May, 1892, to the 30th April, 1893. The depths range between 34 and 45 metres, but are sufficiently close to one another to allow of direct comparison of the results. The upper curve shows the changes in the total number of Diatoms of all the species numerically recorded—namely, *Asterionella gracillima*, *Melosira varians*, *M. arenaria*, *Fragilaria virescens*, *F. crotonensis*, and *Synedra delicatissima*. The second curve exhibits the changes in the number of specimens of the Rotifer *Anuraea cochlearis*; the third curve the same details for the Copepod *Cyclops oithonoides*, and the lower curve the same for the Cladoceran *Diaphanosoma brachyurum*. The three higher curves deal with organisms which are perennial in their appearance, although subject to enormous variation in numbers; but the lower curve relates to a species which is markedly periodic, dying out altogether in the winter so far as individuals beyond the egg-stage are concerned. The plotting of a curve to represent the facts in this case presents some little peculiarity, in that, owing to the construction of the logarithmic chart, there can be no zero line, or rather the zero line is infinitely remote. The simplest way to indicate that the species does nevertheless originate a fresh cycle of existence each spring, becoming extinct again each winter, seems to be to assume that the infinitely remote zero line can be brought up close under the base (unit) line, and then from the points indicating the first and last definite figures obtained, to draw lines down to points on the assumed zero line representing the previous and following date of collecting respectively. In the case of *Diaphanosoma brachyurum* this method has been followed, with the exception that, as the species is known to disappear long before the end of the year, an

assumed date has been taken early in December, instead of going to Apstein's next date of collecting, in the middle of January.

It does not seem necessary to refer here to the details of the development exhibited by the organisms selected for illustrating the use of logarithmic sectional paper, as the curves speak pretty plainly for themselves. Moreover, the present notes were not penned to enter into any discussion of biological facts, but simply to call the attention of biologists, and especially of those engaged in plankton work, to a method of plotting results which has been found very serviceable by the writer.

---

## NOTES ON PERIPATUS MOSELEYI.

BY THE REV. J. R. WARD, OF RICHMOND, NATAL.

COMMUNICATED BY R. T. LEWIS, F.R.M.S.

*(Read October 15th, 1897.)*

In the early part of December 1895 I received from my valued correspondent the Rev. J. R. Ward, of Richmond, Natal, a letter which began as follows:—

“I am sending you a caterpillar in glycerine, which I hope you will be able to get me some information about. It is rarely seen, is found in the bush, and is said to squirt when annoyed; but I do not see how this can be. I should like to know, for the friend who gave it me, what it turns into.”

The “caterpillar” thus referred to fortunately came to hand safely and in good condition, and proved on examination to be an object of very exceptional interest. It was about two inches long, the dorsal and lateral surfaces were olive green in colour, and the ventral portions chrome orange, the entire cuticle being covered with minute papillæ which gave it a soft velvety appearance. Its head was furnished with a pair of antennæ about  $\frac{1}{4}$  inch long, composed of many rings; there were two well developed simple eyes, a mouth apparently capable of cutting, tearing and sucking, twenty-one pairs of legs, each ringed and studded with papillæ, and terminating in a jointed retractile foot bearing two claws. There also appeared to be an anal orifice at the posterior extremity and a generative opening between the hindmost pair of legs.

Clearly this was no caterpillar in the ordinary acceptation of the term; it was not a larval form, it could not be an annelid, and in some very essential points it differed from a myriopod. This was, in fact, my first personal introduction to *Peripatus*, a creature so remarkable that a new class—*Prototracheata*—had to be created for the sole occupancy of its single genus.

As a detailed description of the structure of *Peripatus* by Mr. Adam Sedgwick, illustrated by fourteen figures and a map of



its geographical distribution, forms the first section of Vol. V. of "The Cambridge Natural History," now in the library of the Club, it will be unnecessary to refer here to the details of its anatomy therein given, since the specimen before the meeting seems chiefly to differ from *Peripatus capensis* in the number of its legs and the locality in which it was found; but it may be mentioned that, on comparison with the descriptions of the South African species referred to by Sedgwick, this appears to be identical with *Peripatus Moseleyi*. I cannot, however, refrain from quoting a portion of Mr. Sedgwick's eloquent description of the living animal as follows:—

"*Peripatus*, though a lowly organised animal, and of remarkable sluggishness, with but slight development of the higher organs of sense, with eyes the only function of which is to enable it to avoid the light—though related to those animals most repulsive to the æsthetic sense of man, animals which crawl upon their bellies and spit at or poison their prey—is yet, strange to say, an animal of striking beauty. The exquisite sensitiveness and constantly changing form of the antennæ, the well rounded plump body, the eyes set like small diamonds on the side of the head, the delicate feet, and, above all, the rich colouring and velvety texture of the skin, all combine to give these animals an aspect of quite exceptional beauty. Of all the species which I have seen alive, the most beautiful are the dark green individuals of *Capensis*, and the species which I have called *Balfouri*. These animals, so far as skin is concerned, are not surpassed in the animal kingdom. I shall never forget my astonishment and delight when, on tearing away the bark of a rotten tree-stump in the forest on Table Mountain, I first came upon one of these animals in its natural haunts; or when Mr. Trimen showed me in confinement at the South African Museum a fine fat full-grown female accompanied by her large family of thirty or more just born but pretty young, some of which were luxuriously creeping about on the beautiful skin of their mother's back." \*

The particulars I was able to give as to the one sent to me, at once aroused the interest of my correspondent, who endeavoured to obtain some other specimens, with the object, if possible, of learning something more as to their habits by personal observation of living animals; and, believing that a brief *resumé* of his

\* Cambridge Natural History, vol. v., p. 5.

communications upon the subject will be interesting to the naturalists amongst us, I have ventured—with permission—to place these notes upon the record of our proceedings.

On January 4th of the present year a living *Peripatus* was received from Enon bush, about eight miles from Richmond. My daughter, who happened to be spending her summer holiday with friends in that town, sent me some description of it at the time; and in a letter to me dated a few days later, Mr. Ward remarked, "Miss Lewis called here yesterday, not to see *me*, but to see a living *Peripatus Moseleyi*, in which she seemed particularly interested." This specimen was reported alive and well at the end of the month; and on February 1st, being at the house of the person from whom it had originally been received, Mr. Ward, accompanied by his friend's daughter as guide, made a further search in the adjoining bush, and had the pleasure of finding three more adults—one under the damp bark of a fallen and rotting tree, and the others in some mixed soil and decaying wood covered by a bunch of the common tree orchid. These were subsequently placed in a box with the one captured in January; and three others found about ten days later were put into another box, one of the latter being rather larger than the others and of a deep yellow colour. The boxes referred to were about 14" × 9", and great care was taken, in preparing them for their inmates, to imitate as closely as possible the conditions under which these creatures naturally live. The bottom of the box was first covered with a layer of rotten wood, crushed small and mixed with a little earth, pressed down compactly to form a floor which, whilst not loose enough for the animals to hide in, would absorb and retain the absolutely necessary moisture. On this floor some pieces of bark and moss were so arranged as to form hiding-places which would not readily collapse, and over all were placed some larger pieces of bark, which were useful in excluding excess of light, assisting to keep in the moisture and harbouring the numerous small insects usually found amidst such surroundings. By keeping the floor and contents of the boxes constantly damp, but not too wet, and being careful not to disturb the bark unnecessarily, the *Peripati* seemed quite comfortable, and soon made themselves at home, frequently lying coiled up together in a group when not walking about in search of food. During the hot damp days of February, when small insects were abundant,

a few fresh pieces of moss put into the boxes furnished sufficient insects for all requirements of food supply; but when the dry weather set in and insects became scarce, some other diet had to be provided, and recourse was had to small pieces of fresh beef, which appeared to be satisfactory; for, although never able to see exactly how the creatures fed—they apparently ate the softer portions only of the flesh and on this they seemed to thrive. One specimen having been given away, there were three in each box up to the end of March; but about that time one from each box unaccountably disappeared, and what became of these still remains a mystery: it was, however, suggested that two who appeared to live on specially intimate terms, finding the society of the third to be irksome, had killed and eaten him as the most effectual and economical method of relieving themselves of the company of 'one too many'; but it is only fair to say that in this instance no conclusive evidence can be adduced to convict them of the double crime of murder and cannibalism. The remaining two in each box were obviously pairs, the larger and lighter-coloured individuals being the females; and the interest already taken in them was much increased by the discovery, on April 10th, that one of these was accompanied by two young ones, whilst on the 14th her family had increased to five, and on the 17th to ten, at which number it remained. The large yellow female in the other box was found to have five young ones with her on April 17th, and a few days later eight were counted, no further increase being noted during the month. These young ones were born alive, and except as to colour and size resembled their parents in every respect—possessing even the power to eject the sticky fluid from their oral papillæ at the earliest age at which it was possible to test them. As the births proceeded at the rate of not more than one per day, the family obviously consisted of individuals of graduated ages; whilst there were only two or three the male appeared to keep out of the way, and the young followed the mother if disturbed; but as the number increased the elder ones would form groups by themselves, whilst the mother was attended by the latest born; there did not, however, appear to be any antipathy between either of the parents and their offspring, as the whole of them would occasionally be found coiled together in one happy family. The comparatively large size of the young was a matter of surprise, and

seems worth noting,—those of the smaller female, referred to as being found on January 4th, measured as much as  $\frac{3}{8}$  inch when not more than twelve hours old, and when lying at rest; whilst walking, they were of course much longer. The power of the full-grown animals to eject slime at any offending object was frequently put to the test. Upon being teased or menaced the head was at once turned towards the offender and a shot fired with great accuracy and considerable force, in some instances to as great a distance as two feet. Mr. Ward mentioned that, though his fingers had been struck at six or eight inches, he had not himself seen so long a shot as above stated; but his friend Mr. Gordon, from whom the earlier specimens were received, had himself seen this feat accomplished. This slimy or viscous fluid is secreted by large glands and stored for use in reservoirs at the bases of the oral papillæ, through which it is discharged at will by the sudden contraction of the surrounding muscular tissue. Though mainly used for defensive purposes, it is stated on good authority that the New Zealand species, when foraging, has been seen to shoot down distant insects by this means; and although the fluid itself does not appear to be either poisonous or irritant in its chemical composition, it would undoubtedly prove as troublesome as birdlime to any small creature upon whose wings or legs it chanced to fall. A drop happening in the course of its flight to touch a piece of moss, was observed to be drawn out into a long beaded thread very similar to one of the adhesive threads of the web of a garden spider.

The value of a record of any personal observations in matters of natural history has always been so fully recognised at the meetings of the Quekett Club, that I need hardly apologise for the attempt to preserve those which form the substance of the foregoing notes. Any member who may be desirous of learning something more as to the microscopical structure of *Peripatus* than is given in the "Cambridge Natural History" already referred to, will find the subject more fully dealt with in a memoir by the late Professor F. M. Balfour, edited by Professor H. N. Moseley and Mr. Adam Sedgwick, published in the *Quarterly Journal of Microscopical Science*, vol. xxiii., pp. 213-59, and illustrated by eight beautifully executed plates.

---

## A SHORT NOTE ON MINUTE DIATOM STRUCTURE.

BY EDWARD M. NELSON, P.R.M.S.

*(Read March 19th, 1897.)*

By the aid of the Powell apochromatic adjustable condenser I am able to report two further results in the resolution of fine diatomic structures.

The first is the detection of the long-shaped aperture in the nodule of *Navicula rhomboides*. A figure is unnecessary, because it is a minute edition of the structure beautifully drawn by Mr. Karop in our journal at Fig. 19, Pl. XX., Vol. 4, Ser. II. The pipes and the central spot in the nodule were of course familiar, but the aperture in the centre had not been seen before in so small a *navicula*. The whole spot in the nodule in *N. rhomboides* is not so large as the aperture in Fig. 19, and it was in this minute structure that the still smaller aperture was seen. It was not merely glimpsed, but it was well seen on this occasion, and irregularities in the aperture similar to those in Fig. 19 could be perceived.

The second structure relates to a diatom *Biddulphia elaborata* (Gr. and St.) mounted in styrax. The termination of the stalk of this diatom, which is known as the rose of the diatomic watering-pot, was figured by Mr. Karop in our journal at Fig. 5, Pl. IV., Vol. 3, Ser. II. The diatom itself is figured by Messrs. Grove and Sturt, at Fig. 9, Pl. XVIII., Vol. 2, Ser. II. That drawing, however, does not show the rim which is attached to the oval periphery of the valve, and which is  $\cdot 00041$  inch high. The general appearance of the valve might aptly be compared to an oval tea tray, having a convex mound in the centre as high as the rim, and a pipe, with a watering-pot rose top, rising up a little distance from the ends of its longer axis. The "close set papillæ," which are small pipes probably analogous to the perforation in the nodule in a *navicula*, rise from the centre of a crater which is at the top of an elevation in the middle of the valve. The edge of the crater is approximately level with the top of the rim round the periphery of the valve.

The length of the stalk measures  $\cdot 00124$  inch from its base to the top of the rose of the watering-pot, the length of the valve being  $\cdot 0079$ , and its breadth  $\cdot 0048$ . The ridges radiating from the centre of the valve between the rows of large areolations are caused by a thickening of the siliceous, the areolations being in a thinner part of the siliceous. Thus, if any one wished to make a model in wood of this portion of the valve, they ought to take a board of uniform thickness and plough grooves in it; the holes representing the large areolations would be drilled in these ploughed grooves where the board was thinner.

On the thick ridges between the rows of areolations there are intercostal dots, but these are very irregular, and numbers of them are missing. So much for the coarse structure. One of the peculiarities of this diatom is the apparent absence of any finely perforated membrane, except on the conical side and convex top of the rose of the watering-pot. These diatoms have been repeatedly searched for some delicately perforated membrane, but hitherto without success. Thanks, however, to the new Powell condenser, we are, although not able to see it, morally certain of the presence of a delicate perforated membrane; for little projections sticking out from the edges of the large areolations can, with attention, be made out.

Similar little projections may be seen in the areolations of *Coscinodiscus asteromphalus*, where the delicate membrane has been blown out; in this instance, however, the little projections are much more numerous. Mr. Karop's drawing of similar structures (Figs. 4 and 6, Pl. IV., Vol. 3, Ser. II.) and my photographs (Figs. 4, 5, and 6, Pl. XVIII., Vol. 3, Ser. II.), will illustrate my meaning admirably. The image is not easy. The interesting point is, that if the coarse part of the secondary structure is such a difficult object, what must the full resolution of the delicate membrane be? The answer to this question must be left to the microscopy of the future.

It is, however, satisfactory to be able to report that the question has been more speedily answered than was anticipated; for this afternoon Dr. Tatham, who was examining this specimen, said, "I can glimpse the perforated membrane." After a little while I was able to glimpse it also. It was, of course, like all similar new resolutions, merely a glimpse object, quickly lost again. But after modifying the adjustments and the illuminating

cone the structure was rendered sufficiently visible to enable us to hold it steadily.

Oblique illumination completely obliterates this structure, which can only be seen by means of a direct axial cone of maximum dry aperture.

#### ADDENDUM.

(Read May 21st, 1897.)

This note is merely a postscript to my last communication, to record the further discovery of some minute diatom structures. *Campylodiscus ornatus*, this very uneven diatom, has an ornamental border round it, on the exterior edge of which is a row of small compartments, and on the interior edge a row of much smaller ones. These large exterior compartments have a delicately perforated membrane over them, and so too have the interior ones, but the delicate structure on the interior ones is coarser than that on the exterior. It is just what might have been expected as it is in perfect conformity to the law of diatom structure—viz., “coarse in the centre, fine at the periphery.” On one occasion I had placed this slide on my student’s stand, and was examining it roughly, the objective being an old student’s  $\frac{1}{4}$ -in., and the illumination daylight, when to my astonishment I saw what appeared to be the resolution of the fine radial striæ in the peripheral compartments. A moment’s reflection convinced me that it was nothing but a ghost, the real structure being far-and-away beyond the grip of that or any other dry lens; moreover, the coarser structure in the interior compartments was not resolved! This is an interesting instance of the ease by which a false ghost can be produced by rough-and-ready microscopy. Some microscopists are of opinion that false ghosts are entirely monopolised by critical workers, who use elaborate condensers and wide-apertured objectives, etc.; and think that the elementary student’s microscope suitable for biological or histological work is free from all these objections; but such evidently is not the case.

*Actinocyclus Ralfsii*.—This diatom has a finely perforated membrane extending all over it. This membrane is probably similar to that in *Eupodiscus Argus*, only much finer. Inside the well-known white dots, elaborate ghost patterns can be made; it is, however, not difficult to discriminate between the ghost and

the true images. For example, in the ghost images of intercostals a missing one is never found, but in the true image missing ones and other irregularities are common.

*Eupodiscus Argus*.—Here we find a triple structure—viz., primary, secondary, and tertiary markings.\* The primary is large enough, and presents no difficulty; the secondary can also be very easily seen, but its true nature has, I think, never been thoroughly cleared up; the tertiary is the ordinary finely perforated membrane, but this is hardly so fine as usual. In this diatom we have two, and only two membranes—viz., that on the outside of the valve, which contains the primary and large areolations, and that on the inside, which has the secondary and tertiary structure. The secondary markings are tubes which pass obliquely through this membrane and open into the large areolations. They diverge towards the inside of the valve, and consequently are converging towards the outside.

We come now to a very difficult example—viz., the *Auliscus sculptus*. I have at last succeeded in resolving the rose pattern in the processes of this diatom. Having been able to demonstrate the similar, but much coarser, structure in the *A. racemosus*,† it was a moral certainty that other varieties had it also. In the *Sculptus*, however, it is so exceedingly fine that it has hitherto baffled all attempts at resolution; but now it has been seen on two or three occasions.

The *A. sculptus* has also very fine perforations in its beautifully sculptured border. Another variety—viz., the *A. macraeanus*—is a good one to begin upon, because the rose patterns in the processes are coarser than those in *A. sculptus*. All the above diatoms were mounted in balsam. It may be of interest to note that a bar has been met with crossing an areolation in the *P. angulatum* precisely similar to that in *P. formosum*, recorded in 1886.‡

\* *Journ. Q. M. C.*, Ser. II., vol. 2, p. 270, fig. 4, pl. 17 (1886).

† *Journ. Q. M. C.*, Ser. II., vol. 4, p. 316, fig. 12, pl. 20 (1891).

‡ *Journ. Q. M. C.*, Ser. II., vol. 12, p. 257 (1886).



## NOTE ON MYCETOZOA.

BY J. SLADE, F.G.S.

*(Read May 21st, 1897.)*

At the Soirée held in the beginning of the present month (May) some objects were shown belonging to a group of organisms known as Mycetozoa. These objects are not new to science, but as there seemed to be some misunderstanding in the minds of those who saw them as to what they were, it has been deemed desirable, at an early opportunity, to bring them before the Club and explain what they are. They are too frequently spoken of as Fungi, but this, as we shall presently see, is not their nature. There are about a hundred and seventy British species already described: these, with foreign species, brings the number up to about four hundred.

There is perhaps no group of organisms so easily within reach, which offers at the present so rich a reward to microscopic research. The harvest is abundant, but at present the labourers are few.

You have but to glance at the drawings before you, kindly lent by Mr. J. W. Reed, to see what beautiful objects they are; and although the same cannot be said of the diagrams, even they may be of some service in another way.

Fries, as far back as 1829, clearly defined the group; and De Bary, in his great work \* in 1864, carefully worked out their life-history. Since De Bary's time much has been done to increase our knowledge of these organisms. The Germans have studied them with their usual assiduity, and in England we have a monograph by Mr. Massée, of Kew, another by Mr. Lister, with a "Guide" and collections in the British Museum.

Unfortunately, as in other departments of Natural History so in this, the change in name has been an obstacle to their more

\* "Comparative Morphology and Biology of Fungi, Mycetozoa, and Bacteria," by De Bary. Translation. Clarendon Press, 1887.

general study. When in 1829 Fries first defined the group, he named it *Myxogastres*, and this name has been adopted by Mr. Massée. Walroth, who followed Fries, called it *Myxomycetes*, deeming it more akin to vegetable life; and he has been followed by Sachs in his "Text Book of Botany," and Kerner in his "Natural History of Plants." De Bary, thinking it had more affinity with animals, termed it *Mycetozoa*, and he has been followed by Lister.

The three specimens of this group which were exhibited at the Soirée, and which I will now describe, are set forth in the diagrams. They illustrate three well-marked genera—viz., *Arcyria*, *Stemonites*, *Trichia*. It is well to remember that in illustrations of these or other genera, whether in microscopic preparation, drawing, or diagram, only one phase in the life-history of each is represented, namely the fruiting stage. They are all Sporangia, and it is only at this stage they present characters sufficiently definite for purposes of classification.

In *Arcyria* we see a stalked capsule. At first it is closed, but when ripe it bursts; the top part is blown away, the bottom remains as a cup, to which are attached quite a cloud of threads. This is the capillitium, and encloses numberless spores. When highly magnified, each fibre of the capillitium is seen adorned with rings, half-rings, knobs, warts, etc.

In *Stemonites* the capsule is stalked; the stalk continues into a columella, from which branches the capillitium; the branches become finer and finer, ultimately uniting to form a beautiful network enclosing the spores; the whole being covered by a delicate membrane, which, when ripe, ruptures, entirely disappears, and is so said to be evanescent.

In *Trichia* the sporangium is a simple sessile capsule, which when ripe bursts and exposes a dense mass of threads—the capillitium—each thread of which is detached, unbranched, tapering at either end, and over it traverse well-marked spiral bands. As in the other examples, spores are abundantly scattered through the capillitium. For the many beautiful forms assumed by sporangia of other genera I must refer you to the plates from Mr. Massée's monograph laid out for your inspection.

The capillitium, or system of threads, forming a scaffolding among the spores, is present in most genera. It is best developed in *Arcyria* and *Trichia*.

As before mentioned, these sporangia are the only conspicuous stage in the life-history of these organisms: they appear as minute objects, as small as mustard seeds, or as black, hair-like, minute stalks on dead sticks, rotten wood, decaying leaves in damp places.

When a spore falls on a damp surface, or in water, it germinates. Out of the thick-walled spore comes a swarm spore, which is locomotive, either by means of a single cilium, as a flagellate infusorium, or by means of pseudopodia, as an amoeba. A number of spores germinating together may coalesce to form a plasmodium, each individual in the community preserving its own nucleus, which may divide and increase in the usual way. They may even separate, and after a time reunite.

The formation of a plasmodium is highly characteristic of the Mycetozoa, and does not occur elsewhere. Plasmodia for the most part are inconspicuous bodies. They live usually in the interior of rotten parts of plants, especially rotten wood, and are not visible to the naked eye till they come to the surface to form sporangia.

The brilliant and pure colours of plasmodia are remarkable: as white, rose red, orange yellow, lemon yellow, purple, sap green. They move about in search of food, may be cultivated, grown on glass slips for microscopic observation, and have been seen devouring bacteria most voraciously.

In *Fuligo varians*, or Flower of Tan, a number of plasmodia fuse together into a narrow reticulum, which swells into a cushion-shaped mass, sometimes 12 inches in diameter, full of lime salts, which, with the colouring-matter, forms a crust when dry.

In *Badhamia* the plasmodium thrives on the inner bark of felled elms, and is difficult to find, as it mostly incloses broken fragments of the bark. But before fruiting, these fragments are rejected, and it becomes pure white.

The plasmodium of *Stemonites* may be found emerging from the sawn surface of fir stumps, covering an area of 6 or 7 square inches.

In unfavourable conditions a plasmodium may become encysted, forming a transitory resting stage; and even after the lapse of several months, if placed in water, it revives, escapes from its cyst, and continues to live as before.

Ultimately the plasmodium rests, ceases to feed, concentrates,

to form either sporangia enclosing spores, or sporophores bearing spores on the outer surface.

In many cases quantities of crystals of carbonate of lime, with the colouring-matters, remain behind as the wreckage of the plasmodium.

The solid structures, such as the sporangial wall, capillitium or spore case, do not seem to be made of cellulose, but rather of a congealed protoplasm.

Thus we see that the stages in the life-history of the Mycetozoan, which distinguish it from all other organisms, are : (1st) firm-walled spores, giving rise to (2nd) swarm spores, which coalesce and form (3rd) a plasmodium.

The life-history of a Mycetozoan is divided into a nutritive stage, consisting of naked, membraneless, protoplasmic masses, and a reproductive, spore-producing stage. In the nutritive stage they very nearly resemble some groups of the Protozoa—*e.g.*, the flagellate infusoria. In the manner of their reproduction they certainly show affinities to many Fungi. But in the Fungi the germinating spore never produces a plasmodium, but only a mycelium.

There is no evidence in favour of the supposition that the Mycetozoa are degenerate members of the vegetable kingdom ; whereas the idea that the Fungi originated by differentiation from chlorophyll-bearing plant ancestors is generally admitted.

We have in the Mycetozoa a very remarkable group of organisms, in more ways than one. Not only are they beautiful objects in themselves, but they stand on the common ground or borderland, if such there be, between the animal and vegetable kingdoms.

These facts alone should increase our interest in this group of animated nature. But there is yet another aspect in which we may view it, perhaps beyond the bounds of proof, but yet within the range of the imagination. Professor R. Lankester says, "There is some reason to look upon the Mycetozoa as the nearest representative of that first protoplasm which was the result of long, gradual evolution of chemical structure, and the starting-point of the development of organic form."

It is quite true that our present knowledge of existing organisms is all on the side of Harvey's maxim, "*Omne vivum ex vivo.*" But if, to quote Professor Huxley, "if it were given to us to look

beyond the abyss of geologically-recorded time to the still more remote periods when the earth was passing through physical and chemical conditions, we should expect to be witnesses of the evolution of living protoplasm from non-living matter." May I suggest that that first living form may perhaps have been the remote ancestor of a Mycetozoan?

NOTE ON A NEW MODIFICATION OF DOUBLE COLOUR  
ILLUMINATION.

BY J. RHEINBERG.

*(Read October 15th, 1897.)*

I should like to bring before your notice, this evening, a new modification of double colour illumination suitable for high power.

Similarly as with low-power colour illumination, on the dark-ground principle, one of the ordinary double colour discs, having a central spot of one colour, surrounded by a ring of a strongly contrasting, and in this case preferably complementary colour (*e.g.* red centre and green periphery) is placed in the substage condenser, and by means of the iris diaphragm the relative proportions of the two colours are so regulated that on looking through the microscope the light appears to be neutral tinted.

But although the background appears neutral tinted, a suitable object will be seen coloured, in fact coloured differently in its various parts, as, according to their form and position, they will pick up a preponderance of one or other of the two colours by which they are illuminated. To give a single concrete example:— It is possible to light up a diatom so that the secondary structure may appear in one colour and the primary structure in another, both being very distinct at the same time.

Differential colour illumination by methods hitherto described has been confined to the use of cones of light either greatly exceeding the aperture of the objective used (*viz.* on the dark-ground principle), or very much smaller than the objective aperture (*viz.* on the diffraction system), but it will be observed that the particular modification described this evening permits of the use of the illuminating cone ordinarily employed. Each microscopist may use his own favourite cone.

It will also be observed that diffraction plays but a quite subsidiary part in this method as far as the colour effects are concerned, so that no untoward results on this score need be feared.

## P R O C E E D I N G S.

MARCH 5TH, 1897.—CONVERSATIONAL MEETING.

<i>Brachionus urceolaria</i>	...	...	...	Mr. J. M. Allen.
<i>Plumatella repens</i>	...	...	...	Mr. W. Burton.
Foraminifera from various localities	...	...	...	Mr. A. Earland.
Cholesterin	...	...	...	Mr. H. E. Freeman.
<i>Membranipora pilosa</i>	...	...	...	Mr. G. T. Harris.
<i>Trichina spiralis</i>	...	...	...	Mr. J. T. Holder.
<i>Triceratium fischeri</i>	...	...	...	Mr. H. Morland.
Muscle fibres	...	...	...	Mr. J. Rheinberg.

MARCH 19TH, 1897.—ORDINARY MEETING.

J. G. WALLER, Esq., F.S.A., President, in the Chair.

The minutes of the preceding meeting were read and confirmed.

The following new members were elected:—Mr. W. Barnes, Mr. J. D. Robinson, Mr. Ernest Woodley, Mr. Isenberg, and, as an Honorary Fellow of the Club, Dr. B. T. Lowne.

The following donations were announced:—

“The American Monthly Microscopical Journal”	...	...	...	...	} In exchange.
“The Microscope”	...	...	...	..	
“The Botanical Gazette”	...	...	...	..	..
“Annals of Natural History”	...	...	...	...	Purchased.
“Transactions of the Botanical Society of Edinburgh”	...	...	...	...	} Purchased.
“Reports of the Illinois University	...	...	...	...	
2 vols. “Nova Acta”—Car. Leop. Akad. of Halle	...	...	...	...	} Purchased.
of Halle	...	...	...	...	

The thanks of the Club were voted to the donors.

Mr. Vezey thought it might be interesting to the members to hear that Mr. C. J. Pound—one of their number—had recently been elected President of the Royal Society of Queensland.

Mr. W. Stokes read a paper "On some Cheap Monochromatic Light Filters," in which he described some experiments he had made with coloured gelatine films so combined as to allow only a single colour to pass through; also some attempts to attain the same end by means of glycerine jelly stained with aniline dye.

Mr. E. M. Nelson was glad to hear that something further was being done in this direction, and hoped that these experiments with coloured gelatine would be pushed as far as possible, because they were cheaper and less liable to get out of order than the fluid screens, but as yet they were hardly luminous enough; probably better specimens of gelatine could be obtained.

Mr. Karop thought it was possible that the difficulty mentioned in connection with the glycerine jelly might be due to the fact that it was a compound, and that it might perhaps therefore precipitate the aniline.

Mr. Rheinberg had made a very good screen by floating a little collodion on glass, mixed with a little malachite green. When tested with the spectrum it was found to pass the F line.

The thanks of the meeting were voted to Mr. Stokes for his communication.

Mr. T. B. Rosseter read a paper "On the Experimental Infection of Ducks with *Cysticerci*," in continuation of his paper read before the Club on November 20th, 1896. The subject was illustrated by drawings and diagrams, and by the exhibition of 1 mounted specimens under the microscope.

The President congratulated Mr. Rosseter upon the very interesting paper which he had read, and expressed a hope that some further remarks would be made upon the subject by the members present.

Mr. Karop feared that this was a subject which Mr. Rosseter had all to himself. No doubt, however, the members had been greatly interested in the account which he had given of his investigations, and he was quite sure the paper was one which would be a credit to any Society.

Mr. Rosseter expressed his thanks to the Club for the way in which his paper had been received, although the subject might possibly indicate a somewhat morbid taste on his own part.



Mr. E. M. Nelson exhibited and described an achromatic bull's-eye condenser, which would be also found perfectly aplanatic. Also a new 10-power loup, the object of which had been to obtain a greater length of focus than in the previous form of the same power. In this case the focal length was  $\frac{8}{10}$ " ; in construction the lens was a triplet, but the curves were not symmetrical. Mr. Nelson also read a short note on diatom structure, and exhibited a very much amplified photomicrograph of a portion of a diatom, which he said was on the scale of 1 postage stamp =  $3\frac{1}{2}$  acres.

Dr. Tatham said that on his way down to the meeting he called on Mr. Nelson, and had the pleasure of finding him at work on high-power definition. He said to him, "Just look at this carefully, and you ought to see the fine perforated membrane of the secondary structure." He did look for a long time, and was successful in glimpsing this structure ; but, although he saw it, he did not take any credit to himself for so doing : the reason was the excellence of the arrangements made—for Mr. Nelson was working apochromatically from end to end, and eyepiece and lens were in perfect conditions of adjustment, and it so happened that he was at the right end of the tube at the right time to see this, and to be quite sure that it was a reality. They were working with the full aperture of Powell's apochromatic condenser, and the structure which he saw, he was glad to say, was unquestionably seen also by Mr. Nelson himself. He regarded this as one of the most beautiful sights he had experienced since he became a microscopist.

The thanks of the meeting were voted to Mr. Nelson for his communications.

The Secretary announced that there would be no ordinary meeting of the Club in April, as the third Friday would be Good Friday. He also reminded the members of the Conversation fixed for May 4th, and expressed a hope that they would do their best to make it a success, worthy of the Club.

<i>Asplanchna priodonta</i>	...	...	...	Mr. J. M. Allen,
<i>Euchlanis diletata</i>	...	...	...	Mr. W. Burton.
<i>Coryne vaginata</i>	...	...	...	Mr. G. T. Harris.
Eye of a butterfly	...	...	...	Mr. J. Rheinberg.
<i>Proales wernecki</i> in galls of <i>Vaucheria</i>	...	...	...	Mr. C. F. Roussetlet.

## APRIL 2ND, 1897.—CONVERSATIONAL MEETING.

<i>Melicerta conifera</i> ... ..	Mr. J. M. Allen.
<i>Conochilus volvox</i> ... ..	Mr. W. Burton.
Seed of <i>Nemesia compacta</i> ... ..	Mr. A. W. Dennis.
<i>Cyclops quadricornis</i> , covered with a parasitic infusorian <i>Epistylis</i> (?) ... ..	Mr. A. Earland.
<i>Clava multicornis</i> , with gonophores, from Marazion ... ..	Mr. G. T. Harris.
<i>Navicula zanzibarica</i> ... ..	Mr. H. Morland.
<i>Pedicellina cernua</i> , var. <i>glabra</i> ... ..	Mr. W. Traviss.

---

## MAY 7TH, 1897.—CONVERSATIONAL MEETING.

<i>Conochilus volvox</i> ... ..	Mr. J. M. Allen.
<i>Lophopus crystallinus</i> ... ..	Mr. W. Burton.
<i>Brachionus quadratus</i> , a variety with four posterior-dorsal spines, two at right angles to the dorsal plane. Found at Spalding, Lincoln, April 1897 ... ..	Dr. J. W. Measures.
<i>Psamma arenaria</i> , trans-section of the leaf	Mr. C. Sidwell.

---

## MAY 21ST, 1897.—ORDINARY MEETING.

J. G. WALLER, Esq., F.S.A., President, in the Chair.

The minutes of the preceding meeting were read and confirmed.

The following gentlemen were balloted for and duly elected members of the Club:—Mr. A. Foucar, Mr. J. Mackenzie, and Mr. H. Wild.

The Secretary announced that the catalogues of the Botanical and Petrological specimens in the cabinet of the Club were now ready for issue, and copies could be obtained from the Curator, price 6*d.* each.

The following additions to the Library were announced:—

“Proceedings of the Royal Society”	... From the Society.
“Journal of the Royal Microscopical Society”	” ” ”
“The Microscope” ... ..	” ” Editor.
“The American Monthly Microscopical Journal” ... ..	} ” ” ”
“The Botanical Gazette” ... ..	” ” ”
“Proceedings of the Nova Scotia Institute of Science” ... ..	} ” ” Society.
“Proceedings of the Scottish Microscopical Society” ... ..	} ” ” ”
“Annals of the Belgian Microscopical Society” ... ..	} ” ” ”
“Proceedings of the Geologists’ Association”	” ” ”
” ” Royal Institution of Great Britain” ... ..	} ” ” ”
“Reports of the Academy of Philadelphia”	” ” ”
“Smithsonian Institution Reports for 1894”	” ” Institution.
“Bulletin of the United States National Museum” ... ..	} ” ” Council.

The thanks of the Club were unanimously voted to the donors.

The President said that the Committee had that evening been discussing the question of the advisability of dispensing with the ordinary meeting of the Club in September, and had resolved to submit a resolution, which they had passed, to the members for their adoption, if approved.

The Secretary said that those who were able to attend the meeting in September were aware that it was generally very poorly attended. It was most difficult to get any one to read a paper, and their usual meeting-room was not available. Under these circumstances the Committee had thought it desirable to propose that in future they should have no ordinary meeting that month, although there would be a conversational meeting on the third Friday in place of the ordinary meeting. To carry out this proposal it would be necessary to make a slight alteration in their Rule No. 1, by adding the word September. The rule would then read as follows: “That the Quekett Microscopical Club hold its meetings at 20, Hanover Square, W., on the third Friday evening in every month, except July, August, *and September*, at

eight o'clock precisely, or at such other time and place as the Committee may appoint." On behalf of the Committee he gave notice that the next meeting would be made special for the consideration and adoption of this proposed alteration in Rule 1.

Mr. J. Slade read a paper on the Mycetozoa.

The President said that Mr. Slade had mentioned that a great many persons had studied this subject. He hoped, therefore, that some of those present would favour them with some remarks. Failing this, he proposed a vote of thanks to Mr. Slade for his very interesting communication. This, being put to the meeting from the chair, was unanimously carried.

Mr. Slade said he should like to call attention to the great assistance which Mr. Reed had given him in the matter by procuring the drawings and specimens with which the subject had been illustrated.

Mr. E. M. Nelson read a postscript to his previous communication on minute diatom structure.

The thanks of the meeting were, on the motion of the President, unanimously voted to Mr. Nelson for his communication.

Announcements of meetings and excursions for the ensuing month were then made, special attention being called to the whole day's excursion of June 12th, and to the necessity for notice of members' intention to go being sent to the Hon. Secretary of the Excursions Sub-Committee not later than June 5th.

The proceedings closed with the usual conversazione, at which the following objects were exhibited:—

<i>Stentor viridis</i>	...	...	...	...	Mr. A. E. Hilton.
<i>Limnias cornuella</i> (mounted)	...	...	...	...	Mr. C. Rousselet.
Preparations of <i>Arcyria</i> , <i>Dictydium</i> , <i>Stemonitis</i> , and <i>Trichia</i>	...	...	...	...	Mr. J. Slade.
Head of <i>Gyrinus natator</i>	...	...	...	...	Mr. C. Turner.

---

JUNE 4TH, 1897.—CONVERSATIONAL MEETING.

<i>Limnesia</i> , larval form	... ..	Mr. C. D. Soar.
<i>Technitella melo</i> , Norman, from Cebu, Philippine Islands, 120 fms.	... ..	Mr. A. Earland.
<i>Janischia antiqua</i> , from Cementstein from the Island of Moro, Jutland	... ..	Mr. H. Morland.
<i>Ranunculus repens</i> , Trans., section of a runner	... ..	Mr. C. Sidwell.
The tongue of <i>Andrena cineraria</i>	... ..	Mr. C. Turner.

JUNE 18TH, 1897.—ORDINARY MEETING.

J. G. WALLER, Esq., F.S.A., President, in the Chair.

The minutes of the preceding meeting were read and confirmed.

The following gentlemen were balloted for and duly elected members of the Club:—Mr. C. Campbell, Mr. A. J. Crawley, Mr. J. J. Cayley, Mr. A. S. Murrow, Mr. A. L. Still, Mr. C. E. Woodgate, and Mr. M. F. Dunlop.

The following donations to the Club were announced:—

“Proceedings of the Royal Society”	... ..	From the Society.
“The Botanical Gazette”	... ..	„ Editor.
“The American Monthly Microscopical Journal”	... ..	} In exchange.
“The Microscope”	... ..	
“Annals of Natural History”	... ..	Purchased.
“Journal of Royal Microscopical Society”	... ..	From the Society.
“Le Micrographe Preparateur”	... ..	„ „ Publisher.
“Transactions Natural History Society of Glasgow”	... ..	} „ „ Society.
	... ..	

The thanks of the Club were voted to the donors.

The meeting was then declared special, pursuant to notice given at the preceding meeting, for the consideration of a proposal to alter Bye-law No. 1, by the insertion of the words “and September” after the word “August” in the existing bye-law, the altered bye-law to read as follows:—“That the

Quekett Microscopical Club hold its meetings at 20, Hanover Square, W., on the third Friday evening in every month, except July, August, and September, at 8 o'clock precisely, or at such other time or place as the Committee may appoint."

Mr. J. J. Vezey moved "that the proposed alteration in the bye-law be made." He said that the members would be able to meet on the third Friday in September as usual, but that this would in future be a gossip night instead of an ordinary meeting, the reason for the proposal being that they had found by experience that the attendance at the September meeting was usually very small. There was rarely a paper to be read, and it was thought scarcely worth while to oblige the officers of the Society, who might not then be in Town, to come up to a meeting at which there was so little to be done.

Mr. Rousselet having seconded the proposition, it was put to the meeting by the President, and declared to be carried unanimously.

The ordinary meeting having been resumed,

Mr. Hill exhibited and described a new portable binocular microscope by Messrs. Beck. The general construction of the instrument was the same as the "National" by the same firm, but the stage was made to remove entirely from the stand for greater convenience in packing. The stand was a large-sized one, suitable for pond work, and it was fitted with a centring apparatus.

Mr. E. M. Nelson thought the idea carried out in this microscope was a very excellent one, and rather a novel one also. It no doubt added greatly to convenience in packing away, and he did not see why the stage should not come away and yet be quite as steady when replaced as one which turned on its axis.

Mr. A. Earland read a paper "On Collecting and Preparing Foraminiferous Material," for which the thanks of the meeting were unanimously voted.

Mr. Rousselet read a paper "On the Male of *Proales Wernecki*," drawings of the male and young female being shown in illustration.

A vote of thanks to Mr. Rousselet was unanimously carried.

Mr. E. M. Nelson exhibited a new objective, which, he thought, marked an era in the history of the microscope. It was a  $\frac{1}{10}$ " oil immersion by Leitz, with a numerical aperture of 1.3, the price

of which was only £3 15s., and this was also the first lens of this kind which had been made for a long tube. Semi-apochromatic lenses had been greatly improved, and there was now very little to choose between them and the apochromatics. The difference between them in aperture being in the proportion of 13 to 14, many of the more difficult test objects could be resolved by them with a little care. He also called attention to some photographs, framed and exhibited on the table. All had been enlarged to the same size of picture, although the magnifying powers under which the original negatives were taken varied considerably. He thought, notwithstanding the great amount of amplification, that many of these pictures would be found remarkably sharp and well defined. He also exhibited one of his new mirror lousps, which he thought was likely to be found serviceable either in daylight or by the light of a paraffin lamp. He had shown a lens made on the same formula before, but this one had the mirror added.

The thanks of the meeting were unanimously voted to Mr. Nelson for his exhibits and the interesting descriptions given.

The proceedings then terminated with the usual conversazione.

The eggs of <i>Hemerophila abruptaria</i> ... ..	Mr. A. W. Dennis.
Foraminifera from south-west of Ireland ...	Mr. A. Earland.
The embryos of <i>Planorbis</i> ... ..	Mr. A. E. Hilton.
<i>Proales wernecki</i> (male and female) ...	Mr. C. F. Roussetlet.
<i>Cynips longipennis</i> ... ..	Mr. C. Turner.

---

JULY 2ND, 1897.—CONVERSATIONAL MEETING.

Rotifers inside <i>Volvox</i> ... ..	Mr. W. Goodwin.
The eye of <i>Aphrophora spumaria</i> ... ..	Mr. A. E. Hilton.
Sponge spicules from Oamaru ... ..	Mr. A. J. Jenkins.
Markings on the halteres of the blow-fly ...	Brigade-Surgeon J. B. Scriven.
<i>Isthmia enervis</i> growing on Algae ... ..	Mr. C. Sidwell.
The head of <i>Ocypus olens</i> ... ..	Mr. C. Turner.

## JULY 16TH, 1897.—CONVERSATIONAL MEETING.

Dead rotifer—swarming with Bacteria ...	Mr. W. Goodwin.
<i>Saturnia pavonia minor</i> , antenna of ...	Mr. A. E. Hilton.
<i>Pinus sylvestris</i> , long, radial section ...	Mr. C. Sidwell.
Aquatic larva, head of, showing brushes on mandibles ... .. .	Mr. C. Turner.

---

## SEPTEMBER 3RD, 1897.—CONVERSATIONAL MEETING.

Egg of Chalk-hill-blue butterfly, laid upon its own wing ... .. .	Mr. A. W. Dennis.
Various diatoms ... .. .	Mr. W. Goodwin.
Hair from Fitchett ... .. .	Mr. J. T. Holder.
Leaf of <i>Echinosperrum lappula</i> ... .. .	Mr. G. Sidwell.

---

## SEPTEMBER 17TH, 1897.—CONVERSATIONAL MEETING.

Seeds of <i>Malachium aquaticum</i> , <i>Lychnis</i> <i>flosculi</i> , <i>Nigella</i> sp. ... .. .	Mr. A. W. Dennis.
Chelifer <i>latreille</i> , alive ... .. .	Mr. H. E. Freeman.
Florescules ... .. .	Mr. W. Goodwin.
Larva of Goat-Moth, Foot of ... .. .	Mr. A. E. Hilton.
Earwig, Mouth of... .. .	Mr. J. T. Holder.
Rings in Mica, exhibiting differences in aperture of a low and wide-angled $\frac{1}{4}$	Mr. W. R. Traviss.
<i>Coscinodiscus elegans</i> ... .. .	Mr. C. Sidwell.

---

## OCTOBER 1ST, 1897.—CONVERSATIONAL MEETING.

Sea Buckthorn, <i>Viburnum lantana</i> , leaves of ... .. .	Mr. A. W. Dennis.
Microphotographs by Hardy's Camera ...	Mr. J. D. Hardy.
<i>Corethra Plumicornis</i> ... .. .	Mr. A. E. Hilton.
<i>Triceratium</i> , secondary structure of, with high-power colour illumination ...	Mr. J. Rheinberg.
Rotifers ... .. .	Mr. W. R. Traviss.
Solitary Wasp, head of ... .. .	Mr. C. Turner.



## OCTOBER 15TH, 1897.—ORDINARY MEETING.

J. G. WALLER, Esq., F.S.A., President, in the Chair.

The minutes of the special and ordinary meetings of June 18th were read and confirmed.

The following additions to the library were announced :—

“Science Gossip”—four parts	... From the Editor.
“The Botanical Gazette”	... .. „ „
“Proceedings of the Norfolk and Norwich Naturalists’ Society”	} ... .. „ Society.
“Report of the Plön Biological Station”	.. „ Director.
“The Essex Naturalist”	... .. „ Editor.
“Proceedings of the Geologists’ Association”	... .. } ... .. „ Association.
“Proceedings of the Royal Society”	... .. „ Society.
“The Microscope”	... .. „ Editor.
“Proceedings of the Society of Natural Sciences of Philadelphia”	... .. } ... .. „ Society.
“Journal of the Royal Microscopical Society”	... .. } ... .. „ „
“Annals of Natural History”	... .. Purchased.
“Journal of Microscopy”	

The thanks of the meeting were voted to the donors.

Mr. Hill—for Messrs. Beck—exhibited a new centrifugal apparatus for medical purposes, which was an improvement upon those hitherto used. It was chiefly intended to facilitate the determination of the number of red corpuscles in a given quantity of blood—the tube was of the capacity of 1 cubic centimetre, and this was divided into 100 parts. It was found to run very easily, and to be more effective than anything of the kind in present use.

Mr. Karop said no doubt this would be found very efficient for all purposes for which a centrifuge was of use, in the rapid separation or deposit of particles held in suspension in liquids. It had been found of use in quickly separating urinary deposits; and in this particular form it would no doubt enable any one quickly to estimate the proportionate quantity of red corpuscles in the blood. The price—*i.e.* £6 6s.—was, however, rather prohibitive to the ordinary observer.

Mr. Scourfield said it had been used in America for a variety of other purposes, and had been found very useful in ascertaining the quantity of organisms contained in water from various depths. It had also been used at the fresh-water biological station in Illinois for a similar purpose; and it had been of service in estimating the quantity of food for fishes contained in waters.

Mr. Karop said that a cheaper, but of course inferior, apparatus for the same purpose could be made with a weighted test tube and a piece of string—the string being tied to the neck of the tube and then whirled round. Where the particles were large this would be found perfectly efficient.

Mr. Vezey said it had been suggested to rotate the apparatus by electricity—if this were done no doubt the cost would be reduced, as the mechanism would then be very much simplified.

Mr. Scourfield read a paper “On the Logarithmic plotting of certain Biological data”—a diagram drawn upon the board being used in illustration.

Mr. Rheinberg read a paper “On a New Modification of Double-Colour Illumination.”

Mr. Goodwin inquired if both the colour discs were in the same plane.

Mr. Rheinberg said that was so, and that by moving the iris diaphragm any modification of the two colours could be obtained.

Mr. R. T. Lewis read a “Note on *Peripatus Moseleyi*,” compiled from communications received from the Rev. J. R. Ward, of Richmond, Natal. A specimen in a tube of glycerine, and a coloured drawing of the animal, were exhibited in illustration.

Mr. Ingpen hoped it might be possible to obtain some mounted portions or dissections of this creature for exhibition under the microscope, as they would be very valuable and interesting. He had been reading the section of the “Cambridge Natural History” referred to, and had found it exceedingly interesting.

Mr. Lewis said he had some hope of receiving some mounted specimens of the very young individuals, and he had also the promise of some examples of the New Zealand species. These had, however, not yet come to hand, but if they were received later on he should be very pleased to bring them up to one of the meetings for exhibition.

The thanks of the Club were unanimously voted to the readers of the several papers.

Mr. Vezey—the Treasurer of the Club—intimated that his address had recently been altered from 21 to 17, Mincing Lane.

The Secretary announced the meetings for the ensuing month, also the *soirées* of the Ealing and the Croydon Microscopical Societies; and the proceedings terminated with the usual *conversazione*.

<i>Brachionus mulleri</i>	...	...	...	Dr. J. W. Measures.
Diatom, illustrating note on double colour illumination	...	...	...	Mr. J. Rheinberg.
<i>Vespa vulgaris</i> , ♂, sexual organs of	...	...	...	Mr. C. Turner.

---

## QUEKETT MICROSCOPICAL CLUB.

LIST OF OBJECTS EXHIBITED AT THE CONVERSAZIONE HELD AT  
QUEEN'S HALL, MAY 4TH, 1897.

<i>Plumatella repens</i> . . . . .	Mr. J. Mason Allen.
<i>Melicerta conifera</i> . . . . .	" "
Scales and hairs of insects arranged as a vase of flowers, 309 pieces . . . .	Mr. F. W. Watson Baker.
Wing case of Brazilian diamond beetle	Mr. W. Barnes.
Young oysters . . . . .	" "
Volcanic ash with jasper . . . . .	Mr. Edward Bartlett.
Section of fossil palm, from Australia	" "
Familiar wild flowers—daisy, buttercup, and nettle . . . . .	Messrs. R. & J. Beck, Ltd.
Fungus. Mould grown on gum and sugar	" "
Fracture of steel bicycle spindle . . .	" "
<i>Cordylophora lacustris</i> . . . . .	Mr. A. W. Bird.
<i>Sertularia pumila</i> . . . . .	" "
An early stage of the sea cray-fish . .	Mr. E. T. Browne.
<i>Philodina roseola</i> . . . . .	Mr. David Bryce.
<i>Fredericella sultana</i> . . . . .	Mr. Wm. Burton.
<i>Lophopus crystallinus</i> . . . . .	" "
<i>Paludicella Ehrenbergi</i> . . . . .	" "
Social rotifers— <i>Conochilus volvox</i> . .	" "
Tube-building rotifers— <i>Melicerta conifera</i>	" "
Free-swimming rotifers—various . . .	" "
<i>Triton cristatus</i> , young of, showing circu- lation of blood in branchiæ . . . . .	" "
Silver precipitate (electro) . . . . .	Mr. H. B. Chamberlin.
Group of diatoms. . . . .	Mr. Arthur Cottam.
Eggs of house-fly . . . . .	Mr. T. R. Croger.
Eggs of butterflies, etc. . . . .	" "
Diatoms . . . . .	Mr. Curties.
<i>Isthmia</i> . . . . .	" "

Leg of bee, comb used to clean antennæ	Mr. Curties.
Moss insect (Ceylon) . . . . .	” ”
Palate of <i>Trochus</i> . . . . .	” ”
Hippuric acid, polariscope . . . . .	Mr. Alfred W. Dennis.
Palate of <i>Haliotis tuberculata</i> . . . . .	” ”
<i>Staphylococcus pyrogenes citreus</i> . . . . .	Mr. G. P. Dineen.
Foraminifera from various localities . . . . .	Mr. A. Earland.
<i>Phloothrips coriacea</i> (tickler) . . . . .	Mr. F. Enock.
Living <i>Alaptus fusculus</i> , fairy fly, length $\frac{1}{72}$ inch, bred from eggs of <i>Psocus</i> . . . . .	” ”
Palate of <i>Haliotis tuberculata</i> . . . . .	Mr. H. Epps.
” <i>Trochus ziziphinus</i> . . . . .	” ”
Cirrhi of barnacle . . . . .	Mr. H. E. Freeman.
Calcite showing interference images . . . . .	” ”
Micro-photograph—Marriage of Her Majesty the Queen . . . . .	” ”
Hairs of caterpillar of vapourer moth . . . . .	” ”
<i>Leptothrix stagnalis</i> , in fruit . . . . .	Mr. W. Goodwin.
<i>Nitella opaca</i> , showing cyclosis . . . . .	Mr. Hy. Groves.
Cyclops with parasitic epistylis . . . . .	Mr. W. Hainworth.
The Chromatoscope, invented by Mr. Hardy in 1887 . . . . .	Mr. J. D. Hardy.
Head of saw-fly— <i>Trichiosoma lucorum</i> . . . . .	Mr. F. W. Hembry.
Calyx of thyme, showing oil-glands . . . . .	” ”
Australian quartz . . . . .	Mr. George Hind.
Cyclosis in <i>Anacharis alsinastrum</i> . . . . .	Mr. Alfred E. Hilton.
<i>Clava multicornis</i> . . . . .	Mr. E. Hinton.
<i>Tubularia</i> . . . . .	” ”
<i>Pennaria cavolina</i> . . . . .	” ”
<i>Lophopus crystallinus</i> . . . . .	Mr. J. T. Holder.
Head of <i>Chalasia argentata</i> (India) . . . . .	Mr. J. E. Ingpen.
<i>Evplectella</i> , showing rosettes on epi- dermis . . . . .	” ”
The Queen and Royal Family in 1842 . . . . .	” ”
Sponge spicules, with coloured illumi- nation . . . . .	Mr. A. J. Jenkins.
Sponge spicules, from Oamaru, with coloured illumination . . . . .	” ”
Echinital spines, with coloured illumi- nation . . . . .	” ”

Stridulating organs of male grasshopper . . . . .	Mr. R. T. Lewis.
Auditory organs of female grasshopper . . . . .	" "
A living house-fly ( <i>Musca domestica</i> ), showing head, antennæ, compound and simple eyes, also proboscis in act of sucking honey . . . . .	Mr. R. Macer.
Pollen— <i>Lilium longifolium</i> . . . . .	Mr G. E. Mainland.
<i>Polyxenes lagurus</i> . . . . .	" "
Flower of forget-me-not . . . . .	" "
"    woodruff . . . . .	" "
"    red dead-nettle . . . . .	" "
<i>Drosera rotundifolia</i> . . . . .	Dr. J. W. Measures.
Section of Cementstein, from Jutland . . . . .	Mr. H. Morland.
<i>Rutilaria capitata</i> , valve and four cohering frustules . . . . .	" "
Head of a wasp, showing mouth organs. Mounted without pressure . . . . .	Mr. C. Muiron.
Photo-micrographs of diatoms . . . . .	" "
The microbe of the Indian plague × 2000 diameters . . . . .	Mr. E. M. Nelson.
<i>Radiolaria</i> from the <i>Challenger</i> soundings . . . . .	Mr. J. Neville.
<i>Pedicellaria</i> . . . . .	" "
White-nettle flower, showing pollen . . . . .	Mr. Frank Orfeur.
Tartaric acid . . . . .	" "
<i>Perophora listeri</i> . . . . .	Mr. F. A. Parsons.
Larva of <i>Corethra plumicornis</i> . . . . .	Mr. T. Plowman.
Fungus of ringworm . . . . .	Mr. J. Pollard.
Carious tooth . . . . .	" "
Wing of small tortoiseshell butterfly . . . . .	Mr. C. S. Poulter.
Cyclosis in <i>Vallisneria spiralis</i> , with $\frac{1}{10}$ -inch apochromatic water-immersion objective . . . . .	Mr. T. H. Powell.
<i>Volvox globator</i> , with $1\frac{1}{2}$ -inch apochromatic objective . . . . .	" "
<i>Comatricha friesiana</i> , showing the "capillitium" or framework. Wall of sporangium and spores blown away . . . . .	Mr. J. W. Reed.

<i>Dictydium cernuum</i> . Showing the "capillitium" or framework, the outer wall of the sporangium and spores having been blown away. The stem becomes very weak near the apex of the sporangium, so that the latter may be easily swayed by mites and other minute creatures, who thus become dusted with spores and effect distribution . . . . .	Mr. J. W. Reed.
Drawings and microscopic preparations kindly lent by G. Masee, Esq., Cryptogamist, Royal Botanic Gardens, Kew . . . . .	" "
Fern spores . . . . .	Mr. Frederic Reeve.
Wild thyme . . . . .	" "
Diatoms with colour ground illumination	Mr. J. Rheinberg.
Rotifers. Life in pond water . . . .	Mr. C. Rousselet.
Rotifers. Mounted . . . . .	" "
Clothes moth, <i>Tinea pellionella</i> . . . .	Mr. J. Russell.
Egg case of " " . . . . .	" "
<i>Scapholeberis (Daphnia) mucronata</i> , and the surface-film of water . . . . .	Mr. D. J. Scourfield.
<i>Fredericella sultana</i> . . . . .	Mr. C. J. H. Sidwell.
Mycetozoa. <i>Arcyria punicea</i> . . . . .	Mr. J. Slade.
" <i>Stemonitis fusca</i> . . . . .	" "
" <i>Trichia verrucosa</i> . . . . .	" "
Duodenum of cat, injected . . . . .	Mr. W. Smart.
Diamond beetle . . . . .	" "
Bouquet of scales . . . . .	" "
<i>Bostrychia scorpoides</i> , showing tetra- spores . . . . .	Mr. Alpheus Smith.
Leucite in lava— <i>Rieden Eifel</i> . . . .	Mr. George J. Smith.
Dolerite (altering lias), Portrush, Antrim . . . . .	" "
<i>Axonu versicolor</i> . . . . .	Mr. C. D. Soar.
Deep-sea soundings . . . . .	Mr. A. T. Spriggs.
Section of paint from Spitalfields door, showing 33 coats. Age of door, 150 years . . . . .	Mr. Alfred W. Stokes.

Platino-cyanide of magnesium . . . . .	Mr. M. E. Swan.
Foraminifera (Jersey) . . . . .	Mr. M. J. Swift.
<i>Melicerta ringens</i> . . . . .	Mr. H. Taverner.
<i>Stephanoceros Eichhorni</i> . . . . .	" "
Butterfly's wing . . . . .	" "
<i>Plumatella repens</i> . . . . .	Mr. Charles Turner
The whole of the second chapter of St. John's Gospel written in the $\frac{1}{20000}$ of a square inch. The whole Bible written in the same size would occupy less than one square inch . . . . .	Mr. J. J. Vezey.
Scales from wings of butterflies arranged as a bouquet . . . . .	" "
Forget-me-not . . . . .	Mr. Charles West.
Insect captured by carnivorous plant . . . . .	" "
Section of eye of drone-fly . . . . .	" "
Artificial crystals of hydroquinone . . . . .	Mr. T. Charters White.
<i>Cedrus libani</i> , 3000 years old, from palace at Nineveh . . . . .	Mr. B. W. Williams.
Lianus—Brazil . . . . .	" "
<i>Stephanoceros Eichhorni</i> . . . . .	Mr. Edwin Wooderson.
Longitudinal section of a cat's tongue, showing recurved papillæ . . . . .	Mr. Ernest Woodley.

---



## NOTICE OF RECENT BOOK.

THROUGH A POCKET LENS. By Henry Scherren, F.Z.S. London :  
R.T.S., pp. 192, and 90 illustrations. Price 2s 6d.

In this, his latest work, Mr. Scherren has done much to instil the advantage of a thorough practical use of the pocket lens in the mind of a budding naturalist, and to show him how large an amount of real information may be acquired by an intelligent use of simple apparatus, costing but a few shillings. As, of course, the field of application of a hand magnifier is unlimited, the author has wisely chosen one division of the animal kingdom for his subject—viz., the *Arthropoda*—and in the small compass of about 190 duodecimo pages he has compressed a quantity of detail on the structure, habits, and general life-histories of illustrative genera and species of insects, crustaceans and spiders. The book is one to buy and present to all one's young relatives who show any taste whatsoever for natural science.









1



2



4



3



6



8



5



9



7

10



14



12



8



11



13



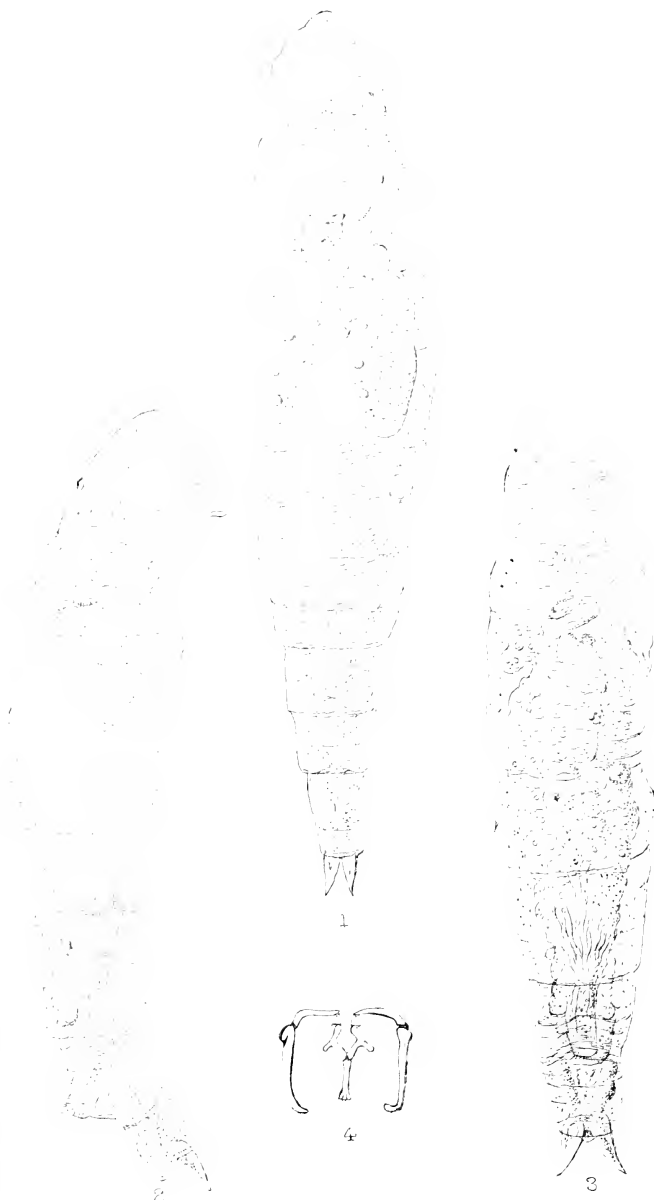

E. R. Dixon & H. T. Tuttle & C. F. F. Coueslet del. & nat.

West, Newman lith.

Proles Wernecki.











# INDEX.

		PAGE
A.		
Abbe condenser. Swift . . . . .	41	
Abbe - Czapski drawing apparatus . . . . .	155	
Achromatic Bull's eye . . . . .	441	
<i>Aleurodes</i> . R. T. Lewis . . . . .	88	
"    R. T. Lewis . . . . .	159	
<i>Alga</i> . W. Goodwin . . . . .	54	
Amician Test. G. C. Karop . . . . .	79	
Andrew, F. W. <i>Challenger</i> dredgings . . . . .	299	
Annual Report, 1894 . . . . .	59	
"    "    1895 . . . . .	235	
"    "    1896 . . . . .	377	
Aquatic <i>Hymenoptera</i> . W. Burton . . . . .	148	
"    "    F. Enock . . . . .	275	
<i>Aulacodiscus gigas</i> . L. Miles . . . . .	295	
B.		
Bacillus of chicken cholera . . . . .	170	
Bacteria in Thames. Shadbolt . . . . .	159	
Baker's portable microscope . . . . .	296	
Beck's binocular microscope . . . . .	446	
"    centrifuge . . . . .	449	
Binocular microscope. E. E. Hill . . . . .	446	
<i>Bonnemaisonia Hamifera</i> . Buffham . . . . .	177	
Books, reviews of 172, 258, 396, . . . . .	457	
<i>Brachionus Bakeri</i> . Rousselet . . . . .	328	
"    Rousselet . . . . .	369	
Buffham, T. H. " <i>Bonnemaisonia Hamifera</i> " . . . . .	177	
"    " <i>Florideae</i> . . . . .	183	
"    "    May water . . . . .	43	
"    "    New seaweed . . . . .	219	
"    "    Death of . . . . .	229	
"    "    In Memoriam . . . . .	210	
Bull's eye, achromatic . . . . .	441	
"    doublet . . . . .	293	
Burton, W. Aquatic Insect . . . . .	148	
C.		
Camera drawings. E. M. Nelson . . . . .	296, 359	
" <i>lucida</i> . E. M. Nelson . . . . .	39	
Cement, Spirit-proof. C. F. Rousselet . . . . .	149, 167	
Centrifuge, Beck's . . . . .	449	
<i>Challenger</i> dredgings. F. W. Andrew . . . . .	299	
Chicken cholera. C. J. Pound . . . . .	170	
<i>Cladocera</i> , Olfactory Setae. D. J. Scourfield . . . . .	280, 304	
Coloured illumination. J. Rheinberg . . . . .	346, 364, 438, 450	
Colour stop, Swift's . . . . .	364	
Committee, Annual Report of: . . . . .		
1894 . . . . .	59	
1895 . . . . .	235	
1896 . . . . .	377	
Conversion Table (Metrical) . . . . .	263	
Curtis. T. C. Quick-changing adapter . . . . .	215	
<i>Cysticercus</i> , infection of ducks with. T. B. Rosseter . . . . .	397, 440	
"    of <i>Tenia Liophallus</i> . . . . .	314	
" <i>Venusta</i> . . . . .	305	
"    New Species . . . . .	362	
D.		
De Toni, Dr. G. B., on T. H. Buffham . . . . .	210	
<i>Diatomaceae</i> , fossil. Dr. A. M. Edwards . . . . .	1	
Diatom structure. Dr. Tatham . . . . .	441	
"    "    E. M. Nelson . . . . .	444	
<i>Diplöis Trigona</i> . C. F. Rousselet . . . . .	119	
Discussion on E. M. Nelson's Camera <i>lucida</i> . . . . .	46	
"    on Dr. Edwards' paper on Fossil Diatoms . . . . .	50	
"    on G. C. Karop's paper on Amician Test . . . . .	155	
"    on E. B. Green's paper: on Root Hairs . . . . .	156	
"    on A. Merliu's paper on <i>Pulvillus</i> of Fly . . . . .	159	
"    on W. Burton's paper on <i>Polynema Natans</i> . . . . .	163	

	PAGE		PAGE
Discussion on J. E. Ingpen's paper on <i>Ithomia</i> Scales . . . . .	164	<i>Entomostraca</i> . D. J. Scourfield	127, 171
.. on J. W. Reed's paper on Pyrenean Flora	167	Errors in camera drawings . . . . .	289
.. on J. E. Ingpen's paper on Scent Hairs of Insects . . . . .	219	Evolution of microscope . . . . .	349
.. on R. T. Lewis' paper on Stridulating Organs . . . . .	294	Excursions, Objects found at :	
.. on W. H. Nunney's paper on Discs on Stigmal Veins . . . . .	296	1894 . . . . .	63
.. on Surgeon Gunson Thorp's remarks on Rotifers . . . . .	301	1895 . . . . .	240
.. on E. M. Nelson's paper on Camera Drawings . . . . .	297, 360	1896 . . . . .	382
.. on T. B. Rosseter's paper on <i>Tenia</i> . . . . .	362	F.	
.. on W. Stokes' paper on Images in Mirrors . . . . .	364	Fish bones. Prof. C. Stewart . . . . .	47
.. on J. Rheinberg's paper on Coloured Illumination . . . . .	365	<i>Floridæ</i> . T. H. Buffham . . . . .	183
.. on C. F. Rousset's paper on <i>Brachionus Bakeri</i> . . . . .	369	<i>Floesularia Trijdidlobata</i> . G. M. Pittock, M.B. . . . .	77, 155
Dissecting binocular. Dr. Tatham . . . . .	206, 222	Foot of house-fly. A. Eliot Merlin . . . . .	146, 348
Donation from South London Microscopical Society . . . . .	157	<i>Foraminifera</i> . A. Earland . . . . .	406, 446
.. from C. F. Rousset . . . . .	215, 358	G.	
.. from Misses Harman . . . . .	222	Gay, F. W., Death of . . . . .	158
Drawing camera . . . . .	39	Goodwin, W. An <i>Alga</i> . . . . .	54
Drawing instrument. Dr. Measures . . . . .	155	" " Small lamp . . . . .	216, 359
Drawings, correcting camera . . . . .	296, 359	Green, E. B. Root hairs . . . . .	83, 292
Drawings of root hairs. E. B. Green . . . . .	161	" " Drawings of root hairs . . . . .	161
Dunlop, M. F. <i>Metopidia Pterygoidu</i> . . . . .	325, 368	H.	
Durham, A. E., F.R.C.S., Death of . . . . .	162	Half-inch Objective, Swift's . . . . .	155
E.		Harly, J. D., on Melicerta . . . . .	220
Earland, A. <i>Foraminifera</i> . . . . .	406, 446	Harman, Misses, donation . . . . .	222
Edwards, Dr. A. M. Fossil Diatoms . . . . .	1	Hill, E. E., Binocular microscope . . . . .	446
Enock, F. Aquatic <i>Hymenoptera</i> . . . . .	295	" " Nachet portable microscope . . . . .	155
.. <i>Prestwichia Aquatica</i> . . . . .	275	" " Beck's centrifuge . . . . .	449
		Hinton, E., portable lamp . . . . .	345
		<i>Hydrachnidæ</i> . C. D. Soar . . . . .	318, 362
		<i>Hymenoptera</i> . aquatic. F. Enock . . . . .	295
		I.	
		Illuminating objects. G. C. Karop . . . . .	278, 297
		Illumination, coloured. J. Rheinberg . . . . .	346, 364, 438, 450
		Infection of ducks. T. B. Rosseter . . . . .	397, 440
		Ingpen, J. E., <i>Ithomia Diasia</i> . . . . .	96
		" " Scent hairs . . . . .	219
		In Memoriam. F. Kitton . . . . .	152
		" " T. H. Buffham . . . . .	210
		<i>Ithomia Diasia</i> . J. E. Ingpen . . . . .	96
		" " W. H. Nunney . . . . .	99
		K.	
		Karop, G. C. Amician Test . . . . .	79
		" " Illuminating Objects . . . . .	278, 297
		" " On <i>Myxozoa</i> . . . . .	292

	PAGE		PAGE
Karop, G. C. Presentation to	373	Microscope, folding. Swift	215
"    " Reichert's micro-	218	"    Nacher's portable	155
"    " Swift's coloured	358	"    Swift's portable	224
"    " Swift's coloured	364	"    Van Heurck	41
"    " stop	364	Microscopes. Ross	42
Keevil, Mr. Photomicrographs	160	Microtome, Reichert's	218
Kitton, F. In Memoriam	152	Miles, L. <i>Aulacodiscus gigas</i>	295
		Minute diatom structure. E. M. Nelson	429
L.		Mirrors, multiple images in. W. B. Stokes	322, 364
Lamp, Nelson-Dallinger. Swift	162	<i>Mycetozoa</i> , G. C. Karop on	292
"    Small. W. Goodwin	216	"    J. Slade	433, 444
Leitz' new $\frac{1}{10}$ . 1.30 N.A.	446	N.	
Lewis, R. T. <i>Aleurodes</i> n. sp. 88,	159	Nacher's portable Microscope. E. E. Hill	155
"    " <i>Peripatus Moseleyi</i>	450	<i>Navicula Major</i> . E. M. Nelson	144
"    " Stridulating Organ	271	Nelson, E. M. Achromatic bull's-eye	441
Light filters. W. Stokes	440	"    " Baker's portable microscope	296
List of objects found at Excur-	63	"    " Bull's-eye doublet	293
"    " found at Excur-	240	"    " Camera lucida	39
"    " found at Excur-	382	"    " Diatom structure	429, 444
"    " exhibited at conver-	451	"    " Errors in camera drawings	289, 296, 359
List of Officers and Committee :		"    " Evolution of microscope	349
1895 . . . . .	76	"    " Leitz' $\frac{1}{10}$ , 1.30 N.A.	446
1896 . . . . .	230	"    " Lens-mirror loup	161, 166
1897 . . . . .	397	"    " <i>Navicula major</i>	144, 156
Logarithmic plotting of data. D. J. Scourfield	419, 449	"    " New lenses	366
Loup, lens-mirror. E. M. Nelson	161, 166	"    " Optical rule	208
"    triple achromatic. E. M. Nelson	228	"    " Photomicrographs	447
Low-power illumination. G. C. Karop	297	"    " President's Address	1895 . . . . . 14 1896 . . . . . 191
M.		"    " Screens	51
Marryat, G. Photomicrographs	160	"    " Swift's portable microscope	224
"    " Death of	229	Notices of Books	172, 258, 396, 457
May-water. T. H. Buffham	43	Nunney, W. H. <i>Ithomia</i>	99
Measures, Dr. Drawing Instrument	155	"    " Discs on Stigmal Veins of Fly	296
<i>Melicerta</i> . J. D. Hardy	220	O.	
Merlin, A. A. C. E. Foot of house-fly	146, 348	Objective, Half-inch. Swift	155
"    " <i>Pulvillus</i> of fly	370	"    " $\frac{1}{10}$ . 1.3 N.A. Leitz	446
<i>Metopidia Pterygoida</i> . M. F. Dunlop	325, 368	Objects found at Excursions	1894 63 1895 240 1896 382
Metrical conversion Table	263	"    " exhibited at Con-	452
Microscope, Baker's portable	296	"    " sazione 1897	452
"    " binocular, Beck's	446	Officers and Committee for	1895 76 1896 230
"    " cheap substage for	167	"    "    "    "	1896 230
"    " dissecting	222		
"    " evolution of	349		
"    " folding. R. Smith	215		

	PAGE		PAGE
Officers and Committee for 1897	397	Quick-changing adapter. C. L.	
Olfactory Setæ of <i>Cladocera</i> , 280,	304	Curties . . . . .	215
Optical Rule. E. M. Nelson	208		
Orfeur, Combination substage	227		
		P.	
<i>Peripatus Moseleyi</i> . Rev. J. R.			
Ward	424		
"    "    R. T. Lewis	450		
Photographic Camera lens	161		
Photomicrographs. H. Keevil	160		
"    "    G. Marryat	160		
"    "    E. M. Nelson	447		
"    "    J. Terry	159		
"    "    T. C. White	228		
Pittock, G. M. <i>Floscularia</i>			
<i>Trifidlobata</i> . . . . .	77, 155		
Pond drag. Swift	45		
Portable lamp. E. Hinton	345		
Portable microscope, Baker's	296		
"    "    Beck's	446		
"    "    Nacht's	155		
"    "    Swift's	215, 224		
"    "    Van Heurck	41		
Pound, C. J. "Chicken Cholera"	170		
"    "    President of Royal			
"    "    Society of Queensland	440		
Presentation to Mr. G. C. Karop	373		
President Royal Society of			
Queensland, Mr. C. J. Pound	440		
President's Address, 1895. E. M.			
Nelson	14		
"    "    1896. E. M.			
"    "    Nelson	191		
"    "    1897. J. G.			
"    "    Waller	333		
<i>Prestwichia Aquatica</i> . F. Enock	275		
<i>Proales Wernecki</i> . C. F. Rous-			
selet . . . . .	415, 446		
Proceedings, Oct., Nov., Dec.,			
1894; Jan., Feb.,			
1895 . . . . .	40		
"    March, April, May, June,			
"    July, Aug., Sept.,			
"    Oct., 1895 . . . . .	154		
"    Oct., Nov., Dec., 1895;			
"    Jan., Feb., 1896 . . . . .	214		
"    March, April, May, June,			
"    July, Aug., Sept., 1896	291		
"    July, Sept., Oct., Nov.,			
"    Dec., 1896; Jan., Feb.,			
"    1897 . . . . .	357		
"    March, April, May, June,			
"    July, Aug., Sept., Oct.,			
"    1897 . . . . .	439		
<i>Pulvillus</i> of fly. A. Eliot			
Merlin . . . . .	370		
Pyrenean plants. J. W. Reed	105		
		Q	
		R.	
Randell, G. Sounding apparatus	163		
<i>Rattulus Collaris</i> . C. F.			
Rousselet . . . . .	265, 291		
Reed, J. W. Pyrenean plants	105		
Report of Committee for 1894	59		
"    "    1895 . . . . .	235		
"    "    1896 . . . . .	377		
"    "    of Treasurer for 1894	62		
"    "    1895 . . . . .	239		
"    "    1896 . . . . .	381		
Resolution of diatoms, 156, 441,	444		
Rheinberg, J. Coloured illumina-			
tion . . . . .	346, 364, 438, 450		
Root hairs, drawings of	161		
"    "    growths on. E. B.			
"    "    Green . . . . .	83, 292		
Ross. Microscopes . . . . .	42		
Rosseter, T. B. <i>Cysticercus</i>			
<i>Venusta</i> . . . . .	305		
"    " <i>Cysticercus</i>			
"    "    of <i>Tenia</i> . . . . .	314		
"    "    Infection of			
"    "    ducks 397, 440			
"    "    Newspecies			
"    "    of <i>Tenia</i> . . . . .	362		
Rotatoria, Preserving. C. F.			
Rousselet . . . . .	5, 54		
Rotifers. C. F. Rousselet 119, 170,	265		
"    Chinese. Surgeon			
"    Gunson Thorpe . . . . .	299		
Rotifer, A new. M. F. Dunlop	325		
Rousselet, C. F. <i>Brachionus</i>			
<i>Bakeri</i> 328, 369			
"    "    Cement, spirit-			
"    "    proof . . . . .	149, 167		
"    " <i>Diplöis Trigoua</i>			
"    "    . . . . .	119, 170		
"    "    Donation of			
"    "    mounted Ro-			
"    "    tifers . . . . .	215		
"    "    New Rotifers . . . . .	170		
"    "    Preserving Ro-			
"    "    tatoria . . . . .	5, 54		
"    " <i>Proales Wer-</i>			
"    " <i>necki</i> . . . . .	415, 446		
"    " <i>Rattulus Col-</i>			
"    " <i>laris</i> . . . . .	265, 291		
Royal Society of Queensland	440		
		S.	
Scale of <i>Ithomia</i> . J. E. Ingpen	96		
"    "    W. H. Nunney	99		
Scent hairs. J. E. Ingpen	219		

	PAGE		PAGE
Scourfield, D. J., on <i>Entomostraca</i>	127, 171	Swift, J. Nelson - Dallinger lamp	. 162
"    "    Logarithmic plotting of Data	. 419, 450	"    Pond drag	. . 45
"    "    Olfactory Setæ	280, 304	T.	
Screens. E. M. Nelson	. 51	Table of Metrical Conversions	. 263
Sea-water fowl. W. P. Shadbolt	94, 159	<i>Tænia Liophallus, Cysticercus</i>	of 314
Seaweed. New. T. H. Buffham	219	"    "    New Species. T. B. Rosseter	. . 362
Shadbolt, W. P. Foul seawater	. . 94, 159	Tatem, J. G., donation by the nieces of	. . 222
Slade, J., on <i>Mycetozoa</i>	. 433, 444	Tatham, Dr. Diatom structure	441
Smith, R. Folding microscope	. 215	"    "    Dissecting binocular	. . 222, 206
Soar, C. D. <i>Hydrachnidæ</i>	318, 362	Terry, J. Photomicrographs	. 159
Sounding apparatus. G. Randell	163	Thorpe, Surg. V. Gunson, R.N. Chinese Rotifers	. . 299
South London Microscopical Society	. . 157	Treasurer's Report for 1894	. 62
Stewart, Prof. C. Fish bones	. 47	"    "    1895	. 239
Stigmal veins, discs on. W. H. Nunney	. . 296	"    "    1896	. 381
Stokes, W. B. Multiple images in mirrors	322, 364	Triple Achromatic loup.	. . 228
"    "    Light filters	. 440	W.	
Stridulating Organ. R. T. Lewis	271	Waller, J. G., President's Address	333
Substage, Cheap. Watson	151, 167	Ward, Rev. J. R. <i>Peripatus Moseleyi</i>	. . 424
"    Combination. F. Orfeur	227	Watson & Sons. Cheap substage	151, 167
Swift, J. Abbe condenser	. 41	"    "    Van Heurck microscope	. 41
"    Coloured illuminator	358	White, T. C. Exhibition of photomicrographs	. . 228
"    Colour stop	. 364		
"    Folding microscope	215, 224		
"    Half-inch objective	. 155		





Adv # 64627  
28/4/95  
DLH

# THE JOURNAL OF THE QUEKETT MICROSCOPICAL CLUB.

EDITED BY  
EDWARD M. NELSON, F.R.M.S

*(It will be understood that the Authors alone are responsible for the views and opinions expressed in their papers.)*

## CONTENTS.

PAPERS.		PAGE
Dr. A. M. EDWARDS.	Fossil Diatomaceæ . . . . .	1
C. F. ROUSSELET, F.R.M.S.	Preserving Rotatoria . . . . .	5
EDWARD M. NELSON, F.R.M.S.	The President's Address . . . . .	14
NOTE.		
EDWARD M. NELSON, F.R.M.S.	A New Camera Lucida . . . . .	39
PROCEEDINGS.		
	From October 5th, 1894, to February 15th, 1895, inclusive . . . . .	40
	Report of Committee . . . . .	59
	Report of Treasurer . . . . .	62
	Objects found at Excursions . . . . .	63
OFFICIAL.		
	List of Members . . . . .	i
	List of Exchanges . . . . .	xx
	Rules . . . . .	xxiii

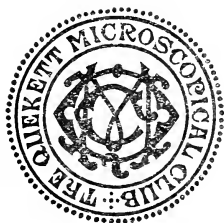

London :

[PUBLISHED FOR THE CLUB]

WILLIAMS AND NORGATE,  
14, HENRIETTA STREET, COVENT GARDEN, LONDON,  
AND 20, SOUTH FREDERICK STREET, EDINBURGH.

47

# M E E T I N G S

OF THE

## QUEKETT MICROSCOPICAL CLUB,

FOR 1895-6, AT

20, Hanover Square, W.,

ON THE

### FIRST AND THIRD FRIDAYS OF EVERY MONTH.

---

This CLUB was established in 1865 for the purpose of affording to experienced Microscopists, as well as to Students, regular and frequent opportunities of discussing those special subjects in which they are mutually interested, and also for promoting Field Excursions to the well-known collecting districts around the Metropolis.

No Entrance Fee. Annual Subscription, 10s, dating from January 1st.

The ORDINARY MEETINGS are held on the *Third* Friday in each Month, except July and August. Business commences at 8 o'clock.

The meetings on the *First* Friday in each month, and on July 19th and August 16th, are for conversation and for the exhibition of objects, from 7 to 9.30 p.m.

---

1895.	Friday, March	...	...	1	...	15
	" April	...	...	5	...	19
	" May	...	...	3	...	17
	" June	...	...	7	...	21
	" July	...	...	5	...	19
	" August	...	...	2	...	16
	" September	...	...	6	...	20
	" October	...	...	4	...	18
	" November	...	...	1	...	15
	" December	...	...	6	...	20
1896.	" January	...	...	3	...	17
	" February	...	...	7	...	21*
	" March	...	...	6	...	20

---

\* The ANNUAL GENERAL MEETING will be held on the Third Friday in February of each year, at 8 o'clock, for the Election of Officers and other Business.









MBL/WHOI LIBRARY



WH 18X5 A

