

LIBRARY OF  
THE NEW YORK BOTANICAL GARDEN

*Purchased*  
1915

September 1899 R. W. Gibson - Invt.

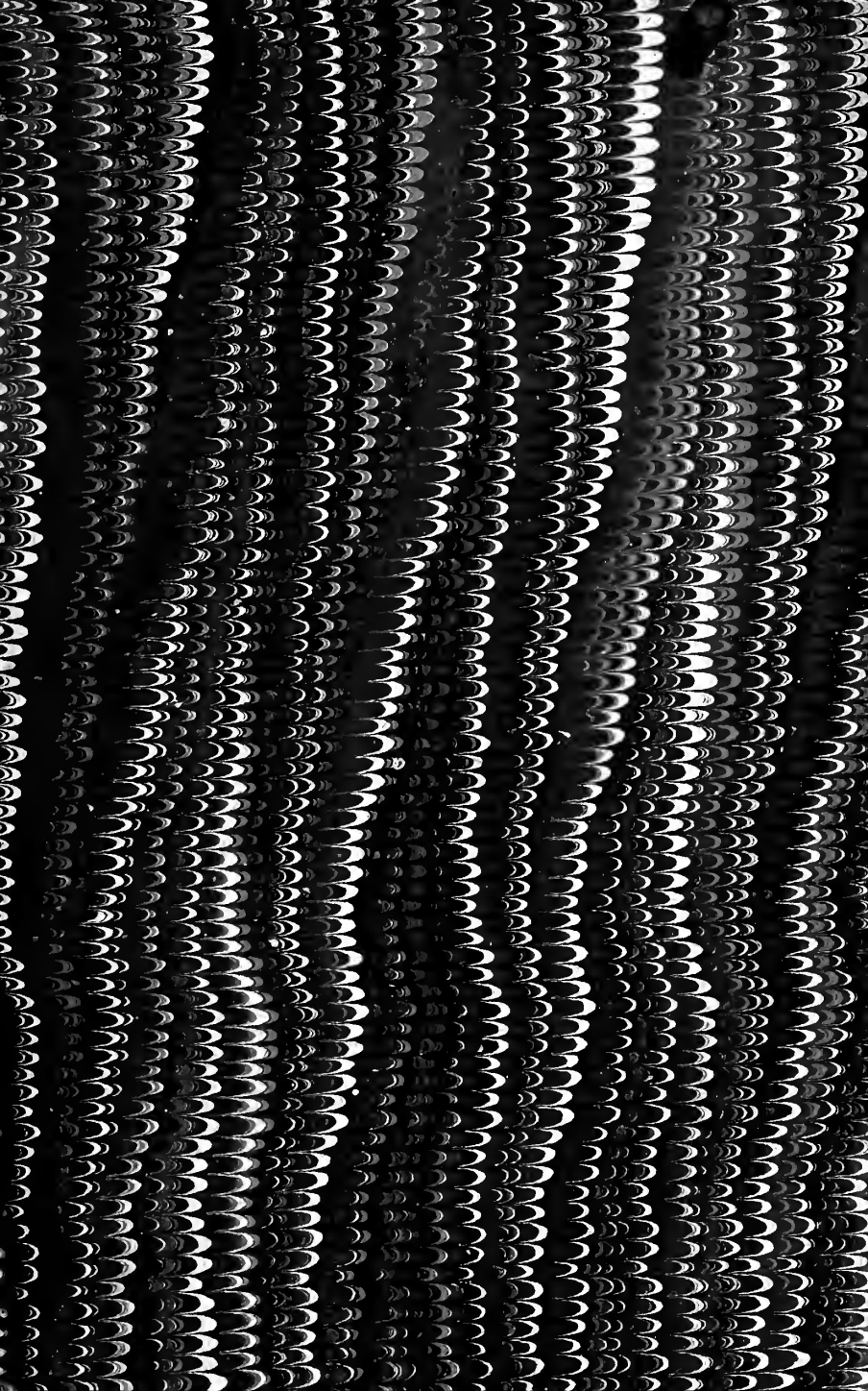











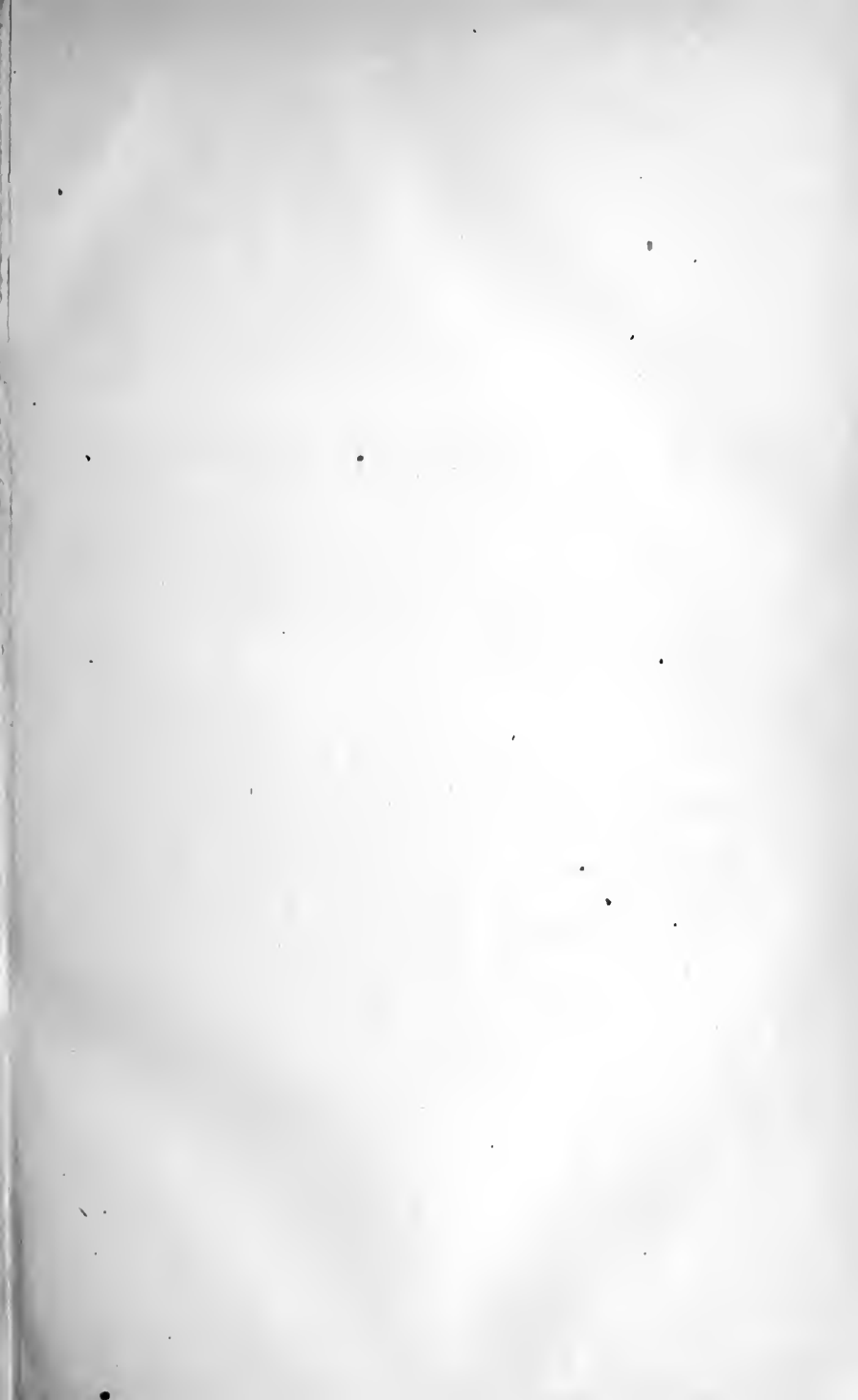



8  
THE

JOURNAL *Pat*

OF THE

ROYAL AGRICULTURAL SOCIETY

OF ENGLAND.

SECOND SERIES.

VOLUME THE FOURTEENTH.

---

PRACTICE WITH SCIENCE.

---

LIBRARY  
NEW YORK  
BOTANICAL  
GARDEN

LONDON:

JOHN MURRAY, ALBEMARLE STREET.

1878.

.0933  
Vol 14.  
2nd series

THESE EXPERIMENTS, IT IS TRUE, ARE NOT EASY; STILL THEY ARE IN THE POWER OF EVERY THINKING HUSBANDMAN. HE WHO ACCOMPLISHES BUT ONE, OF HOWEVER LIMITED APPLICATION, AND TAKES CARE TO REPORT IT FAITHFULLY, ADVANCES THE SCIENCE, AND, CONSEQUENTLY, THE PRACTICE OF AGRICULTURE, AND ACQUIRES THEREBY A RIGHT TO THE GRATITUDE OF HIS FELLOWS, AND OF THOSE WHO COME AFTER. TO MAKE MANY SUCH IS BEYOND THE POWER OF MOST INDIVIDUALS, AND CANNOT BE EXPECTED. THE FIRST CARE OF ALL SOCIETIES FORMED FOR THE IMPROVEMENT OF OUR SCIENCE SHOULD BE TO PREPARE THE FORMS OF SUCH EXPERIMENTS, AND TO DISTRIBUTE THE EXECUTION OF THESE AMONG THEIR MEMBERS.

VAN TRAEER, *Principles of Agriculture.*



# CONTENTS OF VOLUME XIV.

## SECOND SERIES.

STATISTICS:—	PAGE
Meteorology for the year 1877 .. .. .	I-IX
Imports of Corn, &c., British Wheat sold, and Average Prices	X-XIV
Number of Beasts exhibited, and Prices realised for them at the Christmas Markets, 1843-77 .. .. .	XV
Average Prices of British Wheat, &c., per Quarter, in each of the Sixteen Years, 1862-77 .. .. .	XV
Acreage under each description of Crop, Fallow, and Grass; with number of Cattle, Sheep, and Pigs in Great Britain and Ireland, 1875, 1876, and 1877 .. .. .	XVI, XVII
Importations and Average Prices of certain Foreign and Colonial Productions .. .. .	XVIII
Statistics of Dairy Produce, and Prices Current .. .. .	XIX, XX

## PART I.

ARTICLE	
I.—Arterial Drainage and the Storage of Water. By W. H. Wheeler, Mem. Inst. C.E., Boston, Lincolnshire .. .. .	1
II.—On Bats' Guano. By Dr. Augustus Voelcker, F.R.S., Con- sulting Chemist to the Society .. .. .	60
III.—Exmoor Reclamation. By Samuel Sidney .. .. .	72
IV.—Report on the Farm-Prize Competition in the Isle of Man, 1877. By S. D. Shirriff, of Saltcoats, Drem, N.B. .. .. .	97
V.—Report on the Implements at the Royal Agricultural Society's Show at Liverpool; and on the Trials of Self-binding Reapers at Aigburth. By J. Hannam, of Pocklington, Yorkshire .. .. .	103
VI.—Early Fattening of Cattle, especially in the Counties of Sussex and Surrey. By Henry Evershed .. .. .	152
VII.—Report on the Pathological Anatomy of Pleuro-Pneumonia. By Gerald F. Yeo, Professor of Physiology in King's College, London .. .. .	169
VIII.—Reclamation of Bog and Moorland in Galway. By Charles Gay Roberts, of Haslemere, Surrey .. .. .	206
IX.—Report on the Health of Animals of the Farm in 1877. By W. Duguid, F.R.C.V.S., Veterinary Inspector to the Society .. .. .	233

MAR 1 1878

ARTICLE	PAGE
X.—Report of the Field and Feeding Experiments conducted at Woburn, on behalf of the Royal Agricultural Society of England, during the year 1877. (Presented to the Chemical Committee, December 11, 1877) .. .. .	238
XI.—Annual Report of the Consulting Chemist for 1877. By Dr. Augustus Voelcker, F.R.S. .. .. .	246
XII.—Quarterly Reports of the Chemical Committee .. .. .	255
XIII.—Annual Report of the Consulting Botanist for 1877. By W. Carruthers, F.R.S. .. .. .	262
Additions to the Library in 1877 .. .. .	264

---

## PART II.

**MEMOIR on the AGRICULTURE of ENGLAND and WALES, prepared under the direction of the Council of the Royal Agricultural Society of England for the International Agricultural Congress, Paris, 1878 :—**

Editor's Preface .. .. .	269= 3
I.—General View of British Agriculture. By James Caird, C.B., F.R.S. .. .. .	271= 5
II.—English Land Law. By Frederick Clifford and J. Alderson Foote .. .. .	333= 67
III.—Taxation as affecting the Agricultural Interest. By Captain Craige .. .. .	385=119
IV.—Farm Capital. By Elias P. Squarey .. .. .	425=159
V.—Practical Agriculture. By John Algernon Clarke .. .. .	445=179
VI.—Dairy Farming. By John Chalmers Morton. With a Chapter on Pastoral Husbandry. By W. T. Carrington	643=377
VII.—The Cultivation of Hops, Fruit, and Vegetables. By Charles Whitehead, F.L.S., F.G.S. .. .. .	719=453
VIII.—The Agricultural Labourer. By H. J. Little .. .. .	761=495
IX.—The Influence of Chemical Discoveries on the Progress of English Agriculture. By Dr. Augustus Voelcker, F.R.S.	803=537
X.—The Royal Agricultural Society of England. By H. M. Jenkins, F.G.S. .. .. .	855=589
INDEX .. .. .	894=628

N.B.—This part of the Journal has received a double pagination. It is treated as a separate Memoir by means of the italic numerals, which are those referred to in the Index; while the continuous pagination of the Journal, given in the usual Roman numerals, enables it to be bound up with the preceding part as the Volume for the year.

## APPENDIX.

	PAGE
List of Officers of the Royal Agricultural Society of England, 1878 .. .. .	i, xxxvii
Standing Committees for 1878 .. .. .	iii, xxxix
Report of the Council to the General Meeting, December 13, 1877, and May 22, 1878 .. .. .	v, xli
Distribution of Members and Council .. .. .	xii
Half-yearly Cash Account from 1st July to 31st December, 1877, and from 1st January to 30th June, 1878 .. .. .	xiv, xlvi
Yearly Cash Account from 1st January to 31st December, 1877 ..	xvi
Country Meeting Account: Liverpool, 1877 .. .. .	xviii
Bristol Meeting, 1878: Schedule of Prizes, &c. .. .. .	xx
Memoranda of Meetings, Payment of Subscriptions, &c. .. ..	xxxii, ciii
List of Stewards and Judges, and Award of Prizes at Bristol ..	xlviii
Agricultural Education: Examination Papers .. .. .	xciii
Members' Veterinary and Chemical Privileges .. .. .	xxxiii, civ
Members' Botanical and Entomological Privileges .. .. .	xxxvi, cvii

## DIRECTIONS TO THE BINDER.

*Frontispiece*—Diagram Map of England and Wales—to face Title-page of Memoir

The Binder is desired to collect together all the Appendix matter, with Roman numeral folio and place it at the *end* of each volume of the Journal, excepting Titles and Contents, and Statistics, &c., which are in all cases to be placed at the *beginning* of the Volume; the lettering at the back to include a statement of the *year* as well as the *volume*; the first volume belonging to 1839-40, the second to 1841, the third to 1842, the fourth to 1843, and so on.

In Reprints of the Journal all Appendix matter and, in one instance, an Article in the body of the Journal (which at the time had become obsolete), were omitted; the Roman numeral folios, however (for convenience of reference), were reprinted without alteration in the Appendix matter retained.

## ERRATUM IN VOL. XIII.

The Plan of a Farm on p. 478 should have been printed on p. 469, to illustrate the description of the First Prize Farm, viz. "*Netherton, near Aintree, in the occupation of Mrs. Ellen Birch,*" instead of "*Stand Park Farm, in the occupation of Mr. Edward Musker.*"

THE HISTORY OF THE

The history of the world is a vast and complex subject, encompassing the lives and actions of countless individuals and the events that have shaped our planet. From the dawn of civilization to the present day, the human story is one of constant change and evolution. The early days of our species are marked by the struggle for survival in a harsh and unpredictable environment. As we progressed, we developed language, art, and social structures, laying the foundation for the complex societies we know today. The history of the world is not just a record of events, but a reflection of the human condition, showing our capacity for both great achievement and profound suffering. It is a story that continues to unfold, with each generation adding its own chapter to the grand narrative of our existence.



METEOROLOGY; IMPORTATIONS OF GRAIN; SALES OF  
BRITISH WHEAT; PRICES OF CORN AND OTHER  
PRODUCE; AGRICULTURAL STATISTICS; AND STA-  
TISTICS OF DAIRY PRODUCE.



[*The facts are derived chiefly from the Meteorological Reports of Mr. GLAISHER, and the Returns of the BOARD OF TRADE and of the INSPECTOR-GENERAL OF IMPORTS AND EXPORTS.*]

---

METEOROLOGY.—1877.

*First Quarter (January, February, March).*—The meteorology of the quarter was in many respects exceptional. The readings of the barometer were unusually low and the weather stormy; the temperature was high during January and February; rain fell almost continuously, and was especially excessive in January; and the amount of sunshine was remarkably small. Floods generally prevailed in the early part of January; and thunder-storms occurred on 6 days in January, 3 days in February, and 6 days in March. The high temperature which had prevailed with scarcely an exception from the middle of November until the end of the year, continued throughout January and until the 19th February. During the 99 days commencing 13th November and ending 19th February the average daily excess of temperature was equal to  $5^{\circ}1$ ; and the excess during the last 50 of these days, commencing 1st January, was  $6^{\circ}1$ . Between the 20th February and 23rd March, short periods of high and low temperature alternated, but the mean of the 26 days showed a daily defect of  $2\frac{1}{2}^{\circ}$ . The last 8 days of the quarter were uniformly warm, and the average daily excess  $2^{\circ}9$ . The winter of 1876-7 was most exceptionally mild; the mean temperature of the three months, December, January, and February averaging  $43^{\circ}4$ ; this mean exceeded by  $5^{\circ}4$  the average for the corresponding period in 100 years; and the lowest recorded temperature fell below the freezing-point of water on only 12 days during these three months. The mean temperature of the quarter ending March last averaged  $42^{\circ}3$ , and exceeded by  $3^{\circ}6$  the average

for the corresponding period in 106 years, during which there were but six instances of so high a mean temperature for this quarter. In January the mean was  $42^{\circ}7$ , and the excess  $6^{\circ}2$ ; in February  $43^{\circ}5$ , and  $4^{\circ}9$  above the average, whereas the mean fell in March to  $40^{\circ}7$ , and showed a slight defect.

The measured rainfall during the quarter at the Greenwich Observatory was 8.3 inches, and exceeded by 3.3 inches the average amount in the corresponding period of 62 years. In January 4.4 inches of rain were measured, showing an excess of 2.5 inches; in February and March the amounts were 1.7 and 2.2 inches, and the excess 0.2 and 0.6 inch respectively. So far back as 1815 the excessive rainfall of last January was without precedent, although more than 4 inches were measured in the January both of 1828 and of 1868. The rainfall of the three months ending January last was more than double the average amount in 62 years.

*Second Quarter (April, May, June).*—The most noticeable features of the weather in the quarter were the low temperature during the greater part of April and May, and the severe night-frosts early in May; while the temperature of June was considerably above the average. The readings of the barometer ruled low during April and May, while they showed an excess in June. The mean temperature of the quarter at the Royal Greenwich Observatory was  $51^{\circ}9$ , and was  $0^{\circ}4$  below the average for the corresponding period in 106 years. In April the mean temperature was  $45^{\circ}4$  and  $0^{\circ}7$  below the average; in May it was but  $48^{\circ}9$ , and the deficiency  $3^{\circ}6$ . In June, however, the mean was  $61^{\circ}3$ , and showed an excess of  $3^{\circ}1$ . May was but slightly colder than that of 1876, while the mean temperature in June exceeded that of June 1876 by  $2^{\circ}8$ , and was higher than the mean temperature of any June since 1868, when it was  $62^{\circ}0$ .

The measured rainfall of the quarter at the Greenwich Observatory was 5.3 inches, and was half an inch below the average amount in the corresponding period of 62 years. The rainfall of the first six months was 13.6 inches, and exceeded the average amount by 2.8 inches, owing to a marked excess in January and April. In April 3.2 inches were measured, showing an excess of 1.5 inch; in May and June the amounts measured were 1.4 and 0.7 inches, and the deficiency 0.7 and 1.3 inches respectively. Rain was measured at Greenwich on 37 of the 91 days of the quarter; on 20 days of April, 10 of May, and 7 of June. During the 62 years, 1815–76, there were only 7 instances of so small a rainfall in June as that recorded this year; the smallest amount during those years was 0.3 of an inch in June 1849.

The earliest.			The latest.	
Sycamore in leaf,	April 4th,	at Carlisle;	May 26th	at Hull.
Horsechestnut	" 7th	" Osborne;	" 28th	" Hull.
Field elm	" 8th	" Carlisle;	June 3rd	" Hull.
Hawthorn	" 8th	" Helston;	May 25th	" Hull.
Lime	" 18th	" Carlisle;	June 1st	" Hull.
Oak	" 21st	" Strathfield;	" 14th	" Hull.
Hazel	" 22nd	" Hull;	May 30th	" Hull.
Walnut	" 30th	" Carlisle;	June 20th	" Hull.
Common poplar	May 10th	" Oxford;	" 16th	" Hull.
Oriental plane	" 13th	" Oxford;	" 13th	" Hull.
Lilac in blossom,	April 4th	" Helston;	" 22nd	" Llandudno.
Yellow broom	" 9th	" Helston;	" 16th	" Torquay.
Hardy pear	" 12th	" Oxford;	May 14th	" Hull.
Cherry	" 13th	" Oxford;	" 12th	" Carlisle.
Laburnum	" 13th	" Helston;	June 6th	" Hull.
Hardy apple	" 22nd	" Llandudno;	May 20th	" Milltown.
Honeysuckle	May 16th	" Strathfield;	June 27th	" Hull.
Mountain ash	" 17th	" Strathfield;	" 22nd	" Hull.
White broom	" 18th	" Hull;	May 30th	" Milltown.
Wheat in ear,	June 3rd	" Helston;	June 17th	" Osborne.
Oats	" 11th	" Helston;	" 24th	" Cardington.
Wheat in flower,	" 5th	" Weybridge;	" 25th	" Llandudno.
Cuckoo arrived,	April 13th	" Guernsey;	May 13th	" Bernerside.
Swallow	" 12th	" Oxford;	" 6th	" Kelstern.
Nightingale	" 4th	" Oxford;	April 9th	" Strathfield.

*Third Quarter (July, August, September).*—Excepting a period of genial weather from 13th to 21st August, the temperature throughout the quarter was low, chilly, and unpleasant, especially from the 15th to 25th September. The mean readings of the barometer were below the average in July and August, but showed an excess in September. The mean temperature of the quarter at the Royal Observatory, Greenwich, was  $58^{\circ}5$ , and  $1^{\circ}2$  below the average for the corresponding period in 106 years. The mean differed but slightly from the average either in July or August, but the mean in September was as low as  $52^{\circ}9$ , and showed a deficiency of  $3^{\circ}7$ . The mean temperature of September was lower than that of any September since 1803; between 1770 and 1804, however, there were 4 instances of a mean temperature for September lower than that which prevailed in the September of 1877.

The measured rainfall of the quarter at the Greenwich Observatory was 6.4 inches, and was an inch below the average amount in the corresponding period of 62 years. The rainfall in the first nine months of this year was 20 inches, and exceeded the average by 1.8 inch, owing principally to the marked excess in January and April. In July and August the rainfall was 2.4 and 2.9 inches respectively, differing but slightly from the average amounts; in September the rainfall only measured 1.1 inch, which was less

than half the average amount. Rain was measured at Greenwich on 41 days during the quarter, of which 15 were in July, 17 in August, and 9 in September. Only nine times since 1815 has the rainfall in September been so small as that in the present year.

Oats were in flower, on the 7th of July at Llandudno. Wheat was in ear, on the 1st of July at Oxford. Barley was in ear, on the 3rd of July at Strathfield Turgiss. Oats were in ear, on the 1st of July at Strathfield Turgiss. Rye was in ear, on the 1st of July at Oxford.

Oats were cut, on the 25th of July at Oxford, on the 20th of August at Llandudno, and on the 25th at Kelstern Grange.

Wheat was cut, on the 1st of August at Guernsey, on the 7th at Oxford, on the 8th at Cardington, on the 13th at Torquay, on the 17th at Llandudno, and on the 21st at Kelstern Grange.

Barley was cut, on the 18th of August at Cardington, on the 20th at Oxford, on the 24th at Llandudno, and on the 30th at Torquay.

Horse-chestnut was divested of leaves, on the 27th of September at Helston. Hawthorn was divested of leaves, on the 20th of September at Helston.

Woodcock arrived, on the 26th of September at Helston. Swallow departed on the 20th of September from Stonyhurst.

*Fourth Quarter (October, November, December).*—The month of October opened fine and dry, with a low temperature. On the 14th there was a severe gale, causing great destruction of property all over the country. The storm seems to have raged throughout Devonshire and Cornwall with great fury, and caused there a great deal of damage. After this day, to the end of the month, the weather was generally fine. The month of November was for the most part cloudy and wet, with very few bright days; the changes both of temperature and atmospheric pressure were rapid. On the 11th there was a very heavy gale of wind, and the barometer reading on this day was the lowest in the year. The month of December was very dark, and almost sunless, with fog and damp weather prevalent. Till the 9th of October the direction of the wind was mostly from the N. or E., or a compound of those winds; and from the 10th of October to the end of the year the wind was almost always from the W., S.W., or S.S.W., to a very unusual degree.

The mean readings of the barometer, in the neighbourhood of London, were in excess of the average in the months of October and December, but below the average in November. The mean temperature of the quarter at Greenwich was 45°·0, which was



1°·5 above the average of 106 years. The mean differed but slightly in October, but in November it was as much as 3°·2 in excess of the average, and in December it was 1°·7 in excess.

The rainfall of the quarter at Greenwich was 6·9 inches, or 0·2 inch below the average amount in the corresponding period of 62 years. The fall of rain in October was 1·7 inch, being 1·1 inch below the average; in November it was 3·4 inches, being 1·1 inch above the average; and in December was 1·8 inch, being 0·2 inch below the average. Back to 1818 there were but 11 instances of so large a fall of rain in November as in the year 1877.

Field elm was divested of leaves on the 2nd of November at Hull; on the 10th at Weybridge; and on the 15th at Guernsey.

Wych elm was divested of leaves on the 22nd of October at Oxford; and on the 30th at Torquay; on the 5th of November at Oxford; and on the 6th at Hull.

Oak was divested of leaves on the 3rd of November at Oxford; on the 15th at Guernsey; and on the 16th at Hull; on the 3rd of December at Torquay.

Lime was divested of leaves on the 25th of October at Guernsey; on the 26th at Oxford; and on the 30th at Weybridge and Hull.

Sycamore was divested of leaves on the 28th of October at Weybridge; on the 1st of November at Hull; and on the 15th at Guernsey.

Horse-chestnut was divested of leaves on the 14th of October at Oxford; on the 26th at Hull; on the 27th at Weybridge; and on the 30th at Guernsey.

Common poplar was divested of leaves on the 26th of October at Oxford; on the 30th at Torquay; and on the 6th of November at Hull.

Occidental plane was divested of leaves on the 17th of November at Hull.

Oriental plane was divested of leaves on the 12th of November at Hull.

Hawthorn was divested of leaves on the 2nd of November at Weybridge; and on the 9th at Hull.

Hazel was divested of leaves on the 9th of November at Hull.

Walnut was divested of leaves on the 8th of November at Hull.

Acacia was in blossom on the 25th of December at Helston.

Fieldfare arrived on the 30th of October at Oxford.

Swallow departed on the 7th of October from Hull; on the 14th from Weybridge.

METEOROLOGICAL OBSERVATIONS RECORDED AT THE ROYAL OBSERVATORY, GREENWICH, IN THE FIRST SIX MONTHS OF THE YEAR 1877.

1877. MONTHS.	Temperature of										Elastic Force of Vapour.		Weight of Vapour in a Cubic Foot of Air.	
	Air.		Evaporation.		Dew Point.		Air—Daily Range.		Water of the Thames.		Mean.	Diff. from average of 36 years.	Mean.	Diff. from average of 36 years.
	Mean. 106 years.	Diff. from average of 36 years.	Mean.	Diff. from average of 36 years.	Mean.	Diff. from average of 36 years.	Mean.	Diff. from average of 36 years.	Mean.	Diff. from average of 36 years.	Mean.	Diff. from average of 36 years.	Mean.	Diff. from average of 36 years.
January ..	42.7	+6.2	41.0	+3.9	39.0	+3.9	11.3	+1.6	43.4	0	0.236	in. +0.035	grs. 2.7	grs. +0.3
February ..	43.5	+4.9	40.9	+3.4	37.8	+2.9	10.9	-0.4	43.1	0	0.227	in. +0.022	grs. 2.6	grs. +0.2
March ..	40.7	-0.4	38.2	-1.0	35.0	-1.4	14.0	-0.6	42.4	0	0.204	in. -0.012	grs. 2.4	grs. -0.2
Means ..	42.3	+3.6	40.0	+2.1	37.3	+1.8	12.1	+0.2	43.0	0	0.222	in. +0.015	grs. 2.6	grs. +0.1
April ..	45.4	-0.7	42.6	-1.5	39.3	-1.3	14.7	-4.0	49.4	0	0.240	in. -0.014	grs. 2.8	grs. -0.2
May ..	48.9	-3.6	44.9	-4.1	40.6	-4.6	17.9	-2.7	52.4	0	0.253	in. -0.047	grs. 2.9	grs. -0.5
June ..	61.3	+3.1	55.3	+0.8	49.9	-0.7	24.5	+3.4	63.5	0	0.360	in. -0.010	grs. 4.1	grs. -0.1
Means ..	51.9	-0.4	47.6	-1.6	43.3	-2.2	19.0	-1.1	55.1	0	0.284	in. -0.024	grs. 3.3	grs. -0.3

NOTE.—In reading this Table it will be borne in mind that the minus sign (-) signifies below the average, and that the plus sign (+) signifies above the average.

METEOROLOGICAL OBSERVATIONS RECORDED AT THE ROYAL OBSERVATORY, GREENWICH, IN THE LAST SIX MONTHS OF THE YEAR 1877.

1877. MONTHS.	Temperature of												Elastic Force of Vapour.		Weight of Vapour in a Cubic Foot of Air.		
	Air.			Evaporation.		Dew Point.		Air—Daily Range.		Water of the Thames.		Mean.	Diff. from average of 36 years.	Mean.	Diff. from average of 36 years.	Mean.	Diff. from average of 36 years.
	Mean.	Diff. from average of 106 years.	Diff. from average of 36 years.	Mean.	Diff. from average of 36 years.	Mean.	Diff. from average of 36 years.	Mean.	Diff. from average of 36 years.	Mean.	Diff. from average of 36 years.	in.	in.	grs.	grs.	grs.	grs.
July .. ..	60.8	-0.8	-1.4	56.3	-1.5	52.4	-1.5	20.7	-0.6	66.4	0.6	0.394	-0.024	4.4	-0.3		
August ..	61.7	+0.8	+0.2	56.8	-0.6	52.6	-1.2	18.9	-1.0	65.9	0.6	0.397	-0.020	4.4	-0.2		
September	52.9	-3.7	-4.4	49.5	-4.6	46.2	-4.9	18.0	-0.5	58.8	0.6	0.313	-0.067	3.6	-0.6		
Means ..	58.5	-1.2	-1.9	54.2	-3.2	50.4	-2.5	19.2	-0.7	63.7	0.6	0.368	-0.037	4.1	-0.4		
October ..	48.6	-0.5	-1.6	45.5	-2.7	42.1	-4.0	17.6	+2.9	52.0	0.6	0.269	-0.045	3.1	-0.6	grs.	grs.
November ..	45.5	+3.2	+1.9	43.5	+2.1	41.2	+1.7	12.7	+1.1	47.6	0.6	0.260	+0.013	3.0	+0.2		
December ..	40.8	+1.7	+0.6	39.2	+0.5	37.1	+0.2	10.0	+0.6	41.4	0.6	0.221	0.000	2.6	0.0		
Means ..	45.0	+1.5	+0.3	42.7	0.0	40.1	-0.7	13.4	+1.5	47.0	0.6	0.250	-0.011	2.9	-0.1		

NOTE.—In reading this Table it will be borne in mind that the minus sign (-) signifies below the average and that the plus sign (+) signifies above the average.

**METEOROLOGICAL OBSERVATIONS RECORDED AT THE ROYAL OBSERVATORY, GREENWICH, IN THE FIRST SIX MONTHS OF THE YEAR 1877.**

1877. MONTHS.	Degree of Humidity.		Reading of Barometer.		Weight of a Cubic Foot of Air.		Rain.		Daily Horizontal movement of the Air.	Reading of Thermometer on Grass.				
	Mean.	Diff. from average of 36 years.	Mean.	Diff. from average of 36 years.	Mean.	grs.	Amount.	Diff. from average of 62 years.		Number of Nights it was				
										At or below 30°.	Between 30° and 40°.	Above 40°.	Lowest Reading at Night.	Highest Reading at Night.
January ..	86	- 1	29·665	- 0·085	547	6	4·4	+ 2·5	Miles. 370	10	16	5	0	42·0
February ..	80	- 5	29·751	- 0·043	548	5	1·7	+ 0·2	408	9	14	5	19·0	46·0
March ..	81	- 1	29·569	- 0·172	543	2	2·2	+ 0·6	307	17	13	1	18·2	42·9
Means ..	82	- 2	29·662	- 0·100	548	4	8·3	+ 3·3	Mean 362	Sum 36	Sum 43	Sum 11	Lowest 18·2	Highest 46·0
April ..	80	+ 2	29·591	- 0·177	543	0	3·2	+ 1·5	Miles. 308	3	21	6	0	43·8
May ..	73	- 3	29·704	- 0·084	541	0	1·4	- 0·7	279	6	9	16	23·0	46·9
June ..	67	- 7	29·843	+ 0·030	530	2	0·7	- 1·3	284	0	6	24	36·5	57·1
Means ..	73	- 3	29·713	- 0·077	538	1	5·3	- 0·5	Mean 290	Sum 9	Sum 36	Sum 46	Lowest 23·0	Highest 57·1

NOTE.—In reading this Table it will be borne in mind that the minus sign (-) signifies below the average, and that the plus sign (+) signifies above the average.

METEOROLOGICAL OBSERVATIONS RECORDED AT THE ROYAL OBSERVATORY, GREENWICH, IN THE LAST SIX MONTHS OF THE YEAR 1877.

1877. MONTHS.	Degree of Humidity.		Reading of Barometer.		Weight of a Cubic Foot of Air.		Rain.		Daily Horizontal movement of the Air.	Reading of Thermometer on Grass.				
	Mean.	Diff. from average of 36 years.	Mean.	Diff. from average of 36 years.	Mean.	Diff. from average of 36 years.	Amount.	Diff. from average of 62 years.		Number of Nights it was			Lowest Reading at Night.	Highest Reading at Night.
										At or below 30°.	Between 30° and 40°.	Above 40°.		
July .. ..	74	- 1	in. 29.747	in. -0.058	grs. 529	grs. + 1	in. 2.4	in. -0.2	Miles. 286	0	4	27	0	55.2
August ..	73	- 3	29.701	-0.093	527	- 2	2.9	+0.5	293	0	2	29	30.5	58.1
September	78	- 3	29.903	+0.101	540	+ 7	1.1	-1.3	241	3	15	12	25.6	57.0
Means ..	75	- 2	29.784	-0.017	532	+ 2	Sum 6.4	Sum -1.0	Mean 273	Sum 3	Sum 21	Sum 68	Lowest 25.6	Highest 58.1
October ..	79	- 8	in. 29.849	+0.151	grs. 544	grs. + 5	in. 1.7	in. -1.1	Miles. 301	9	17	5	0	46.5
November	86	- 2	29.517	-0.233	541	- 7	3.4	+1.1	378	9	14	7	24.4	46.0
December	87	- 1	29.863	+0.072	552	+ 1	1.8	-0.2	301	14	14	3	24.0	41.8
Means ..	84	- 4	29.743	-0.003	546	0	Sum 6.9	Sum -0.2	Mean 327	Sum 32	Sum 45	Sum 15	Lowest 20.3	Highest 46.5

NOTE.—In reading this Table it will be borne in mind that the plus sign (+) signifies above the average, and that the minus sign (-) signifies below the average.

## CORN: IMPORTATIONS, SALES, AND PRICES.

QUANTITIES OF WHEAT, WHEATMEAL and FLOUR, BARLEY, OATS, PEAS and BEANS, IMPORTED into the UNITED KINGDOM in the Year 1877.

1877.	Wheat.	Wheatmeal and Flour.	Barley.	Oats.	Peas.	Beans.
	cwts.	cwts.	cwts.	cwts.	cwts.	cwts.
January ..	2,856,041	567,970	1,195,953	768,825	64,379	236,098
February	2,633,667	397,305	874,886	398,848	57,430	349,900
March ..	3,067,498	561,235	1,328,562	852,281	68,388	601,165
April ..	3,833,983	584,115	1,514,541	599,320	45,058	434,978
May ..	4,752,407	1,078,777	808,324	1,097,234	166,083	342,485
June ..	5,069,928	625,173	751,672	1,609,389	130,211	331,875
In first Six Months } Months	22,213,524	3,814,575	6,473,938	5,325,897	531,549	2,296,501
July .. ..	5,347,361	384,268	604,713	1,811,996	121,572	259,259
August ..	5,090,039	384,867	559,261	1,808,975	64,787	482,523
September	4,036,649	510,301	819,301	1,120,712	64,364	407,338
October ..	6,083,782	710,459	1,325,397	851,003	158,515	447,139
November	6,213,201	690,480	1,317,407	779,744	384,262	347,052
December	5,178,332	874,579	1,870,734	1,227,277	186,797	333,670
In last Six Months } Months	31,949,364	3,554,954	6,496,813	7,599,707	980,297	2,276,981
Year ..	54,162,888	7,369,529	12,970,751	12,925,604	1,511,846	4,573,482

NOTE.—The average weights *per quarter* of corn, as adopted in the office of the Inspector-General of Imports and Exports, are as follow:—For wheat, 485½ lbs., or 4½ cwts.; for barley, 400 lbs., or 3½ cwts.; for oats, 308 lbs., or 2¾ cwts. Corn has been entered by *weight* instead of *measure* since September, 1864. No duty has been charged since 1st June, 1869.

COMPUTED REAL VALUE of CORN IMPORTED into the UNITED KINGDOM in each of the FIVE YEARS, 1873-77.

	1873.	1874.	1875.	1876.	1877.
	£.	£.	£.	£.	£.
Wheat .. .. .	28,446,689	25,201,062	27,418,970	23,140,766	33,820,084
Barley .. .. .	4,010,344	5,266,096	4,630,654	3,745,420	5,396,791
Oats .. .. .	4,804,118	5,118,785	5,407,928	4,619,427	4,998,864
Maize .. .. .	6,621,720	7,484,178	8,112,158	12,744,432	9,851,236
Other kinds .. ..	1,788,716	1,959,237	2,304,218	2,555,397	2,321,922
Wheat Flour .. ..	5,839,197	5,709,820	4,828,167	4,729,206	6,803,327
Other kinds of Flour	10,570	14,405	12,130	15,474	17,284
Total of Corn ..	51,521,354	50,753,583	52,714,225	51,550,122	63,209,508

QUANTITIES of BRITISH WHEAT SOLD in the Towns from which Returns are received under the Act of the 27th & 28th VICTORIA, cap. 87, and their AVERAGE PRICES, in each of the TWELVE MONTHS of the YEARS 1872-77.

		QUANTITIES IN QUARTERS.					
		1872.	1873.	1874.	1875.	1876.	1877.
		quarters.	quarters.	quarters.	quarters.	quarters.	quarters.
First month ..		194,719	183,987	187,106	210,661	154,367	152,557
Second month		193,910	202,977	189,031	223,974	188,539	173,729
Third month	}	245,612	238,125	206,145	292,172	208,367	213,718
(five weeks)							
Fourth month		191,522	159,268	150,725	233,970	160,868	150,012
Fifth month ..		231,780	225,595	175,715	234,683	174,153	132,231
Sixth month	}	268,626	219,750	172,298	216,016	188,611	122,390
(five weeks)							
Seventh month		109,543	101,101	95,871	121,684	90,626	77,674
Eighth month		126,769	96,986	82,564	135,456	88,030	89,759
Ninth month	}	295,774	266,856	323,153	199,314	314,327	225,659
(five weeks)							
Tenth month		264,934	265,122	248,984	226,503	216,393	217,046
Eleventh month		195,743	214,026	225,162	186,607	192,440	175,262
Twelfth month	}	263,152	285,648	335,339	234,035	225,254	212,627
(five weeks)							

		AVERAGE PRICES PER QUARTER.					
		1872.	1873.	1874.	1875.	1876.	1877.
		s. d.	s. d.	s. d.	s. d.	s. d.	s. d.
First month ..		55 4	55 10	62 4	44 4	44 11	51 7
Second month		55 8	56 5	63 4	42 3	43 4	51 8
Third month	}	55 1	55 6	61 1	41 2	43 1	51 1
(five weeks)							
Fourth month		54 2	54 10	60 0	43 0	44 11	53 4
Fifth month ..		56 3	55 8	62 2	42 5	45 0	65 10
Sixth month	}	58 11	58 4	61 2	42 2	47 0	64 6
(five weeks)							
Seventh month		58 7	59 6	60 8	45 3	48 6	62 9
Eighth month		59 9	60 1	58 4	52 4	46 4	64 11
Ninth month	}	58 7	63 10	48 11	49 3	46 8	59 1
(five weeks)							
Tenth month ..		58 7	60 10	44 8	46 1	46 7	53 7
Eleventh month		56 11	60 9	43 11	47 4	48 0	52 3
Twelfth month	}	56 7	61 6	44 6	46 4	49 9	51 6
(five weeks)							



AVERAGE PRICES of BRITISH CORN per Quarter (Imperial measure) as received from the INSPECTORS and OFFICERS of EXCISE according to the Act of 27th & 28th VICTORIA, cap. 87, in each of the FIFTY-TWO WEEKS of the YEAR 1877.

Week ending	Wheat.		Barley.		Oats.		Week ending	Wheat.		Barley.		Oats.	
	s.	d.	s.	d.	s.	d.		s.	d.	s.	d.	s.	d.
January 6..	51	2	38	9	24	7	July 7..	61	5	35	6	27	10
January 13..	51	3	39	0	24	8	July 14..	62	3	34	7	28	10
January 20..	51	11	39	7	24	11	July 21..	63	0	32	5	28	0
January 27..	52	3	39	11	24	10	July 28..	64	6	39	0	27	10
February 3..	52	7	40	7	25	8	August 4..	65	6	35	5	28	7
February 10..	52	3	40	3	25	4	August 11..	65	8	34	7	27	4
February 17..	51	0	40	3	24	9	August 18..	64	9	32	9	27	10
February 24..	51	1	40	4	25	7	August 25..	63	10	33	9	28	4
March 3..	50	11	40	0	26	3	September 1	62	0	34	6	27	5
March 10..	51	4	40	8	25	11	September 8	60	6	39	0	28	5
March 17..	51	3	40	8	26	5	September 15	59	0	40	1	27	2
March 24..	51	2	41	3	24	9	September 22	57	6	43	8	25	10
March 31..	51	1	41	4	24	6	September 29	56	5	43	11	25	3
Average of Winter Quarter	51	4	40	2	25	2	Average of Summer Quarter	62	0	36	10	27	7
April 7..	51	5	41	11	25	5	October 6..	55	11	44	2	24	6
April 14..	52	4	40	0	24	11	October 13..	52	2	43	6	23	9
April 21..	53	9	41	4	24	10	October 20..	52	9	42	6	23	5
April 28..	55	10	40	6	25	8	October 27..	53	7	42	4	23	8
May 5..	60	6	40	5	27	6	November 3	53	8	42	4	24	2
May 12..	65	7	39	7	26	10	November 10	52	5	43	3	24	6
May 19..	68	9	39	11	29	0	November 17	51	8	43	8	24	9
May 26..	68	6	37	9	28	1	November 24	51	5	44	0	24	0
June 2..	66	11	36	2	27	2	December 1	51	7	44	2	24	11
June 9..	65	0	36	6	27	7	December 8	51	4	44	1	23	10
June 16..	64	1	34	7	26	1	December 15	51	7	44	0	24	0
June 23..	64	0	36	11	26	2	December 22	51	4	43	3	23	11
June 30..	62	6	33	11	28	9	December 29	51	9	43	0	23	4
Average of Spring Quarter	61	5	38	5	26	9	Average of Autumn Quarter	52	4	43	4	24	0



QUANTITIES of WHEAT, BARLEY, OATS, PEAS, BEANS, INDIAN CORN or MAIZE, WHEATMEAL and FLOUR, IMPORTED in the FOUR YEARS 1874-77; also the COUNTRIES from which the WHEAT, WHEATMEAL, and FLOUR were obtained.

	1874.	1875.	1876.	1877.
Wheat from—	cwts.	cwts.	cwts.	cwts.
Russia .. .. .	5,714,488	9,995,295	8,769,260	10,838,000
Denmark .. .. .	167,286	493,599	262,518	73,812
Germany .. .. .	3,053,680	5,615,984	2,324,148	5,455,763
France .. .. .	300,299	1,296,920	293,350	1,494,783
Turkey and Wallachia and Moldavia .. .. .	659,676	1,308,137	1,238,851	1,253,018
Egypt .. .. .	293,880	2,093,853	2,218,227	2,447,709
United States .. .. .	23,048,552	23,463,910	19,299,785	21,308,667
Chili .. .. .	1,925,334	900,880	982,619	736,011
British India .. .. .	1,076,876	1,334,943	3,279,887	6,104,940
British North America .. .. .	3,807,174	3,604,610	2,417,151	2,912,178
Other countries .. .. .	1,432,215	1,678,262	3,308,356	1,538,007
<b>Total Wheat</b> .. .. .	<b>41,479,460</b>	<b>51,786,393</b>	<b>44,394,152</b>	<b>54,162,888</b>
Barley .. .. .	11,335,396	11,049,476	9,770,075	12,970,751
Oats .. .. .	11,387,768	12,435,888	11,204,588	12,925,604
Peas .. .. .	1,808,980	1,603,033	1,609,997	1,511,846
Beans .. .. .	2,363,151	3,453,371	4,601,206	4,573,482
Indian Corn, or Maize .. .. .	17,693,625	20,438,480	39,958,226	30,455,681
Wheatmeal and Flour from—				
Germany .. .. .	751,366	796,301	930,469	1,239,437
France .. .. .	659,568	1,752,079	1,083,447	1,900,213
United States .. .. .	3,290,235	2,273,846	2,320,886	1,771,558
British North America .. .. .	389,355	358,766	282,053	254,695
Other countries .. .. .	1,139,084	867,697	1,325,685	2,203,626
<b>Total Wheatmeal and Flour</b> .. .. .	<b>6,229,608</b>	<b>6,048,689</b>	<b>5,942,540</b>	<b>7,369,529</b>
Indian Corn Meal .. .. .	8,511	7,494	7,706	9,713

The AVERAGE PRICES of Consols, of Wheat, of Meat, and of Potatoes; also the AVERAGE NUMBER of PAUPERS relieved on the *last day* of each Week; and the MEAN TEMPERATURE in each of the Twelve Quarters ending December 31st, 1877.

Quarters ending	AVERAGE PRICES.						PAUPERISM.		Mean Temperature
	Consols (for Money).	Minimum Rate per Cent. of Discount charged by the Bank of England.	Wheat per Quarter in England and Wales.	Meat per lb. at the Metropolitan Meat Market (by the Carcass).		Potatoes (York Regents) per Ton, at Waterside Market, Southwark.	Quarterly Average of the Number of Paupers relieved on the <i>last day</i> of each week.		
				Beef.	Mutton.		In-door.	Out-door.	
1875	£.		s. d.						0
Mar. 31	92 <sup>6</sup> / <sub>8</sub>	3·70	42 6	5d.—8d. Mean 6½d.	4¾d.—8d. Mean 6½d.	{ 81s. 3d.— 111s. 3d. } Mean 96s. 3d.	146,708	622,652	39·5
June 30	93 <sup>6</sup> / <sub>8</sub>	3·50	42 6	5¼d.—8¼d. Mean 6¾d.	5½d.—9¼d. Mean 7½d.	{ 80s. 6d.— 120s. 6d. } Mean 100s. 6d.	131,717	592,362	53·4
Sept. 30	94 <sup>3</sup> / <sub>8</sub>	2·43	49 0	5¼d.—8¾d. Mean 7d.	5½d.—9¼d. Mean 7¾d.	{ 70s. 6d.— 93s. 6d. } Mean 82s.	125,614	555,429	60·7
Dec. 31	94 <sup>3</sup> / <sub>8</sub>	3·20	46 7	5¼d.—8¼d. Mean 6¾d.	6d.—9¼d. Mean 7½d.	{ 105s. 6d.— 127s. 6d. } Mean 116s. 6d.	136,124	546,251	43·1
1876									
Mar. 31	94 <sup>1</sup> / <sub>8</sub>	4·18	43 8	5¼d.—8d. Mean 6¾d.	5¾d.—9d. Mean 7½d.	{ 121s. 6d.— 151s. } Mean 136s. 6d.	145,088	558,026	39·8
June 30	95 <sup>4</sup> / <sub>8</sub>	2·24	45 1	5d.—8¾d. Mean 6¾d.	5d.—10d. Mean 7½d.	125s.—170s. Mean 147s. 6d.	134,357	535,419	51·7
Sept. 30	95 <sup>7</sup> / <sub>8</sub>	2·00	47 1	5¾d.—8¾d. Mean 6¾d.	5¾d.—9¾d. Mean 7¾d.	..	130,349	517,196	61·8
Dec. 31	95 <sup>3</sup> / <sub>8</sub>	2·00	48 2	4¼d.—8d. Mean 6¾d.	5¾d.—9d. Mean 7¾d.	..	141,907	514,739	47·0
1877									
Mar. 31	95 <sup>7</sup> / <sub>8</sub>	2·00	51 4	4¼d.—7¾d. Mean 6¾d.	5d.—9¾d. Mean 7½d.	138s.—172s. Mean 155s.	152,778	532,697	42·3
June 30	94 <sup>7</sup> / <sub>8</sub>	2·96	61 5	4¼d.—8¾d. Mean 6¾d.	4¾d.—9¾d. Mean 7d.	136s.—174s. Mean 155s.	143,674	523,878	51·9
Sept. 30	95 <sup>1</sup> / <sub>8</sub>	2·45	62 0	4¼d.—8¾d. Mean 6¾d.	4¾d.—9¾d. Mean 7¾d.	97s.—126s. Mean 111s. 6d.	139,211	509,110	58·5
Dec. 31	96 <sup>2</sup> / <sub>8</sub>	4·50	52 4	3¾d.—8d. Mean 5¾d.	4¾d.—8¾d. Mean 6¾d.	152s.—174s. Mean 163s.	151,709	512,286	45·0

The annexed Return shows the number of Beasts exhibited and the prices realised for them at the Christmas markets since 1843 :—

Year.	Beasts.			Year.	Beasts.		
		s.	d.			s.	d.
1843	4,510	4	0—4	1861	8,840	3	4—5
1844	5,713	4	0—4	1862	8,430	3	4—5
1845	5,326	3	6—4	1863	10,372	3	6—5
1846	4,570	4	0—5	1864	7,130	3	8—5
1847	4,282	3	4—4	1865	7,530	3	4—5
1848	5,942	3	4—4	1866	7,340	3	8—5
1849	5,765	3	4—4	1867	8,110	3	4—5
1850	6,341	3	0—3	1868	5,320	3	4—5
1851	6,103	2	8—4	1869	6,728	3	6—6
1852	6,271	2	8—4	1870	6,425	3	6—6
1853	7,037	3	2—4	1871	6,320	3	10—6
1854	6,181	3	6—5	1872	7,560	4	6—6
1855	7,000	3	8—4	1873	6,170	4	4—6
1856	6,748	3	4—5	1874	6,570	4	4—6
1857	6,856	3	4—4	1875	7,660	4	6—6
1858	6,424	3	4—5	1876	7,020	4	4—6
1859	7,560	3	6—5	1877	7,510	4	6—6
1860	7,860	3	4—5				

AVERAGE PRICES OF BRITISH WHEAT, BARLEY, and OATS, per IMPERIAL QUARTER, in each of the SIXTEEN YEARS 1862-77.

Year.	Wheat.	Barley.	Oats.	Year.	Wheat.	Barley.	Oats.
	s. d.	s. d.	s. d.		s. d.	s. d.	s. d.
1862	55 5	35 1	22 7	1870	46 10	34 7	22 10
1863	44 9	33 11	21 2	1871	56 10	36 2	25 2
1864	40 2	29 11	20 1	1872	57 0	37 4	23 2
1865	41 10	29 9	21 10	1873	58 8	40 5	25 5
1866	49 11	37 5	24 7	1874	55 9	44 11	28 10
1867	64 6	40 0	26 1	1875	45 2	38 5	28 8
1868	63 9	43 0	28 1	1876	46 2	35 2	26 3
1869	48 2	39 5	26 0	1877	56 9	39 8	25 11

**ACREAGE under each Description of CROP, FALLOW, and GREAT BRITAIN and**

DESCRIPTION of CROPS and LIVE STOCK.	GREAT BRITAIN.		
	1875.	1876.	1877.
<b>CORN CROPS :—</b>	Acres.	Acres.	Acres.
Wheat .. .. .	3,342,481	2,995,957	3,168,540
Barley or Bere .. .. .	2,509,701	2,533,109	2,417,588
Oats .. .. .	2,664,009	2,798,430	2,754,179
Rye .. .. .	54,903	56,210	60,146
Beans .. .. .	564,181	517,556	497,879
Peas .. .. .	316,375	293,407	311,797
<b>TOTAL CORN CROPS .. ..</b>	<b>9,451,650</b>	<b>9,194,669</b>	<b>9,210,129</b>
<b>GREEN CROPS :—</b>			
Potatoes .. .. .	522,653	502,719	512,471
Turnips and Swedes .. .. .	2,142,698	2,145,573	2,073,455
Mangold .. .. .	361,617	347,889	358,055
Carrots .. .. .	14,936	16,129	15,953
Cabbage, Kohl-rabi, and Rape .. ..	189,733	179,475	182,710
Vetches, Lucerne, and any other crop } (except clover or grass) .. .. }	432,470	380,089	442,202
<b>TOTAL GREEN CROPS .. ..</b>	<b>3,664,107</b>	<b>3,571,874</b>	<b>3,584,846</b>
<b>OTHER CROPS, GRASS, &amp;c. :—</b>			
Flax .. .. .	6,751	7,641	7,481
Hops .. .. .	69,171	69,999	71,239
Bare fallow or uncropped arable land	557,979	651,212	616,147
Clover and artificial and other grasses } under rotation .. .. }	4,354,071	4,540,273	4,493,216
Permanent pasture, meadow, or grass } not broken up in rotation (exclusive } of heath or mountain land) .. .. }	13,313,621	13,515,944	13,728,355
<b>LIVE STOCK :—</b>	No.	No.	No.
Cattle .. .. .	6,012,824	5,844,141	5,697,933
Sheep .. .. .	29,167,438	28,182,951	28,161,164
Pigs .. .. .	2,229,918	2,293,620	2,498,728
Total number of horses used for } agriculture, unbroken horses, } and mares kept solely for } breeding .. .. }	1,340,129	1,374,576	1,388,582
Acreeage of orchard, or of arable or grass- } land, used also for fruit-trees .. .. }	154,584	157,287	163,290
Acreeage of woods, coppices, and plan- } tations .. .. }	2,187,078*	2,187,078*	2,187,078*

\* As returned

## GRASS, and NUMBER of CATTLE, SHEEP, and PIGS, in IRELAND, in 1875-76-77.

IRELAND.			UNITED KINGDOM, including the Islands.		
1875.	1876.	1877.	1875.	1876.	1877.
Acres.	Acres.	Acres.	Acres.	Acres.	Acres.
161,321	119,597	143,319	3,514,088	3,125,342	3,321,065
234,503	221,263	226,603	2,751,362	2,762,263	2,652,300
1,499,371	1,487,086	1,471,698	4,176,177	4,298,722	4,238,957
9,556	8,631	10,441	64,579	64,951	70,703
9,970	10,672	8,584	574,414	528,556	506,701
1,677	1,238	1,202	318,410	295,012	313,470
1,916,398	1,848,487	1,861,847	11,399,030	11,074,846	11,103,196
900,277	880,693	871,522	1,431,879	1,391,885	1,392,784
332,783	344,721	336,201	2,485,256	2,500,425	2,419,296
43,172	48,544	48,753	405,527	397,217	407,518
3,303	3,217	3,503	18,833	19,845	19,943
41,896	40,887	47,006	231,717	220,439	229,786
48,655	45,162	47,868	483,817	427,986	492,364
1,370,086	1,363,224	1,354,853	5,057,029	4,957,797	4,961,691
101,248	132,878	123,362	107,999	140,519	130,846
..	..	..	69,171	69,999	71,239
11,287	11,652	16,678	570,005	663,363	633,495
1,943,923	1,861,464	1,925,168	6,337,953	6,441,184	6,459,404
10,431,776	10,507,249	10,145,227	23,773,602	24,053,273	23,903,314
No.	No.	No.	No.	No.	No.
4,111,990	4,113,693	3,996,027	10,162,787	9,995,028	9,731,537
4,248,158	4,007,518	3,989,178	33,491,948	32,262,579	32,220,067
1,249,235	1,424,143	1,467,999	3,495,167	3,734,429	3,984,447
470,442	479,502	496,165	1,875,851	1,863,410	1,894,128
..	..	..	..	..	..
325,173	324,152	328,413	..	..	..

in 1872.

CERTAIN ARTICLES OF FOREIGN AND COLONIAL PRODUCTION IMPORTED in the YEARS  
1874-77; and their QUANTITIES.

	1874.	1875.	1876.	1877.
<b>ANIMALS, Living:</b>				
Oxen, Bulls, and Cows, number	157,821	224,969	227,478	174,023
Calves .. .. .	36,041	38,729	44,098	30,172
Sheep .. .. .	758,915	985,652	1,041,494	874,062
Lambs .. .. .				
Swine and Hogs.. .. .	115,389	71,928	43,558	20,037
Bones (burnt or not, or as animal chareol).. .. . tons	82,242	97,162	85,135	104,223
Cotton, Raw .. .. . ewts.	13,989,861	13,324,564	13,346,739	12,112,819
Flax .. .. .	2,373,993	1,765,068	1,404,661	2,216,267
Guano .. .. .	112,429	114,454	210,918	152,990
Hemp .. .. .	1,241,115	1,342,466	1,170,728	1,251,458
Hops .. .. .	145,994	256,444	167,421	248,620
Hides untanned: Dry .. .. .	554,964	552,629	469,460	551,547
"    "    Wet .. .. .	711,161	652,634	583,914	594,542
Petroleum .. .. . tuns	85,630	77,661	100,175	134,096
Oilseed Cakes .. .. . tons	157,718	180,379	190,225	163,349
Potatoes .. .. . ewts.	3,986,662	4,696,132	6,031,341	7,969,136
Butter .. .. .	1,619,808	1,467,870	1,659,357	1,637,939
Cheese.. .. .	1,485,265	1,627,748	1,538,475	1,651,088
Eggs .. .. . per great hundred	5,672,049	6,178,433	6,274,924	6,257,892
Lard .. .. . ewts.	374,328	540,244	558,983	592,944
Bacon and Hams .. .. .	2,542,095	2,638,875	3,159,445	2,805,594
Salt Beef .. .. .	231,532	181,504	243,342	208,364
Salt Pork .. .. .	287,238	232,782	350,151	295,524
Clover Seeds .. .. .	256,025	306,551	387,099	358,056
Flax-seed and Linseed .. .. . qrs.	1,682,048	1,961,987	1,998,130	1,712,298
Rape .. .. .	289,046	501,350	499,218	539,263
Sheep and Lambs' Wool .. .. . lbs.	338,800,481	361,133,165	385,987,842	405,949,161

The QUANTITY and VALUE of MEAT IMPORTED in the 6 YEARS, 1872-7.

QUANTITIES.

	1872.	1873.	1874.	1875.	1876.	1877.
	Cwts.	Cwts.	Cwts.	Cwts.	Cwts.	Cwts.
Beef, Salted or Fresh ..	228,912	260,554	261,721	215,581	413,351	673,683
Meat, " " ..	55,354	79,841	119,401	144,954	92,556	135,250
Total.. ..	284,266	340,395	381,124	360,535	505,907	808,933
Meat, Preserved other- wise than by salting }	350,729	260,749	265,223	171,373	283,066	470,712
Total Meat ..	634,995	601,144	646,347	531,908	788,973	1,279,645

VALUES.

	£.	£.	£.	£.	£.	£.
Beef, Salted or Fresh ..	420,258	519,815	523,326	454,337	943,580	1,674,364
Meat, " " ..	138,272	216,681	335,846	419,019	281,830	403,962
Total .. ..	558,530	736,496	859,172	873,356	1,225,410	2,078,326
Meat, preserved other- wise than by salting }	945,819	733,331	757,001	592,196	887,035	1,438,909
Total Meat ..	1,504,349	1,469,827	1,616,173	1,465,552	2,112,445	3,517,235

The quantity of meat imported in 1876 was 788,973 cwts., showing an increase of 257,065 cwts. over that in 1875. In 1877, the quantity was still greater, viz., 1,279,645 cwts., being 490,672 cwts. in excess of that imported in 1876. This largely increased importation of dead meat will probably have the effect of reducing the present high price of butcher's meat. The average price of beef by the carcass at the Metropolitan Meat Market was 6½*d.* in 1876; in 1877 it was 6¾*d.*, or 5·7 per cent. less. The average price of mutton was 7¾*d.* in 1876; in 1877, it was 7*d.*, showing a decrease of 6·7 per cent.

The following remarks relating to Irish and Foreign Butter and to Cheese are extracted from 'The Grocer':—

**IRISH BUTTER.**—The month of January began with prices unusually high, and continued so until nearly the end of March, owing partly to the drought in the summer of 1876, which left smaller quantities on hand than usual, and partly to a wet, cold, and backward spring in 1877.

April commenced with prices for seconds (for firsts were not quoted after March, when they were 125*s.* to 155*s.*) at 115*s.* to 130*s.*, and closed at 116*s.* to 118*s.* In May seconds were quoted at 114*s.* to 117*s.* Cork firsts in June were 125*s.*, and fell at the close of the month to 122*s.* In July firsts were 122*s.* during the first two weeks, but fell to 120*s.* In August the prices for firsts ranged from 119*s.* to 121*s.* In September prices varied from 129*s.* to 135*s.* October began at 130*s.*, and finished at 126*s.* In November the prices for firsts ranged from 123*s.* to 130*s.*, and in December very few firsts came to market, so prices began at 130*s.* to 132*s.*, and in the third week rose to 134*s.* and 137*s.*

**FOREIGN BUTTER.**—The prices of foreign butter were influenced by the same causes that affected Irish butter. The best brands of Normandy were offered the first week in January at 140*s.* to 150*s.*, in the second week they were offered at 148*s.* to 156*s.*, the next seven weeks they were 159*s.* to 160*s.*, and to the middle of March 156*s.* to 164*s.*; at the end of this month they were 140*s.* to 146*s.*, with new supplies coming forward. In April the highest price for best brands was 140*s.* In May prices began at 126*s.* to 136*s.*, but finished at 114*s.* to 118*s.* In June the prices for best fluctuated more, beginning at 118*s.* to 126*s.*, and closing at 120*s.* to 128*s.* The highest price in the first two weeks of July was 124*s.*, then to the middle of August 120*s.*, and rose by the end of this month to 128*s.*, which was the lowest price for best for the rest of the year. Early in September prices for best ranged from 126*s.* to 132*s.*, the next week they were quoted at 134*s.* to 144*s.*, then for four weeks 134*s.* to 140*s.*; the second and third weeks in October they were



136s. to 144s., and in the last week prices for best were 134s. to 140s. In the month of November prices began at 126s. to 132s., the next two weeks they were 128s. to 136s. The top price then to the third week in December was 140s.

CHEESE.—American cheese continued to be a leading article in the market, and the transactions during the year 1877 were large.

Early in January the opening prices for best were 64s. to 68s., lower qualities were 46s. to 60s. During the next five weeks prices for best were quoted at 70s. to 74s., but with stocks gradually reduced prices rose, and were quoted at 72s. to 76s., and afterwards prices for best ruled at from 76s. to 78s. From the middle of April to the end of May quotations for best ranged from 73s. to 76s. By this time some of the new make began to arrive, and prices gave way somewhat rapidly. Thus in the beginning of June prices for best were 68s. to 70s., whereas in the last week of this month they fell to 56s. to 60s. From the beginning of July to 1st September—with the exception of one week—prices were chiefly for best at 55s. to 58s. In September prices for best began at 60s. to 62s., and closed at 62s. to 64s. Early in October prices for best were quoted at 64s. to 66s.; at the close of this month they rose to 66s. and 70s. The year closed with best quality quiet at the latter prices; lower qualities were quoted at 54s. to 64s.

CORK BUTTER MARKET.—This market being now almost entirely dependent on English consumption, has accordingly felt the effects of the general depression of trade in the sister country, and a range of prices lower than for many years past has prevailed. The absence of any advance or fluctuation in price has also been very marked, seconds having been as low in November and December as they were in July and August. No value can be set on the nominal quotation set out for firsts at the close of the year, for, there being none of them making, it is in the power of any interested party, owing to the peculiar constitution of the market, to cause any price, however high, to be put forward as the official quotation for them. A much more reasonable course would be, not to quote a price for what is not making, nor any prospect of being made at this season, and to leave holders of old butter to sell it on its merits as best they may.

The dull and wet summer, though so unfavourable to the harvest, has not acted prejudicially on butter-making, as the supply for 1877 has not only exceeded that of 1876, which was a year of drought, but has surpassed that of 1875, which was the largest on record, as will appear by the following figures:—1875, 433,000 firkins; 1876, 389,000 firkins; 1877, 442,000 firkins.



## STATISTICS OF DAIRY PRODUCE.

*(The following Quotations, &c., are extracted from 'The Grocer.')*

PRICES CURRENT on 1st SATURDAY in JANUARY of each YEAR, from the latest actual MARKET SALES.

	Average Annual Price in the 5 years, 1870-74.	1875.	1876.	1877.	1878.
<b>Butter :</b>	Per cwt.	Per cwt.	Per cwt.	Per cwt.	Per cwt.
Carlow, finest, F.O.B. . . . .	126s. to 136s.	150s. to 160s.	138s. to 148s.	140s. to 150s.	116s. to 132s.
" Landed . . . . .	124 .. 138	.. ..	138 .. 148	.. ..	.. ..
Cork, 1sts. . . . .	138 .. 143	158 .. 160	146 .. 150	150 .. 162	134 .. 137
" 2nds . . . . .	129 .. 135	151 .. 154	136 .. 142	140 .. 148	122 .. 125
" 3rds, new . . . . .	111 .. 116	131 .. 132	110 .. 112	119 .. 120	100 .. 103
" 4ths . . . . .	98 .. 98	115 .. ..	81 .. ..	90 .. 91	72 .. ..
Limerick . . . . .	117 .. 121	.. ..	118 .. 120	130 .. 138	.. ..
<b>Foreign :</b>					
Friesland . . . . .	113 .. 130	136 .. 144	135 .. 140	136 .. 140	132 .. 140
Jersey, &c. . . . .	79 .. 129	94 .. 144	80 .. 136	80 .. 132	124 .. 135
Kiel . . . . .	111 .. 145	135 .. 164	.. ..	.. ..	.. ..
Normandy . . . . .	93 .. 150	110 .. 160	90 .. 162	100 .. 150	100 .. 148
American . . . . .	82 .. 115	112 .. 138	90 .. 118	95 .. 136	60 .. 120
<b>Cheese:</b>					
English Cheddar, fine, new . .	76 .. 90	74 .. 94	74 .. 92	60 .. 94	78 .. 90
" good, new . . . . .	74 .. 93	.. ..	.. ..	.. ..	.. ..
Red Somerset Loaf . . . . .	68 .. 81	78 .. 88	76 .. 86	.. ..	.. ..
White or yellow Cheddar } Loaf . . . . .	72 .. 81	80 .. 88	76 .. 86	.. ..	.. ..
Scotch Cheddar . . . . .	67 .. 77	74 .. 82	64 .. 76	64 .. 80	70 .. 76
Cheshire, new . . . . .	76 .. 87	84 .. 88	76 .. 86	73 .. 90	78 .. 84
" good ditto . . . . .	58 .. 70	70 .. 76	50 .. 70	46 .. 70	60 .. 74
Wiltshire, new . . . . .	67 .. 78	70 .. 82	62 .. 78	74 .. 82	72 .. 78
" good ditto . . . . .	57 .. 64	66 .. 68	.. ..	.. ..	61 .. 70
North Wilts Loaf, new . . . .	66 .. 80	78 .. 88	74 .. 86	.. ..	76 .. 78
Derby . . . . .	65 .. 83	76 .. 88	76 .. 86	80 .. ..	74 .. 78
<b>Foreign :</b>					
American, fine . . . . .	68 .. 73	72 .. 76	62 .. 64	66 .. 72	65 .. 70
" good . . . . .	54 .. 65	50 .. 68	30 .. 58	46 .. 60	54 .. 62
Gouda . . . . .	49 .. 64	52 .. 60	56 .. 62	50 .. 62	56 .. 64
Kanter . . . . .	.. ..	.. ..	.. ..	.. ..	.. ..
Edam, new . . . . .	53 .. 68	54 .. 64	60 .. 70	60 .. 68	60 .. 66

## QUANTITY and VALUE of BUTTER IMPORTED from DENMARK, 1865-76.

Years.	Quantities.	Computed Real Value.	Years.	Quantities.	Computed Real Value.
	Cwts.	£.		Cwts.	£.
1865	65,555	362,440	1871	140,851	803,226
1866	67,305	319,528	1872	173,574	1,009,322
1867	80,589	422,479	1873	201,558	1,203,459
1868	79,437	471,262	1874	226,053	1,363,433
1869	103,613	574,981	1875	206,171	1,275,870
1870	127,013	767,190	1876	205,195	1,311,234

STATEMENT of the QUANTITY and VALUE of BUTTER imported from the UNITED STATES, BELGIUM, FRANCE and HOLLAND; and of CHEESE imported from the UNITED STATES and HOLLAND, 1865-76.

Years.	UNITED STATES.			
	BUTTER.		CHEESE.	
	Quantities.	Computed Real Value.	Quantities.	Computed Real Value.
	Cwts.	£.	Cwts.	£.
1865 ..	83,216	437,703	442,913	1,296,204
1866 ..	16,059	77,754	415,726	1,386,447
1867 ..	39,035	113,290	526,740	2,470,017
1868 ..	7,117	37,279	489,117	1,439,380
1869 ..	17,203	84,603	487,870	1,612,325
1870 ..	16,915	80,928	555,385	1,861,263
1871 ..	83,775	394,359	731,326	2,014,805
1872 ..	45,765	199,679	598,198	1,701,435
1873 ..	43,406	199,639	790,238	2,352,181
1874 ..	36,307	188,769	849,933	2,589,776
1875 ..	40,331	205,900	958,978	2,786,027
1876 ..	118,131	593,122	936,203	2,564,977

Years.	BELGIUM.		FRANCE.	
	BUTTER.		BUTTER.	
	Quantities.	Computed Real Value.	Quantities.	Computed Real Value.
	Cwts.	£.	Cwts.	£.
1865 ..	70,619	433,179	353,115	1,867,085
1866 ..	76,667	426,712	452,196	2,276,493
1867 ..	80,754	470,464	450,693	2,265,147
1868 ..	70,456	405,987	393,578	2,156,824
1869 ..	85,789	481,609	407,432	2,231,450
1870 ..	84,408	516,643	289,692	1,672,899
1871 ..	94,539	523,460	304,683	1,636,006
1872 ..	74,191	409,555	355,089	1,916,795
1873 ..	76,610	439,501	446,550	2,409,861
1874 ..	76,723	465,517	713,251	3,944,233
1875 ..	79,950	499,028	567,560	3,387,219
1876 ..	65,309	419,209	622,488	3,732,405

Years.	HOLLAND.			
	BUTTER.		CHEESE.	
	Quantities.	Computed Real Value.	Quantities.	Computed Real Value.
	Cwts.	£.	Cwts.	£.
1865 ..	345,026	1,886,486	386,962	1,100,037
1866 ..	383,225	1,979,070	426,559	1,317,231
1867 ..	326,217	1,733,459	332,628	961,245
1868 ..	343,322	1,992,414	329,565	959,547
1869 ..	415,176	2,253,420	426,913	1,262,101
1870 ..	406,795	2,388,459	422,553	1,204,830
1871 ..	390,616	1,986,708	348,148	954,236
1872 ..	269,091	1,358,579	329,535	942,537
1873 ..	279,004	1,453,875	336,654	1,013,233
1874 ..	351,605	1,877,755	398,888	1,164,921
1875 ..	357,106	1,917,910	370,123	1,078,594
1876 ..	402,984	2,252,909	330,435	949,413

# JOURNAL

OF THE

## ROYAL AGRICULTURAL SOCIETY OF ENGLAND.

---

I.—*Arterial Drainage and the Storage of Water.* By W. H. WHEELER, Mem. Inst. C.E., Boston, Lincolnshire.

THE question of drainage is one of vital importance to the modern farmer, and has therefore received a very full share of attention in the 'Journal of the Royal Agricultural Society.' Nearly all the articles and discussions, however, have been devoted to the drainage of small areas and to the removal of the rain-water from the land; and with the exception of an article by Mr. J. A. Clark "On Trunk Drainage," in the 'Journal' of the Society for 1854,\* which was principally devoted to a history of some of the large works carried out in the Fen districts, the subject of arterial drainage and the disposal of the water for useful purposes has not been touched.

In a climate like that of England, where the fluctuations of cold and damp seriously affect the health, the rapid removal of the rainfall and consequent improvement of the temperature are most important from a sanitary point of view; and to the proper cultivation of the soil they are an absolute necessity. The manner of removal and the ultimate disposal of the water due to the rainfall are the chief points for consideration. Water is a most useful friend and servant, if kept under proper control. Hitherto it has been too much the custom to treat the rainfall as an enemy to be got rid of as rapidly as possible, instead of endeavouring to control and regulate the supplies, and conserve the superabundance of one season to supply the deficiency of another. It is the stagnation of water in the land that is injurious, and for the prevention of this, drainage is essential. Even in floods, the mere overflowing of the water on the land seldom does any great harm if it be kept moving; but if allowed to become stagnant, it soddens and injures the soil, spoils the herbage, sours

---

\* First Series, vol. xv. p. 1.

the ground, and creates malaria in the neighbourhood. Ague, which used to be the common disease of the Fen districts, has, since the adoption of an improved system of drainage, almost entirely disappeared: its occasional recurrence now only happens during droughts in autumn, when the water is dried up out of the ditches, and the sun, acting on the decaying vegetable matter thus exposed, creates a malarious atmosphere.

Avoiding any reference to ordinary under-drainage by pipes, and to the improvement and management of tidal streams, and other large works which, owing to their magnitude and the great number of interests involved, can only be carried out by public bodies under the guidance of a Civil Engineer, it is proposed in this article to deal with the main drains, ditches, or "sewers," which collect the rainfall from the under-drains, and with the brooks and smaller water-courses, which receive the outflow of the ditches and convey it away to the tidal rivers and estuaries—with such arterial drainage, in fact, as is to be found on all large estates, the improvement and management of which devolves on the landowner and his agent. It is also proposed to give in general terms such information on the theory and practice of drainage as may be of service to those who constitute the various Drainage Boards of the country, in enabling them the better to comprehend plans of improvement which may from time to time be brought before them; and to point out the various uses which the rainfall may serve before it is allowed finally to leave the land for its ultimate destination,—the ocean.

The question of dealing with water-courses is becoming one of growing importance. The higher cultivation of the land on the one hand, and the increase of flooding on the other, render the enhanced loss from the latter cause so serious as to call for interference from the Legislature.

As each proprietor under-drains his fields, and improves the main water-courses through his estate by cutting off bends and adapting the form of the channel to the state most conducive to a rapid flow of the water, the rainfall is more quickly disposed of, and reaches the outfall at a period very much sooner than it was able to do previously. Less water therefore remains in the soil, and there is no longer a supply to keep up the gradual percolation which formerly fed our brooks and springs. Hence the alternate floods and droughts which are now so constantly occurring. To meet this difficulty it is necessary to adapt the channels to receive the extra service required of them in flood-time, and to store up the surplus flood-water for provision during the time of drought.

The divided control and jurisdiction, however, over a main

water-course which passes through several estates belonging to different owners, renders it difficult for the improvements to be carried out universally; and the total neglect on some parts of a stream of all necessary works, such as cutting the weeds and the removal of obstructions in the bed and sides, causes a diminution of the water-way and a consequent obstruction of the channel. To such an extent in some districts has this been allowed to go on, that in a case quoted before the Committee of the House of Lords of last Session, a small tributary river had for several miles diminished one-half in width and silted up one-half in depth, and had become so fouled with weeds, that the bed was being gradually raised above the level of the surrounding country.

To quote the words of a correspondent of the 'Times,' "the condition of the smaller streams of the country is indeed deplorable. Their channels are generally an alternation of weed-choked swamps and nearly impassable rapids, with here and there a rare oasis of deep steady stream, the consequence of the needs of some millowner who does what is right in his own eyes, restrained only by the common-law rights of the neighbours above and below him." Streams in such a condition are ill-adapted to carry off the rapid flow of water due to modern drainage; and the damage by consequent flooding is increased by the neglect to maintain the embankments protecting the lower lands.

The increase in the value of all land, arising from the ever-growing population of the country, has caused large tracts, formerly meadows, which received little damage, or even benefit, from occasional floods, to be converted into arable land, on which a continuous flood means the loss of the present crop, and detriment to the future one by the soddening of the soil. In considering any general scheme, it may become a matter for serious consideration whether it may not be more profitable to throw these low-lying arable lands into grass, and suffer them to be occasionally flooded, than to carry out such an extensive plan of improvement as will protect the lowest lands from winter floods under such exceptional rainfalls as occur only at long intervals.

The almost unanimous testimony of the witnesses examined before the Committee of the House of Lords appointed to inquire into the constitution of existing Conservancy Boards, with reference to the prevention of floods and the storage of water, which sat last Session, was to the effect: "That floods are more frequent and of longer duration in recent times than formerly: That the cause of this is due to the general adoption of subsoil drainage and the improvements in arterial drainage by straightening rivers," &c., whereby the water is brought more rapidly to



the main carrier; also to the condition of the rivers owing to neglect and the want of any general power to raise funds and carry out the necessary works whereby weeds are allowed to accumulate, shoals to arise, and deterioration generally to take place, whereby they are rendered inadequate to carry off the drainage.

The remedy suggested for this is, first, the appointment of a Conservancy Board, fairly representing all interests concerned, who shall have power to deal with the main stream or river from its source to its outfall, leaving the several districts which discharge their water into the river by the tributary streams under the care of bodies already constituted, or to be formed at option under the Land Drainage Act; and, secondly, that the Conservancy Board shall have power to rate the whole area of the watershed, the assessment being made on its rateable value, lands and houses below flood-level being rated at a higher amount than those above.

The principal remedial works pointed out as necessary for the prevention of injury by floods are the cleaning, scouring out and improving of the channel, embanking the sides, and the regulation of mill-dams and weirs, with provision for holding up and storing the water for use in the dry season of summer.

#### LEGISLATION.

*Rights of Water-courses.*—Brooks or streams are formed by the union of springs and the contents of ditches. Rivers are formed by the union of streams. The extent of country drained by a stream or river is termed its basin. The line or ridge bounding the top of the basin is the "watershed," the streamlets shedding, or parting off as from the ridge of a house to their respective areas; the space within this line being the area drained by the stream.\* Large water-courses, in which the tide regularly ebbs and flows, and through which a common right of navigation is exercised, are generally public; and the subjacent soil is the property of the Crown and under the control of the Board of Trade, or, in certain cases, in the lord of the manor, or trusts formed under the authority of the Legislature. The streams and water-courses which form the subject of this article are, as a rule, private property, and the soil over which they pass belongs to the person who owns the land on either side, or the riparian proprietor, "*ad medium filum aquæ*," the centre line of the stream being thus the boundary. The right to the use of the water and to the fishery in a private stream belongs, as a rule, to the riparian proprietor; but the possessor of such right

---

\* 'Physical Geography (Advanced Text Book).' By Page.

cannot use it to the detriment of his neighbours, nor can he be molested in his right with impunity. Thus, a miller cannot lawfully take too much water from the original channel, or pen up and throw back too great a quantity upon the machinery of another mill. The right to use water from a stream may be acquired by grant or custom.\* The right of a proprietor to water only extends to that flowing on the surface. Water percolating under ground is not the subject of any prescriptive right, but, like the air above, is free to all. Any owner of land may sink a well and take as much as he likes from beneath his own land, notwithstanding that by so doing he dries up his neighbour's wells or mill-streams. (*Chasmore v. Richards*, House of Lords, 1859.)

The duty of keeping a stream or water-course in order and maintaining the embankments, where they exist, is with the riparian proprietor, under the common law of the land. The remedy of the owner who is damaged by his neighbour's neglect is to bring an action, and, provided he can prove a prescriptive liability of the person permitting damage to cleanse or maintain the stream and banks, he can get damages. It has, however, been lately settled in the case of *Hudson v. Tabor*, that a riparian proprietor is not primarily liable to maintain the embankments on his own land, notwithstanding that the result of his neglect may be to flood the land of his neighbours.

*Courts of Sewers.*—The evil arising from the want of combined control over rivers, water-courses, and embankments, has been felt from very early times. The first attempt at legislative interference was by the issue, as far back as the reign of Richard II., of royal commissions appointed by the Crown to inquire into any exceptional case of flooding and damage, with power to order such works to be done as they deemed necessary. "These commissions being granted when the sea-walls were broken, or when the sewers and gutters were in need of repair, so that the fresh waters could have their courses; and that the commissions in question issued because the King was bound of right so to keep his kingdom against the sea as that it were not drowned or wasted, and also to provide that his subjects should pass through the kingdom with safety."—(Woolrych, 'Law of Sewers.')

In Henry VIII.'s reign the Commissions, which up to that time had only been issued as occasion required, were permanently established, and the Act 23 Hen. VIII. cap. 5, although amended in William IV.'s and in the present reign (3 & 4 Will. IV. cap. 22; 4 & 5 Vict. cap. 45; 12 & 13 Vict. cap. 50), still continues the chief structure on which the powers

\* 'Law of Waters and Sewers.' By Woolrych.



and duties of Commissions of Sewers have been reared. The Commissions of Sewers thus established only extend to certain parts of the kingdom, and they have no general jurisdiction or control over the water-courses of the country. The number of commissions now in force, issued pursuant to the Act of Henry VIII.'s reign, is thirty-one.

*Modern Drainage Acts.*—The next legislative interference was by the Act 10 & 11 Vict. cap. 38, known as “Lord Lincoln’s Act.” Under the powers of this Act, upon application to the Inclosure Commissioners, depositing plans, giving notice, and other forms, a landowner whose drainage is injured by want of a proper outfall may, subject to paying compensation, enter upon the lands of the adjoining proprietor to “widen, straighten, deepen, divert, scour or cleanse any river, stream, ditch or drain, brook, pool or water-course, and to make, open, and cut any new water-courses, side-cut, &c., and to alter or remove any bank, sluice, floodgate, weir, &c., or other obstruction, and to make or erect any bank, &c., or other works necessary for drainage or warping.” (Sect. ix.) Also, by sect. xiv. provision is made that where there is neglect by any proprietor in properly maintaining the banks of any stream, or cleaning and scouring out the channel, the party aggrieved may apply to two Justices for an order to do the work himself, the expenses being recoverable before the Justices by summary process. If the stream is a boundary adjacent to the lands of the aggrieved person, the work can be done without the preliminary order, the cost of the work being recoverable in the same manner.

This Act gave very valuable powers to individual proprietors for perfecting schemes of improvement in drainage on their own lands, by obtaining an outfall where required through the land of others; but it afforded no facilities for joint action and the levying of equally distributed rates, or for dealing compulsorily with that small minority who are always sure to rise up to thwart any joint scheme of voluntary improvement.

The large works of drainage improvements and reclamation of land which had been effected up to the year 1861, had all been done under the authority of special Acts of Parliament, the costs of which were so great as to offer an insuperable bar to works that were not of great magnitude. To meet this difficulty, in the year 1861, an Act was passed (25 & 26 Vict. cap. 33), to further amend the law relating to drainage, by which facilities were given for the formation of Drainage Trusts for carrying out works of improvement. It has already been stated that in the Fen districts and some other parts of the country Commissioners of Sewers existed, under whose control the existing water-courses were placed, and who under certain restrictions

could borrow money and carry out improvements. The new Act gave the means for the extension of these Commissions to other parts of the country, and also for the formation of elective drainage districts, without the enormous cost attending a special Act of Parliament. The Inclosure Commissioners have the management of all proceedings under the Act, and its powers cannot be used without their approval. They are empowered to hold a local inquiry into the merits of schemes submitted to them, and to see that all persons interested have due notice of what is intended to be done. The provisional orders issued for any approved scheme are embodied in a general Bill brought in every Session, which gives all the power of a special Act of Parliament. The costs of obtaining the order do not exceed from 50*l.* to 100*l.*, except in the case of great opposition, and then these are reduced to a minimum. The preliminary inquiry, held by a Commissioner in the locality, is simple and inexpensive in the extreme as compared with a contest before the Parliamentary Committees of the Houses of Parliament.

The Act is divided into three parts. The first relates to the extension of Commissions of Sewers into all parts of England upon application to the Inclosure Commissioners by the proprietors of one-tenth part of the land within the boundaries of a proposed district. These Commissioners, when duly constituted, have power to borrow money and levy rates for carrying out works for the improvement or maintenance of existing water-courses or banks; for removing weirs, mill-dams or other obstructions; for making new water-courses, banks, outfalls, and other works required for drainage, for the supply of water for cattle, and for warping or irrigation. Any scheme can be stopped in embryo by the dissent of the proprietors of one-half of the land proposed to be embraced by the Commission.

The second part of the Act creates a new body, termed an Elective Drainage District. Under the first part of the Act the Commissioners are appointed by the Crown, who hold office for life. Under this division the Drainage Board consists of a definite number of qualified persons who are elected by the whole body of tax-payers in the newly formed district, and who hold office only for one year, but are eligible for re-election. The Drainage Board has the same power of raising money, levying taxes, and carrying out works as a Commission of Sewers, as already described.

The third part of the Act gives further powers for obtaining outfalls for drainage. Any person interested in land who finds it necessary to open new drains, or to improve existing drains, through the lands of other owners, is to make application to such owner, and send him a plan of the proposed improvement, with

a statement of the amount of compensation proposed to be paid. If the owner assents, a deed is to be drawn up to that effect and deposited with the Clerk of the Peace, and the agreement is thence to be binding on all parties for ever after. If, however, the proprietor dissents, the matter is referred to two Justices (or by consent to arbitration), who are to determine whether the proposed improvements will cause injury to the adjoining owner, and whether such injury is of a nature to admit of a money compensation; and if they so find, they may make an order giving the applicant power to proceed with the work and may assess the amount of compensation.

Twenty-nine districts, containing a total of 74,912 acres, and ranging from 246 acres in extent to 11,000, have availed themselves of the powers afforded, the average charge of the Inclosure Office in granting the first sixteen orders, as given by Mr. Grantham, having been 42*l.* 9*s.* 10*d.* each. The cost of the works executed has varied from 2*l.* to 5*l.* an acre, and the annual charge from 3*s.* to 8*s.*\*

Having been professionally engaged in obtaining provisional orders for two districts under this Act, and subsequently carrying out the works, I can speak with confidence as to the extreme facility and economy in obtaining the order, and the courtesy and assistance rendered in the matter by the Inclosure Office and their Assistant-Commissioner, Mr. Grantham, in whose pamphlet on this subject will be found full particulars of the working of the Act.

Under the Improvement of Land Act (27 & 28 Vict. cap. 14), passed in the year 1864, any landed owner having a limited interest may, with the consent of the Inclosure Commissioners, borrow money and charge his estates with its repayment over a number of years, for any works of permanent improvement, including all works of drainage, the improvement of water-courses and their outfalls, embankments from rivers or the sea, the irrigation or warping of land, building bridges, the erection of weirs, water-engines for sawing or other purposes, the construction of wells, ponds, or reservoirs, or any similar works which will increase the value of the land for agricultural purposes. By an Act of the last Session (40 & 41 Vict. cap. 31) this power is still further extended to the construction of reservoirs and works necessary for the water-supply for domestic and farm purposes on the landowner's own estate, or for the supply of villages, sanitary authorities or other persons, and gives power to collect and receive rents or tolls for the same. It

\* 'The Land Drainage Act, 1861.' By R. B. Grantham (Clowes and Sons), Appendices A and B. 'Report and Minutes of Evidence of Committee House of Lords on Conservancy Boards, 1877.'

must be clearly proved to the satisfaction of the Inclosure Commissioners that the works will effect a permanent yearly increase in the value of the lands on which they are situate, or will produce a revenue exceeding the yearly amount proposed to be charged thereon.

The several Acts of Parliament above enumerated give all the power that is required for the proper maintenance and improvement of the tributary streams, water-courses and drains of the country, which form the subject of this article. What is now required is a general Act, constituting Boards for the conservancy of the rivers of the country, and a proper system of uniform management and control from their source to their outfall, so that the wants of the various conflicting interests should be fairly represented and dealt with in such a manner as shall tend to the general good.

#### SUPPLY OF WATER TO RIVERS.

*Rainfall.*—As the rain produces the water which has to be dealt with, it is a first essential in all drainage matters to procure accurate data as to the amount which falls in the district in question. This varies very considerably according to the situation and physical surroundings. The average of all England and Wales may be taken at about 32 inches. On the west side of the island, owing to the prevalence of westerly winds bringing the clouds across the Atlantic, and to the range of hills which bar their progress, the rainfall amounts to about 40 inches a year. In the Lake district, amongst the Cumberland hills, it rises as high as 165 inches. On the east coast, owing to opposite causes, the average fall is only about 25 inches, falling as low as 20 inches in the Eastern Midland division.\*

However interesting and necessary in procuring data average calculations may be, they must be discarded in making provision for drainage or water-supply, and the extremes of wet or drought must be provided for. As a guide, however, it may be taken almost as an invariable rule that if the average of any district in England be taken for twenty years, and one-sixth deducted or added, the result will give respectively the average of three minimum or maximum years.

*Flow.*—The flow of water in English rivers in mountainous districts varies ordinarily from extreme dry seasons to extreme floods three-hundredfold, and even in exceptional cases as much

---

\* 'The Distribution of Rain over the British Isles.' By G. J. Symons; published annually (Stanford and Co.). 'Rain: How, When, and Why it is Measured; being a popular account of Rainfall investigation.' By G. J. Symons (*idem*).

as five-hundredfold. In the hills of Yorkshire, Lancashire, and Derbyshire, which constitute the backbone of England, the yield of the springs in dry weather varies from about 12 to 18½ cubic feet per minute for every square mile of contributing ground, whilst the flood-drainage varies from 4915 to 9830 cubic feet per minute. In the more impervious granite districts and other igneous and metamorphic regions there is almost a total absence of springs, nearly the whole of the water flowing off in floods; the quantity discharged amounting to 19,200 cubic feet per minute.\*

On the Devonian formation, from observations made on the small River Allen, which drains 1·76 square mile, it was found that, whereas in February when the ground had attained its maximum saturation, out of a rainfall of 5·13 inches, 96 per cent. was discharged by the river, the maximum flow being 295 cubic feet per minute per square mile; while in August, when evaporation and absorption had the greatest effect, out of a rainfall of 4·88 inches, 8 per cent. flowed off by the river, the maximum discharge then being 20·5 cubic feet per minute.†

In the Fen districts of Lincolnshire and Cambridgeshire, where perhaps more attention has been devoted to the science of drainage than in any other part of England, it is usually calculated, in estimating the amount of horse-power required for lifting the water into the main drains in winter, that provision should be made for a quantity equal to a quarter of an inch of rain falling over the whole district in twenty-four hours, or 403·3 cubic feet per minute per square mile. The soil consists of a mixture of peat and alluvial matter resting on clay, the greater proportion is arable, highly cultivated, and thoroughly under-drained.

The average daily discharge from the basin of the Thames above Teddington Weir, embracing an area of 3676 square miles, is given as varying from 17 to 22 cubic feet per minute, or, by different authorities, from 6·8 to 8·7 inches of rainfall out of a total average for the year of 26 inches.‡

*Percolation, Absorption, and Evaporation.*—The variation in the discharge of different streams is accounted for by the varying amount of percolation, absorption, and evaporation, which takes place in their drainage-areas; each depending respectively upon

\* Beardmore, 'Manual of Hydrology'; "Rise and Fall of the River Wandle," 'Trans. Instit. Civil Engineers,' 1861; "Discharge from Under Drains." By B. Denton, *idem.*, vol. xxi.; "Fresh Water Floods of Rivers," *idem.*, vol. xxvii.

† 'The Rainfall of Cornwall, with observations on the Flow of Streams,' By H. M. Whitley. Truro: Lake, 1876.

‡ Grantham on "Arterial Drainage" (Hawkesley), 'Trans. Instit. Civil Engineers,' vol. xix.; Redman on 'the Thames' (Taunton and Symons), *idem.*, vol. xlix.



the geological character of the district, the state of cultivation of the soil, and the season of the year.

The geological structure and the physical outline of a district affect very greatly the quantities of rainfall discharged off the surface or absorbed by the land. If the district be of an impermeable character with steep slopes, a large portion of the rainfall will run off into the water-courses. If, on the other hand, the soil be porous and the contour of the district flat, the greater portion of the rainfall will be absorbed. The dip of the strata also has an important bearing on the amount absorbed or discharged off the surface. A permeable stratum may be so thrown up as to dip in a direction opposed to the slope of the drainage area, and carry the rain falling on its surface away from the natural streams of the watershed to supply springs in another district.

Fig. 1.—*Geological Section of unconformable strata, showing Permeable Beds dipping away from the Drainage Area of their outcrop.*

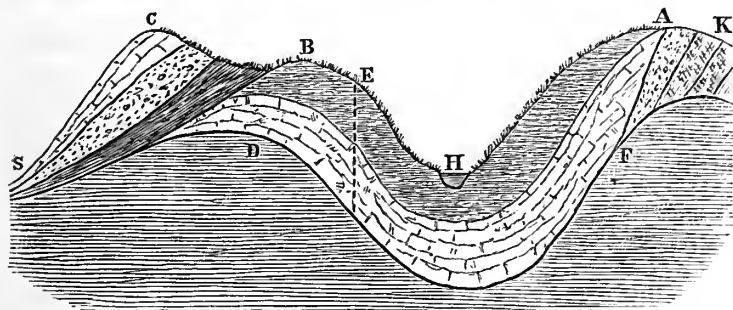

In the accompanying diagram the limits of the watershed are shown by the letters A C. Rain falling on the surface between A and B would run down and pass away by the water-course along the valley at H. That, however, falling between B and C would, to a very great extent, be absorbed by the permeable stratum which crops out at the surface, and, sinking down till it met the impermeable stratum, run off in the direction B S, and find escape at the spring S, contributing to the supply of the water-course of the adjoining watershed. Again, rain falling on the permeable stratum between A and K, would be absorbed and sink down in the direction K F, and be held there as in a reservoir by the impermeable stratum below. When the space between F and D became supersaturated or full, the water would flow over D and pass down towards S, and there find its escape. The supply from this source would be intermittent, the quantity varying probably as the rainfall. A well sunk through the

permeable stratum at E would yield a constant supply until the natural reservoir FD was exhausted.

The rain which falls on most volcanic and unstratified rocks flows so freely off the surface, and is carried so directly to the stream, that nothing is stored for summer supply. In the more recent formations the amount of percolation is so considerable, except in the case of the clays, that there is scarcely any flow off the surface. The flow of the rivers is nearly constant, and floods in these districts are rare, only occurring under exceptional circumstances.

A rainfall of an inch in ten or twelve hours will nearly all run off a hill of unstratified rock or clay almost as quickly as it falls, but on a steep chalk or limestone hill, even at elevations of 800 or 900 feet above the level of the sea, although there might be a rainfall of 2 inches in an hour, the whole would sink into the ground. So also in the red sandstone the water is absorbed almost as fast as the rain reaches the ground, and consequently the supply of water from wells in this formation is always abundant.\* Sand, when dry, will absorb from 2 to 3 gallons in every cubic foot, and water will permeate as much as 18 inches in depth in one hour.†

The capacity of chalk soils to receive the rainfall by percolation is easily accounted for when it is considered that a cubic foot of chalk, when dry, will absorb from 2 to 2½ gallons of water, or from 33 to 40 per cent. of its bulk, equal to 56,000,000 gallons for every *foot* in depth per square mile, or about 4 inches of rainfall.‡ (Ansted.)

So strong is this power of absorption in these soils, the chalks especially, that they may always be traced on a map by the absence of streams and rivers.

The difference between the amount of absorption of chalk soils and those of an impervious nature is also shown by the size of the openings of bridges and culverts across streams running through chalk and clay districts. From a comparison made by Mr. Homersham of nine pairs of bridges over the Thames or its tributaries, one bridge of each pair spanning respectively a stream draining an area of chalk, and the other crossing a stream draining a nearly equal area of the London clay, or of London clay with a little chalk, the ratios of the water-ways draining the chalk varied from one-tenth to three-tenths of the area of those draining the clay, the latter being

\* "The Water Supply of Paisley," 'Trans. Instit. Civil Engineers,' vol. xxxi.; "The Rise and Fall of the Wandle," *idem*, 1861.

† 'Water Supply of Cities and Towns.' By W. Humber. Crosby Lockwood and Co.

‡ "The Chalk Water System," 'Trans. Instit. Civil Engineers,' vol. xlvii.



often filled with flood-water, while the former were never full.\* The water-way of the arches in the clay districts varied from 8 to 17 superficial feet for each square mile of drainage area, while in the chalk districts the water-way varied from one-third of a foot to 2 superficial feet per mile of drainage area.

The water absorbed during the wet season of autumn and winter in these underground reservoirs slowly gravitates to the fissures. Through these natural channels it continues to flow in the direction of the dip of the strata until stopped by some impervious material, when, having risen high enough to surmount the barrier or dam, it is discharged in the form of springs. These springs feed and maintain the water-courses with a regularity only to be found under such circumstances, rendering them extremely valuable for purposes of water supply and for driving machinery, some of the best mills in England being found on streams fed from the chalk formation. When the rainfall is so exceptionally heavy that the chalk becomes surcharged, and incapable of absorbing and holding water, it finds fresh vents, and, bursting out, forms those remarkable streams known as "bournes," the flow from which only occurs at intervals separated by long periods.

Many of the deep-seated springs in the chalk and limestone are not affected by the rain until several months after its fall, the water taking some considerable time to saturate the rock and travel along the underground channels to the point of discharge. The heavy rainfall of a winter and autumn affords a supply for the following summer. The maximum of these springs is generally between May and July, and the minimum between October and December. The state of the stream may thus be predicted beforehand; a wet winter may be expected to afford plentiful supplies for the following summer, but a dry autumn and winter must inevitably be followed by a deficiency in the following summer and an unusual depression in the water level.

The perennial character of the chalk springs is affected by their altitude above the level of the sea; those placed about 100 feet above the sea being scarcely or ever dry, while those at a greater elevation are more liable to fail in a dry season.

The quantity of rain which finds its way to the water-courses, is affected not only by the geological condition of the soil on which it falls, but also by the vegetation with which that soil is covered, and the meteorological condition of the atmosphere at the time.

---

\* "Chalk Water Supply," 'Trans. Instit. Civil Engineers,' vol. xlvii.; "Fresh Water Floods of Rivers," *idem*, vol. xxvii.

During summer months the percolation on most soils is little or nothing, the whole of the rainfall being absorbed by the thirsty ground and the growing vegetation, or passing away by evaporation. In the four winter months, beginning with November, the tendency of percolation is to approach the amount of rain fallen.

In the Thames basin it is calculated that at least 3 inches of continuous rainfall is required in the autumn to replace the evaporation of the summer months, and that no essential percolation contributes to the streams until the soil has become thoroughly saturated. Mr. Rawlinson states that in a district in South Wales, after two or three dry summers, unless  $2\frac{1}{2}$  inches in depth of rain fell within six days, nothing came off to flow down the stream in the valley.\* Beardmore, as the result of his observations, found that in September and October it takes 1 inch of rain, repeated twice in a week, materially to affect the streams unless the country is hilly and precipitous.† In the Fen districts a great portion of the water sent into the rivers from the springs on the high lands in summer is absorbed by the Fen soil. The Witham, in Lincolnshire, drains 1063 square miles, less than half of which is fen land. The upper portion is fed by several tributaries deriving their source from the oolites, the supply being perennial. Yet in a very dry summer, so great is the absorption in the Fen portion of the basin, that scarcely any fresh water passes away to sea, the supply from the high land streams being utilised for keeping up the water level in the fen ditches and sewers. In the dry summers, of 1864 and 1868, so great was the absorption that not a single drop of water passed during the summer and autumn out of the river down the haven to the sea; and it was not until quite the end of the year—in the year 1864 the end of December—before the water in the river had risen sufficiently high to flow over the sediment which had collected in the haven. The circumstances of this river are no doubt peculiar, as the flow of the tidal water is arrested in its progress about 5 miles from the mouth of the river by a sluice placed across the channel; and no benefit is derived from the semi-diurnal ebb and flow of the tides in maintaining the water level in the pores of the soil nor from the scour in keeping the channel free from deposit; but the fact stated is sufficient to show the immense amount of absorption going on in free soils when under cultivation.

Evaporation is greatest off the surface of water, amounting in the course of the year to a quantity nearly equal to that falling

\* "Rainfall and Evaporation," 'Trans. Instit. Civil Engineers,' vol. xlv.

† 'Manual of Hydrology.' By Beardmore. Waterlow and Sons, 1862.

on its surface.\* The mean daily evaporation from off the surface of a reservoir or other body of water is considered to vary from the 12th to the 16th of an inch.† Mr. Humber considers that the loss to be allowed for in a reservoir from this cause may be calculated at the rate of one inch of rainfall over the whole of the gathering ground.‡

Evaporation proceeds more rapidly off soils covered with grass and similar vegetation than off those that are bare. From experiments made at Vienna, it was found that the proportion of percolation (two feet deep) through ground covered with turf, as compared with that bare of vegetation at the same place, varied as follows:—

In May	. .	25·2	per cent. less through turf.
June	. .	53·1	”
July	. .	23·4	”
Aug.	. .	29·2	”
Sept.	. .	12·7	”

And as the result of these experiments, the conclusion arrived at was that in the summer half-year forest soil was the moistest; bare, open ground less moist; turf the driest.§

Percolation is therefore diminished when there is vegetation, and especially when the growth extends through the whole of the year, as in grass. Dr. Gilbert computes that for every ton of really dry substance grown, a depth of 3 inches of rain would be evaporated through the vegetation.§ Trees, whether planted singly, or in woodlands and forests, have a material effect in checking evaporation; their influence upon the disposal of the rainfall being thus described by Mr. Steinmetz, in his popular book on ‘Meteorology:’ ||—“Trees and forests contribute to the formation of springs and water-courses, not only by means of the humidity which they produce and the condensation of vapour by refrigeration, but also by reason of the obstacles which they present to the evaporation of the water in the soil itself, and by means of the roots which, by dividing the soil like so many perforations, render it more permeable and facilitate filtration. Certain it is that the clearance of forests and the consequent drying up or draining of marshes and bogs have caused a material alteration, not only in the entire face of the country, but in the supply of water to the rivers formerly derived from

\* Beardmore, ‘Manual of Hydrology.’

† Burnell, ‘Hydraulic Engineering.’

‡ ‘Water Supply of Cities and Towns.’ By W. Humber. Crosby Lockwood and Co., 1876.

§ ‘Rainfall and Evaporation,’ ‘Trans. Instit. Civil Engineers,’ vol. xiv.

|| ‘Sunshine and Showers, their Influence throughout Creation.’ By A. Steinmetz. Reeve and Co., 1867.

those reservoirs, and in the periodical amount of rainfall and the regularity of its distribution. Many streams throughout the country, which formerly supplied large mills with unfailling water-power, except in the very driest of seasons, are now, with vastly improved machinery requiring less power, frequently unable to work; and almost all are compelled to be supplemented by steam-power to make good the deficiency. Owing partly to this cause, but principally to the modern system of drainage, by which the land is cleared of water almost as soon as it falls, having now none of the ancient reservoirs, in the shape of bogs and marshes, to receive and retain it for future use, all the old water millers complain that the rainfall, however heavy, does them no permanent good. It just occasions a momentary flush, which is rather injurious than otherwise, being in excess of the requisite power, instead of being held in reserve by the marshes and, above all, by the subsoil of the adjacent land. This was formerly, in the undrained state of the country, perhaps the largest source of supply, because it extended over the whole area, and yielded its reserve deliberately and in driblets." The proportion of forest or woodland required for an agricultural country, in order to insure a regular and sufficient rainfall without violent storms, is estimated at 23 per cent. for the interior, and 20 per cent. near the coast. This estimate relates to Germany; but in England the proportion, according to Sir Henry James, the late head of the Ordnance Department, is only  $2\frac{1}{2}$  per cent. "The Wolf Spring in the Commune of Soubey, in France, furnishes a remarkable instance of the influence of woods upon springs. A few years ago this spring did not exist. At the place where it now rises a small thread of water was observed after very long rains, but the stream disappeared with the rains. The spot is in the middle of a very steep pasture, inclining to the south. Eighty years ago, the owner of the land perceiving that some firs were shooting up in the upper part of it, determined to let them grow, and they soon formed a flourishing grove. As soon as they were well grown, a fine spring appeared in place of the occasional rill, and furnished abundant water in the longest drought. For forty or fifty years this spring was considered the best in Clos-du-Doubs. A few years since the grove was felled and the ground turned again into a pasture. The spring disappeared with the wood, and is now as dry as it was ninety years ago." Numerous other instances could be quoted to show that the felling or planting of timber has a most material influence on the rainfall and springs of a country, and also in ameliorating the conditions of climate. Woods are almost always moist, for not only is evaporation checked by the shade of the foliage, but the trees them-

selves act as collectors of water, by condensing the vapour in the atmosphere, which is caught by the leaves, whence it drops on the soil below. The appearance of a tree on a foggy evening, with drops depending from the end of every twig, and the ground beneath saturated with water, must be familiar to all. The fact must be equally well known that, in a drier condition of the atmosphere, trees collect the water from the earth by the spongioles of their roots, and return it to the atmosphere from the leaves; this process being most active in spring and summer. Thus the winter-rains conduce to the humidity of the atmosphere during the droughts of summer.

The capillary action which takes place in the soil materially assists the process of evaporation. As the surface is dried up in summer the water gradually rises from the soil beneath to feed the roots of the vegetation and to form the dew which so refreshes the plants after a hot summer's day. A contrary process takes place in the wet season of winter, when surface-water is too plentiful, percolation being then assisted by the opening of the pores of the soil by the thaw which follows a sharp frost. A rapid thaw after a fall of snow produces a much greater flood than is due to the mere quantity of water produced by the melted snow. The break-up of a frost is often accompanied by a heavy fall of rain, which, added to the melted snow and rapid percolation of the water, causes unusually high floods in the rivers. It is stated that all the great floods on the Thames valley during the past 120 years have been due to this cause.

The depth to which the rain percolates through the soil varies considerably at different periods of the year. Messrs. Lawes and Gilbert, as the result of their experiments, found that out of an average rainfall of 28 inches,  $10\frac{1}{4}$  inches percolated through 20 inches of soil, 10 inches through 40 inches, and 8 inches through 60 inches; and that after the warm and comparatively dry weather of the autumn there was less water going through 40 inches than through 20 inches; but that when the winter-rains accumulated, the reverse happened, and there was sometimes more passing through *sixty inches* than twenty.\*

Taking all circumstances into consideration, Mr. Hawkesley gives it as his experience, which is confirmed by Mr. Glaisher, that the evaporation and absorption of the rainfall vary throughout England generally between 10 and 18 inches; the former applying to steep precipitous mountains of non-absorbent rock,

---

\* "Rainfall and Evaporation," 'Trans. Instit. Civil Engineers,' vol. xlv.  
VOL. XIV.—S. S. C



whilst the latter takes place in flat spongy moorland or cultivated ground.\*

Professor Rankine gives the following figures as a guide to the proportion borne by the available to the total rainfall in different districts:—

	Proportion of available to total Rainfall.
Steep surfaces of granite, gneiss, and slate nearly . . . . .	1
Moorland and hilly pasture, from . . . . .	0·8 to 0·6
Flat cultivated country, from . . . . .	0·5 to 0·4
Chalk . . . . .	0

Deep-seated springs and wells give from 0·3 to 0·4 of the total rainfall.†

Mr. Bailey Denton puts the mean total discharge of the rivers at their outfalls in floods and freshets, from rainfall which has found its way over the surface of the ground without entering it, in the north and west of England, at 20 inches; and for the midland, southern, and eastern districts at 6 inches; or a mean for the whole country of 15 inches; while the proportion of rain required to maintain the natural flow of our rivers during the summer and dry weather periods of the year is about one-eighth of the average mean rainfall, or 4 inches over the whole of the river watersheds.‡

In calculating the proportion of rainfall which any given stream will discharge, there must be taken into consideration, besides the disturbing causes already alluded to, the nature of the soil over which the river passes. A very large proportion of the water is in some cases abstracted from the stream by permeable strata, which it encounters on its course. Thus, the River Churn, a tributary of the Thames, which derives its source from the flow of strong springs in the Cotswold Hills, after running through the Lias clay for the first part of its course, comes to the Oolitic strata, when the quantity flowing down the channel, instead of increasing, suddenly decreases. From gaugings taken by Mr. Simpson, C.E., in the dry period of the autumn of 1859, the quantity was found to decrease from 320 cubic feet per minute at 5½ miles from the source to 10 cubic feet at 14 miles. The water in the intervening space percolated through the fissures and fractures of the rocky bed, and through the porous strata of the fish- and mill-ponds. After this it began again gradually to increase in volume until it attained

\* "Water Supply of Paisley," 'Trans. Instit. Civil Engineers,' vol. xxxi.

† Rankine's 'Manual of Civil Engineering,' Griffin and Co., 1871.

‡ 'The Storage of Water.' By J. Bailey Denton. Spon and Co., 1874.



100 cubic feet per minute at the junction with the Thames at Cricklade, 22 miles from the source. Allowing for the increased drainage area, this showed a loss of 340 cubic feet per minute. To remedy this, Mr. Simpson advised the mill-owners that the bottom of the stream and the fish-ponds through which the river passed should be puddled, at an estimated cost of 3000*l*.\*

Subsequently, at a public meeting held to consider this subject, arrangements were entered into by which the millers and others interested agreed to contribute to a common fund for the payment of men to be regularly employed to inspect the stream, and to puddle the bottom and sides wherever leaks were discovered.†

In like manner streams may be abnormally increased in volume by springs which are fed by rain falling outside the watershed of the river in the manner shown in the illustration (Fig. 1, p. 11). The River Frome, in the neighbourhood of Chalford, when gauged in its ordinary condition by Mr. Taunton, was found to yield, about 7 miles from its source, in a dry season, 321 cubic feet a minute. This quantity was increased, within three-quarters of a mile, to 1605 cubic feet, by very strong springs, one of which alone was found to yield 64 cubic feet a minute. The ordinary summer flow of the river in dry weather was 481 cubic feet per minute, equal to about 28 per cent. of the total fall of rain on an area of about 25 square miles, but for a few springs it represents only 17 per cent. of the total quantity.‡

Owing to the various causes already described, it will be seen how difficult, in fact impossible, it is to lay down any rule or formula which can be applied generally to the proportion of rainfall which is discharged by the river or stream draining the district. It is only by carefully noting the statistics of rain for each particular district—examining the geological condition of the district in which the river has its source and through which it flows, with the nature of the vegetation with which the surface is covered—that even an approximate estimate can be formed of the quantity of water for which proper provision should be made.

#### DISCHARGE OF WATER BY NATURAL CHANNELS.

Having settled the quantity of rainfall to be drained off any given district, the next point for consideration is the best form

\* "The Perennial and Flood Waters of the Upper Thames," 'Trans. Instit. Civil Engineers,' vol. xxii.

† House of Lords' Committee on Conservancy Boards; Evidence of Mr. Taunton, QQ. 2180, 2200, 2230.

‡ "Rainfall and Evaporation," 'Trans. Instit. Civil Engineers,' vol. xlv.

and direction for the carrier which shall convey away the water as rapidly as possible in times of excess, and yet not suddenly exhaust the country, but leave a supply for the droughts of summer and early autumn.

The power which moves the rainfall from the pores of the earth to the river, and thence to the ocean, is that due to gravity, or the attraction which the earth exercises upon all bodies in a direction perpendicular to the surface of the sea. Every particle of a fluid being equally attracted in the same direction, the surface always has a tendency to become level, and water, if left free to act, continues in motion until all its particles attain the same level. Hence the particles of water at the upper end of a stream are always in motion towards the lower level, and the whole mass moves downwards until the lowest level attainable is reached. The vertical space through which the water moves in its course is termed the "fall," and the length of the stream divided by the fall, gives the rate of fall, inclination, or gradient. This motion is checked by the retarding force due to the friction which the particles of water meet with from the sides and bottom of the channel, and from weeds, and other impediments. The net result attained from the operation of the two forces is termed the velocity of the stream, generally reckoned at so many feet per minute or miles per hour. The greater the length, therefore, in proportion to the fall, the greater the friction, the slower the current, and the smaller the quantity moved in a given time. Water rubbing against water meets with less friction than when rubbing against earth, consequently the smaller the surface of earth which the water touches in the channel the less the friction. Water in a deep narrow channel will move more rapidly than in a broad shallow one, because it encounters less friction. And so also a straight stream will, *cæteris paribus*, discharge more water than a crooked one, because the proportion of length to fall is less, the friction is less, and the space travelled over is less. Engineers use the term "hydraulic mean depth" to represent the proportion of rubbing surface in a stream to the volume of water passing along it. The figure representing this is found by dividing the sectional area of the channel by the length of the border touched by the water, and forms an important element in all calculations for the discharge of water-courses.

In order to find the size of a stream adequate to convey a given quantity of water in a given time, it is necessary to fix its area, contour, rate of fall, and mean frictional resistance. For this there are several different formulæ; but that adopted in Beardmore's 'Manual of Hydrology,' for finding the velocity in feet per minute ( $v$ ) is to multiply the square root of the hydraulic

mean depth in feet (the product of the area ( $a$ ) divided by the wetted contour ( $c$ )) by the fall in two miles in feet ( $f$ ), and this again by 55; the result being the velocity in feet per minute.

$$\sqrt{\frac{a}{c}} \times f \times 55 = v.*$$

This again, multiplied by the sectional area in square feet gives the discharge in cubic feet per minute. For example, a channel which has a fall of 3 feet per mile, depth of 4 feet, and a mean width of 30 feet, will have an area of 120 square feet, the length of the bottom and sides touched by the water being  $24.0 + 7.21 + 7.21 = 38.42$  feet. 120 divided by 38.42 is equal to 3.12, the hydraulic mean depth, which, multiplied by 6, the fall in 2 miles, is equal to 18.72; the square root of which is 4.32, which, multiplied by 55, gives 237.6 as the velocity in feet per minute; and this, multiplied again by 120, the area, gives 28,112 cubic feet per minute as the discharge.

As the retarding force or friction is as the length of the bottom and sides of the stream, and the accelerating force is as the cross-section, it follows that as the depth of the water increases the velocity increases, and consequently the discharging power of the channel.

A stream which has a hydraulic mean depth of 4 feet, and a fall per mile of only 1 foot, will have the same discharge as a channel which has a fall of 4 feet, and a hydraulic mean depth of 1 foot. This shows the advantage of a deep channel in districts where the fall is only slight, and that of a shallow channel when the gradient is very steep, in moderating the velocity and the consequent action of the water on the sides and bottom of the channel.

*Form and Capacity of Channel.*—The form of channel which gives the best results is that which has its mean width equal to about double the depth.† Great care and thought are necessary in setting out the section of any new channel, avoiding on the one hand expense in moving soil, by having the slopes too flat; and on the other allowing sufficient capacity for maximum floods, and sufficient slope to avoid the washing away of the sides. Great attention was paid to this subject by the Board of Works in the drainage operations in Ireland, and minute instructions, with specimen sections, will be found in the Ap-

\* Beardmore's 'Manual of Hydrology. Tables 4 and 4a.

† 'Hydraulic Tables.' By J. Neville. Lockwood and Co., 1875.

pendix to the 'Report on the Drainage of Lands,' presented to the House of Lords in 1852.\*

The slope will depend on the nature of the soil, and the angle of repose at which it will remain without being washed away by the current. The least slope may be given in solid rock and chalk, where 6 inches horizontal to each foot in vertical height will be found sufficient. In ordinary soils the sides will stand at an angle of 1 to 1; in silt and sand,  $2\frac{1}{2}$  or 3 to 1 will be necessary. The safest guide is to be derived from a careful observation of the banks of the water-courses in the neighbourhood, and the slope and form to which they have adapted themselves where not interfered with by vegetation or abnormal circumstances. The soil thrown out, or "spoil," if not carted away, should be moved a sufficient distance from the cutting to prevent its weight forcing the sides into the new channel. This distance, as in the slope, will depend upon the soil, but should not be less than 4 feet. The Irish regulations prescribed a minimum of 6 feet.

The size of a cutting must be determined by the quantity of water it will have to discharge in maximum floods, the fall to be obtained and the slopes which the soil will allow. The first has already been dealt with. The fall will be regulated by the difference in level between the new cut at its commencement and its outfall. If the fall is too steep, the velocity will be so great that the sides and bottom of the stream will be washed away; deep holes will be formed in one place and bars in another, and the regularity of the current will be interfered with. Too sluggish a flow, on the other hand, encourages the growth of aquatic plants, which not only impede the discharge of the water, but also collect the silt or warp which, together with the vegetation and other matters brought down, form aits or islands in the stream, a frequent cause of flooding in neglected rivers.

The wearing action of the current is dependent on the velocity of the water and the nature of the materials through which the channel passes. When the sides and bed of a river are composed of materials of such a nature that the current is not sufficient to move them except when swollen by extraordinary floods, the condition of the channel is considered "stable;" and the adaptation of the velocity to the tenacity of the banks is expressed by the term "regimen" of the river.

The following table,† the result of experiments, gives the greatest velocities close to the bed, which is consistent with the stability of the soil, and at which the water has sufficient force to carry the particles with it. When the velocity is greater

\* Report: Drainage of Lands (Ireland), House of Lords, 1852.

† 'Dictionary of Engineering:' Art. "River." Spon and Co., 1874.

than that given in the table, the banks require protection by osiers, fascines, stone, or other means.

Feet per Minute.	Miles per Hour.	Material.
15	0·17	Soft clay.
30	0·34	Fine sand.
40	0·45	Coarse sand, and gravel as large as peas, and clay.
120	1·36	Gravel, 1 inch in diameter.
200	2·27	Pebbles, $1\frac{1}{2}$ inch in diameter.
240	2·72	Heavy shingle.
300	3·40	Soft rock.
400	4·54	Rock and shingle.

Under ordinary conditions the surface inclination of the water follows that of the bottom of the cut; but it is not necessary for the motion of the water that any inclination should be given to the bed of the channel. In low flat countries, such as the Fens, it is not unusual to lay out the bed of the larger cuts or drains at a dead level. When floods come, the whole body of water is set in motion, and there can be no dispute that water running over water suffers less friction than when running over soil; the drain serves also as a reservoir for water when the sluices are closed in summer. In the smaller drains a fall of from 4 to 6 inches in the mile is deemed sufficient.

The ordinary velocity of streams passing through cultivated lands, where it naturally follows that the fall is not very great, is from three-quarters of a mile to 3 miles an hour. Mr. Beardmore records a velocity of 9 miles an hour in the River Lea, one of the tributaries of the Thames;\* but this was under very exceptional circumstances during the great flood of 1852, and such a rate is rarely attained except in mountain torrents. Where there is any considerable body and depth of water, a stream will continue in motion with a mean inclination on the surface as low as 2 inches per mile. The inclination of the larger rivers varies from 4 to 12 inches in the mile. The Thames varies from about 18 inches per mile from Lechlade to Teddington, to  $1\frac{1}{2}$  inch from Teddington to London Bridge, and rather more than half an inch from London to Yantlet Creek.† Du Buat considered that one-eighth of an inch per mile is the smallest possible rate of inclination that can be given to a canal to produce sensible motion.‡

In providing a system of arterial drainage, attention must be directed to the fact that in making provision for the admission

\* "Fresh Water Floods," 'Trans. Instit. Civil Engineers,' vol. xxvii.

† Renné's 'Report on Hydraulics.'

‡ 'Canal and River Engineering.' By Stevenson. Black, 1872.



of tributary streams into the main channel, the sectional area of the latter will not necessarily require an increase in dimensions corresponding to the additional area of the tributary. The union of the two streams makes the whole flow the swifter; water near the banks, before at rest, is put in motion, and in lieu of the friction of four sides, that of only two have to be overcome.\* The hydraulic mean depth being increased, the rate of discharge is also increased.

The size of an arterial drain or cut must be regulated by the depth at which the bottom can be placed below the surface of the land. In order to obviate too deep cuttings where the slope of the ground is very irregular, it is often necessary to vary the inclination of the bed along the course of the stream; but whatever gradient may be adopted, the bottom must be so regulated that the surface-level of the water in the main drain in times of flood can be discharged at such a level as will admit of the tributaries freely uttering their contents. This level will depend on the depth adopted in particular localities for laying the under-drains. Speaking generally, a minimum of 4 feet is advisable. In other words, the flood level of the main stream should be at least 4 feet below the surface of the land. This was the minimum allowed by the Irish Drainage Board, for the circular issued to the engineers contained the following instructions: "Your attention is directed to the necessity in all drainage works of providing for the effectual discharge of the maximum floods at as low a level as practicable (within reasonable limits of expense), so as to provide ample outfalls for the future deep thorough drainage and improvement of such of the adjacent lands as require it. For this purpose main drains should seldom if ever be under 5 feet deep; small streams and rivulets from 6 to 7; and larger streams and rivers from 8 to 9 feet or more, according to the size of the river."†

Owing to the general neglect with which the smaller rivers, brooks, and water-courses of the country are treated, few streams provide this depth. Mr. Grantham, C.E., has stated that in his opinion the average depth of the running water-courses of this country does not exceed 3 feet.‡

In cutting drains through bog or peat, provision must be made for the subsidence which takes place to a very considerable extent in the drained land, owing to the compression of the soil. This arises from abstraction of the water, and decay of the organic matter in the peat by working and exposure to the air.

\* 'Arterial Drainage.' By G. A. Dean. Stratford: Morris, 1861.

† Report: Drainage of Lands (Ireland), House of Lords, 1852.

‡ Grantham on "Arterial Drainage," 'Trans. Instit. Civil Engineers,' vol. xix.



In the Fen districts this subsidence has been found to amount to as much as 2 and 3 feet, and even in extreme cases, as in Whittlesea Mere, as much as 8 feet, involving the lowering of the drainage wheels and the cills of sluices.

#### IMPROVEMENT OF NATURAL CHANNELS.

*Regulating Weirs—Catchwater Drains—Bridges.*—In cases where the natural gradient of the country is very steep, and it is desirable to hold up the water in the streams for the use of the cattle and to prevent the drying up of the soil in summer, or where the soil is so loose and friable as to be easily washed away, it may become necessary to regulate the fall by the use of steps or weirs. This process was adopted in the drainage of Hainault Forest, as described by Mr. Grantham in his paper on "Arterial Drainage."\* The natural fall of the valley at the surface of the land was so great, that the velocity of the water would have destroyed the sides and bottom of the drain. Overfalls built of brick were therefore put in, varying from 10 feet to 3 feet in width of opening, and rising from 3 to 5 feet. These overfalls were so constructed that boards could be inserted in grooves to hold up and store the water in summer for cattle or other purposes, and for irrigating the land on both sides.

Where the district to be drained is flat and surrounded by land rising at a steep inclination, especially where mechanical power has to be resorted to for raising the water, it may be advisable to adopt the system of catch-water drains used by Mr. Rennie in the Fens. A drain was there cut skirting the low land, for the purpose of collecting the water from the higher level and carrying it off to an outfall above the point of discharge of the lowland water. The Fen drains have thus only to contend with the rain falling on the level. By the use of regulating sluices at the end, and at intervals along the catch-water drains, these serve as reservoirs for the storage of water which is admitted to the drains on the low level during the summer, so as to fill the ditches and supply water for the stock. Water supplied in this way from the high-land streams bordering on the Fens is highly prized, and considered of incalculable advantage.

The arrangement of these high-level drains is often such as to involve the necessity of carrying the low-level drains across and consequently underneath their bed. This is simply and easily accomplished by syphons or "sunken tunnels," which consist merely of cast- or wrought-iron pipes or a wooden tunnel. It is hardly necessary to say that, if it is required, these may be

\* 'Trans. Instit. Civil Engineers,' vol. xix., Grantham on "Arterial Drainage."

placed at a level considerably below the drain, the water of which they convey, and the end which utters the water being placed so much lower than the receiving end as to compensate for the friction of the water in passing through. If placed at a dead level, there will be a slight head on the upper side.

In making new cuts or improving old water-courses, the building of new bridges, or the altering of old ones, is a matter requiring much attention. The increased rate at which the rain-water is now sent to the brooks renders the openings of many bridges and culverts, which formerly were large enough, of insufficient capacity and therefore a great impediment to the flow of the water. The use also of steam-cultivating machines and traction-engines, weighing 10 or 12 tons, renders it imperative that bridges should be built both wider and stronger than formerly. Wherever practicable, a single arch should be used, as offering less obstruction to the flow, and being less liable to be blocked by weeds and timber. If the subsoil is sufficiently sound, inverts should be avoided, as rendering difficult any future deepening of the bed. For the same cause it is desirable that the bottom level under the bridges and for some distance above and below them should be lower than the general gradient of the river-bed. The size of the opening must be such as to give a larger sectional area than the cut itself at the highest flood-level.

*Improving existing Water-courses.*—By removing shoals and straightening the stream by cutting off bends, the discharge of the flood-waters will be increased in proportion to the increased water-way, the diminished distance the water has to travel, and the smaller amount of friction from the sides and bottom which it has to encounter. Improvements of this nature should always be commenced at the outfall, otherwise the water will be sent into the lower reaches of the stream with such increased rapidity that the unimproved portion will not be able to discharge the water poured into it with sufficient velocity, and flooding of the lands at the lower levels will ensue.

The removal of shoals is effected either by hand-labour, the water being dammed up in sections by sheet-pile dams; or, when this is not practicable, by dredging with a small barge and spoon and bag. The spoon is formed with a ring of iron, about 2 feet in diameter, having a bag of strong leather attached to it by leather thongs. The ring is attached to a pole which is lowered from the end of the barge to the bottom of the stream. A chain made fast to the ring is wound up by a windlass, fixed at the other end of the barge, and the spoon is thus dragged along the bottom, being guided in its progress by the man who holds the pole. The chain passes over a pulley suspended on an upright

in the centre of the barge, and when the spoon reaches the spot immediately under this pulley, the chain lifts it vertically until it reaches the gunwale of the barge, when the bag is emptied on to a shoot and then drawn back again and lowered for a fresh supply. The bag is now generally superseded by an iron scoop with perforated sides, the bottom being made of steel and hung on hinges, and kept in its place by a catch and lever, which is released by the man in attendance as soon as it reaches the barge; the bottom then falls, and the contents fall on the shoot (Fig. 2). This operation requires four men to work it; two at

Fig. 2.—The Hand Dredger.

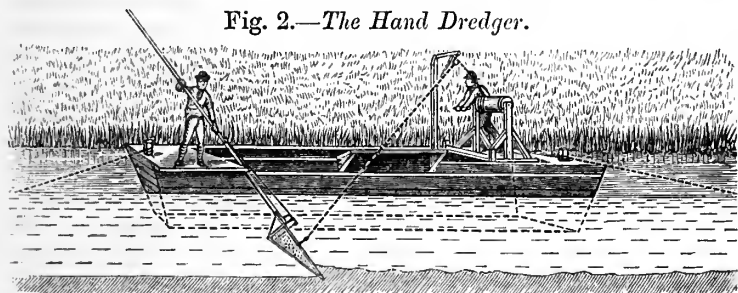

the windlass, one with the pole, and one to shovel the dirt off the shoot into the barge. Under ordinary circumstances, it will raise from 25 to 30 tons a day.

In streams where the current is slow, weeds and aquatic plants grow freely on the bottom, and by the friction which they offer to the water materially retard its flow. In very irregular and shallow channels, much impeded by weeds, the velocity will be reduced from this cause as much as one-half from that which a clear course would afford.\* In the Spanish irrigation works it has been found that the best velocity to keep the channel clear of sediment and prevent the too rapid growth of weeds is about 120 feet per minute, or  $1\frac{1}{3}$  mile per hour.†

In canalised streams of low velocity, where there is no flow in summer, or where the movement of the water is very sluggish, the weeds require cutting twice and even three times in the year. The ordinary method is by joining together several scythe-blades, and attaching ropes to each end of the set of knives. Men walk on either bank of the stream, and keep drawing the cutters backwards and forwards as they move up the stream. The weeds are then drawn to shore with rakes and placed above flood-level. The cost of this work in the Fen districts, where it is termed "roding," is about 20s. per mile for drains from 15 to 20 feet wide, and 30s. for larger drains.

\* Neville's Hydraulic Tables.

† 'Irrigation in Spain,' Roberts.

If proper supervision is not exercised over this process, the weeds float down the drains into the main river, and accumulate in the shallows. The silt and debris washed down with the water settles among the weeds, and forms aits or islands, which contract the area of the water-way and divert the course of the stream. A scour is thus caused on the opposite bank, and a permanent irregularity made in the channel of the river.

*Embanking Streams.*—One of the principal remedies insisted on by the witnesses before the Committee of the House of Lords of last Session, as a prevention of floods, was the proper embanking of the sides of the stream, for the purpose of preventing the lower lands from being drowned by the water coming down from the higher level. Mr. Rawlinson, C.E., one of the Rivers Pollution Commissioners, in his evidence, stated that “speaking broadly, taking all the rivers he was acquainted with, that if he put one remedy first as the prime remedy, embanking would be the one.”\*

The material required for the embankment can generally be obtained by widening and deepening the water-course, thus effecting two improvements at the same time. It is not essential that the soil of which the bank is composed, or on which it stands, should be impermeable to the water. A porous and gravelly soil can be successfully embanked and the water kept out with embankments as porous as silt and peat.\* The latter material, however, allows so much to pass through by filtration, that it is almost invariably found necessary to have a puddle trench in the middle of the bank, the clay being chopped very small and well trodden in while dry. The material being above the surface of the land would be liable to shrink in dry weather if worked in the ordinary way, and the embankment is generally found to be more water-tight if the clay is well punned in a dry state. Miles of embankments around the coast, for the exclusion of the tidal waters, are composed of the silt deposited by the tide on the foreshore. The pressure of the tidal water remains only for a short period, and not long enough to allow the water to rise through the soil. The same is the case in extraordinary land floods, which are so evanescent that the water would be down again before there would be any appearance of water on the surface behind the embankment.

To meet the case of water-courses draining mountainous or hilly districts, where occasional floods exceed the average very greatly, and but rarely occur, it would obviously be a waste of money in the first cost of construction, and permanently in the

---

\* House of Lords' Committee on Conservancy Boards, 1877; ‘Minutes of Evidence,’ QQ. 164, 169, 170, 207.

quantity of land occupied by the stream, if it were made large enough to receive the whole of the water sent down in these floods within its proper bed. To meet this the banks may be placed some distance apart, and the "cess," or intervening space between the foot of the bank and the stream, be laid at a very flat slope, and grassed over. In excessive floods the whole space between the banks would thus afford water-way of sufficient capacity to meet the most extreme rainfall. During the rest of the year it would afford excellent pasturage for sheep and cattle. The bridges and other works must be made of the full dimensions to meet the largest floods, so that the water should have free course and meet with no impediment.

*Flood-gates and Sluices.*—While embanking shuts out the flood-water from flowing over the adjacent lands, it also prevents the drainage from these low lands finding access to the main water-course. Provision can be made for this by cutting an interior drain, running parallel with the bank and discharging lower down the stream. If, however, the floods only occur at long intervals and last a short time, the low-land drains which enter the main stream may be protected by sluices with fixed or self-acting doors. The latter would close by the action of the water as soon as the level outside became greater than that inside, and open again for the emission of the inland water as soon as the flood had passed off. By a judicious management of these sluices the land behind the banks can be kept well drained. If the sluices have fixed doors, the person under whose care they are placed, as soon as a heavy rain comes, ought, in anticipation of a flood, to open the door and empty the drain, which would then become a reservoir to receive and hold the water percolating from the rain on the low land until the height of the flood had sufficiently subsided to allow of the doors being opened. The best form of sluice has a double set of doors, the one self-acting, and the other so fixed as to regulate at pleasure the height of the water in the drains. The engraving (Fig. 3, p. 30) represents one of these sluices with a four-feet opening and self-acting tankard-lid door, with draw-door behind.

In tributary streams, self-acting doors, shutting against the river into which they drain, are often very beneficial in preventing the backing-up of the water in heavy floods. By their use many miles of embankment may be saved. Even where embankments exist, the erection of doors saves great pressure and the consequent risk of a breach, a contingency from which no banks are free. Some settlement, or weak place in construction, or burrow made by mole, rat, or rabbit, which may have been in existence for years unknown, is finally discovered by a flood a



few inches higher than usual. The water first trickles through, the hole gradually enlarges, until, without warning or time for preparation, the bank bursts and a whole level is inundated, and crops and property destroyed to the value of many thousands of pounds.

Fig. 3.—*Elevation and Section of Sluice with Tankard-lid Door.*

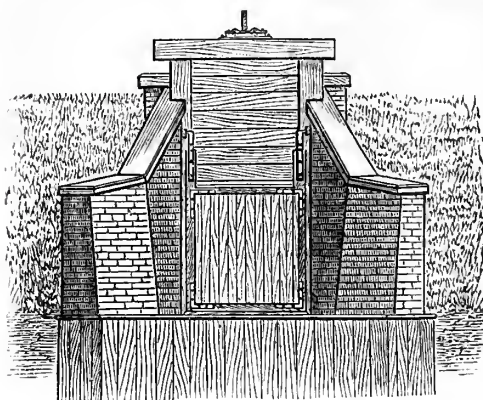

ELEVATION

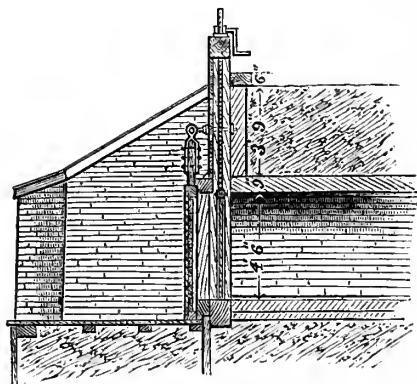

SECTION

In streams discharging into tidal rivers, or on the sea shore, doors are necessary as a protection against the tides. The situation of the outfall in such cases should be chosen where the set of the tide is on a concave shore, and where, consequently, the water is always deepest and the outlet the least likely to be blocked by shoals in dry weather. The cill of the sluice should be placed below the level of low-water of spring tides, the exact distance being a matter of controversy, but two feet may be taken as a safe distance.

The simplest form of sluice consists of a wooden tunnel made of four 3-inch planks nailed together, with a door or clapper at the outer end hung at the top with crooks and bands, and falling over the opening of the trunk of discharge. The door is kept closed as the tidal water rises and presses against it. Cast-iron flanged pipes, bedded in concrete, bolted together, with a strip of vulcanised india-rubber between the flanges, make a more durable sluice. The door ought to be planed smooth, and have a strip of gun-metal inserted in the face of the frame against which it shuts. The rod on which the door hangs should also be of gun-metal, otherwise it is liable



to become fast with corrosion, caused by the salt water. Larger sluices are built of brick. When the openings do not exceed from 2 to 4 feet in diameter, a single door hung from the top with crooks and bands, and inclined at a slight angle from the vertical, technically called a "tankard-lid door," is used. For larger openings the doors are hung vertically, and swing on pins working in a socket at the bottom, and with a collar and strap at the top. They vary in size from a single door for a four-foot culvert to the large double doors used on tidal streams in the Fens, with openings of 20 feet, and from 20 to 30 feet in height. A further description of these large sluices, however interesting, would be foreign to the purpose of this paper.

#### DRAINAGE OF LOW-LYING LAND.

*Raising Water from Low Levels.*—When the land to be drained lies below the ordinary flood-level of the outfall stream, mechanical means must be adopted to ensure efficient drainage. Originally this was accomplished by wind-engines and scoop-wheels. Windmills have been extensively used in Holland for drainage purposes, where the practice was to employ one mill with sweeps from 80 to 90 feet in diameter for every 1250 acres drained. These mills work about sixty days in the year on an average.\* But these engines, not being made on improved scientific principles, do not yield the same amount of work as those of modern construction. The Dutch engineers introduced them into the Fens of Lincoln and Cambridge, and many instances may yet be found in these counties of wind-engines draining large tracts of land. The high state of cultivation practised in the Fens has rendered efficient drainage of so much importance that the uncertainty of the wind has caused it to be almost entirely superseded by steam, and the scoop-wheel also is gradually giving place to the centrifugal pump. It is doubtful whether in thus entirely abandoning the power of the wind a wise course has been pursued, and whether the better and more economical plan would not have been to have supplemented the wind with steam, using the latter only when the wind failed. There are many bogs and tracts of pasture land which would not bear the expense of steam-power, but which could be sufficiently drained by small wind-engines and scoop-wheels.

The scoop-wheel is the simplest form of pump, and well adapted for the drainage of small areas, as it can be worked either by wind, horse-power, an ordinary locomotive, or a fixed engine. It consists of a wheel, not unlike the paddle-wheel of a

---

\* Burnell's 'Hydraulic Engineering.' Weale's Series, 1858.

steamer, revolving in a trough with a self-acting door at the end towards the stream into which the water is lifted, which door closes directly the wheel ceases working. The wheel beats or carries the water on the ladles or floats from the lower to the upper side. The lift, or height which the water is raised, and the quantity lifted depend on the diameter of the wheel, the width of the floats, and the number of revolutions in a given time. A series of articles describing scoop-wheels, both theoretically and practically, will be found in 'Engineering' for the year 1870, vol. ix. The illustration, Fig. 4, is a plan and elevation showing the

Fig. 4.—*Elevation and Plan of Scoop-wheel, with Shuttle for regulating Water to it.*

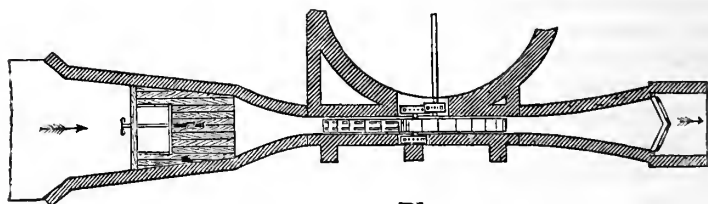
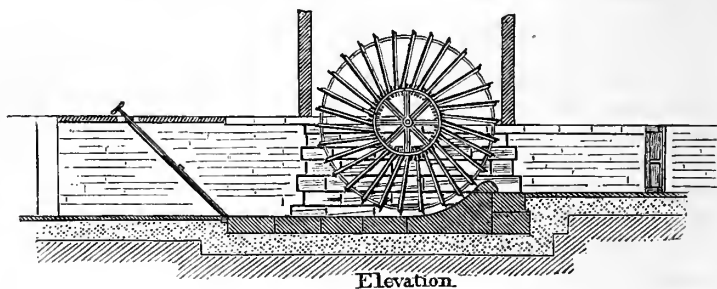

wheel and the trough in which it works. These wheels vary in capacity from the size sufficient to drain a small tract of 50 or 100 acres to the immense wheels used in the drainage of many thousand acres of Fen land. The drainage of Deeping Fen, in Lincolnshire, containing 25,000 acres, is effected by two of these wheels worked by powerful steam-engines. The larger wheel is 80 feet in diameter and 28 feet wide, and the two are capable of lifting 300 tons of water a minute, the lift or head of water against which the wheels work being sometimes as much as 6 feet. The drainage of the East Fen, in the same county, containing about 30,000 acres, on the other hand, is effected by two Appold centrifugal pumps worked by high-pressure con-

densing-engines. The fans of the pump are 7 feet in diameter. The lift is 5 feet, and with this head the two pumps can discharge 700 tons of water a minute.\*

The defect of the scoop-wheel is that it cannot adapt itself to variations in the level of the water in flood times, either on the delivery or inlet side. It cannot be driven beyond a certain speed, and if deeply immersed in water it does very bad duty. It is much more cumbrous than a centrifugal pump, and consequently requires more expensive foundations. The relative proportions of a scoop-wheel and a pump to deliver water, say with an 11-feet lift and engine of 14 horse-power, would be as follow: diameter of scoop-wheel 40 feet, width 18 inches, number of revolutions  $4\frac{1}{2}$ . Diameter of pump 3 feet 4 inches, width  $8\frac{3}{4}$  inches, number of revolutions 180. Centrifugal pumps employ advantageously the whole power of the engine; as the lift decreases, so the quantity of water discharged increases, and that in an automatic manner, without any sensible alteration in the speed of the engine, and without any care on the part of the attendant. It is found in practice that centrifugal pumps do keep the land clear with less horse-power, and therefore less fuel per acre, than scoop-wheels. In a comparative trial in six districts drained by pumps and scoop-wheels respectively, the area drained ranged in the case of pumps, from 1000 to 1228, and in the case of scoop-wheels from 600 to 830 only per unit of power employed.† The illustration (Fig. 5, p. 34) shows a pump and engine attached to an iron cylinder, as manufactured by Messrs. Eastons and Anderson, and peculiarly well adapted for fixing in peat soils, where it is difficult to secure a good foundation without great expense.

At a rough calculation, it may be assumed that for the drainage of fens or low-lying districts, from 1 to  $1\frac{1}{2}$  horse-power will be required for every 100 acres where the lift does not exceed 10 feet.

*Dumb Wells.*—Where the nature of the subsoil is of a porous and absorbent character, as chalk, limestone, or some sort of sandstone, the quantity of water discharged in flood times may be regulated by dumb wells sunk into the porous strata. By means of these shafts the capacity and cost of new arterial drains may be reduced, and flooding prevented without altering existing water-courses. In the illustration, Fig. 1, p. 11, a shaft sunk through the impermeable strata, between the letters B

\* 'History of the Fens of South Lincolnshire.' By W. H. Wheeler, C.E. Simpkins and Co., 1868. 'Trans. Instit. Civil Engineers,' vol. xxxiii.; Engineering, Sept. 18 and 25, 1869.

† Paper by J. M. Heathcote, Esq., in the 'Cambridge Independent Press,' Nov. 24, 1877.

Fig. 5.—Centrifugal Pump Engine and Iron Cylinder.

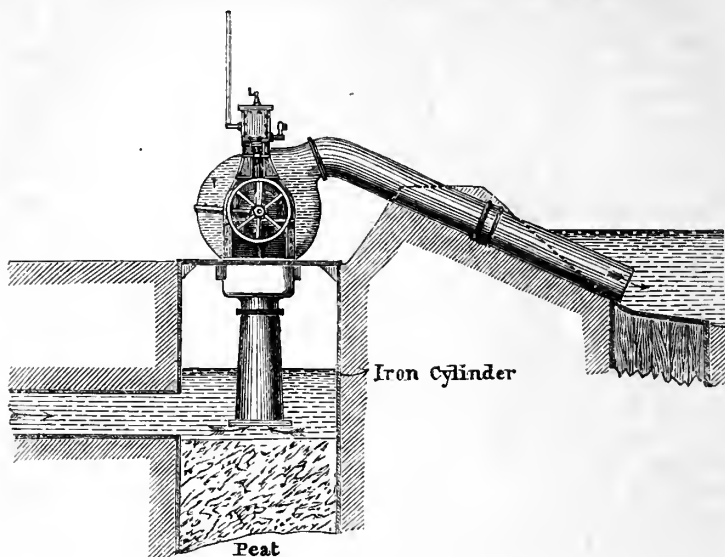

Scale: 8 feet to an inch.

and H, would let the water down to the porous strata below, and lessen the quantity falling into the water-course at H. An instance is given by Mr. Homersham, in which the chalk was covered with clay 18 feet in thickness, and effective drainage obtained by sinking dumb wells through the clay and filling them with flint stones. The rain, instead of flowing off by surface channels into the rivers and causing floods, was absorbed into the chalk, and escaped underground to the sea.\* On Lord Dillon's estate in Oxfordshire, Mr. Bailey Denton brought the drainage of several hundred acres to a shaft 3 feet in diameter, sunk from 20 to 30 feet into the oolite, and thus disposed of the whole of the water.† The basin of the Colne, a tributary of the Thames, has no outlet for flood waters excepting by "swallows," the soil of the district being drift clay, gravels, sands, with chalk beneath at considerable depths, the beds of which dip away from the valley.‡ In the oolitic limestone the waters from ditches may be frequently seen, when running a full stream from 18 inches to 2 feet deep, to disappear from the surface and be absorbed by swallow holes.

*Outfalls.*—The consideration of the improvement of main out-

\* 'Trans. Instit. Civil Engineers,' vol. xxii, "On the Upper Thames."

† Bailey Denton, 'Evidence, House of Lords' Committee on Conservancy Boards,' 1877; QQ. 2461, 2471, 2473.

‡ Beardmore's 'Manual of Hydrology.'

fall channels for brooks and water-courses, and without which all other works must prove abortive, is beyond the scope of this article, the works being of so comprehensive a character, as only to be dealt with by a properly constituted Conservancy Board under the guidance of a qualified engineer. There are, however, many small streams and outfall drainages which discharge into estuaries or on the sea coast, the improvement of which is essential for the proper maintenance of the system of drainage to which they afford an outlet. These streams often have to find their way to the main channel through a long foreshore of alluvial deposit, and are diverted from their course and impeded in their flow by the action of the tides and by the deposits washed into them. They are generally so wide and shallow that the outflowing water has not sufficient power to maintain a free course. The remedy is to concentrate the whole force of the outflowing stream in a narrow and deep channel. This is sometimes done with stakes and boarding, or by stones and clay. The Dutch and American engineers use faggots and brushwood made into "mattresses," secured in their places by piles, and sunk by being weighted with stones; and by this means they train and regulate currents of very considerable velocity.\* A very effective yet simple and economical plan has been adopted in training the Fen rivers discharging into the Wash, and is equally applicable to creeks and small outfalls. The training walls are constructed of faggots or fascines, made of thorns cut from the hedges, bedded in clay. The fascines are about 6 feet in length, including the long legs or projecting branches, and 3 feet in girth, the butt-ends of the thorns being all placed one way and tied together with tarred string. They are placed along the side of the intended channel in a single or any greater number of rows, according to the depth and force of the current to be dealt with, and covered with a layer of about 6 inches of clay, the process being repeated, layer after layer, until the surface of the foreshore is reached, the usual height in the large rivers being half-tide level. If properly laid, training walls thus constructed may be placed in a channel with 20 feet in depth at low-water, and will resist the force of both ebb and flood-tides, and form a permanent and lasting barrier where stone would be washed away. The cost of this work is about 1s. 8d. per cubic yard. A full description of this process, in connection with the training of the outfall of tidal rivers and the reclamation of the foreshore, will be found in the 'Transactions of the Institution of Civil Engineers.†

---

\* "Use of Fascines in Holland," 'Trans. Instit. Civil Engineers, vol. xli.

† Wheeler on 'Fascine Work and Reclamation,' vol. xlvii.



## FLOODING.

In providing for any new system of drainage, although the primary motive may be to void the surplus rainfall from the land as quickly as possible, yet other considerations should be taken into account and the fact not lost sight of, that the modern system of drainage has a tendency to bring about droughts in summer, the effect of which may be as disastrous as floods in winter. The point to be gained is the proper control and regulation of the water arising from the rainfall, and so to devise schemes of improvement as to have thorough mastery over both discharge and storage, verifying the old adage that "water is a good servant but a bad master." There are districts where floods, if not allowed to remain too long on the land, do absolute good to grass, by depositing on it matter of a fertilising nature washed from calcareous and marly soils. In the same watershed there may be streams the water from which, having passed over ferruginous and siliceous soils, does great damage; the grit, in the latter case, deposited on the leaf of the grass, purging and otherwise injuriously affecting the cattle that feed on it.\* An instance of this occurs in the valley of the Hampshire Stour, as described by Lord Malmesbury in his evidence before the House of Lords' Committee on Floods, where his Lordship is reported as stating that on the Stour the farmers want five or six floods in the year, a fine marly warp, which is very enriching, being brought down by the water and deposited. The water flowing from the New Forest by another stream in the same district is impregnated with a great deal of chalybeate matter, which is very pernicious, and does a great deal of harm to the meadows. If floods were done away with on the Stour, the deterioration of the land would be immense. The flooded meadows let at 3*l.* an acre; whereas those higher up the stream, which are not flooded, let for only 15*s.* an acre.†

The Clerk to the Thames Valley Drainage Commissioners, Mr. Hawkins, in his evidence before the same Committee also stated,‡ that there would be the greatest opposition in the Thames Valley if the people thought that the floods on the grasslands were to be entirely stopped in winter. They are very valuable as long as the water can go on and off, and not be left lying on the land and spoiling the grass. In his opinion the object of any legislation should be to regulate the floods, and to pass them off instead of letting them lie on the land. Mr. Bailey

\* 'Report and Evidence of Committee, House of Lords' Conservancy Boards,' Session 1877; Evidence, Taunton, Q. 2206; Denton, QQ. 2418, 2421, 2422, 2425; Lowndes, Q. 2537.

† *Idem*, Q. 2582 *et seq.*

‡ *Idem*, Q. 2749.



Denton also gave evidence to the effect that, in his opinion, a flood passing over the surface of meadow land quickly does good (unless it be impregnated with injurious substances), but if it is detained for days great injury results. On being questioned, however, as to whether, striking a balance of advantages and disadvantages, he would rather have a flood on meadow land or have it altogether excluded, he replied, "Decidedly excluded, *that which a man cannot be master of is generally an evil.*"

*Regulation of Water.*—Flood regulators may be either natural or artificial. The former exist where the subsoil is of a porous and absorbent character, and where the strata are so arranged that the water received into and stored up in the pores of the soil and the clefts and seams of the chalk or stone is given out again gradually in the form of springs within its own watershed. These reservoirs are the most valuable of all regulators for water supply, as a perennial flow of wholesome water is kept up in the stream even in the driest summers. The supply from this source might be materially increased by the formation of the "swallow holes" or dumb wells, already described, and the water thus preserved to its own proper district in the wet season instead of being allowed to flow away to sea. In many districts there are lakes which perform the part of flood regulators; the outlet not being of sufficient capacity to discharge the water poured into it during heavy rains from the hill or mountain streams, it becomes stored up for the supply of the rest of the year. In the drainage of the Kilbeggan district, in Ireland, the flood waters of a large portion of the catchment basin were taken to Loch Ennell, and only delivered out by degrees, thus giving a command over the floods of the district to facilitate the drainage and supply the mill-power.\* The Lakes of Cumberland and Westmoreland act as valuable regulators of the exceptionally heavy falls of rain which occur in that district, and many other instances could be cited. On the smaller brooks and water-courses valuable storage for the water supply of farmsteads and villages could be provided by the formation of large ponds or artificial lakes on the higher part of the stream. These, while acting as valuable reservoirs for the summer supply, might be made an ornamental feature in a park; but, where this is not practicable, they would pay an ample rent for the ground occupied.

However valuable lakes and reservoirs may be as regulators of small streams, it is an utterly fallacious idea to suppose that the floods of such rivers as the Thames could be prevented by any artificial system of storage: a remedy often proposed by those who have not paid sufficient attention to this subject. It has

---

\* Report: Drainage of Lands (Ireland), House of Lords, 1852.

been calculated that to provide storage for the water flowing off the drainage ground of the Thames above Hampton from a fall of three inches of rain, would require a reservoir capable of holding more than one hundred and sixty thousand million gallons, and that its construction would entail an expenditure of 15,000,000*l*.\* This plan of dealing with floods was tried by the Dutch engineers. In the original scheme laid out by them for the drainage of the Fens on the east coast, the banks which enclosed the rivers were placed at great distances apart, in some instances as much as a mile, the intervening spaces being left to receive the water coming down from the high lands in great floods, and to store the excess beyond what the river could take until the flood abated. These spaces are called "washes," and form very valuable pasturage in summer. On the Nene, immediately below Peterborough, the wash-lands are 12 miles in length and half a mile broad, the level of the land being about that of the ordinary winter flow. The space occupied represents about 1 per cent. of the area which drains into it. In floods, these washes are filled to a depth of from 5 to 7 feet, the latter quantity representing about 1 inch of rainfall from the drainage area; and yet, with this provision, the Nene is found utterly inadequate to the discharge of the rainfall in wet seasons. The floods along its valley are matters of notoriety, the water held in these washes forming only a very small proportion of the quantity which ought to flow down the river.†

The regulation of streams the fall of which is too rapid may also be effected by canalising them, dividing the channel into sections, embanking the sides and fixing weirs or floodgates. This system is carried out wherever the water is made available for mill-power, and may be made of great advantage where irrigation is used, or where the practice prevails of keeping the ditches dividing the fields full of water to within a certain distance of the surface. There can be no doubt that however important thorough drainage of the soil is for the prevention of evaporation from the surface during winter, in light porous soils and pasture-fields an equal advantage may be gained by maintaining the water-level in summer at such a distance below the surface as not to be too deep to permit the water to rise up to the roots by capillary action. This can be effected by keeping the water in the ditches and streams during the summer, which may then serve not only as water-regulators and reservoirs, but also as fences. In the Fens this is universally the practice. In the main drains, where not used for navigation, water from

---

\* "Rainfall and Evaporation," 'Trans. Instit. Civil Engineers,' vol. xlv.

† Shelford, 'Trans. Instit. Civil Engineers,' vol. xlv.

5 to 6 feet in depth is always maintained, the surface being from 4 to 5 feet below the ordinary level of the land. From these main-drains and the high-land streams which discharge into them the ditches are always kept filled; in the peat soils to within 2 feet of the surface, and in silty soils from  $2\frac{1}{2}$  feet to 3 feet. Thus, by the rapid removal of surplus rainfall in winter and a due supply of water in summer, soils which once were only a refuge for moorfowl are now made to grow splendid crops of wheat and roots, and yield a rent of more than 3*l.* an acre.

The large crops of grass obtained from irrigated meadows, and the heavy rents paid for such land, tend further to show that water-supply is as valuable as drainage, and that it is the regulation of the supply that should be the guide in all schemes for the improvement of water-courses.

#### DOMESTIC WATER SUPPLY.

Water for domestic and agricultural purposes is becoming a paramount necessity, both as a matter of economy and as an essential to health. The increasing vigilance of sanitary authorities will eventually compel every landowner to provide a proper supply for his cottages, and the high price and scarcity of labour will make it more economical to pay the interest on the money required to store or provide an adequate quantity of water, than to have to fetch it with a cart and horse a considerable distance from the nearest source of supply. The facility for carrying out works of water-supply has been increased by the Act passed last Session enabling land-owners to charge their estates with the cost of the necessary works for storage.

There is no difficulty as to the sufficiency of water—it is simply the means of storing and preventing waste that are wanted—sufficient rain falls even in the driest districts of this country to supply all the wants of the inhabitants. The quantity used in a house varies considerably, depending a great deal on the facility with which it is obtained. In cottages where the water has to be fetched from the village well, 2 gallons a day for each inmate will be the most that is used. If an abundant supply is provided close to the house, the quantity used will rise to 5 gallons a head, or say 25 gallons per day on an average to each cottage. A small farmhouse, where there are neither baths nor water-closets, will require about the same quantity per inmate. For the larger class of farmhouses, for vicarages, and for mansions, 20 gallons per day for each inmate should be provided. In towns the quantity supplied varies from 10 gallons per head, where good management prevails, to 50 gallons, where great waste takes place. This includes all water required for watering

streets and for manufacturing purposes. The minimum requirements of a farmstead of 100 acres would probably be as follows:—

The farmhouse containing on an average six inmates	Gallons.
at 5 gallons each . . . . .	30
For the stack-yard and cattle-sheds . . . . .	50
A labourer's cottage containing five inhabitants . . . . .	10

To this must be added the water required for feeding the steam threshing-engine, and for watering the stock in the yards in winter, which would require about 20,000 gallons more. The house would thus require 10,950 gallons, the farmstead 38,250 gallons, and the cottage 3650. A careful storing of all the rain which falls on the roofs of the buildings, allowing the rainfall to be 22 inches in the year, and the farmhouse and out-buildings to cover 1000 square feet of ground, would yield 11,419 gallons, or a little more than 31 gallons a day. The farm-buildings and sheds would cover about 3500 square feet, and collect 39,965 gallons, equal to a supply of 110 gallons per day; and the cottage, with 500 square feet, would yield 5700 gallons, equal to 15½ gallons per day. The tanks to hold this should be so proportioned as to be large enough to hold the winter supply, and allow for replenishment by thunderstorms and ordinary showers; a capacity equal to about 2 gallons for every square foot of roof will, on an average, be found sufficient. In some villages the water off the roof of the church and school-houses has been collected in a large tank for the use of the inhabitants, and been found of the greatest convenience, saving many a weary drag to the village pond. An ordinary village church would cover about 7000 square feet, and the school 1000 more, and these together would yield 91,356 gallons in the course of the year, equal to a daily supply of 250 gallons.

*Reservoirs, Storage, and Village Supply.*—If the cottages and farmsteads, instead of being isolated, lie compactly in a village street, a more effective and probably more economical plan will be to provide one large storage reservoir, with supply pipes to the village, and “stand-pipes” or separate services to the houses. Where there is a constant spring or stream of pure water above the village, the process is extremely simple, but where these means are not available, storage must be resorted to. As a matter of economy, where there is a constant fall and no pressure on the pipes, glazed stoneware pipes, having Stanford's patent sockets and joints, may be used; but where there is any pressure, or where the pipes are laid at any great depth below the ground, iron is the only satisfactory material.

The supply from the gathering ground for feeding this reservoir must be calculated on the result of the driest years and the

storage room adapted for the same period. On the eastern side of England, Mr. Hawkesley states that periods have occurred where, in dry seasons, 250 days have elapsed from the first lowering of the water in the reservoirs to the commencement of its re-elevation.\* Speaking generally, storage for 150 to 180 days will be found sufficient. The quantity of rain to be depended on in dry seasons may be ascertained by finding the average fall of the district and deducting one-sixth, the result almost as an invariable rule giving the available rainfall of three consecutive minimum years. Taking, as before, 22 inches as the average rainfall, the quantity to be relied on would be 16 inches. From this must be deducted the loss from evaporation and absorption by vegetation, &c., which varies from 10 up to 18 inches in extreme cases. The mean may be taken at 14 inches, leaving only 2 inches to be stored. This rainfall on an acre of drained land will yield 45,229 gallons (7260 cubic feet). The superficial dimensions of the reservoir will depend on the supply required; the depth, however, ought not to be less than from 6 to 7 feet, as with this depth there will be less loss from evaporation and the water will keep better. In retentive clay soils, it may be found sufficient merely to form the reservoir in the soil by excavation; but where the strata are porous, the sides and bottom must be puddled, or lined with concrete or brickwork. In the latter case the excavation will not require to be carried the full depth of the reservoir, the walls being built partly above the surface and being backed up with the excavated material. A small village, with mansion, vicarage, gardens, stables, farmsteads, and cottages, would require about 2,000,000 gallons of water in the course of the year, and, allowing storage for 180 days, would require a reservoir 7 feet deep and about 150 feet square, and a gathering ground of 50 acres. The cost of supply from such reservoirs to villages may be taken roughly at from 20s. to 25s. a head of the population. Mr. Bailey Denton calculates that 1 inch of rainfall on an acre would supply two and a-half persons with water for a year, at the rate of 25 gallons each.† At this rate, 120 acres would be required instead of 50.

This outline of the requirements of village water-supply is sufficient to give a general idea of what is necessary. The special means to be adopted in any particular locality must depend upon the circumstances of the district: no scheme generally applicable can be laid down.

A typical case, showing how easy it is for a private individual to carry out works of water-supply, will be found in the

---

\* "Water Supply, Paisley," 'Trans. Instit. Civil Engineers,' vol. xxxi.

† 'Storage of Water.' By B. Denton. Spon and Co., 1874.

evidence given before the Floods Committee by Mr. G. G. Macturk.\* This gentleman has executed works for the supply of a village of 800 people, and has found them remunerative and very acceptably received by the inhabitants. At a cost of 1000*l.* he has laid down about 3 miles of iron pipes, connected with a brick reservoir receiving its supply from a strong land-spring. From this main the cottages in the village and the farmhouses are supplied. There are altogether 120 tenants using the water, the charge varying from 5*s.* a year for a cottage to 20*s.* for a farmhouse; the total rental at present being 70*l.*, sufficient to pay 5 per cent. and provide for a sinking fund. The pipes were laid along the roads, with the consent of the Surveyor of Highways, and the supply is not confined to Mr. Macturk's own tenants.

Another illustration of the method of supplying large mansions and of affording a complete protection against fire will be found in the description given by Mr. R. B. Grantham, before the Institute of British Architects, of the works designed by him at Somerley for the Earl of Normanton.† The supply is obtained from a stream fed by strong springs from the Bagshot sand and gravel. The water is collected in a service-tank, whence it descends to a pumping well and is forced to a high-level reservoir, 100 feet above, by a steam-engine, which is also used for sawing timber and other purposes. The reservoir is upwards of 2 miles distant, is built of concrete, and is capable of holding 150,000 gallons; and the bottom is 7 feet above the tops of the roofs of the mansion. The main pipes from the reservoir are of iron, 6 inches in diameter. From the main are laid service-pipes to the house, flower- and kitchen-gardens, stables, laundry, and cottages. Hydrants are attached to the house-service, and the whole forms a most elaborate and complete system of domestic supply and fire-service for the protection of every part of the house, which contains valuable collections of statuary, paintings, &c. The total cost of the whole service of pipes and reservoir, but exclusive of the engine, which exerts about 4 horse-power when pumping, was 2000*l.*, and the annual cost about 40*l.*

In this case the valuable nature of the property to be protected rendered an effective fire-service necessary, which added very materially to the cost. A simpler case, which will be representative of the requirements of a much larger class of houses and homesteads, will be found in the neighbourhood of Grantham. The premises consist of a large farmhouse, farm-buildings, and

\* 'Report on Conservancy Boards, House of Lords,' 1877; Q. 2143 *et seq.*

† Grantham on the 'Water Supply of Country Mansions.' Stanford and Co., 1874.



stock-yards; with stables for nag-horses and hunters; cottages for grooms, foremen, &c. The supply is derived from a well sunk about 160 feet into the oolitic limestone, and the pumps are worked by a small wind-engine, with self-regulating sails fixed on a skeleton frame over the well. The water is forced into two wrought-iron tanks; one on the top of the house for the domestic supply, and the other on the roof of one of the farm-buildings for the cattle-yard, stables, and cottages. The tanks are large enough to hold three or four days' supply, to allow for times when the wind is too still to work the engine. There is also provision for working the pumps by hand-labour, in case of failure of the motive power. The cost of the wind-engine, fixed complete, was 45*l*. The cost of the pumps and tanks, being fixed at different times, is not exactly known, but the cost of the whole supply, complete, may be taken at about 100*l*.

These illustrations are sufficient to indicate the economy and ease with which water may be supplied to villages and mansions. Where the source of supply flows at an elevation above the locality to be supplied, the force of gravity is sufficient to move the water through the pipes. When, however, it has to be lifted, it may be accomplished by one of the many machines which exist, each being more or less efficient according to the quantity of water at command and the fall to be obtained.

*Engines for Raising Water.*—The simplest form of machine is the "Shadoof," which was used by the Ancient Egyptians for lifting the water from shallow wells or from the river for irrigation and water-supply, illustrations of which may be found on many of the ancient monuments. The use of the pole and bucket is still common, not only in Egypt but in many parts of Europe, for raising water from wells. The water-wheel was not unknown to the Egyptians, though it does not appear to have been used very generally, this and the hydraulic screw having been probably of later introduction.\* The shadoof consists simply of a pole working on an axis. The pole is weighted at one end and a bucket is attached to the other. The illustration (Fig. 6, p. 44) shows the method of raising the water from the river by a series of steps.

The simple contrivances used for working saw-mills and other machinery in hilly districts, where a wooden trough carried on tressels brings the water from the neighbouring stream to the top of a large wheel, with buckets formed on the periphery, shows how ready the mechanic is to take advantage of all available resources for working his business in preference to employing that most expensive and troublesome of all motive power—

---

\* 'The Ancient Egyptians.' By Wilkinson. Murray, 1874.

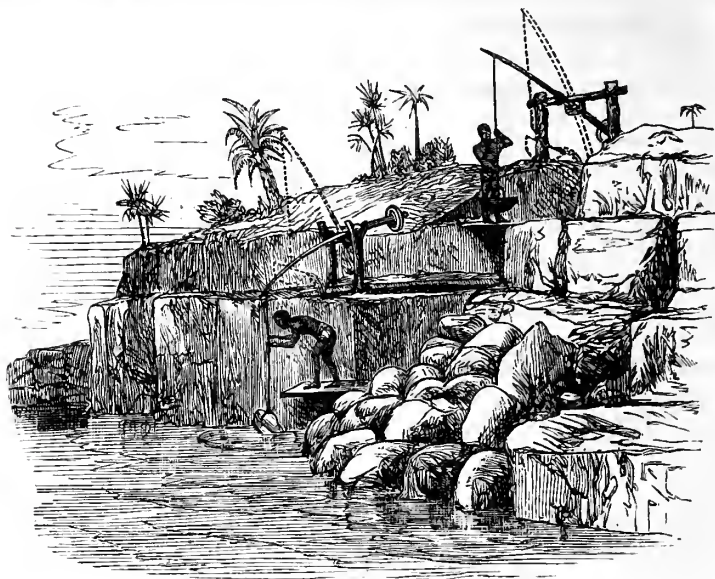
Fig. 6.—*Modern Shadoof, or Pole and Bucket, used for raising water.*

human labour. Generally these water-wheels have been fitted up more with regard to simplicity and economy of cost than to an effective use of the motive power. Where water is plentiful, this may not be a consideration. A turbine will, however, be found a more compact and effective machine, and it has been extensively adopted on the Continent, but much less patronised in England than it deserves. The turbine is a water-wheel, having generally a vertical axis, to which motion is imparted by a column of water entering at the centre and passing off at the circumference. It can be worked at either high or low pressure. In the former case it is driven by a small body of water having a high fall, and therefore suitable for erection in hilly districts where the supply of water is small and variable, and facilities exist for the construction of reservoirs; the latter kind of machine is adapted for a large body of water having a low fall, in some cases not more than 9 inches.\* Turbines require very little masonry in fixing, and can be worked with a useful effect of from 75 to 80 per cent. The illustration (Fig. 7) shows one of Messrs. J. and H. Gwynne's horizontal turbines, fixed for working a set of pumps or other machinery.

---

\* For a full description of these machines, see 'Spon's Engineering Dictionary,' Art. "Turbine."

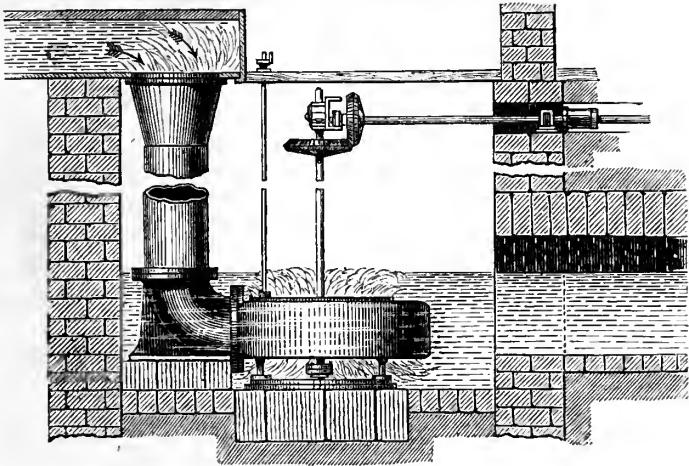
Fig. 7.—*Schiele's Turbine.*

The Ram is a simple and beautiful instrument in frequent use for raising water from a stream for the supply of mansions and gardens. It requires very little fixing and occupies only a small space. It supplies at once the motive power and the pump, without the aid of any other force than that produced by the momentum or moving force of a part of the water to be raised. So great is this effect, that a moving column of water will overcome and move another column 30 times the height of the waterfall by which it is raised, with a waste of only from 30 to 40 per cent. of the actual power of the water employed. For example, with a fall of 5 feet, 7 gallons of water only will be required in the best form of ram for every gallon raised 25 feet; or, with a 10-foot fall, 14 gallons will be required to raise 1 gallon to a height of 100 feet above the ram; and so in like proportion as the fall or rise is increased or diminished. These machines will go on working night and day without attention, are simple in construction, and seldom get out of order. To estimate the quantity of water that a ram will raise from a stream, it is necessary to multiply the number of gallons of water available from the stream per minute by the height in feet through which the water falls before it acts on the machine, and by  $\cdot 70$ , to allow for loss in working the ram; then to divide the product by the height in feet to which the water has to be raised, and the result will be the number of gallons which the ram will raise per minute. The illustration (Fig. 8, p. 46) gives a section of the ram, showing the working parts. The water, escaping through the supply-pipe with a velocity due to the height of the fall, forces

the larger ball out of its muzzle, and raises it to the orifice, which it immediately stops.

Fig. 8.—*The Hydraulic Ram.*

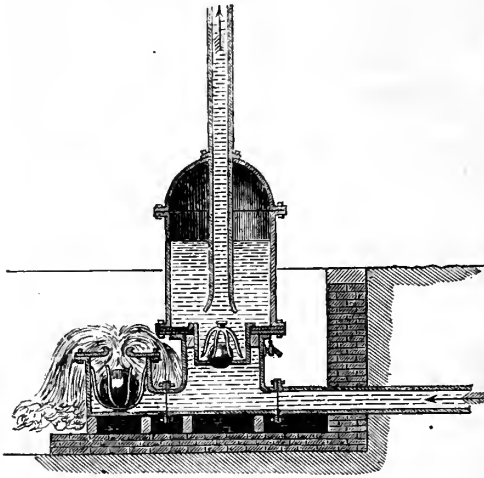

The momentum of the water raises the other valve, and the force of the water, compressing the air, is driven up the supply-pipe. The ball soon loses the velocity imparted to it, and descends by its own weight, when the same process is again repeated. A full description of the different kinds of ram will be found in Tomlinson's 'Cyclopædia,'\* under the article "Hydrostatics."

There are many cases, however, where the supply can only be obtained from a reservoir or water-course situated at a lower level than the locality to be supplied, and without sufficient fall to work an hydraulic engine. In this case the most effective power is steam; but unless this can be used in conjunction with other works, as in the case quoted above, the cost is too great for such supplies as are here treated of. Wind, however, supplies a cheap and, although at times intermittent, a fairly effective motive power, costing nothing in the way of fuel and little in the way of attention. Small wind-engines, fixed either on the top of the highest farm-building or on skeleton frames of wood, are coming to be very extensively used for pumping, and for working chaff-cutting machines and mills for grinding meal. In America they are much more extensively used than in England, and a full description of the American wind-engines, with illustrations, will be found in the last volume of the 'Journal' at page 67.† In the Colonies, and in India also, great numbers are in use for supplying water to the tanks at the railway stations. In Australia, where drought prevails for many months in the summer, and where manual labour is exceedingly expensive, the water used for the vineyards, for agricultural purposes, and for the large horse, sheep, and cattle

\* Tomlinson's 'Cyclopædia of Arts and Manufacturers.' Virtue and Co., 1866.

† 'Journal of the Royal Agricultural Society,' Second Series, vol. xxiii., 1877.

runs, is all raised by wind-mills from wells averaging about 38 feet deep.

Wind-engines with self-regulating circular sails, so constructed as to be secure in a storm, are made of all sizes. One with a sail 6 feet in diameter is capable of working a pump of  $1\frac{1}{2}$ -inch bore. A sail 15 feet in diameter is equal to about 1-horse-power, and costs 50*l*. Gearing and a shaft for horse or pony to supplement the wind may be worked in connection with these engines, but this is unnecessary where a tank or reservoir can be provided of sufficient capacity to hold three or four days' supply. The illustration (Fig. 9) shows one of Warner and

Fig. 9.—*Warner's Patent Windmill, with Annular Sails, Pumps and Horse Gear.*

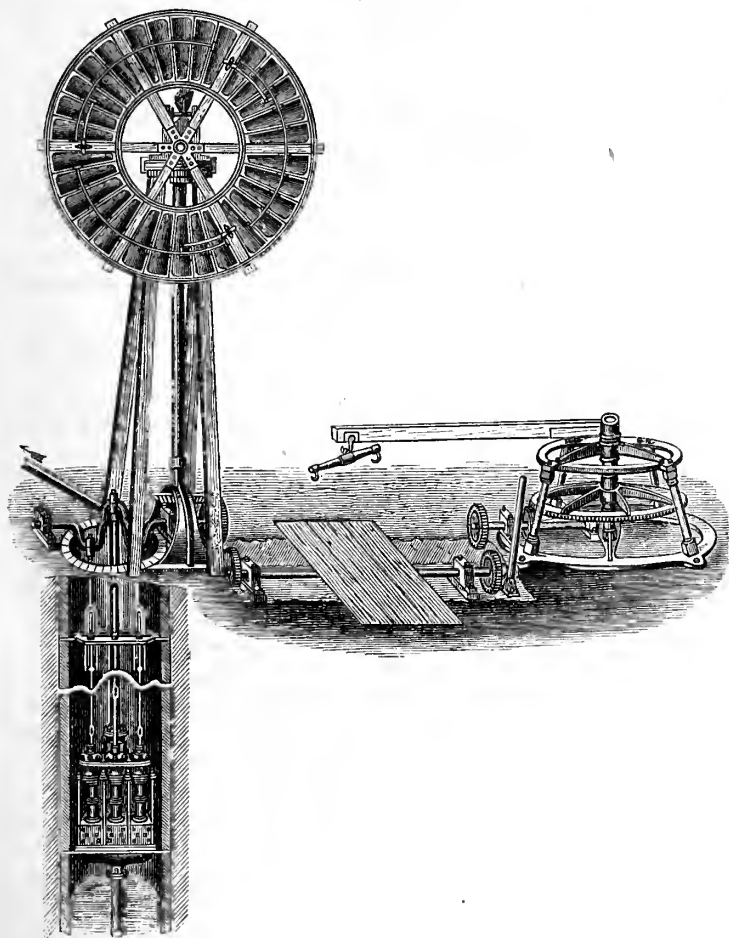

Co.'s patent windmills, with annular sails fixed for working a set of pumps, and with horse-gear attached.

Wind-engines with four or five arms and cloth sails are very inexpensive, and much more simple in construction than those with annular sails, and will be found in frequent use in brick-yards for working a pump for emptying the brick-pit in winter time. If made with self-regulating wind-gear and patent wooden sails, they are more costly, but very effective little machines, applicable to a great variety of purposes. The next illustration (Fig. 10) shows one of these engines, as supplied by Messrs. Owen and Co., for working a pump from a deep well.

Where the supply is not required at a great elevation, as, for example, for a small railway station or farm-yard, the tanks are frequently constructed of wrought iron, and placed on the top of the framing or tower carrying the sails. Such a tank could be made to hold about 1200 gallons.

The pressure of the wind acting on any surface, expressed in pounds on one square foot, is equal to the square of the velocity of the wind in miles per hour, multiplied by  $\cdot 0049$ .

The following table gives approximately the velocity and force of the wind, and the corresponding numbers of the Beaufort Scale used to denote its force by sailors and in the daily weather reports in the newspapers.

Miles per Hour.	Force on one Square Foot.	Corresponding figure of Beaufort Scale.	
1	..	0	Calm.
5	2 oz.	1	Hardly perceptible.
10	$\frac{1}{2}$ lb.	2	Light breeze.
20	2 lbs.	3	Good steady breeze.
30	$4\frac{1}{2}$ "	4 to 6	High wind.
40	8 "	7	Gale.
50	12 "	8	Storm.
60	18 "	9	Heavy storm.
70	24 "	10	Hurricane.
80	32 "	11	Hurricane.
100	50 "	12	Tearing up trees, &c.

It has been found practically that a wind moving with a force of less than 10 miles an hour is not able to insure the working of a corn-mill; when the velocity exceeds 20 miles an hour it is necessary to furl the sails.\*

To find the power given off by a wind-engine, the area of the sails in square feet must be multiplied by the cube of the velocity of the wind in feet per second, and the product divided by

\* Burnell's, 'Hydraulic Engineering: "Pneumatics."' Weale's Series.



Fig. 10.—Owen's Improved Patent Self-regulating Wind-Engine and Pump.

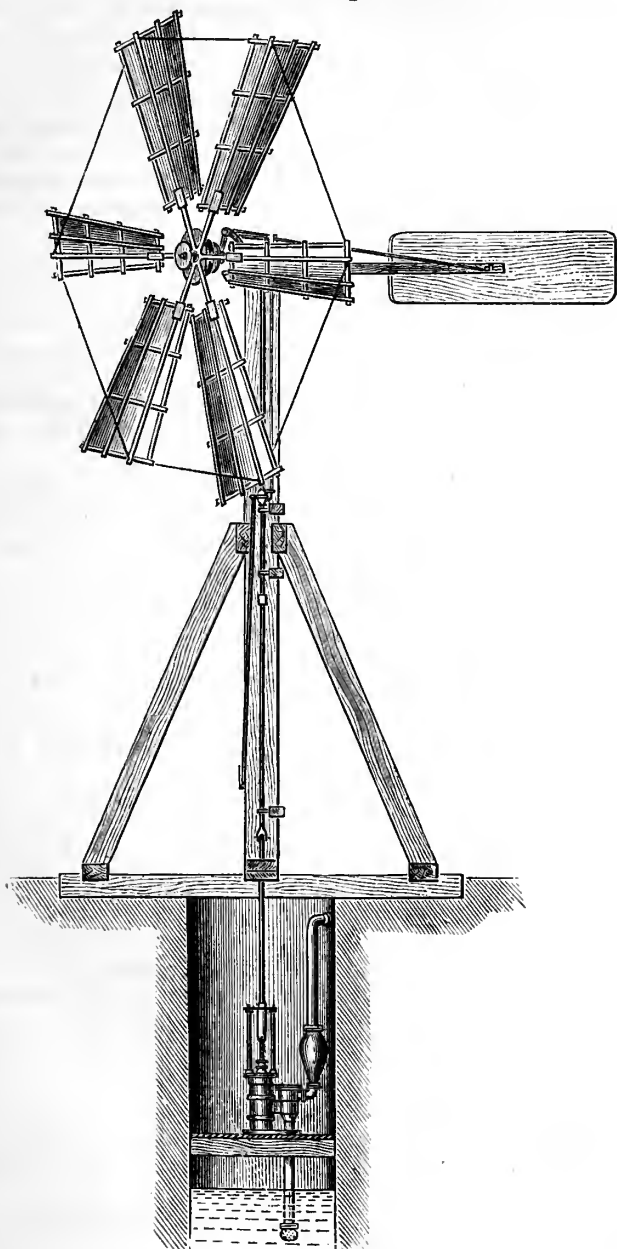

1,080,000, the result being the gross horse-power developed, from which must be deducted an allowance for friction depending on the construction of the engine ( $H-P = \frac{A V^3}{1,080,000}$ )\*

*Quality of Water.*—The quality of the water supplied is a matter of great importance. For all household purposes soft water is more economical and infinitely preferable to hard water. For drinking purposes, purity and freedom from animal contamination are essential. The quality of hardness in water is derived from the presence of mineral substances collected by the rain in its course over or through the earth. Of the hardening salts, carbonate of lime is the one most generally met with, and on the proportion of this salt in solution the standard of hardness is based. If 100,000 lbs. of water contain .1 lb. of carbonate of lime, or its equivalent of other salts, it is said to possess one degree of hardness. Each degree of hardness indicates the destruction and waste of 12 lbs. of the best hard soap by 10,000 gallons of the water when used for washing.† Rain-water fresh from the clouds is practically free from hardness. After it has once touched the earth it becomes impregnated with hardening salts, the number of degrees of hardness depending on the character of the water-bearing stratum through or over which it passes, and the length of time it is in contact with the soil. Water collected from the Igneous rocks contains from 0·8 to 5·9 degrees of hardness; next in order of softness come the waters from the Metamorphic, Cambrian, Silurian, and Devonian rocks, the Millstone Grit, London Clay and Bagshot Beds, which range from 0·4 to 32·5 degrees; the New Red Sandstone waters average 7·7 degrees; the Magnesian Limestones yield about 41°·2; the Lias 29 degrees: the Oolite and Chalk strata, which afford the most abundant and reliable sources of supply, yield waters generally hard, but the hardness is principally of a temporary character, which may be greatly reduced by boiling. The degrees of hardness of water flowing through the Chalk formation vary from 12°·4 to 38° and average 23·3 degrees.‡ While there can be no question that soft water is preferable for washing purposes, yet opinions vary considerably as to its desirability for drinking. It is alleged that the health and physique of populations in hard-water districts is superior to that where soft water is provided. Dr. Letheby gave it as his opinion, in his evidence before the Committee on Water Supply, that the best water

\* Molesworth's 'Pocket-Book Engineering Formula.' Spon and Co.

† 'Sixth Report of the Rivers Pollution Commission' (Domestic Water Supply), 1874.

‡ Ibid.

for a town supply was that which contained from  $10^{\circ}$  to  $15^{\circ}$  of hardness.\*

*Filtration.*—Organic matters held in solution or suspension are highly injurious to health; no more effective source of disease of the very worst type exists than water contaminated with animal refuse and sewage. No system of mechanical filtration will effectually remove this. The Rivers Pollution Commissioners are even of opinion that the process of oxidation necessary to destroy the soluble organic matter present in polluted water is one of such extreme slowness, that the hitherto prevalent idea as to the purifying effect of running water is untrustworthy; and that there is no river in this country long enough to purify water thus contaminated sufficiently for drinking purposes. Fortunately, in the pores of an open soil oxidation goes on very rapidly, especially when assisted by growing vegetation, and it completely removes all noxious matter.

Mineral matters held in suspension, although of an innocuous character, diminish the brightness of water and impart a repulsive appearance to it. Filtration through sand is therefore requisite where the supply is drawn from brooks and water-courses. Slow filtration removes the suspended impurities and also assists in the oxidation and removal of organic matter in solution. The filter-beds generally in use are composed of sand and gravel, the amount varying according to the quality of the sand and of the water to be filtered, the average being about 2 feet of sand, 6 inches of fine gravel, and 6 inches of coarse gravel. The beds are made in duplicate, to allow of one being cleansed and oxidised while the other is in use. The gravel is only introduced to support the filtering medium, the sand, and to allow of the filtered water being drawn off without disturbing it. Below the filtering material the water drains off by means of perforated tubular pipes stretching across the beds and communicating with a central inclined channel. The head of water used to work the beds is generally about 2 feet, and the same depth of water is kept on the top of the sand. The filtration through sand should not proceed at a higher rate than 6 inches of descent per hour, and this will allow about  $1\frac{1}{2}$  square yard for every 1000 gallons filtered in 24 hours. The sediment deposited on the surface of the sand requires to be scraped off frequently in summer time, and less often in winter. From a quarter to half an inch of sand is taken off each time with the sediment, the sand being replaced when the layer is reduced to 1 foot in thickness.†

\* 'Water Supply of Cities and Towns.' By W. Humber. Crosby Lockwood and Co., 1876.

† 'Waterworks for the supply of Towns.' By Hughes. Weale's Series, 1859.  
'Water Supply of Cities and Towns.' By W. Humber.

## WATER FOR FARM PURPOSES.

*Irrigation.*—In addition to the use of water for drinking and cleansing purposes, it is exceedingly valuable for irrigating grass-land, the water meadows of Devonshire, Gloucestershire, Somersetshire and other counties growing very large crops, and commanding rents sufficient to pay ample interest on the cost of the works necessary for laying them out, storing the water, and regulating the supply. An example of successful drainage combined with embanking and irrigation is given in the Appendix to the ‘First Report of the Rivers Pollution Commissioners.’\* The Bampton and Shilton inclosure contains 3000 acres, two-thirds of which were liable to be flooded, and nearly all were without sufficient outfall for under-drainage. A great part of the meadow, previous to the drainage operations, had been under water for nine months, and the only vegetation to be seen on hundreds of acres was an occasional blade of sedge peeping through the brown scum left on the meadows by long-continued floods. The land was embanked from the Thames; a new outfall with the necessary tributary drains was cut; the arable land was under-drained from 4 to 8 feet deep; and a portion of the meadow irrigated by sluices from the Thames. The total cost of the inclosure, including several miles of roads, was under 9000*l.* About 5000*l.* of this was expended in water-courses and embankments, and it was estimated by Mr. Bryan Wood, the valuer, that the value of the crops in one rainy season since the inclosure, were worth the whole of the 9000*l.* more than they would have been if the land had not been improved. All the land sold since the inclosure realised more than double what it was worth before.

The water of most large rivers is very fertilising, containing a great deal of rich alluvial warp and vegetable matter in suspension. Water off chalk soils also holds valuable fertilising salts in solution. From mountainous districts the particles held in suspension are generally not of a fertilising character, and often do more harm than good.

In India the magnificent works carried out by the previous rulers of that country in the construction of canals, reservoirs, embankments, and other irrigation works, stand as a reproach to our own government.

The very existence of the population in some parts of our Indian Empire seems to depend upon irrigation. With the tropical sun and the dry climate of that country, lands, otherwise highly fertile and capable of producing the most abundant

---

\* ‘First Report of Rivers Pollution Commissioners’ (Thames).

crops, are said to remain in a barren state. It is asserted that the districts where famine is constantly occurring are those where irrigation has been neglected. It is stated on competent authority that if canals had been constructed in place of railways, means of communication ample for the wants of an agricultural population would have been provided; and at the same time and at less expense, the resources of the country would have been developed to an enormous extent, and the calamities arising from the starvation and misery of thousands probably averted.

In Italy and Spain the conservation of water for the purpose of irrigation has long received its due attention, and instead of treating it as an enemy to be got rid of as quickly as possible, its force is subdued and made to become not only a valuable, mercantile commodity, but one of the greatest blessings which can be bestowed. So highly is water esteemed in Italy for the purposes of irrigation, that 16*l.* a year is not thought too much to pay for a cubic foot per second.

The soil of parts of the south and east of Spain consists of a rich alluvial deposit, from 3 to 10 feet in depth, and the climate is such that crops of almost any description can be grown. Wheat, barley, maize, olives, oranges, apples, rice, pepper, and numerous similar crops flourish, well where the land is irrigated. Where water is wanting the soil is barren. The average price of irrigated land in Murcia in 1859 was 500*l.* The price of dry ground in the same neighbourhood was from 25*l.* to 30*l.* Irrigated land near Madrid lets for 5*l.* an acre. The same class of land, but dry, can be purchased in fee for the same sum. The average price paid for the water is about 20*s.* a day for a cubic foot a minute, this being the price charged by the Government along the Henares Canal.\*

*Dew Ponds.*—Sheep and cattle feeding on high table-lands and chalk downs require a plentiful supply of water for drinking in summer. This is provided by what are termed “Dew Ponds.” The source from which these ponds are replenished has long been a matter of wonder. Situated on the very top of the highest land of a watershed, it is impossible they can derive their supply from springs, and the prevalent idea has hitherto been that, having been filled by the rains of winter, they are fed in summer by the condensation of the dew, rising from the surrounding land at night, by the cool surface of the water in the pond—hence their name. This popular idea has, however, lately been controverted by Mr. H. P. Slade, who has made a thorough investigation into the subject, and published the results of his observations in a very interesting pamphlet.† A description of the pond Mr. Slade

\* “Irrigation in Spain,” ‘Trans. Instit. Civil Engineers,’ vol. xxvii. ‘Irrigation in Spain.’ By Roberts. Spon and Co., 1867.

† ‘Dew Ponds.’ By H. P. Slade. Spon and Co., 1877.

experimented on will give a general idea of the method of construction of these valuable reservoirs for water-supply. It is situated on the highest ground of the Berkshire Hills, 450 feet above mean sea-level, and is excavated in the chalk. A neighbouring farm, 135 feet below the pond, has to obtain its water from a well 108 feet deep. It cannot therefore, from its situation, be supplied by springs or surface-drainage. It is 69½ feet in diameter and 6 feet 8 inches deep, and in shape it resembles a shallow rain-gauge, the straight sides meeting nearly in a point at the bottom. It is lined with a layer of clay, 12 inches thick, mixed with lime to stay the worms, and covered over with first a coating of straw to prevent the sun cracking the clay, and finally with loose rubble. It was constructed in 1836 at a cost of 40*l.*, and up to 1876 had been only once dry, owing to a leak caused by the growth of rushes. Exposed to the sun and wind, it is liable to great evaporation and loss; and Mr. Slade contends that, theoretically, it cannot derive its source from the condensation of the dew, as the surface of the water heated by the sun during the day would be warmer than the surrounding atmosphere at night; and, practically, that it does not do so, as his observations show that in no instance did a gain take place after sunset, and in the early morning hours occasionally a thick mist was observed to rise from the pond's basin and roll away over the downs, leaving a strong dew deposition in its track. The only source of supply by which the water can be maintained in the pond is the rainfall. The total fall for the four summer months, June, July, August, and September, was 11·708 inches. There were in the pond on June 7th, 24,719 gallons of water, and there remained on October 2, 18,218 gallons. A rainfall of 11·708 inches falling on the area of the surface of the pond would represent 23,043 gallons, which, added to the loss between June and September of 6501 gallons, would make a total to be accounted for of 29,544 gallons. Of this Mr. Slade estimates that 6203 gallons were drunk by the sheep at the rate of about half a gallon a day each, and the remainder passed away by evaporation and absorption of the sides of the pond above the water-level.

*Water-power, Water-mills, Weirs, &c.*—Besides the uses already referred to, water is made to serve another purpose as power for driving mills and machinery; and for this end the regulation of the supply is all important. It seems an anomaly that such a valuable force should be allowed to pass our doors and go away to sea, while we are sinking shafts and fetching fuel from the bowels of the earth, and transporting it at great expense hundreds of miles to perform work, such as driving mills and engines, that could as well be worked by water if a regular supply were insured. The numerous water-wheels used in the mining-districts for



crushing ore, pumping, and winding, illustrate of what service water may be if properly applied. As an example of the power to be utilised on our smaller rivers and water-courses, the case of the Wandle, a small tributary of the Thames, with a watershed of only 17,605 acres, may be cited—the water from this stream driving no less than 38 mills of an aggregate of 781 horse-power. Mr. Bailey Denton considers that the drainage off 20,000,000 of acres of this country might be made available to deliver its surplus water at a mean height of 150 feet, and that a power equal to at least half that obtained from the use of coal might be secured from this source alone.\*

Mills have had to bear a great deal of undeserved blame for causing floods; but a proper consideration of the subject, and a perusal of the evidence given before the Floods Committee of the House of Lords, are sufficient to show that, under proper regulations, there is no reason why mills, with their attendant weirs and staunches, should in any way contribute to the flooding of the districts above them. On the other hand, credit should be given for the good they do by preserving the water and preventing the land from being denuded of all its moisture by an over-zeal for drainage. A properly constructed weir across a stream only affects the land to such a distance as it prevents the side drains emptying into the main stream. Parallel drains discharging below the weir are a simple remedy for this. Mr. Abernethy in his evidence, referring to the Thames, says that “he does not agree with the sweeping measure of removing all these various dams and weirs which at present keep up the surface-level; and considers that their removal, with a deepening of the bed of the channel, would allow the river to run in a depressed bed considerably below the level of the adjoining lands, and during the summer months would act as a great drain to the subsoil.” In this opinion Mr. Coote and Mr. Grantham entirely concurred.† The most perfect system of drainage in England is to be found in the Fens. Here the water is always held up in summer, the sluice-gates being opened by the sluice-keepers, when necessary, to let off any surplus. In autumn, when from a heavy fall of rain and the saturation of the ground a full flow of water may be expected, the sluices are opened and the main drains partially emptied, so as to be ready to receive the rainfall which will reach them from the upper districts in the course of from 24 hours to two days. The water is then allowed to have free course until the flood has passed off, when the “slackers” or draw-doors are again closed, and the water is allowed to reach the summer

\* ‘The Storage of Water.’ By B. Denton. Spon and Co., 1874.

† ‘House of Lords’ Committee on Conservancy Boards, Report and Evidence,’ 1877; QQ. 202, 474, 475, 542, 553, 645, 812, 816, 907.

level, at which height, by a proper regulation, it is maintained. After the ground has become thoroughly saturated in winter, the sluices often remain open for several weeks together, only to be closed in time to keep up sufficient water for the summer supply.

Instead of sluices, falling weirs may be constructed, having doors which can be prostrated in times of flood, when they no longer operate as weirs, but allow the flood to have free course. As soon as the flood is gone, the doors can be lifted again and form a weir for mill purposes as before. Solid weirs, made of a greater length than the cross-section of the stream, may also be so constructed as to facilitate the passing of the flood-waters while holding up a sufficient quantity for mill purposes or for navigation. These weirs have been successfully adopted on the River Severn, and are fully described by Mr. Leader Williams in his evidence before the Committee of the House of Lords.\* The rule adopted by Sir W. Cubitt for the length of these weirs is that the rectangle formed by the length of the weir and its depth below the flood-line shall be equal to the rectangle of the river above the weir within the same flood limits.† The length of the weir may thus be four times the width of the stream, and is generally placed obliquely. The top cill, instead of being flat, is curved, and the curve is carried down to the back of the weir, by which means the water is discharged with much greater facility. The velocity being thus increased in one section of the weir, continues throughout the whole channel. It is contended that these solid weirs do not obstruct the action of the under-current, but rather facilitate the passage of the flood-waters, the theory being that a flood coming down into a channel comparatively empty is impeded very much in its course by shoals and the friction against the sides and bottom; whereas, if it be discharged into a deep quiescent pool, the whole body of water is set in motion, and the discharge brought about by a wave propagated through the water, the effect of which is rapidly felt at the lower end of the pound, and so the discharge takes place much more rapidly than if the water had to travel bodily over the whole distance along a shallow dry channel.‡

The principle of a weir placed obliquely across the stream is to be found in numerous works in Spain. All the old weirs made for the irrigation works cross very obliquely, the angle formed by the up-stream bank and the weir at the side from which the canal takes its water being often less than 45 degrees.§

*Gauging Streams.*—For all purposes of water-supply, whether

\* 'House of Lords' Committee on Conservancy Boards, 1877, Report and Evidence.' Williams, QQ. 1647, 1648; Taunton, Q. 2217.

† 'Trans. Instit. Civil Engineers,' vol. v.

‡ Ibid., "Freshwater Floods," vol. xxvii. (Parkes, p. 45.)

§ 'Irrigation in Spain.' By Roberts.

for domestic use, for irrigation, or for driving machinery, it is necessary to ascertain the yield of the stream or spring, and to measure the quantity of water available. For small springs the simplest plan is to let the water run into a vessel of known capacity, and to note the time required to fill it. For streams an approximate estimate may be formed by selecting a straight length of the channel, free from obstruction, which will give a fair representation of the current generally; and, having measured the distance, to ascertain the time taken by a float to pass from one point to the other. The float should be so constructed as just to move on the surface of the water, with the greater part of its body below, so as not to be acted upon by the wind. A tuft of grass with a portion of the earth adhering to the roots will answer the purpose. This will give the surface-velocity in the centre of the stream, which, being greater than that at the sides and bottom, owing to the friction of the rubbing surface, must be reduced by 16 per cent., or by multiplying the number of feet per minute by  $\cdot 84$ , the product of which, multiplied by the sectional area of the stream, will give the discharge in cubic feet per minute; multiplying this again by  $6\cdot 23$ , will give the equivalent number of gallons. Where greater accuracy is required, a weir or dam should be made across the stream with planks and clay, and the depth of water measured either passing over the top of the weir or through a notch. In small streams a weir may be formed with a plank from half an inch to an inch in thickness, having a V-notch cut in its upper edge, the sides of the notch meeting at a right angle. The edges should be chamfered off, so as to leave as little thickness as possible in contact with the water, and the plank should be set perfectly horizontal with a spirit-level. At a distance above, sufficient to avoid the curvature of surface which the water assumes as it approaches the weir, a peg with a step cut in it requires to be driven into the stream, at a point accessible from the side, the step being exactly level with the bottom of the notch. This point may be ascertained either by a spirit-level or by means of the water as it gradually rises to the level of the notch. In small streams the distance of the peg from the weir may be from 3 to 4 feet. (See illustration, Fig. 11, p. 58.) After the water has settled down from the disturbance caused by placing the dam, the height of the water on the step of the peg must be measured in inches. The fifth power of the square-root of the height or head ( $h$ ) in inches, multiplied by  $0\cdot 32$ , will give the cubic feet ( $D$ ) passing through the notch every minute ( $D = 0\cdot 32 h^{\frac{5}{2}}$ ). For example, supposing the height of the water on the step of the peg is 4 inches, the quantity would be  $10\frac{1}{4}$  cubic feet, or  $63\frac{3}{4}$  gallons. Care must be taken that the

Fig. 11.—Weir, with Notch-board and Peg for measuring the Quantity of Water flowing down a Stream.

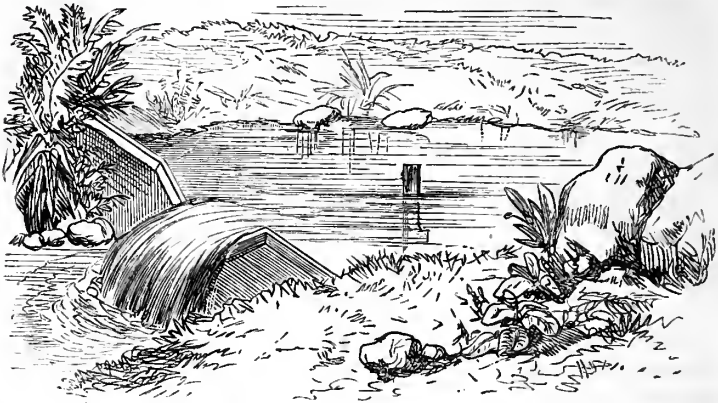

stream be dammed up by the weir sufficiently to reduce it nearly to the condition of a still pond, and also that the water should have a fall from surface to surface not less in height than double the depth it runs over the notch.

The observations should be repeated several times on different occasions, so as to obtain a fair average discharge. As a guide, it may be taken that a notch, 5 inches deep, will discharge about 100 gallons a minute. When the weir has no notch, the height of the water passing over the top can be ascertained by measuring the peg in the same manner, the step being placed level with the top of the weir. The product of the depth of water in inches ( $h$ ) passing over the weir, as ascertained from measurement on the step of the notch, multiplied by the square root of the depth and by the length ( $l$ ) in inches, and a constant  $\cdot 43$ , gives the discharge ( $D$ ) in cubic feet per minute; or by  $2\cdot 67$  for gallons, the formula being  $D = h \times \sqrt{h} \times l \times \cdot 43$ . For example, a weir 72 inches long, with 2-inch overflow, will discharge 543·8 gallons or 87·3 cubic feet per minute.

An approximate calculation, sufficient for preliminary purposes, may be made by holding a rule, marked in inches, on the lower edge of the weir, with the flat side opposed to the current. The difference in head to be allowed for and added to the reading will be from one-tenth to a quarter, according to the quantity of water passing over the weir.\*

The power of water to drive mills or any other hydraulic engines is derived from the weight of the water and the height

\* Neville's 'Hydraulic Tables.' Beardmore, 'Manual of Hydrology.' 'Practical Hydraulics.' By Box. Spon and Co. A very useful little book, with Tables.

from which it falls. The product of these two during the space of one minute, divided by 33,000, gives the horse-power. The weight of a cubic foot of water is generally taken at 62·5 lbs., and contains 6·23 gallons. For example, a stream yielding 60 cubic feet a minute, and falling 30 feet, would give 3·4 horse-power  $\left(\frac{60 \times 62\cdot5 \times 30}{33,000}\right) = 3\cdot4$  H.P. From this a deduction has to be made for friction and waste to obtain the actual power, this being more or less according to the construction of the engine. For a well-made turbine, 20 per cent. may be sufficient; whereas for an undershot wheel, 70 per cent. should be allowed.

### CONCLUSION.

In all the works of Nature the means are most beautifully adapted to the end to be accomplished, and everything follows a regular law and order. Thus with the rainfall and water-supply: the sun by its heat causes the vapour to rise from the surface of the ocean; the winds carry the vapour across the land; the clouds are caught in their progress by the mountain-tops, or they come in contact with a cooler stratum of atmosphere, when condensation takes place and the vapour falls to the earth in the form of rain, affording a supply of a requisite indispensably necessary for all animal and vegetable life. By the force of gravity the water not taken up by the vegetation sinks through the pores of the soil and gradually percolates to channels formed in the hollows of the surface of the earth. Along these it runs till it is finally discharged back into the ocean. The process of percolation through the soil is so slow, that the abundance of one season is sufficient to keep up a supply for the drought of another. The increase of population and the growing wants of civilisation compel the inhabitants of a thickly populated country to obtain the greatest amount of food-supply that is possible from the soil, and by artificial means to stimulate production. Of the several processes conducive to this end, one of the most successful is the drainage of the land by pipes. This, by removing the water more rapidly than the slow operations of nature would accomplish it, opens the pores of the soil and affords a supply of air to the roots of the plants; and also, by checking surface-evaporation, increases the temperature of the soil. So great has the benefit derived from under-drainage been found, that it has been generally adopted without reference to the effect that this interference with the operations of nature would cause. The result has been floods at one time and droughts at another. In the zeal for the removal of water, no regard has been paid to the regulating process of nature for the storing up the abundance of one season for the wants

of another. The great aim to be kept steadily in view in all drainage operations should therefore be not the withdrawal of the water only, but the proper regulation of the surplus rainfall: the so contriving the works that a thorough command can be kept over the supply, letting it go when over-abundant, but retaining all that is necessary for future wants. It is the more essential that attention should be prominently called to this view of the case, in the present feeling of the country with regard to floods, and with the probability of large works being undertaken to improve the rivers of the land. It is feared that the channels may become so enlarged and improved by the removal of obstructions as to drain away too rapidly the whole winter supply, and the water-level be so reduced in the soil that the latter evil will be greater than the first; that our pastures may become ruined, and the land dried up for want of water. In all schemes of improvement the means of holding up the water by weirs or sluices are as important as those for enlarging and clearing the water-way. Let water be regarded as a valuable servant, useful for drinking, for cleansing our persons and our belongings, for the growth of vegetation, for manufactures, for driving our machinery, for irrigating our lands, for facilitating inland locomotion, and for refreshing and keeping bright and pleasant the face of the country. There is nothing that adds so much to the beauty of a landscape as water—whether in a quiescent state, as in a lake, surrounded by verdure-clad hills, or moving as in a mountain-stream or a waterfall: neither is there any music more pleasant than that of water, whether it be the murmur of the mighty ocean, the ripple of the stream over the pebbles in a trout-stream, or the splash from a waterfall embosomed in ferns and mosses.

---

## II.—*On Bats' Guano.* By DR. AUGUSTUS VOELCKER, F.R.S.

THE term guano, as is well known, is usually applied to the dry and more or less decomposed excrement of sea-birds, extensive deposits of which are found on the rocky promontories of the coasts of South America and South Africa and on the islands that skirt them. The same name is likewise given to a variety of brown, yellow, or reddish-coloured powdery natural phosphatic fertilisers, the chief supplies of which come from the high tableland near the coast of Bolivia, between Peru and Chili, and from a number of small uninhabited islands situated in the Caribbean Sea and the South Pacific Ocean.

Guano is a name appropriately bestowed upon those natural phosphatic fertilisers, which can readily be shown to be the direct



products of the action of water upon accumulations of the fæcal matter of sea-birds, and of the remains of marine animals. The invariable presence of nitrogenous organic matters, yielding from  $\frac{1}{2}$  to  $\frac{3}{4}$  per cent. of nitrogen on an average, and the fine powdery condition of all true phosphatic guanos, plainly indicate their origin and mode of production.

Nitrogenous and phosphatic guanos clearly have a common origin; and the latter being, comparatively speaking, quite recent products of decomposition, may be appropriately described as true guanos. But it appears to me objectionable to give the name of "Rock guano" to Sombrero and Curaçao Rock, or to Alta Vela, Redonda, and similar phosphatic minerals, essentially differing in physical characters from Mejillones, Malden Island, Starbruck Island, or Lacepede and other phosphatic guanos, and possessing still less in common with Peruvian, Saldanha Bay, Ichaboe, and other kinds of birds' dung which are rich both in ammoniacal and phosphatic constituents.

Guanos from which nearly the whole of the nitrogenous and saline constituents have been removed, by rain and other atmospheric agencies, contain the phosphatic elements in a finely divided condition; and although their efficacy as manures is, no doubt, much enhanced by treatment with acids, they may in virtue of their fine condition be applied to the land with more or less advantage in their natural state. On the other hand, Alta Vela, Redonda, and other phosphatic minerals, the origin of which is shrouded in mystery, and which are found in nature in the shape of rocks or stones, frequently contain little or no trace of organic matter, while the phosphatic constituents are in a completely mineralised state. Materials of that kind, in my judgment, cannot be applied to the land with advantage, unless they have been subjected to chemical treatment, and thereby converted into efficient manures.

If applied to ground phosphatic minerals, the name of guano appears to me misleading; for it conveys the impression to the mind of practical men that such minerals, merely reduced to a fine powder, may be employed for manuring purposes, in the same manner as true guanos, without previous treatment with acids.

I allude to this matter, because instances have been brought under my notice, by farmers who applied ground phosphatic minerals, which had been sold to them as guano, as a top-dressing for corn-crops, under the wrong impression that they would produce effects similar to those which nitrogenous guanos are well known to produce upon corn-crops. It is scarcely necessary to observe that it is a sheer waste of time and money to top-dress wheat or barley with ground minerals containing no ammonia whatever.

The exhaustion of the Chincha Island guano deposits, the limited supply of ammonia-salts and nitrogenous refuse-matter, and the constantly increasing demand for high-class artificial manures, have greatly stimulated of late years the search for natural fertilisers in all parts of the globe; and, in not a few instances, enterprising explorers have been rewarded with success.

Amongst the more recent discoveries of new sources of fertilising matters, those of considerable accumulations of Bats' guano deserve to be noticed. The object of the present Paper is to give a brief account of the chemical composition and the manurial properties of a number of samples of Bats' guano, which have been recently examined by me, and which I received from different places, where more or less extensive deposits have been found.

As far as I have been able to obtain information, Bats' guano is found in Arkansas and Texas, in the south of Spain, in Jamaica, on several islands belonging to the group of the Bahamas, and on several East Indian Islands.

Bats' guano consists of the more or less decomposed dung of bats, and of their dead bodies, mixed with variable proportions of earthy matter. It varies in colour from light brown to dark brown, and generally smells but faintly of ammonia. Some of the samples examined by me were light, powdery, dry, and full of fragments of the wings of insects; others I found heavy, earthy in appearance, and quite void of smell.

This fertiliser is found in caves, inhabited by innumerable bats, attracted to the neighbourhood of the caves by swarms of insects which infest certain swampy districts in semi-tropical countries, and which afford abundant food to the winged mammals.

The most extensive accumulations of Bats' guano appear to have been found in numerous rocky caves in Texas and Arkansas. Some of the caves yield comparatively little guano, others many hundreds of tons; and from 15,000 to 20,000 tons are reported to have been taken from a single cave in Texas. The number of bats frequenting the caves amounts to millions, and when they issue forth they darken the air as if a great volume of smoke were pouring out from the opening.

Caves covering miles of ground, and inhabited by innumerable bats, are also found in Arkansas; and there can be no doubt that the caves in Texas and Arkansas contain large stores of bats' dung of sufficiently good quality to be usefully employed for agricultural purposes.

BATS' DUNG FROM ARKANSAS.

Some time ago I received two samples of bats' dung taken from caves in Arkansas. One of them was dry and earthy in appearance, and marked "Old deposit;" the second, labelled "Fresh deposit," was very damp, lumpy, and dark coloured.

On analysis the two samples yielded the following results:—

COMPOSITION OF ARKANSAS BATS' GUANO.

	No. 1. Old Deposit.	No. 2. Fresh Deposit.
*Moisture .. .. .	6.74	33.53
Organic matter and salts of ammonia ..	21.32	44.63
† Phosphoric acid, soluble in water .. .. }	6.64	1.92
‡ " , insoluble in water .. .. }		1.84
Lime .. .. .	6.11	1.87
§ Nitric acid .. .. .	1.80	8.40
Alkaline salts, oxide of iron, alumina, and other substances not determined .. .. }	15.09	3.12
Insoluble siliceous matter .. .. .	42.30	4.69
	100.00	100.00
* Containing nitrogen .. .. .	2.48	6.62
Equal to ammonia .. .. .	3.01	8.04
† Equal to tribasic phosphate of lime rendered soluble by acid .. .. }	..	4.19
‡ Equal to tribasic phosphate of lime ..	14.49	4.02
§ Containing nitrogen .. .. .	.46	2.18
Equal to ammonia .. .. .	.56	2.65

Notwithstanding the wet condition of the fresh deposit, it yielded 8.04 per cent. of ammonia and 8.4 per cent. of nitric acid, corresponding to 13.22 per cent. of nitrate of soda, and containing 2.18 per cent. of nitrogen, equal to 2.65 per cent. of ammonia. Thus, altogether, the fresh bats'-dung contained 8.80 per cent. of nitrogen in the shape of nitrogenous organic matters, ammonia-salts, and nitrates, corresponding to 10.69 per cent. of ammonia. The fresh deposit was full of fragments of the wings of insects, presenting a beautiful appearance under the microscope. It had no offensive or pungent smell, and did not contain any appreciable quantity of volatile carbonate of ammonia. About one-half of the phosphoric acid found in the analysis was soluble, the second half was insoluble in water, and both together represented 8 per cent. of tribasic phosphate of lime in round numbers. The presence of a considerable

quantity of nitrates together with much nitrogenous organic matter is rather remarkable; the material, however, was light and porous, offering free access to air, and, under these circumstances, the nitrogen of the fresh excreta would give rise to the formation of nitrates.

The old deposit, although much drier than the fresh, contained scarcely half the amount of organic matter and salts of ammonia, and very much less nitric acid. It was richer in phosphates than the fresh deposit, and was unfortunately contaminated with so much sand and valueless earthy matter that, unless the cost of transport be moderate, it would hardly appear worth the expense of exploring the caves in which such deposits occur. The fresh deposit, on the other hand, is a valuable manure that probably would realise about 10*l.* a ton in the market.

I have further submitted to more detailed analyses four other samples of Bats' guano, which I have reason to believe were taken from caves in Arkansas or Texas, and have obtained the following results:—

DETAILED COMPOSITION OF BATS' GUANO.

	No. 1.	No. 2.	No. 3.	No. 4.
Moisture .. .. .	27·24	23·60	64 07	12·30
* Organic matter and salts of ammonia ..	5·83	8·26	21·57	30·41
Phosphoric acid .. .. .	2·38	24·96	1·42	8·33
Lime .. .. .	8·91	27·21	3·71	14·30
Magnesia .. .. .	·39	1·33	·09	·34
Oxide of iron .. .. .	3·69	·40	·69	·45
Alumina .. .. .	2·30	..	..	..
Sulphuric acid .. .. .	·44	4·03	·99	5·87
Nitric acid .. .. .	·80	6·75	3·20	9·75
Carbonic acid .. .. .	4·51	..	..	..
Chloride of potassium .. .. .	..	..	·37	..
Chloride of sodium .. .. .	·80	·53	·47	1·07
Potash .. .. .	·33	·20	..	·48
Soda .. .. .	·19	·58	11	..
Insoluble siliceous matter .. .. .	42·19	2·15	3·31	16·70
	100·00	100·00	100·00	100·00
* Containing nitrogen .. .. .	·49	·48	2·91	5·37
Equal to ammonia .. .. .	·59	·58	3·53	6·52

Combining together the acid and basic constituents, the composition of these four samples may be represented as follows:—

CHEMICAL COMPOSITION OF BATS' GUANO.

	No. 1.	No. 2.	No. 3.	No. 4.
Moisture .. .. .	27·24	23·60	64·07	12·30
*Organic matter of salts of ammonia ..	5·84	8·26	21·57	30·41
Tribasic phosphate of lime .. .. .	5·19	24·96 23·40	1·60 1·42	8·33 5·91
†Phosphoric acid .. .. .	..			
Lime .. .. .	10·24	..	..	..
Carbonate of lime .. .. .	..	2·91	4·19	12·58
Nitrate of lime .. .. .	·15	6·85	1·68	9·97
Sulphate of lime .. .. .	·74	4·92	·33	1·26
Nitrate of Magnesia .. .. .	..	·39	..	..
Magnesia .. .. .	·39	·43	..	1·02
Nitrate of potash .. .. .	·71	..	·37	..
Chloride of potassium .. .. .	..	·80	·53	1·07
Chloride of sodium .. .. .	·80	·52	1·59	·30
Nitrate of soda .. .. .	·52	2·30	·69	·45
Oxide of iron .. .. .	3·69	2·15	3·31	16·70
Alumina .. .. .	2·30	..	..	..
Insoluble siliceous matter .. .. .	42·19	..	..	..
	100·00	100·00	100·00	100·00
* Containing nitrogen .. .. .	·49	·48	2·91	5·37
Equal to ammonia .. .. .	·59	·58	3·53	6·52
† Equal to tribasic phosphate of lime	..	54·49	3·08	18·18

A glance at the preceding analytical results shows that the composition of the four samples presents a wide range of differences. The samples No. 1 and No. 2, it will be seen, were fairly dry, but very poor in organic matter and ammonia. No. 1, likewise, was poor in phosphate of lime and in nitrates, and much contaminated with carbonate of lime, sand, and other worthless mineral matters. Altogether it was not worth removing, for it contained only 5 per cent. of phosphate of lime, about  $\frac{1}{2}$  per cent. of ammonia, and not quite 1 per cent. of nitric acid. The second sample contained about as much nitrogen in the form of organic matter as the first;  $6\frac{3}{4}$  per cent. of nitric acid and an amount of phosphoric acid corresponding to  $54\frac{1}{2}$  per cent. of tribasic phosphate of lime. At the present market-value of manures, No. 2 would be worth about 7l. a ton.

The sample marked No. 3 was very wet, as it contained 64 per cent. of water. Notwithstanding this large amount of water, it yielded on analysis  $3\frac{1}{2}$  per cent. of ammonia and 3 per cent. of nitric acid, in round numbers; and in a proper air-dry condition would be a valuable manure.

The fourth sample, it will be seen, was the driest of all, and the richest in nitrogenous organic matter, salts of ammonia, and nitric acid. It contained 5·37 per cent. of organic and ammoniacal nitrogen, equal to  $6\frac{1}{2}$  per cent. of ammonia and  $9\frac{3}{4}$  per cent. of nitric acid, corresponding to 17·19 per cent. of

nitrate of soda, and containing 2.52 per cent. of nitrogen, equal to 3.06 of ammonia. The total nitrogen in No. 4 thus amounted to 7.89 per cent., equal to 9.58 per cent. of ammonia; and the phosphoric acid in this sample was equal to 18 per cent. of tribasic phosphate of lime. A manure, equal to the Bats' guano No. 4, would be worth about 11*l.* a ton.

#### BATS' GUANO FROM THE SOUTH OF SPAIN.

As early as 1870 a peculiar kind of guano was sent to me for examination, which, having been found in caves in Spain, was called Cave-guano. It was a wet, dark-coloured, porous material, having but little smell, and was full of fragments of insects. I readily recognised it as Bats' guano.

On analysis it yielded the following results:—

Moisture .. .. .	33.68
*Organic matter and salts of ammonia .. .. .	25.16
Phosphate of lime .. .. .	7.48
Sulphate of lime, &c. .. .. .	1.18
Insoluble siliceous matter .. .. .	32.50
	100.00

* Containing nitrogen .. .. .	3.36
Equal to ammonia .. .. .	4.08

Two years afterwards, two more samples of bats'-dung found in the south of Spain were examined by me. Both, it will be seen by the subjoined analyses, were superior to the one the analysis of which has just been quoted. Both were very porous, voluminous, and dark-coloured materials, without any particular smell, and both contained innumerable fragments of insects' wings.

The composition of these two samples was as follows:—

	No. 1.	No. 2.
Moisture .. .. .	15.82	18.81
*Organic matter and salts of ammonia .. .. .	65.08	42.09
Phosphate of lime .. .. .	3.34	..
†Phosphoric acid .. .. .	..	4.65
Limo .. .. .	..	5.18
‡Alkaline salts .. .. .	13.37	..
Substances not determined .. .. .	..	15.28
Insoluble siliceous matter .. .. .	2.39	13.99
	100.00	100.00
* Containing nitrogen .. .. .	8.67	4.96
Equal to ammonia .. .. .	10.52	6.02
† Equal to tribasic phosphate of lime .. .. .	..	10.15
‡ Containing soluble phosphoric acid .. .. .	3.76	..
Equal to tribasic phosphate of lime .. .. .	8.20	..





Like bats' dung from other localities, that from Jamaica is likely to vary very much in composition. The sample analysed by me was poor in ammonia and not particularly rich in phosphate of lime.

#### BATS' GUANO FROM PENANG.

In Penang Bats' guano bears the name "Typelawer." When pure it is held in high estimation as a manure by the planters; but often, I am informed, Typelawer is much adulterated by the Chinese dealers.

The only sample hitherto analysed by me had the following composition:—

Moisture .. .. .	10·54
*Organic matter .. .. .	9·25
Phosphate of lime .. .. .	38·08
Carbonate of lime .. .. .	5·69
Sulphate of lime .. .. .	13·76
Magnesia .. .. .	·78
Alkaline salts, including 2·32 of potash .. .. .	6·09
Insoluble siliceous matter .. .. .	15·81
	<hr/>
	100·00
	<hr/>
* Containing nitrogen .. .. .	·33
Equal to ammonia .. .. .	·40

This specimen, it will be seen, contains 38 per cent. of phosphate of lime and 6 per cent. of alkaline salts, including  $2\frac{1}{3}$  per cent. of potash, and no doubt is a useful fertiliser on account of the phosphates and salts of potash which it contains. On the other hand, it is poor in organic matter, and yields not quite  $\frac{1}{2}$  per cent. of ammonia on decomposition.

In Penang Typelawer is used chiefly as a manure for sugar-canes. The sample analysed by me, being very poor in ammonia, would not be a good manure for sugar-canes, but probably other samples are richer in nitrogenous constituents.

#### BATS' GUANO FROM THE BAHAMAS.

Most of the Bats' guano which is actually imported into England as an article of commerce is derived from numerous caves frequented by bats on Guanahani Island (St. Salvator) and on other islands belonging to the group of Bahamas, and passes in commerce under the name of Bahama or Guanahani guano.

It has a dark-brown colour, little or only a faint ammoniacal smell, and generally contains fragments of coral or limestone,

which appears to constitute the cavernous rocks in which the accumulations of bats' excrements are found.

Guanahani guano is often too damp and lumpy for direct application to the land in its natural condition, and requires to be dried, sifted, or otherwise manipulated before it can be used with advantage for agricultural purposes.

The following analyses, made with average samples representing whole cargoes recently imported into England, will give an idea of the general character of the Guanahani guano of commerce:—

COMPOSITION OF GUANAHANI OR BAHAMAS GUANO OF COMMERCE.

	No. 1.	No. 2.	No. 3.	No. 4.	No. 5.	No. 6.
Moisture .. .. .	27·05	23·46	27·73	20·61	31·12	31·49
*Organic matter .. .. .	14·72	11·38	21·18	11·10	10·74	11·18
†Phosphoric acid .. .. .	13·77	12·34	21·09	12·61	15·20	13·99
Lime .. .. .	25·75	30·90	16·04	32·78	26·70	25·96
†Nitric acid .. .. .	1·26	1·05	4·08	1·24	·91	2·97
Magnesia, alkaline salts, &c. } (not determined) .. .. .	12·66	17·83	6·89	20·02	14·19	13·37
Insoluble siliceous matter ..	4·79	3·04	2·99	1·64	1·14	1·04
	100·00	100·00	100·00	100·00	100·00	100·0
* Containing nitrogen ..	·68	·53	1·93	·54	·84	·60
Equal to ammonia ..	·83	·64	2·34	·64	1·02	·72
† Containing nitrogen ..	·33	·27	1·06	·32	·24	·77
Equal to ammonia ..	·40	·33	1·29	·39	·29	·93
Total nitrogen .. .. .	1·01	·80	2·99	·86	1·08	1·37
Equal to ammonia ..	1·23	·97	3·63	1·03	1·31	1·64
‡ Equal to tribasic phos- } phate of lime .. .. .	30·06	26·94	46·04	27·53	33·19	30·54

With the exception of No. 3, all the samples, it will be seen, were comparatively poor in nitrogenous organic matters. All contained some nitrates and phosphate of lime, the latter averaging in the different cargoes from 27½ per cent. to 46 per cent. Except No. 3, all contained considerable quantities of carbonate of lime.

From these analyses it appears that Bahamas guano is not suitable as a manure for corn-crops; but, like other phosphatic guanous, it may be usefully applied to root-crops or to worn-out pasture-land.

It need hardly be mentioned that Guanahani guano of so variable a composition should be bought on the strength of a guaranteed analysis, at the market-rates at which ammonia and phosphate of lime can be bought at present in similar manures.



Moisture .. .. .	11.39
*Organic matter and salts of ammonia .. .. .	16.45
Phosphoric acid, soluble in water .. .. .	.76
Phosphoric acid, insoluble in water .. .. .	7.88
Lime .. .. .	12.32
Magnesia .. .. .	3.83
Oxide of iron and alumina .. .. .	4.33
Sulphuric acid .. .. .	14.27
Nitric acid .. .. .	.35
Carbonic acid .. .. .	1.04
Chloride of potassium .. .. .	10.16
Chloride of sodium .. .. .	8.62
Insoluble siliceous matter .. .. .	8.60
	<hr/>
	100.00
	<hr/>
* Containing nitrogen .. .. .	2.64
Equal to ammonia .. .. .	3.20

Combining these constituents together, the composition of this guano may be represented as follows:—

Moisture .. .. .	11.39
*Sulphate of ammonia .. .. .	8.05
†Organic matter .. .. .	13.28
Monobasic phosphate of lime .. .. .	1.05
Equal to tribasic phosphate of lime rendered soluble .. .. .	(1.66)
Tribasic phosphate of lime .. .. .	13.84
Tribasic phosphate of magnesia .. .. .	2.84
Sulphate of magnesia .. .. .	7.59
Carbonate of lime .. .. .	2.36
‡Nitrate of lime .. .. .	.53
Sulphate of lime .. .. .	7.36
Chloride of potassium, equal to 6.39 of potash .. .. .	10.16
Chloride of sodium .. .. .	8.62
Oxide of iron and alumina .. .. .	4.33
Insoluble siliceous matter .. .. .	8.60
	<hr/>
	100.00
	<hr/>
* Containing nitrogen .. .. .	1.70
Equal to ammonia .. .. .	2.06
† Containing nitrogen .. .. .	.94
Equal to ammonia .. .. .	1.14
‡ Containing nitrogen .. .. .	.09
Equal to ammonia .. .. .	.11
Total nitrogen .. .. .	2.73
Equal to ammonia .. .. .	3.31

This guano, it will be noticed, has a very complex composition, and differs principally from the generality of samples recently analysed by me in containing large proportions of chloride of potassium and sodium, which somewhat depress the average percentage of phosphate of lime, amounting in most cargoes to about 30 per cent., and rising in some to upwards of

40 per cent. It is also richer in nitrogen than the majority of samples that have come under my notice ; and, on the whole, is a useful manure for general agricultural purposes, being well suited for most crops usually grown on the farm.

This brief account of the chemical composition and properties of Bats' guano fully explains the variable statements which have appeared in agricultural periodicals with regard to its fertilising value. Bats' guano, it has been shown, includes manures, some of which contain as much as 10 per cent. of ammonia, and others only 1 per cent. and even less, and which differ in value from 3*l.* per ton, and even less, to 11*l.* a ton and upwards.

### III.—*Exmoor Reclamation.* By SAMUEL SIDNEY.

EXMOOR was afforested by William Rufus, some seven hundred years ago, when Dartmoor was also made a Royal Forest. The red-deer, the chosen game of the Norman kings, still retain a doubtful hold upon the Exmoor hills, though they have long been driven, by the advance of cultivation, from the rest of England. In those old days they roamed in large herds over this remote and thinly inhabited district, attracted by the excellence of the summer pasture of the hills, and the solitary wildness of the deep oak-clad valleys. These valleys formed the purlieus of the Forest, over which the forest laws protected the royal chase against the neighbouring landowners.

No doubt the deer often crossed the wide valley intervening between Exmoor and Dartmoor forests, where within the reach of tradition they still existed, and, when hunted, took refuge in the English Channel, as the Exmoor deer still do in the Severn sea.

Still farther back, the Exmoor district had been thought by the Romans (the great strategists of old), to be of sufficient consequence to take a place in their system of occupation ; and a very large Roman camp, called Sholesborough Castle, stands on the south-western heights, overlooking the counties of Devon and Cornwall for many a mile ; while they had a smaller camp close to Lynmouth, which was used by them as a landing-place. All this shows that the Exmoor district had been held to be of some importance long before the days of the Red King.

Be that, however, as it may, Exmoor remained in a state of nature, wild and desolate as an American prairie, until it was disforested by Act of Parliament in 1818. At that date the Exmoor Forest, together with the unenclosed lands lying open to it, comprised sixty thousand acres without a fence, and extended from the



Elworthy Turnpike, ten miles west of Taunton on the Dunster Road, to Bratton Fleming, near Barnstaple, and to the sea at Morte, near Ilfracombe.

Over these wastes there were no roads but the tracks of the packhorses; no enclosures, no cultivation, no dwellings, no population except the shepherds who attended to the summer feeding of live-stock from the valleys, and the smugglers who made temporary depôts in the moors on their way from the many creeks of the coast, so convenient for their "free-trade."

The slow, long-eared, deep-voiced stag-hounds of that day, often ran their quarry thirty miles without a check, before the huntsman could sound the *morte*.

The only return obtained from these hill-wastes was an almost nominal sum paid for the agistment of the live-stock of valley farmers, fed on the Moors in the fine months of the year, and from herds of native ponies, as hardy, and nearly as wild, as the red deer.

Exmóor proper, as distinguished from the heathy commons that surround it, lies at an elevation of from 1000 to 1500 feet above the level of the sea, so that the elevation is constantly increasing as it is approached from Barnstaple, distant sixteen miles, Ilfracombe, seventeen miles, South Molton, eleven miles, Lynmouth, nine miles, and Minehead, nineteen miles, although many narrow intermediate valleys are crossed. Exmoor consists of long, green, undulating table-lands, intersected by steep gorges, provincially called combes.

In one of these combes the River Exe has its source, not far from that of its yet larger tributary the Barle. After forcing a devious way for many miles, being joined at every mile by lesser streams, and rolling over pebbly rocky bottoms, these two rivers form a junction at Exebridge, a few miles below Dulverton. The sides of these steep valleys, running for miles through the forest, consist of a brown loam, covering a deep yellow subsoil, the debris of the soft Devonian clay-slate rock that underlies it.

About half of Exmoor is naturally dry, and is covered with this brown loam, which becomes fertile on the application of lime. Experience has proved that this brown soil is nothing else than the unfertile yellow subsoil after it has been exposed to the influence of light and air.

The other half is covered with shallow peat, which holds water like a sponge after the showers, which are frequent in every month in the year.

The unreclaimed peat-land produces a profusion of "forest-grass," a coarse benty herbage, containing the stool-bent, flying-bent, drew-moss, deer-hair, cotton-grass, bluepry, spratt, rush, and other grasses of the kinds that form the winter and spring

keep of the many thousand sheep that dwell all the year round on the Scotch hills, from the English border to Caithness.

The wet lands of Exmoor are wet, because, from some inscrutable cause, a thin clay-pan, of from three to six inches thick, and quite impervious to water, has been spread by nature like a sheet over large portions of these hills. Where the pan exists, and the water cannot penetrate to the pervious subsoil, the peat has grown, covering in the course of centuries hard stones of no great size which seem to have been strewn over the surface of the pan, and to have belonged to the formation that produced it, having no affinity with the *killas* or clay-slate rocks of which the hills are composed.

The barrows, or ancient burying-places often found on the tops of the hills, are formed of heaps of these stones, which were no doubt lying on the surface of the ground at the time the barrows were made, and have since been covered over by the growth of the peat. One may gallop for ten miles over the green surface of Exmoor proper, and scarcely see a stone emerging from the sod.

For the greater part of the year these shallow peats are saturated with water like a sponge, and form a strong contrast to the dry Exmoor land, on which the effect of heavy rain is absorbed almost as quickly as on a New Red Sandstone formation.

Exmoor, although for centuries a Royal Forest, has no trees growing on it. Those which, at some remote period, clothed its valleys have disappeared long ago. A drainer comes sometimes upon a trunk or root; quantities of hazel-nuts, some eaten by squirrels, have been found in the bogs; and several old charcoal pits, in which lumps of charcoal were found as fresh, to all appearance, as the day they were burnt, have been cut across. This charcoal, it is supposed, was used by the "*old men*"\* to smelt the Exmoor iron ores.

The valleys which lead up to Exmoor are fringed with oak coppice—part doubtless of the primeval forests of the country. Old men, of one generation back, could remember when a squirrel could travel along the oak brushwood, which extended up the Badgeworthy and Hoar oak valleys, as far as where the

---

\* Neither antiquaries, nor miners, nor tradition can tell us whether these "*old men*" were Phœnicians, or Romans, or Germans who visited England in the time of Henry VIII. The only fact certain is that they worked mines and smelted iron ore in the whole of the Exmoor district, from near Elworthy Turnpike to near the sea at Ilfracombe. This was the spathic or spathose iron-ore, which until the Great Exhibition of 1851 had not been used in England for centuries, although without it the best class of steel cannot be manufactured. The mines on Exmoor have since been partially explored, and worked sufficiently to show that they will be of considerable importance for making steel when the means of conveyance to the sea have been completed.

Exmoor boundary fence now stands. Most hardwood trees, oak, ash, sycamore, beech; lime, poplar, Spanish- and horse-chestnut, alder, and wych-elm may be seen growing fairly well at Simon's Bath. Of the pine tribe the spruce-fir grows admirably well on Exmoor, while neither the larch nor the Scotch fir makes much progress. On somewhat similar hills on the Welsh side of the Bristol Channel, the Scotch fir and the larch flourish, but the spruce will hardly live. Whence this extreme difference? Spruce-fir is an inferior timber, but, when forty years old, it will stand well in the open roofs of sheds and farm buildings.

The rhododendron flourishes magnificently in the Exmoor peat.

It is said that there are to be found on Exmoor the sites of several villages destroyed by William Rufus in his work of afforesting; but they are not to be distinguished by the untrained eye of the ordinary traveller. There are certainly no traces of the Saxon plough on Exmoor, although the adjacent commons, now for the most part covered with heather, bear traces of having been inclosed and cultivated. The *under-coats* of the thatch of some of the oldest farmhouses, when pulled to pieces within living memory, were found to be of rye-straw, a crop which has not been grown in Somerset or North Devon in this or the previous century.

It is conjectured that these commons encircling the Royal Forest were part of the immense tracts of peasants' lands which were cleared on the breaking-up of the feudal system, under the reigns of the Tudors and the Stuarts; when the necessity for fighting vassals ceased, and a demand arose for beef, mutton, skins, and hides, and the cash they would bring; and flocks and herds were found more profitable than villages of armed retainers.

As long as Exmoor was a Royal Forest, and, with the adjacent lands of the same quality, was only used as summer pasture, the peat-tracts were never touched except to obtain fuel. Peat is formed by the roots of growing plants, which can only be destroyed by being made permanently dry, or by being cut off at its roots. Below the peat on Exmoor comes, as already described, a pan, which holds up the water, and causes the growth of the peat from the surface of the wet land. Beneath the pan lies the pervious subsoil, which, when accidentally or intentionally denuded, is converted in a series of years, by the action of sun, wind, and rain, into a brown soil, which only requires lime to produce fine pasture-grass.

In 1818 the Government, for some unknown reason, passed an Act of Parliament disforesting Exmoor, and offered the royal allotment, of more than 10,000 acres, for sale, by public tender. There were several competitors. The purchaser was a Wor-

cestershire squire, Mr. John Knight (of the same family as Payne Knight), who gave 5*l.* an acre for the forest, and obtained about 10,000 additional acres of adjoining land, of a similar character, at about the same price—a compact estate of 21,000 acres, in a state of nature—producing nothing that was not self-sown and self-sustained; without fences, without roads across it, or communication with the surrounding towns and ports, and without dwellings, except a public-house at Simon's Bath, which often sheltered smugglers and poachers, and female fugitives from the law of settlement. Except that the prices of labour and live-stock were low, the year 1818 did not seem favourable for a great reclamation scheme. The long wars that sprang out of the French Revolution of 1798 had been closed at Waterloo; war prices for corn had only been temporarily sustained by two bad harvests; but the war taxes remained, and threatened to be increased by an approaching return to cash payments. Wheat brought 5*l.* a quarter in 1814, and only 40*s.* in 1822; while beef in Newgate Market was quoted from 2*s.* 4*d.* to 3*s.*, and mutton at 2*s.* to 2*s.* 10*d.* per stone.

Still, the retrospect of the reclamations of the past century was tempting to an energetic man who was familiar with the agricultural literature that Arthur Young had created, who had been one of the guests at the Woburn sheep-shearings, who had seen the result of the conversion of some 400,000 acres of heath and moor in Bedfordshire, Norfolk, Lincolnshire, and his native Worcestershire, into rich, rent-paying farms. He was familiar with the successive steps of claying and marling, root-growing and sheep-feeding, and with the four-course system then perfected in Norfolk by the invention of the drill and the horse-hoe, and the use of crushed bones and rape-cake, the earliest portable manures. He had studied the means and the management by which Mr. Thomas Coke, afterwards Earl of Leicester, had created a princely estate out of the desert where he "saw, when he took possession, two rabbits fighting for one blade of grass." In his character and his acquirements, in his ample means and tenacity of purpose, Mr. John Knight had every qualification for success except one—the art of profiting by experience. He began grandly, and the monuments of his early enterprise remain to this day.

It is difficult for the present generation to form the least idea of the state of isolation in which many fertile districts of the kingdom, and especially of the West, existed in the early years of the present century, when they lay even a short distance from the mail-coach roads, and the ports and creeks of the sea-coast.

A map of Northern Devon and Western Somerset will show

the Exmoor\* of the present day communicating with the sea-coast at Barnstaple, Ilfracombe, Lynton, Minehead; and with South Molton, Dulverton, and Taunton, by good coach-roads and well-provided bridges over the winter torrents. But in 1818 the only means of communication was by the tracks travelled over by the once celebrated, now extinct, Devonshire pack-horse—that famous animal which disappeared before road waggons and carriers' carts, just as these have been superseded by railway-trains.

Mr. Knight began by building, of the dry stone of the country, a fence more than forty miles in length round the Exmoor portion of his property. He next constructed excellent roads, north, south, east, and west; roads which remain examples to the county for the skill with which they were laid out, and the solidity with which they were executed. These, for the first time, gave Exmoor access to the neighbouring market-towns and ports, and, last, though not least, to limekilns.

He laid the foundations of a mansion, which was never completed, and is at present a picturesque ruin; he inclosed a number of fields of from 50 to 100 acres each, and established farms east and west of Simon's Bath. On these farms he set zealously to work to carry out the system of cultivation that had been so successful in his native county under a very different climate.

He had farmed largely all his life in the north of Worcestershire, and had had a share in bringing into cultivation large tracts of heathy common on the New Red Sandstone in that county, much resembling in character the Cannock Chase of our own times.

The appearance of Exmoor in genial seasons was so superior in apparent fertility to that of the Norfolk blowing-sand and the Lincoln heaths and wolds, that he never doubted that the famous four-course system would convert it, with the help of turnips and sheep, into profitable barley-, if not wheat-land.

His efforts were vain,—defeated by a climate that made corn-growing at any price unprofitable: for, even if the mechanical means, which have so recently been perfected, had been in existence for breaking up and mixing the soil at Exmoor, it was impossible, at the elevation of 1000 to 1500 feet above the sea-level, except in very exceptional years, to ripen the crops of wheat and barley.

Had Mr. Knight met with a little work written by a Lammermuir farmer, and printed in 1823, by the father of the present Sir Hugh Hume Campbell, he would perhaps have learned that the capital he sank, and the tenacious energy with which

\* "The Ordnance map of Exmoor is so curiously incorrect that it must have been composed out of the inner consciousness of the surveyor—valleys are made hills, and hills valleys."—*Letter to the Author.*



he persisted year after year in arable cultivation, would have laid down three times the area of well-limed permanent pasture. Mr. Knight broke up the pan before described with heavy subsoil ploughs, drawn by teams of bullocks at a vast expense, and with complete success, so far as making the land perfectly porous and dry for all time; for he converted the mixed peat, pan, and yellow clay, when dressed with lime, into a dark fertile soil, which to this day produces admirable pasture. The land which was broken up forty or fifty years ago, and then injured by over-tillage, in vain attempts to grow eorn-crops, having then been liberally dressed with lime, forms the staple of the best grass-land on Exmoor; and the subsoil-ploughs, which it would not pay to work with bullocks, now form a useful addition to the earth-stirring apparatus set in motion by the steam-cultivator.

A large herd of West Highland cattle, introduced as better calculated to brave inclement winters on the higher ranges of Exmoor than the native Devons, thrived at first amazingly; but the calves, running with their dams on the hills, grew up wild as the red-deer, and proved unmanageable and unprofitable. Mr. Knight also established in the inclosures at Simon's Bath a large breeding-stud of Yorkshire mares, for which he provided English thoroughbred sires, and even joined in the costly experiment of importing from Dongola several stallions of the breed from which the traveller Bruce chose his war-horse.\*

But although Mr. Knight was an excellent judge of horses, and spared no expense to obtain blood, bone, and quality, and although he succeeded in producing many excellent horses, he failed, as everyone who has attempted a great stud of half-bred horses has failed, to make a profit by it.

The attempts to farm on Exmoor were persevered in with lavish tenacity long after everyone, except the owner, had become convinced that wet tracts could not be broken up by ox-teams with any prospect of profit; and that to attempt to turn the dry land, however fertile, into sheep and corn farms, on the four-course-system, was simply impossible in that climate.

In 1842 Mr. Knight, then seventy-six years of age, feeling himself unable to continue the exertions and exposure necessary for carrying on his Exmoor farms, retired to Italy, where he died at Rome in 1850. He placed the management of his property in the hands of his eldest son, the present proprietor,

---

\* "After the publication of 'Bruce's Travels,' Mr. John Knight being at the house of Sir Joseph Banks, Lords Moreton, Headley, and Dundas being also of the party, the conversation turned on Bruce's description of the big Nubian blood horse, and ended in each writing a check for 250*l.* and handing them over to Sir Joseph on account of the expense of bringing over some specimens of the Dongola. The best of these found their way to the Exmoor breeding stud."—Sidney's 'Book of the Horse.'



Mr. Frederick Winn Knight, then just elected to represent his native county of Worcestershire in Parliament.

This gentleman's first step was, with the help of his agent, Mr. John Mogridge, of Molland (one of a family well known to all admirers of pure North Devon cattle), to build a number of farm-houses, which were completed with remarkable economy and success, as may be seen at the present day. Mr. Knight drew all the plans of the farm-steadings himself; he built them of stone delved on the moors, and with labour hired by the piece from the neighbouring villages. In a word he succeeded, without the costly assistance of an architect or surveyor, in producing comfortable and convenient, but certainly not picturesque, farm-steadings.

The idea in preparing these large farms was to follow the system that had been so successfully carried out in the wolds and heaths of Lincolnshire—to let the farms at very low rents, in their wild unimproved state, with a tenant-right like that of Lincolnshire, to farmers of capital and enterprise.

Such tenants, however, were not at that date to be found in the neighbourhood. The Devon and Somerset farmers, a quarter of a century ago, considered that to attempt to farm on Exmoor, or to use it for anything but summer grazing, was sheer madness. They would not have it at any price, although some of them occupied fields of the same soil, divided only from Exmoor by a boundary fence.

When in 1850 Mr. John Knight died at Rome, Mr. Frederick Knight found himself saddled with the farm devoted to the horse-breeding stud and many thousand acres of wild land in hand, besides a number of new farms unoccupied. The only income he obtained from over 10,000 acres of wild land was the poll-rent paid for the summer feed of sheep and cattle, and the produce of herds of Exmoor ponies, which fetched less money as three-year-olds than Mr. Frederick Knight's six-months-old pony foals have realised for the last half-dozen years at Bampton fair.

The first set of men then who signed agreements to occupy tracts of land on Exmoor, and for whom Mr. Knight undertook to erect fences and houses and to make roads, were strangers to the country and climate.

If the prices of live-stock and dairy produce had kept up to the scale of preceding years, on which these men had made their calculations, some of them would probably have succeeded. But the groundless panic and consequent fall in the price of corn, meat, and live-stock, which took place after the passing of Sir Robert Peel's Free Trade measures, cleared Exmoor of most of the strangers who had first settled down under Mr. Frederick Knight's low rents and liberal leases.

The following extracts from an article on the condition of Exmoor, which I wrote after visiting the district in the autumn of 1853, tempted by an advertisement of the pony sales, give a good idea of the character of the country, and of the changes that have taken place within a quarter of a century. These changes have made the North Devon and Somerset farmers prosperous, while the arable farmers in the rest of England are struggling with a succession of difficulties.

1853 was a year of low prices for every sort of farming-produce, and particularly for live-stock. North Devon had not tasted the benefits of railroad cattle-trucks. At that date a recently opened spur-line from Exeter to Tiverton afforded the nearest station to Exmoor, distant 30 miles of very hilly road.

Within the last six years, two lines starting from Taunton have tapped the Hill district—one, the more important, running through South Molton, 11 miles from Exmoor, terminating at Barnstaple—the other along the base of the Brendon Hills to Watchet and Minehead. Both communicate directly with all the markets from Bristol to London. Instead of having to travel to Exeter, and then change to a branch line to Tiverton, the "Flying Dutchman" takes up at Paddington and deposits at South Molton within six hours; while the meat-van, packed with carcasses in the evening at South Molton, is in the Metropolitan Market the next morning. But the road from South Molton to Exmoor has scarcely changed since 1853.

"A gradual ascent over a succession of hills, of which every descent, however steep, leads to a still longer ascent the first 6 miles, through real Devonshire lanes, with high banks on each side, covered with ferns and grass, and topped with trees and hazels, bearing nuts with luxuriant abundance; the road for the most part excellent, without much road-makers' care, for it rests on natural rock. On the rich valley pasture of small enclosures red Devon oxen were fattening; and sheep, not of any mountain or upland breed, but long-woolled.

"At length the hedges began to grow thinner, beech-hedges succeeded hazels; the road, more rugged and bare, showed the marks winter torrents had ploughed, deep channels; and at the turn of a steep hill we saw on the one hand the brown and blue moor stretching before and above us, and below, the fertile long cultivated vales lay like a map unrolled, various in colour, according to the crops, divided by frequent enclosures in every angle, from the most acute to the most obtuse. Below was the result of the cultivation of centuries; above, an example of one of the most recent attempts at reclamation. As far as the horizon extended, not a place of habitation was to be seen, until just at a hollow bend out of the ascending road we came upon a

low white farm-house, flanked by a great turf stack, but with no signs of corn or fold-yard for cattle. This was the one hostelry and habitation on Lord Poltimore's moorland estate—'The Poltimore Arms.' Our conductor opened a gate, in a high stone wall capped with turf; we drove through, left Devon, and entered Somerset and the Exmoor estate."

\* \* \* \* \*

"Very dreary was this part of the journey, although, contrary to the custom of the county, the day was bright and clear, and a hot sun defeated the fogs, and kept at a distance the drizzling rain. We had left the smooth rock-floored road, and were travelling along what more resembled the dry bed of a torrent; turf banks on each side defined rather than divided the property. As far as the eye could reach, the rusty tufted moorland extended, bounded in the distance by round-backed hills. For about two miles we jolted along until we came in sight of the first farm-house. Soon a magnificent crop of turnips came in view, close adjoining a heavy crop of oats. The next three miles, through the heart of Exmoor, was over one of the capital roads constructed by Mr. F. W. Knight's father. Descending a steep hill, we came in sight of a view, of which Exmoor and its hundred districts in North Devon afford many—a deep gorge, at whose precipitous base a trout-stream rolled along gurgling and plashing, and winding round huge masses of white rock. The far bank in places extended into natural water-meadows, where red cattle and wild ponies grazed, and in others rose precipitously. At one point, where both banks were equally steep and lofty, on the far side was a young plantation with thick underwood; but no trees of sufficient magnitude to deserve the name of a wood. Passing the small pool called Simon's Bath, fences gave signs of established cultivation and habitation; a rude ancient bridge, with two arches of different curves, without side battlements or rails, led to the small lodge, adapted from a public-house, for his temporary habitation, by Mr. John Knight, pending the completion of a mansion never completed, the unfinished walls of which rose like a dismantled castle from the midst of a grove of trees. Crossing the stream, not by the bridge but by a ford, and passing through the stone-built straggling village of Simon's Bath, we arrived in the field where the pony sale was to be held, some 10 acres, forming a very steep slope from the upper part, which is comparatively flat, the sloping side extending on the boundary stream broken by a stone quarry, and dotted over by huge blocks of bleached stone."

Amongst the few changes in the scenery wrought on Exmoor, within a quarter of a century, one of the most noteworthy is the construction of a church and parsonage on this picturesque spot;

while below, the thin plantations have grown into luxuriant woods—home of woodcocks in hard weather, and of foxes all the year round.

“The breeding stud of ponies,” to see which was the principal object of my visit, “contained about 400 head. Their produce, which had been, as already mentioned, improved at vast expense, averaged at auction as three-year-olds only about 7*l.* apiece, a miserable return from 10,000 acres.

“The farms, which varied in extent from 500 to 1000 acres, were principally occupied as store farms, with some dairies. The tenants were from Yorkshire, Lincolnshire, Leicestershire, Derbyshire, and Dorsetshire. Modifications of the system of all those districts were tried by the tenants. The plan of reclamation then in course of trial was to burn the turf, dress it with 2½ tons of lime per acre, at a cost of 1*l.* a ton. Then, without other manure, to have a crop of turnips sown on the flat, eat the turnips off in winter with sheep, follow with seeds—a mixture of Timothy grass, clover, and Italian rye-grass—to be pastured for three years, then ploughed up and succeeded by a crop of oats. The next rotation was to be roots, supported by farmyard-manure of beasts fed during the winter.”

But very few tenants lived to see the end of this rotation. It was pretty on paper, but it had a fatal defect—it did not, and it could not, pay in a climate where growing wheat for sale was out of the question. A few small farmers still grow wheat for their own consumption, but it is generally very poor in colour and in quality. Some years after the foreign farmers had disappeared, the gradual rise of prices of stock and meat began to fill the pockets of the North Devon cattle and sheep producers; at last a North Devon man took one of Mr. Knight's large farms near his house at Simon's Bath. He was, perhaps fortunately, not rich, and in the beginning held an auction every spring to let the summer grazing of some of his grass-fields. People began to get accustomed to the idea of an Exmoor farm; and one by one men from the neighbouring parishes took, on leases varying in terms from 4 to 19 years, all the land that Mr. Knight had to let. The rents at first were low. Since the general re-settlement of the estate in the hands of the Devonshire farmers, hardly a case of re-letting a farm or an allotment in Exmoor has taken place without a considerable increase of rent.

This increase has been accompanied in almost every instance by a fresh outlay of capital on the part of the landlord, to make the farm worth the new rent. The farms have seldom changed hands, and the outlay has been usually agreed upon, watched, and executed for the landlord by tenants who have made money on the farm, and who best know its capabilities and its deficiencies.

The enclosure of Exmoor and the surrounding commons, the improvable nature of the slate-soil, and its great and easy adaptability to the wants of the age—beef and mutton—have been of unmitigated advantage to the inhabitants of the neighbourhood, high and low.

Nothing could be poorer or more miserable than the “entourage” of these wastes previous to the enclosures. The farms were generally very small; the farmers were hardly removed from the class of agricultural labourers, to which their brothers and sons often belonged. Wages were but 7s. or 8s. a week, and employment in the winter months almost *nil*.

In some parishes, a great part of the land belonged to these small farmers, whose little holdings were generally mortgaged, and often deeply. These little proprietors lived in such extreme poverty as to be often actually worse off than the agricultural labourers.

In other parishes the farms had for centuries been let on leases for three lives, the annual rent being very small, the chief income arising from fines paid on putting a new life into the lease.

The cultivation was miserable in the extreme. It consisted in making good the fence round one field, and cropping it with oats, year after year, until it would bear oats no longer; then throwing it out, and treating another field in the same way. The best grass-field on the farm was generally chosen as the next in succession for oats. Turnips were almost unknown; and a man who had been seen hoeing a field of them was pronounced a madman for destroying his own produce.

It was a lawless country. The commons extended to the sea-coast for many miles. The farmers were in league with the smugglers; and when a cargo was announced, all the farm men and horses were put in requisition to land it and to convey it by night over the moors to the little inland towns for sale. Some of the farmhouses near the sea had large secret cellars, where the kegs were stowed away.

Sheep and pony stealing was rife on the moors; and herds of stolen sheep and ponies were regularly driven to the chief fairs in the South of England.

Wrecking was not neglected, when opportunity offered, on the rocky and dangerous coast between Barnstaple Bar and Minehead. Families are pointed out whose wealth, such as it is, is said to have been made by some such contraband and unlawful practices.

The neighbourhood of Withypool, where a large undivided common still affords secret ways of conveying stock by night,



without fear of detection, is still celebrated for lost sheep. The old nursery rhyme—

“Steal the sheep and sell the wool,  
Say the bells of Withypool,”

shows that an evil tradition lurks around that locality.

Many of the farm-buildings, fifty years ago, were of the most miserable description. A long building like a shed would sometimes contain two or three farm-houses. The farms (small as they were) were seldom united in a ring-fence. The fields were disposed as if they had been chosen by lot instead of being laid out for the convenience of the owners or tenants. Some catch-water meadows they had, and these were the only pieces of land that were well attended to and kept in good order. The cottages in the hill villages were dirty and wretched, and the pig, when driven, took refuge, as in Ireland, in the dwelling-house.

The enclosure of the commons and the high price of live-stock and dairy produce, have raised the value of the whole hill country. Landlords, tenants, and labourers have alike benefited. Many thousands of acres of inclosed common-land, which fifty years ago counted for little or nothing in the valuation of a parish, are now let for from 10s. to 20s. an acre.

The tenant-class have all money in their pockets; and whereas half a century ago it was difficult to find a good tenant for a farm of 100*l.* a year, several eligible men are now found at once as competitors for farms of three or four times that rental.

But the greatest change for the better has been among the labouring classes. Their condition, thirty years since, partook of the poverty of the agricultural labourers of the south-west of England generally. Since that time their wages have nearly, if not quite, doubled. In the parish of Exmoor there is but one pauper.

The inclosure of the commons opened a wide field for the labourer; nearly 100 miles of new roads, and many hundred miles of new fences (besides building, draining, paving, and other cultivation on lands from which no labourer had ever earned an honest shilling in their uninclosed state), have been mainly done by piece-work during the time of which I am speaking.

The gangers, or small contractors, for this work have developed themselves in great numbers into thriving farmers. In no part of England has the working-class had such an opportunity, during the last thirty or forty years, as in the north of Devon and the adjoining parts of Somerset. These remarks must be



strictly held to apply to the Devonian slate, or Old Red Sandstone, country only, and not to extend to the yellow clays which bound that formation on the south, and reach across the whole basin from the slopes of the Exmoor slates to the Dartmoor granite.

There are few or no parishes here in which thriving farmers are not to be found who sprang directly from the labouring class, and this is nowhere more easily to be seen than on Exmoor.

*William Carter*, of Litton Farm, who has raised himself to the position of one of the best breeders of North Devon stock, was an ox-boy on Honeymead Farm, and afterwards a postilion in the late Mr. Knight's stables at Simon's Bath. His farm is in the wildest part of the Exmoor Hills, adjoining the parishes of Molland and Anstey. He seldom sells a cow calf under 10 guineas, or a heifer under 35*l.* to 50*l.* Shorthorn breeders may laugh at these prices, but on Exmoor they are thought very remunerative ones. Having worked with the subsoil plough and ox-teams in his boyhood, he was not afraid of breaking up the black land, and shortly after taking his farm had some capital fields of reclaimed peat.

*William Carter* still lives on Exmoor, though he has bought at 50*l.* an acre, out of his savings, a farm into which he has put his daughter and son-in-law. He is one of the few Exmoor tenants without a lease, but he well knows that his rent will not be raised during his lifetime.

Excellent herds of North Devon cattle are also to be seen on some of Mr. Knight's South Forest farms. A visit to Emmett's Farm (Mrs. Tucker), and Wintershed Farm (Mr. Richards), will well repay any fancy breeder of North Devon stock.

*William Hayes*, of the Warren Farm (recently dead), had been one of the late Mr. Knight's cattle-herds for many years at 15*s.* a week. His rental was nearly 400*l.* a year on Exmoor alone. His son still holds his lease of the Warren Farm.

*William Fry*, of Picked Stones Farm, came to Exmoor to work in the nursery as a day-labourer.

His predecessor in Picked Stones Farm, *Francis Comber*, was also, in his youth, a day-labourer in Mr. Knight's employment. He afterwards worked a lime rock, and had saved 1000 guineas before he took Picked Stones at a rent of 180*l.* a year, which rent is now, on reletting, largely increased. Comber has retired, with a good competency, to his native village, after placing both his sons in business.

Many other examples may be named on Exmoor alone of labourers who have grown into farmers, but enough has been said to show that the influx into the market of good land, let at

low rentals, which has been caused by the inclosure of the commons, has been turned to good account by the hard-working and intelligent labouring class of North Devon and West Somerset.

The *patois* of the inhabitants of the Exmoor Hill parishes, fifty or sixty years ago, was wholly unintelligible to ordinary Englishmen. A little book entitled 'An Exmoor Scolding, and Exmoor Courtship, in all the propriety and decency of the Exmoor Language, with a Glossary,' was compiled by a neighbouring clergyman, aided by one Peter Lock, a blind itinerant fiddler and native of North Molton. It was printed about the year 1725, and passed through seven editions before 1771. It has since been several times reprinted at Exeter, and was considered a text-book for young barristers on the Western Circuit. Witnesses from the hill country were generally aware of the advantage they possessed in having an unintelligible jargon to fall back upon when teased with questions they did not like to answer. An ordinary tourist can now make himself easily understood in passing through the Exmoor neighbourhood.

During the last half-century the farmhouses and buildings in some of these parishes have been entirely rebuilt, and in all they have been much improved. The roads, from having been execrable, are now almost universally in a fair condition, and many new turnpike and leading roads have been made.

Changes have taken place in the ownership of property. Many of the small freeholds have been sold to men of larger means; and in some cases the old proprietors are living comfortably as tenants on farms where they had starved as landowners. The leases for lives are almost extinguished. Turnips have been encouraged. The old plan of exhausting one field at a time has been exchanged for improved methods which enable farmers to earn and pay a fair rent half-yearly.

The extension of railway communication to South Molton and Barnstaple, as already mentioned, has opened the markets of England to the North Devon farmers. A further railway extension through the hill country is now being planned, which will, when carried out, by greatly cheapening and increasing the supply of lime, increase the produce and the value of the Exmoor district to an amount that no one living can at present estimate.

The rents are paid to the day, and for the last dozen years there has not been an arrear on any Exmoor farm. The new principle in North Devon of breeding and feeding is at the bottom of the success. *The old North Devon farmer sold his store-stock to the dealer; the new one sells his stock fat to the butcher.*

In 1875 and 1876 West Country farmers were thriving on

Exmoor, paying for some dozen farms an average rent of 300*l.* a year apiece. For several years previous no farm had become vacant on Exmoor without it being an object of keen competition by men bred within twenty miles of the confines of the Forest.

But it must be added that between 1853 and 1863 great improvements of a cheap and simple character had been made in the treatment of the land of Exmoor. Mr. Knight had still to face the inconvenience of holding in hand many thousand acres. Attempts made, with great perseverance and more than ordinary knowledge of the principles and practice of breeding, to improve the size and quality of the breeding stud of ponies, by using stallions of a superior character, did not pay. As long as the ponies were treated as wild animals, finding their living on the open moor, helped with a little forest hay in the rare snow-storms, they cost next to nothing; but as soon as they were improved in breed it was found necessary to feed them well in winter on hay and roots, if not with corn, grown on reclaimed land, if they were to grow into animals of any value. If crops were to be grown and gathered to feed ponies, it would evidently pay better to feed flocks whose ewes give a fleece and a lamb every year.

After many inquiries conducted in Scotland, and some experiments with a flock of four or five hundred ewes of the Exmoor breed, Mr. Knight determined on stocking the still unlet portions of the moor with Cheviot or black-faced ewe flocks, to be tended by Scotch shepherds on the Scotch system of selling off the lambs, made as fat as possible, every autumn. This plan has recently been made more easy of execution by the extension through the hill district of the railroads from Taunton, that give access to markets as distant as Bristol, Birmingham, and London.

This very bold, not to say revolutionary, experiment was encouraged by the successful operations of his agent, Mr. Frederick Lovibond Smyth, in growing rape as artificial food for sheep on waste land, not more than three or four miles from the Exmoor boundary, without the great expenses that attend root-growing and preparing land for that purpose.

Mr. Frederick Smyth was a tenant of a farm (Westland Pound) under Earl Fortescue, when, in 1857, on the inclosure of Challacombe Common, several hundred acres of waste land, composed of peat from 12 to 30 inches deep, resting on the before-mentioned impervious *pan*, were added to Westland Pound.

Mr. Smyth tried the experiment of cultivating this wet peat-land by paring, burning, and once ploughing it, then sowing

rape-seed with lime, at the rate of about 3 tons to an acre. The experiment was a success. Rape thus sown in June will produce a crop in six weeks, and it is the only crop that will grow before the land is laid dry, while the tap-roots pierce through the pan and help to disintegrate it. This crop of rape he ate down with sheep. He repeated the same rape crop for three or four successive years, each year having it eaten down by sheep, whose treading, aided by the penetration of the tap-roots of the rape, by that time decomposed the peat almost or quite down to the pan, which was broken up by the subsoil plough. The last year the reclaimed land was sown with rape and seeds mixed, and thus laid down to permanent pasture.

Without lime, peat-land will grow nothing. The system of sowing rape with grass-seeds had been practised with success in the district for several years; but the system of reclaiming moor-land by successive crops of rape, eaten down by sheep, is entirely the invention of Mr. F. Smyth.

Many commons, partly composed of peat-lands, have been inclosed in this district during the past half-century. Much of the dry brown lands of these have been broken up and cultivated. So many crops of oats have usually been taken from this sort of land as to leave it in a worse state than before it was inclosed.

Until Mr. Smyth introduced these lime-grown rape-crops, every other known method of reclaiming black-peat lands failed to produce the immediate return that would justify a farmer in breaking them up, and they for the most part remained in their wild state.

Nothing on these hills feeds sheep so surely and so rapidly as this rape-crop. Sheep turned on it have been known to increase in value from 3s. to 4s. a week, and on an average may be calculated to gain 2s. in that time.

This rape-reclamation system was discovered at a time when the demand for meat for the supply of distant markets was encouraging the hill-farmers to grow mutton as well as wool. In the good old times, wool was the principal object of the farmers on the hills adjoining Exmoor; and mutton, as in Norfolk, when Mr. Coke commenced his agricultural revolution, was only a secondary consideration. This was not extraordinary when the only markets were local markets, which might on any market-day be glutted by an extra flock of fat sheep. Under these circumstances, ewes and wethers alike were frequently kept on the commons until they died of old age. As each parish in the hill-district was, and is, entitled to pasturage on the manorial wastes in proportion to the number of stock kept during the winter, it was every farmer's interest to keep as many as possible, however thin, so long as they were kept alive. This system, if

it can be called a system, perhaps accounts for the North Devon men making such indifferent hill shepherds. They possess little of the practical science that distinguishes the Scotch hill flock-owners.

The steep hill-sides, below the limed reclaimed flats at the top, get the benefit of the washings of the lime, and the feeding and treading of the sheep which go on it to lie and chew the cud after feasting off the rape.

The first experiment commenced on Exmoor in 1868 was carried out with the above described success on one hundred and forty acres of Duerdown. This pasture was eaten by sheep for four years. For the last three years (1877) it has been mown for hay; and after a dressing of one cwt. and a quarter of nitrate of soda and salt has yielded two tons an acre of hay of excellent quality.

The great advantage of this system over the ordinary more elaborate and more expensive plans is that the instrument of reclamation, the rape-crop, feeds mutton that pays all the expenses of liming in the first year.

Mr. Smyth finds that rape pays best when grown in May, but is then very subject to fly. From June to August the crop is more certain.

The sheep and lambs sold off the first rape-crops before November pay for the lime bill, due, according to the custom of the country, at Christmas.

The great object of the reclamation of these moors is to produce permanent pasture, which can be maintained by applying judicious lime dressings from time to time. With this object in view, it is Mr. Smyth's opinion that corn, that is oats, should not be grown on reclaimed moor-land before it is laid down to pasture, as the grass is never so good after a corn-crop. Indeed, a hill-farmer will find it more profitable to grow oats only for the use of his own horses. The ripening is always uncertain, and on recently reclaimed peat-land oats are apt to grow rank and flaggy. His returns must be from horses, meat, wool, and dairy produce.

Some of the best permanent grasses to sow on the improved peats are: Timothy grass (*Phleum pratense*), Yorkshire fog (*Holcus lanatus*), and Cock's-foot (*Dactylis glomerata*), with rye-grass and perennial clovers.

Mr. Knight established his Scotch shepherds either in some of the farm-steadings built between 1843 and 1850, or in substantial cottages, with a garden and grass for a cow attached to each. There they dwell, with their wives and children, in solitude as complete as on their native hills.

The flocks consist of one hirsle of hardy black-faced High-



land sheep, placed on the Chains, as the highest and most exposed part of Exmoor is called; the others are Cheviots, whose merit as producers of wool, mutton, and lamb, in districts where Down sheep could not exist, have long been established.

The permanent flocks consist entirely of ewes, which are kept until they are five years old, then fattened and sent to market with half-bred lambs—generally got by a Shropshire Down or Leicester ram. From 5000 ewes, including yearlings, about 4000 lambs are reared. Those intended to keep up the stock are the produce of pure-bred Cheviot rams, some of which are usually purchased every third year in Scotland. Shropshire Down rams have not only the credit of being sure lamb-getters, but are a favourite cross with the butcher.

With the Cheviot flocks and Scotch shepherds have been introduced mowing and haymaking machines, which are of the greatest possible value in a district where the supply of grass is almost unlimited, where labour is scarce, and the days and hours when haymaking is possible are few and uncertain. With the aid of this machinery, a large quantity of the wild natural forest grass is turned into hay, not of a very fine or very nutritious quality, but good enough to keep the ewes or any rough stock alive in hard winters, for mountain sheep will eat and thrive where more luxurious breeds would starve. This hay is stacked and carried to what the Scotch shepherds call "*Stells*," for the use of the flocks in hard winters.

All the forest grass not cut is, after the custom of all Scotch sheep-farmers, periodically burned down.

In very hard winters, a few locust-beans are added to the forest hay—this being the most convenient purchased food, because it requires no preparation; and the Hill sheep eat it without any hesitation on the first time of asking.

These Scotch sheep, being much more hardy than the native breeds, find a living on the moor in all weathers except in snow-storms, which are very rare on Exmoor as compared with the North of England. About Midsummer, the rape crop comes into use in time for the draft ewes and the lambs, which fall late on Exmoor, and it lasts until killed off by frost about November.

On this rape, alternated with grass, the sheep and lambs are fattened without roots, corn, or cake, and are sent off to be sold, alive or dead, according to the state of the market, between August and November. In November the whole of the draft stock is expected to be sold out.

The lambs, except those purchased on the spot by butchers or jobbers, who travel to Simon's Bath for the purpose, are driven by road to South Molton; there they are killed, cooled, and the



carcasses hung in meat-vans provided for the purpose by the Great Western Railway; and they are delivered in the Metropolitan Market quite as soon as carcasses killed within 50 miles of London; and the meat is in special demand from the flavour imparted to it by the manner in which the lambs are fed.

It will be seen from the preceding description, drawn up on Exmoor itself, that under this, the third and last experiment, the feeding of sheep and lambs, with the help of rape-crops and lime-dressing, actually converts wild moorland, if dry, into permanent pasture without further expense; and that this pasture can be maintained in good condition by periodical dressings of lime without any other manure. On my first visit to Exmoor twenty-five years ago, some beautifully green water-meadows existed near Simon's Bath. Others have since been made, but not in the proportion that might have been expected. Looking at the numerous hill-side springs and brooks, each offering the utmost natural facilities for successful irrigation, more might easily have been done. The brilliant verdure of the existing meadows shows that the water need only be distributed over the hill-sides to produce a most profitable return for cost and labour. It is a point worth noting that the Exmoor pastures never rot sheep. Couch-grass does not exist on Exmoor, and so grassy is the soil that a well limed fallow will find its way into good permanent pasture without a grass-seed being sown on it.

Mr. Knight has lately been sowing some of "the thousand-headed kale," the virtues of which have recently been made known by Mr. Robert Russell, of Farningham, in Kent. Mr. Russell, by careful selection of seed, has succeeded in vastly improving a cattle-food which has been known in Yorkshire for half a century.\* If this kale succeeds on Exmoor, it will fill up a gap between November and Midsummer, after rape has died out and before it comes in again.

In 1873-4 the success of the new system of sheep-farming on Exmoor, with its attendant green crops of rape, had made urgent the necessity of breaking-up and subsoiling extensive tracts of wet peat-land, and converting them into permanent pasture.

Already a great break had been made in North Devon agricultural customs by the introduction on the hills of such advanced implements as iron wheeled ploughs, mowing machines, and hay-making machines. The time seemed to have arrived for trying if steam could not do quickly, effectively, and economically, what ox-teams had done slowly and expensively in 1824.

---

\* Soyer, the celebrated cook, mentions, in his book published in 1863, seeing the "thousand heads" grown in Yorkshire for feeding sheep; but Messrs. Sutton, the seedsmen, of Reading, tell me that the modern reputation of this "kale" as sheep-food is due to the pains bestowed on it by Messrs. Russell in selecting the best seed.

## STEAM CULTIVATION.

Having decided on trying steam, Mr. Knight had the difficult task of selecting from the various rival makers and systems the best machinery for his purpose. He found that Fowler's double-engine set had the advantage of going at once to work without any preliminary fixing of machinery, as well as the immense power of a straight and single action, so necessary in carrying out the Duke of Sutherland's bold determination to manufacture arable land out of deep peats accumulated during centuries over the rough debris of perished forests. But in order to use double engines, nearly parallel roads or tracks, along which the engines can travel, are necessary, and such did not exist on Exmoor. To make such roads would have been very costly; and as Mr. Knight's object was to cultivate for permanent and improved pasture, and not to establish tracts of arable land, they would become useless in a few years when the final object of the reclamation had been achieved. On the other hand, the number of men required for working all the old roundabout systems rendered their employment too costly.

So stood matters until, at the Taunton Show of the Royal Agricultural Society in 1875, Messrs. Barford and Perkins exhibited a new system, invented by Mr. F. Savage, C.E., of King's Lynn.

After a careful inspection of the ground to be ploughed, Mr. Barford undertook to construct a 10-horse engine and set of tackle to work Messrs. Fowler's Sutherland or Marshland plough on Exmoor. The trial took place, to Mr. Knight's complete satisfaction, in 1876. The principle of reducing the speed to meet an extra heavy strain makes this 10-horse engine master of all the power needed—and by passing the large subsoil-hook along the bottom of an empty furrow, instead of ploughing and subsoiling at one operation, the whole tackle is relieved from a strain that might be detrimental to it. In some wet places this hook has succeeded in grubbing the subsoil nearly three feet below the original surface.

The ploughs, both the marshland and four-furrow plough, used by Mr. Knight, were made by Messrs. Fowler of Leeds, and so good are they, that no stone has yet been met with in the process of steam-cultivation on Exmoor that has seriously damaged either of them.

Mr. Savage's system does away with the heavy detached drums which formed an essential part of all the old single engine sets, and he has arranged the road driving-wheels so that they can be used, when ploughing, as most efficient winding-drums, the ropes working in boxes sunk in the wheels, and the end of the engine being blocked up as a platform while

at work. By this arrangement the entire machine is simplified, the boiler is spared the strain it is subjected to when the winding-drum is attached to it, and the large driving-wheels do all the work, whether on the road or in the field. The road-wheels can be driven either together or one at a time, or one forward and the other backward, so that the engine can actually be turned by steam on the ground on which it stands. But the invention that makes this engine more particularly suited to Exmoor is, that it has a very slow speed-gear attached to it, by which it can be lifted in a very few minutes out of any hole or bog into which it may have sunk. The ploughing-tackle is worked by Campain's anchors, moved by chains and balls, on Mr. Savage's latest plan. If, then, water can be led along a plough-track to the foot of the engine, which can frequently be done on Exmoor, the engine and rope take only one man to work it. The Campain's anchors are pushed forward by the balls at the discretion of the ploughman; and although a spare man usually attends the plough, to carry the signal flag, to manage the rope-porters where needed, or to turn a stone out of the way, the set can be worked under favourable circumstances for half-a-day with two men only—one with the engine and the other with the implement. The men who now work the apparatus successfully were agricultural labourers when Mr. Barford came to Exmoor. Compared with the six or seven hands usually employed with the old roundabout sets, the advantage is immense. The engine works with a very small quantity of coal.

Passing over the details of what might make a very interesting agricultural tale under the title of 'Adventures of a Steam-Cultivator on its Journeys through Devonshire Lanes and over Somersetshire Moors,' it will be enough to state that, in the autumn of 1877, the engine, working a Sutherland plough by a roundabout apparatus, was in steady work in exterminating some 400 acres of natural forest grass growing on a skin of primeval peat, nearly all moist, and in some parts with the water standing for an acre or more ankle deep.

This Sutherland plough consisted of two huge shares, that is, one at each end of the implement, and also at either end a sub-soiler in the form of the fluke of an anchor without palms, the whole resting on four barrel-like wooden rollers, which acted as wheels as well as rollers. The engine having been by signal set to work, the plough was slowly dragged forward between two automatic anchors, cutting a huge slice of peat, and making a furrow 12 inches deep and nearly 2 feet wide; the sod, as it was turned over by the plough, being rolled flat by the barrel wheels. When a double journey had been performed forwards

and backwards, the machine was stopped, and one of the hooks let down; and this, in nine cases out of ten, reached, penetrated, and broke up the before-described *pan*, and, with one effort, thoroughly dried, and for ever, the peat which had already been destroyed by being torn from its roots.

The result was equally wonderful and capital. When the subsoiler was set in motion the water stood in pools several inches deep. The moment the iron had penetrated the *pan* the water passed away as through a cullender, and it remained perfectly dry after rain for some part of every day for a week. The work was done at the rate of nearly three acres a day, for it is one of the peculiarities of Exmoor that "rain does not stop ploughing."

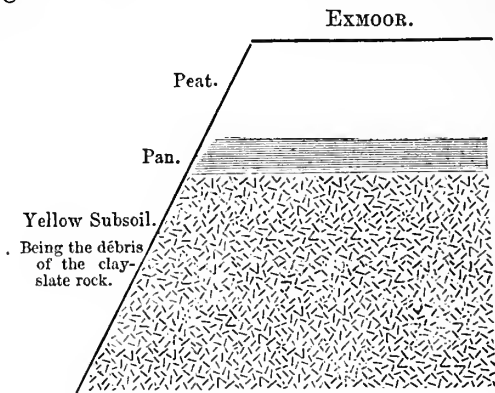

In the opinion of one of the most experienced land-agents in North Devon, the one operation just described doubles the value of the land.

The next steps would be to cross it with a plough or cultivator, then to break it up roughly with a strong harrow, to lime it at the rate of  $2\frac{1}{2}$  to 3 tons an acre of lime drawn by Mr. Knight from the kilns at Combmartin or Lynmouth, with his own horses,\* and finally to sow a crop of rape to be fed-off with sheep. After two or three crops of rape, paid for in fat lambs, the land will be ready to lay down for permanent pasture, requiring no further expense for drainage and no manure beyond lime, which is essential, because the natural soil, being almost devoid of the calcareous element, will not grow the most nutritious grasses until limed.

As to the proportionate extent of deep peat on the last re-

\* Four of these in 1876 were gray French mares, drafts from the General Omnibus Company's stock; bought by the author, lame from London stones, and worked sound on Exmoor.

claimed tract, Titchcombe—an enclosure of 400 acres broken up by steam power,—there were about 50 acres which could only be broken up and drained by the Sutherland plough and hook. Six or seven acres are so deep that they will require tile or stone drains. About 150 acres have been cultivated and the land laid dry by a four-furrow plough, connected by a chain in hauling the last furrow with a light subsoiler; formerly worked by four horses. The rest of Titchcombe could have been broken up by horse or ox labour; but the steam-engine being at work, it saved time to use it.

The following is as nearly as possible the actual cost of ploughing and subsoiling 19 acres of the above-mentioned land “on the west side of Titchcombe;” this being part of 400 acres that were effectually reclaimed up to Christmas, 1876:—

*Cost.*

	£	s.	d.
2 Men, 20 days at 3s. 2d. each per day .. .. .	6	6	8
1 Youth, 20 days at 1s. 8d. „ .. .. .	1	13	4
2 Boys, 20 days at 1s. „ .. .. .	2	0	0
8½ tons of coal at 20s. .. .. .	8	10	0
4 gallons of best oil at 5s. .. .. .	1	0	0
2 „ common oil at 3s. 3d. .. .. .	7	8	
Interest and depreciation on tackle, 14 days at 15s. per day ..	10	10	0
„ „ „ 6 days, when worked for } a few hours only each day at 5s. .. .. . }	1	10	0
Total .. .. .	31	17	8

The following is Dr. Voelcker’s analysis of the soils which are being brought into cultivation by Mr. Knight’s steam cultivator:—

EXMOOR SOILS.

*Dried at 212 degrees.*

COMBINATION OF	No. 1. Dry Land.	No. 3. Wet Land.	No. 5. Clay Pan.
Organic matter and water of com- bination .. .. . }	14·11	28·40	9·90
Oxide of iron and alumina .. ..	1·43	·97	3·38
Lime .. .. .	·19	·05	·08
Sulphuric acid .. .. .	·04	·03	·02
Phosphoric acid .. .. .	·29	·15	·14
Magnesia and alkalies .. .. .	1·49	·90	·47
Insoluble siliceous matter .. ..	82·45	69·50	86·01
	100·00	100·00	100·00



The results of the reclamation of Exmoor, since 1818, may be summarised in a very few words:—

In 1841, when handed over to the management of the present owner, there were only two tenants, one of whom paid 40*l.* and the other 30*l.* a year, and there were only two farm-houses and seven cottages; ten years later a score of good farmhouses and homesteads had been constructed, which no Devonshire man would rent on any terms, while the landlord derived a small and precarious return from a stud of native ponies. When twenty-five more years had elapsed there were twenty-eight farm-houses and fifty cottages; all the farms had for several years been let to substantial thriving farmers, born and bred in the immediate neighbourhood; and the applications for farms, when vacant, gave the landlord ample choice. The four hundred ponies had been reduced to forty mares, whose foals were sold annually. The summer and winter pastures in hand, with additional rape-crops, were consumed by 9000 ewes and lambs. Steam subsoiling and cultivation were rapidly preparing wild land for crops which would enable the breeding flock to be increased by at least one-half.

The substantial improvements have not been executed without the "master's eye." For many years, Mr. F. W. Knight has spent the greater part of the Parliamentary recess on Exmoor, superintending the details of his pastoral and agricultural innovations in person. In three visits to Simon's Bath Lodge in 1875, 1876, and 1877, I have traversed the district and realised the progress of the works which I have attempted to describe.

*Dairying.*—The North Devon farmers have within the last few years opened up a good market in London for the speciality of the county, namely, clotted cream. But up to the present time the operations of dairying, and particularly of butter-manufacture, are conducted in as barbarous a manner as in any part of England or Ireland. Mr. George Allender observed, in a paper on *Dairying*, read before the Farmers' London Club, in 1877, that, "Nothing commands a more certain sale than first-class butter; there is plenty of second-class. The difference is many pence per pound, and the difference between first-class and second-class in ninety cases out of a hundred is only a matter of better management and attention to trifles. . . . ; three-fourths of the butter is spoiled after it is churned, from not getting the butter-milk thoroughly out of it and not making it up close, so as to exclude the air."

The North Devon Dairy farmers have everything in their favour, an excellent breed of cows, soil, climate, and generally unlimited supplies of soft running water; but their operations are conducted entirely by rule-of-thumb, entirely dependent on



the skill of the dairy-maid, without any assistance, modern machinery, or modern experience.

To expect full-grown North Devon farmers or dairy-maids to learn anything from reading is nearly as much out of the question as in the days of Arthur Young; but, in my opinion, the landlords might do much by introducing into the village schools manuals on the work of the future lives of the boys and girls. A short practical and interesting manual on Dairy Work might easily be prepared from the 'Journal of the Royal Agricultural Society of England,' with woodcuts of the cooling apparatus, churns, and butter-making machines, which are in familiar use on the peasant-farms of Sweden, and are sold at a very low price.

---

IV.—*Report on the Farm Prize Competition in the Isle of Man, 1877.* By S. D. SHIRRIFF, of Saltcoats, Drem, N.B.

IN connection with the country meeting of the Society for the year 1877, the following prizes were offered by the Liverpool Local Committee for the best managed farms in the Isle of Man; viz., in Class 7, for the best managed farm of 70 acres or upwards in extent, 25*l.*; and in Class 8, for the best managed farm under 70 acres, but of not less than 25 acres in extent, 15*l.* In Class 7 there were only two entries, and in Class 8 but a single competitor. Before proceeding to describe the competing farms, it may be of interest to give a few particulars regarding this beautiful little island, dropped as it were into the sea, and almost equidistant from what were formerly three great kingdoms, now made greater from being happily all blended into one. In order to realise the singular situation of this island, I may mention that on a clear day a distinct view of England and Scotland and Ireland can be had from the top of one of its mountains called Barrule—not a bad site, one would almost say, for a royal palace.

The length of the island is about 33 miles. Its breadth varies, being at its widest part about 8½ miles. It contains about 130,000 statute acres, and its population is a little over 60,000.

The climate of the Isle of Man is wonderfully mild. The annual mean temperature is higher than that of any other place occupying the same parallel of latitude. The genial influence of the Gulf Stream causes this. The mean winter temperature of the Isle of Man is about 42° Fahr., whereas the temperature of Newfoundland, which lies 7° further south, is 18° colder during winter, owing to the influence of Arctic currents. There could

be no better confirmation of the mildness of the climate than the proof afforded by the beauty and luxuriance of some delicate varieties of shrubs, and whole hedgerows of fuchsias of large size may be seen in great perfection.

I pass over the very early history of the island. It is a spot singularly rich in legendary lore. For 400 years it was the home of the Druids, and many of their stone circles are still to be seen. There are also numbers of stone crosses similar to those in Ireland, bearing Runic inscriptions, which testify to the conquests of Christianity under the banner of St. Patrick. It was successively the property of Norwegian, Scottish, and English princes, forming a dependent sovereignty in the great feudal system. For three centuries under the sway of the Earls of Derby, it passed to the Dukes of Athol, and finally into the hands of the Crown, who purchased all their rights and privileges from the Athol family so lately as 1829 for 416,000*l.* I mention this sum to show what changes a few years make, the lead mines of Laxey alone having paid to the Crown in thirteen years upwards of 80,000*l.* in royalty, or about one-sixth of the whole purchase money of the island.

#### COMPETING FARMS.

I now come to describe the competing farms in Class 7. Both are near Castletown, where the Judges arrived on the evening of the 25th of June, after rather a stormy passage from Liverpool to Douglas, proceeding on per rail to Castletown. We inspected both farms next day. Our instructions in regard to awarding the prizes were similar to those for the Liverpool district, viz., to consider:—

1. General management with a view to profit.
2. Productiveness of crops.
3. Goodness and suitability of live-stock.
4. Management of grass-land.
5. State of gates, fences, roads, and general neatness.

The farm described first, and which we considered, on the whole, most deserving of the prize, is in the occupation of Mr. Thomas Farghar. It is called Whitestone Farm, and lies about a mile from Castletown. The proprietor is W. L. Drinkwater, Esq., Kirby-by-Douglas. The soil may be described as light. The subsoil Mr. Farghar, in his schedule, mentions as being shingle—a light gravelly débris of the limestone formation. The farm comprises about 122 acres imperial.

The rotation adopted by Mr. Farghar appeared to be most suitable for the soil, viz., pasture which lies generally for three

years, and when ploughed, is sown either with wheat, barley, or oats, whichever is most suitable for the fields. Then a green crop follows in the shape of beans, potatoes, and turnips. A white crop succeeds these, and the land is again sown down with grass-seeds.

This farm is admirably adapted for grazing. A river, which bounds one side of it, gives a fine supply of water to nearly every field. When we inspected this farm it was under the following crops, viz. :—

Wheat, 23 acres, after turnips.	Swedes, 25 acres.
Barley, 16 acres, roots and grass.	Yellow turnips, 1½ acre.
Oats, 7 acres, roots and grass.	Beans, 8 acres.
Potatoes, 2½ acres.	Pasture, 26 acres.
	Old grass, 5 acres.
	Hay, 7 acres.

The grain crops gave promise of being good. The potatoes looked particularly well, and we admired the capital ploughmanship which was shown by the straightness and regular width of the drills. The beans were very good indeed, and we were particularly well pleased with the pasture, the strong healthy clover plants proving the soil to be in capital heart. The hay was also a good crop.

I may here give the mixture of grass-seeds Mr. Farghar sows, viz., 4 lbs. red clover, 4 lbs. white, 2 lbs. alsike, 3 lbs. trefoil, with 1 bushel perennial rye-grass and ¼ bushel Italian.

*Stock.*—The stock kept on the farm may be described as movable. We saw 30 good three-year-old bullocks which had been kept during winter in the cattle-courts, and were being grazed for a short time preparatory to being sold to the butcher. The sheep stock were ewes—two score of the Shropshire breed; these are put to Shropshire rams. The lambs are sold fat, at an average price of about 42s. The produce of the 40 ewes averages about 60 lambs. The old ewes are sold in August at a profit of 10s. per head, exclusive of the wool.

*Labour.*—2½ pairs of horses generally do the work of the farm; but three pairs were employed last season. Three ploughmen, all married, are kept, and live on the farm, receiving 13s. per week, with free house and garden, 1½ ton of coals, and 2 bushels of potatoes. No extra wages are paid during harvest. Women employed receive 10d. per day, and 1s. 6d. during harvest.

*Manures.*—Mr. Farghar uses about 8 tons of bone manure for his turnip crop. From being near the coast he has a plentiful supply of sea-weed, with which he manures the stubble as an addition to as much farmyard-manure and lime-compost as he can possibly manufacture. Mr. Farghar keeps one cow for the

house, and fattens two pigs. He breeds no cattle, finding it more profitable to purchase those he requires for eating his turnips and rotting down straw to supply manure for the farm. The gates and fences were all in pretty good order. We considered Whitestone Farm to be in a creditable condition, the pasture fields, which may be invariably taken as one of the best tests, being particularly well laid down and showing capital cultivation. Mr. Farghar holds his farm under a system of three years' tenure.

The other farm competing in this class is called Balladoole, the property of William Baring Stevenson, Esq., of Balladoole, Castletown. It is farmed by Mr. Thomas Fisher. It lies one mile to the west of Castletown. The extent is 189 acres. The soil varies from heavy clay to light gravelly land, all upon the limestone formation. The tenancy is from year to year. When we inspected this farm, we found it under crop as follows:—

Wheat, 39 acres, 10 after grass, 10 after potatoes, 8 after beans, 5 after mangolds, 6 after turnips.

Barley, 32 acres, 19 acres after wheat, 13 after turnips.

Oats, 9 acres, after wheat. Beans, 6 acres.

Potatoes, 10 acres. Pasture under rotation, 34 acres.

Swedes, 19 acres. Hay, 7 acres.

Greystone, 3 acres. Pasture, 6 years old, 19 acres.

Mangolds, 4 acres. Pasture, 11 years old, 5 acres.

The wheat crop on this farm varied much in appearance. Some portions were exceedingly good; others, again, were not very good. The variety of the soil was one of the causes of this difference, another being the effect of the preceding crops. The barley crop promised, on the whole, to be a good average one. Potatoes looked healthy and vigorous, and there was a fine promise of the turnip crop, the young plants being strong and regular all over the breadth sown; but both potatoes and turnips were suffering from the hoeing and singling being behind, which was not to be wondered at in consequence of the nature of the season, a rapid vegetation of weeds, and a scarcity of labour to overcome these difficulties.

*Stock.*—Mr. Fisher keeps 11 cows, 1 bull (Shorthorn), 10 calves, 6 yearlings, 5 two-year-olds, 6 three-year-olds. Four had been sold at prices varying from 22*l.* to 31*l.* There were 42 ewes,—one-half Shropshire, the other half Leicester. The lambs are all kept over the winter and fed off as shearlings. Mr. Fisher finds he can get the highest price for the Shropshires as mutton. He was very unfortunate with his lambs last season, having lost forty by worms in the lungs.

*Horses.*—Ten horses are employed on the farm ; also a foal, a yearling, and a two-year-old. Five pigs are bought in to fatten.

Mr. Fisher pays about 100*l.* a year for artificial manures, and about 22*l.* for cake. In addition, he uses a considerable quantity of beans, barley, and oats for feeding purposes.

*Labour.*—There are four cottages on this farm. Carters receive 13*s.* per week, free house and garden, and 1½ ton of coals. The total cost of labour for the year is a little under 2*l.* per acre.

Mr. Fisher lays down his pastures with 3 lbs. per acre of red clover, 3 lbs. white, 3 lbs. alsike, 2 lbs. trefoil, 1 bushel mixed ryegrass, one-third being Italian and the remainder perennial.

Mr. Fisher's system of farming is quite different from Mr. Farghar's, both in regard to the management of the stock and the cropping of the land. The former breeds all his cattle and keeps on his lambs ; the latter purchases his cattle and sells his lambs off the ewes. Mr. Fisher takes two consecutive white crops : Mr. Farghar never more than one white crop. Our Isle of Man experiences are too limited to enable us to give an opinion as to which practice is most suited for the district, as so much depends upon the capabilities of the soil and *the situation* in regard to the supplies of manure to keep up the condition of the land. We considered that the entire management of Balladoole reflected credit on Mr. Fisher's skill as an agriculturist, and that he showed an evident desire to introduce and prove new systems of farming.

The farm which competed for the prize in Class 8 lies on the road between Peel and Ramsey. To reach this farm we drove from Castletown to Peel—a most beautiful drive, giving us a view of the south-west coast of the island. Our route took us through Glen Meay, on to Peel, where we remained all night.

We drove to Ballaneddin. It is a freehold, the property of, and farmed by Mr. John Teare. Its extent is 50 acres arable and 10 acres pasture. The soil is medium ; and the sub-soil is a mixture of gravel and clay. Mr. Teare had :—

7 acres wheat after three-	}	{	9½ acres hay.
year-old grass.			24 „ pasture.
10 „ barley after old grass	}	{	½ „ carrots.
and roots.			½ „ mangolds.
3 „ oats after old grass	}	{	1½ „ potatoes.
and roots.			4 „ turnips.

The stock kept consists of 3 working horses, 1 two-year-old colt, 4 milch-cows, 4 calves, 3 yearlings, 1 two-year-old. The cattle are all reared and sold fat at two years old in spring. Mr. Teare keeps 18 ewes ; and had from these 23 lambs, cross-



bred between Shropshire and Leicester; of these, 12 lambs had been sold at 35s. He employed one man at 17*l.* per annum, with food in the house, and the field work was done by hired-in workers at 1s. per day. We considered this farm to be under most careful and economical management.

Mr. Teare is an exceedingly earnest hard-working man, of an old Isle of Man family, proud of his holding and most anxious to improve it to the utmost of his power.

With this inspection our duties of judging were finished. We drove on to Ramsay through a beautiful country, rich in its agricultural aspect. We passed some fine farms and saw some beautiful pastures stocked with both fine cattle and sheep. From Ramsay we drove through Laxey, and saw its wondrous water-wheel. It is 72 feet in diameter, and capable of pumping 250 gallons of water per minute from the lead-mine from a depth of 400 yards. From Laxey we went on to Douglas, where we got a steamer for Liverpool.

We left the Isle of Man favourably impressed with much we had seen. Its natural beauty is very great. A great portion of the soil is rich, and with such a mild climate its agricultural resources must be large. It is a matter of regret that the Prize Farm Competition was so limited, as these contests tend much to improve the agriculture of a district. No better illustration of this can be given than the high state of cultivation of the farms in the Lancashire districts where such competitions have been longest in vogue. But it must be borne in mind that the farmers of the Liverpool district possess many advantages which the Isle of Man farmers do not enjoy. The rent of the land, judging from the average of the farms we visited, is high in the Isle of Man. Then in regard to the disposal of farm produce, the advantages are entirely on the Liverpool side. The Isle of Man farmers must either rear or purchase cattle to consume straw and turnips to supply manure for the farms, while the sums realised off the farms near Liverpool, from the sales of hay and straw, are very large, the price of straw now being far above its value for manure. No district could possess greater facilities for the disposal of, or command a better market for, every kind of farm produce, and also for obtaining supplies of manure. The large sums there realised for straw and hay are impossibilities to the farmer in the Isle of Man; but he might possibly compete successfully with the very earliest varieties of potatoes. With high farming there is always a proportionate amount of extra risk, and when a disastrous season like the present one ensues, there is a much greater loss. A careful economy pervades the Isle of Man system of farming, and what may be described as an agri-



cultural balance is well maintained. What I mean is, there is not too much dependence or expense placed on the results of any single crop, the failure of which may seriously affect the balance for the year. As already stated, the rents are high, about 3*l.* per acre, and rates are by no means low, the following being paid on a property-valuation of 77*l.*, viz., tithe, 5*l.*; lunacy rates, which are singularly high all over the island, 2*l.*; school rate, 2*d.* per *l.*; road rate, 3*d.* per *l.* Labour is more expensive, and farm burdens are greater, in Lancashire, but, taken as a whole, we consider that the chances of agricultural success are greater on the mainland than in the Isle of Man. In our drive over the island we were struck with the numbers of people who seemed to go there for pleasure. A constant succession of carriages of every description were passing along the thoroughfares, giving quite a holiday aspect to the country. I am sorry to add that the results of their present crop do not differ from our own, the cereal crops showing a deficiency of nearly 50 per cent; potatoes were nearly a total failure; and the turnip crop a very poor one. I conclude this report with an expression of the pleasure that my colleagues and I enjoyed from our visit to "Ellan vannin veg veen," *Anglicè*, "dear little Isle of Man," and our thanks for all the information and kindness we received during our stay in the island.

It would be ungrateful to leave finally the Farm-Prize Competition of 1877 without expressing the thanks of the Judges to Mr. Rigby, the Secretary of the Local Committee, who gave us most valuable information as to routes, and was in every respect most courteous and obliging.

S. D. SHIRRIFF.  
T. P. OUTHWAITE.  
J. D. OGILVIÈ.

V.—*Report on the Implements at the Royal Agricultural Society's Show at Liverpool; and on the Trials of Self-binding Reapers at Aigburth.* By J. HANNAM, of Pocklington, Yorkshire.

SEVERAL circumstances combined to lighten the duty of the Official Reporter. The Judges awarded only three of the Society's Silver Medals out of the ten at their disposal; and out of eight Self-binding Reapers entered for exhibition at Liverpool only five were shown, and of these only three came to trial at Aigburth. These three machines were exhibited at the recent Philadelphia Centennial Exhibition, and of two of them Mr. Coleman has given a detailed description in the last volume

of this Journal, in his exhaustive Report of the Agricultural Implements at that Exhibition. A general view of the Liverpool Meeting, as compared with previous Shows, has also been given in the Report of the Senior Steward.

Despite these circumstances, the magnificent exhibition of 6900 implements and machines affords "room and verge enough" for the Reporter's observation and comment. There were, in fact, a large number of exhibits which were noticed by the Judges, and which were ineligible for a medal according to the Society's regulations on the score of not being entirely new, of having been exhibited at a previous show, or of not being agricultural.

Of such of these as they deemed most entitled to notice they supplied a list to the Reporter.

There were also many inventions which, though not quite of importance enough to be distinguished by the special notice of the Judges under the conditions regulating the competition for medals, were excluded from a "commendation" by the 6th regulation, which specifies that "no commendation of miscellaneous articles shall be made by the Judges."

The Judges of Self-binding Reapers were Mr. John Coleman, Riccall Hall, and Mr. Henry Cantrell, Baylis Court, Slough; of Miscellaneous Articles, Mr. John Thompson, Badminton, Chippenham; Mr. J. W. Kimber, Fyfield Wick, Abingdon; and Mr. S. Rowlandson, Newton Morrel, Darlington; with Mr. W. Anderson, C.E. (of Messrs. Eastons and Anderson's, Erith Ironworks, Kent), as Consulting Engineer, and myself as Official Reporter.

These gentlemen made their inspection of the whole of the exhibits in the Showyard, on Monday, 9th of July, and the three following days.

The following regulations, under which the Judges made their awards, were laid down in the Prize Sheet:—

#### GOLD MEDAL.

The Gold Medal of the Society will be awarded at Liverpool, or any future Meeting, for an efficient Sheaf-binding Machine, either attached to the Reaper or otherwise.

#### SILVER MEDALS.

1. There are ten Silver Medals, the award of which the Judges appointed by the Council have the power of recommending in cases of sufficient merit in new implements exhibited at the Liverpool Meeting.

2. These medals cannot *in any case* be awarded to any implement, unless the principle on which the implement is constructed be entirely new, and the implement has never before been exhibited at any of the Society's Shows.

3. These Medals are specially intended as a mark of approval of any new principles of construction which the Judges may consider as *essential improvements*; subject always to the restriction contained in Rule 2.

4. The Judges are also empowered to make special awards of medals for efficient modes of guarding or shielding machinery, especially when worked by steam, from contact with persons immediately engaged in attending to such machinery while at work.

5. No medal shall, in any case, be awarded to any implement or miscellaneous article, capable of trial, until it has been subjected to such trial as the Stewards may direct.

6. No Medal shall be awarded by the Judges without the consent of the Stewards, and no commendation of miscellaneous articles shall be made by the Judges.

It being determined, owing to the backwardness of the harvest, not to test the competitors for the Gold Medal at that time, the trial was postponed. A careful examination of the construction of each implement of the class in the yard was, however, made.

The Judges of miscellaneous articles, after a tedious circuit of the yard, and a careful inspection of the multitudinous ingenious machines claiming their attention, decided only to award three of the ten medals at their disposal, thereby leaving a considerable number of novelties and improvements undistinguished, except by the notice which the Reporter may be able to give them.

#### REPORT OF THE JUDGES OF MISCELLANEOUS ARTICLES.

To the Stewards of Implements:—

We recommend that medals be awarded to the following articles:—Stand 243, No. 5304. W. N. Nicholson and Son, for their patent Grist Mill.

Stand 205, No. 4362. Hodgkin, Neuhaus and Co., for their new patent Boiler-feeder.

Stand 262, No. 5838. Clayton and Shuttleworth, for their new patent Drum-guard on Threshing-machine.

We have taken notes of several other novelties and improvements, a list of which we handed to our Reporter, a copy of which you can have if desired.

JOHN THOMPSON.  
J. W. KIMBER.  
SAMUEL ROWLANDSON.

We sanction these recommendations.

J. BOWEN JONES.  
JOHN HEMSLEY.  
GEO. H. SANDAY.

#### GOLD MEDAL.

This medal was offered for “an efficient Sheaf-binding Machine, either attached to a reaper or otherwise.”

There were eight entries in this class, viz., Messrs. Burgess and Key, of Holborn Viaduct, London; Messrs. James and Frederick Howard, Bedford; Melville Thomson Neal, of 22, Buckingham Street, Adelphi, London; H. J. H. King, of Newmarket, Stroud, Gloucestershire; Chyms H. McCormick, of Chicago, Illinois, U. S. A.—agent, Rush F. Mason, of 142, Queen Victoria Street, London; Phillips and Co., of the

“Enterprise” Reaper Works, Grantham, Lincolnshire; Walter A. Wood, of 36, Worship Street, London; and D. M. Osborne and Co., 125, St. Ann Street, Liverpool.

Three of these entries were not represented in the Showyard. The absentees were Messrs. Burgess and Key, Howard, and Phillips. Their machines were new inventions, and considering the very limited period of time during which they can test harvest machines, they no doubt acted wisely in making use of that limited period for experimenting with their new ideas instead of coming to a public trial in doubtful form, especially as several of the competing machines that they would have met had been in practical use for some time, and last year had been tested at the Philadelphia Centennial Exhibition. Mr. Neale and Mr. King were the only two English makers who faced the American trio of McCormick, Wood, and Osborne.

Mr. Neale's machine was the greatest novelty in principle, and the prettiest piece of mechanism in the yard. It is in advance of the American machines, all of which tie with wire, in the point that it ties with soft string or yarn. So far as the tying-up goes, it certainly makes the knot, and binds the sheaf experimented upon in the Showyard. Its adaptability for general field-work is another thing, and is greatly to be doubted, owing to the mechanism being somewhat complicated.

Mr. H. J. King's machine is more simple in construction. It is priced at only 35*l*. This machine did not compete, because the band was too short for the straw. It ties with string without a knot, the ends being twisted together and left perfectly secure. The corn, after being cut, is carried to a table on the side of the delivery board, and at the same level, by an ingenious arrangement of fingers, where the string is passed round the sheaf. The low level of the table is a disadvantage that in practice might result in the clogging of the machinery. Neither of these machines came into the trial field.

The three remaining machines in the yard were the “Harvester and Sheaf-binder” of Chyms Henry McCormick, of Chicago, U. S. A.; the “Harvester and Binder” manufactured by Walter A. Wood, London; “Harvester and Automatic Self-binders,” manufactured by D. M. Osborne and Co., Liverpool. All these machines were tried at the Philadelphia Centennial Exhibition, and the two former are fully described in Mr. Coleman's admirable Report in the last volume of the Society's Journal, to which I am indebted for the illustrations and mechanical description which are now appended.

McCormick's machine has been in use in America six years, and is a combination of upwards of twenty patents, and has been produced at a cost of upwards of 10,000*l*. It is a strong, heavy

machine, and seems to require a powerful draught. The following figures, showing front and rear elevations of McCormick's Grain-binder, and the mechanical description, are from Mr. Coleman's Report:—

The chief peculiarity of the invention consists in the mounting of the binding-apparatus upon a traversing carriage so that the binding-arm moves up to that part of the table which receives the grain from the elevating apron, strikes into the inflowing grain, separating the portion to be bound, encircles it with wire, which, owing to the application of a spring arrangement, is endowed with the requisite degree of tension to secure a closely-bound sheaf, twists the wire and cuts it off during the backward movement, and finally discharges the sheaf.

The driver adjusts the binding mechanism so as always to bind the bundle midway of the length of the grain, by means of a lever-handle, mounted on a small lantern-wheel working in a rack and connected, by flexible links passing over pulleys, with the binding mechanism, which moves freely backwards and forwards in a direction parallel with the length of the grain. The subjoined illustrations (Figs. 1 and 2) show the front and rear elevation of the binding-

Fig. 1.—*Front Elevation of McCormick's Grain-binder.*

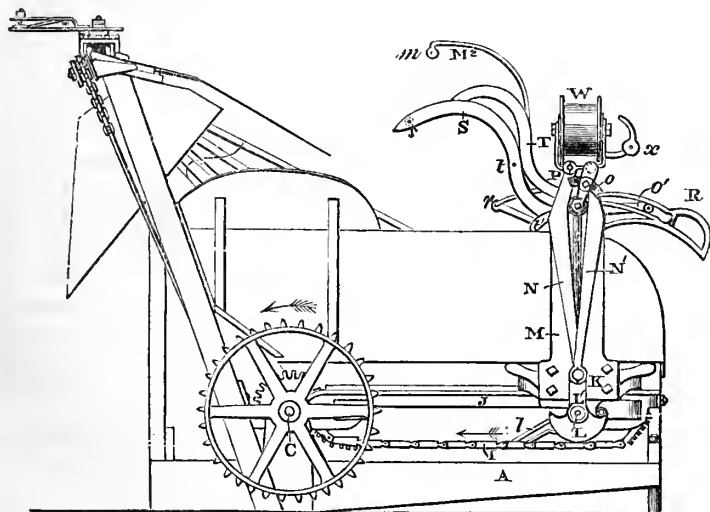

apparatus. C is the driving-shaft, on which is a double sprockle-wheel which gears into corresponding wheels on which the driving-chain I passes, as well as over corresponding wheels on the opposite end of the gear frame J. The arrow shows the direction in which the chain-gear travels. This chain carries a slotted link, l, connected with a shaft, L, and imparts the reciprocating motion to the binding-arm necessary for the various motions. I will endeavour to describe the mechanism. N, N<sup>1</sup> are pitmen pivoted on the crank L<sup>1</sup> of the shaft L, attached respectively to the cranks o p of two rocking shafts, concentric with each other and mounted in bearings in an overhanging support of the binding-frame. The crank which operates the compressor is adjustable laterally by the slotted rack and set screw, and its throw is thus regulated. The inner

rocking-shaft consists of a steel rod carrying at its forward end a crank arm,  $O^1$ , working in a slot in a vibrating compressor,  $R$ , pivoted at  $r$ , so as to give the compressor a movement eccentric to that of its driving-shaft. This shaft, owing to this construction, allows the compressing arm and its crank to yield under the strain of binding the sheaf. The binding-arm  $S$  is slotted lengthwise to receive the supplementary arm  $T$ , pivoted at  $t$ , and is vibrated at proper intervals. Two wires are used in binding, and consequently two twists are formed. The wire from the upper reel  $W$  passes through a tubular spindle,  $x$ , with a tension spring, thence over a pulley,  $m$ , on the arm  $M^2$ , thence over the

Fig. 2.—Rear Elevation of McCormick's Grain-binder.

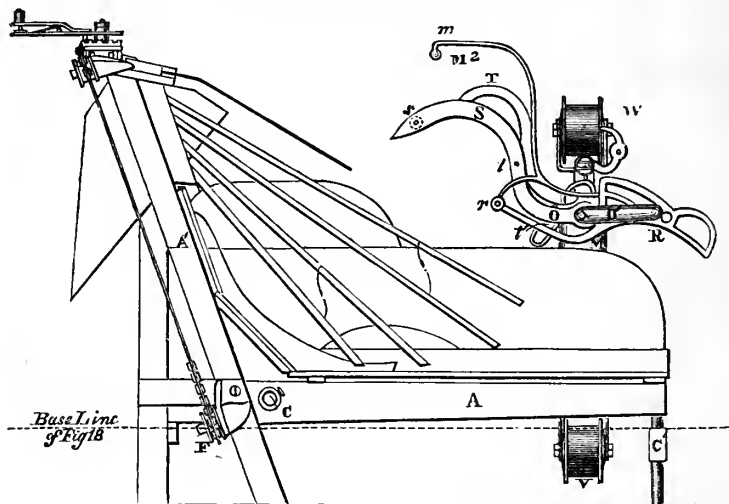

pulley  $s$ , where it is united to the lower wire. The lower wire passes from the spool  $V$ , a positive feed being employed. This arrangement is very clever. The wire is only fed when a bundle is bound. We will suppose that the two wires are connected, then the binding-carriage is ready to move forward with its binding-arm uplifted as is seen in the figure, in readiness to encircle a bundle lying upon the platform. In the absence of any grain to be bound, the binding mechanism would go through its motions and return to its starting-point, but no wire would be fed from the lower spool.

Although heavy, the machine is under perfect management and control, and the change from a heavy to a light cut can be effected instantly. Wood's machine, though of the same price as McCormick's, is much the lighter of the two. The tying apparatus is most ingenious, and to the way in which it twists and cuts the wire no justice can be done by description. The delivery of the tied sheaf is a specialty that I shall have to notice when describing the trials. This machine is said to have cut 8000 acres of wheat this season. The following figures and descriptions are given by Mr. Coleman :—



Fig. 3.—Plan of Walter A. Wood's Harvester and Self-binder combined.

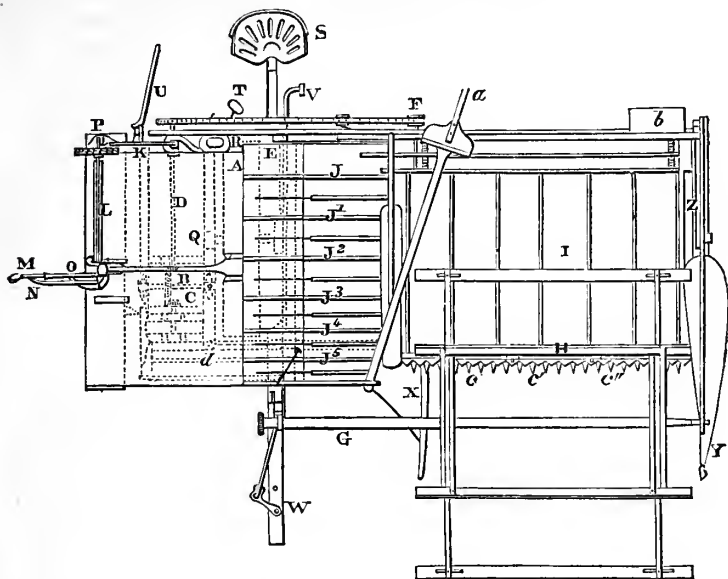

- A. Driving-wheel, with spur-gear.  
 B. Cross-shaft, driven by A.  
 C. Crank-shaft, driven by bevel-gear from B.  
 D. Elevator driving-shaft, driven like C.  
 E. Large elevator-roller, driven by chain and chain-wheel from D.  
 F. Apron driving-roller, driven same as E.  
 G. Reel, driven by chain.  
 H. Sickle-bar.  
 I. Apron with slots, carries grain towards J<sup>1</sup>, &c.  
 J, J<sup>1</sup>, &c. Elevator belts.  
 K. Oblique shaft, driven by bevel-gear from D.  
 L. Binder-shaft, driven same as K.  
 M. Binder-arm.  
 N. Compressing arm.

- O. Reciprocating arm.  
 P. Standard supporting shafts and arms.  
 Q. Receptacle for the grain.  
 R. Stand for wire-spool.  
 S. Seat for driver.  
 T. Foot-lever for stopping action of binder.  
 U. Lever for altering position of binder.  
 V. Tilting-lever.  
 W. Pole.  
 X. Inside divider.  
 Y. Outside do.  
 Z. Ground-wheel.  
 a. Seat standard to attach seat, when binding by hand.  
 b. Tool-box.  
 c c' c'' Fingers.  
 d. Pitman.

The driving-wheel of large size is indicated by the dotted lines at A. The first motion shaft B is driven by spur-gearing; a bevel-wheel on this shaft drives from either side the crank-shaft C, and the elevator driving-shaft D. The two pinions balance each other, and as the binding machinery is driven from D, it will be seen that the arrangements for producing complicated effects are remarkably simple. The rollers which drive the apron and elevator by which the corn is carried from the knife to the tying-apparatus are both driven from the end of the shaft D by chain-gearing. This, again, is well contrived. The apron with wooden slots is shown at I, and the elevator-belts at J<sup>1</sup> J<sup>2</sup> J<sup>3</sup> J<sup>4</sup> J<sup>5</sup>; and this completes the whole of the machinery belonging to the harvester proper. The tying-apparatus can be readily detached and the machine worked by manual binders; all that is required is to shift the driver's seat from S to *a*. Before I proceed to details, it may facilitate my explanation if I briefly state the plan of working. The corn is delivered in a continuous stream on to the concave table Q. The revolving binder-arm, with

the compressing and reciprocating arm, collect the corn into a sheaf, bind it round with wire, twist the same, and cut it off; all this taking place during part of the revolution of the binder-arm. The sheaf is made and thrown off the platform by means of a couple of springs, not shown in the illustration. The ingenious mechanism by which the two wires are twisted and cut off is more easily understood than described. It is effected by the action of two small toothed wheels working in opposite directions. The cutting off is effected when these wheels cease to move forward, the wire coming in contact with a sharp edge.

Fig. 4.—*Front Elevation of Walter A. Wood's Harvester and Self-binder combined.*

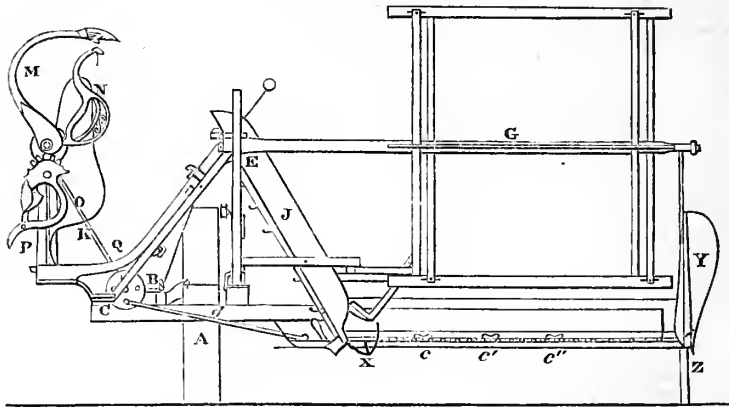

- A. Driving-wheel, with spur-gear.
- B. Cross-shaft.
- C. Crank-shaft.
- E. Large elevator roller.
- G. Reel, driven by chain.
- J. Elevator belts.
- K. Oblique shaft.

- M. Binder-arm.
- N. Compressing arm.
- O. Reciprocating arm.
- P. Standard.
- Q. Receptacle for the grain.
- Y. Outside divider.
- Z. Ground-wheel.

Fig. 4 enables me to proceed with my description. The motion for securing the action is derived from the shaft D by bevel gearings driving the shaft K, which again communicates motion to the binder-shaft L. By a crank-gear the binder-arm M is made to revolve. The compressing arm N is so contrived as to ensure the proper amount of pressure on the band. R is the stand for the wire-spool, a variable tension being provided for. The driver, by foot-leverage at T, can stop the binder at any point, and thereby regulate the size of the sheaf if required; for the action is automatic and continuous. The lever U, also within reach, is useful for shifting the position of the binder according to the length of the straw, so as to have the bands in the proper place. V is a tilting-lever for altering the angle of the platform. The reel, which can be raised or lowered, placed forward or backward, according to the nature of the crop, is driven by chain-gear from the hub of the driving-wheel.

Osborne's machine is called the "Gordon Binder and American Harvester." The inventor has been at work on it since 1863, and in 1866 eleven were used successfully through the season. Its operation is simple. The grain is reeled to the cutters with the ordinary reel. It is cut and dropped on an end-

less canvas apron, which elevates it over the wheel to the binding table. The binder-arm with the needle, having the wire passed through it, passes the wire around the sheaf and carries it down to the twister which is below the binding table. There the two ends of the wire are taken in the twister, which performs its work as the sheaf is moved away from the next sheaf; thus while the sheaf is being removed from the table the wire is twisted and cut off, and the sheaf, securely bound, drops gently to the ground. The end of the wire is returned in the twister, and the operation is repeated at the will of the driver: Mr. Coleman speaks well of this machine in his Report. He says, "I much regret that I am not able to give a drawing and detailed description of the binder shown by D. M. Osborne and Co., inasmuch as this machine made decidedly the best work at the trial, cutting a considerable area without the wire breaking or a stop of any kind. The apparatus consists of an ordinary harvester frame, with linen travelling-belt and elevator, furnished with teeth. The peculiarity consists in the binding-arm being placed on the near side instead of the end of the binding platform, and having a swan-neck motion, so that, drawing the wire from the spool, it twists it round the grain and forces the straw together whilst the tying takes place underneath. The sheaf is pushed off by the needle as it rises to repeat the motion. The mechanism by which this elegant movement is obtained is both simple and ingenious."

I have been fortunate enough to obtain the following sketches of different elevations of the machine (Figs. 5 and 6, pp. 112 and 113).

The following is a general description of the working parts of the machine, and the mode in which they act, taken from the specification of the patent:—

The invention has reference to a combination of devices for controlling the gathering mechanism, devices for receiving the severed crop and carrying it to the driving-wheel end of the cutting apparatus, and elevating it above the same, and discharging it on a receiving platform outside the wheel. It also has reference to an automatic binding mechanism for gathering the goods, and passing the wire round the same and twisting the ends together to hold the bundles, and discharging the completed bundle from the platform.

It has also reference to an arrangement of devices by which the driver can in his seat adjust the binding mechanism, so that the band will surround the bundle at the proper point, between the butts and heads of the grain.

It also relates to the mechanism for controlling the action of the binder to adapt it to the formation of bundles of uniform size, in grain of varying stoutness. It also relates to the devices for tilting the cutting apparatus for cutting higher or lower, and various details of construction in the several operative parts of the binder, and the gear-shifting mechanism.

In the construction of the harvester a framework (B, C, D) is provided for supporting the operative parts of the machine. This framework is supported on a main driving-wheel (A), on which the major part of the framework is carried, the other end of the framework being supported by a wheel at the end,

Fig. 5.—Front View of Messrs. D. M. Osborne and Co.'s Sheaf-binder.

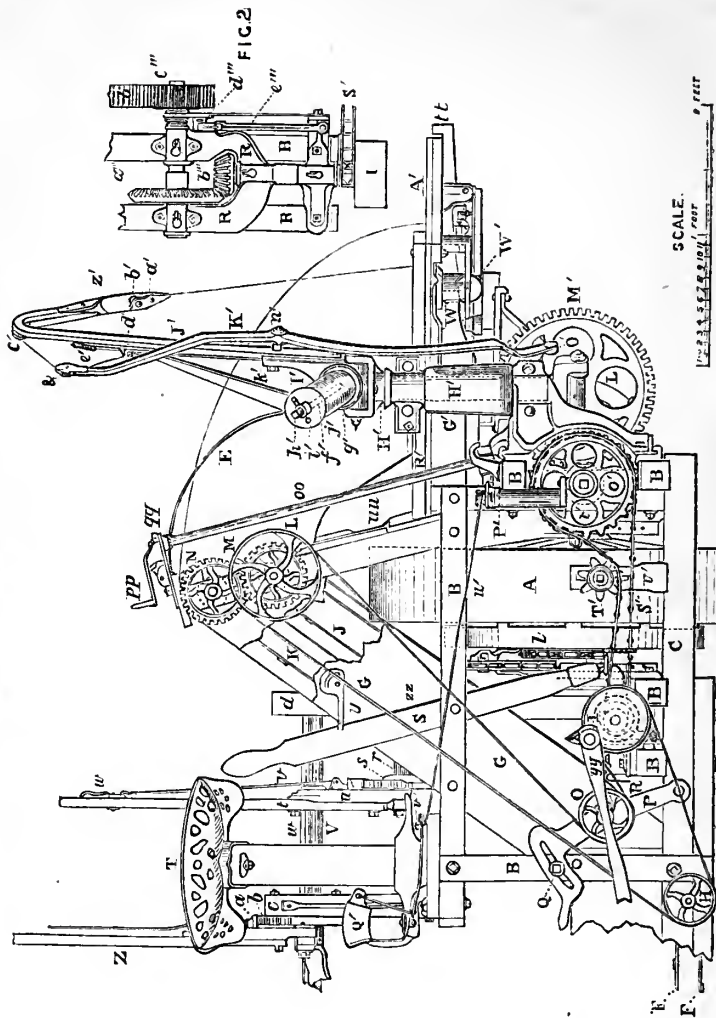

- A. Main driving-wheel.
- B. C. D. Wood framework.
- G. Wing board for holding rollers which elevate endless apron.
- I. Crank-wheel for driving knives and all elevator chains.
- J. Lower elevator canvas.
- K. Upper elevator canvas.
- L. Main sprocket-wheel attached to driving-wheel. Drives reel-chain.
- M. N. Upper and lower gear to turning elevator roller.
- R. Main gear frame. (See Fig. 6.)
- S. Lever for throwing knives in and out of motion.
- V. Reel-shaft.
- Z. Wood lever for raising and lowering reel.
- A'. Table for receiving grain from elevator.
- B'. Main cast frame for binder.

SCALE.  
 1 2 3 4 5 6 7 8 9 10 feet  
 1 2 3 4 5 6 7 8 9 10 feet

Fig. 6.—Side View of Messrs. D. M. Osborne and Co.'s Sheaf-binder.

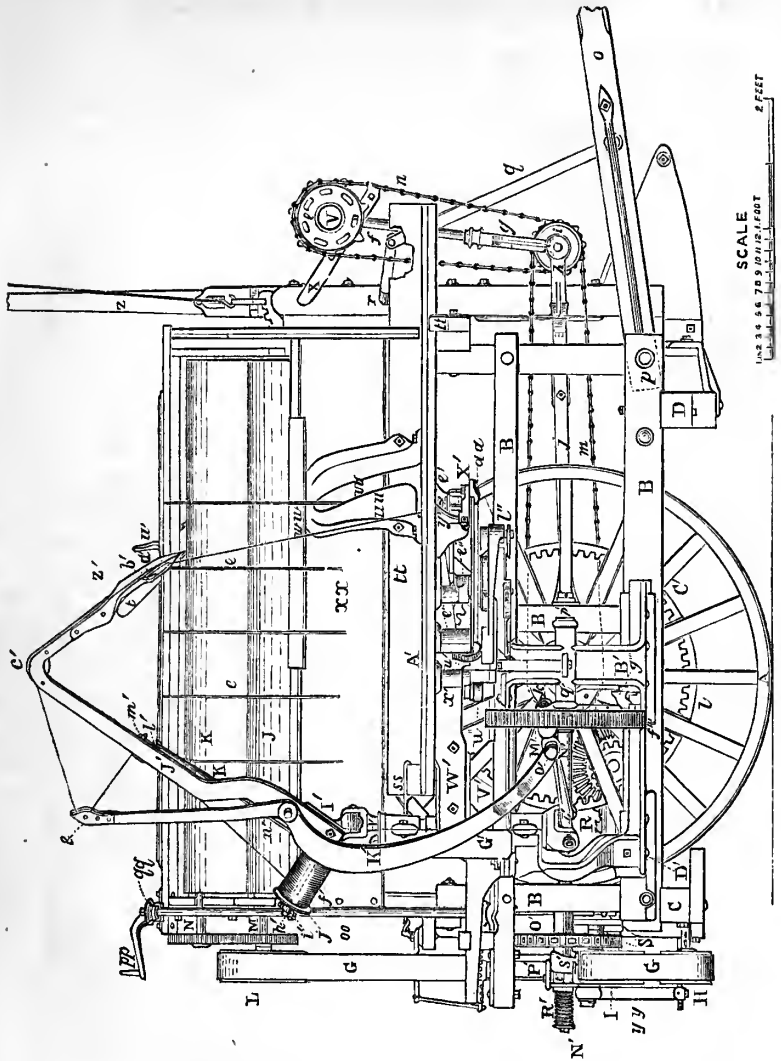

- D. Slide and rest for binder.
- G'. Rock-shaft support.
- H'. Vertical rock-shaft.
- I. End of needle-bar.
- J'. Needle-bar.
- K'. Connecting arm for taking up slack in wire.
- L'. Rocker arm; connects large spur-gear and vertical rock-shaft.
- M'. Large spur-gear for driving binder.
- N'. Driving-shaft for binder, with spur-pinion meshes for driving M'.
- P'. Clutch for holding binder from making sheaves.
- Q. Treadle, controlled by driver to regulate size of sheaves.
- R'. Spring for holding binder-clutch.
- S'. Chain for driving binder.
- W'. Twister arm; carries twister for binding.
- X'. Sector rack; meshes into twister pinion.
- Z'. Needle for needle-arm.

SCALE  
 1 2 3 4 5 6 7 8 9 10 11 12 1 FOOT  
 P. FLET



which is adjustable. The main wheel (A) is also adjustable by its axle being supported in slotted brackets, the radial centre of which is the pinion-shaft, with which the main gear-wheel (*l*) meshes. At the front edge of the framework and at one side of the driving-wheel is the cutting apparatus, which consists of the ordinary slotted fingers and scalloped cutters, to which a reciprocating motion is given by a sway-bar, connected to the centre of the cutter-bar, and projecting rearward across the frame to which it is pivoted near its centre, its rear projecting end being attached, by a connecting rod (*yy*), to a crank (I) which derives its motion from the driving-wheel by a train of gearing connected with it (see Fig. 6). A reel for gathering the crop is supported in front over the cutters, on the projecting arms of a rock shaft (X), which has a lever (Z) and holding devices, by which the driver can elevate or depress the reel at pleasure, and fasten and hold it in its adjusted position. This wheel is driven by a sprocket-wheel (*e*) on its shaft, connected by a chain (*n*) to a double sprocket-wheel (*i*) in a frame which is linked to reel-bearer (*g*) coincident with the centre of the reel axis, and is also linked to the axis of the main wheel axle, so that the chain connecting a sprocket-wheel (*k*) on the hub of the main wheel with double sprocket-wheel will impart motion to it, and through it to the chain connected with the sprocket-wheel on the reel-shaft, the axis of the links being the centre of the double sprocket-wheel; the relation of the chains and sprocket-wheels will not be changed in raising and lowering the reel. To carry the severed crop to its receiving platform (A') outside of the main wheel whilst the cutting apparatus is located on the inside, an endless apron is provided, exceeding somewhat the length of the cutting apparatus behind which it is arranged, and supported on rollers at each end, the rollers being placed at right angles to the cutting apparatus, and supported in suitable bearings. The upper surface of the apron being slightly above the plane of the cutters, motion is imparted to it by a band attached to a pulley (I) on its shaft as will be hereafter described, the motion of the upper surface of the apron being from the outer end of the cutting apparatus towards the driving-wheel. To elevate and carry the crop over the driving-wheel (A), two endless aprons (KK) are provided and arranged on the frame parallel to each other and inclining outwards over the driving-wheel, sufficient space being left for the passage of the crop upwards between them. These aprons are supported on rollers, which have suitable bearings in an inclined framework (G). The lower ends of these aprons are so placed as to receive the crop from the first apron named, and long enough to carry the crop over the driving-wheel and deliver the same on a platform outside of the wheel, the platform being supported in nearly a horizontal position; a break-board attached to the framework under the elevator end of the apron serving to protect the wheel and prevent the accumulating sheaf from being drawn down by the lower apron. These elevating aprons have tight ribs or laths fastened across their surfaces the better to enable them to hold and carry up the grain. The continuous surfaces of the aprons have a motion upwards, which is imparted to them by the shafts (M, N) of the upper roller being geared together; and one of the shafts (M), having a band-wheel (L) around which a belt is passed, also around a band-wheel on the shaft (H) of one of the rollers of the apron behind the cutting apparatus, and also around a pulley on the crank-shaft (I), gets its motion from a train of gearing connecting it with the main driving-wheel. This train of gearing is the same that vibrates the cutters, and consists of the crank-shaft and its pinion (see Fig. 6), a bevel wheel gearing with it, on the shaft of which is a pinion which gears with a gear-wheel (*l*) connected with the main-wheel; this pinion (*b*) has a clutch face (*l'''*) and interlocks a pin put through the end of the bevel-wheel shaft (*e'''*) and can by sliding the same on the shaft be made to lock with, or be disconnected from the same for stopping or starting the connecting-gear or devices. For facility of doing this a shifting lever (S) is arranged in reach of the driver,



and connected by intermediate devices to a fork ( $e'''$ ) which embraces a groove in the hub of the pinion.

To bind the crop into bundles a framework having ways is provided, and is supported in guide-pieces ( $D'$ ) attached to the harvester-frame ( $B$ ) outside of the driving wheel. At one end of this frame, supported in bearings nearly in a vertical position, is a shaft ( $H'$ ) to which is attached an arm ( $W'$ ) which extends from it at right angles, and carries at its outer end a gripping, cutting, holding, and twisting mechanism for the wire of which the band is made. These devices are constructed and arranged as follows:—A double hook with bevelled edges is fastened to a shaft a short distance from its end, and on the end of the same shaft is fastened a similar double hook. The shaft is inserted in a metal frame or block; this block has fastened to its upper face a plate with its edges bevelled the reverse of the first hook, and close to which the first hook revolves, and with it makes a double shearing-hook for cutting off the wire. A finger is pivoted to the block in frame by one of its ends, its other end being bevelled off and of proper width to enter between the two hooks, and rests on the shaft against which it is pressed by a spring, so that in the reverse movement of the twister-shaft it will act as a clearer to remove any fibres or straws that may accumulate around it in twisting the wires. A pinion is fastened to the projecting end of the shaft on the opposite side of the frame or block from the twister. To the side of this block is fastened a piece of steel so as to form an open mortice. This block or frame is bolted to bracket on the end of the arm ( $W'$ ) previously described, with the shaft nearly vertical and the top of the upper hook far enough below the top of end of arm, which is in form of an open box, to give space for length of wire enough to form a twist. Above the twister is fastened a double plate with sufficient space between the plates for a gripping-finger to move. These plates have a vertical V-shaped opening; a finger is pivoted to the plate and twister-frame, so that the projecting end of the finger will swing in between the plates and across the V-shaped opening, so as to clamp or grip the wire. This finger is operated by a connecting-rod pivoted to it, and its other end to a short arm on the under side of the arm ( $W'$ ) that carries the twisting devices. In the open mortice at side of twister-block is inserted a flat slot-bolt, so as to play free. The upper edge of the bolt, a short distance from its end, has a hook-shaped notch cut in it, and this, together with the mortice in which it is inserted, serves to grip and hold the end of the wire while the needle ( $Z'$ ), hereafter to be described, is conveying the wire round the bundle. The other end of this flat bolt is rounded, and has a spring for forcing it into the mortice and holding it there. To release it at the proper time the round end is connected to a short lever which has a friction-roller on it and is worked by a cam hereafter to be described. A sector-rack ( $X'$ ) is pivoted to the under side of the twister-arm ( $W'$ ) so as to gear with the twister-pinion, and has a friction-roller pivoted to its under side, and projects into a cam-shaped groove in a frame which is fastened to the binder-frame, and below the twister-arm, and parallel to the plane in which it oscillates. This groove is of such form that in the oscillations of the twister-arm it will give a swinging movement to the sector-rack ( $X'$ ) at the proper time sufficient for each hook to seize at the proper time its separate wire and separately sever and then twist them together for fastening them after surrounding the bundle. To an ear on this cam-frame is twisted a cam-piece, against which the roller on the lever that works the flat, holding both, strikes at the proper time to open it and release the end of the wire, and sever the wire brought down by the needle-arm. Another pivoted cam is so arranged that the roller on the arm that works the connecting-rod of the gripping-finger will strike it at the proper time to seize the two wires as they surround the bundle, grip and hold them freely so that they may be severed and twisted together: they open and release the twisted ends of the wire for the discharge of the bundle, and hold it open until the proper time comes for again

closing. To the top of the shaft from which the twister-arm ( $W'$ ) projects, is hinged an arm ( $J'$ ) carrying a pointed needle ( $Z'$ ) and a sliding shive to its side ( $m'$ ) connected with a spring ( $e'$ ), and to this sliding shive ( $l'$ ) are fastened the ends of a cord or band ( $n'$ ) long enough to pass round a grooved shive at the bottom ( $g'$ ), and of the wire spool ( $j'$ ) which is placed on a spindle ( $f'$ ) inserted in the hinged end of the needle-arm ( $l'$ ). A connecting-rod ( $K$ ) is pivoted to this needle-arm and is extended downward, and attaches to a lever which is hinged to the lower end of the same shaft to which the needle-arm hinges. The other end of this lever is pivoted radially to a hub on a gear-wheel ( $M'$ ) which is overhung and has a shaft, the axial centre of which corresponds with the hinged point of the other end of the lever ( $L'$ ). The rotation of this wheel by means of the lever ( $L'$ ) hinged to the shaft of twister-arm ( $W'$ ) gives to it an oscillating motion to and fro on that shaft, and at the same time the needle-arm ( $J'$ ) receives an up and down movement by means of the connecting-rod ( $K'$ ) which unites the two. This connecting-rod extends above its point of connection with the needle-arm and has on its end a shive ( $\&$ ). Motion is imparted to the wheel ( $M'$ ) to which the lever ( $L'$ ) is pivoted by a feathered pinion on a grooved shaft ( $N'$ ) arranged parallel to the shaft of the gear-wheel, and driven by a sprocket-wheel and chain ( $O'$ ) connecting it with another sprocket-wheel on the crank-shaft inside of the crank-head ( $I$ ). On the shaft ( $N'$ ) to which the first sprocket-wheel is connected is also a clutch ( $P'$ ) having teeth, which will lock with teeth on the sprocket-wheel, and this clutch is connected by levers and links to a treadle ( $Q'$ ) near the driver's seat ( $T$ ), so that he can disconnect the clutch from the sprocket-wheel at pleasure for stopping the binder, and by releasing his foot from the treadle, a spring ( $R'$ ) on the shaft forces the clutch towards and locks it with the sprocket-wheel, and its shaft revolves with it operating the binding mechanism. In threading the wire to the needle it is passed first from the spool ( $j'$ ) around the sliding shive ( $l'$ ), then around the shive ( $\&$ ) on the top of the connecting-rod ( $K'$ ) of the needle-arm, then to the shive at the bend ( $e'$ ) of needle-arm, and down the needle, and through between the shives near its point, and then to the holding-jaw ( $y'$ ) below the twister. The operating of the binder is as follows:—With the wire arranged as stated, and the needle-arm ( $J'$ ) standing at the highest, and moving outwards from the delivery end of the elevator aprons ( $KK$ ), the harvesting and elevating mechanism previously put in motion, and sufficient material having been cut and elevated for a bundle, the driver releases his foot from the treadle ( $Q'$ ), and the binder is set in motion. The rotations of the wheel ( $M'$ ) to which the end of the lever ( $L'$ ) is pivoted carries around with it the pivoted end of the lever; its hinged end being connected to the shaft ( $H'$ ) which supports the twister-arm ( $W'$ ), and its devices and the end of the wire that is in its holding-jaw. The upper end of the wire, which is connected to the needle ( $Z'$ ) of the needle-arm ( $J'$ ), which is hinged to the same shaft, is also carried forward, pressing the wire against the accumulated sheaf. As the needle ( $Z'$ ) and twister-arm ( $W'$ ) advance towards the breast-board ( $XX$ ) below the delivery end of the elevating apron ( $KK$ ), the needle-arm ( $J'$ ) begins to descend, the point of the needle passing down back of the sheaf, and between the falling straws, separating them and surrounding the sheaf with the wire, the twister-hook rotating partially, so as to seize the strand of wire in the holding-jaw; and after the other strand of the wire has been carried down below the twister, the gripping-finger comes into action, and closes upon both wires between the twister and the bundle. The second hook of the twister is rotated so as to sever the second wire, and the first wire is released from the holding-jaw, and it secures and holds the second wire, the first wire being severed by one of the cutting-hooks, followed by the severing of the other wire by the other cutting-hook, the ends of the wires being in the separate hooks as the arm moves outward, the rotating of the hooks, by the action of the sector-rack ( $X$ ), twists the ends

of the wire together above the hook. When the twist is completed the clamping-finger is released, and as the arm starts on its return again the finger is thrown entirely open and the bundle is free. This operation will now continue to be repeated once in 10 or 15 feet, according to the speed at which the binder is geared. When from the thinness of the crop an insufficient quantity has accumulated, by means of the treadle (Q) the driver disconnects the binder from the harvester devices, and skirts it again when sufficient has accumulated, repeating the operation as frequently as the condition of the crop may require. He can also elevate and depress the reel at pleasure, as may be required by the condition of the crop, and can move the binder laterally by means of levers (*pp*) and shaft (*oo*), so as to place the band at the proper point between the butt and head of the grain, and can also disconnect the operative parts of the whole machine from the driving-wheel at pleasure.

To attempt to give a full and detailed description of the mechanism, as laid down in the specification of the patent, would occupy more space than I have at my disposal for the whole Report. I trust, therefore, that the foregoing condensed description will suffice to give a clear idea of the principle and construction of this ingenious machine.

#### THE TRIALS AT AIGBURTH.

The proposed trial of sheaf-binders for the gold medal offered by the Royal Agricultural Society excited general interest throughout the country. The desirability of still further diminishing the cost of harvest-labour has been impressing itself upon the agricultural mind for some time. To the exhibition at Liverpool of reapers capable of sheafing and tying up the grain as they cut it, a special interest was therefore attached. The Royal Agricultural Society, anticipating popular sentiment, fulfilled its truest functions when it offered these prizes, and completed a great and useful work by carrying out a series of trials to test the practical efficiency of the several implements entered as capable of accomplishing the object desired. The fact of an entry of eight machines at the Show, led to the opinion that we were approaching the time when the sheafing and tying of grain would be done by mechanical instead of manual agency. The opinion has been fully justified by the results of the trials.

The unripe condition of the cereal crops rendered it impossible to carry out the programme at the time of the Show; and the Stewards, after inspecting the crops that were submitted to them by the local committee, adjourned the trials to the 14th of August, a fixture changed to the 16th of August. A week's postponement would have been a wiser step under the circumstances of the bad ripening weather that characterised the season.

The locality fixed for the trials was Aigburth, a village three miles distant from Liverpool. For nearly all the way by two

routes the frontages are occupied by modern villas, and the grand plain of rich agricultural land in fields upwards of twenty acres in size, does not come in view until a sudden turn of the road is reached.

At this time the fields were full of grain-crop, a small portion of which only was in stook, and the large flats of oats and wheat caught the eye as the site of the trials. Grand green crops are scattered over the plain, while but few meadows were to be seen, arable culture with the Liverpool market at hand being the more profitable agriculture. The selected trial-ground was on the farm of Mr. W. Scotson, who occupies 450 acres, and who this year received a Medal from the Local Committee for the third best-managed farm, as described by Mr. Shirriff in the last number of the 'Journal.'

The state of the weather at this time was a matter of considerable anxiety, both to the Judges and the competitors. Much rain had fallen during the night, and some showers during the early morning, and at nine o'clock the sky was clouded and the atmosphere soft and murky. At ten o'clock, however, a breeze arose which to some extent dispelled the clouds, and the possibility of the trials proceeding, should no further showers intervene, became hopeful. At this time the straw of the crops was quite wet, and the ground soft and sticky. At eleven o'clock a great change had taken place, and the wheat, though not quite dry, was considered capable of being operated upon, at least in the preliminary trials which it was necessary to give in order to enable the competitors to get their machines in perfect order for the test-trials, by which time it was thought that the trial-plots would be quite fit for cutting. The field of wheat was about 40 acres in extent, and in the shape of a parallelogram, alongside of which was a narrow strip of 8 or 10 acres of permanent grass, which formed a convenient entrance-ground for the competing machines, and requisite space for the spectators. It also gave access to the actual trial-ground at any point in the whole length of the field during the whole progress of the trials. A portion from each end of the field having been cut off from the allotted trial-ground, the central or main part of the field was reserved for the operations of the Society. Taking the ends of the parallelogram to represent north and south, the trial-plot of wheat was divided into three separate portions of equal size by parallel lines running from east to west. The uppermost portion, or most northern one of these three divisions, was next subdivided into exact half acres by parallel roadways running from north to south, these minor roadways being only one swathe in width. The sectional roadways were made of sufficient width to allow the machines to turn conveniently without being interfered with by the rank-and-file of the spectators, who fringed the plots of corn in these

wide alleys, despite the exertions of the police, to whom I must bear my most willing acknowledgment of the admirable manner in which they kept order. In no single instance was there a crush at particular points to get near the machines, or the slightest obstacle offered to the comfortable performance of their duties by the Judges. As the line of competitors advanced, it was found that there were only three in the field, and that these were the American machines belonging to McCormick, D. M. Osborne, and Walter A. Wood, which I have already described.

The above is the order of entry in the Catalogue, but in all the competitive trials they drew lots for their places. Having waited for the weather so long, on the order being given to start not a moment's delay took place. No. 1, McCormick, drew No. 3 as his trial-plot; No. 2, D. M. Osborne, drew plot No. 1; and No. 3, Walter A. Wood, drew plot No. 2. The preliminary trial just alluded to consisted in sending the whole of the machines round another plot not required for the main trials. The crop upon this was heavier than that of the numbered plots, was considerably twisted, and was consequently exceptionally damp. The crop here was of about 33 bushels per acre, while that on the measured plots varied from 24 to 27 bushels per acre. Of the preliminary work I may remark, that it exhibited the incapacity of all the machines, as will be seen from further details, to cut heavy corn when laid down, especially if the same be unripe and wet; but as heavy corn is never cut in practice either unripe or wet, this incapacity of the machines to contend with such circumstances did not diminish the interest in the further trials, which the more favourable aspect of the weather now rendered it likely would take place. McCormick first commenced to go round the plot. The noticeable features in this machine, when "stripped for fight," were the strength and the weight of the implement; the great number of shafts, pinions, and wheels indicating a heavy draught, and the tact with which the clever conductor had striven to reduce this objection in practice, by providing a yoke of team-horses of the most wonderful shape and size. He did not, however, get once round the tract before he was in difficulties. Where the corn was heavy the heads fell over the board, and the supply of cut grain was not continuous; and, when it was continuous, it stuck in the sheaf-binder, the power to move it out of the way of the succeeding sheaf being inadequate, and there being not only an extra weight in each sheaf, but the straw-fibres had no elasticity. Three or four bound sheaves consequently became entangled as soon as ever the machine cut its full width and at its normal pace. Although the strength of the horses appeared to be inexhaustible, their tempers were unable to bear the strain put upon them by the frequent stoppages of the machine. With a



pair of fresh horses McCormick did better, especially when supplied with an extra man to take off the sheaves and to prevent them from becoming entangled with each other, and when the laid portions were taken up by scythe-men.

Walter A. Wood's representative next came forward and speedily overtook his competitor, with a pair of the lightest horses I have ever seen in harness, except in an Irish car in the city of Cork, or in a London milk-cart. What the colossal horses of McCormick could not accomplish, it seemed ridiculous to expect from a pair of ponies, not even good thoroughbred weeds. This idea so impressed me, that I could not resist asking the polished conductor if he would not change his team in like manner as McCormick had done. With that *naïveté* which the men of the Eastern States of America know how to assume, he replied, "I think, Sir, I had better do as he has done—give them a trial." The look accompanying this told me at once that my pity was misplaced.

When I saw the machine begin work, I was at once satisfied of my own incompetence to give advice to the driver on the conduct of his machine. Light and elegant in construction, W. A. Wood's machine catches the eye immediately; in this case it startled public opinion by the superior manner in which it cut and bound the heavy damp corn, when assisted by a man to remove the sheaves and to take up the twisted portions. The delivery power of this machine is considerable, and indeed the question will have to be discussed as to whether it may not be diminished with advantage. Still, in this case, it could not throw off sheaves weighing 20 lbs., instead of 7 or 10 lbs., always in sufficient time to prevent the outside sheaf being caught by the binding wire of the succeeding sheaf, and thus forming a nucleus for a lump which speedily stopped the binding gear.

D. M. Osborne's machine, the last of the trio, came forward with as many friends as either of its opponents. It is an original invention, perfect in most of its points, and moderate in its size and weight. It went round with comparatively few stoppages, and excelled McCormick and equalled Wood in the quality of its work. Its delivery power, acting with a crane-neck motion, is not as powerful as Wood's swan-neck motion, both of which carried the wires round the bundles. The crane-neck obtains its initiatory power from the machinery fixed on the left side of the machine, while that of Mr. Wood's derives its motion from a central shaft. There is something taking to the eye of the practical man in the new movement of D. M. Osborne, which will excite discussion; but this I deem futile. His own practical tests during the present year will show its capabilities fully.

Considering that no machines ever were constructed to cut



heavy wheat in a green state, much less to sheaf it and bind it, I defer any remarks on the special features of each machine in work, except in regard to the question of draught, in which McCormick is so palpably deficient, until I come to treat separately of the individual trials.

During the foregoing runs, the weather continued fine, and the trial plots had become in a fair condition for cutting when the first machine commenced operations on the allotted half-acre. No. 1, McCormick, began in plot No. 2.

This plot was, if anything, the lightest crop, being not more than 25 bushels per acre, and was in every respect, except a slight dampness, favourable for cutting. The machine started at 20 minutes before 12, and finished the plot at 12.30 P.M. There were two or three breakages of wire, and many stoppages. These stoppages absorbed  $28\frac{1}{2}$  minutes of the whole time, and were caused chiefly by the entanglement of the sheaf and the imperfect manner in which the cut corn was carried on to the platform. More than half the time, it thus appears, was consumed by these stoppages. The horse-power consumed seemed excessive, and the stubble was left longer than necessary, being about 8 inches in length. The average cut of the machine was 4 feet 10 inches. This trial was most satisfactory, as showing where the practical difficulty laid, and the necessity for further improvement in the mechanical construction of the machine in particular parts. Had there been no stoppages the half-acre would have been cut, sheaved, and tied in a little over 20 minutes—a pace quite satisfactory and capable of effecting a fair day's work. It must be noted, however, that, as in the preliminary trial, it was found necessary to allow an extra hand to remove the sheaves off the delivery-board as soon as they were tied. This, however, did not prevent the clogging at the knife, owing to the want of a proper dividing-rod and appliances to lift the straw on to the platform, from which it has to be raised by the canvas elevator to the tying apparatus. Owing to this circumstance the sheaves were not by any means even in size, or as straight in the straw as they might have been. The sheaf-delivery of this machine was evidently imperfect, even had the straw been quite free from damp it would not have quitted the sheaves. In this case, however, though the machine had the advantage of doing its work upon a light crop of standing corn at a period of the day as favourable as possible for the work, still it had a difficulty to contend with in the immature state of the crop, a large proportion of the straw of which was full of sap and contained many "greens."

No. 2, W. A. Wood's machine, commenced work on plot 3, at 12.30. This plot was an average standing crop of 26 bushels per acre, and had become by this time in good condition for

cutting, except as regards a slight dampness at the bottom of the corn. The machine worked at a brisk pace, and made good progress with its work for fully 15 minutes, when a slight stoppage occurred, in consequence of "greens" getting wrapped round the rollers which move the endless web. The whole work was completed with only four stoppages, which absorbed  $8\frac{1}{2}$  minutes, the whole time taken being 33 minutes, leaving  $24\frac{1}{2}$  minutes as the time actually employed in the process of cutting. The sheaves made were particularly neat and uniform, while the tying in this, as in the previous instance, was quite perfect, not a single loose sheaf being made by either. The attendant to assist in the delivery was again allowed; but this, I believe, was only rendered necessary by the heavy weight of the sheaves. The power which this machine has of propelling and expelling the sheaves from the delivery-board is so great, that had the sheaves been of the ordinary weight and the straw dry and brittle, I believe that no manual assistance would have been required. The manner in which it shoots forth the sheaf, as from a catapult, after it has been embraced by the "swan-neck," is so effective, that it is only on the score of excessive power and of overdoing the work that any objection can be made. The liability to shake out corn arising from the propulsive power is a question which I need not discuss in this place, under the existing circumstances, by which a loss of  $8\frac{1}{2}$  minutes was chiefly necessitated, for I hold that the main cause of the delays on this occasion are to be attributed to those existing circumstances rather than to imperfect mechanical design or construction. But one breakage of wire occurred, and caused a delay of two minutes, which must not be debited to the machine itself. The stubble left was an inch shorter than that left by McCormick's machine, while the absolute absence of ears in the tail of the machine and of straggling straws on the ground was noticeable, and elicited universal admiration. The horses moved at a good pace with considerable ease, the draught evidently not being excessive; but this point was afterwards settled by the dynamometer.

D. M. Osborne's "Gordon Reaper" next commenced on plot 1, half an acre in extent, and of precisely the same length and breadth as the two preceding lots. On this plot the wheat was very fine, and one portion of it was considerably more bulky than any on either of the other two, the remaining portion being three or four bushels per acre higher. The crop stood well and the ground now was nearly dry, while the straw was in better condition than it had been at any previous time during the day. The land being of a sticky character, the drier state of the surface had considerable effect in lessening the apparent draught. The machine began cutting at 1.17 P.M., and went on progressing well, with

two slight stoppages, till 1.30, when the clouds, which had been gathering round for some time, burst forth with a sudden down-pour of rain, which drove every one from the field under shelter. No further time-work could therefore be done in this case, as, when the clouds passed away and a brisk wind shook the straw so as to make it comparatively dry, the soil was so wet and the state of the straw so deteriorated for cutting, that the conditions of the trial became changed. It was therefore considered advisable to take as a test the portion cut during the short period of time that the machine had worked upon the crop in a similar condition to that in which the other machines had worked previously, rather than complete the cutting of the plot after the rain, as such work would evidently afford no real measure of comparison of the time that the machine would have finished its work in, had the weather remained fair and the crops equally favourable for the process. The portion cut before the rain came on afforded ample space to show the excellent character of the work completed by the machine, the stubble being uniformly short, the sheaves even and straight in the straw, and the tying perfect. There was one breakage of wire in the thirteen minutes that the machine was actually cutting. I have spoken previously of the ingenious and clever crane-neck, cheaper as an original mechanism, likely to become a most valuable motion in machines of this character, although it was unable on this occasion to quit the newly tied sheaf before the succeeding one came. The usual manual assistance, as in the other two previous cases, was rendered. I must, however, notice, as a condition common to all, that the total absence of brittleness and buoyancy in the straw, arising from its imperfect ripeness and moist condition, rendered the movement of such a material through the machinery a matter of considerable difficulty, the machinery having to work against a dead weight—a thing certainly never contemplated by the inventor of any of the machines.

On the stoppage of the test-trials by rain, the prospect of any further work being done in the field looked hopeless. In a short time, however, a breeze arose and the clouds were carried away with great rapidity, leaving us in the presence of the sun, none the less bright for the murky atmosphere in which he had been recently enveloped, and later on in the afternoon we had a few hours of real harvest weather. That the Judges had not left the field was a matter of congratulation, and it was determined to commence the dynamometer test-trials, as soon as the wet was shaken out of the straw, and as soon as Mr. W. E. Rich, C.E., was ready to commence operations. The lowest portion of the allotted plot of wheat was reserved for these trials. The crop here was very fine and not broken down at

all. The straw was long, too long certainly for the comfortable working of the machines. The size of the plot, in shape of a parallelogram, was about 6 acres, and all the machines were sent round it as a "preliminary canter," in order that the exhibitors might have their respective machines in suitable trim for the test work. After this, McCormick was the first summoned to action, and the dynamometer was attached to it. It made three circuits, during which time Mr. W. E. Rich, standing on that marvellous piece of mechanism which so infallibly records the draught-power absorbed by any machine in completing a piece of work, made the observations furnishing the *data* from which the valuable table subjoined (p. 125) is collated. The stoppages of McCormick were few and no breakages of wire occurred. It cut well, though the stubble was left rather long, and I think gained credit with observers for its work in comparison with its performance in the morning.

W. A. Wood's was treated in a precisely similar manner, and it pleased the spectators by the ease with which it cut and placed the straw in the sheaf. Its delivery was of course assisted as in the previous case, though it required that assistance less than either McCormick's or Osborne's machine. The stubble it left was much admired, being perfectly level, and considerably shorter than that left by McCormick. The straw was too long for his platform, a point in which McCormick was somewhat superior.

Third and last Osborne came smilingly to the front after his ill-fortune in the previous trial; but if unlucky in his time-test, now he had every reason to congratulate himself on the circumstances under which he came to the dynamometer-test. Under the influence of the breeze the straw had now become in a better condition than it had been during any other period of the day, while the bright sunshine gave it a crispness that made it pass over the gathering-board and through the sheafing apparatus with a degree of lightness not previously shown in the other trials. In this case the stoppages and the breakages were *nil*, which was the more remarkable, as the straw was evidently longer than the machine was calculated to deal with, and there was a tendency of the cut grain to hang over the reception-board, and on the delivery platform to entangle the ears in the wheels on the left side of the machine which regulated the movement of the crane-neck reaper. Special care prevented any mischief taking place from this cause, though the extreme length of the wheat was a disadvantage to the machine, which its able conductor had to guard against. The stubble was left beautifully level, if not quite as short as Walter A. Wood's. The sheaves were well-made and uniform, though considerably smaller than those made either by Wood or

McCormick. The allotted rounds having been completed, several special trips were made to satisfy the inquiries of Mr. Rich on particular points.

The measurements of the lengths of the stubble were taken with the greatest care and accuracy by Mr. Rich, and the sheaves were weighed and counted by Mr. Elphick, the Assistant Steward. The average width of cut made by each machine was ascertained in a most ingenious mode; the activity and skill shown by Mr. Robson, a pupil of Mr. Anderson's, was most noticeable, the work requiring both head, hands, and legs, and entailing no slight tax on physical energies of a high order. The following table of the dynamometer results has been furnished by Messrs. Eastons and Anderson, the Society's Consulting Engineers.

DYNAMOMETER TRIALS with SHEAF BINDERS at AIGBURTH, LIVERPOOL,  
August 17, 1877, on WHEAT.

Name of Exhibitor in Order of Trial.	C. H. McCormick.	Walter A. Wood.	D. M. Osborne and Co.	Averages.
Price .. .. .	£ 60	£ 60	£ 50	
Width of Cut—With lay .. ..	Inches. 58	Inches. 50	Inches. 55·2	
„ Against lay .. ..	52	61	62	
„ Average .. ..	55	55·5	58·6	
Height of Stubble .. .. .	8	6	7	
Side draught—With lay .. ..	lbs. 35	lbs. 15	lbs. 35	
„ Against lay .. ..	25	25	37·5	
Mean draught (in lbs.) With lay ..	464	468	486	
„ „ Against lay ..	471	460	418	
„ „ Average ..	467·5	464	452	461
Mean draught (in lbs.) per inch-width of cut {				
„ With lay ..	8	9·36	8·85	
„ Against lay ..	9·06	7·54	6·75	
„ Average ..	8·53	8·45	7·8	8·26
Mean speed in miles per hour ..	3·15	3·00	3·22	3·12
Width of knife .. .. .	Inches. 5·6	Inches. 4·0	Inches. 5·6	
Number of sheaves cut .. .. .	17	21	{ *18 } 34	
			{ 16 }	
Total weight of sheaves .. .. .	lbs. 265	lbs. 371	{ 250 } 423	
			{ 173 }	
Mean weight of each sheaf .. ..	15·6	17·7	{ 13·9 } 12·4	
			{ 10·8 }	
Foot-lbs. of work per lb. of corn cut, or height to which corn must be raised to represent work done in cutting and binding it )	423·5	420·7	468	

\* Sheaves were kept separate in the up and down runs.



After the dynamometer and other tests of machinery, the Judges have usually summed up and tabulated the points of merit of the respective competitors, the position in the scale under each point having been estimated at a certain number, perfection being represented by a fixed quantity. In this case the several heads under which merit was defined were (1), weight and draught; (2), efficiency of operations and simplicity of mechanism; (3), quality of material and workmanship; (4), clearing horse-track; (5), price. On this occasion, however, the Judges, after mature deliberation, determined to issue no further comparative estimates on the specific details of the distinctive merits of each than are supplied by the table. A careful analysis of the figures will show that in point of simplicity of mechanism and efficiency of operation W. A. Wood stands well in front of both his competitors, who seemed to be about equal, although these deductions from facts I should certainly modify by placing D. M. Osborne before C. H. McCormick in both points. In weight and draught Osborne shows a slight advantage over W. A. Wood, and a considerable one over McCormick; the advantage, however, is so small that it is not appreciable during actual work by an observer. All being American machines, it might be presumed that the quality of material and workmanship in each would be pretty much the same, but inspection shows that in this point W. A. Wood has the advantage over both his opponents. In cutting close up to the standing corn and in clearance of the stubble his machine is perfect, not a single ear or straw being scattered in an acre. McCormick and Osborne are but in the slightest degree inferior in this particular, their work being, practically speaking, if not perfection, as good as need be. I am convinced that this point of merit which attaches to a good sheaf-binder is one which is not at present at all estimated properly by practical men. It will in the course of another year's experience be considered one of the greatest advantages which the present system presents, and will put the sheaf-binding reaper in a distinct category from even the best self- or manual-delivery reaping-machine. The gain will be first in the saving of the expenses of raking, which operation will be quite unnecessary over so clean a stubble with sheaves so securely bound; and, secondly, in the gain of two bushels per acre in the sheaf-corn, which otherwise in all the ordinary processes now employed, whether by scythe or machines, is gathered into "rakings," and very frequently entirely spoiled, but in all instances is of inferior quality to the bulk of the crop. The cost of McCormick's machine and that of W. A. Wood's is 60*l.* each, whilst the price of Osborne's is 50*l.*, a slight advantage which will disappear



when the maker brings forward a machine with the necessary alterations for adapting it to our English crops.

The completion of the first day's work was much more satisfactory than the commencement, when the clouds hung over us with a threatening curtain. Several slight showers, also, in the early part of the day were most teasing; but the Judges acted judiciously in their arrangement of the proceedings under the existing circumstances; and the Stewards, with marvellous patience and activity, devoted themselves to the necessary preparations for a work which could not fail to be discouraging as it appeared to be likely to be a futile one, viz., that of harvesting in wet weather. The change to fine weather at the late period of the day falsified our fears, and enabled the trials to be so far completed that the Judges decided that no more cutting should take place in the wheat-field, and that the machines should commence operations upon oats the next morning.

The trials on the 18th took place on oats on another part of the same farm. The field was about 30 acres in size, and, on the whole, a magnificent crop, one-half of which was fully 9 quarters per acre; of the remaining half there was a small portion rather light, with rather shorter straw, which I estimated at  $5\frac{1}{2}$  quarters per acre. The remainder of this moiety of the field I estimated as likely to produce 7 quarters per acre. The two sections of the field were divided by a broad space which had been cleared of sheaves; on the east side, and also on the north and south sides. The whole of the grain on the west side, between the portions spoken of and the fence, was already cut and stooked. The whole of the piece prepared for the operation of the self-binding reaper by the open spaces surrounding was next subdivided into plots of half an acre by a swathe running from east to west. The top lot, No. 1, was of a much heavier character than any of the other pieces, and contained a good deal of entangled and twisted corn. The crop throughout the field was uniformly ripe, with straw especially bright and brittle, the conditions, therefore, being much more favourable for the sheaf-binders than they were in the previous day. This portion was selected for a preliminary operation of all the machines, and McCormick went first. McCormick only succeeded in getting twice round, and this with several stoppages. Where the crop was heavy he could not get it up, but where it was laid he came to a dead-lock and retired.

Walter A. Wood came next, and made three circuits in the heavy corn, with manual assistance at the delivery-board, as well as at the point where the cut-corn has to be lifted on the lower table, and to pass up the incline on the sheafing-platform. The roller and sheet acted very well, and the speed of delivery

was considerable, while the cutting process was accomplished in a most successful manner. The amount of manual help required, although it effected the work that was to be completed, and thus showed the value of the machine, even under difficult circumstances with proper management, was not such as could be taken into account of a trial where the object was to produce an efficient reaper and sheaf-binder; still it determined the relative merits of the several machines under the circumstances, but required an excessive amount of attention and skill, as well as two extra attendants to keep it going. At this time McCormick had been cutting away at the next plot, which the Judges had permitted him to enter upon, owing to the bad start which he had made in his previous attempt.

This crop was standing, and admirably adapted for cutting by reaper, and upon it he certainly made very good work as regards everything, except length of stubble. Once or twice the wire broke, but the stoppages were few and unimportant. Extra assistance, however, was not able to be done without.

For the test-trial it now fell to McCormick's lot to have the good fortune to be fixed on the very lightest piece of corn in the field, with about  $5\frac{1}{2}$  quarters per acre, and, as I have previously stated, with every straw as yellow as a guinea and as stiff as a reed. In the half acre allotted to McCormick the work was done in rather better style, as the corn was lighter, and the machine managed to quit the sheaves, which were made very small, without any assistance. Properly speaking, however, the machine has no delivery, there being no motion given to the sheaf after it is bound, except what it derives from the push of the succeeding sheaf, when it simply drops off the platform, two frequently falling together under the best of circumstances. The time the work was done in was satisfactory, as the machine cut at a rapid pace. Though a full width was not taken, this, of course, lessened the bulk on the platform and on the sheafing-board. The time of completing the half-acre was  $34\frac{1}{2}$  minutes.

W. A. Wood's machine had also a very favourable plot for cutting; it was only very slightly larger in bulk of straw than that done by McCormick. With this crop it required no extra assistance at the delivery, the sheaf being impelled three or four yards from the standing corn with great speed, exactly in the same manner as a knur from a spell. Whether this powerful action will shake out any grain when the corn is very ripe is a moot point which I leave. Anyhow, Mr. Wood may afford to reduce the power of the spring to some extent, and still leave the machine quite efficient in ripe corn. There is no use in retaining this excessive "throw," inasmuch as it was seen in the wheat-trials to be incapable of dealing with corn in a very raw

condition. There were no stoppages to speak of beyond the tying of a wire, and the work was completed in  $35\frac{1}{2}$  minutes. The sheaves were more proportionate than those made by the previous machine, inasmuch as the stubble was cut much shorter and the straw left longer in the sheaf. This saving of straw at the present time, when the price is so high, is an important point in estimating the claims of a self-binding reaper to the notice of a practical farmer. I need not enter into any calculations as to the quantity of straw gained per acre by the close cut of W. A. Wood's machine, the stubble being one inch shorter than either of its two opponents, and two inches shorter in many instances than that left by McCormick's machine. The binding process was quite perfect, and the sheaves when put into stook would have shown to advantage against any work done by the sickle, and those portions in the same field which had been cut by the scythe looked very slovenly in comparison with Wood's work.

D. M. Osborne was less fortunate than his neighbours, and was put to work in another portion of the field, in which the crop was certainly heavier than those cut in the foregoing trials. Nor was the straw all with one inclination: still the work was completed in fair time, including a few stoppages due to the clogging of the cutting-knife by twisted grain. Sheafing and tying, as in all other instances with this machine, were perfectly accomplished, and the stubble left was an average between that of the other two. Thirty-seven minutes were absorbed in the work, of which  $4\frac{1}{2}$  minutes were wasted in stoppages.

No further trials or dynamometer tests being made, I have only to refer to the results patent in the trial-field to the ordinary observer. The special points of merit and other individual features in each were similar to those exhibited by the work on the wheat crop on the previous day. All the machines failed in showing themselves capable of dealing with a heavy crop without extra manual assistance beyond that of the driver and conductor, or indeed with a crop of the ordinary length and bulk of straw grown in this country. The delivery, which was defective in Wood's implement, was bad in Osborne's, and worse in McCormick's. The cutting powers in the oats were precisely similar to those exhibited in the wheat trials, and quite equal to those possessed by an ordinary reaper.

The deficiency in collecting or gathering the heavy corn, as soon as it was cut, upon the lower table, from whence it ascends up the inclined plane to the sheafing platform, was very marked in Osborne's and McCormick's machines. Both in wheat and oats, the delivery of the sheaves from Wood's machine was superior to that of both his competitors. The swan-neck motion

and the tying mechanism in the same machine are not only original in conception and ingenious in device, but the most effective of the three competing implements. I see no more reason why it should not be constructed to gather and bind a 4-quarters English wheat-crop than that it should cut one of 3 quarters, which it really can do now in a workmanlike manner. Osborne's binder ties equally well, and his crane-neck motion is quite original; thus while the tying is as good as possible, the movement of the sheaf off the delivery-platform is the difficulty now in force. McCormick's tying is equally perfect, and the result of perhaps the most ingenious combination of wheels, cams, and pinions ever put together in a machine to be worked on the rough land and under the guidance of a farmer's man. In the present trials the inventors lost nothing on this score, but I am afraid that agriculture can scarcely claim the credit of having produced any of those energetic, powerful, and clever men who conducted the several machines in these trials. I cannot, speaking from an observer's point of view, do justice to the manner in which this complicated machinery worked in practice, the sheafing and tying being as good as need be, and the failure being solely due to the contracted space in which the retiring sheaf had to move, and to the absence of a propelling power to start its motion.

To each of the machines attaches the special merit of being able to cut a crop of corn, even now, if assisted by two extra men, of heavy bulk, in a shorter time than any ordinary reaping-machine, and in a better manner,—arising from the absolute absence of waste from scattered ears in the horse-track. This, of course, is a saving supplementary to that arising from the the binding and the sheafing of the grain.

On three points, indeed, for the self-binding reaper, as even now presented in the field, the specific merit of this economy may be claimed, as well as the entire success of all the inventions in the sheafing and tying processes. The invention of the sewing-machine was deemed a marvellous instance of mechanical genius, but it is nothing to compare with the inventions which have just been tested. In the one case the material to be operated upon is fixed, and the thread is always in the same position; whilst in the case of the self-binding reaper, the material consists of distinct kinds of corn, of every variety of bulk, to be operated upon under different circumstances of weather. These various kinds of corn must be cut and conveyed to a table, and thence, by revolving wheels, elevated 5 feet high, and passed into the jaws of an iron piece of mechanism of the most *outré* form, which grasps it, while elbows, fingers, knuckles, and thumbs manipulate it so that, without a sensible delay, it passes off the machine to the ground, and is found to be a perfect

sheaf with the straws as straight as the arrows in the quiver, and with the heads uniformly at one end. The tying process is so perfect, that in two days' work I never discovered a knot that had slipped, the wire, in fact, breaking on the application of severe tension in any part but in the knot.

One feature common to all the machines is the tying with wire; and it is proper to note here, that when great interest had been excited throughout the country at the announcement that American manufacturers of agricultural implements, at their Philadelphia Exhibition, had exhibited machines capable of doing the cutting work of an ordinary reaper, and at the same time completing the operation by sheafing and binding the straw,—the competition for the Royal Agricultural Society of England's Gold Medal was looked forward to with great interest, owing to the announcement of several entries of English machines which were said to be much superior in this point of tying by using other substances than wire for that purpose. I must confess to having held the strongest opinion antagonistic to the use of wire as a binding material, and I have every reason to believe that the impressions of the Judges were somewhat in the same direction. A minute examination of the American wire-binders and the two English machines which used ordinary string for that purpose—and with it the models exhibited in the Yard certainly could tie securely a sheaf—served to show me that my opinions were to a considerable extent based on prejudice, and the public trials fully converted me to the opinion that the practical objection to wire was groundless. Taking into account the small cost of the wire, 1s. per acre, the effectiveness of the mode, and the saleability of the wire at half price, after use, I am induced to think that it will be necessary to make very particular investigation into the capabilities of other substances as tying materials before assigning to wire any disadvantage for that purpose. With ordinary care, which ought to be a thing natural to people engaged in the working of complicated machinery, there is only a very slight risk of bits of wire getting mixed with the straw used as fodder or bedding. If the risk of this were great, considering the large number of animals that eat straw in the winter in this country, the objection to it would be fatal; but the risk, which I have said is ordinarily trifling, has become reduced to the minimum point by the introduction of a new patented clipper or scissors, by which the wire is severed and retained in the jaws of the machine until it is removed by the hand, for the purpose of being put into a basket or box provided for that special purpose. A piece of wire, therefore, cannot get amongst the straw, except by design, or with the knowledge of the attendant, and such a circumstance is an act of volition of that person as



distinct as the taking of a lucifer match out of his pocket and throwing it amongst the straw would be.

Fig. 7.—*Sketch of W. A. Wood's Wire-band Cutting Nippers.\**

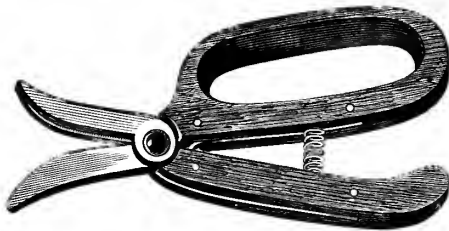

The following description appeared in the 'Farmer' of March 11th :—

"The straight blade which enters in below the band is double, and on the inner half there is a projection. On the outer side of the curved blade there is a corresponding projection. These two projections lay hold of one end of the cut wire, whilst the other is set free and drawn from under the sheaf upon the feeding bench of the threshing-machine. Now, the wire should be cut close to the twist, and the twist end pulled out, as this is the easiest way of doing the work. The instrument is hung from the neck of the operator by a strap, so that the moment he cuts the band and pulls it out, he, with the help of a spiral spring, opens the blades, when the wire band may be withdrawn and placed in a box under the feeding bench, and when the threshing is over the whole may be bundled away, not a single inch being left in the straw."

A remarkable evidence of the universality of the feeling, be it prejudice or not, against the use of wire for sheaf-binding is shown by the fact that in every one of the English inventions entered at the Liverpool Show a distinctive feature was stated to be the employment of some vegetable fibre as a binding material instead of wire, and in the Royal Agricultural Society's trials next year no doubt it will be made a great point of by our native

\* In a letter dated March 4th, Mr. Scotson gives me the following account of his experience of the use of this contrivance for cutting and holding the wire band :—"Last week I threshed the white oats, which were cut by the three Self-Binding Reapers, tried by the Royal Agricultural Society in my fields in August last. We had one of W. A. Wood's Wire Band-cutting Nippers. If we had two instead of one there would have practically been no difficulty in the two people on the threshing-box supplying the sheaves as fast as the Clayton and Shuttleworth 8-horse machine could thresh the corn. The sheaves need to be cut where the twisted wire fastens, so that the sheaf is loose at once from the wire band, which we dropped into a basket. If the wire band is not cut where the twisted fastening is, the twisted portion of the band brings some straws from the loose sheaf with it—which is objectionable; but, as I have indicated, with two pairs of nippers the two persons on the machine-box would have time to turn the sheaf to find the part of wire band where the twisted fastening is on the sheaf. When the sheaves were all threshed, we sent the wire bands, with what little unthreshed corn attached to them, altogether through the threshing-machine, and would not have weighed 30 lbs. weight, wire, straw and all which we burnt, so that practically I see little difficulty in the corn being tied with wire."—Ed.



manufacturers. In spite of this, the American makers have obtained the start, and they will take some collaring even should this point be in favour, which I much doubt, of our native invention :—

“*Dimidium facti, qui cœpit, habet.*”

The experience of these two days' trials seemed clearly to point to the superiority of Wood's machine over the other two in adaptability to the practical work of the farm. McCormick's is especially imperfect in the way in which it divides the cut from the uncut corn. It has, however, many good points, amongst which is the adjustment of the reel. Osborne's machine is the next in merit to Wood. It works with a cloth elevator, like McCormick's, and is an ingenious invention with an imperfect dividing and gathering as well as delivery arrangement. At present, W. A. Wood's machine is nearly perfect. When some alteration and adaptation to English crops have been made, viz., in the gathering and the delivery arrangement, it will reach, I think, a point of efficiency that will with difficulty be surpassed. One point, however, of mechanism will no doubt have struck the skilled mechanic who is in charge of it, and that is, that the mutilated segment is defective in want of continuity of motion, from which arises an amount of jerkiness that may with advantage be diminished. I scarcely dare suggest that the spring propelling the sheaf is too strong; but whatever be the cause, it is a point that my description of the trials will have shown to be sufficiently prominent to demand and obtain skilled attention.

As a general conclusion, it is quite clear that none of the three machines is an efficient reaper and sheaf-binder combined, on the general crops of this country. It has been shown also, that in particularly light crops the work of cutting and sheafing and binding can be done by two of the three fairly well, and by one of them particularly well; nor should I fail to note, as a corollary, that the mere operation of sheafing and tying, unconnected with the question of gathering and delivering, is undoubtedly now an accomplished fact.

At the conclusion of the trials the Judges placed the following Report in the hands of the Stewards :—

“The Judges report that having made a careful and thorough examination of the American Sheaf-binding Machines, which were tried on wheat and oats on Mr. Scotson's farm at Aigburth, they are of opinion that whilst great credit is due to the three inventions, viz., those of Walter A. Wood, D. M. Osborne and Co., and C. H. McCormick, for the considerable efficiency attained, none of them have, as regards the requirements of English farmers, attained that perfection which would justify them in awarding the Gold Medal of the

Society. They, however, strongly recommended that a SILVER MEDAL be awarded to Walter A. Wood as a recognition of Progress, and that *high commendation* be bestowed on the binding mechanism employed by D. M. Osborne and Co.

“Believing in the great importance of this invention, when made practically efficient, they are glad to know that the Society propose to continue their offer of a Gold Medal for an efficient Self-binder.”

The recommendation of the Judges was adopted by the Stewards.

On this occasion the management of the arrangements devolved upon Mr. Bowen Jones and Mr. George Henry Sanday, Stewards of the Society, and Mr. H. M. Jenkins, the Secretary of the Society, whose exertions were repaid by the entire success of the proceedings, there being not a single hitch during either day in any important matter to mar the progress of business, if we except the showers on the first day. The exceptionally fine weather on the second day, the total absence of mist and the presence of sunshine, by no means common attributes of the weather in the neighbourhood of Liverpool, were some compensation to all engaged in the field for the inconvenience sustained on the previous day.

The efforts of the Judges to complete the trials in the space of two days were noticeable, and it was only through the favourable change in the weather that they were enabled to accomplish this object.

#### THE SILVER MEDALS.

Following the awards, the first implement to notice is W. N. Nicholson's Patent Grist Mill for power, price 12*l.* 10*s.*, and called by them “A New Vertical Grinding Mill and Kibbling Mill, for beans, peas, oats, barley, maize, linseed, &c., with adjustable feed and concave safety appliances for passing stones without injury to the grinding surfaces.” In this mill W. N. Nicholson and Son claim to have invented what has long been looked for, viz. a comparatively cheap mill with few and easily replaced wearing parts, and one which, run at no excessive speed and with no excessive power, will yet get quickly through a large amount of work, and produce withal an excellent sample.

The following statistics were given by the exhibitor as evidence of its practical success:—Run at a speed of 400 to 500 revolutions per minute, with an actual 3-horse power indicated, the results were briefly, *per hour*, 60 bushels maize kibbled, or 10 bushels ditto finely ground from the whole corn; 40 bushels beans kibbled, or 14 bushels finely ground; 12 bushels barley finely ground, and a similar quantity of oats.

The mill may be shortly described as follows:—On the top of a vertical spindle, A, supported in a tripod frame, and carrying the driving-pulley, is

loosely fitted a bell-shaped metal matrix, B, 6 in. in its smallest diameter and 10 in. in its greatest. This constitutes the driving part. Its surface is deeply grooved at the top for kibbling purposes, and finely lined at the bottom for grinding into flour. It revolves inside a concave, D, similarly grooved, but cut the reverse way. The position of the matrix with the concave is altered by means of a hand-wheel and levers, which raise or depress it at will, and adjust it for grinding fine or for kibbling, with the peculiarity of allowing the grinding surfaces to remain idle when kibbling only is required. A safety provision is made for allowing the passage of any foreign hard substance, such as a nail or stone introduced with the feed, without injury to the grinding part. The feed is regulated by means of a ferule fixed at the bottom of the hopper, and riding on the crown of the matrix. This can be readily set to a nicety by a simple combination of lever, hand-wheel, and screw.

The special advantages claimed for the mill are:—

1. That the matrix and the concave, the principal wearing parts, are small, inexpensive, and require no fitting when it is necessary to replace them.
2. That the grinding being carried on over the whole surface of the concave, it wears evenly and not in holes; and the system of vertical adjustment ensures its grinding thoroughly until worn quite smooth.
3. That owing to the safety arrangement the liability to breakage of the concave is reduced to a minimum.
4. That the mill will grind all kinds of corn and pulse equally well.

Fig. 8.—Section of Nicholson's Patent Grist Mill.

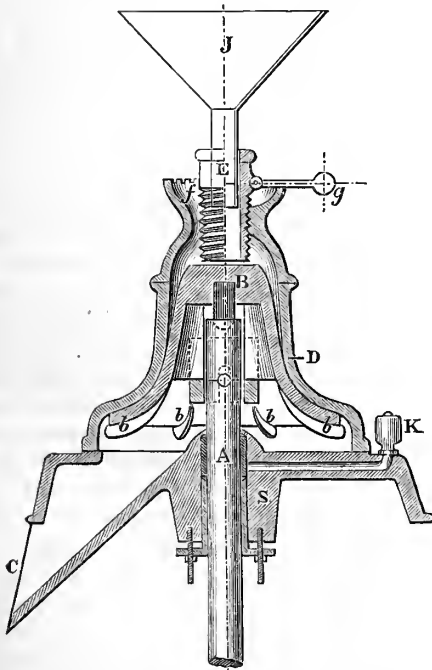

A. Vertical spindle, on which is the fly-wheel and driving-pulley.

B. Hard-metal bell or cone suspended freely on spindle, having coarse grooves in the upper part, meeting grooves in the concave for kibbling, and finer grooves cut the reverse way for grinding into meal.

b, b, b. Feathers for causing a current of air through the mill, and carrying the grist to the delivery spout C.

D. The fixed metal concave, grooved the reverse way to the cone B.

E. Nozzle or ferule for regulating the feed, screwed into the dome (f) and held in any required position by a jointed lever (g), dropping into notches in the upper flange of the dome.

J. Hopper.

K. Oil-cup for lubricating the spindle where it passes through the stuffing-box S.

This machine worked admirably under every test to which it was submitted. The invention is remarkable for the sim-

plicity as well as the novelty of its principle, and for the absence of complicated mechanism in its construction. Its practical merit must be measured by the durability of its grinding surfaces and the cost of their renewal. This latter is stated to be 30s. per set. The durability of its grinding surfaces depends on the character of the metal, the special composition of which I have no knowledge of. The wear of these, however, will be lessened by the special feature that the grinding surfaces remain idle when the mill is set for kibbling only; in other words, they are so wide apart that the grain kibbled in the upper portion of the mill can pass between the surfaces; hence the result is clean kibbling, and not a mixture of kibbling and grinding which is so common in many mills.

Whatever may be said of other descriptions of mills in use, it is clear that this is an efficient and economical implement, and a really new invention. As such the Society's silver medal fell to it by indisputable right. The award will have an indirect beneficial result beyond that of distinguishing this particular implement if it should direct fresh attention to the value and use of this class of machinery on a farm. The necessity for such becomes day by day more imperative. A large and increasing proportion of home-grown grain is now consumed on the premises, and large importations of foreign beans, peas, lentils, and Indian corn are used to still further increase the meat-making capacity of the farm. The grain for horses, too, is generally mealed for mixing with chopped hay and straw. To send these several kinds of seed-corn to be ground at a public mill would cost as much as would pay the rent of a small country mill. Forty years ago all corn was ground at the mill and paid for by "moulder," a system then legalised, by which the miller took a fixed proportion of each sack of grain in payment for his work. The proportion taken was certainly never *less* than the proper one, but there was no obligation that a larger quantity should not be taken, and tradition records that the "moulder" was often well done by being twice done. But little grain was ground for stock at that time, hence the continuance of the ancient practice. At this day, however, the farmer could not bear to see his waggon come from the mill with two or three sacks less than he sent. In due course no doubt we shall see competitive trials, under the auspices of the Society, of the several grinding and kibbling mills now in use throughout the country, when the relative standing of this machine will be positively established. At present it comes before us with visible claims that entitle it to the Society's medal and to public notice.

The Hydrotrophic new boiler-feeder received a silver medal. There has for some time been room for further improvement in boiler-feeding, which should combine the advantages of the

injector and donkey feed-pumps without their disadvantages. This desideratum Messrs. Hodgkin, Neuhaus and Co. profess to have accomplished in their Hydrotrophe, a special adaptation of their Pulsometer pump.

The accompanying sectional illustrations clearly show the mechanical construction of the Hydrotrophe.

Fig. 9.—*Transverse Section of the Hydrotrophe.*

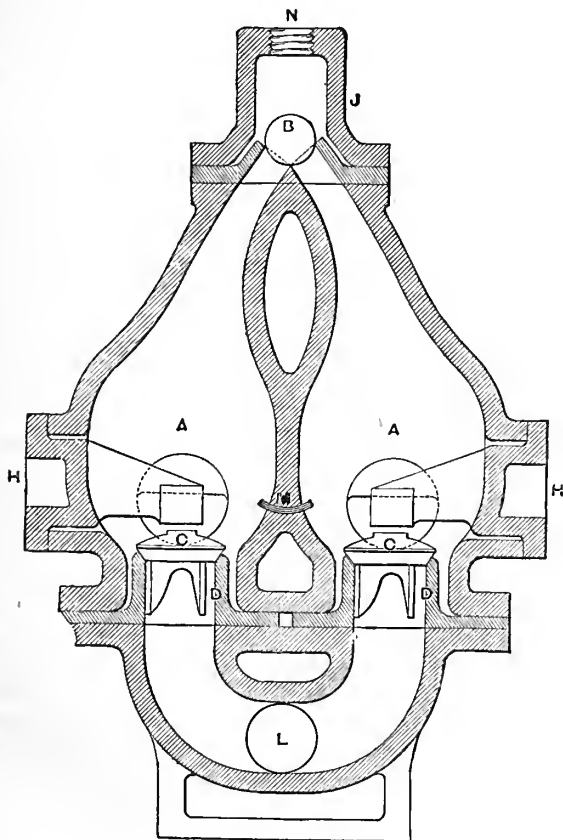

The Hydrotrophe consists of two chambers, A A, contained in one casting, connected at the top by a neck, J, containing the steam ball-valve B, which, by its oscillation, admits the steam alternately to the chambers, and at the bottom by a breeches-piece on which the junction seats D D and suction valves C C are placed. On the side of the chambers is attached the discharge-box O, containing the delivery seats E E and the valves F F. Doors, H H H, are fitted to permit inspection of the suction and delivery valves, and to

enable their lift to be adjusted if at any time needful. K is the discharge pipe leading downwards for connection with the boiler. L is the suction pipe for water supply, which can either be from a cistern on the ground-level or from a height, as circumstances may make most convenient. G is the suction air-vessel, through a plug in which the hydrotrophe is filled with water at first starting. The small injection pipe M is bent upwards and forms a connection between the two chambers; its purpose is to hasten the condensation of steam when the hydrotrophe is employed on a long suction.

Fig. 10.—*Longitudinal Section of the Hydrotrophe.*

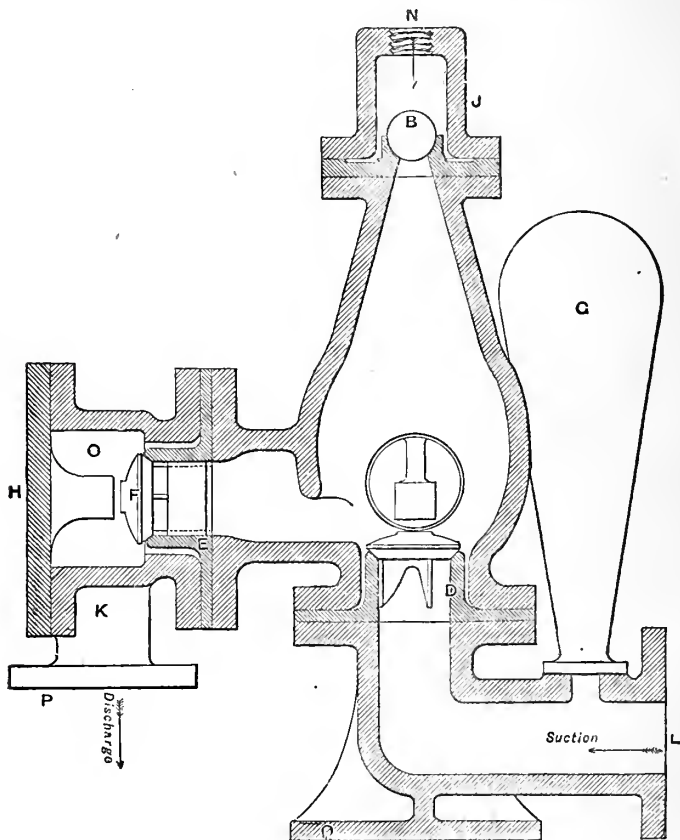

The hydrotrophe may be fixed in any convenient position with respect to the boiler, either upon it or at some distance from it; the only necessary condition being that the discharge flange should not be less than eighteen inches above the normal water-level. Steam could be supplied through a wheel-valve screwed into the opening N by means of a pipe taken from any well above the water-line; the discharge pipe, to which is connected the flange P, is to be taken into the boiler at any point well below the water-



level, and the suction-pipe is either to be taken down to a tank not more than eight or nine feet below the level of the flange Q, or it may be connected with a tank at any height above the apparatus. When fixed, the instrument is to be filled with water by unscrewing the plug in the air-chamber G, and is then ready to be started. On admitting steam through the steam-neck J, by opening the wheel-valve above it, the steam will depress the water in the chamber open to the steam, forcing it through the delivery-valve. On reaching, however, the centre of the discharge-opening leading to the discharge-box, owing to a particular configuration of the passage, the steam is instantly condensed. The steam-ball, pulled on one side by the partial vacuum, and also assisted by the vapour and water in the other chamber, changes its position in its seat, sealing the opening in the neck through which steam had been previously passing, and a tolerably perfect vacuum is then formed, and the water then rushes up through the suction-valves to fill the void. In the meantime the action in the other chamber is exactly similar to that just described, these alternate changes going on steadily as long as steam and water are supplied.

Beyond the foregoing descriptive remarks no further observations are necessary from me, as the Judges were favoured with a special Report on this machine from Messrs. Eastons and Anderson, the Society's Consulting Engineers. They report as follows:—

Article 4361, Stand 205. Hydrotrophe or apparatus for feeding boilers. This instrument is a variety of the pulsometer, which was first exhibited last year and found on the trial not to be an economical method of raising water. As applied to feeding boilers, however, the question of economy does not arise, because the whole of the steam used is returned to the boiler; there cannot, therefore, be any considerable loss of heat. The instrument, now exhibited for the first time, is said to be for 30 horse-power boilers. We have found by experiment that it will pump as little as 1.89 gallons per minute at ten pulsations, equivalent to 18 horse-power, and as much as 6.21 gallons per minute at 29 pulsations, which is equivalent to 60 horse-power; the range of the apparatus is therefore considerable. We ascertained further that it will work steadily with feed-water up to 140° temperature, and that there is no difficulty in stopping and starting the instrument. It has one defect in common with the Gifford injector, and that is, that it will not suck water more than 8 feet high; in the present instance it was not more than 5 feet above the level of the water in the supply-tank. It must be placed near the water-level of the boiler, and the higher it is above, the more water it will deliver within the limits of the apparatus. The price is 16*l.*, which is moderate, and there is no difficulty in fixing. We think the hydrotrophe will prove a useful and durable pump applicable wherever independent feed-pumps are required, and where water can be obtained within 8 feet of the water-level of the boiler to be fed.

EASTONS AND ANDERSON.

The third and remaining silver medal was awarded to Messrs. Clayton and Shuttleworth's new patent Drum-guard on a Threshing-Machine. This adaptation fills up a want long felt. It is a machine purely agricultural, which is a distinctive feature of merit to be duly considered when it comes before the Judges of the Royal Agricultural Society. To the farmer and

every member of the community the loss of life by accidents or the maiming of limbs has long been regarded as a national loss. Yet, strange to say, though safety-gearing has become a rule in the higher branches of mechanical construction used in arts and manufactures, it is only within five or six years that our mechanics have turned their attention to this point, and made efforts to accomplish the same object in the more powerful and complicated machinery now used in advanced and scientific agriculture. From what I saw at the Liverpool Meeting I shall be enabled to give before my Report is concluded, not only proof of the general interest manifested by engineers on this particular point, but to show abundant testimony of the results which they have attained already, and some of which will produce a most appreciable saving of human life.

This machine does not, however, depend upon the important work which it proposes to accomplish, but is fully entitled to any honour that the Society can award it, not only as an effort in the right direction, but also as a successful remedy and prevention of a serious evil. A more thoroughly efficacious automatic safeguard to a very dangerous part of a most destructive machine I have never before met with. Like all the most important inventions round which hundreds of adaptations have clustered, this discovery depends on one of the simplest mechanical principles known and employed by every workman. The whole thing is done by an automatic movement of two levers attached to a crank-rod at each end, and moving simultaneously whichever of the two levers chances to be pressed upon, in which case the mouth of the drum is securely closed. A noticeable feature in this invention is in the fact that a few inches of open space are left when the safety-guard is down. Through this aperture the loose corn accumulated on the stage, chaffings full of short heads, rakings, and other refuse in which there will be generally found an accumulation of gravel and small stones which are in ordinary machines frequently injurious to the workpeople, can be thrust by a rake into the concave of the drum. It is remarkable to observe that safety appliances judiciously applied to agricultural implements generally increase their efficiency and value.

The following mechanical description will show how this Drum-guard operates in practice, and will be clearly understood at a glance by every one. Simplicity in construction and effectiveness in action, as all mechanics know, are really true cause and effect:—

In producing this guard two important points have been kept in view: 1st. To remove all danger to the persons engaged in feeding. 2nd. To place as much of the necessary mechanism as possible below the scaffold boards.

Fig. 11.—Sectional View of Messrs. Clayton and Shuttleworth's Drum-guard when open.

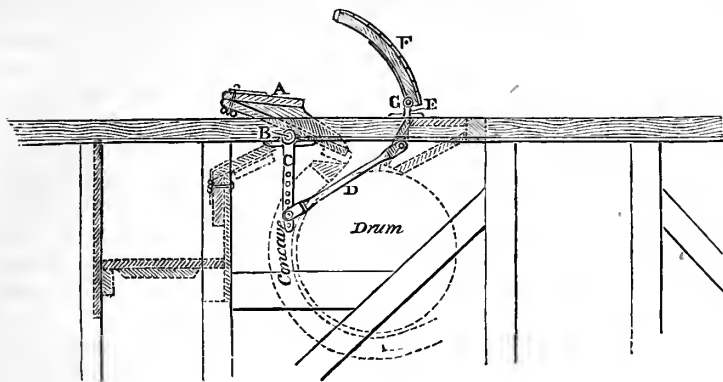
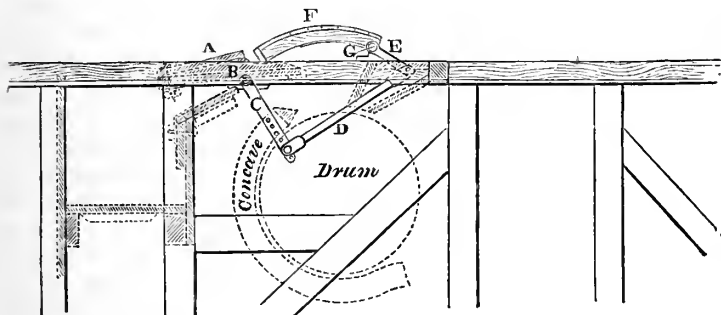

Fig. 12.—Sectional View of Messrs. Clayton and Shuttleworth's Drum-guard when closed.



These objects have been satisfactorily accomplished in the following manner:—A is the feed-board radiating on pivots B. F is the hood radiating on pivots G. C and E are levers secured to the ends of pivots B and G. These levers are connected through the medium of the rod D, consequently any slight pressure or weight brought to bear on the hood F or feed-board A instantly closes the mouth of the drum; the hood then resting on the top of the machine-frame, as shown in Fig. 2. The coupling-rod gives simultaneous movement to the feed-board A and hood F. A convenient opening is left below the bottom edge of the hood (whether up or down) for sweeping loose corn into the drum, which, coupled with the compact method of construction, renders it a valuable adjunct to threshing-machines.

## MISCELLANEOUS INVENTIONS.

Second only to the interest attached to the Sheaf-binders was that which followed another class of labour-saving machinery in farm field-work, viz., the Hay-loaders.

Two of these were exhibited:—The Harvesting-machine or Elevator, invented by C. Loader, East Pennard, Shepton Mallet, Somerset; and the American Hay-loader (Foust's patent), exhibited by Alfred Field and Co., Liverpool. The former is priced at 45*l.*, and the latter at 25*l.*

Neither of these was eligible for a medal according to the strict conditions enforced in the regulations quoted at p. 104: nevertheless they are attempts at accomplishing important objects difficult of attainment, and command consideration. This the Judges gave them by practical tests thoroughly carried out. The loaders were tried on the farm of Mr. Hugh Hayward Jones, at Lark Hill, West Derby, about three miles from the Showyard.

Each was worked in succession on a heavy crop of hay, loading from heavy close winnow from the swathe, and from open winnow in which the hay was laid in a breadth of 4 yards. The English machine in each case gathered the hay clean, and lifted it up well; but at an immense expense of power, the horses labouring to keep it going. When going at full pace, the men on the waggon were useless, the one nearest the machine being buried under a continual avalanche of hay, and entirely occupied by his efforts to disentangle himself from the shower of hay falling upon him. His convulsive struggles were amusing. Under these circumstances one-third of the hay slipped off the waggon. A good deal also fell behind the waggon at the hind corners. Acting against the wind the work was impracticable, the hay blowing away at the highest point of elevation and while falling. This machine is very heavy, and the process at present can only be accomplished at a cost far exceeding that of manual power.

The American machine is very light and elegant, and, except in a wind, deposits the hay on a waggon which goes in front—the opposite being the case with the Loader machine—in a manner that allows two men to load it fairly well. In this case also by far too much hay fell on the ground after passing the top of the Elevator. A wider waggon or narrower gatherer might be adopted. A foot in width could advantageously be saved, as then it would gather as much as two men could load. The gathering-rake moves in the opposite direction to that of the Loader, which is a revolving cylinder with teeth like those of the Hay-spreader, which draws the hay inwards. The American drum goes round the opposite way, the teeth bringing

the hay outwards. Very pretty as the motion is, it must be said that the American machine did not take up the hay, when in heavy row, as clean as the English. Upon a very light winnow it worked very well. Altogether, this machine, from its cheapness, its light weight, its comparatively light draught, and the general principles of its construction, promises well for the future. The gathering power may, I think, be improved materially, after which we shall have a clever machine capable of working its way into practice where large breadths of grass are cut, and where the quantity of work done in a limited time is of more importance than a small money economy. The advantage in price, which the American machine has, is a matter of consequence, and it may be made yet more cheaply.\*

The Judges placed both implements in the list of novelties recommended to the notice of the Official Reporter. Both have in them the elements of future success. The American machine starts with the great advantage of comparative cheapness and simplicity. I have not been able to obtain an illustration of Loader's machine, but it may be best described in the language of the specification of patent as follows:—

"The inventor's object has been the construction of a machine in such a manner as to admit of its being adjusted to load a waggon either at the front or the back of the same, as may be required.

"The machine is arranged with gathering frames fixed in front of the loading-rakes worked by an endless band or chain, which receives its motion from a pinion on the axle of the chain-pulley gearing, with a wheel on the axle of the running-wheel. The hay as it is gathered by the prongs is taken up by the front loading-rakes and carried to the top of the inclined platform, when it is allowed to fall into the waggon as it proceeds.

"When the machine is required to load sheaves or loose corn at the back of the waggon, the gathering prongs are fixed under and in the rear of the loading-rakes, until on reaching the top it is allowed to fall into the waggon. The chain or band of the loading-rakes is worked by a pinion on the axle of the chain-pulley gearing with an internal wheel on the running-wheel."

The American Foust's Loader was described and figured by

---

\* Loader's machine was worked in the trials with the waggon attached behind it. The elevating prongs (which act in a somewhat similar manner to the corresponding parts in an ordinary elevator) work in front of, and in an opposite direction to, the advance of the machine, and so meet the hay and gather it up cleaner than the American loader can do. In fact, this machine will gather up hay fairly clean which has been left spread on the ground by the haymaker. The wind-rows of hay on which the loaders were tried were very large, and the horses being driven at a great pace, the hay was delivered on to the waggon much faster than two men could possibly place it. This caused the work to be done in a very untidy manner.

Foust's loader works behind the waggon, and the hay is picked up at the tail of the machine. This machine appears more particularly adapted for taking up hay out of wind-row, which it does tolerably well, and with moderate draught.—  
J. W. K.



Mr. Coleman in his Report on the Agricultural Implements at the Philadelphia Centennial Exhibition.\*

Considerable interest was excited by the two Sheep-shearing Machines exhibited by Messrs. Newton Wilson and Co., and by the Reading Iron Works for Captain Turquand.

The former invention comprises an iron standard, on which the motive-power, a pulley-wheel turned by hand, is fixed, and from the end of which a flexible arm with ball-and-socket joint carries the shears. The operator holds the sheep with one hand, whilst he guides the shears with the other.

Captain Turquand's machine has some special features which recommend it for favourable consideration.

It consists of a double-hinged frame capable of securely holding two sheep, which are secured by the legs and by a strap across the neck, so completely that the operators have both hands at liberty to work the shears and manipulate the wool. The motive-power is derived from the revolutions of a large and easily rotated fly-wheel, which drives by means of a crossed strap and two rollers, above the platform where the sheep are secured. Catgut bands convey the required motion to the cutters. This is a very simple and efficient arrangement. It is necessary to begin one sheep first, and when shorn on one side he is transferred to the opposite frame, which, owing to the hinged apparatus, is readily accomplished. Thus two operators can work, and with moderately expert hands a dozen sheep can be shorn per hour, three men being employed. The price of the machine complete is 35*l*. As professed labour-savers, the Judges determined to put them to a competitive test. The experimental trials of these on living sheep took place, and were watched with great interest by a large concourse of spectators, not the least interested among whom were the shepherds in charge of the sheep for exhibition, as the place in which the trials were held was only a few yards distant from the sheds in which the sheep were housed, the Leicester sheep being nearest. There was, therefore, a gathering of the knowing ones round the ring, whose remarks were truly of a practical character, but, it must be admitted, more free than complimentary. Each competitor was allowed a sheep to practise on before the testing with animals took place.

Newton Wilson's machine has no platform, the man who guides the machine holding the sheep on the ground exactly as

---

\* 'Journal of the Royal Agricultural Society,' 2nd Series, vol. xiii., Part I., p. 35.



when ordinary shears are used. Captain Turquand's machine has a very ingenious platform on which the sheep is laid and bound down, so as to allow the man to guide the machine without obstruction and without the labour and the strength required to control an unruly sheep. When half shorn, a reversal of the platform turns the sheep so as to bring the unshorn side under the operation of the shears. This mode of securing the sheep saves, I am convinced, half the power used in manipulating the machine. At the trial, the man engaged in using Newton Wilson's machine consumed as much power in holding the struggling sheep as he did in guiding the shearer and taking off the wool. In point of construction, Turquand's machine has a great advantage in its platform and in the clever manner in which the power is applied. Having a heavy fly-wheel, the power required after motion was produced was very little, a man keeping the shears going with perfect ease. This point I personally tested. In point of working capabilities, Turquand's machine has considerable advantage, cutting more freely and with larger grasp. Newton Wilson's shears seemed to nibble at the wool to some extent, and to linger as they passed over the sheep. They also left a quantity of waste wool in short lengths. This opinion seemed justified by the result, as Turquand finished his sheep in good style in 11 minutes, the Newton machine taking 17 minutes to complete the denuding of the other animal. In neither case was the sheep cut in any part of the skin, and the workmanship of the operation was first class, more wool being got off than by the ordinary mode of "clipping." These excellences do not by any means counterbalance the disadvantage of the cost of the operation by either machine, as compared with hand-shearing. The same number of hands are required by the new as well as the old mode; but a better man is required at the wheel, and to bring sheep to the machine, than is required to bring the sheep to the ordinary shearer, as he has no wheel to turn. Indeed, this help may be dispensed with by penning the sheep close at hand. Assuming, however, the manual power to be equal to both modes, we still have the cost and the interest of the machine in excess, and inferior results by the new mode. The sheep operated on were lambs, and it required 11 minutes to remove the wool by the fastest of the machines, a time more than double what a first-rate clipper would require to clip a similar sheep in. Certainly, in a trial on a single sheep, the fleece could be taken off by hand-shears in less than half the time taken by the machine; while in ordinary practice, by ordinary shepherds, not more than 7 minutes would be required to strip a small sheep. The

practical man will at once see that it will not pay to employ two men and a machine to clip five sheep per hour, which is all it can do, calculated even at trial-speed.

A practical test of a novelty of this kind is of great use; it points to the inventor the path before him, and the difficulties that he has yet to overcome, while it tells the practical man that the wool can be taken off by machinery even better than by hand. The next step may be to cheapen the process by increasing the pace of the machine.

While Turquand's machine is clearly and distinctly superior to Newton Wilson's, both fail to show themselves "labour-savers," one pair of shears by the aid of machinery and extra hands failing to do the work that one pair of shears in the hands of a skilful workman can accomplish without help or machinery.

As some discussion has arisen on this point, I am glad to be able to contribute a precise fact which satisfactorily defines what a good "clipper" can do. During last summer, a farmer's son on the East Riding Wolds of Yorkshire clipped 100 Leicester sheep in 11½ hours. He had no help except to take away the wool and to bring him fresh sheep.

The Judges have directed my notice to no less than five machines of one class—Chaff-cutters, more especially with regard to the improved arrangement of safety guards.

The strong current of public feeling in favour of safety-apparatus on dangerous machinery, and the success of mechanics in accomplishing the adaptation of such safeguards in many instances, I have already mentioned. Chaff-cutters present the most notable instances of mechanical success in this direction; each of the machines referred to having, in addition to its own special claims, whether of construction or principle, an undisputed title to the merit of having adopted gearing which renders an accident to the feeder from the knives almost impossible.

*Safety arrangement in Messrs. Richmond and Chandler's Chaff-cutter* (Catalogue No. 931). The hopper is fitted with a self-acting endless feeding web, or creeper, which carries the material to the toothed rollers, thus rendering great assistance to the feeder, and moreover adding much to his safety, as no thrusting forward of the material is required, and there is therefore no necessity for him to put his hands near the toothed rollers. The machine is sent out to cut any two lengths of chaff without change of wheels by simply moving a handle, which also acts as an instantaneous stop motion, and which can be worked either by hand or foot. The foot treadle is placed in a convenient position, and is so arranged that on being pressed upon the rollers are at once stopped. This would be a great advantage if the feeder carelessly got his hand caught between the feed-rollers. In addition to this, a self-acting reverse motion has just been introduced, the lever of which is so placed that if the

feeder get his hand caught, and have not the presence of mind to throw the machine out of gear with his foot, it appears certain that his arm must be drawn against the lever, when the rollers would be at once reversed and the hand liberated.

*Allcock's new Patent Portable Chaff-cutter*, No. 130 in the Society's catalogue, price 28*l.*, was shown amongst machines in motion. Its special claim to notice is its new patent lever for protecting the feeder from accidents. The safety-guard renders it impossible for the feeder to be injured when at work, as, in the event of his arm getting too far and bringing the fingers in contact with the rollers, the arm itself lifts the lever without effort or impulse on the part of the man himself, and compels the fingers to go back from the rollers with the fodder in the box until quite away from all danger, whereas most other guards are dependent on the presence of mind of the feeder, and his quickness in using the lever to reverse the rollers.

The "*Starr*" *Chaff-cutter of Lowcock and Barr*, price 16*l.* 16*s.*, has also a special claim to notice on account of its new safety-bar, consisting of a novel arrangement of the lever for stopping and reversing the rollers, so that if the man feeding the machine should even get both his hands fast in the rollers, he would instantly liberate himself by throwing his arms or body against the safety-bar. The idea is new and admirably practical. It is possible for a man to get his hands fast in the rollers without throwing his body against the safety-bar, but it is unlikely so to happen. In ninety-nine cases out of a hundred some part of his body would press against the bar, so that the safety-action, if not quite automatic, is nearly so.

*John Williams' Chaff-cutter* (W. P. 7), price 18*l.*, is "*Whittaker's Patent*" Chaff-cutter, with a safety-gearing to stop or reverse the machine by hand or foot. A special feature in the safety-gearing of this machine is that the lever, which throws the clutches connected with bevelled pinions in and out of gear, once pressed stops the action permanently, and the machine does not go on after the pressure is taken from the lever, as is the case with some machines.

The last of this class of machinery on my list is the *Safety Lever Chaff-cutter* (S. Edwards's Patent), No. 10, price 19*l.*, exhibited by Messrs. John Crowley and Co., Sheffield. The levers, its maker says, are such that the user is secured against any liability of accident when feeding. "By the *one lever* the feed is *reversed* or *driven forward*, and the length of cut varied without change wheels. One great improvement is the *entire* absence of any retaining pins to keep the starting-lever in position, which enables the man feeding it, even if both his hands were fast in the feed-rollers, to stop the machine with his body by bringing it in contact with the lever, which is placed in a convenient position for that purpose."

That the Judges should notice five implements of one class I have attempted to explain by indicating the special feature of merit which they all possess in common, of making the danger to the attendants as small as possible; and enough has been said to show that marvellous perseverance and ingenuity have been displayed by our agricultural mechanical engineers in applying safety-gearing to a class of implements in such general use that the saving of life and limb must be very considerable.

Of the numerous Field Implements, Denton's Grass Harrow, Hunter's Turnip-Topper, and Barford and Perkins' Steam Cultivator, have sufficient novelty to render a brief notice of them desirable.

The general show in this important department of agricultural mechanics was never so large or so interesting. Every branch of the manufacture was thoroughly represented, ploughs, harrows, drags, cultivators, &c., from every maker, but each maker seemed to have a pattern of every variety made by his firm. The fact is, since the systematic trials by the Royal Agricultural Society have been temporarily abandoned, the makers, resting on their laurels, have discontinued straining after novelty, but have directed their energies towards extending and increasing their legitimate trade in the implements that in past years they had perfected and the merits of which public trials had tested. Hence while the general show of field implements was magnificent, the list of novelties pointed out by the Judges was meagre.

Denton's New Grass Harrow is made entirely of wrought iron with Bessemer steel teeth; it has the merit of being only 2*l.* 15*s.* in price. When joined together the links form a diamond or lozenge longer than wide, and at the apex of each angle a triangular piece of iron 4 inches long is attached through its centre. Twisted links run across the bottom of the lozenge and form a horizontal line, the triangular knives forming another horizontal line  $4\frac{1}{2}$  inches distant from the line of the links. Thus there is a cutter or tearer and a twisted link in each 9 inches; beginning with 1 link and 1 tearer at the corner, then 3, then 5, then 7, &c., &c., the line of blades runs slantingly, or at angles of about 45°, both to the right and to the left. As a grass harrow it clutches the ground, scratching up the moss with the knives, while the chains harrow up the rubbish and free it from mould. For harrowing hide-bound pastures, or meadows that have been dressed with bones; lime, or compost, it has most properly not escaped notice on this occasion. As a seed harrow on a cloddy surface it seems likely to be useful.

Hunter's Turnip-Topper and Tailer is one of the class of labour-saving implements which agriculture now needs. In saving the hay and corn crops much has been effected by machinery of this character, and more has yet to be accomplished, as the Liverpool exhibition and trials have shown; and if similar economy can be accomplished with our roots the gain of agriculture will not be insignificant. Root-crops cover more than one-fifth of the area of the arable land, or, to be exact, there are 2,826,824 acres of mangolds and turnips in Great Britain, while their weight is about ten times that of any other crop per acre. The manipulation through all its stages, from the first hoeing to the putting, topping, tailing, and storing, forms no inconsiderable item in the labour account of the farm. For reducing the manual labour employed in this work there is ample margin. Our ridging ploughs, drills, horse-hoes, and scarifiers have done much towards facilitating the cultivation of the crop; and two other machines are required to cheapen the costly processes necessitated, viz., a turnip-thinner and a turnip-topper

and tailer. No improvement appears to have been made in the former since the Bedford Meeting. The latter Mr. Hunter exhibited in forms adapted for both heavy and light land. The invention has been brought out and tested for some years, but it is on its duplicate form for strong and light soils that it rests its claim as a new implement in the catalogue, and competes for the Society's medal. Whether this claim be admitted or not, its title to be considered a most useful novelty cannot be ignored, if we take "novelty" to mean something that has not been achieved elsewhere *as a whole*, rather than as something entirely and absolutely new in all its parts as well as in its results.

The implement is constructed for cutting or sawing off leaves or tops, also for cutting up the turnips from the roots, placing them in regular rows ready to be carted away for storage, or put into heaps for cutting up and consuming on the land on which they were grown. By a very simple arrangement of the cutting or sawing frame connected with the main beam of the implement, and adjustable by rods and chains, the leaves of the turnips are lifted up in front of the cutting frame, the saw of which passing along cuts them all neatly off nearly at the same level. The cutting frame is triangular, the narrow or leaf-lifting end being towards the front of the machine, the saw or cutting part forming one side of the triangle, and placed on the outer side of it. There are two cutting frames, one on each side of the implement, so that as it passes along it cuts off the leaves of two rows at the same time. The rods and chains which adjust the position of the cutting frame are carried backwards, and are connected with two small levers jointed to the handles, so that the attendant can work them as required. The main-framing is carried upon three wheels, a small one being in front, and the two hind ones on a cranked axle worked by a lever, so that the implement can be raised from or lowered to the surface of the land as may be required.

Barford and Perkins' Steam Cultivator is a novelty in its self-acting appliance for lifting the tines out of the ground at the headlands, or at any point. Similar in general construction to ordinary cultivators for steam power, in this point of turning without difficulty it is *unique*. Inside each wheel, and fitted to the axles, are iron cams. By leverage from the operator's foot a bolt or bolts with small friction wheels at their extremities are made to protrude from the side of the frame so as to come in contact with the cam, and thus the frame is raised; the said frame not being rigidly attached to the axle when raised, the frame is held up by strong supports which can be removed by a second leverage. Without a diagram, it is difficult to convey an idea of this ingenious device. So far as I could ascertain in the limited space in the Show-ground there seems to be little doubt of its being a novelty that will make its way in practice.

From an engineering point of view, no exhibit in the yard excited equal interest with Otto's Silent Gas-Engine. Its special claims are "no boiler, no coal or refuse, no extra attendance,

safety and economy, suitability for most agricultural, and an infinite variety of other purposes." This is a startling programme, and it may be useful to inquire how it is to be accomplished. The engine is constructed by Messrs. Crossley Brothers, Manchester. The principle and action of this remarkable engine are simple, but are not generally understood. The principal peculiarity of the engine lies in igniting the charge of mixed gas and air *when this charge is compressed to a pressure of 30 lbs. or so above the atmosphere.* It has been found that when gas and air are thus compressed, ignition is possible with a very much weaker mixture than when they are at atmospheric pressure only, the compression appearing to bring the particles within the range of chemical affinity. A weak mixture of gas and air thus ignited burns more slowly than one containing a higher percentage of gas, while the heat resulting from the combustion is imparted to the non-combustible portion of the mixture, expanding it and giving that *sustained pressure* on the piston, which has been an element so wanting in previous gas-engines. The following diagram and explanatory remarks are from the 'Engineer':—

Fig. 13.—Diagram from Otto's Gas-Engine.

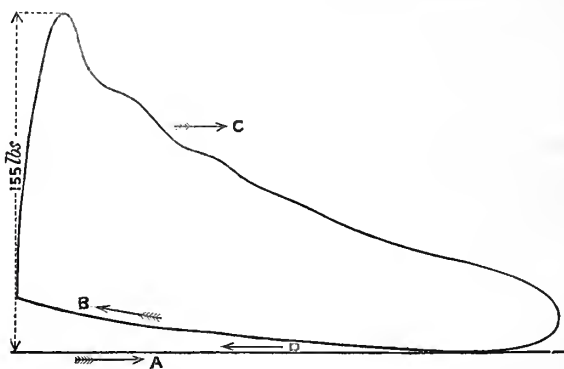

"It must be premised that the gas is only exploded *once* in every *two* revolutions when the engine is fully loaded, and the explosions may take place much more rarely when the engine is running against a small resistance. We have marked the diagram with letters and arrows to show the course of the piston. The first horizontal line is just below the atmospheric line, and marked A in the out stroke of the single-acting piston. The cylinder fills during this stroke with a mixture of gas and air through a slide-valve at the back. The inward stroke is shown by B, which gives the curve due to the compression of the gas and air mixture. When the stroke is finished, the gas is ignited by a small gas-flame, and the pressure rises, partly as a result of the explosion, and partly because of the expansion of the nitrogen of the air due to the heat of the explosion. The piston then goes out, and the curve



of the expansion C is drawn. At the end of this stroke the exhaust opens, and the piston returns, as shown by D, expelling the products of combustion. The governor acts by preventing the admission of gas when the engine runs too fast, so that more than two, or, indeed, more than a dozen revolutions may be made without the admission of any gas whatever. The 'Otto and Langen' gas-engine, of which Messrs. Crossley Brothers have made such large numbers, and of which they have introduced so many improvements, has been found eminently useful as a motor where small powers are required. The 'Otto and Langen,' however, is somewhat noisy, and in some cases this is an objection. The new 'Otto' engine, therefore, working as it does as quietly as an ordinary steam-engine, opens up a still further field for the employment of gas motors, while apart from its silent action it possesses other advantages. Numerous testimonials speak favourably of its action in daily practice, and its makers claim for it the following special meritorious features:—First, that the principle of combustion in this gas-engine is *entirely new*. In it an explosion does not take place in the ordinary meaning of the term. A small part only of the charge is combustible, which on ignition serves to expand the remainder, thus avoiding shock and effecting vast economy. The engine is also alone in the peculiarity of igniting its charge at the *beginning* of the stroke, leaving the whole of the stroke for effective expansion of the gases, instead of merely a fraction, as in other obsolete constructions. Secondly, this engine unites *the greatest simplicity of parts* ever yet attained in a gas-engine, or even in many steam-engines, with an *economy* and *durability* often surpassing either. It is as silent as a steam-engine, and works with the same smoothness and regularity, having, of course, the immense additional advantages of starting at full power at once on the gas being lit, and, by dispensing with the boiler, of avoiding the dangerous and pecuniary risks, annoyances, and expensive attendance which a boiler entails."

Riches and Watts showed a Porcelain Roller Mill (Wegman's patent). It has differential speed and self-acting pressure for softening Fine Middlings, or breaking down wheat in preparation for the stones. It is manufactured by A. B. Childs and Son, 70, Fenchurch Street, London. The price is fixed at 80*l*. The machine is only 34 inches wide, by 42 inches long, and comprises two sets of rollers supplied from either side of the hopper. The surfaces are very smooth; and their efficiency is attributed to their peculiar porous nature. The principal use of the mill is to prepare middlings for the sieves. This is ordinarily effected by the tearing action of the stones; whereas the rollers operate with a squeezing action on the particles of bran which are thus prevented passing through the silk, and thus a more perfect separation is effected. The idea of using rollers is not new; cast-iron or steel rollers have been employed, but the inventor states, not having an equal porous surface, the meal coming from these rollers was caked, and could not be sifted without a further disintegrating process, which tended to destroy the beneficial effect of the rolling by rubbing the flattened bran particles into the meal. The quality of the flour rolled by this mill, after being sifted, was certainly extremely fine.

“An INTERMEDIATE HORIZONTAL MOTION which can distribute power in any direction” was mentioned by the Judges. This is manufactured and exhibited by W. N. Nicholson and Son, of Newark. It is an intermediate motion with a vertical as well as a horizontal driving-shaft. The vertical shaft is fitted with a horizontal flanged pulley, from which any number of food-preparing and other machines arranged in a circle round the gear can be driven, without moving them into position, by a half-twist strap.

On moderate-sized farms, where expensive fixed machinery cannot be adopted, this motion will be very useful, and, in any case, will allow several operations to be carried out without the expense of costly shafting.

---

#### VI.—*Early Fattening of Cattle, especially in the Counties of Surrey and Sussex.* By HENRY EVERSHERD.

THE counties of Surrey and Sussex are not naturally adapted to the business of rearing cattle, and they are, in this respect, less productive than in the last century. Fifty years ago the live stock of a Wealden farm consisted, in winter, of some bacon-hogs and Kentish lambs, with a few hardy Sussex cows and their offspring. The cattle “roughed it” in the straw-yards during winter, and lived on clover, grass, and stubbles, the rest of the year. This was the system that stamped the Sussex breed with their characteristic hardihood. But this old-fashioned method is quite unsuited to modern farming. The straw-yards are no longer supplied with choice handfuls straight from the flail during six months of the year. All adventitious opportunities of satisfying bovine appetites have been diminished. The wide margins of the lanes have been reduced, the commons and wood-side pastures have been enclosed, and the stubbles, under modern management, should contain the least possible quantity of accidental forage.

It is the same in other parts of the two counties; the supply of food and fodder for breeding-cattle has been reduced. Nor are these counties naturally adapted to pasturage. Setting aside the sheep-breeding district of the South Downs, neither of them is a breeding county. They produce food for the winter rather than the summer months, the Wealden clays being well adapted to the growth of mangolds, and the loams and sands of Surrey being equally favourable to the growth of other kinds of root-crops. The amount of winter-food is increased by the practice of mowing the “seeds” of the four-course rotation for

hay instead of grazing them. There is no doubt that sheep and cattle both do badly when summered on hot sandy soils. All through Surrey, therefore, and in Sussex, more or less, the farms, as a rule, are emptied of their stock in spring. At that time the last of the fattening cattle are finished off on the last of the roots; and about Guildford Fair-day, on May 4th, the last of the store tegs, which have been wintered on turnips and kept some weeks further into the spring on rye and other forage, are disposed of.

The farms are thus depopulated for the summer season. In October they are again stocked. Store sheep for folding and fattening in the turnip-fields are purchased in the breeding-districts of the south and west, and the yards are filled with cattle. In the main this management, as a general system, is right; but in recent years the high price of store-cattle has induced the best stock-farmers to rear, at home, some at least of the stock intended for fattening.

One of the best strains of red cattle was collected, a hundred years ago, at Theal, a farm in the parish of Slinfold; and most of the best existing herds of Sussex cattle have derived some of their excellence from this stock.

Mr. William Stanford, late of Charlton Court Farm, Steyning, has been a successful promoter of the practice of rearing and fattening young bullocks in his district. The calves required for the process are brought from the dairy districts of Somersetshire and the West, to Chichester and other markets. Various methods of feeding and treating calves from birth have been recommended, and they are all a little difficult to describe clearly in detail.

Mr. Stanford's method does not differ materially from that of other good managers. His calves are invariably weaned at birth. New milk is by degrees replaced by skimmed milk, thickened with boiled linseed or oatmeal. They are gradually induced to feed on linseed-cake and hay. At three months old, and up to six months old, their daily ration is 2 lbs. of linseed-cake, with the same quantity of bean-meal, and with about half a bushel of roots, hay, straw, and salt. The cake and meal are gradually increased, till at twelve months old they get twice the quantities above mentioned. In summer, some of the articles of diet just named are replaced by trifolium (which is good food while it lasts), by tares and grass, with second-cut clover. The whole of the green food is cut and brought to the animals in their sheds and houses, which they do not quit till they are sent to the butcher, by which time their daily rations will have been increased to 4 lbs. of cake and 6 lbs. of bean-meal, with roots and a moderate allowance of hay. The principle of management is

to let the animals continually outgrow their food, pushing them on rapidly the last three months, and finishing at something under two years old. I may here note that the calves get daily, at six months old and until ten months old,  $1\frac{1}{4}$  lb. linseed-cake, 1 lb. bean-meal, 2 gallons grains, 1 gallon mangold, and 5 lbs. hay. The cost of this, with labour and with a proper deduction for the value of the manure, is about 3s. 6d. a week. Each cow rears five calves.

From the first, Mr. Stanford's calves never quit their sheds until removed by the butcher. The reasons for this treatment will be given by and by; meanwhile, although the knack of rearing calves without loss can hardly be imparted by written directions, the reader may like to hear, at this stage, what other breeders have said on the subject.

Mr. William T. Carrington, of Croxton Abbey, Staffordshire, a dairy farmer with 100 cows, who enjoys a well-deserved reputation for successful stock management, has lately given his experience in the management of dairy-cattle. He says:—

“It is my practice to rear nearly 40 of my earliest heifer calves. They are not allowed to suck their dams; they have from 4 quarts to 8 quarts of new milk per day, according to age, from three or four weeks. They are then fed with skim-milk, thickened with boiled linseed or oatmeal, and are taught as soon as possible to eat hay and a small quantity of linseed-cake. They are allowed to run out on a grass-field in May and June, and are after then generally left out altogether, with a shed to run into in very wet weather, or to avoid the heat of the sun and the teasing of flies. The wet-nursing is generally discontinued when they are about four months old. They are, however, supplied with about 1 lb. each per day of linseed-cake all through the year.

“In order to have all the milk available for cheese-making we have hitherto often fed the calves, when taken from new milk, with whey thickened with meal.

“Skim-milk is a much safer food, and now that cheese sells at a good price, it will never answer to keep sufficient milk for the calves out of the cheese-kettle. In the spring, calves are generally very plentiful in this district, as dairying is the principal farming business, bull calves are therefore generally sold at a low price.

“Having a considerable local reputation for breeding good stock, I am able to sell mine at a fair price—selected ones for being reared by neighbouring dairy farmers for stock purposes, and the remainder to be reared as bullocks. I send many of them, at a week old, tied up in bags, packed with straw, leaving the head at liberty, per passenger van, into districts where calves are scarce. They travel quickly and safely, at a moderate cost. I am now using only first-class pure-bred bulls of registered pedigree.

“Those who rear bullocks cannot be too particular in getting the calves of the best possible quality. A coarse ill-bred bullock is a very unprofitable animal either to rear or feed.”

The same principle of management is elsewhere observed. Mr. Thomas J. Scott, of Stretton Baskerville, Hinckley, showed me a dairy of cows from whose milk was made some of

the best cheese of a noted district. The dairy is under first-rate management, and the treatment of calves may be briefly summed up thus:—"They are taken from their dams at birth, and put on new milk for about three weeks, when the quantity of milk is gradually reduced, and Henri's food is given. Hay follows, with 1 lb. of linseed-cake daily, or its equivalent." Henri's food is largely used in Leicestershire in rearing calves, which seem to derive benefit from the mixture of an aromatic stimulating ingredient with the nutritious meal.

Here is the receipt of a dietary given in somewhat more detail:—6 quarts of new milk daily for fourteen days from birth, and for the next six weeks 2 gallons of skimmed milk, warmed and mixed with  $\frac{1}{2}$  lb. of linseed-cake,  $\frac{1}{4}$  lb. boiled linseed, and  $\frac{1}{2}$  lb. split beans. To these approved receipts I will add one which Mr. Henry Ruck has laid before the Chamber of Agriculture at Cirencester. Calves are reared on Mr. Ruck's principle with little or no milk after the first fortnight. His plan may be thus described:—

"Seven lbs. of finely ground linseed-cake is dissolved in 2 gallons of hot water, and to this is added 2 gallons of hay-tea; 7 lbs. of mixed meal, consisting of equal parts of wheat, barley, oat, and bean-meal, is also added with 2 gallons of water. This mixture, which may be described as 7 lbs. of linseed-cake ground fine, 7 lbs. of mixed meal, 2 gallons of hay-tea, 4 gallons of hot water, is given to the calves as follows:—2 quarts in the morning, further diluted with 2 quarts of water, and 2 quarts mixed with 2 quarts of water at night. Upon this gruel the calves thrive well, and they are weaned from it at twelve weeks old, having cost not more than from 1s. 3d. to 1s. 6d. per head per week. Mr. Ruck is fully convinced of the practical method of weaning calves just described, but insists upon the importance of strict personal supervision and attention to the wants and peculiarities of appetite of each calf."

On this last point I agree with him entirely, and consider his mixture valuable and worthy of attention; but I should prefer approximating his plan to Mr. Carrington's, and suckling with new milk for three or four weeks, with skimmed milk afterwards, as "a much safer food," safe until three or four months old.

After the above, the reader will probably conclude that calves are best weaned with new milk for several weeks. All changes of diet should be effected gradually. Suppose new milk has been used for two or three weeks, one-third of it may then be omitted and replaced with skimmed milk which has been boiled and allowed to cool to the natural temperature of new milk. In another week the quantity of the new milk may be further reduced, and boiled linseed added to the skimmed milk: 5 lbs. of linseed will make 7 gallons of gruel, and when the whole of the new milk has been omitted, this quantity of nutriment, or its equivalent in some other form, will prove sufficient for five calves, in addition to skimmed milk. The food should be given



twice a day, and a good feeder, having taught the calves to suck, will feed twenty in a convenient building. The stomachs of calves are particularly delicate, and the food should be carefully prepared. It must not be burnt or sour. The hay must be sweet. The calves must lie dry and warm, in a cool well-ventilated shed in summer, and in lots of not more than half a score, so as to avoid the disease occasioned by their habit of lying in a heap and inhaling each other's breath. Moreover, if the animals are to attain the earliest possible maturity, they must remain at all times in their sheds, placid and undisturbed. They must not be turned out for exercise either in summer or in winter. The experiment was tried of keeping one lot in and turning another on the best grass during the most favourable period of the summer; and there could be no doubt as to the result. Whenever the two lots of animals were compared together, those were found to be doing best which were shut up in a shed. And, at the end of the summer, they were worth about 30s. each more than the out-door cattle; the feeding having been the same, except the difference in the fodder.

Mr. Joseph Blundell, of Southampton, set an early example in the production of "baby beef" in South Hants in 1857, and read a Paper on the subject before the Royal Agricultural Society, June 18, 1862. The following is his treatment:—

"My calves are weaned at a few days old, fed with new milk at first, gradually introducing with the skim-milk, linseed-cake, meal, and barley-meal, with a little sweet meadow hay for a time in the rack allowed them until they can safely take to green fodder, which they get in succession—first rye, second trifolium, third clover, with a portion of old mangold, then early turnips. To commence the winter they get hybrid turnips, carrots, or swedes; and lastly mangold, until the green fodder comes in again, being supplied with clean fresh oat or barley straw always in the rack whilst feeding either on green fodder or roots, the portion not eaten being removed for littering the boxes daily. As soon as they begin to take green fodder they are allowed a small portion, say 2 lbs. of cake-meal per day, mixed with the old mangolds, which are cut with Gardner's turnip-cutter. As soon as root-feeding commences they get 4 lbs. of cake per day, and continue to receive this quantity until they are sold at 18 to 20 months old; having, however, during the last three months 1 lb. of bean or barley meal extra; but at no time after they once take to their green food are they allowed hay, as this would be found to absorb the profit and injure the health of the animals also, for since I adopted the method of straw-feeding I have never had an animal hoven or unhealthy. The quantity of roots given the first winter is 56 lbs. per day; the second autumn not more than 64 lbs. per day, the meal being always mixed with the cut-roots: in this way each kind of food is more beneficial to the animals, and when only fed twice a day they have plenty of time to lie down and digest their food, and will return to the troughs with a good appetite, and will eat a good portion of clean straw."

Mr. Blundell has frequently obtained prizes for young stock at the Easter Cattle Show of the Botley and South Hants Farmers'



Club, and has published one instance of a first-prize Shorthorn heifer which he sold to Mr. William Lunn, of Southampton, at 18 months 3 weeks old, weighing 98 stone 6 lbs., with a great weight of fat inside.

In reporting on the farming of Surrey, in 1870, for the Bath and West of England Society (having previously reported upon it in 1854 for the Royal Agricultural Society), I described the example-farm of Mr. Cyrus Ellis, of Great House Farm, Hambleton, who was then, and still is, a producer of young beef on a Surrey sand farm. The soil generally is extremely thin. High Down, on the east side of the Farm, is a sandy heath which still defies the plough and can never be conquered but by a powerful combination of tillage and manure. Mr. Ellis has at the present time carried on his operations quite as far up the High Down as he can do with profit. He can do nothing without dung. The poor iron-sands of Surrey soon tell upon the pocket when mismanaged, which they easily may be in regard to the system of manuring. Artificial manures, for example, must be sparingly used on the poor sand. Mr. Ellis finds that superphosphate of lime starts the young turnip-plants, but does not enable them to hold their growth. Nitrate of soda must be used moderately; and, in short, after closely questioning his land on the best method of manuring it, the response is favourable to bulky rather than concentrated dressings. One-fourth of his land is in roots fed off by fattening sheep, or consumed by young bullocks. There are 6 cows; and 30 calves are annually purchased for early fattening. The usual number of sheep wintered and fattened on the farm is  $1\frac{1}{2}$  per acre, besides almost half a store-lamb per acre wintered on turnips and kept through the summer on forage-crops. The effect of the cattle feeding is clearly seen in such results on land so thin. And possibly Mr. Cyrus Ellis might not have kept to the front as a distinguished member of a family noted for good husbandry if he had paid high prices for store-cattle instead of rearing calves at home. He and others in his neighbourhood still continue the practice here described.

The following is extracted from the report referred to above; —“By the plan of early fattening, Mr. Ellis avoids summering the cattle a third season, and gets rid of a difficulty which is always severely felt on the sand farms, of maintaining any considerable head of stock in the summer. The calves are allowed to run out in the arable fields as soon as the rye is ready for them: afterwards they get cake in the pastures. The 30 fattening bullocks are started on early turnips by the middle of September.” \*

\* ‘Journal of the Bath and West of England Society and Southern Counties Association,’ vol. iii. third series, p. 15.

There seems to be no reason why, on purely arable farms, cattle should not be continuously as well fed as sheep. On mixed arable and grass farms young cattle can be kept more advantageously the first and second years on the pastures, to be fattened in the third year at about  $2\frac{1}{2}$  years old.

A few examples may be quoted from farms which I recently visited, and reported upon in 1870, and again more recently. Mr. W. M. Stanford (who farms his own land), of Broadbridge Farm, near Horsham, avails himself of his 105 acres of meadow and pasture on the banks of the River Arun. He has increased the breeding-stock since 1870, and has now a herd of 70 or 80 Sussex cattle of all ages, fattening his home-breds on the pastures during the third summer, and finishing them in the stalls. At the end of May I found the cows on two-year-old "seeds," with calves by their sides, their own progeny, except in the case of the heifers whose offspring, born in December, had been already weaned. A heifer rears her own calf, dropped early, and three months later she takes the calf of another cow. The first-born calves were waiting in yards for their pastures and summer run. They had been early taught the use of cake, hay, and mangold. They get 1 lb. of cake daily till winter, and then 2 lbs., with half a bushel of roots and a small quantity of hay and straw. In their second year they are put on good grass in spring, when the cake is taken off; and the following winter they receive, at nearly two years old, 2 lbs. of cake daily, 1 bushel of roots and hay once a day, with uncut straw from the rack twice a day. This brings them to the third season, when they are put on good grass as before. In July they begin to get cake; 3 lbs. daily, increased to 6 lbs. at Michaelmas, when they are stalled. This feeding is increased to 9 lbs. of cake and 3 lbs. of bean-meal for the last six weeks. The average weight at Christmas, at the age of 2 years and 10 months old, is 130 stone. On such a farm as Broadbridge, with its feeding-pastures, that is no doubt the right management, and the description may be regarded as an appropriate commentary.

Messrs. Drewitt and Son, of Piccard's Farm, near Guildford, furnished me with all possible details, and placed their sale-books before me. The cows on their farm each rear two calves, and feed them entirely from March or April till July or August, when they are weaned on the rowans, and get  $2\frac{1}{2}$  lbs. of linseed-cake each daily. In October they are removed to the yards, and wintered on the same allowance of cake, with one-third of a bushel of swedes or mangolds daily, straw, and rough hay. After their second summer—on pasture with the same cake—they are prepared for the butcher, with  $1\frac{1}{4}$  bushel of roots daily, 5 lbs. or 6 lbs. of linseed-cake for three months, and after-

wards at the finish, 5 lbs. or 6 lbs. of pea- and barley-meal in addition. The following figures show the weight at a little more than two years old. In 1871, nine calves bought from the West country, at a week old in March or April 1869, were sold at 6s. per stone to Mr. Colebrook, butcher, Guildford. They weighed: May 23, a steer, 108 stone, 5 lbs.; a heifer, 100 stone; May 27, a steer, 117 stone, 1 lb.; May 29, a steer, 106 stone; a steer, 101 stone, 7 lbs.; June 5, a steer, 97 stone, 1 lb.; June 7, a steer, 122 stone, 2 lbs.; June 26, a heifer, 79 stone, 9 lbs.; June 29, a steer, 115 stone, 4 lbs. The heaviest of these cattle was just 105 weeks old.

In June 1872, the crop of 1870 was sold at the same period of the year at 5s. 7d. per stone, and an average weight of 94 stone. In 1873 the price was 6s. 8d., and the average weight 95 stone. In 1874 the price was 6s., and the weight 100 stone; the bullocks in this case being the offspring of good-sized Shorthorn cows kept at Aldershot. The price of calves during six years varied from 35s. to 50s. each. In using Devon bullocks, Messrs. Drewitt have found them smaller consumers of roots than Shorthorns, and their experience coincides with that of their relative, whose system is next to be described.

Messrs. John Drewitt and Son farm largely at North Stoke, in the gorge of the River Arun, where it passes through the South Downs to the sea. The herd is a cross between the Devon and Sussex, a comparatively small sort, which does not tread through the turf of the river-side meadows. The management is as novel as it is successful. The young cows on this farm receive the bull at fifteen or sixteen months old, and during three years in succession they take their calves on the meadows. They are fattened after the third year. The system is suited to the spot and to the breed, and has the advantage of involving scarcely more labour than a dry herd. In summer the herd numbered 8 cows over four years old; 20 three years old; 22 two years old; 27 steers two years old; 18 yearlings gone to bull; 41 yearling steers and 5 heifers, and 71 calves, with 3 bulls. These were all on the grass on June 26, except the bulls and a few young calves. Ten of the oldest heifers were to be finished in the stalls at Christmas, and the remainder in the spring.

In addition to the 240 acres of flooded meadow and 20 acres of dry pasture, there is an arable farm of 450 acres, and 220 acres of down; and other cattle, besides the home-breds, are fattened. I am describing, however, the system, and not the farm. The breeding-heifers and steers rising two years old are wintered on straw, half a bushel of swedes or mangolds, and 3 lbs. or 4 lbs. of rape-cake or cotton-cake. The period of calving is between September and April. The system has borne the test of twenty

years' trial, and its principle appears to rest on the avoidance of the risks and costs of purchase. The three calves produced by each cow are the compensation for the wear and tear of maternity. In all probability the drawback attaching to a breeding-herd in this respect is less in the case of these cows than it would be with deeper milkers; and Messrs. Drewitt's mixed Devons and Sussex (a beautiful and meat-making herd) are, no doubt, admirably adapted for his purpose. They are of moderate size. Other sorts of cattle may produce mountains of beef, while these yield only hills; but the cost of production is the main point.

Mr. J. B. Lawes has shown, by a series of experiments at Rothamsted, that well-bred Shorthorns, Devons, or Herefords, consume food and make meat in proportion to their size; and Messrs. Drewitt's experience has led them to the same conclusion.

During an interesting correspondence in the 'Agricultural Gazette' on the subject of "Two-Year-Old Beef," a number of letters appeared from practical men describing their management. Perhaps the following may be added to my other examples, as showing the varieties of management in the north of England:—

"Since such prices as 18*l.* and 20*l.* a head for lean oxen came into vogue, there have been considerably more calves reared in Roxburgh and Berwickshire. The cows kept are generally selected more on account of their milking capabilities than for their pure breeding, and are mostly Ayrshires and crosses of that breed with the Shorthorn. On those farms where it is the custom to rear calves, a good useful Shorthorn bull is kept, not always of high pedigree, but that, too, is being more sought after than formerly; the hinds' cows and those of the neighbours being served on the condition that the owner of the bull shall have the first offer of the calf. The cows calve from February till May, and the calves, with plain diet, certainly without pampering, are fed off at 22 to 24 months old, as the case may be, and oftener than not do not taste oilcake the last season till three months before they are sold—50 to 60 stones (of 14 lbs.) are the usual weights. There are more calves reared in Northumberland than in both the before-mentioned counties put together; the breed of cattle—generally Shorthorns—is much superior; but here, in the southern part of the county, the practice of feeding at two years old has only obtained during the last 20 years. When that is the object in view, it is a great point to have early spring calves, not later than April if possible. It was the practice on Tyneside to keep on an average-sized farm, say 200 to 300 acres, a dozen or more fine heavy Shorthorn cows, and, rearing their calves, to feed them off on grass the third summer. That was the plan when the bare-fallow system was pursued, and fewer turnips grown than nowadays. Great attention was paid to the breeding both of sire and dam. Latterly it was found that it paid better to buy Irish cattle, which were to be had good of their sort at low prices, and so it came to pass that on many farms the Shorthorns, the breed of which had descended in the family from father to son, gave place to two or three come-by-chance Irish cows, just kept to provide milk for the farmhouse and the cottagers. However, since the great rise in the price of lean cattle, the old system of rearing a part and buying in the remainder of the cattle fed has been recommenced; indeed, in many cases, it had never been entirely

given over, and there are not many districts that could turn out the number of fine and even high-pedigreed Shorthorns that Tyne can do yet. On this farm—about 500 acres arable, and 60 of old grass—I feed annually about 80 cattle on turnips; one-half Shorthorns and crosses reared on the place, and the remainder Irish heifers bought in during the summer, in July and August. Sometimes a few of these turn out in-calf, of which more anon. Eight milch-cows are kept, and two sets of calves reared; one dozen early ones, and another lot later on, when the first can do with gruel and skimmed milk. They get new milk for one month, then half new and half old, with linseed-gruel for another month or more, if milk can be spared; and then the later lot get all the skimmed milk till harvest, which helps them up with the older ones to make a more level lot. During the summer they graze in a small paddock, and have a shed to go into. When still very young they are trained to eat a handful of oilcake and crushed oats, and often, though not always, they get a serving or two per diem of cut grass or tares. As autumn advances the allowance of cake is gradually increased to 2 lbs. each, and when the nights begin to get chilly a little meadow-hay is put into their racks at nightfall. The first winter they are allowed two small feeds of white or yellow turnips per diem (not nearly so many as they could eat), 3 lbs. of oilcake, which keeps the blood healthy and prevents quarter-ill, and as much oat-straw or chaff as they can consume, but none to waste. During summer they are grazed among the sheep, and are brought into the yards and boxes in the latter part of October in good holding condition. For the first fortnight a few turnips with the leaves on are spread about the pastures, and, if at all conveniently near the steading, the cattle are brought into the courts at night and get a fill of oat-straw and a warm bed. The turnips are given sparingly at first, for fear of scouring; the bite of grass in the field by day and the oat-straw at night in the fold both help to tide them early over the change of food. Before Martinmas they are fairly housed for the winter; the home-bred stirks being acquainted and quiet with each other in the folds, and the strangers in the boxes. Very often the bullies and simpletons have to be withdrawn from the folds, and accommodated with single boxes also. As long as the white and yellow turnips last, generally up to the new year, 4 lbs. of cotton-cake is allowed, and after that 6 lbs. of a mixture of oilcake, crushed beans, light barley, &c., with three moderate feeds of swedes, and two fodderings of oat-straw or barley-chaff per diem. One great point is never to allow the stirks to lose their calf-lyre, and keep them steadily growing and improving; if this be done, there is not the slightest difficulty in bringing them out on an average 60 stones weight (of 14 lbs.) at 22 to 24 months old in April and May. There are always a few Irish heifers turn out in-calf. These suckle their own calves for a month or five weeks, and can generally make them worth 3*l.* to 3*l.* 10*s.*, which sum will procure a good Shorthorn calf, two to three weeks old. With very little trouble the cow accepts her changeling, and if it has fortunately happened that she has calved early, and this is all managed before May-day in the house, then they are ready to go out when the grass comes, and the handling tames and quiets the calf, so that it does not turn out the 'wild runner' of former times. They are grazed on old grass, and get 4 lbs. of cotton-cake each day. The calves suck till February, and last year were sold in May, 13 months old, at 24*l.*, and the dams at 27*l.* Taking into consideration the little keep required for the calf the first six months, it will be seen that no system of feeding pays better than this; but it can only be followed out to a limited extent. A few years ago I turned out a half-bred Irish calf, which sucked 12 months, at 19 months old, 72 stones (of 14 lbs.) weight, and the beef was most beautiful, not at all vealy, as some might suppose. This is only plain ordinary management; I could not pretend to calculate quantities of food and value thereof."

This letter from an experienced farmer in the North completes the subject of feeding. But a few words are required on shelter, and the building of the necessary sheds. Cattle cannot bear exposure. Sir John Sinclair, who introduced the Cheviot sheep into the north of Scotland, says of sheep and cattle in mountain districts, "For every pound of beef that can be produced in a hilly district, 3 lbs. of mutton can be obtained." Elsewhere the disparity is not so great; still bullocks require an amount of shelter, first and last, which the well-clothed sheep can dispense with. The cost of shelter, probably, and the want of the necessary buildings on most farms, have diverted attention from the early feeding of young bullocks. The question of buildings, therefore, is of prime importance. It may seem somewhat out of place to recommend home-made and cheap buildings in the 'Journal' of a great and national Society, which must properly desire to encourage the best agricultural methods; and it may be that the best built covered homesteads are the most economical in the long run. Still, in the absence of such buildings, a tenant may well consider whether he cannot erect sheds not unsuited to his purpose, and of a less costly description—such sheds, in fact, as a lease or covenants for the payment of their value at quitting may enable him to erect.

I have known farms in Surrey and Sussex with seven, eight, or even nine homesteads, and a barn or two at each. And some of these barns are now filled with calves and young fattening cattle, instead of corn, to the number of seven or eight in each large bay. When there is a wall the cost of shedding is reduced. If the entire shed has to be erected, the back and sides should be of oaken slabs, or, in some districts, they may be formed of the warmer materials, which will be presently referred to. The roof may be of poles, large enough to be once cut, and it must be securely thatched. Village carpenters are not much practised in the art of erecting cattle-sheds at the cheap rate that a 21 years' lease requires. Such a shed must be put up quickly, and the materials must be such as the neighbourhood affords—slabs, unplanned poles, and straw, heather, "chips" (in a hoop-making district), branches, faggots, or furze-bushes.

A friend of mine became a practical carpenter when thrown upon the world fifty years ago. Having risen in fortune above his former level—his father was among the best farmers in Sussex—he hired a farm for amusement near his native place, on a seven years' lease. Ten years since, I found him, with one old contemporary carpenter, engaged in the erection of some rough-and-ready farm-buildings. What he did for the money was surprising. He built an ample cart-shed for less than 5*l.*, and a fowl-house and several detached sheds at



the same cheap rate. These sheds all stand on strong posts, they are all well tied, the sides well stuffed with warm furze or heather, the roofs well thatched with straw. The skeleton of the buildings consists partly of deal, cut to the required scantlings at a metropolitan saw-mill, and generally of poles, purchased at the wood sales in the neighbourhood. They have stood out the recent gales on an exposed coast, and still promise to stand for many years. But if a master-builder or carpenter had been called in to put up these buildings, almost every bit of their material would have been rejected. There would have been sawing and planing and morticing on the spot; bricks, tiles, and lime, and artisans at 6*d.* an hour. This is all very good when the work is well organised and on a sufficiently large scale, and when the buildings are such as a landlord requires on his own fee-simple. But a tenant must be his own builder.

Mr. Stanford's buildings were erected by his foreman, who happened to be a clever self-taught carpenter. On every bit of wall he has put up a home-made shed, converting several yards, which were too cold for young stock or for fattening animals, into snug and populous quarters, full of life, industry, and manure-making, and completely sheltered from wind and wet. This was done by means of sheds made of stout Scotch fir-poles, tied with the bolts and irons of an old threshing-machine. The sheds are 16 feet deep, and are topped by roofs of furze, thatched by wheat-straw, at 15*d.* per square. As they are not built into the brickwork, they remain the property of the tenant, and for thirty years to come the thatched sheds which the foreman and farm carpenter built seven years since, at the cost of a few pounds, may still be filled with cattle at various stages, provided the buildings are occasionally, and in good time, retouched and restored.

I now come to the question of profit.

At the recent sale at Charlton Court the following were the prices and returns per week of the young bullocks, the top price of beef at that time being 6*s.* 2*d.* per stone, according to the quotations at the next metropolitan market:—

	Guineas.	Return per Week.	
		<i>s.</i>	<i>d.</i>
11 months old Shorthorn steer .. ..	16	7	0
13       "       "       steer .. ..	22	8	3
14       "       "       heifer .. ..	20	7	0
15       "       "       heifer .. ..	22	7	1
16       "       "       steer .. ..	27½	8	4
18       "       "       steer .. ..	25	6	9
18½     "       "       steer .. ..	28	7	4

There were several other beasts sold at prices nearly equal to the above, and included in the following analysis of results:—

One at 11 months gave 7s. per week from birth; one at 13 months, 8s. 3d. per week; three at 14 months, 7s.; three at 15 months, 7s. 1d.; six at 16 months, 6s. 10d.; and two at 18½ months, 7s. per week. A 2½-year-old Sussex steer returned 6s. 3d. per week, and a 2-year-old, 7s. per week. These were both from a famous herd. Those Shorthorns which afforded the least return were calves bought in the market; and those which gave the highest were by Mr. Stanford's pedigree bull, out of his own well-bred but not pedigree cows.

The above figures show that tolerably bred Shorthorns will return 7s. a week from birth on this system, at from 13 months to 18 months old.

The best feeders of common country-bred cattle in Sussex and Surrey inform me that they consider a fair average weight for animals well fed from birth is 100 Smithfield stone at 100 weeks, giving a return of one stone per week, or 6s. per week. At the sales I have quoted, Mr. Stanford obtained 6d. or 1s. a week more for two-year-olds fattened from birth; and a "plum," killed by Mr. Page, of Partridge Green, gave 8s. per week, *i.e.*, 132 stone at 100 weeks. Mr. Glazebrook, of Shoreham, slaughtered one of the bullocks from Charlton Court, a 16 months old steer, weighing 76 stone 2 lbs., and yielding 15 stone of loose fat. There was very little offal.

These animals were not pure-bred heavy-fleshed Shorthorns, which are rarely seen in Sussex, but common cattle, such as the Brighton dairy cows produce. The returns are 6s. 6d. per week; and similar returns, which cannot but leave a profit, might be obtained under this system with the same class of cattle; and 6d. or 1s. a head per week more with pure Shorthorns.

The following is an estimate of the cost of a young bullock at seventy-one weeks old, or one year and nineteen weeks:—

	£	s.	d.
Purchase of a calf .. .. .	2	0	0
Four weeks new milk, 6 quarts daily, at 2d. per quart .. .. .	1	8	0
Eight weeks skimmed milk, 6 quarts daily, at ½d. per quart, and 2 lbs. meal, at 1¼d. per lb. .. .. .	1	5	8
Seventeen weeks in June, July, August, and September on a daily diet of 2 lbs. linseed-cake, 2 lbs. bean-meal, mangel, hay, grass, clover, &c. .. .. .	3	19	4
Twenty-six weeks to end of March, 5 lbs. cake and meal daily, ¾ bushel of roots, hay, and straw, for fodder .. .. .	6	16	6
Sixteen weeks to harvest, 8 lbs. cake and meal daily, mangel, grass, clover; total 7s. 2¼d. a week .. .. .	5	15	8
Attendance, 71 weeks at 6d. .. .. .	1	15	6
Insurance, Interest, and Rent of Shed .. .. .	1	5	0
	<hr/>		
	24	5	8

On this estimate the young bullock, born in spring and sold at harvest in the following year, costs a little more than 7s. a week, and he should be worth, according to Mr. Stanford's average return of 7s. per week, 24l. 11s. The value of the manure may be fairly estimated at 20 per cent. on the cost of the food (19l. 5s. 2d.), or 3l. 17s. Our balance-sheet therefore stands thus:—

<i>Dr.</i>		£	s.	d.
	A bullock 71 weeks old .. .. .	24	5	8
	Profit .. .. .	4	2	4
		<hr/>		
		28	8	0
 <i>Cr.</i>				
	A bullock sold at 71 weeks old .. .. .	24	11	0
	Value of manure , .. .. .	3	17	0
		<hr/>		
		28	8	0

I have claimed 20 per cent. on the value of the dung of corn-fed animals fattened under cover. The theoretic value of the manure derived from the above different articles of food is: decorticated cottonseed-cake, 6l. 10s. per ton; rape-cake, 4l. 18s. 6d.; linseed-cake, 4l. 12s. 6d.; beans, 3l. 14s. My estimate of 20 per cent. on the cost of the food, as the value of shed-made manure, will not be thought excessive by practical men. Mr. Hudson, of Castle Acre, who paid from 2000l. to 3000l. a year for cake and other "feeding-stuffs," and brought 1200 acres of poor thin soil into a state of great fertility, would not have thought it excessive; nor would the incoming tenants of Lincolnshire, who pay half the value of the cake used the year before; nor would the late Mr. Clutton of Reigate, who raised the value of his pastures from 20s. to 50s., by feeding them with linseed-cake; nor would any person who knew Charlton Court Farm when Mr. Stanford hired it, and afterwards on his quitting. He had doubled his flock, leaving about 600 ewes on a farm of 700 acres; and he had done this by means of the "condition" put into the land by the use of oilcake, and the constant succession of forage-crops and "snatch" crops. It is difficult to see how this result could have been accomplished under any other plan on a breeding-farm situated on the north front of the South Downs, and ill suited for the folding of fatting sheep. One of his feeding-places was an old-fashioned double barn, an extemporised manure-factory, situated half-way up the hill, where the dung was most required. Another of the advantages of the site was the isolation of the animals in the event of contagious diseases appearing on the farm.

Persons unacquainted with this system of rearing and feeding cattle have imagined that the risk must be great. On the con-

trary, those who understand the process have found that the risk of loss is reduced to a minimum under the rapid system of treatment. Mr. Stanford's losses in some years have been *nil*; and he has found the risk of life less generally in proportion to the shorter existence of the animal. As a rule, and mainly for want of proper buildings, skill, and capital, cattle are not brought to the same early maturity as sheep. It is not generally recognised that cattle should weigh five times as much as sheep at from twelve to twenty-four months old, when they have been fed as well, and sheltered. Skilful feeders are aware that "beef makes beef," and they never allow their cattle to become poor. The feeder of young cattle has them always ready for the butcher from three months old. It is true, no doubt, that animals which are cheaply fed at little cost of food or labour may improve but slowly, and yet prove remunerative; but in artificial feeding the process must be quick. The body must be built up rapidly by an excess of food beyond that required to support the wear and tear of life; and the greater the supply beyond that quantity the smaller the waste. In theory, therefore, an animal could not be over-fed. Mr. Loudon remarked that the process of fattening was analogous to the filling of a cask with a hole in the bottom, since the faster you pour in the liquor the sooner will the tub be full, and the business concluded. The feeder, however, must exercise his skill in regard to the limited powers of assimilation, the age, and the state of the animal. Young beasts, fattened from birth, will grow and make flesh more rapidly before than after two years old, and they yield the best profit when slaughtered at eighteen or twenty months old. Cattle which are not to be killed until after the age of two years would, perhaps, be more profitably summered on pastures, provided that they exist and are sufficiently good for fattening cattle, which is rarely the case in Surrey and Sussex.

Another point which must be mentioned is the superiority of old mutton and mature beef. The quality of all meat, however, depends greatly upon management and the mode of feeding. English bacon, fed chiefly on barley-meal, is superior to that fed on beans or on maize. American bacon, fed entirely on maize, shrinks in boiling, and the rasher is oily and indifferent. Beef is also affected by the feeding, and it is not the fact that young beef is always poor. Mr. Port, the butcher, of Ship Street, Brighton, who supplies a superior class of customers, writes of some bullocks from Charlton Court, purchased Jan. 12th, 1874, at 19½ months old, and weighing 100 stone 4 lbs., 94 stone, 92 stone, and 90 stone: "These bullocks when slaughtered were most complete bodies of beef, and the meat gave every satisfaction to the consumer, being very tender, and

of delicious flavour." Mr. Port says of another lot: "I bought of Mr. W. Stanford, at Steyning market, on March 9, five very superior Shorthorn steers under 20 months old, with calves' teeth. Their meat is of most excellent quality. The heaviest weighed 111 stone 4 lbs. The flesh on the ribs, where quartered from the loin, measured 5 inches thick." As this part of my subject is important, Mr. Port may be allowed to say further: "I have, during the last three years, killed a large number of the young bullocks fed by Mr. Stanford;" and he then gives a favourable opinion of their weight and quality. A young steer which I had seen, and which was bought at the sale on June 7, is reported as having been "full of fat, with large, thick flesh, and finely grained, and of very superior flavour." Mr. Duke, of Steyning, writes of some bullocks under 20 months old: "They were all remarkably ripe handsome carcasses of beef, giving me and my customers great satisfaction, as they have always done. They carried an average of 12½ stone of fat." Mr. Glazebrook, of Steyning, writes: "Some of the buyers at the sale considered I had given a guinea a bullock more than 6s. per stone, but, from the experience I have had of Mr. Stanford's young beasts, I had confidence in them."

These details are important. They show that young beef need not be unripe, that it need not shrink unduly in cooking, and need not be innutritious.

In concluding this short paper, I may point out that if cattle can be reared and fattened with advantage on Surrey sand-farms and bleak chalk hills, there must be many farms of 200 or 300 acres which do not at present raise cattle, and which might easily maintain from 4 to 6 cows, and fatten 20 or 30 bullocks on the system I have described. Even on those farms where sheep are the carriers of fertility, the straw must be converted into manure, and cattle of some kind must be kept, I would introduce a cow or two per 100 acres, and convert the produce into young beef.

Most Surrey farms are provided with a few favoured paddocks, where good turf has been carefully nursed; and the same remark applies to the compact clays of the Weald of Sussex, which are equally unkind to grass. In both counties the extent of grass-land does not often exceed 5 acres in the 100, and upon the clays, at any rate, it might, in the present period of increased expenses, be profitably increased. Laying down grass-land on compact clay costs 10*l.* per acre. I have seen many attempts to cover such land with good turf, and some of them proved failures, while others were successful. The expense in all cases would preclude the possibility of those sudden conversions of arable to pasture which the dairy-farmers in Staffordshire have

effected on the loams and friable marls of the New Red Sandstone, where a yearly tenant of 300 acres has sometimes sown 40 acres or 50 acres with grass in a single year, and seen it grow into good turf in five or six years, without special or expensive farming. Young pasture in the Weald must be carefully nursed till the ground is well covered with sod, and the seeds should be sown on land well fallowed and heavily manured. There are several methods, and the objects to be attained in each of them are to have the land clean and full of condition at the time of sowing, and to sow at the end of summer on a stale surface. Foul land may be sown with tares for folding, and then deeply ploughed, or smashed up with the steam cultivator, to lie through the winter; or it may be sown with the most approved root-crop (early turnips, perhaps), and folded before Michaelmas, and then laid up with a deep furrow for the winter. Or a clean stubble may be selected. But in any case deep cultivation in dry weather should precede the winter previous to sowing the grass. The land should then be heavily manured during hard frost with well-prepared dung, which need not necessarily be ploughed under in spring. A capital piece of turf was lately formed on poor clay after very deep cultivation and winter manuring, without subsequent ploughing. In the absence of deep-rooted weeds, the land was kept clean by surface cultivation till July. A great deal of raw yellow clay had shown itself at the surface, but the manure, frost, and protracted weathering, from October till July, corrected this ungenial earth, and the seeds were sown in this last-named month in a firm but not a hard-bound surface of fine mould. The young plants grew vigorously. They were manured in winter, and presented a most promising appearance in spring, tillering well, and producing stout, strong stems, with vigorous roots, which had laid well hold of the ground. The grass was mown the first summer, lightly fed with cattle in autumn, and again manured the following winter.

If a piece of turf is required for carrying out the plan of home-grown beef, either as a run for the calves or cows, it can be obtained quickly, at a cost of two years' rent and plenty of manure.

---



VII.—*Report on the Pathological Anatomy of Pleuro-pneumonia.*

By GERALD F. YEO, Professor of Physiology in King's College, London.

INTRODUCTION.

THE difficulties which present themselves in attempting to study the pathological anatomy of the diseases of cattle are increased in the case of pleuro-pneumonia by the legal restrictions which compel the slaughter of beasts affected with it. In most instances the animals are slaughtered suddenly, by order of the authorities, allowing no time for notice to be sent so as to enable one to reach the scene of action. It is therefore only by means of the combined kindness of a number of disinterested persons that a *post-mortem* examination can ever be witnessed, and then only at the expense of much time and trouble spent in reaching some remote locality. Moreover, the inspection of the autopsy but poorly repays the personal inconvenience which must be gone through in order to attend it, for the slaughter and evisceration of the animal must always be conducted by some practised operator, whose dexterity depends upon his rigidly adhering to a certain methodical system, which is not framed with a view to pathological investigation. The necessary operations are performed with such skill and rapidity, that no time is allowed for the pathologist to contemplate the relative position of the morbid parts, or to reflect on the possible pathogenic relation which one may bear to another.

It is a well recognised fact that in order to make a description of the pathological anatomy of any disease at all adequate, or of scientific value, all the viscera should be examined in every case, so that the most trivial abnormality may be noted. In the lung disease of cattle this may be regarded as impossible. Besides the difficulty of attending the slaughter of the beast, the enormous bulk of the material—the diseased lungs alone often weighing 30 lbs.—in the majority of cases renders the thorough investigation of all the viscera quite out of the question. Fortunately, in pleuro-pneumonia this does not seem at all necessary, because the abdominal organs do not present any changes which can be looked upon as either constant or characteristic of the affection.

The nervous centres have never been examined, because it is necessary, the instant the animal is knocked down, to destroy the spinal cord and the brain, so as to prevent the energetic reflex movements of the limbs which would otherwise accompany the skinning, and prove dangerous to the operators.

There are, then, in studying the diseases of the lower animals, many difficulties which balance the one advantage, of which we often hear, namely, that of being able to kill the beast at any time, and thus find out the steps in the morbid changes which correspond to the various stages of the disease. Practically, in the case with which I have to deal, this advantage is but little felt, for there is really no control over the time of slaughter, and there seems a clinical difficulty in ascertaining how long the disease has lasted, so that the exact stage it has reached cannot be known until the animal is killed.

These difficulties doubtless explain the great paucity of scientific literature on this subject, and the complete want of any adequate scientific explanation of the progress of the disease. The following references may suffice to give some idea of the present standpoint of our knowledge of the subject.

The first accurate description of the morbid anatomy of pleuro-pneumonia that I have been able to find, is given by F. Weber,\* and, as far as the description of the appearances of the diseased lungs is concerned, this paper has not been surpassed by any since published, that I know of. He calls the disease *interlobular pneumonia*, and attempts to explain its development as a form of chronic inflammation of the tissues between the lobules. Though he recognised that there were different kinds of consolidation, he appears only to have submitted one of these varieties to minute investigation, otherwise his clear reasoning would not have led him to the conclusions which he announces in his paper.

He says that examination of the diseased lung gives two negative results:—

1. There is no trace of croupous exudation in either the large or small bronchi; the mucous membrane in the larger ones is perfectly healthy; in the smaller tubes a mere trace of catarrhal injection can be detected.

2. In the lung tissue itself the air cells are filled with fluid as in œdema, and not with solid exudation.

From these results he concludes that the tissue of the lung is in a state of œdema, not hepatisation.

With reference to the starting-point of the disease, he says, "I now pass to the beginning stages, which give the clearest proof that the interlobular connective tissue, and the pleura, are the real seat of the disease." The other parts, he thinks, become secondarily affected, the exudation causing a kind of strangulation of the lobules, which gives rise to hyperæmia, pulmonary apoplexy, serous infiltration, and (very rarely) hepatisation.

The connective tissue of the lung, then, he considers to be the

---

\* Virchow's Archiv., Bd. vi. p. 89.

part affected by the disease, which generally begins under the pleura but also occasionally in the deeper interlobular tissue.

He distinguishes two forms of this interlobular pneumonia. One wide-spread and diffuse, extending over an entire lung. The other, which attacks a small, sharply bounded part of the lung, like lobular pneumonia. These occur with equal frequency, and he expressly states that their difference merely depends on extent and anatomical arrangement, their mode of origin being identical.

Klebs\* describes one case in which he found good examples of vascular plugging. He thinks the disease resembles in most respects ordinary pneumonia, but can be distinguished by the coagulation in the vessels.

Röll† considers that this disease corresponds with the interstitial pneumonia of other animals. The first steps, he thinks, occur in the connective tissue between the lobules, most commonly in the deeper parts of the lung. This tissue becomes congested, and a serous exudation takes place into it, which greatly swells the interlobular spaces. The congested pulmonary parenchyma is thus pressed upon, and ultimately becomes quite airless. The serous fluid more rarely fills the air-cells themselves, and still more unusual is the occurrence in them of the firm exudation of ordinary inflammation. He describes the various secondary lesions which may arise in the course of the disease, and amongst them he mentions bronchial and pleural inflammation.

Bruckmüller‡ considers the pleuro-pneumonia of cattle to correspond exactly with ordinary pneumonia of other animals, the peculiar construction of the lung sufficiently accounting for the peculiarities in the pathological anatomy of the pneumonia of bovine animals.

“There is only one form,” he says, “of inflammation of the lung in cows, and this is always associated with very striking changes in the interstitial tissue.” He describes the disease under the title “croupous interstitial inflammation of the lung,” and he says, “If we compare the pathological products which arise in the lungs of cows affected with pleuro-pneumonia (*Lungen-seuche*) with the products of inflammation of the lungs in other animals, we can find no real difference.” He denies its specific nature and its contagiousness, but says it is a good example of an infectious complaint.

The scientific pathology of this disease has not been studied in England with great care or success. The morbid appearances

\* Virchow's Archiv., Bd. xxxviii. p. 326.

† Lehrbuch d. Pathologie u. Therapie d. Hausthiere. Wien, 1860.

‡ Lehrbuch d. Path. Zootomie. Wien, 1862.

are very easily recognised, and no energy was required to master the anatomical details, since any one can recognise the disease *post-mortem*. Therefore the English school has neglected this department of study, having preferred to go into the wider field of theoretical speculation in order to determine the cause of the disease.

Professor Brown,\* in an admirable brochure on the subject, gives a very clear sketch of the disease, and well describes the most striking morbid appearances. As to the exact essence of the disease, he says :—

“Pleuro-pneumonia is essentially determination of blood to the lungs, and exudation of liquor sanguinis, that is to say, blood deprived of its red particles, into the connective tissue which is everywhere distributed throughout the lung structure, existing abundantly between the lobules and on the surface of the lungs under the pleural membrane. Exudation occurs also on the surface of the pleura, but the chief deposit takes place under it, and causes its elevation from the lung tissue just as the exudation between the lobules causes them to separate from each other.”

And again he says :—

“Inspection of those organs of the animal body which are principally implicated in the disease (the lungs), however minute and complete it may be, only puts us in possession of a knowledge of effects. It is evident enough that the lungs have received an excess of blood, and that a large quantity of the circulating fluid has been exuded into the tissue of these organs; but the really important question is, What circumstances conduced to these results? And the only answer which the pathologist can offer is contained in a somewhat vague reference to ‘blood poisoning.’ As in other contagious diseases the blood of the animal affected with pleuro-pneumonia becomes charged with some poisonous material, which is excreted by the vessels of the lungs: for example, in small-pox, the virus is excreted by the skin, and the poison of cattle-plague by the mucous membrane. In each case it is impossible to define the determining causes. We can no more understand why some of the constituents of the diseased blood are poured out in large quantity in the fibrous tissues of the lungs in pleuro-pneumonia than we can comprehend the ultimate cause of the distinctive eruptions in the various exanthematous diseases.”

Mr. Fleming † says, “Pleuro-pneumonia is a specific and contagious fever peculiar to bovine animals. In its essence it is a malignant fever allied to the general eruptive diseases.”

Professor Walley ‡ gives an elaborate account of the *post-mortem* changes of zygomatic pleuro-pneumonia. He divides the progress of the disease into three artificial and rather fanciful chronological stages. The general characters of the first being :—

“Increase in weight, bulk, and friability; diminution in resilient power, and consequently increased resistance to inflation, and decrease in crepitation

\* ‘Obs. on the Lung Disease of Cattle known as Pleuro-pneumonia.’

† ‘A Manual of Vet. Sanitary Science and Police.’ London, 1875.

‡ ‘Vet. Journ.,’ May, 1876.

on pressure; with deepening of colour, and the presence, occasionally, of ecchymoses or hyperæmic patches in the bronchial mucous membrane, and vascular stellate spots in the parenchyma."

He says:—

"The general characters of the second stage are:—A mottled appearance on section, increase of bulk, density, specific gravity, and friability; absolute loss of textural integrity, breaking up of the capillary vessels, and, as a consequence, parenchymal extravasation: obliteration of large vessels and small bronchia, with destruction of the thoracic lymphatic glands."

He thus sums up the characters of his third stage:—

"Absolute loss of integrity (death), with segregation of the injured lung; hyperplasia of contiguous interlobular tissue; and increased density of the surrounding parenchyma. If the destructive process is arrested, the conditions are: absorption of the red cells, consolidation of the parenchyma, hyperplasia of the interlobular connective tissue, restoration of the circulation, *grey or yellow hepatization*. In either case the changes in the bronchia and trachea are: ulceration of the mucous membrane, and consolidation of the submucous and extratubular exudate."

As an outline of its general pathology, he says:—

"We are justified in concluding that Zy. p. p. is a distinct and specific infection, and that, although the structures which have been injured by the localisation of its lesions, secondarily (unless dead) undergo inflammatory changes; primarily, the disease is a purely effusive one, *i. e.* in the initial shape, effusion—simply and purely—is the characteristic lesion; in the second and third stage, passive are accompanied, and finally succeeded, by active processes; and, in the subsequent changes, inflammatory processes alone go on."

The French definition of the disease is much the same. The most recent authority says:\* By this name ("peripneumonie contagieuse") is designated a virulent and contagious general affection, confined to bovine beasts; it is of epizootic character, and is accompanied in ordinary cases by local manifestations in the lungs and pleura, and by a fibrino-serous exudation into the interlobular connective tissue and the pleural cavity; an exudation which has been erroneously regarded as inflammatory.

#### NORMAL ANATOMY.

In some points the structural arrangement in the lung of the ox is sufficiently peculiar to demand a short notice, the more so since the peculiarities have, I believe, a very direct bearing on the mode of commencement and progress as well as the pathological characteristics of the disease.

The regional anatomy appears to be interesting only from a clinical point of view, showing, as it does, how difficult, if not impossible, it must be to recognise pneumonic consolidation

\* 'Dictionnaire de Méd. Vétérinaire,' t. iii. p. 74. Paris, 1877.

when the disease is localised to the anterior lobes, which are completely walled off from physical examination by the dense mass of solid parts forming the shoulder of the beast.

The number of lobes and their complete separation one from the other by means of deep fissures may tend to keep the disease isolated, but otherwise the descriptive anatomy teaches us little. In the larger air-passages the mode of subdivision is irregular, being seldom fork-like, as in the human lung. The trachea itself does not bifurcate until it has given off a large separate branch to the right anterior lobe. The lobar bronchi give off small lateral branches, as they run down sometimes beneath the pleura of the long slender lobes, and do not divide dichotomously. The mode of branching, however, is found to differ materially in different lobes, and appears to depend on their size and shape, those of the large posterior lobe dividing more like the air-passages of the human lung.

The blood-vessels follow the course and mode of branching of the air tubes; the artery and the vein lying on either side of their corresponding bronchus. In the healthy lung the vessels and bronchi are surrounded by a quantity of very delicate connective tissue, which forms around them a loose sheath common to the three, so as to separate them from the lung parenchyma. Any, or all, of the vessels may be pulled out of this yielding case of soft cobweb-like tissue; and the delicate structures may be torn from their proper coats, with which they are thus seen to be directly continuous. The bronchus, artery, and vein contained in this sheath may be conveniently referred to under the name *broncho-vascular system*, while the region of lung-tissue supplied by any such system may be called *broncho-vascular territory* (Fig. 1).

If a thin injection-mass be thrown, with gentle and steady pressure, into the interstices of this peribronchial tissue, it gradually runs along the outer surface of the bronchus and vessels, and permeates into all parts of the connective tissue sheath. Thus may be demonstrated the existence of a close network made up of an immense number of delicate, irregularly sinuous, or lacunar lymph-channels, which completely encompass the artery and vein, and form around them a sheath of lymphatic anastomoses.

In the very small bronchial tubes which belong to the single lobules the mode of branching changes and becomes dichotomous, and the branches lie at right angles to each other. Within the lobules, the tubes and vessels have no longer the same sheath of connective tissues, and I have failed to satisfy myself of the existence of any lymphatic vessels around the bronchus in this situation. If such exist, they must play a very insignificant



Fig. 1.—Showing the Distribution of a Broncho-vascular System and the corresponding Territory of part of a Lobe.

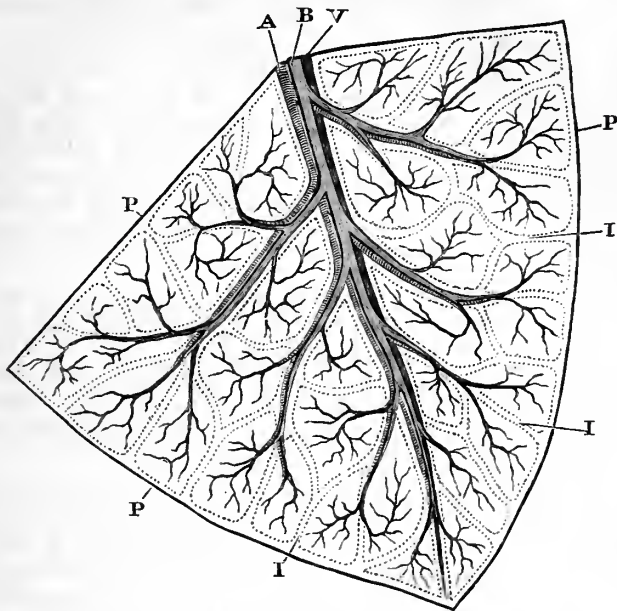

A. Artery. B. Bronchus. V. Vein. P. Pleura. I. Interlobular spaces. The dotted lines indicate the course of the lymphatics. (Semi-diagrammatic. Reduced one-half.)

part in draining the tissue, compared with that taken by the numerous channels in the sheath of the larger broncho-vascular systems.

With regard to the construction of the parenchyma of the lung, there are also some peculiarities which deserve special note, as they distinguish the lung of the ox from that of most other animals. In the bovine tribe a state of affairs persists throughout adult life, which is found only in the early stages of the development of the lung of man. The lobules, or ultimate component parts, are distinct from each other, and may be regarded as independent lung units, each having its own proper air-tube and blood-vessels, and being connected to its neighbours only by some very delicate connective tissue. This connection can be stretched, by a little gentle traction, so as to make the partition between the lobules an eighth of an inch in width. A little more forcible traction, aided by occasional touches of a scalpel, tears through this delicate tissue, so that, with a little care, the lobules may be

completely separated from each other, without their tissue suffering the least injury. They are thus left hanging from the large bronchus, by means of their own proper broncho-vascular systems, just as raisins hang from the parent stalk. If they be now partially inflated, each lobule is seen to be a soft, irregularly shaped body, about the size of a filbert nut. On the pleural surface the outlines of the lobules can be seen to be polygonal areas with definite boundaries. The spaces between the lobules are occasionally made more prominent by means of little chains of air blebs, which lie in them. This seems a common pathological condition in cattle, being a form of true interlobular emphysema, which can also be easily produced after death by means of forcible inflation.

When the delicate connective tissue, which forms at the same time the partition and connection between the lobules, is broken through, each lobule may be seen to be enveloped in a case of this loose tissue. This can be traced to the point of entrance of the vessels, where it is found to be continuous with the tissue of the loose sheath already described as surrounding the broncho-vascular system.

Careful investigation of the fine interlobular connective tissue shows it to be the seat of a very rich plexus of lymph-channels. Here and there vessels with an even outline and wall are seen, but it is more common to find, lying throughout the tissue, wide, sacculated, and irregular passages, freely intercommunicating one with the other. This plexus of lymph-vessels lies midway between two adjacent lobules, and evidently carries some of the lymph overflow from each of them, their lymph-channels being thus intimately related.

By blowing air into an interlobular space, a number of the neighbouring spaces may be inflated, and thus artificial emphysema produced. The relations of these parts can, however, be much better seen by means of injection. A thin coloured solution may readily be made to run through the lymph-channels, and will be found to spread from one interlobular space to those immediately adjacent; and thence it will pass along the lymphatic channels of the corresponding broncho-vascular system already mentioned. Thus, from a single point of insertion under the pleura, not only can more than one interlobular space be injected, but also the injection finds its way along the lymph track, and reaches the main routes, leading towards the root of the lung.

A rich set of lymph-channels may be seen beneath the pleura, being best marked over the interlobular spaces. Though at first it appears distinct, this lymph plexus is intimately connected with those of the interlobular spaces, and may be re-

garded as a part of the same general system. That wonderfully rich set of lymphatics, with which one is familiar in the sub-pleural tissue of many animals, does not appear to be so well developed in the ox. In comparison, at least, with those around the bronchi and vessels, the sub-pleural lymphatics are small. It seems probable that in the case of the ox the deep channels which accompany the blood-vessels take the place of the lymphatic high roads which exist under the pleura of many animals.

The following points concerning the normal anatomy may be thus briefly recapitulated.

1. The vascular and bronchial territories are distinctly defined and independent of one another.

2. The lobules of the lung in the ox are quite distinct, and may be separated without injuring their air-cells.

3. Each lobule is enveloped in a loose case of connective tissue, which contains a rich plexus of lymphatics.

4. A sheath of delicate connective tissue also surrounds the *broncho-vascular systems*, and forms the bed of large lymph-channels.

5. The lymph from the interlobular spaces passes along the peribronchial passages.

6. As the lymph-vessels follow the course of the broncho-vascular systems, those around any given system must drain the territory of the lung tissue supplied by that system.

7. The sub-pleural lymphatics seem to take a less important share in draining the tissue than is the case in many other animals.

#### MORBID ANATOMY.

There are few diseases in which the *post-mortem* appearances are more characteristic than in pleuro-pneumonia. So distinct are the characters of the advanced stage of the disease, that the most unscientific eye can recognise it after seeing a few cases. The group of morbid changes is very constant; and, moreover, there is a general character which is so peculiar as to be easily recognised in every stage of the disease, and which has therefore been deemed specifically diagnostic of it. To the butcher, pleuro-pneumonia presents a much more simple field for speculation than it does to the pathologist, who recognises a number of different morbid changes, which seem to depend on very different causes.

Morbid processes occur in the pleura, in the lung parenchyma, and in the bronchial tubes and blood-vessels. It appears convenient to discuss the changes in each of these parts separately, in the order named, this being also the order in which they are met with in the *post-mortem* examination.

*Pleural Lesion.*—The changes in the pleura show the ordinary signs of pleurisy of rather acute type, in some one or other of its many phases. There is nothing definitively characteristic in the anatomical changes in the pleural cavity to distinguish this from the other forms of pleural inflammation, from whatever cause they may arise. The only point of peculiarity which seems constant in this disease of the pleura is its tendency to remain localised, although the inflammation is intense. In acute pleuritis, the inflammation is usually diffused very evenly over the entire organ, but here are found very different degrees of pathological change in different parts of the same pleura, the inflammatory action being always more intensely marked in some one part than over the general surface of the lung. This focus of greatest intensity is usually well seen even in old cases, for at this point the pleura is found to be covered with dense fibrinous exudation, the deeper layers of which are often stained with blood. This is invariably found to cover the point where the lung lesion is most advanced in its development. As the disease spreads, the contiguous lobes become firmly cemented together by the adhesion of their pleural surfaces. Adhesions may also occur between the visceral and parietal layers of the pleura, but it is more common to find them widely separated by a quantity of fluid effusion. The amount of disease found on the parietal pleura is, commonly, strikingly slight, when compared to that of the pleura covering the lung.

Every variety of exudation may occur, and often a number of different kinds are met with in the same pleural cavity. Most commonly the surface of some one part is coated over with soft, spongy, friable, or semi-gelatinous material, while in other parts the pleura may only be thickened or opaque. Now and then dense fibrinous masses may cause firm adhesions; but the animals are seldom allowed to live long enough for that to take place.

The effusion contained in the cavity of the pleura is generally a thin yellowish, or greenish, whey-like fluid, containing flocculent masses or shreds of fibrinous material. It forms a soft coagulum soon after removal. Sometimes it is quite clear, but more commonly it is turbid or opalescent. I have not met with a case where the pleural cavity contained pus. The amount of the fluid is sometimes very great, filling the greater part of the chest, compressing the lung and displacing the neighbouring viscera. I have seen quarts escape when the breast-bone was split, and on looking into the chest it still appeared to be quite full of fluid.

When the anterior lobes are the seat of the disease and the pleura covering them is intensely affected, the neighbouring pericardium is often inflamed, its fibrous layer thickened, and

the serous lining rough, and studded with small points of ecchymosis.

As the name pleuro-pneumonia implies, the inflammation of the pleura is a very constant part of this disease. It occurs with great regularity, and, on account of the striking characters of the lesions it causes, it is never overlooked even by the most careless observer. Cases do occur, however, where the pleura is not affected at all. I met one such by accident when studying the normal anatomy of the bovine lung.\*

In this case there was not the least sign of even thickening of the pleura, while the lung disease was well marked.

This is the only case I have met with in which there was no trace whatever of pleurisy. I am informed, however, that it is not uncommon to find nodules of disease in the lungs of fat cattle, even where there has not been the least suspicion of disease before death, and no sign of pleural disease at all.

In three cases, where there were several points of disease in different parts of the lung, the pleura covering some of them was found to be perfectly healthy. Thus in one case there was extensive disease of the left lung and pleura, and in the right lung there were three isolated nodules, the largest about the size of a cricket-ball; and yet there was not a trace of pleural disease on that side, and nothing could be more definite than the specific characters of the diseased points of lung tissue.

It would appear, then, that pleurisy does not invariably accompany the disease of the lung tissue; but when the diseased focus is small and deep-seated, the serous membrane may escape. As a general rule, however, the *post-mortem* examination of the disease is not made in the earliest stage, for the lung lesion may easily be overlooked, and it may remain latent for an indefinite time, and therefore its duration does not at all correspond to the clinical history of the disease, which generally dates from the pleural complication.

With regard to the lesion of the pleura, I feel convinced of the following points:—

1. It has the characters common to the ordinary forms of acute pleurisy.

---

\* I took from the slaughter-house a lobe of a lung as a sample of healthy tissue. It was taken from a very fine well-fattened young bullock which was not suspected, before or after slaughter, to have had anything the matter with it. The pleural surface of both lungs was perfectly healthy throughout, and retained its transparency and natural shining surface. On examining the deeper parts of this lobe, a small focus of well-marked pleuro-pneumonic consolidation was found, surrounded by a considerable area of tissue which was the seat of clear exudation. A piece cut off from the part of this lung I had removed was examined by Prof. Brown, and he considered the microscopic characters of the disease to be well marked.



2. It always varies in degree of severity in different parts of the same pleura.

3. Its point of greatest intensity corresponds to the apparent starting-point of the lung lesion.

4. It is not an invariable or essential part of the disease.

5. It usually appears to be of more acute type and more recent development than the lung lesion.

6. Its occurrence often gives the first indication of the existence of disease.

*Lung Lesion.*—The situation of the disease in the lung is generally obvious, on account of the pleural inflammation being more intense over that point. When the pleurisy is absent, or is too diffused to indicate the exact position of the affected part, it can still be easily recognised as a hard, heavy, airless, and discoloured mass, standing out boldly from the neighbouring normally collapsed lung tissue, which is soft, light, and elastic.

The extent to which the organs may be affected varies greatly, the size of the diseased area being, as a general rule, in direct proportion to the length of time the disease has lasted. Sometimes the greater part of both lungs appears to be implicated, while in others there may only be a nodule the size of a man's fist. When looking at the lungs after removal, one is apt to think that a greater proportion of them is affected than is really the case; because the diseased part seems to have greater relative bulk, when compared with the healthy structure, than it has in reality; for this latter collapses into very insignificant dimensions when the thorax is opened, while the size of the diseased portion remains unaltered. The correct proportion of healthy and morbid parts can only be seen when the organs are inflated, by which means the healthy parts are distended to their normal size. At first sight I have often felt inclined to say that the whole of one lung was engaged, so enormous was the hard mass and so general the pleurisy; but inflation brought out many considerable tracts of healthy lung tissue, which would have escaped notice had they not been thus distended with air. In these cases, where the whole of a lung seems diseased, much of the airless part presents on section none of the distinctive characters of pleuro-pneumonia, but merely those which are due to pressure, or such-like secondary changes.

Under the present system of slaughter the disease never seems to reach the extreme stages which have been described by some authors, where the lungs weigh over 100 lbs. As a general rule, the morbid processes, which are characteristic of the disease, are limited to a comparatively small area, seldom engaging more than half the lung, and most commonly only one lobe. Where many lobes are diseased, they are found to be affected in



different degrees, there being usually a central focus, in which the pathological processes appear in a more advanced stage of development.

When the lung is distended with air, so as to assume its normal size and shape, and give an accurate cast of the cavity of the chest, it becomes obvious that the diseased part is not only densely solid, but that it is also considerably swollen; the increase in size being much more than could be brought about by the forcible inflation of a similar part of healthy tissue. It is also changed in shape, its flat surfaces having become convex, so that the diseased mass projects above the surface-level of the inflated lung as a rounded swelling, distorting the neighbouring lobes and pushing them from their natural position.

If a section be made through the centre of the affected part, by cutting from the surface towards the root of the lung, the broadest side of the lesion is always at the pleural surface, and the narrowest points towards the root of the lung. This tapering off towards the entrance of the broncho-vascular system is very well seen in the less advanced cases, where the disease is localised to an area with a distinct conical outline. The base of this cone looks towards the pleural surface, and its apex inclines to the root of the lung, at which point it is found to correspond to the broncho-vascular system supplying this region. In some instances this wedge of disease is found accurately to correspond to one of the broncho-vascular territories which have already been mentioned. In the advanced stages of the disease this conical outline is generally lost, owing to the swelling, which rounds off the corners, and also to the irregular spread of the lesion by means of the pleura.

The disease is often localised to one lung, the right apparently a little more frequently than the left; but it is also often found in both, one generally being much more diseased than the other. Sometimes two or more distinct foci of morbid change may exist, apparently without any connection, there being a broad piece of healthy lung tissue between them.

In the earlier stages of the disease, the boundary of the lesion of the lung is definitely marked and accurately circumscribed. The line of demarcation in these cases always corresponds to the interlobular spaces, all the lobules supplied by a certain set of vessels being engaged, while their immediate neighbours may be perfectly free. The sharp lines of demarcation, not only between the healthy and diseased structure, but also between the different territories affected with the various degrees of morbid change, are amongst the most striking and constant characters of anatomical appearances.

Although the consolidation which is met with in this disease

has much in common with that which is brought about by other causes, it differs materially from the hepatisation caused by ordinary pneumonia in man, and these differences form its chief diagnostic characters. The dense solidity is seldom accompanied by any friability of the tissue, but is resisting and elastic, except in those parts where the tissue is undergoing necrosis. Such circumscribed localisation and boss-like swelling only occur, as far as I know, in this disease and in malignant growths. The manner in which the different changes in colour are distributed forms another striking characteristic. There never is any gradual shading of one colour into another, as seen in the acute pneumonia of the human lung, but the different shades are placed side by side, being separated by most abrupt lines. The greatest possible varieties of shade may be seen irregularly distributed in patches of various sizes; here and there a dull buff colour, or a bright crimson, mixed with deep brown or black. The normal pale pink colour of the lung is always lost, being replaced by some of the above shades, often arranged so as to produce a variegated or mottled appearance of the cut surface; or a large black area may exist in the centre of the section through the diseased lobe, and this is commonly surrounded by patches of brown or buff.

Perhaps the most striking appearance seen on the cut surface is the network of pale yellow lines which is distributed over it. The lines forming this network are, on an average, about one-eighth of an inch in diameter, always very pale, and sharply defined. They intersect and cross one another, so as to map out the surface into a number of polygonal areas, about half or three-quarters of an inch in diameter. These areas are found to correspond with the sections of the lobules, and the pale lines are obviously the swollen interlobular spaces cut across, the narrow lines which exist in the healthy lung between the lobules being represented by masses of more or less solid exudation, so as to give a cross-section of more than an eighth of an inch. This set of pale streaks, crossing the surface in many directions, reminds one of the whitish veins running through variegated marble; and hence the common name which has been applied to the appearance of the section of the lung lesion. This "marbling" is considered to be the great diagnostic character of the disease.

When examined more closely, the increase in diameter of the interlobular partitions is found to depend on extreme filling of the tissue interstices and lymph channels with a material, which may be a clear fluid, or a translucent jelly; or, in the very advanced stages, a dense fibrinous mass may occupy the entire space.

In every case there are to be seen different shades of this marbling, which correspond to different stages in the disease, or are quite distinct morbid processes. I think it will simplify the description of the morbid anatomy of the lung, and render the steps in the progress of the disease more easily understood, if these various forms of pathological change be considered separately.

*Clear Exudation.*—The first which I shall mention may be called simply exudation, or the infiltration of the tissues with a clear material. This condition is generally found in the periphery of the diseased region, and forms a very complete case, enclosing the dense forms of consolidation to be described hereafter. This can be particularly well seen where but a small nodule exists. Thus, in one case, where only three lobules were in an advanced state of disease, all the lobules lying in immediate apposition to them were in a condition of pale œdematous-like thickening. When a great extent of the lung is engaged, the boundary of this transparent exudation is irregular and badly defined; but when a limited area only is affected, its margin is sharply marked, and corresponds to the lines separating the lobules.

There seems to be no increase in the amount of blood in the lung in this condition. On the contrary, the blood-vessels appear, for the most part, empty, and the tissue anæmic. The pink colour is replaced by a pale yellow, or dull buff, and at the same time the tissue gets a peculiar semi-translucent look. A clear fluid escapes from the cut surface. This is often mixed with a little frothy fluid, but as a rule the tissue seems quite airless, and does not crepitate. The interlobular spaces are filled with a clear fluid, which widely distends the interstices of the delicate connective tissue. Except in the cases where the disease is very limited, the part filled with clear exudation does not appear to have any very definite shape, as it easily spreads beyond the limits of the broncho-vascular territories, passing from one interlobular space to another. When the pleural inflammation is very intense, some of the lung tissue situated immediately under it is affected with this infiltration, but it seldom reaches to a depth of more than an inch or so from the pleural surface. This mode of extension of the exudation, under the inflamed pleura, is of great importance, as it causes destruction of a large part of the lung, and seems to spread the disease with great rapidity over an extensive area of the organ, giving rise to those cases where nearly the entire lung is implicated.

A great variety of intensity of this exudation exists. The tissue appears at first to be soft and spongy; the air is then gradually diminished, and the part becomes brawny and tough. Although

the line of demarcation is often very distinct between this clear exudation and perfect consolidation, there are so many degrees of the former, that it seems capable of passing into more dense forms of induration, and it is difficult to find any characteristic which would serve to distinguish all grades of this change from that about to be described, but, as will be seen, the two must be kept quite distinct. The more dense the affected parts the more perfectly marked is the exudation into the interlobular spaces, and therefore the more perfect is the development of the marbling.

The microscopic examination of this translucent spongy kind of condensation of the lung tissue shows that, in the earlier stages, there is but little change in the characters of the tissue-elements. The cavities of the air-cells are filled with a material which is obviously recently clotted serous exudation. It consists of delicate threads of fibrin and a few granular corpuscles. The fibrin threads are variously knotted and granular, and appear to radiate from the corpuscles. The very same kind of material is found to fill the lymph-passages of the interlobular spaces, and the small bronchioles contain some similar fibrinous fluid. The network of capillary vessels around the air vesicles is quite empty of blood, and therefore cannot be well seen in this stage of the disease. The number of cell elements differs very much in different cases. They are chiefly, to all appearance, ordinary white blood corpuscles. In the cases where the exudation is more abundant, however, there is also a number of cells, which are much larger and more granular, and in the midst of them a very distinct nucleus is obvious. The more solid and brawny the tissue, the more numerous these large coarsely granular cells are found to be, and the more thick-set is the network formed of the granular threads of fibrin. In the denser forms of disease the epithelium, lining the alveoli, appears to be changed. The cells are granular and thick, and their nucleus becomes prominent, so that the cells, which in the normal lung are so very difficult to see, become so obvious as to attract the attention of the most thoughtless observer.

*Opaque Consolidation.*—The kind of induration next to be noticed may, as I have already said, closely resemble the result of a long-continued state of the clear exudation just described, which seems gradually to pass through a series of changes, each being more dense than the preceding, until a condition is arrived at which deserves the name of perfect consolidation. But this is not to be confounded with what I call opaque consolidation, from which it differs in its mode of origin, its development not being preceded by the last-described infiltration. It is invariably less resilient, and is more granular in appearance.

In the earliest stages of the disease the two forms of lesion can be easily distinguished one from the other.

This opaque condition is always more vascular than the clear exudation, but cannot be said to be much engorged, although here and there the blood-vessels are more or less distended with blood, so as to give the tissue a bright reddish-brown colour. This is the exception rather than the rule, for the usual colour of the section-surface is a pale brownish-red. The parenchyma is not at all translucent, the tissue being quite opaque as well as solid. The spaces between the lobules are densely filled with an opaque dry exudation, which in places can be turned out of the lymph-vessels, as distinct casts of their internal conformation. The air vesicles are filled with a somewhat similar material, which, under the microscope, proves to be composed of great numbers of cells, entangled in a dense felt-work of delicate granular fibrin threads, united into a dense solid mass. The swelling of the entire part is much greater than in the translucent form, and the spaces between the lobules are much more distended; at the same time they retain their pale straw-colour, and form the striking system of markings seen in the "marbling."

Every part of this true consolidation is hard, heavy, and resisting, but not so elastic as the parts which are translucent and soft. In a few instances the tissue has been found to be friable, apparently from a tendency to necrosis, caused by want of nutrition, the blood-vessels being pressed upon by the swelling. This is an exceptional case, however, for, as a general rule, the nutrition of the part is not at all interfered with, and the tissue not only retains its firmness, but continues to become more and more solid, until an almost cartilaginous consistence is attained. The bronchial arteries supply the nutrition, and are much enlarged. This induration is associated with a distinct increase of the tissue elements, of the connective tissue septæ between the lobules, and also of the tissue of the lobules themselves. In some cases, where the animal has been allowed to live a long time, the fibrous thickening of the interlobular spaces increases to such a degree, that the lobules are greatly encroached upon, and the vesicular tissue becomes so altered that the lung parenchyma can hardly be recognised. In this stage, which is now rarely met with, the animal being slaughtered when first the disease is recognised, the lung is nearly as dense as fibro-cartilage, creaking under the edge of the knife like gristle. Most of the smaller bronchi are obliterated, and even tubes which should normally admit the little finger have been found closed and impervious, their existence only being recognised by the cartilage of their wall remaining unaltered



amidst the dense, fibrous tissue in which they lie. The small bronchi are all plugged in this condition, while in the translucent form they are all free and pervious.

This kind of indurated tissue is always pale and bloodless. The pulmonary vessels are usually closed by pressure, but the nutrition of the part seems amply provided for by the bronchial vessels, which are more obvious than they become in the later stages. In many parts thus indurated, the lobular tissue may retain a certain amount of vascularity, its colour then contrasting most strikingly with the thick interlobular spaces, which are white and glistening.

This fibroid change reminds one of the condition of the human lung in the very advanced stage of interstitial-pneumonia which has been called cirrhosis. It differs, however, from that in a very essential point, namely that there appears no tendency to contraction of the fibroid tissue, such as is found in cirrhosis, causing shrinking of the lung and dilatation of the bronchi, &c. On the other hand, in the fibroid consolidation of pleuro-pneumonia, the infected part invariably seems to be increased in size. It is certainly possible that, if life continued long enough the shrinking might take place, for the contracted state known as cirrhosis only occurs as the ultimate result of old interstitial pneumonia.

Microscopic examination of the different stages of this consolidation shows various gradations in the exudation material. From being a fibrinous mass packed with cells, it changes to a kind of cicatricial tissue. The capillary vessels are frequently found to be filled with blood corpuscles. The bronchioles and air vesicles contain masses of different kinds of cells, some small, round, and pale, but the majority large, and coarsely granular.

In a few cases, peculiar small bodies were found in the cavity of the air vesicles. In certain parts they were so numerous that two or three came into the same field of the low power (Hartnack, Obj. No. 4). They were most strikingly regular in size, measuring about  $\frac{1}{500}$  of an inch in diameter. Their shape was nearly spherical, or very slightly oval. In structure they appeared to be made up of small rods very closely set together, and radiating from the centre of the body. They resisted the action of the strongest reagents, even such as completely destroyed every trace of the lung tissue; in fact everything seemed to make them darker and more distinct. They are like crystals of tyrosin, but they do not respond to the tests for that substance.

The exact nature of these bodies I have not been able to determine, but, from the rarity of their occurrence, I have come to the conclusion that they cannot be said to have any important bearing on the pathology of the disease.



*Black Consolidation.*—The third form of consolidation to which I wish to call attention is generally found in well developed cases of pleuro-pneumonia, though it is more frequently wanting than either of the preceding forms. Its appearance contrasts most strikingly with the changes hitherto mentioned, and it appears to differ from them also in its mode of production. It is at once distinguished from all other kinds of morbid change by its colour, which looks nearly black, so intensely dark is the red of the lobular tissue. From its cut surface a deep red fluid escapes, which stains all the paler structures dark crimson.

The shape of this form of lesion is always that of a distinct cone, the apex of which points to the root of the lung, and its base to the pleura. Its boundary is invariably sharply marked off from the neighbouring diseased tissue, in the midst of which this dark part always lies. The lobular tissue is the only part which has the dark colour, the interlobular spaces being as pale as in the other forms of consolidation. The pale yellow of the interlobular spaces is exceedingly striking in this black part, and also forms a clear trenchant boundary to it. It is easy to satisfy oneself that the extent of this lesion corresponds accurately to that of a vascular territory. Sometimes an entire district supplied by a good-sized vessel is in this condition. In other cases several small territories are engorged, in which case they commonly all belong to the one district which receives its blood supply from the same main branch.

The extent of this lesion is seldom so great as that of either of those already described, but its weight and density exceed those of any other form. The amount of swelling which accompanies it is also very great, so that when a very prominent knob projects over the surface of the lung, and is covered with very intense pleurisy, one may safely predict that, on section, it will prove to be the base of a cone of this black marbling. It is invariably associated with very intense and acute pleurisy, which often gives one the impression of having commenced at this point, and spread thence over the serous membrane.

The microscope shows the minutest vessels of the tissue to be intensely engorged. Even in those parts where the blackness has not reached its height, all the blood-vessels are tightly packed with blood discs, which are so pressed together as to form a continuous line of faceted corpuscles looking like a solid injection. The fluid part of the blood seems to have escaped from the vessels and left the solid parts alone in the swollen and tortuous capillaries. In the very black part, engorgement does not adequately express the state of affairs. Here the vessels have given way, and the blood-discs have escaped

and filled every available corner of the air vesicles. The larger blood-vessels are also filled with plugs of clotted blood, which adhere to their walls.

This form of black consolidation, which obviously is the condition known as hæmorrhagic infarction, is never found alone; it is always associated with, and preceded by, the other lesions, which seem to be of much longer standing.

Like the other morbid changes, this appears to pass through a series of stages, which depend on the changes taking place in the effused blood and in the nutrition of the tissue. The first step must occur with great rapidity, for one never meets with any initial state of hyperæmia. Where the lesion has lasted for some time, the tissue is found to have lost its elastic toughness, and become hard, dry, and friable, and at the same time its colour has faded to a dull brown. The friability of the part may increase, so as to form a dry crumbling mass, which ultimately undergoes caseous degeneration. In other cases the death of the tissue occurs more suddenly, and the part becomes gangrenous. The dead tissue may be surrounded with a kind of fibrous case, so as to remain shut off from the neighbouring parts. Sometimes this completely separates, and remains in the chest as a cyst, containing a mass of cheesy degeneration. These cases only occur where the cure of disease has been attempted instead of the animal being slaughtered.

To sum up the more important of the foregoing facts.

1. The lung parenchyma is usually the seat of various forms of irregularly arranged exudation, which give it a mottled look.

2. The interlobular spaces are always the seat of more or less exudation, which gives their sections the appearance of pale yellowish lines.

3. These pale lines subdivide the mottled surface into irregular small fields, and thus give the effect which is deemed so characteristic—*marbling*.

4. Three kinds of lesion must be distinguished in the lung.

(a) A more or less fluid exudation, making the parenchyma airless, though soft and translucent; this is diffused superficially, and wide-spread.

(b) A dense, opaque consolidation, which is generally the central focus of disease, and is wedge-shaped and defined.

(c) Black consolidation—hæmorrhagic infarction.

5. (a) or (b) May pass into consolidation of a dense kind, and ultimately may form tissue of cicatricial hardness:

6. (c) May produce gangrene, caseous degeneration, or fibrous crumbling.

*Broncho-vascular Lesion.*—The part taken by the bronchial tubes in the chain of pathological processes seems to me so important, that I think it well to describe the changes found in them quite independently of those occurring in the lung tissue.

I find it convenient to associate the description of the vascular lesions with those of the air-passages, because, anatomically, they are very intimately connected, and because the morbid processes in the one help to explain the changes that take place in the other.

The bronchial tubes and blood-vessels have not, as far as I can ascertain, received very much attention. Those authors who describe the change commonly found in them, consider it to be secondary to, or sympathetic of, the affections of the lung and pleura. Every examination I have made of diseased lungs appears to me to contradict this view, and, in spite of a prejudice in favour of the accepted views, the opinion has been gradually forced upon me that the pathological processes in the bronchi are of the greatest importance, and throw considerable light on the initial stages of the disease.

I have never examined a lung affected with pleuro-pneumonia in which there was not a well-marked and characteristic lesion of the bronchial tubes of the part most severely affected. No matter how small the focus of disease in the lung may be, or how little advanced a stage these morbid changes may have reached, there is always definite disease in the corresponding bronchus, extending some distance along the tube, but more or less localised to the diseased neighbourhood. In the small foci of consolidation, where the disease may be regarded as just beginning, the morbid process in the bronchus is generally more extended, and shows evidence of longer duration than the change in the lung parenchyma. This applies only to the part of the lung in a state of real consolidation, and not to that part which is translucent and extended over a large sub-pleural area. In the latter part the bronchial lesion is often wanting.

The cavity of the air-tubes of the opaque solid part is always plugged with a dense adherent mass of tough granular material. This completely occludes all the small bronchi, and extends into the neighbouring larger ones, tapering to a fine point towards the less diseased tubes, where it is commonly surrounded with a quantity of tenacious frothy mucus, which occupies the bronchi for some distance towards the root of the lung. In passing from the larger healthy bronchi to those in the diseased focus, one meets with every stage of transition, from the ordinary frothy sputum of acute bronchitis to tenacious mucous or fibrinous masses which stick to the wall of the bronchus. Often a long branching cast of the air-tubes may be drawn out from them,

here and there some of the branches breaking off and remaining impacted in the tube.

After the removal of the plug, the mucous membrane lining the bronchi is found to be rough and discoloured, and stripped of its epithelial lining. In the neighbouring tubes there is generally intense congestion of the membrane, with patches and streaks of ecchymosis scattered here and there over the surface. The longitudinal folds of the membrane are always greatly exaggerated, showing firm contraction of the wall of the tube. Throughout the opaque part which shows the actual focus of disease the mucous membrane is of a dull-grey, or muddy-yellow colour, uneven and rugged on the surface.

Wherever the lining membrane of the bronchi is congested, they are found to have suffered more deeply. Their proper walls are thickened, their coats being separated one from the other by a kind of tough exudation. The walls of those air-tubes which contain the firm plugs are always enormously thick and dense. Even the small tubes, which are normally very thin, transparent, and yielding, become tough, opaque, and rigid canals, the wall often exceeding in diameter the lumen of the tube. Besides the thickening of the walls of the bronchi, their delicate connective sheath is implicated throughout the diseased part. This fine elastic substance becomes the seat of dense exudation, which changes the thin, yielding, cobweb-like sheath into a tough and rigid case (Fig. 2, A). This exudation

Fig. 2.—*Transverse Section of Broncho-vascular System, contrasting the Healthy with the Diseased State.*

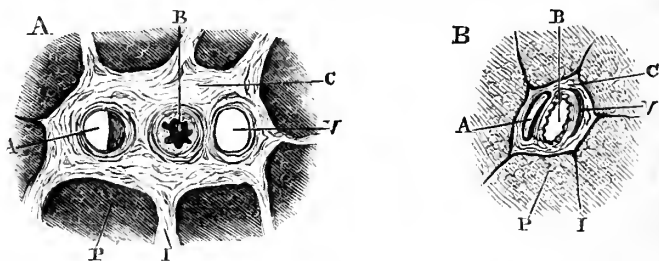

- A. In a state of advanced disease. A. Artery, partially excluded by a thrombus. B. Bronchus, contracted and plugged. V. Vein. C. Common broncho-vascular sheath, thickened by exudation. I. Interlobular tissue. P. Lobular parenchyma.  
B. A corresponding broncho-vascular system in health.

appears to be very similar in character to that which fills the interlobular spaces, and it presents the same varieties and occupies the same relation to the tissue in both these situations. By means of the exudation, the peribronchial lymph-passages are rendered strikingly obvious, as if they had been filled with some pale opaque

injection mass. The course and relations of the larger channels may be thus easily followed with the naked eye. The clear transparent fluid exudation which occurs between the lobules in the more extended part of the lung lesion is not often met with about the bronchi. I am led to suppose from this that the exudation is more dense from the first in this region, or that it becomes solid at an early date after its commencement.

The delicate fibrous tissue, which forms the bed of the lymphatics around the bronchus, seems to undergo a slow process of thickening; the elements of the tissue rapidly proliferating. In the very advanced stages, where the fibrinous change has had time to occur in the lung, the tissue proliferation attains a maximum, and, as already mentioned, may cause the occlusion of tubes of considerable calibre.

The microscopic examination of the plug which fills the bronchi of the diseased part shows that it is made up of amorphous or finely granular material, and of a great variety of elements, in varying quantities and different stages of destruction. Among these are found quantities of columnar epithelium cells, all of which are granular, and may be broken. On some of them cilia may still be recognised. There are also great numbers of large indefinite granular cells which contain a distinct nucleus. Blood-cells and discs are also found, in some cases the quantity being enormous. Besides these elements are numerous threads of fibrin, and many foreign elements, such as fungi, bacteria, &c.

For some distance along all the tubes in the neighbourhood of the disease the epithelium is greatly changed. Even in those bronchi whose coats are hardly, if at all, altered, the epithelial cells are granular and easily rubbed off the membrane, so that it is almost impossible to make a preparation where they remain *in situ*. In the part where the lung tissue is solid, there is never any epithelial lining to the tubes. The elements of the tissue forming the thickened bronchial wall are found to be pushed asunder by exudation and numerous young cells. The fibrillation of the white fibrous tissue is clouded and obscured, and thick bundles of strong elastic fibres stand out boldly, as if the tissue had been treated with acetic acid. The muscular part of the wall is very indistinct. The plates of cartilage are unaltered, but are separated from each other, and seem very far removed from the cavity of the tube, considerable exudation having been poured into the submucous tissue.

By making a series of transverse sections, or a longitudinal section, of the bronchial wall, in one of the least developed foci of disease, one can see that the disease of the mucous membrane extends to a greater distance from the diseased centre than that of the bronchial wall or of the peribronchial tissue.

Occasionally, however, the lymphatics may be affected to an enormous extent; in one case the disease reached to the trachea, and caused partial occlusion of it, by filling the numerous lymph vessels which occupy the posterior part behind the trachealis muscle (Fig. 3). In these cases the lymphatic glands of the root of the lung are much enlarged, but as a general rule do not become caseous.

Fig. 3.—*Surface of Transverse Section of Trachea in which the Lymphatics are intensely engorged.*

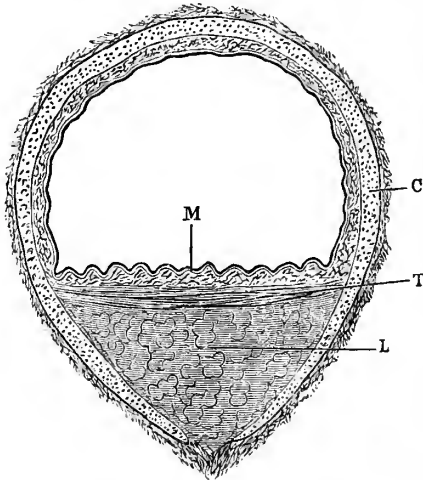

M. Mucous membrane. C. Cartilage. T. Trachealis muscle. L. Connective tissue and engorged lymph-channels.

In speaking of the normal structure of the lung of the ox, I called attention to the very intimate relation between the bronchial tubes and the blood-vessels. They pass along the same grooves in the lung parenchyma, are surrounded by the same sheath of thin connective tissue, and their lymphatics communicate freely with those of each broncho-vascular system, forming one large set of absorbents, which carries all the lymph of the territory supplied by the bronchial tube and its accompanying vessels. It is not at all surprising, then, that as the morbid changes just described are going on in the peribronchial tissue, the sheath of the blood-vessels participates in the diseased action. The exudation encloses the blood-vessels at the same time that it thickens the tissue around the bronchus. So that instead of the three vessels lying in a loose bed of soft tissue, they are encased in a frame, which, enclosing them all, soon becomes so tough and rigid, that they remain patent cylinders,



like tunnels punched out of a resisting substance, such as a piece of turnip (see Fig. 2). The tissue about the blood-vessels is changed in exactly the same way as that around the bronchus, the elements becoming altered in a similar manner.

After a time the walls of the blood-vessels become engaged, the external coat being first attacked, and the other coats in turn becoming thickened and rigid. Often the vessel wall may be increased to several times its normal thickness, and yet the intima looks healthy on the surface. Here and there the intima seems to be also affected. Small red roughened patches are seen on the inner surface of the vessel. The colour seems to depend on staining with the blood contained within the vessel itself. When these rough patches are as large as two or three millimetres across, they are always coated over with a thin pale coagulum. These clots increase in thickness with the increase in size of the damaged patch. Often the intima seems destroyed around the entire calibre of the vessel, or for a considerable extent along one side. In these cases, where the roughness of the intima is extensive, the altered surface cannot be so well seen, as the clot which

Fig. 4.—Showing Thrombus of Artery.

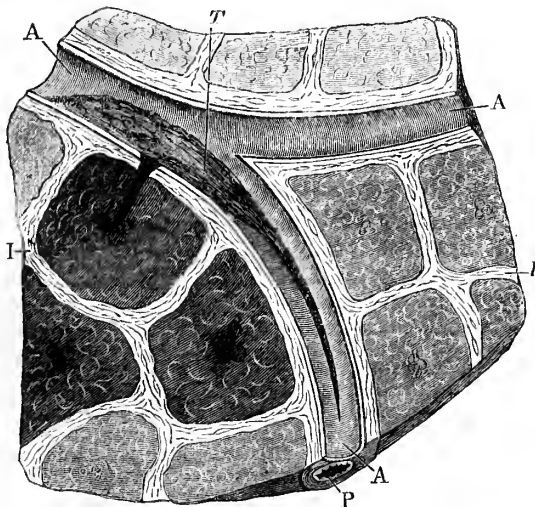

A. Artery. P. Bronchus. T. Thrombus, tapering off to a fine point of fresh coagulum.  
I. Interlobular tissue.

covers it is very thick (Fig. 4). The vessel is thus partially occluded by a thrombus, which, in the case of small vessels, soon

completely fills them with a tight adherent plug. When any vessel is quite occluded, all its branches are found filled with clots of blood, which are often black and soft, evidently being of recent formation. When an extensive plug lies in a large artery without causing its occlusion, many of its minute branches are usually quite stopped. This appears sometimes to depend on small emboli, formed by fragments broken off the thrombus in the parent trunk of the artery. In other cases a number of small vessels throughout the diseased part may be choked up with thrombi, which have evidently been formed primarily in them, and which seem to be caused by several points of the intima being damaged. Once a branch of a vessel has been filled, the clot seems to grow with great rapidity into the larger branches, so as to produce occlusion of the parent trunk and of the neighbouring branches arising from it.

As may be inferred from what has already been said of the hæmorrhagic consolidation, the parts of the lung parenchyma to which the plugged vessels lead, are those thus suddenly engorged. The various appearances met with in the formation of hæmorrhagic infarction are now well understood, so I need not pause here to explain them.\* Here the infarction is well marked, but, owing to the many variations in the method in which the coagulation in the vessels may be brought about, there is a much greater variety in its form than is commonly met with in those cases where it depends exclusively upon embolic plugging. The constant conical shape of the black consolidation can now be easily explained, as well as the suddenness with which the engorgement occurs. The variegated appearance produced by small dark-red patches, which is now and then seen on the cut surface, obviously depends upon small scattered infarcts, which result from numerous emboli, or from irregular and diffused injury to the intima of the small vessels.

---

\* This form of engorgement and hæmorrhage, called by Laennec *pulmonary apoplexy*, is now universally admitted to depend on a local impediment to the circulation, such as an embolus impacted in an artery. There being no arterial anastomosis in the lung, such a plug has a very marked effect. The embolus cuts off the normal supply of blood from the part, and the pressure in the arterial branches beyond the stoppage falls to zero. The blood, however, can still find its way through the capillaries into the branches at the distal side of the plug. The branches of the occluded artery are thus reduced to the condition of occluded veins, and as they have none but capillary connections, they may be said to form blind ends to the adjacent arteries. The blood then trickles into these arterial branches and fills them, but no onward flow can take place, therefore they become intensely engorged with stagnant blood. Under these circumstances the inner coat of the vessels is deprived of its nutrition, for which the constant renewal of the blood is required. This starvation of the minute vessels renders them unfit for their function; they lose their power of retaining the blood, which escapes into the neighbouring texture, forming the dense black consolidation now known as *hæmorrhagic infarction*.

The chief points of importance concerning the bronchi and vessels may be thus briefly summed up:—

1. The bronchial tubes are always diseased in the region affected with the opaque conical form of consolidation and in its immediate vicinity.

2. The mucous membrane is extensively diseased, the epithelium destroyed, and the bronchus filled with a plug.

3. In this region also the walls of the bronchus are thickened, and its calibre is diminished.

4. The sheath common to the broncho-vascular system is throughout swollen, rigid, and densely infiltrated.

5. The lymphatics of the entire vascular territory are rendered impervious by dense exudation.

6. In the early stages of the affection, the morbid process of the lining of the bronchus is more extensive than that of its wall and surrounding tissue.

7. The walls of the vessels may be implicated and their lining membrane irritated and damaged.

8. Thrombosis may occur at one or several points of the vessels, and cause the occlusion of some of them.

9. Small emboli may break off from a thrombus, and plug several branches of the artery.

10. The disease seems always to make greater progress in and around the bronchus than around the corresponding vessels.

#### CONCLUSION.

In the foregoing pages I have attempted to adhere to a plain statement of facts, as supplied by the notes of the autopsies taken on the spot, and by the examination of numerous specimens which have been sent to my laboratory. I have tried to avoid any expressions which involve theories, and have done little to work out the course of the very interesting morbid changes which form the essence of this disease. Without some effort, however, to follow the order in which the various pathological events occur, the description of the appearances would be barren of interest or utility. I shall therefore now try to trace the sequence of the morbid processes; thus the order in which they occur may be ascertained, and possibly the initial stages of the affection arrived at.

As may be seen from the brief summary of the views held on this subject, which was given in the beginning of this paper, it seems generally agreed that the pleura, or the sub-pleural and interlobular tissue, is the part first attacked. Although I commenced work with this idea firmly fixed in my mind, I cannot make my observations coincide with such a view,

and I think many of the facts enumerated show that this cannot be the case.

In the attempt to trace each lesion to its exciting cause, I have, in every instance, been obliged to pass from the pleural surface towards the deeper parts.

If the pleura were the starting-point of the disease, we ought to find the entire of the membrane, on one or other side of the chest, affected evenly throughout. Such is the common course of acute affections of the pleura, and the inflammation in this disease is generally of such an acute type that twenty-four hours would suffice for it to spread over the entire membrane. But I have invariably found that the pleural inflammation is either localised to the place where the lung is diseased, or is much more developed at that point.

With such acute pleurisy as is often found, a case ought surely now and then to occur where intense fever and constitutional disturbance would lead to the early recognition of the disease, and call for the immediate slaughter of the beast; and if the pleural inflammation were really the initial step in the disease, we might fairly expect occasionally to find a case in which pleurisy was the only part of the affection as yet developed. But this is not so. I have never seen, nor heard of a case in which pleurisy alone existed. The lung tissue is always diseased to some considerable depth. I have found, on the contrary, that the typical changes may occur in the lung, without any trace of pleural inflammation.

In the common run of cases, where pleurisy is associated with extensive disease of the lung, the latter always gives the impression that it is of much older standing than the pleural affection. The pleurisy is commonly acute, while in the lung we usually have evidence of such chronic changes as would require a very long time for their development. From comparing the lung lesions with the clinical history, I have often been forced to believe that the disease had existed for a very much longer time than was believed during the life of the animal. In one case, where the cow was described as having been in perfect health three days before I saw the lungs, and was said to have given nine quarts of good milk the day before, I found lesions in the lung, which, I think, must have taken at least six weeks for their production, associated with the first stage of intense pleuritis. Another cow, which was said to have been well, and milking five days before death, had a condition of lung which I cannot imagine could be developed under four or five months. Here there was also recent acute and extensive disease, engaging the entire of the left pleura.

The duration of the clinical history usually corresponds with

the stage of development of the pleuritis, and never with the disease of the lung. I am convinced that the lung disease usually exists for months without being suspected, and invariably the beast is first thought to be sick only when the affection has spread to the pleura, and caused intense inflammation of that membrane with its accompanying well-marked symptoms. And I believe that if our diagnostic powers were improved, cases of pleuro-pneumonia without pleurisy would more frequently be met with.

In thus asserting that the pleural lesion is secondary to that of the lung, I do not mean to imply that the lung parenchyma cannot under any circumstances become secondarily affected from the pleura covering it. It will presently be seen that nothing is more common than this spreading of the disease from the pleura to the subjacent tissue. It can be seen in every case where the inflammation of the pleura is severe, and has lasted some little time. The infective process may be communicated from the primarily affected lobe to its neighbours, by means of the intervention of the pleura, and in these cases the pleura does seem to be the starting-point of the processes in the lobes, which are thus secondarily engaged. But if the primarily affected lobe be carefully examined, it will always be found to contain a wedge of typical marbling, extending towards the root of the lung, with the bronchi and vessels diseased in the manner already described. In this deep-seated, conical, indurated region, the morbid process is more developed than elsewhere. And it is such a centre, I believe, that forms invariably the original point of disease. One such focus, at least, can always be found in some part or other of a diseased lung, no matter how extensive the wide-spread shallow pleural infection may be. To me it seems impossible to explain this chronic, old, indurated part of the lung disease as a result of the acute, recent pleurisy.

On the other hand, there is no difficulty in explaining the pleuritis as a result of the lung lesion. In many of the cases slaughtered immediately after the development of the pleural inflammation, this relationship is most obvious. Putting aside the existence of any specific form of infective material, the irritation and inflammation of the pleura may be explained by the mere mechanical injuries done to the membrane by the swelling of the subjacent lung during the disease. To this exciting cause may be added defective lymph drainage and impaired blood supply.

In the cases where the pleural disease is associated with hæmorrhagic infarction—and these are remarkably common—of course there can be no difficulty in explaining the pleuritis. The pleura may be torn; some blood may escape into its cavity

and set up general inflammation; and the part of the membrane corresponding to the infarction is always cut off from its supply of normal nutrition.

There can be no doubt, however, that in the tissues affected by this disease there must exist, or be produced, some material with infective properties, and therefore there can be no difficulty in finding a cause of the inflammation of the susceptible serous membrane.

I am thus forced to believe that the pleurisy is invariably secondary to the disease of the lung parenchyma. The next question then must be, what is the immediate cause of the pulmonary lesion?

It has been said that different kinds of morbid changes are found side by side in the lung, the immediate exciting causes of which must be quite distinct. The most constant of these is the opaque consolidation, which is comparatively deep-seated, and localised to a conical territory, gradually increasing in extent and induration. A second, the most wide-spread change, seems to be an interstitial exudation or interlobular pneumonia starting from the pleura, or from the last-mentioned lesion. A third, perhaps the most distinct and striking, is the black hæmorrhagic infarction.

The immediate exciting cause of the last mentioned morbid process seems clear enough. We know that, when the lining membrane of a blood-vessel is injured, the blood coagulates at that point, and this coagulation increases if the irritation continues to destroy the smoothness of the inner coat. Thus we have thrombosis, leading to vascular plugging. The *modus operandi* of vascular occlusion in causing hæmorrhagic infarction of the lung is now well understood, and has already been referred to (see p. 194). It only remains, then, to search for the origin of the irritation of the vessel-wall in order to complete the pathogeny of this lesion.

A ready cause of the disease of the wall of the vessels is afforded by the engorged state of the peribronchial lymph-vessels. The entire broncho-vascular system is surrounded by one set of lymph-vessels, through which the irritative processes can penetrate with great facility (see Fig. 2, p. 190). When the lymph-channels around the vessels are thus engorged, one can easily understand how the chronic inflammatory processes infect their proper walls, and finally reach the intima.

There appears no reason to doubt that this chronic inflammation, which takes place in the connective tissue sheath of the broncho-vascular system, is the immediate cause of the great thickening of the walls of the vessels, which always precedes, and is more extensive than, the injury to the inner coat.



And there does not seem the least reason for supposing that the disease of the vessel wall precedes that of the surrounding tissue. On the contrary, such an idea is rendered most improbable by the fact that the neighbouring parts are always more extensively diseased than the vascular wall, the inner coat being the least affected, and often escaping altogether. These points will appear more obvious when the course of the bronchial lesion is discussed.

Both the other forms of consolidation obviously depend upon causes quite distinct from that which induces infarction; and, moreover, a little consideration shows that the mode of commencement of one of these is very unlike that of the other.

Fig. 5.—*Semi-diagraphic Sketch to illustrate the mode of extension of the Disease. (A portion of three neighbouring lobes is shown.)*

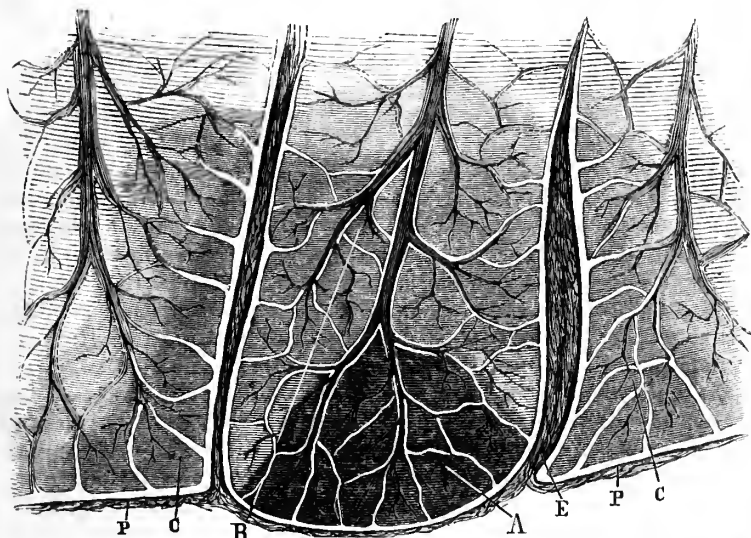

The darkest part of the central lobe (A) is the starting-point (*opaque consolidation*): the lighter part of same (B) shows extension of the *clear exudation* *via* bronchial lymphatics (C) by means of the pleura (P). (E) Pleural exudation. Reduced to one-fourth.

The clear exudation is always more wide-spread and superficial, less solid and less defined, than the opaque induration. The tissue elements remain normal even after the exudation has become intense. The vessels and air-passages are pervious and little altered. It might be described as intense inflammatory œdema, while the other may be termed croupous consolidation. From the distribution and relations of this clear exudation, it appears certain, as just stated, that it is the result

of infective action spreading, by means of the lymph-vessels, from the inflamed pleura, and along the broncho-vascular system. But I have already stated that the pleura cannot be said to take the initial step in the disease, so we must look for some other cause of the dense opaque consolidation, which certainly does not depend upon pleural infection.

The first thing that strikes one as remarkable about this form of lung-lesion is its shape. This always is the same as that of the territory supplied by the broncho-vascular system which enters at its deepest part. In this respect it bears some resemblance to the infarction. In the case of the latter, however, its mode of production and its cause explain its shape, but the blood vessels in the young cone of opaque consolidation are, as a rule, healthy and pervious, and therefore can throw no light on the matter.

Let us examine what changes are constant in this cone. By making a fair section directly through the centre of a small isolated focus of the dense pale induration—and to such a stage of the disease we must look to learn its initial steps—three important facts become obvious; first, that the air-cells are filled with croupous exudation; secondly, that the bronchial tube and its branches are plugged with a dense, adherent, fibrinous mass; and thirdly, that all the lymph-vessels around these air-tubes are swollen and turgid, being the seat of a dense fibrinous exudation. Looking at such a specimen, one cannot avoid being impressed with the idea that the occlusion of the bronchus and the engorgement of the lymphatics immediately surrounding it must be the cause of the lobular consolidation and the interlobular exudation. The more I have tested this view by careful scrutiny of the diseased parts, the more firmly convinced I am of its truth and importance in explaining the first steps in pleuro-pneumonia. I am at a loss otherwise to understand the peculiar localisation, the sharp demarcation, and the conical shape; all of which are such constant characters of the opaque consolidation, particularly in the early primary nodules of the disease; but, if this view be correct, they are all easily accounted for.

A focus of opaque consolidation being once established, there is no difficulty in accounting for the clear exudation which so constantly surrounds it. When once the broncho-vascular set of lymph plexuses have become the seat of this irritating exudation, it is easy to imagine how they will facilitate the spread of the disease. Encompassing the bronchus, they lead the infective material to irritate its coats, and cause them to undergo a kind of chronic destructive inflammation. At the same time, traveling along the lymphatics towards the root of the lung, the inflammatory process comes upon the tributary broncho-vascular

systems, chokes their lymph-passages, and thus produces interlobular exudation throughout the territory from which they come. There is no difficulty in working out a great variety of ways in which the disease may be spread through the lung by means of the peribronchial lymph-vessels, on the one hand, and those under the pleura on the other; the former leading the infective process to the root of the lung, the latter extending it over the surface of the organ. Thus the soft translucent form of exudation may be spread in two ways, viz. by the subpleural and by the peribronchial lymphatics. This would sufficiently account for its irregular outline and indefinite distribution.

But, even admitting that the irritative change in the peribronchial tissues is the cause of the thrombosis and consequent infarction, and that it also takes a great share in the production of both forms of solidity of the lung parenchyma, we have made but little way towards finding out the starting-point of the disease. The occurrence of the peribronchial exudation remains to be accounted for, and its exciting cause must be discovered before we can speak of the first step in the morbid processes, without which the life-history of the disease is deficient in the most vital point.

There seems every reason to believe that this is a process which goes through the same series of events as chronic inflammation, such as would follow any form of persistent irritation, and lead to intense induration. It is needless to go into the much-vexed question whether this be an inflammatory disease or not; authors differ not only amongst themselves, but even with themselves, upon this point. We only know inflammation as a certain series of phenomena occurring in a certain order. We meet these same phenomena in the same order in pleuro-pneumonia, and we must find a more satisfactory explanation of its peculiarities and divergence from ordinary inflammation than the simple statement that it "is not inflammatory in any of its stages, and never presents any of the phenomena which are associated with inflammation."

In the parts where the peribronchial exudation is most firm, and the tissue most densely infiltrated with new cells, the proper walls of the air-tube are invariably much thickened, and show signs of long-standing disease. The lining membrane of this part of the bronchus is also quite destroyed by a process of ulceration, the epithelium cells being cast off, and forming part of the plug which fills the calibre of the tube.

In those cases where there has been but little time for the disease to spread by the lymphatics, the destruction of the mucous membrane is more extended than the thickening of the peribronchial lymphatics. In short, the mucous membrane

seems more extensively diseased than any other structure, in the very early stages of the affection.

From this it would appear that the irritation of the peribronchial lymph-channels is produced by a form of chronic inflammation in the structure of the bronchial wall, which is brought about by the disease of the mucous membrane.

So constantly have I met with this condition in the opaque parts, that I have but little hesitation in affirming that the disease commences in the air-passages as a chronic inflammation, associated with destruction of the bronchial mucous membrane. I cannot say what is the exact size of the tubes in which the inflammation begins; it seems likely that the lobular bronchi are those most readily affected, and certainly the very small tubes are invariably attacked, even when the disease is in its most recent stage. The impression left on my mind is, that the delicate lobular bronchi are those first attacked in the majority of cases, though often the morbid processes are more striking in those tubes about the size of a quill.

As to the immediate exciting cause of this strange form of bronchitis, little can be said. No light is thrown on the subject by the morbid anatomy, no constant specific elements have been found in the affected part. The ætiology of the disease must be studied clinically and experimentally. The only suggestion I should presume to make upon this subject is a plain deduction from the reading of the pathological events as I have traced them out; it is this, that pleuro-pneumonia being a local disease, starting in the bronchial mucous membrane, it can only be produced by direct and immediate infection of that membrane, and it is little to be wondered at that inoculation of the tail, or other part, cannot produce the local disease in the lung, though it may set up, in the part operated upon, a form of progressively infective inflammation, which runs a course not unlike that of the lesion of the lung. I have had many opportunities of satisfying myself that when a tail is "successfully" inoculated the subcutaneous connective tissue undergoes a change exactly like that between the lobules of the lung, and the infective process rapidly spreads by the lymphatics.

I can well understand how a beast, by sniffing the fodder of a diseased neighbour, may draw into its air-passages some of the dried discharge, and thus infect its bronchial mucous membrane and get pleuro-pneumonia, while all the skill science can apply will not induce the disease of the lung by mediate contagion, *i.e.* the inoculation or injection under the skin or into the vessels of infective material procured from a diseased lung.

Whether there be any special virus which acts as the specific cause of this disease or not, must also be left to experimental



inquiry to determine positively. I have searched in vain for a morphological element which could be regarded as the *materia peccans*. However, the general aspect of the morbid processes gives one the idea that some peculiar infective product is at work. In very many cases foreign elements, so peculiar as to provoke suspicion, have been found, but further investigation failed to bring home to them the necessary pathogenic properties, as they have generally proved to be inconstant or harmless substances, whose presence is either accidental or unimportant.

The fact that no morphological representative of an infective material can be found, is no proof that it does not exist. How long is the list of diseases which are acknowledged on all sides to depend on the presence of a peculiar virus? How very few—if there be any—of these specific materials do we know in any other way than by the effects they produce? Some, we know, cause a general affection of the blood, some a peculiar primary local lesion, and subsequent general infection, others again give rise to a purely local inflammation with a specific character. In the latter category I am inclined to place the virus of pleuro-pneumonia. When applied to the bronchial mucous membrane or introduced into any lymph-bearing tissue, it sets up chronic inflammatory changes associated with excessive exudation. Ordinary inoculation illustrates this perfectly. The operation causes practically no inflammation; but after a definite period of incubation, varying from ten to fourteen days, a local specific inflammation is produced in the connective tissue; but this is not accompanied by any constitutional disturbance, except when it spreads extensively: timely amputation of the tail, however, usually prevents this unfortunate accident, and the animal quickly recovers without having any traces of a blood-disease.

I abstain from attempting to discuss the many abstract questions or theories which have from time to time been introduced into the study of this peculiar affection. Whether it be real inflammation, or some mysterious specific change differing from all other diseases; whether it be comparable with any human disorder; whether it be zymotic or not, &c. These are very interesting speculations, but their consideration is not very likely to lead to any immediate practical result; and therefore it appears to me more profitable to attempt to unravel the intricate sequence of pathological events, and trace the successive steps of the morbid changes which occur in pleuro-pneumonia, for I am satisfied that it is along this track we must travel, if we hope ever to arrive at the true pathogeny of the disease.

To recapitulate, then, the various items in the pathological sequence may be thus enumerated:

1. Irritation of the mucous membrane of the smaller bronchi, probably by some infective material (specific virus?).

2. Chronic ulcerative bronchitis, localised to a few minute bronchi.

3. Occlusion of the affected air-tubes.

4. This produces such changes in the air-cells belonging to the affected tubes that the lobular parenchyma becomes solid.

5. As the bronchial disease progresses, the walls of the air-tubes become thickened and infiltrated with the products of chronic inflammation.

6. The peribronchial lymphatics are implicated by the extension of the infective process from the bronchus, and are soon filled with dense exudation.

7. The block in the lymphatics of the broncho-vascular system impedes the flow of lymph from the corresponding territory.

8. The tributary lymph-channels are thus mechanically engorged, and at the same time they are irritated by infective materials.

9. The inflammation of all the coats of the air-tube gradually spreads towards the root of the lung.

Thus we have a deep-seated cone of typical consolidation, traversed by numerous wide whitish lines, corresponding to the swollen interlobular connective tissue (marbling). In fact, the essential features of the disease are all established.

The morbid process seldom stops here, however. It spreads in two ways.

First, by the broncho-vascular lymph-passages:—

1. The irritating and infective materials find their way along the lymphatics towards the root of the lung, following the normal course of the lymph stream.

2. The wall of the bronchus becomes affected after a time by the irritative matter in its surrounding lymphatics.

3. The lymphatics of tributary bronchial tubes, met with as the disease thus advances, are choked, and the drainage of their territory impeded.

4. The interlobular lymph spaces of the newly affected territory soon become filled with exudation. Thus the clear kind of consolidation is produced.

Secondly, by the pleura:—

1. The pleura becomes affected over the focus of consolidation by means of the subjacent lymphatics.

2. The pleurisy soon extends far beyond this limited region, or the serous membrane becomes generally inflamed.



3. From the inflamed pleura infective materials reach the lymphatics beneath it, and also those lying between the neighbouring superficial lobules.

4. Extending along the interlobular lymphatics, the irritation and exudation may pass towards the deeper parts, so that an immense tract of lung is converted into a semi-translucent mass with swollen interlobular spaces.

The consolidation formed in any of these ways may become intense induration, if the animal live long enough.

With regard to the origin of the disease of the vessel wall we must also start from the peribronchial disease.

1. The lymphatics of the bronchus readily allow the morbid products to pass to those immediately around the vessels.

2. The wall of the vessel becomes greatly thickened by chronic inflammatory products.

3. The inner coat—which resists the disease for some time—ultimately becomes diseased in small patches.

4. The blood coagulates over the diseased inner coat, and may occlude a small branch at its origin, or even the entire vessel.

5. Particles of the clot may break off, and, passing into the minute arteries, form there embolic plugs.

6. Thus numerous arteries of varying size may be stopped up.

7. The most varied forms of hæmorrhagic infarction are thus produced.

8. The infarction may become gangrenous, cheesy, or may dry up into a crumbling mass.

9. A capsule may form around the most diseased part, and shut it off from the rest of the lung.

If asked to give a pathological definition of pleuro-pneumonia, I should say that it was:—A chronic, specific, local disease, starting in the bronchi, and insidiously implicating the parenchyma of the lung, by occlusion of the bronchi and inflammation extending along the lymphatics: the other organs and the blood possess a singular immunity from the specific contamination. It is not accompanied by constitutional symptoms, and only gives obscure physical signs. At any time during the progress of the disease its existence may be manifested clinically, by the occurrence of complications—acute pleurisy or hæmorrhagic infarction with pleural inflammation—which excite high fever, with various functional derangements.

---

VIII.—*Reclamation of Bog and Moorland in Galway.* By  
CHARLES GAY ROBERTS, of Haslemere, Surrey.

MORE than one-fifth of the area of Ireland consists of waste land. Connaught, the smallest of its provinces, contains more bog and waste land than any of the other three. Its total area is 4,233,239 acres. Of these only 460,614 acres were returned in 1877 as under tillage; 2,279,636 acres being in grass, meadow, and clover; 54,903 acres woods and plantations, and 1491 fallow. The remaining 1,436,595 acres of bog and waste land remains a perpetual challenge to the energy and industry of man to bring it into cultivation, and compel it to yield crops for his benefit. An English agriculturist travelling through Ireland for the first time will ask himself the question again and again, Is it necessary that these vast areas of level land should remain unprofitable and waste? Cannot these hill-sides and moorlands be made to produce a better herbage, so that they may feed instead of starve the cattle turned out upon them? The question is one of such great national importance that every practical attempt to answer it is of great value. During the fifteen years that Mr. Mitchell Henry has held the Kylemore estate, his attention has not been confined to questions of general interest to the country and the county which he represents in Parliament, but he has paid great attention to the wants of the poor in his immediate neighbourhood, and has worked with increasing confidence at the reclamation of a considerable portion of the moor- and peat-lands in his possession. These experiments in cultivation are far from being complete, and in many respects their success cannot yet be spoken of with confidence; but they have now been continued for a sufficient time, and extend over a sufficient area, to make them well worthy of the attention of British agriculturists. They have all been carried out under the superintendence of Mr. Archibald D. MacAlister, the resident agent, who has combined much prudence and caution with great intelligence in their execution. Unless much discretion is used, the introduction of innovations into many parts of Ireland is apt to be attended with very serious drawbacks, but, by gradually feeling his way, Mr. MacAlister has been able to ascertain the best method of improving the condition both of the land and of the peasantry. Thus experience has taught him that the drains which he at first put in at 40-foot intervals are not sufficient for moorland with such a rainfall as prevails at Kylemore, and they are now being placed at half that interval. Hardly any of the cottages upon the estate possessed the luxury (or, as an

English labourer might term it, the necessary convenience) of a window. Had Mr. Henry been ill-advised, he might rashly have given orders that a window should at once be put into every cabin, and thus have made all his tenants bitterly complain that the comfort of their homes was ruthlessly destroyed. Instead of this, he proceeded more cautiously, and was content to put in a window for the single tenant who wished for sweetness and light. After a while, the improvement was thought to confer an air of greater gentility upon its possessor. When the neighbours complained that one had received greater advantages than the rest, their wishes were gratified at once, and now there is not a cottage on the property that has not a glazed window that can be opened to let in air as well as light.

The physical and the social peculiarities of the district must be considered before we can discuss intelligently the work that is being done. These will force themselves upon the attention even of the casual visitor, whether he comes *viâ* Galway or from Westport. In the latter case the first 10 miles of his road will lie over a dreary waste of bog and moor, with many small farms, some of them still cultivated, but, in their marks of sloth and poverty, even more sad than are the heaps and lines of stones that mark the site of hamlets, surrounded by a multitude of small enclosures, once tilled by hand, but now grazed over by rough cattle; the next 5 miles of road along the valley of the Owen Erive river passes through the finest mountain scenery in the county of Mayo. In passing through the village of Leenane, at the head of Killery Harbour, he will see several small farms that receive a liberal application of sea-weed, and produce excellent crops of potatoes and oats. The population here have the great advantage of varying their diet with fish, that can be caught at all times in the land-locked water of the bay, an arm of the Atlantic half a mile in breadth, running up like a Norwegian fiord for 9 miles into the heart of the mountains. From Leenane he will pass for a distance of 7 miles through the Joyce's Country, and will meet with no signs of cultivation until he arrives at the Pass of Kylemore. If the southern route is chosen, the railway must be left at Galway. Along the first 7 miles of the road, as far as Moycullen, there are many well-cultivated fields and well-built steadings; at Ross the road enters upon the property of the late Mr. Martin, of Ballynahinch; a country so wild that it was the boast of Connaught that "The King's writ could not run in it." It extends for nearly 40 miles along the road for Clifden. The whole of this property was purchased by the Law Life Insurance

Company for 180,000*l.*, the greater part of it being of no agricultural value. By them it has been divided and re-sold. About 17 miles from Galway, the post-town of Oughterarde is reached. While changing horses, a walk down its single broad street will show that it contains many substantial buildings, in addition to its enormous Union House, and the visitor will carry away with him the impression of its being a comfortable and thriving town, unless he stops to look in at the doors of some of the smaller houses. His English ideas of comfort may in that case be disturbed by finding that the cattle share with the family their single living-room. Such cabins are the rule and not the exception in the rural districts of Connemara, but they present an incongruous appearance when found amid the modern houses and shops of a thriving little town. As reference will be made to them further on, a sketch of an interior is given. A is the

Fig. 1.—*Plan of a Connemara Cabin.*

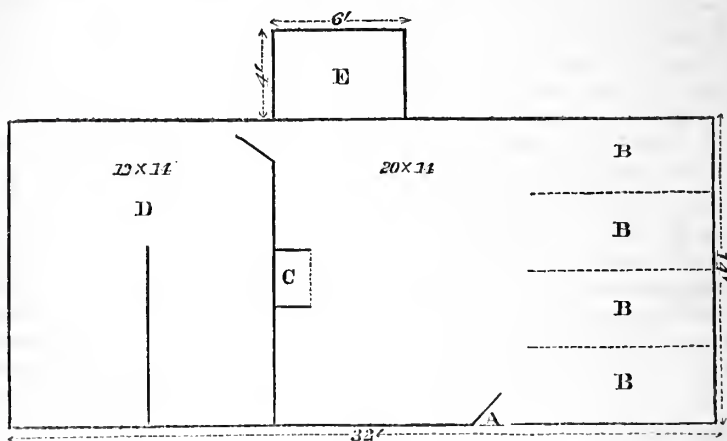

door opening into the living-room, 20 feet by 14; 8 feet of its length is occupied by cattle, their position being indicated by the dotted lines at B, B; C is the hearth; the doorway beyond it leads into the bedroom at D, 14 feet by 12, occupied commonly by the young folk. At E there is a recess, 6 feet by 4, built out from the living-room, and occupied by the bed of the heads of the family. For 12 miles after leaving Oughterarde there is a wide-spread tract of bleak moor, and numerous small lakes, with no trees to relieve the eye from the monotonous colour of the peat. The character of the country then changes, the hills increase in height as the great group of the western highlands is

approached, and for the remaining 15 miles it skirts the southern and western sides of the Mamturk Mountains, passing between them and the Twelve Pins, grand and rugged masses of quartzite rock, rising singly, and yet in close proximity to heights of from 2000 to 2300 feet. In the whole drive from Oughterarde to Kylemore there is scarcely a tree to be seen except on the islands of Lough Inagh, and there are hardly any signs of cultivation except the small patches of potato garden by the side of the cabins, few and far between. Amid so much that is wild and desolate, it will be noticed that the road itself is in excellent repair, and has been very well constructed. All the main roads throughout the district are equally good, having been made by Government during the time of the famines, to give employment and relief to the starving peasants. The road enters the Pass of Kylemore at its eastern extremity and runs for some 4 or 5 miles along the side of the Kylemore Lough, and the rapid Dawris river till it reaches the little village of Letterfrack at the head of Ballynakill Harbour on the shore of the Atlantic. Looking down the valley, it is seen that it is bounded on the north and south by a rugged chain of hills, from 1500 to 2000 feet high. Immediately below, the lake occupies the whole breadth of the eastern end of the valley; the eye is refreshed by a belt of 400 acres of wood, clothing the hill on its northern side, and at the foot of the wood are seen the grey granite walls of the castle, built on three terraces hewn out of the rock on the edge of the lake. South of the Castle at Addergoole and further west, where the valley grows wider on each side of the Dawris river, there are bogs of deep peat, but the greater part of the valley is occupied by moorland, a thin covering of peat resting upon metamorphic rocks of mica schist and hornblend. Banks of limestone occur on each side of the valley, and are worked on the south at Mweelin, and near the pinetum on the north, between the castle and garden. Lime is the first requisite for the reclamation of peat land. It has been hitherto drawn chiefly from the quarry at Mweelin, but the completion of the building operations will now render the supply from the second quarry available for use on the land. On the southern side of the valley, reclamations have been made at Addergoole and Mweelin, on the level land opposite to the castle, but those of most importance have been carried out on the hillside north of the valley, opposite to the village of Letterfrack, at Toorena, and at Mullaghglass, extending in a northerly direction over the crest of the same hill, to the southern shore of an indentation of the coast line. Some insight into the value of the land in its unreclaimed state may be gained by referring to Griffiths' 'Tene-

ment Valuation of Ireland,' on which all county and poor rates are levied. The valuation of Galway was made in 1854. The Barony of Ballinahinch in the district of Connemara contains 191,432 a. 2 r. 4 p., and is valued at 17,756*l.* 2*s.*, being an average of 1*s.* 10 $\frac{1}{4}$ *d.* per acre. The land at Kylemore, however, is below the average rate of the barony, 925 $\frac{1}{2}$  statute acres being only valued at 639*l.*, that is, at the rate of 1*s.* 4 $\frac{1}{2}$ *d.* per acre. It originally formed a portion of the Blake estate. In the time of the famine it suffered more than other parts of Ireland, in consequence of its isolation. The relief works were at a distance; the poor people remained on their bits of land as long as they could get anything to keep body and soul together; food was not brought to the starving families; and when at length they were forced to leave their homes, they were not strong enough to travel, but dropped and died upon the hills before they could reach the relief stations. Looking down upon a large field recently ploughed at Mullaghglass, we asked Mr. MacAlister the reason of its appearing cut up into numerous strips and squares of varying quality. The explanation brought most vividly before the mind the painful history of the periodical famines that culminated in 1847. It was originally a township, with a cabin standing upon every land. The plots still give some evidence of the varying industry with which the tenant dug his peat and grew his potatoes. The township was depopulated by famine, when many died and others left; twice afterwards it was re-peopled, but the new comers were again driven away by failure of their crops. Now all the cabins are gone, the site of the township having been let as a beach-farm to a grazier before it came into the possession of the present owner. In a similar way a great part of the Kylemore property had been converted into grazing land, and Mr. Henry was able to secure 4000 acres of land almost without a tenant upon it. This has been of the greatest importance, for no tenant has been turned out to facilitate the reclamations, and care has been taken to leave the hearth-stones undisturbed, in accordance with local prejudices. Shortly after the famine, Archdeacon Wilberforce purchased 8000 acres, through the Encumbered Estates Court; he let the greater part of the land as a grazing farm to Mr. St. J. C. Clowes, working himself as a Catholic priest among the peasantry then remaining while building cottages for them as their landlord. On a part of the site of the old village of Mullaghglass he erected thirty cottages of stone and larch timber, at an average cost of 17*l.* each. The remaining part of this township was let to a grazier, shortly before the whole property was purchased by the present owner.



I will now give a brief summary of the improvement on each township of the property, taking them in the order of passing down the south side of the river and returning up the north side. The first two townships were not purchased from the Wilberforce family. The work of reclamation by Mr. Mitchell Henry was first begun opposite to the castle at Mweelin. Previous to the famine, this land was owned, as a fee farm under the Provost of Trinity College Dublin, by two Miss Murphys who grazed cattle, and lived in a small cottage, still standing. They died at the time of the famine, leaving the farm to their nephew, a clerk in a solicitor's office in Dublin. Finding himself unable to pay succession duty and the taxes upon the land, he was glad to sell his white elephant to a Dublin tailor for 10*l.* and a suit of clothes. In 1854 it was owned by the Rev. J. Duncan, and subsequently sold by him to the present owner. On the mountain side 30*l.* were spent here twelve years ago on sheep-drains with excellent effect; before this was done there was a great loss from rot among the sheep, as many as thirty dying annually out of a flock of 200. The benefit is not confined to sheep and cattle; in wet weather the grouse will always give the preference to the drained land. The system of sheep-drainage was introduced into the district by an Ayrshire man about 15 years ago; it is done with the Scotch spade, cutting a small open trench across the face of the hill, the turf being laid on the lower side. The trench is 20 inches deep, with a breadth of 20 inches at top and 9 inches at bottom; and the cost is 1*d.* per Irish rod of 7 yards long. Every seventh year the trenches should be cleaned out, at a cost of  $\frac{1}{2}$ *d.* per 7 yards. At the foot of the hill there are the remains of an old monastery, and at a short distance one of the burying-places of the once powerful family of the Joyces, noted for their size and strength. Lower down is situated a good limestone quarry, with a kiln in which both coal and peat are used for the lime burning. Immediately below the kiln is a bog of deep peat. Here 20 acres were drained, nine years ago, by 4-foot drains, 30 feet apart, leading into a main drain, which at its lower extremity had been left as an open ditch. This has proved very disadvantageous, as the sides have been trodden down by sheep and cattle, and the outfall of the minor drains has been so much impeded that a new main drain is now being cut to open the minor drains about 30 feet from their original outfall. The land received a dressing of 50 barrels, equal to 150 bushels, of lime per acre, and was trenched into 4-foot ridges; 10 acres received a dressing of guano, and were sown with turnips; the other 10 acres received a half-dressing of farmyard-manure, and were planted with potatoes. The roots were drawn for the cattle

in the yard at Addergoole, and oats were sown over the 20 acres and seeded. The crop was good after the potatoes, but not worth cutting after the turnips. The next year the grass was cut for hay; since then it has been grazed by 300 sheep and 10 head of cattle, which have also the run of the townland, comprising 653 acres of moor, with a large proportion of barren rock. The grass is now poor and mossy, and rushes mark the places where the drains have failed to act. Before turning to the next piece that has been broken up, it will be convenient to give a general account of the system now adopted at Kylemore in reclaiming the bog.

*Draining.*—The first step in the reclamation of peat-land is the removal of the excess of water by draining. The facility with which this can be done will depend upon the depth of the peat, the nature of the subsoil, the contour of the land as affecting the outfall and pitch of the drains, and, though last, not least, the average rainfall of the district. As regards the first point, it has already been stated that there is comparatively little deep bog at Kylemore. The peat is frequently of such a depth that drains can be cut through it, over a large area of land; it will obviously be useless to do this where the peat rests, as it does over a large area, upon the solid rock, which is here sometimes primitive, but more usually of a metamorphic character. On some of the hill-sides, however, and notably at Tooreena, beneath the peat is found a thick deposit of drift, consisting of gravel mixed with micaceous sand, and a little clay, affording an excellent receptacle for the drains. The mountainous nature of the district makes the pitch of the land amply sharp enough to insure a sufficient draught for drainage; but it also attracts the clouds from the broad Atlantic, and draws down from them an amount of moisture almost unprecedented in the British Islands. A rain-gauge is kept by Mr. Maxwell near the eastern end of the Lough, at a spot 105 feet above the sea. The fall recorded by him, and reported in the tables drawn up by Mr. G. J. Symons, was 56·02 inches in 1875, and 95·33 inches in 1876. Nearly 2 inches fell on the day of my arrival in May; and in calling subsequently on Mr. Maxwell, I found that he had no reason to expect the rainfall of 1877 would be less than that of the two previous years. The following table (p. 213) is an extract kindly furnished by him from his monthly record.

A rainfall like this explains the good-natured remark of a native, as he looked out of the window, that the rain was “Nothing to speak of, but quite enough to wet an Englishman to the skin.” Rules that apply to the drainage of other districts will not be sufficient for exceptional circumstances like these.

## MONTHLY RAINFALL AT KYLEMORE IN 1877.

RAIN-GAUGE 1 FOOT ABOVE GROUND AND 105 FEET ABOVE SEA-LEVEL.

MONTH.	Total Depth.	Greatest Fall in Twenty-four Hours.		Number of Days on which .01 or more fell.
		Depth.	Date.	
January .. ..	18.33	1.94	23	30
February .. ..	8.31	.94	14	28
March .. .. .	6.72	1.03	10	29
April .. .. .	5.77	1.21	24	22
May .. .. .	8.70	1.95	26	17
June .. .. .	7.12	1.75	28	16
July .. .. .	7.40	1.26	21	31
August .. .. .	7.64	1.56	27	24
September .. ..	3.10	.88	12	15
October .. .. .	11.63	1.73	20	23
November .. ..	18.25	1.88	10	30
December .. ..	13.01	2.23	5	30
Total .. .. .	116.03	..	..	295

As the reclamations have been carried on, the drains have been put closer and closer together, and some years must yet elapse before it is certain that those last put in, at 20 feet apart, will keep a peat soil sufficiently dry beneath such a weeping sky.

One great lesson taught by past experience has been that wherever peat is found, the work of reclamation must not be hurried; it is useless to attempt cultivation until the excess of water has been got rid of; and, since peat holds water like a sponge, this cannot be done without allowing it time to become partially dry.

The first operation must be to cut the main drain along the lowest level; if this can be cut through the peat, into gravel or sand, the rest of the drains can be cut at once, but if the peat is deep and soft, it may be some years before the work can be carried further. At Addergoole there is a plot of 50 acres to be drained: a big trench was dug in 1874 down the centre of this land, 9 feet wide and 4 feet deep, at a cost of 2s. 6d. per perch of 7 yards. The bog being soft, it partially filled in at once, and at the end of a week it was only 6 feet wide and 2 feet deep. In 1875 it was deepened again to a depth of 6 feet. In 1876 the sides were cut wider at the top, so as to give them more batter. The trench now stands 5 feet deep and 9 feet wide at the top; the peat in its immediate vicinity has become more

consolidated, and the minor drains can now be cut. Where the peat is less than 4 feet thick, the main drain can be cut at a cost of 8*d.*, and the minor drains at 6*d.* per Irish perch of 7 yards, with 3*d.* extra for going through or under each boulder-stone or root of bog-oak; the minor drains have lately been placed at 8 yards interval, wider intervals having proved insufficient. Across the minor drains, sheep-drains are run at about the same distance apart, to carry off the surface-water, at a cost of 1*d.* per perch. The bog should then be left untouched for from two to four years, during which time the turf will become consolidated. The drains should then be cleared out, and a wedge of turf, too wide to reach the bottom, be driven down, so as to form a solid covering, with a water-channel of, 6 inches deep below it. The drain is then filled in and levelled. The sodding and levelling is usually done by day-work, at a cost of about 3*d.* per perch. There is great advantage in leaving the drains open till the peat has subsided, for if covered in at once the channels are apt to be filled up; the surface will in the meantime be better fitted to benefit from tillage, and from the application of lime. Where the peat is thin, the surface will be sufficiently dry to be ploughed by oxen, or by horses working in pattens; the former animals are now exclusively used for all reclamation work; they not only travel better over soft ground, but are far less liable to injure themselves when required to strain at a dead-pull, when the plough strikes against a boulder or buried root. There was at one time great difficulty in reducing the furrow of turf after the plough; ordinary harrows often failed to penetrate it, and it had to be chopped up by hand-power. A great advantage has been obtained from the use of Randall's Pulverising Harrow, an American invention, imported from Utica (Fig. 2).

Beneath the bar, to which the shafts are attached, there are two frames, each carrying 6 sharp-edged revolving discs, so arranged that they can be set obliquely at any angle to the line of draught. The discs are not plain, but are slightly dished, the concave side being inwards. Each disc cuts into the furrow, and pushes the strip it has cut towards the centre of the machine. Whenever the furrow is tough, the weight of the driver increases the cutting-power of the harrow. The work done by this machine is excellent, and it is of great service in comminuting turf and peat. When the bog is not firm enough after draining for ploughing, it must be dug by hand and thrown up in ridges or lazy beds, 4 feet wide. The next operation should be the application of lime, which materially assists in disintegrating the soil, and at the same time neutralises the acids in it. The effects of lime are well known to the peasantry, who expressively say that it "boils the bog." On soft ground the lime used to be carried

Fig. 2.—View of Randall's Pulverising Harrow.

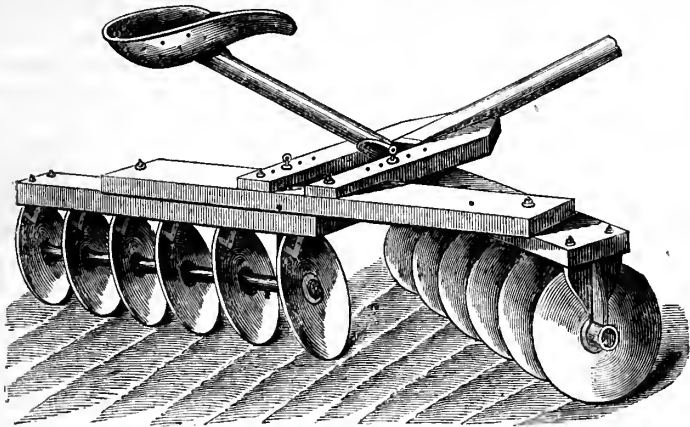

out by women in baskets upon their backs: where the ground was somewhat firmer, it was done by an ox drawing a small sledge. In either case it was a tedious process, as the sledge only contained 3 or 4 bushels of lime, and yet was drawn with difficulty over the rougher places and through the occasional patches of soft bog. Within the last few months 400 yards of Decauville's Portable Tramway has been purchased, and has proved so convenient for spreading lime and manures on the bog, that Mr. MacAlister anticipates that it will reduce the cost of reclamation 2*l.* per acre. After the liming, as much as possible of the land is put into root-crops, with farmyard-manure for potatoes and turnips; and these have usually been followed by oats laid down with clover and grass-seed. In some instances grass-seeds have been sown at once without any intervening crop; but there is great difficulty in obtaining a tilth fine enough for grass-seeds, and the best results have hitherto been obtained by taking a root-crop first.

I will now return to the cultivation that has been carried on at Mweelin. A second piece of deep peat, 11 acres in area, was drained and brought into cultivation 8 years ago, at a total cost of 113*l.* As this plot is immediately in front of the castle, on the opposite side of the lake, it was desirable to get a good sward of grass as quickly as possible. The drains were put in, 30 feet apart, no turf was removed, 150 bushels of lime per statute acre were applied, and a half-dressing of farmyard-manure. The land was trenched and planted with potatoes and



turnips. The potatoes were poor; the turnips yielded 10 tons to the statute acre. The next crop, oats, not manured, yielded 10 cwt. to the acre: Italian and perennial ryegrass, with Timothy and cocksfoot, were sown with the oats, and cut two years for hay, yielding good crops without a top-dressing. The first year there were 14, and the second year 11 tram-cocks to the acre, each weighing 12 to 14 cwt. of hay when carried to the rick. The grass was cut at the end of June, and carried to the rick-yard in August. The grass then failed, yielding a miserable crop the third year. It was ploughed up June 1876, and received 150 bushels of lime and 6 to 8 tons of dung per acre. At the end of July it was sown with rape and grass-seeds. In June 1877 there was a fair crop, which was cut green for horses, about 18 inches high and rather thin on the ground.

The next township of Addergoole had a considerable amount of labour and capital expended upon it, before it passed into Mr. Henry's possession. It contains 958 acres, and was purchased soon after the famine by Mr. Eastwood, an Englishman, who built himself a house, a lodge, and some very substantial farm-buildings. From the size of the buildings it must be concluded that he contemplated the reclamation of a much larger extent of land than what he brought under cultivation. A large quadrangle is surrounded by stables, sheds, and other buildings, fit for 500 acres of arable land. In the centre of the side opposite to the entrance gate there is a large barn built in the shape of a cross, 60 feet long in each direction. These buildings were erected with some of the stones from the ruins of a deserted village; the rest of the stones were used to fill up the bed of a small river which Mr. Eastwood diverted, and to form the bank of the new cut. He reclaimed 60 acres of land in the old river-bed, a gravel soil resting upon peat. After levelling the land, he planted part of it and laid the rest down to grass. He also reclaimed 30 acres of deep bog; the work was done well but expensively, although at that time wages were only 5s. per week. At the present time wages are 9s. a week. We may well wonder how the poor fellows could manage to live upon 5s. a week, but, as one of them explained, with pathetic humour, "When all's ate the dinner's over." Mr. Henry has already brought 20 additional acres into cultivation, and has commenced the drainage of 100 acres more.

The chief accommodation for live-stock is at Addergoole. Of horses there are 29 on the estate; only 6 of these are kept for farm work, but occasional help is given by carriage-horses or old pensioners. Three pairs of oxen have been kept for ploughing, and the best workers have been found to be those crossed with the Alderney—small, active, and very tractable. About 130 other





exertions have received a great impetus from the example set them by their landlord. Mr. Blake, the original owner of the property, settled upon Dowrosmore the pauper-tenants from other townships who remained after the famine. Creggaun, Cross, Shanaveag, and five-sixths of the township of Currewongaun, are in the hands of tenants, and improvements are carried out by them chiefly by manual labour.

Recent legislation has done much to encourage reclamation by tenants, by giving them security that they shall reap the full benefit of their labour. They no longer fear to improve their houses or their land, and the effect of this is already well marked in most parts of Ireland.\*

Mr. Henry is of opinion that the landlords are already benefited by a rise in the market-value of their land. He thinks that the small tenants (under 10*l.*) should have leases for twenty years, renewable at their option, the rent to be adjusted by valuation for each lease. This would virtually amount to fixity of tenure. The spirit of improvement is of very gradual growth, but may be encouraged: with this object lime has been *given* to the most enterprising of the tenants. A few grass and turnip-seeds given to one man excited jealousy among his neighbours, and now several of them vary their cropping, instead of confining themselves to growing potatoes, with an occasional crop of oats. At present they are not ready to receive any benefit that would involve an increase in their rent, however small.

A part of Currewangaun is kept in hand, and 25 acres have been improved: comprising 8 acres of barley seeded, 5 acres oats, 4 acres grass, and 8 acres drained, but not yet cropped. The crop of barley proved a poor one in 1877; being short in straw and light in grain, the whole will be cut into chaff and steamed for the fattening beasts.

At Mullaghglass improvements have been made both by tenants and landlord. The best land lies along the coast, from 100 to 200 feet above the sea; the eastern portion of it is let with the houses upon it to twenty-seven tenants, paying a total

---

\* In connection with this subject, the following returns of the number of persons who emigrated from all Ireland during the years 1867 to 1876 will be of interest:—

1867 .. .. .	80,624	1872 .. .. .	78,102
1868 .. .. .	61,018	1873 .. .. .	90,149
1869 .. .. .	66,568	1874 .. .. .	73,182
1870 .. .. .	74,855	1875 .. .. .	51,462
1871 .. .. .	71,240	1876 .. .. .	38,315

During the first six months of 1877, 18,945 persons emigrated, while the number for the corresponding period of 1876 was 20,604. This shows that, from whatever cause, there is a very obvious turn in the tide of Irish emigration.

rent of 94*l.* 10*s.* The western portion comprises 214 acres (Nos. 1 to 10 in the plan). It was depopulated during the

Fig. 3.—Sketch-map of Mullaghlass and part of Tooreena.

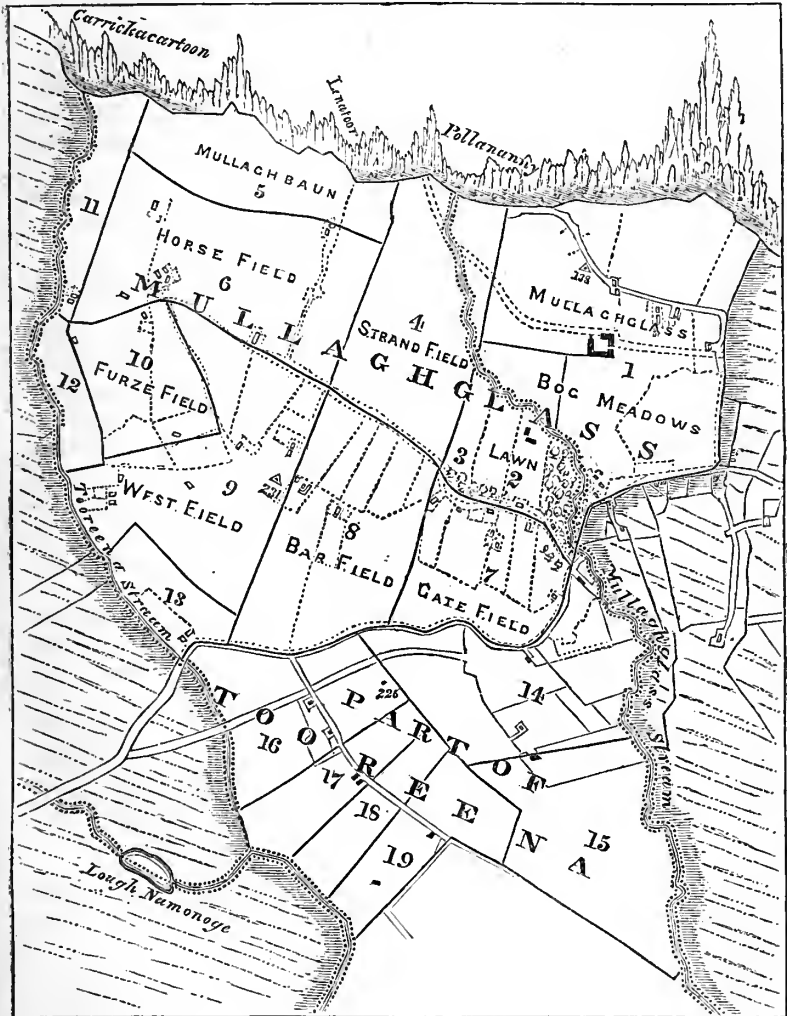

famine, and was let as a beach-farm to Mr. Currie in 1860 for 120*l.* A house and farm-building had been erected by the Wilberforces at a cost of 800*l.* The rent was subsequently

reduced to 110*l.*, but the tenant died in 1865, and the land is now occupied by the owner. Beach-farms are of great value to a grazier for the summer-grazing of stock. For the privilege of turning out a cow on such land cottagers pay 1*s.* 6*d.* per month. During winter the cattle are kept alive on the black sedge that grows in the valleys. Calves are reared and kept in the cottages till they are one or two years old; they are then sold either to small graziers, or direct to the larger graziers, who drive their herds of cattle to the fairs, or sell them to jobbers, either for the English market or to go into Leinster, where they are fattened on grass and turnips. The graziers in Connaught do not aspire to fatten their cattle; their object is to "warm" them upon the beach-farms, so that they shall be strong enough to be driven to the fairs. At the end of an average winter but few of the cottagers' cattle are in a condition to be driven any distance.

The average prices obtained by the cottagers are, for cattle at twelve months old, 2*l.* to 3*l.*; at two years, 5*l.* to 6*l.*

Graziers with small herds will obtain for two-year-olds 6*l.* to 7*l.*, and for three-year-olds, 8*l.* to 9*l.* After they have been warmed on the large grazing-farms, four-year-olds will fetch from 13*l.* to 16*l.*

The best turnips upon the estate have this year been grown at Mullaghglass, averaging more than 18 tons per acre.

As the land of this farm, however, was formerly under spade-tillage, it is not a fair example of the reclamation of waste land, and it will therefore not be worth while to enter fully into the details of its cultivation.

The following is an abstract of the amount spent during the last two years in farm-labour upon this farm, and upon the one which will be taken next in order and with fuller details.

ABSTRACT OF FARM LABOUR.

Three Months ending	Mullaghglass, Nos. 1 to 10.	Tooreena, Nos. 20 to 28.
	£ s. d.	£ s. d.
1875 31st December ..	55 19 4	97 12 1½
1876 1st April .. ..	73 6 7	72 16 4½
„ 1st July .. ..	76 7 5	159 13 5
„ 30th September ..	118 10 9½	171 15 4½
„ 30th December ..	81 5 10	121 3 10½
1877 31st March .. ..	82 13 6	79 3 9
„ 30th June .. ..	101 18 7	174 9 0½
„ 29th September ..	140 2 11	166 19 3½
„ 29th December ..	132 12 9	74 1 4
Total 27 months ..	862 17 8½	1117 14 7

Fig. 4.—Sketch-map of part of Tooreena.

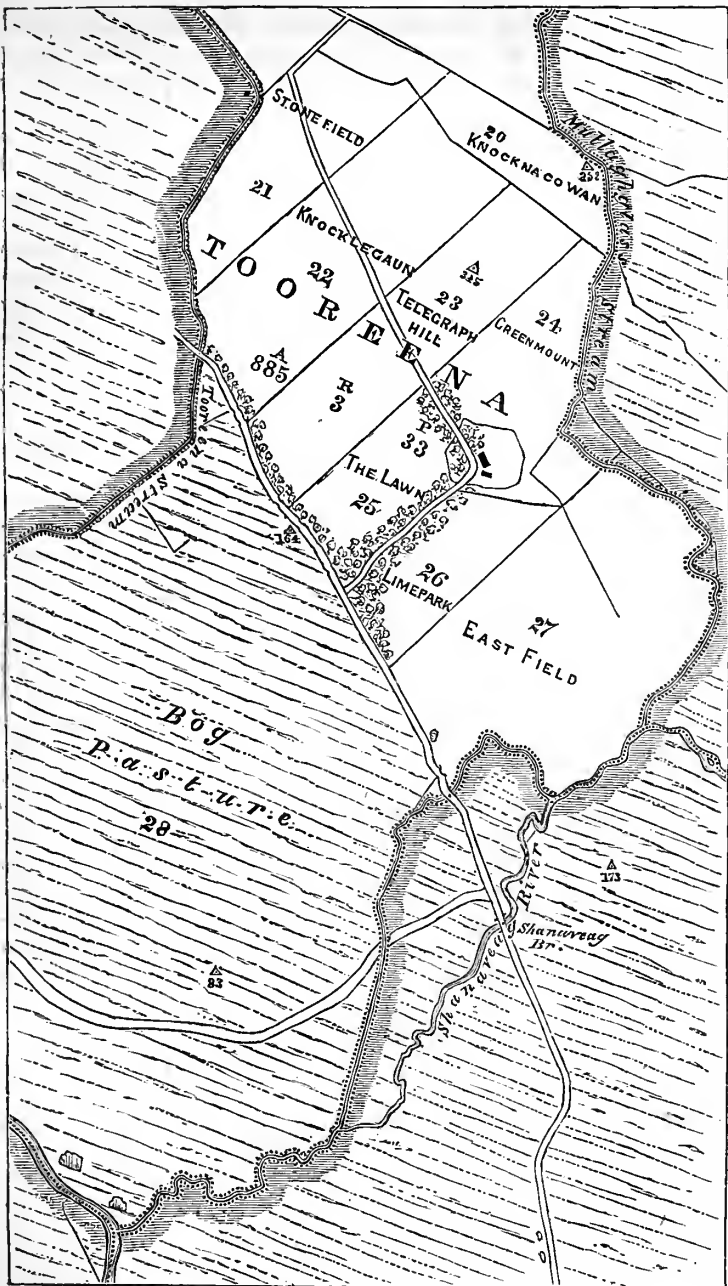

At Tooreena there are nine cottages : these are let, with 103 acres of land, in fields numbered 11 to 19 on the plan (Fig. 3), the tenants paying an aggregate rental of 27*l.* The remaining 633 acres of the township were let with no house upon them for 20*l.*, subsequently reduced to 15*l.* per annum. As the tenant did not succeed in paying even the reduced rent, Mr. Henry took this land in hand in 1874, and has been gradually reclaiming a great portion of it. There are 373 acres of it (No. 28, extending beyond the limits of the plan, Fig. 4) deep bog, resting on Silurian rock ; this part is not an inviting subject for cultivation, and as yet it has been only sheep-drained. It is intended, however, to reclaim about 40 acres of it near the road, where the peat is not so deep as elsewhere. The remaining 260 acres are moorland, mostly having a southern aspect. A gravelly subsoil of drift formation is covered with a thin growth of peat, averaging 20 inches in depth. About 150 acres of this land was bearing crops in 1877, and the rest of it is now being reclaimed. The land lies on a low hill, some 600 feet high, in a conspicuous part of the property, where the eye is refreshed by the broad patch of verdure standing up amid the sombre majesty of darker and more lofty hills.

With the exception of a very small patch of two or three acres, close to the new buildings, no part of this land shows any marks of previous cultivation ; it is therefore an excellent example of the cultivation of waste land ; and it will be worth while to give a somewhat detailed account of the work that has been done. On entering the farm from the high road, one may notice that the gate-posts are none of them of wood ; in the absence of timber of local growth rough boulder-stones are used as posts, sometimes a single stone being sufficient, while in other cases three large stones have been piled one on the other and clamped with iron. Boulder stones varying from a hundredweight to a ton had occasionally to be removed from the land, and it was as easy to make them into cyclopean gate-posts as to break them up and obtain other posts from a distance. The fences are formed of ditch and bank, planted with alders and fuchsia, with some osier and thorn. The fuchsia grows freely from cuttings, and stands the winter well ; there are hedges of it in Letterfrack that have stood for thirty years ; where they have not been kept down, they are 10 to 12 feet high. As a fence on level ground, it is very inferior in efficacy to thorn, but it is quick growing, and soon forms a sufficient and ornamental protection, combined with the ditch and bank. The formation of fences and the draining of the land were the first operations undertaken in 1874. In that year, and the first nine months of 1875, 446*l.* 8*s.* 4*d.* was expended in wages. The sum of 55*l.* 7*s.* 4*d.* was expended in



1874 in building a small cottage and a stable for one pair of horses and one pair of oxen; since that time the cottage has been enlarged, and some more accommodation has been provided for cattle; the cost of this labour is included in the return already given on page 220 of the wages paid since September 1875, viz., 1117*l.* 14*s.* 7*d.* The total amount, therefore, expended up to December 1877 in wages upon this farm has been 1619*l.* 10*s.* 3*d.*

I will now take the fields in numerical order as they are given in the plan of the farm (Fig. 4):—

No. 20. *Knocknagowan* contains 20 a. 0 r. 34 p.; has been fenced, and is now being drained. The fencing is done by contract at 1*s.* 4*d.* per Irish perch of 7 yards; the ditch is dug 4 feet deep, with a breadth of 6 feet at top and 4 feet at bottom. The bank is planted with alders, costing 15*s.* per 1000. The drains that have been cut in this field do not pass through the bottom of the peat; the contractors receive 8*s.* per clamp of 8 × 8 × 8 feet for the turf.

No. 21. *Stone Park*, 26 a. 2 r. 3 p.—The name of this park—or field, as it would be called in England—indicates its character; a thin covering of turf rests upon a gravelly subsoil containing a great number of stones of all sizes. The subsoil being very open and porous, cultivation was at first tried without draining, but the result has not been satisfactory. In January 1876, 8 acres north of the road were ploughed by oxen, at a cost of 30*s.* per acre; in May it was worked with the American disc-harrows, and seeded with rape and a cheap lot of Timothy, cocksfoot, and clover. The seeds failed, and the land was ploughed again in 1877, after having been stone-drained 3 feet deep and 40 feet apart. The drains cost 6*d.* per Irish perch for digging; the rest of the work is done by the day. A channel is roughly built with large stones at the bottom of the drain, and the gravel is filled in over this. Two bullocks were occupied one week drawing stones. The expenditure on the 8 acres has been—

	£	s.	d.
8 acres ploughing, at 30 <i>s.</i> .. .. .	12	0	0
8 „ harrowing by disc-harrow, at 5 <i>s.</i> .. .. .	2	0	0
Rape and grass seeds .. .. .	6	0	0
320 perches drains dug, at 6 <i>d.</i> .. .. .	8	0	0
Wages for carting stones, and filling in .. .. .	6	0	0
Two oxen, one week .. .. .	1	0	0
8 acres ploughed by oxen, at 20 <i>s.</i> .. .. .	8	0	0
	<hr/>		
	£43	0	0

An additional 3 acres have been recently ploughed.

No. 22. *Knocklegaun*, 45 a. 2 r.—In this field, in 1877, there were 20 acres grass north of the road, and 10 acres in oats below the road. Of the 20 acres in grass, 10 acres to the west were drained in 1874, and the 10 to the east a year later. The following is a summary of their cropping:—

10 acres west.	Drained and ploughed in .. .. .	1874
	Oats .. .. .	1875
	Oats .. .. .	1876
	Grass cut for hay .. .. .	1877
10 acres east.	Drained 45, 50 and 60 feet apart .. .. .	1875
	Oats .. .. .	1876
	Grass cut for hay .. .. .	1877

A careful inspection of this grass early in June showed that all the finer grasses had failed; the only grass then growing was the Yorkshire fog (*Holcus lanatus*), an inferior natural grass commonly found on poor moorland. Many rushes were growing between the drains, which were evidently too far apart. The crop of hay was 1 ton per acre.

The 10 acres below the road were ploughed in 1874; turf-drained in 1875, 40 feet apart and 3 feet deep; sown with oats in 1876 and again in 1877, grass-seeds being sown with the second crop.

It will be noticed that the ploughing in this field preceded the draining; this can only be done with advantage where the ground is firm. The ploughing cost 35s. per acre and the drains 52s. per acre for digging, and 26s. for sodding and covering. The oats in 1876 were a bad crop. The crop growing in June 1877 looked very thin and poor, partly from want of lime and partly from the drains being too far apart. The crop was cut green and made into hay.

No. 23. *Telegraph Hill*, 29 a. 3 r. 28 p.—At the south end of this field there are 4 acres above the lower road, which have recently been turf-drained 4 feet deep and 21 feet apart; the digging by contract cost 11l. 16s. Sodding and filling by day-work cost 5l. 8s., a total cost of 4l. 6s. per acre.

Between these 4 acres and the upper road there are two pieces of 6 acres each, cropped respectively with oats and turnips.

The 6 acres on the west were, in 1875, ploughed, harrowed, and drained, but received no lime or dung. In 1876 the land was ridged by hand, at a cost of 13l. 10s., and top-dressed with nearly 5 cwt. per acre of a mixture of guano and Lawes's turnip manure; 28 cwt. was applied to the 6 acres, at a cost of 8s. 6d. per cwt.; turnips were then sown; the first thinning cost 4s. and the second 3s. per acre. The crop, about 20 tons per acre, was carted off the land. In 1877 the land was ploughed by bullocks at 10s. per acre, and harrowed. Oats were sown and top-dressed with  $\frac{1}{2}$  cwt. nitrate of soda, and  $1\frac{1}{2}$  cwt. Lawes's manure, at a cost of 20s. per acre. The seed sown was 12 stone to the statute acre, and is believed not to have been sufficient for newly reclaimed land. The crop looked thin in June; it yielded 8 cwt. oats and 16 cwt. of straw per acre.

The 6 acres on the east have been cropped thus:—

1875. Ploughed, drained, and lined.

1876. Oats, top-dressed with 1 cwt. guano and  $2\frac{1}{2}$  cwt. superphosphate, yielded a fair crop. The land was then ploughed and harrowed. In the spring of 1877 it received a half-dressing of dung, and was then ridged by hand-labour; this occupied 11 men for three weeks, and cost 13l. 8s. 7d. The dung was carted to the side of the field, and carried out by girls in baskets upon their backs in the way that is usual in the district. 22 cwt. of fertilizers, costing 8s. 6d. per cwt., were applied as a top-dressing over the piece, and it was then sown with turnips. The crop was estimated by Mr. MacAllister at fully 12 cwt. per acre.

Immediately above the upper road, 3 a. 1 r. were manured in 1874 with sea-sand, except a small strip which received a dressing of lime instead of sand. Sand was delivered by contract at 1s. per load, and 10 loads were put to the acre. The lime did not show so well as the sand for the first year, but has had a greater effect since.

The cropping has been, 1875 and 1876, oats; 1877, turnips. Above the turnips there are 6 acres in grass, 3 acres of which were sown in 1875, and the other 3 acres in 1876. The cultivation of the first sown portion has been in—

1874. Drained 40 feet apart and ploughed by pair of horses.

1875. In June, limed with 150 bushels per acre. Harrowed with Howard's harrows, and then chopped with spades, 10 men working two days, at a cost of 30s. Sown with rape and grass seeds covered by a chain harrow.

1876. Cut green for bullocks, a good crop; part cut a second time.

1877. Top-dressed with 2 cwt. superphosphate and 1 cwt. nitrate of soda per acre, at a cost of 25s. An inspection of this grass early in June showed that the herbage was chiefly fog-grass with a little Italian ryegrass and a very little Timothy. The cocksfoot appeared to have died out. The other 3 acres were treated in the same way, but a year later. The ryegrass here was vigorous, and gave a good promise for hay.

Mr. MacAllister reports the yield from these two plots as 25 cwt. got together in very good condition, and that it will be worth 4*l.* a ton to Mr. Henry for consumption by the riding and carriage-horses. The remaining 5 acres at the top of this field have been drained and ploughed, but not yet cropped.

No. 24. *Green Mount*, 29 a. 0 r. 31 p. In the name of this field we may find an indication of the fact that in its original state it was one of the best fields in the neighbourhood for natural grasses. Cattle that had been wintered upon the black sedge in the valleys, were driven to such fields as this to feed upon the white sedge in the spring, and by the month of June they would be sufficiently "warmed," *i. e.* strong enough to be driven to the fairs, or sold for England or Leinster. A part of this field has been left in its primitive condition. A neighbouring grazier, of much experience, estimated the best grass upon it as worth 2*s.* 6*d.* per acre in its natural state. The herbage consists chiefly of white and black sedge, with small heath, and a little grass. 8 acres at the top of this field have been recently drained. In November 1876, the land was ploughed by 2 oxen, a man, and 2 boys, at a cost of 30*s.* per acre. They did an acre in three days, finishing the piece in four weeks. One boy led the oxen, and the other was employed in clearing the ploughshare of the long fibres of the peat.

The drains have been dug by contract, 24 feet apart. The following has been the cost on the 8 acres:—

	£	s.	d.
Wages of man and 2 boys ploughing .. .. .	5	4	0
"    "    "    American harrowing .. .. .	0	15	3
2 oxen, reckoned at 1 <i>l.</i> each per week, probably cost less	8	0	0
Draining, digging 483 perches, at 6 <i>d.</i> .. .. .	12	1	6
"    digging 109    "    8 <i>d.</i> .. .. .	3	12	8
Sodding and levelling by day work, about .. .. .	8	0	0
<b>Total .. ..</b>	<b>£4 14s. 2d.</b>	<b>per acre..</b>	<b>.. .. £37 13 5</b>

The next piece is 12 acres in grass; the cost of its cultivation will be given in full detail as a good example of the cost of laying down to grass without taking an intermediate crop.

Oct., 1874.—Ploughed by horses, 1 acre in 3 days ..	35 <i>s.</i> per acre	£21	0
May, 1875.—Drained 40 feet apart, sodded and levelled	35 <i>s.</i> ..	21	0
June, 1875.—Limed 150 bushels per acre, at 4 <i>d.</i> .. ..	50 <i>s.</i> ..	30	0
	Per acre		
Carting lime, at 1 <i>s.</i> 4 <i>d.</i> per load of 12 bushels ..	16 <i>s.</i> 8 <i>d.</i> ..		
Drawing out lime on sledge, 2 days' work for } ox, at 2 <i>s.</i> ; and boy, at 1 <i>s.</i> per diem .. .. }	6 <i>s.</i> .. ..	24 <i>s.</i> 2 <i>d.</i> ..	14 10
Spreading lime .. .. .	1 <i>s.</i> 6 <i>d.</i> ..		
Harrowing with zigzag harrows, 2 oxen and 1 boy ..	5 <i>s.</i> ..	3	0
Seeds:—7 lbs. Rape, 7 <i>s.</i> ; 1 bush. Perennial Ryegrass, 6 <i>s.</i> ; 1 bush. Italian Ryegrass, 5 <i>s.</i> ; 6 lbs. Cocksfoot, 6 <i>s.</i> ; 6 lbs. Timothy, 6 <i>s.</i> ; 6 lbs. Mixed Clover, 6 <i>s.</i> .. ..	36 <i>s.</i> ..	21	12
July 15th, 1875.—Sowing broadcast, chain-harrowing, and rolling .. .. .	5 <i>s.</i> ..	3	0
Superphosphate, 3 cwt. at 7 <i>s.</i> ; Guano, 1 cwt. at 14 <i>s.</i> ..	35 <i>s.</i> ..	2	0
<b>Total .. ..</b>	<b>£11 5s. 2d.</b> ..	<b>136</b>	<b>2</b>

On November 12th, 1875, 180 lambs had the run of these 12 acres, with other land, till 17th March, 1876.

The first crop was cut for hay in July 1876, and was estimated at 30 cwt. per statute acre.

The cost of making and carrying the hay was not ascertained. On 15th April, 1877, it was top-dressed with nitrate of soda, 1 cwt. at 15s.; super-phosphate, 2 cwt. at 14s.; broad-casting and harrowing, 1s.; total, 30s. per acre, 18*l*. The artificials were sown on a windy day, and were not mixed with ashes, hence the lines of sowing were very clearly marked in June. The grass was then rank immediately over the drains, but the crop as a whole was rather poor, especially so on the level land at the top, where the peat attains a depth of 3 feet. On the slope of the hill the peat is about half that depth, and the grass there is much better. The crop yielded 20 cwt. of hay. It is intended to put intermediate drains between those already put in; this will add nearly 20s. per acre, and make the total cost of draining about 55s. I must also take 1*l*. per acre for the cost of the buildings and fences over the 260 acres of moorland on the farm.

The total cost for building, fencing, draining, breaking up with the plough, and liming, will thus be 8*l*. 5s. per acre, a very moderate outlay for fitting the land for cultivation. The subsequent work is the usual routine of the farm, but some economy might be effected in it by sowing only rape and ryegrass seed: the 18s. spent on the finer grasses and on clover is evidently thrown away. The land will not be fitted for these until it has been longer under cultivation. The artificials would be more efficient if mixed with ashes or sand before sowing, and it will probably be better to substitute some ammoniacal manure for the nitrate of soda, which in such an extremely wet climate must be dissolved and washed into the drains before it can be taken up by the crop.

The only part of the farm that has been previously cultivated is a corner of this field close to the farm buildings. A well and the foundation of an old cabin remain in the middle of 4 acres of lapsed land, cultivated sixty years ago. These 4 acres were ploughed and drained in 1874, cropped in 1875 with oats, in 1876 with turnips, and in 1877 with oats, seeded down, the yield was 8 cwt. of oats and 16 cwt. of straw per acre.

No. 25. *The Lawn*, 19 a. 1 r. 38 p.—The most interesting plot in this field is a portion of the 4 acres in grass after oats in 1876 and potatoes in 1875. This plot of grass is generally well up to the average in condition, but a strip next to the road is of marked superiority, being quite the best grass on the farm. It received a dressing of sea-weed and coral-sand, and is strong in ryegrass, with a little cocksfoot, the only cocksfoot to be found on the farm in June 1877. Timothy grass could not be found; being a very small seed, it was probably buried too deep by the chain-harrow. There is very little fog-grass, and no rushes are to be found on the strip. The grass adjoining is not nearly so good where no sand was put. Coral-sand is of the utmost value for reclaiming bog-land, and it is a pity that it cannot be obtained in sufficient quantity near the farm. Even deep peat, when it is near the shore, may be profitably reclaimed by sand and sea-weed. An excellent illustration of this may be observed very near the Kylemore property at the head of Barnaderg Bay. A tenant proprietor has there some splendid gardens of potatoes growing on the deep peat, and only manured by frequent applications of sea-weed and coral-sand. 12 acres of oats were grown in the Lawn in 1877, half of them after oats yielded 8 cwt. of oats, 35 lbs. to the bushel, and 16 cwt. of straw per acre; the other 6 acres were after potatoes, a poor crop, yielding only 4 cwt. of oats, 30 lbs. to the bushel, and 10 cwt. of straw.

1 acre of potatoes in this field yielded 2 tons of sound and 6 cwt. of diseased tubers.

No. 26. *Lime Park*, 25 a.—A part of this field is occupied by a plantation by the side of the road. 3 acres were sown with rape and grass seeds in 1876, and yielded about 25 cwt. of hay; 8 acres of this field were in oats in 1877; where a full dressing of lime had been applied, the erop was 8 cwt. of oats and 16 cwt. of straw; but only 5 cwt. of oats and 12 cwt. of straw were obtained where less lime had been spread.

3 acres of potatoes were grown, and yielded 5 tons 10 cwt. of tubers of all descriptions.

A crop of 14 tons of turnips per acre was obtained over 8 acres; one-third of these were fed off by sheep, and the rest were carted to the buildings.

The roots are all grown in lazy beds. The land, having previously been drained, ploughed, and disc-harrowed, was trenched by hand. The men work in gangs under a gaffer or foreman. He commonly has 11 men under him, never 12, lest it should bring bad luck. The gaffer, with a Scotch spade shaped like a hay-cutting knife, marks out the lines of a series of trenches 18 inches wide; one man in each trench lays the spits he digs out alternately right and left of him, and thus forms the ridges between the trenches. The lime was drawn by ox-sledge to the corner of the piece that was being trenched by the gaffer or contractor, 2 of his men carried it thence on a hand-barrow to the ridge, and it was spread with the same long-handled spades that are used for the digging.

No. 27. *East Field*, 60 a. 0 r. 22 p.—This field has been fenced in, and 6 acres of it have been ploughed up, but no draining, except making surface sheep-drains, has been done. 3 acres have been eropped with turnips, and yielded 5 tons per acre.

No. 28. *Bog Pasture*, 373 a. 2 r.—It is intended that 40 acres shall be reclaimed here, but the work has not yet commenced.

The following table gives a summary of the cropping of Tooreena Farm in 1877:—

No.		Oats.	Grass.	Turnips.	Potatoes.	Ploughed and Drained.	Ploughed or Drained.	Total.
21	Stone Field .. ..	..	..	..	..	8	..	8
22	Knocklegaun ..	10	20	..	..	..	4	34
23	Telegraph Hill ..	6	6	9	..	5	..	26
24	Green Mount ..	4	12	..	..	8	..	24
25	The Lawn .. ..	12	4	..	1	..	..	17
26	Lime Park .. ..	8	3	8	3	..	..	22
27	East Field .. ..	..	..	3	..	..	3	6
		40	45	20	4	21	7	137

It thus appears that at the 30th December, 1877, 109 acres had been cropped, 21 acres ploughed and drained, 4 acres drained and 3 acres ploughed. The total expended in wages upon the 260 acres of moorland at Tooreena was 1619*l.* 10*s.* 3*d.* The greater part of this was of course spent on the 137 acres entered in the table; but as all the land has been fenced, and the buildings put up will serve for the whole area, it may fairly be



estimated that an average of 11*l.* per acre has been spent in wages upon the 109 acres that have been cropped. Unfortunately I cannot obtain an exact return of the total amount that has been expended on lime and artificial manures, for Mr. MacAllister is not able to separate the latter from the general expenditure on the Kylemore property. I may, however, safely take the expense of liming at 50*s.* per acre. The cost of the artificial manures will vary considerably with the different crops: for the two hay crops grown on Green Mount (pp. 225, 226), it was 35*s.* and 29*s.* per acre respectively. I shall probably be not far wrong if I assume that the cost of the artificial manures, the materials used in the buildings and the plants purchased for the hedges will in the aggregate be equal to the value of the crops which have been hitherto grown. The produce of the farm will be chiefly consumed at home. 250 hoggets were brought from the mountain farms to Toorena on the 1st of December, and were wintered on the 25 cwt. per acre of the small turnips left on the ground, with the run of the new grasses. The value of this feed is reckoned at 4*s.* per head. Eight beasts are being fattened on turnips, hay, and oats in the straw, cut into chaff, with 4 stone of Indian corn and oilcake; it is estimated that they will leave a profit of 6*l.* each to the credit of farm produce. The three working oxen employed at permanent improvements, not charged to the crop, are estimated to return a value of 12*l.* each per annum for the turnips, hay, chopped oats and grass which they consume. Six young beasts are wintered, and will yield 2*l.* each. One acre of potatoes was consumed on the farm by the ploughmen, the refuse goes to the cattle, and the rest will be required for seed. Seven tons of straw have been sent, and there will be 5 more to spare for the stables at the castle, at 2*s.* 6*d.* per cwt. Five tons of oats will be sold to the castle at 8*s.* per cwt.

The total amount to be credited to the farm is thus made up to the sum of 216*l.* :—

	£
12 tons straw, at 2 <i>s.</i> 6 <i>d.</i> per cwt. .. ..	30
5 " oats " 8 <i>s.</i> " .. ..	40
Wintering 250 hoggetts at 4 <i>s.</i> .. ..	50
Fattening 8 beasts on turnips, &c. at 6 <i>l.</i> .. ..	48
Wintering 6 young beasts, at 2 <i>l.</i> .. ..	12
Keep of 3 working oxen .. ..	36
	£216

Thirty Kyloes were grazed on the unreclaimed portion of the farm for six summer months. The wool sold is credited to the mountain farms. The expense incurred for implements has been trifling. The whole of the implements and utensils



upon this farm were valued at 46*l.* 4*s.* on the 1st of February, 1878, the principal items being:—

	£	s.
2 ploughs (Gray's), at 3 <i>l.</i> 10 <i>s.</i> each .. ..	7	0
2 harrows .. ..	5	0
1 cart and harness .. ..	10	0
2 sets plough harness .. ..	3	0
4 sledges .. ..	2	0
American disc-harrow .. ..	4	0
Hay cutter, Richmond and Chandler's .. ..	2	0
Turnip pulper, Nicholson's .. ..	2	10

A three-horse threshing-machine from the Reading Iron Works is moved from farm to farm as wanted.

I have now finished with the township of Toorena, and shall not have occasion to describe in any such detail the work that has been done on other parts of the property. East and West Lettergash are occupied by fifty tenants; the best land lies, as usual, along the shore, inland it is mountainous, and not capable of much improvement. There is a prospect, however, of a great improvement in another direction; excellent schools have been recently built, and under a competent master and mistress the children show great aptitude for learning, and have acquired habits of cleanliness and neatness that contrast most favourably with those surrounding them.

At Lemnaheltia and Pollacappul great changes have been made by the planting of trees and gardens, but, with the exception of 2*l.* spent on sheep-drains on the mountain side, ornament has been studied rather than economy in these improvements.

In considering how far the reclamations have been successful, one may look at the result as it severally affects the proprietor, the labourer, and the country generally. I cannot yet say that any of the land, as it now stands, would command such an increased rent as to insure a good return for the capital expended upon it. In such a climate, few men would venture to take an arable farm, and there is much yet to be done before the land can be considered fairly laid down for grazing. Upon the home-farm of an estate, however, much may be done with advantage that would not be profitable to a mere tenant. Considerable quantities of hay, straw, and oats, are required, and there are many advantages in obtaining these on the spot without incurring the cost of long carriage. There can be little doubt that, as a general improvement to the property, these reclamations have a very considerable value. This is not the place to discuss a question of the residential value of property; but any one who has been long amongst dark peat-bogs and barren mountains, will understand how great an ornament in such a landscape is a patch of cultivated land.

The experiment is not yet sufficiently advanced to say whether or not the reclamation of Tooreena will be a direct pecuniary success. One great point in favour of the undertaking is, that comparatively little money has been sunk in building. Land-improvers not unfrequently begin by putting up buildings at such a cost, that the chance of a profit is almost thrown away at the first step. The advice of Solomon is sound in agricultural matters still. "Prepare thy work without, and make it fit for thyself in the field; and afterwards build thine house." There is every reason to anticipate great advantage from the system recently adopted of putting the drains much nearer together than they were at first. The benefit is not confined to getting rid of the excess of moisture; the land is much improved by the soil thrown out from the bottom of the drain and spread over the surface. Over much of the moorland the drains are dug through 2 feet of soil underlying the peat; even where this subsoil is pure sand, it will mechanically improve the soil, but in many places it contains an appreciable quantity of clay that adds much to its value. The drains that are being cut in Green Mount, field No. 24, pass through 2 feet of peat, then through 6 inches of "mother earth," a light-brown sandy soil, and then into a bluish-grey subsoil, of which a sample was taken and subsequently analysed by Dr. Voelcker with the following result:—

*General Composition of sample of Subsoil dried at 212° Fahr.*

Organic matter and water of combination	.. ..	3·15
Oxide of iron and alumina	.. .. .	12·62
Lime	.. .. .	·16
Magnesia and alkalies	.. .. .	·42
Insoluble siliceous matter (fine sand and clay)	..	83·65

---

100·00

Dr. Voelcker remarks that the subsoil "contains merely traces of lime and, as far as I can judge, is poor stuff. It contains some clay, but its bulk is made up of fine micaceous sand. Nevertheless, it may be put with advantage upon peaty land, for even pure sand, and much more a mixture of sand and clay, will consolidate spongy peat land, and add mineral matters so much wanted in peaty soils." The quantity of soil to be spread over the surface will now be twice as great as it was before. Turf drains that were formed at Letterfrack nearly thirty years ago are still sound and unbroken; they cost nothing for materials, while the labour can be obtained at a very low rate in almost unlimited quantity. No part of the outlay is likely to give a better pecuniary return than that which is spent in wages, while one cannot but feel that the real benefit of the out-

lay does not stop there. No one can enter into an agricultural problem without being forced to pay some attention to the social questions connected with it. One cannot look at the work without inquiring about the labourers. In approaching one of the numerous gangs, the first glance may give one the idea that they are a party of somewhat ragged boys. A nearer view will show that they are men, but most of them under-sized. The whole race of the Connemara district has been affected by the famines of the past and the meagre diet of the present time. In the matter of clothing, however, things may look worse than they really are, for while darning and patching seem almost unknown, economy develops itself in another direction. In wet weather it is customary to put on the most weather-tight garments first, while the most ragged ones only go on as a further protection.

Most of these men occupy a bit of land, which they prepare for potatoes early in the spring. As soon as their own work is done, early in April, they come to work at the reclamations, and it is a great boon to them to get work near home, although the wages are much lower than they might earn in England. Boys are taken on to work at 5s. and 6s., while ordinary labourers earn 9s., and the gaffers or foremen 12s. to 15s. per week. Girls earn 9d. per diem, and are rapidly learning to hoe turnips, a lighter work than the carrying of turf and manure which usually falls to their lot. Saints'-days and fairs are kept as holidays, and sadly interfere with work and wages. In spite of these interruptions, the men are gradually acquiring habits of steadier labour than they have been used to, and are learning to appreciate the value of methodical work. Some of them have already begun to drain their own land, and in other ways to follow the example of improved tillage.

The number of men that apply for work is a sufficient proof that the wages are not too low for the district. The labour-book shows that in May 1877 the average number of day labourers at Kylemore was 240, including many carpenters and bricklayers, who, with the men and boys attending on them, average 12s. per week, and gardeners averaging 9s. per week.

It may be asked, Would it not be better for the men to leave the district altogether, and live where their labour can be more profitably employed, either in cultivating for themselves a more fruitful soil, or in earning higher wages? No doubt it would be best for all those who are unencumbered, but some have old folks dependent on them, and with all, the love of home is very strong. If it were obviously best, they cannot be forced away against their will; and the only question that remains for them is, is it better to work for themselves or to earn wages from

another? There is a vast amount of waste in the hand-tillage of the Irish cotter; the same labour applied methodically on a farm where horses or oxen are employed will add much more to the wealth of the country. The labourer will himself live much better on 8s. or 9s. a week, than on the produce of his bit of hand-tilled land. The great and perhaps sole advantage of the cotter-system is that something is laid by against old age. The man who has reclaimed a bit of land, and is allowed by his landlord to reap the full benefit of his labour, will, in his old age, continue to pay a rent of 2s. 6d. or 5s. for land that he has made worth 20s. or more an acre. The labourers at Kylemore do not sacrifice their home advantages by working for hire during a great part of the year. Home is home, be it ever so homely, and the love of home is nowhere stronger than among the pure Celts of Connemara: a gentle, honest, childlike race, in a very low state of civilisation, from which they can only be raised by cautious steps. An amusing illustration of this occurred in the last cottage on the estate that was shared by man and beast. For some years a cattle-shed, built close to the cottage, remained unoccupied, because it would break the old man's heart to turn the cows out of the living-room. When the old man died, the young people consented to put the cattle in the shed and keep the room for human beings only.

The allotment of waste land among our labouring classes has been advocated from time to time by well-meaning men, who hope that by spade-husbandry the labourer will raise himself in the social scale. No encouragement can be derived for such a scheme from the experience of Kylemore. The lesson to be learned here is that any such attempt can only result in the waste of labour and the degradation of the man. The Irish cotter has long occupied land at a low rent, with a tenure in most cases virtually, though not legally, secure. His position is much lower physically, morally, and socially, than that of any class of men earning day-wages in the British Islands. From a social point of view, the chief merit of these works of reclamation is that they afford the poor cotter an opportunity to raise himself gradually from that miserable state of living from hand to mouth in which he has so long been sunk. A bad crop of potatoes brings want and suffering always in its wake, and a single failure would even now bring back famine to the district. Prevention is far better than the cure of such calamities. While there is no encouragement for those who would settle our now uncultivated land with peasant proprietors, there is much here that may be suggestive to those who own similar tracts of land, and wish to recognise the responsibilities as well as the privileges which the ownership of property entails.

IX.—*Report on the Health of Animals of the Farm in 1877.*  
By W. DUGUID, F.R.C.V.S.

GREAT anxiety was caused among the stockowners of this country during the earlier months of the past year by the importation of cattle affected with Rinderpest, and the spread of this plague not only within but beyond the metropolitan area, where it first appeared. On the 16th of January, 39 animals arrived from Hamburg on board 'The Castor,' and were landed at Deptford Foreign Cattle Market. Previous to shipment they had been examined on the 12th by the Government Inspector at Hamburg, who gave a certificate stating that they were in perfect health, when some of them must have been almost dying of the disease. One actually died on the passage, and twenty-seven more died before they could be slaughtered.

The Veterinary Department of the Privy Council were aware of the existence of rinderpest in Germany, and had warned the whole of the Inspectors at the ports previous to the arrival of 'The Castor' with her diseased cargo.

The Inspector at Deptford at once detected the condition of the plague-stricken animals, and every precaution was taken to prevent any spread of the virus, by isolation and the free use of disinfectants, while the process of slaughter was being carried out. No difficulty was experienced in dealing with the carcasses of these animals at Deptford, where special facilities for the purpose exist. After slaughter they were placed in iron digesters and subjected to the action of steam at a temperature of 400°, and there was every reason to believe that, as had been the case in 1872, the disease would not extend beyond the confines of the place where these cattle had been landed. It was supposed that the slaughter of plague-stricken animals and the destruction of their carcasses at the port of landing would be sufficient to prevent the further spread of this bovine pest; but it now appears that no authority exists to prevent the virus being carried by the passengers or crew of the vessel in which the diseased animals have been carried; and in the case of 'The Castor,' she landed a general cargo at the wharf belonging to her owners before any means of disinfecting the vessel could be adopted.

On the 29th of January a disease of a suspicious nature was discovered in a dairy at Limehouse, and on the 31st, when Professor Brown visited the premises, there was no doubt that the animals were affected with cattle-plague. The whole were at once destroyed, and an order was issued by the Government prohibiting the removal of cattle and sheep from the metropolis.

The expediency of this order was soon apparent, for even then the contagion had obtained considerable hold, as was proved by the fact that during the next six days, by the 6th of February, no less than seven dairies in the Limehouse district had been declared infected.

Orders were then issued to prohibit all sales in the lairs and markets of the metropolis, unless by special licence, and it was also enacted that all animals exposed for sale should be marked for immediate slaughter, so that, in the case of any evasion of the law, such animals could be readily recognised. Notwithstanding these prompt measures, the disease still continued to spread, and by the 20th of February several more outbreaks were reported in the metropolis, and two had occurred about a mile and a half beyond. While this extension in the East of London was taking place, much fresh alarm was created by the appearance of the plague in Hull, on the 18th of February. This outbreak was not, as at first supposed, due to contagion carried from London, and its source could not in the first instance be traced. As the result of an inquiry made by the local authority regarding the health of stock in Hull, it was found that one dairyman had disposed of the whole of his stock, and refused to assign any reason for so doing, merely stating that he had sold them to a butcher. The inference to be drawn from this is that they were diseased; and it seems very probable that they were affected with cattle-plague. Further inquiry elicited the following facts:—On the 12th and 14th of January two cargoes of animals were landed at Hull from the same sheds in Hamburg where the Deptford cargo had been housed. Soon after the arrival of one of these cargoes, one animal presented peculiar symptoms, from the description of which, and the *post-mortem* appearances reported by the Inspector, Professor Brown came to the conclusion that the animal was suffering from cattle-plague; and we have thus evidence of the importation of the plague into London and Hull from the same infected sheds in Hamburg, in January. The disease spread from this original centre in Hull to several other dairies, and on the 8th of March an outbreak was discovered on a farm at Beelsby, near Grimsby, in Lincolnshire. The inquiry which was instituted did not result in the source of the infection being traced; but it can scarcely be doubted that the poison was conveyed, in some indirect way, by the agency of people or things that had been in contact with diseased animals in Hull.

The continued extension of the disease in and around London led to the Privy Council, at the suggestion of the Royal Agricultural Society, taking charge of the Metropolitan Police-district. The order under which the functions of the local authorities in



regard to cattle-plague were assumed by the Privy Council came in force on April 16th, and at that time fresh outbreaks were almost of daily occurrence. Energetic measures were at once adopted, and proved so successful that from May 1st to May 15th no cases were reported. On the latter date a small outbreak took place in Whitechapel, and this was considered for some time the last that would be heard of cattle-plague in this country, until we had some fresh importation. Such, however, was not the case; and another outbreak occurred in the Bethnal Green district on the 14th of July. In this, as in many of the other cases, no direct communication with diseased animals could be traced: but there can be no doubt that in some unexplained way the poison had been preserved, for the most rigid inquiry failed to elicit any evidence of the re-introduction of the virus from abroad.

By the beginning of July the restrictions on the movement of cattle and the holding of markets which had been made by various local authorities had been removed. The re-appearance of the disease in the metropolis, after two months' cessation, showed the necessity for continuing the regulations in London for some time longer, and they were not entirely removed until the beginning of December, although no further case of rinderpest occurred.

The different outbreaks may be stated as follows:—There were altogether 47 outbreaks in England, among 2000 head of cattle; of which 835 were slaughtered healthy, the remainder either died from the disease or were slaughtered, and their carcasses were either destroyed or buried deeply and covered with lime.

In the several counties the outbreaks were as follows:—

In Essex, 6. Among 23 cattle, of which 15 were slaughtered healthy, 8 were attacked with the disease, of which 7 were killed and 1 died.

In Lincolnshire one outbreak occurred. Among 24 cattle, of which 18 were healthy and 6 diseased, all were at once slaughtered.

In Middlesex (ex-metropolis) there were 5 outbreaks. Among 425 animals, of which 17 died from the disease, 86 diseased and 322 healthy animals were killed.

In York (East Riding), there were 7 outbreaks. Among 65 cattle; 2 died from the disease; 17 diseased and 46 healthy were killed.

In the metropolis the outbreaks, including the one on the 14th of July, were 28. Among 563 animals, of which 434 were slaughtered healthy, 1 escaped, 128 were attacked, of which 113 were killed and 15 died.

A Select Committee of the House of Commons was appointed to take evidence and inquire into the question of cattle-plague and importation of live-stock. Their Report and recommendations on the subject were laid before Parliament by the end of last Session, and legislation on the question is now in progress.

This visitation of rinderpest proves that even the slaughter of plague-stricken animals at the port of landing is not sufficient to prevent the spread of the virus; so powerful is this poison in infective properties, that the smallest quantity carried by people or things that have been in contact with diseased animals is capable of spreading the malady; and therefore unless the vessel, cargo, and crew are immediately taken charge of and dealt with in such a manner as to insure our safety, we may, while importation of live-stock is allowed under existing regulations, at any time have another visitation of this dire scourge.

*Blood-poisoning.*—Only two outbreaks of this nature came under my observation during the past year. The first of these occurred in March on a farm near Chelmsford, where some twenty animals were attacked with splenic apoplexy in a few days. It was at first rumoured that the disease was cattle-plague, which at that time existed in Essex, but the history of the outbreak, the symptoms of the disease, its rapid course (some animals dying in a few hours), and the *post-mortem* appearances, clearly proved the nature of the disease. The high feeding of the animals, producing a plethoric condition, had no doubt much to do with the origin of the disease. A change in the mode of feeding arrested the further progress of the malady, which would certainly not have been the case had the virus of cattle-plague been introduced on the premises.

In August an outbreak of splenic apoplexy took place among a herd of dairy stock on a farm near Yeovil, in Somersetshire. The pastures lay along the valley of the Yeo, and one meadow where the disease first appeared was opposite the outflow of the sewage of Yeovil into the river. The meadows had been more or less flooded during the winter and spring, and no doubt this excessive moisture, under the influence of the warm weather, had produced a rapid vegetation, with a considerable quantity of decaying vegetable matter on the surface of the soil.

Owing to a number of animals being suddenly taken ill, it was at first supposed that they were poisoned by drinking the sewage-contaminated water of the river. There was, however, no evidence that any of them had done so, and, in addition, they had access to the river above the sewage outfall. The condition of the meadow and the herbage were such as have frequently been described where cases of blood-poisoning have occurred, and moreover one animal died from the disease in a

meadow on the opposite side of the river above the point of any sewage contamination.

The removal of the cows from these pastures, and the substitution of a small quantity of good sound hay as part of their food, arrested the further progress of the malady.

*Foot-and-Mouth Disease.*—Towards the close of 1876 fears were entertained that after the decline of this disease to a few centres it would again extend among young stock, which possessed no immunity by passing through it in the wide-spread epizootic of 1874-5.

A few cases were detected in the Metropolitan Cattle Market, which had for some time been free. The restrictions, however, imposed on the movements of stock, and the closing for a time of some of the markets in several counties owing to the existence of cattle-plague in the country, limited very materially the spread of this disease. Since the withdrawal of the cattle-plague regulations, during the past three or four months, several outbreaks of foot-and-mouth disease have been reported, but in most cases only a few animals have been affected, and the disease has been of a mild type. Some counties that have formerly suffered severely from this scourge are now free, and in others the number of animals affected during the last quarter of the past year has been very small.

In Newcastle, where the disease had not been seen since March, an outbreak occurred in four salesmen's lairs in the week ending December 22nd, among Scotch and Irish beasts kept over from the previous week's market.

*Pleuro-pneumonia.*—The extension to Ireland of the regulations relating to this disease, has, according to competent authorities, produced a very marked effect in limiting its spread. In Norfolk little more than half the number of cases have been reported in 1877 as compared with the previous year, and this has been attributed chiefly to the slaughter of and compensation for diseased animals in Ireland.

In addition to this, we must not fail to recognise the restrictions placed on the movement of cattle and the closing of some fairs for a time, while rinderpest existed, as a means of preventing the spread of pleuro-pneumonia, as well as other contagious diseases. Among dairy-stock in the metropolis this malady has been rather prevalent for the past three or four months. At the time I wished to find infected sheds in which to place inoculated animals, as a test of the value of this measure as a preventive, more than twenty places, all within the metropolitan area, were available for the purpose as infected premises. One great difficulty in dealing with this disease is due to the prolonged period of incubation in which the poison remains in a

latent form, and animals that have cohabited with the diseased are not suspected when they are even capable of spreading the contagion.

In carrying out the regulations of the Contagious Diseases (Animals) Act relating to pleuro-pneumonia, in many cases the local authorities are satisfied with the slaughter of the actually diseased animals, and the disinfection of the stalls where they stood. The premises are declared an infected place, but no further notice is taken of the apparently healthy animals until another case is reported. A careful examination of the whole of the stock would often lead to the detection of the disease in some animals at a very early stage, and their separation from the rest of the herd would in many cases prevent the further spread of the virus.

*Sheep-scab* has prevailed to a considerable extent in many parts of the country, more particularly in Wales and Yorkshire; during the last quarter of the year no less than 1060 cases were reported in the East and some 770 in the North Riding.

In Somerset, also, there have been 640 cases recently; while in some other counties where sheep-farming is carried on extensively this malady is almost if not quite extinct.

---

X.—*Report of the Field and Feeding Experiments conducted at Woburn, on behalf of the Royal Agricultural Society of England, during the year 1877. (Presented to the Chemical Committee, December 11, 1877.)*

#### THE EXPERIMENTS ON THE CONTINUOUS GROWTH OF WHEAT.

*Stack-yard Field.*—The wheat crop of 1876, grown by the late tenant, yielded per acre—

25½ bushels dressed corn.

20½ cwts. straw.

The seed of the first experimental crop was sown during the first week of November (1876). The description selected was Browick, being that usually grown in the neighbourhood. The dung and the mineral manures were applied before the seed was sown. The salts of ammonia and nitrate of soda were top-dressed in the spring.

The produce obtained is given in the following table:—

PRODUCE OF WHEAT; FIRST SEASON, 1877.

Plots.	MANURES PER ACRE.	PRODUCE PER ACRE.		
		Dressed Corn.		Straw, &c.
		Quantity.	Weight. per Bushel.	
		Bushels.	lbs.	Cwts.
1	Unmanured .. .. .	22½	61·8	20¾
2	200 lbs. Ammonia-salts, alone (applied in the Spring) .. .. .	34½	60·9	37½
3	275 lbs. Nitrate Soda (applied in the Spring) .. .. .	31¾	60·6	34¼
4	200 lbs. Sulph. Potass, 100 lbs. Sulph. Soda, 100 lbs. Sulph. Magnesia, 3½ cwts. Superphosphate of Lime .. .. .	20½	61·4	20
5	200 lbs. Sulph. Potass, 100 lbs. Sulph. Soda, 100 lbs. Sulph. Magnesia, 3½ cwts. Superphosphate of Lime, and 200 lbs. Ammonia-salts (in Spring) .. .. .	33¾	60·9	39
6	200 lbs. Sulph. Potass, 100 lbs. Sulph. Soda, 100 lbs. Sulph. Magnesia, 3½ cwts. Superphosphate of Lime, and 275 lbs. Nitrate Soda (in Spring) .. .. .	32	60·3	36¾
7	Unmanured .. .. .	20¾	61·1	19¾
8	200 lbs. Sulph. Potass, 100 lbs. Sulph. Soda, 100 lbs. Sulph. Magnesia, 3½ cwts. Superphosphate of Lime, and 400 lbs. Ammonia-salts (in Spring) .. .. .	43¾	62·1	48¾
9	200 lbs. Sulph. Potass, 100 lbs. Sulph. Soda, 100 lbs. Sulph. Magnesia, 3½ cwts. Superphosphate of Lime, and 550 lbs. Nitrate Soda (in Spring) .. .. .	39¾	61·2	42¾
10	Farmyard-manure; estimated to contain Nitrogen = 100 lbs. Ammonia (not specially made, as there was not time to make it, 6 tons of well turned-over manure taken from the yard) .. .. .	18	60·0	18¾
11	Farmyard-manure; estimated to contain Nitrogen = 200 lbs. Ammonia (not specially made, as there was not time to make it, 12 tons of well turned-over manure taken from the yard).. .. .	18¾	60·4	20½

The more noticeable features of the results are as follows:—

There was an entire absence of any beneficial effects from the application of the farmyard-dung, or from that of mineral manures without nitrogen. A given amount of nitrogen, applied as ammonia salts, was more effective than the same amount applied as nitrate of soda. This was the case whether they were used alone, in the same quantity in conjunction with mineral manures, or in double quantity with the same mineral manures. The superiority of the ammonia-salts over the nitrate showed

itself, in each case, in the yield of grain per acre, in the weight per bushel of the grain, and in the quantity of straw; and it was quite evident to the eye on inspection of the crop just before harvest. The corn was riper, and the straw was of a better colour, with the ammonia-salts than with the nitrate.

The absence of all effect from the farmyard-manure is very remarkable. Owing to the long continuance of wet weather during the winter (1876-7), there may have been a considerable loss of the soluble nitrogen of the manure by drainage through such a porous soil; but this supposition does not seem to afford a sufficient explanation of the entire want of action.

The absence of all effect from mineral manures, used alone, must be taken to show that the previous wheat crop had gathered up all the available nitrogen from the soil, excepting so much as the unmanured crop could make use of. On the other hand, the large increase of produce, amounting to from 10 to 13 bushels of corn, and from 14 to 17 cwts. of straw, per acre, by the application of ammonia-salts or nitrate of soda alone, shows that the soil contained, in an available condition, sufficient of all the necessary mineral constituents for the crop.

When, in conjunction with mineral manures, nitrogen = 50 lbs. of ammonia per acre was applied, either as ammonia-salts or as nitrate of soda, more increase of produce was obtained for a given amount of nitrogen in the manure, than when nitrogen = 100 lbs. of ammonia per acre was so applied. It thus appears that the larger amount of soluble nitrogen was more than could be turned to account by the growing crop in the particular soil and season. Yet, nitrogen = 100 lbs., and 200 lbs. ammonia per acre, when applied as dung, was without effect.

#### THE EXPERIMENTS ON THE CONTINUOUS GROWTH OF BARLEY.

*Stack-yard Field.*—The experimental barley, like the experimental wheat, was grown after the wheat crop of 1876, taken by the previous tenant, as already referred to. The manures applied for the barley were the same as those for the wheat. For the wheat the dung was taken from the yard; for one plot in quantity estimated to contain nitrogen corresponding to 100 lbs., and for the other to 200 lbs. ammonia per acre. For the barley, however, the dung was made in the experimental boxes, at Crawley Mill Farm, and, both food and litter being weighed, the composition of the dung applied could be estimated with greater accuracy.

The following table shows the produce obtained:—



PRODUCE OF BARLEY. FIRST SEASON, 1877.

Plots.	MANURES PER ACRE.	PRODUCE PER ACRE.		
		Dressed Corn.		Straw, &c.
		Quantity.	Weight per Bushel.	
		Bushels.	lbs.	Cwts.
1	Unmanured .. .. .	22 $\frac{1}{2}$	54.4	13 $\frac{1}{2}$
2	200 lbs. Ammonia-salts .. .. .	35 $\frac{1}{2}$	54.9	23 $\frac{1}{2}$
3	275 lbs. Nitrate Soda .. .. .	26 $\frac{1}{2}$	54.7	19 $\frac{1}{4}$
4	200 lbs. Sulph. Potass, 100 lbs. Sulph. Soda, 100 lbs. Sulph. Magnesia, 3 $\frac{1}{2}$ cwts. Super- phosphate of Lime .. .. .	18 $\frac{1}{2}$	53.9	11 $\frac{3}{4}$
5	200 lbs. Sulph. Potass, 100 lbs. Sulph. Soda, 100 lbs. Sulph. Magnesia, 3 $\frac{1}{2}$ cwts. Super- phosphate of Lime, and 200 lbs. Am- monia-salts .. .. .	38 $\frac{1}{2}$	55.3	25 $\frac{1}{2}$
6	200 lbs. Sulph. Potass, 100 lbs. Sulph. Soda, 100 lbs. Sulph. Magnesia, 3 $\frac{1}{2}$ cwts. Super- phosphate of Lime, and 275 lbs. Nitrate Soda .. .. .	33 $\frac{1}{2}$	54.7	22 $\frac{1}{2}$
7	Unmanured .. .. .	19 $\frac{1}{2}$	54.6	12
8	200 lbs. Sulph. Potass, 100 lbs. Sulph. Soda, 100 lbs. Sulph. Magnesia, 3 $\frac{1}{2}$ cwts. Super- phosphate of Lime, and 400 lbs. Am- monia-salts .. .. .	52 $\frac{1}{2}$	56.1	35 $\frac{1}{2}$
9	200 lbs. Sulph. Potass, 100 lbs. Sulph. Soda, 100 lbs. Sulph. Magnesia, 3 $\frac{1}{2}$ cwts. Super- phosphate of Lime, and 550 lbs. Nitrate Soda .. .. .	49 $\frac{1}{2}$	55.0	32 $\frac{1}{2}$
10	Farmyard-manure; estimated to contain Nitrogen = 100 lbs. Ammonia; made from 376 lbs. Cotton-cake, 940 lbs. maize- meal, 12,857 lbs. Mangolds, 3215 lbs. Wheat-straw Chaff, as food; and 316 $\frac{1}{2}$ lbs. Barley-straw, as litter. Weight, 5 tons, 10 $\frac{1}{2}$ cwts. .. .. .	18 $\frac{1}{2}$	55.6	11 $\frac{1}{2}$
11	Farmyard-manure; estimated to contain Nitrogen = 200 lbs. Ammonia; made from 752 lbs. Cotton-cake, 1880 lbs. Maize-meal, 25,714 lbs. Mangolds, 6430 lbs. Wheat-straw Chaff, as food; and 6328 lbs. Barley-straw, as litter. Weight, 11 tons 1 cwt. .. .. .	26 $\frac{1}{2}$	54.2	15 $\frac{1}{2}$

There is a very close resemblance between the effects of the different manures on the barley and on the wheat. Mineral manures alone gave no increase of crop; whilst ammonia-salts alone, or nitrate of soda alone, gave a very considerable increase. As with the wheat, the ammonia-salts produced more effect than the nitrate, whether used alone or in conjunction with mineral manures; and whether (with mineral manures) in quantity cor-

responding to 50 lbs., or to 100 lbs. ammonia per acre. It is especially remarkable that, when these nitrogenous manures were used alone, that is without mineral manure, the ammonia-salts gave  $8\frac{1}{2}$  bushels more barley than the nitrate of soda containing the same amount of nitrogen. Nitrate of soda is more subject to loss by drainage than are ammonia-salts; and the result may be partly due to more washing out in its case; but probably in a greater degree to the nitrate having been sown later than the ammonia-salts, and possibly unfavourably late for the soil and season, compared with the sowing of the ammonia-salts.

The dung for the barley not having been applied until the spring, it was not subject to the same risk of washing out, and loss by the winter rains, as that for the wheat. Still, the dung produced no effect on the barley when applied in quantity estimated to contain nitrogen corresponding to 100 lbs. of ammonia per acre; the produce being only 18 bushels; whereas, ammonia-salts (with minerals), in quantity equal to 100 lbs. of ammonia, gave  $52\frac{1}{2}$  bushels; or nearly three times as much. Lastly, dung containing nitrogen corresponding to 200 lbs. of ammonia per acre gave only  $26\frac{1}{2}$  bushels of barley.

Thus, the results of the first year's experiments, on this light and porous soil, have shown, with both wheat and barley, very striking effects of nitrogen applied in the soluble condition of ammonia-salts or nitrate of soda.

#### THE EXPERIMENTS ON ROTATION.

*Stack-yard Field.*—Rotation No. 1; four acres as under.

1877 Seeds.  
1878 Wheat.  
1879 Roots.  
1880 Barley.

The four acres of clover and ryegrass have been fed-off by sheep during the summer, and the land is now sown with wheat. On one acre 728 lbs. of decorticated cotton-cake have been consumed; on a second acre the same quantity of maize meal; and the third and fourth acres were separately eaten off without any purchased food. On one of these, artificial manure, supplying nitrogen and other constituents, equal to those estimated to be contained in the manure from the 728 lbs. of consumed cotton-cake, and on the other equal to those in the manure from the 728 lbs. of consumed maize-meal, will be applied for the wheat in the spring. The crop of seeds being better on one side of the land than on the other, the sheep having no purchased food

were put on that part. The periods during which the sheep were kept upon the land were from May 10 until nearly the end of July, and from the latter end of August until the middle of October.

The following table shows the number of sheep fed on each acre, the quantity of purchased food consumed (if any), the number of weeks the animals were kept on the land, and the total increase in live-weight yielded.

SEEDS, 1877.

Plots.		Increase in Live- weight.
		lbs.
1	Fed-off by 10 Sheep, with 728 lbs. Cotton-cake; on the land 15 weeks .. .. .	303
2	Fed-off by 10 Sheep, with 728 lbs. Maize-meal; on the land 15 weeks .. .. .	275
3	Fed-off by 10 Sheep, without other food; on the land 14½ weeks .. .. .	214
4	Fed-off by 10 Sheep, without other food; on the land 13½ weeks .. .. .	209½

Deducting the amount of increase in live-weight obtained without purchased food from that obtained with it, the amount of increase so reckoned as due to the cotton-cake is 91¼ lbs., and that to the maize-meal 63¼ lbs. Both with the oxen in the boxes and here with the sheep in the field a given weight of cotton-cake has yielded more increase than an equal weight of maize-meal. Owing, however, to the small number of oxen and somewhat small number of sheep under experiment, the results must not be taken as conclusive on the point. It is proposed to carry out experiments with a much larger number of animals next year.

Rotation No. 2 ; four acres as under.

- 1877 Roots.
- 1878 Barley.
- 1879 Seeds. :
- 1880 Wheat.

Mangolds were sown on these four acres, which were respectively manured as under:—one acre with dung made from a given quantity of straw as litter, and of mangolds and wheat straw-chaff as food, with 1000 lbs. cotton-cake consumed in addition; the second acre with dung from the same amount of litter, and of mangolds and wheat-straw chaff as food, with

1000 lbs. maize-meal in addition; the third and fourth acres each with dung from the same amount of litter, and of mangolds and wheat-straw chaff as food, without any purchased food in addition; but one of them received artificial manure, supplying two-thirds as much nitrogen and as much of the other constituents as were estimated to be contained in the manure from the 1000 lbs. of cotton-cake; and the other received artificial manure supplying the whole of the nitrogen, and other constituents, estimated to be contained in the manure from the 1000 lbs. maize-meal.

The amounts of produce obtained are recorded in the following table:—

## MANGOLDS, 1877.

Plots.		PRODUCE PER ACRE.	
		Roots.	Leaves.
1	With Dung, made from 3230 lbs. Straw, as litter; 5000 lbs. Mangolds, 1250 lbs. Wheat-straw Chaff, and 1000 lbs. Cotton-cake .. .. . With Dung, made from 3230 lbs. Straw, as litter; 5000 lbs. Mangolds, 1250 lbs. Wheat-straw Chaff, and 1000 lbs. Maize-meal .. .. . With Dung, made from 3230 lbs. Straw, as litter; 5000 lbs. Mangolds, 1250 lbs. Wheat-straw Chaff; and Artificial Manure, containing two-thirds as much Nitrogen, and the other constituents, of the Manure from 1000 lbs. Cotton-cake; namely, 248 lbs. Nitrate Soda, 100 lbs. Bone-ash (made into Superphosphate), 62½ lbs. Sulphate Potass, and 65 lbs. Sulphate Magnesia .. .. . With Dung, made from 3230 lbs. Straw, as litter; 5000 lbs. Mangolds, 1250 lbs. Wheat-straw Chaff; and Artificial Manure, containing as much Nitro- gen, and other constituents, as the Manure from 1000 lbs. Maize-meal; namely, 80 lbs. Nitrate Soda, 16½ lbs. Bone-ash (made into Superphos- phate), 7 lbs. Sulphate Potass, and 11 lbs. Sulphate Magnesia .. .. .	tons. cwt.	tons. cwt.
2		3 17	2 15
3		2 1½	1 16½
4		7 4½	3 8½
		3 16½	2 11½

As compared with ordinary agricultural crops, these weights are but small. The quantity of dung applied was, however, only from 3 to 4 tons per acre; whereas in ordinary farming 20 or even 30 tons are often applied for this crop. The following considerations will show why this could not be done in these experiments. The object of the Woburn Rotation experiments is to measure the effects, throughout the course, of the manure produced by the consumption of a given quantity of one cattle-food, against those of the manure from an equal quantity of another food; and at the same time to compare these with

artificial manures estimated to supply the same amounts of the most important constituents as the manure from those foods. The arrangements adopted to attain this object involve the application of the following quantities of manure during the rotation of four years. On the cotton-cake acre, besides the manure from the litter, mangolds, and wheat-straw chaff, used in making the dung, that from 1728 lbs. of decorticated cotton-cake will be applied; 1000 lbs. of the cake having been already consumed in the production of the dung for the mangolds, 728 lbs. more will be consumed with the seed crop in 1879. And, as the mangolds will be consumed on the land with the addition of straw-chaff, and the seeds also will be consumed on the land, only the increase in live-weight, and the crops of barley and wheat-grain will be carried off for all this manure put on. Then the plot which is to receive, in artificial manure, the same amount of nitrogen as that estimated to be contained in the manure from the 1728 lbs. of cotton-cake, will have applied to it (besides the manure from the litter, and from the mangolds and wheat straw-chaff) 642 lbs. of nitrate of soda, which will be distributed as follows:—248 lbs. to the mangolds, 124 lbs. to the barley, and 270 lbs. to the wheat; whilst, as in the case of the cotton-cake manure, only the increase in live-weight, and the barley, and the wheat, will be exported. It will be obvious that if, with a view to get a heavy root-crop, much more manure had been applied, it would have been at the risk of having over-luxuriant and laid corn crops. Indeed, from the experience already gained with the continuous barley and wheat crops in the same field, the probability is that the manures applied will prove sufficient for maximum corn crops.

Thus, eight of the sixteen acres allotted to rotation have already been brought under experiment, and the remaining eight will be so next year. Twelve of the sixteen will then be under wheat, barley, and mangolds, growing under the influence of cake-dung, or maize-dung, or dung made without purchased food, but with equivalent artificial manure being applied instead. The remaining four acres will be in seeds, commencing without manure, but to be treated exactly as the four of Rotation No. 1.

For the second crop of the continuous wheat experiments the seed was sown at the beginning of November (1877). The manure for the dunged plots was made in the boxes applied to the land, and ploughed in. The mineral manures have also already been applied; but the ammonia-salts and the nitrate of soda will, as before, be top-dressed in the spring.

Both the continuous wheat and the continuous barley plots were kept thoroughly clean during the past season.

On the four acres of Rotation No. 2, sown with mangolds last spring, the growth of weeds was so great before the mangolds were well up, that the plant was retarded in its early stages. The season, too, was generally unfavourable for roots. But, if sufficiently highly manured, the crop of mangolds in *Stack-yard field* would, no doubt, have been equal to any in the neighbourhood in the same season. With the quantities of manure actually applied, much larger crops than those grown could hardly have been expected under the circumstances mentioned.

Crawley Hill Farm was given up by the late tenant in an exceedingly foul condition, and great expense has been incurred in endeavouring to clean it; but, owing to the very unfavourable character of the past summer, the efforts made have been only partially successful.

A. VOELCKER.

J. B. LAWES.

XI.—*Annual Report of the Consulting Chemist for 1877.*

By DR. AUGUSTUS VOELCKER, F.R.S.

IN the Annual Report for 1876 I stated that, during the period of December 1875 to December 1876, an unusually large number of oilcakes were sent to the Laboratory for examination, no less than 206 samples having been received during that period. In my present Report, I have to mention that only 136 samples of oilcakes were sent for analysis in the past season. This diminution in the number of cakes sent for examination finds a ready explanation in the fact that spring food was abundant and the hay crop good, and that there was less demand for purchased food in the past season than in the preceding one.

Grossly adulterated cakes, at present, are not sold so frequently as they were at one time, and little difficulty is experienced in most localities in obtaining pure linseed- and unadulterated cotton-cakes. Green German rape-cake has been very scarce, and only a few samples of good quality were received for examination. The superior feeding-value of green rape-cake appears to be better appreciated than formerly by Continental farmers, and, in consequence, but little German rape-cake is now imported into England.

The practice of selling linseed-cake made from imperfectly screened linseed as "pure," I regret to say, still continues, as will be seen from the following Quarterly Reports of the Chemical Committee (pp. 255 *et seq.*), in which reference is made to a number of cases of this kind.

Purchasers of linseed-cake should insist upon being supplied



with cake which is made from properly screened linseed, when they have bought cakes as "pure," and in accordance with the forms of guarantee previously recommended by the Chemical Committee. The examination of oilcakes for their purity entails no great amount of analytical work; and as members of the Royal Agricultural Society have the privilege of obtaining an opinion whether a cake is pure or not, in the course of a day or two and at the trifling expense of 5s. per sample, it is to be hoped that members of the Society will avail themselves of this privilege more frequently than hitherto.

The quality of the samples of American decorticated cotton-cake analysed by me in the past season was satisfactory; but some of the samples of ordinary or whole-seed cotton-cakes, received for examination in 1877, were not so good as they might have been, had the husks of the cotton-seeds been ground finer.

Coarsely ground cotton-seed husks are rather indigestible, and apt to cause constipation of the bowels, not unfrequently followed by inflammation; and hence it is desirable that all oil-crushers in producing cotton-cake should imitate the example of some makers, who reduce the cotton-seed husks to a finer condition than the majority of makers of English cotton-cake.

In connection with feeding-stuffs, I may mention that occasionally a species of millet, or Sorghum seed, known in commerce as Dari grain, is imported from Egypt into England, and sold at a more moderate price than that of feeding-barley.

Dari grain is a good food for poultry, and, ground into meal, an excellent fattening meal for cattle. As will be seen by the subjoined analysis of a sample lately analysed for a member of the Society, Dari grain contains an appreciable amount of ready-made fat and a large proportion of starch, which is with ease transformed into fat in the animal economy; but it is rather deficient in albuminoids, and for this reason Dari-meal should be given to stock in conjunction with cake, beans, or peas; or, speaking generally, with food rich in albuminous compounds:—

*Composition of Dari grain.*

Moisture .. .. .	11.31
Oil .. .. .	4.02
*Albuminous compounds (flesh-forming matters) ..	10.06
Starch and digestible fibre .. .. .	68.10
Woody fibre (cellulose) .. .. .	3.65
Mineral matter (ash) .. .. .	2.86
	<hr/>
	100.00
	<hr/>
* Containing nitrogen .. .. .	1.61

Malt-combs are used both for feeding and manuring purposes. Unless malt-combs are very dirty, and, like some samples of kiln-dust, contaminated with much soot or cinders, it appears to me wasteful to apply malt-dust as a direct manure to the land. Malt-combs, as will be seen by the following analyses of two samples analysed by me for a member of the Royal Agricultural Society of England, contain a large proportion of readily digestible food, which in a great measure will be wasted if they are applied to the land as a direct manure; and which may with advantage be utilised by passing the malt-combs through the animal body.

Malt-dust is a very useful addition to other food, for, apart from its intrinsic feeding-value, it promotes the digestibility of other food; and for this reason is particularly useful when coarse and somewhat indigestible food is given to sheep or cattle.

Malt-combs, likewise, may be given with great benefit to dairy-cows, for, like most articles of food rich in albuminoids, phosphate of lime and magnesia, and alkaline phosphates, constituents in which milk abounds, they possess high milk-producing qualities.

COMPOSITION OF TWO SAMPLES OF MALT-COMBS.

	No. 1.	No. 2.
Moisture .. .. .	10·83	5·74
*Albuminous compounds .. .. .	23·81	21·94
Non-nitrogenous organic matters .. .. .	58·70	66·12
Phosphate of lime and magnesia (bone- phosphates) .. .. .	1·49	1·97
† Alkaline salts .. .. .	4·06	2·40
Insoluble siliceous matter .. .. .	1·11	1·83
	100·00	100·00
* Containing nitrogen .. .. .	3·81	3·51
Equal to ammonia .. .. .	4·63	4·26
† Containing phosphoric acid .. .. .	·81	·65
Equal to tribasic phosphate of lime .. .. .	1·77	1·42
Total phosphoric acid .. .. .	1·49	1·55

With regard to the waters analysed by me in 1877, I have to report that a large proportion of them were found to be contaminated more or less with sewage or injurious drainage products, and were therefore unfit for drinking and general domestic purposes.

Potash-salts and sulphate of ammonia are generally sold

guaranteed to contain a given percentage of potash or ammonia. The samples examined by me were found to correspond with the guaranteed analyses.

The price of nitrate of soda rose considerably last March and April, which may probably account for the greater frequency of cases of adulterated samples which have been brought under my notice in the present year. In the Quarterly Report of the Chemical Committee for December (p. 257), attention was drawn to a flagrant case of the adulteration of nitrate of soda with common salt. I allude to this case in the Annual Report mainly for the purpose of directing once more attention to the fact that a high-priced article of commerce, like nitrate of soda, is particularly liable to be adulterated, and for this reason ought never to be purchased without a written guarantee of the quality of the nitrate, which should contain not less than 94 to 95 per cent. of pure nitrate of soda, or not more than 5 to 6 per cent. of impurities.

During the last twelve months a larger number of samples of Peruvian guano than in any previous year were sent to me for analysis by members of the Royal Agricultural Society. Peruvian guano is now shipped from the deposits in the south of Peru, and the quality of these deposits, as is well known to commercial men, varies greatly. Whilst some of the samples sent to my laboratory yielded from 9 to 10 per cent. of ammonia, others contained only from 3 to 4 per cent.

As a rule, the samples poor in ammonia I found richer in phosphates than guanos containing a high percentage of ammonia. It is scarcely necessary for me to state that the commercial value of Peruvian guano is more largely affected by its percentage of nitrogen than by that of the phosphates or any other constituent.

Peruvian guanos comparatively poor in ammonia and rich in phosphates may be used with advantage as manures for root-crops, or for hops, provided such guanos are sold at a price corresponding with the market-value at which guano-phosphates and ammonia can be bought. Under the present conditions of the guano-trade, intending purchasers of Peruvian guano are strongly advised not to be satisfied with the assurance readily enough given by dealers that the guano is genuine as imported, for a good deal of guano, though genuine, is of an inferior quality, and, in some cases, not worth more than one-half or two-thirds of the price at which the best qualities are sold. The proper course for agriculturists to pursue with reference to guano transactions is to buy guano only upon the strength of an analysis representing the quality of the sample which is offered for sale. On delivery of the bulk, about 10 lbs. should be taken

from a dozen bags, well mixed together, and the whole passed through a sieve. Of this well-mixed average sample about  $\frac{1}{2}$  lb., which is amply sufficient for analysis, should be sent to a competent analytical chemist, whose certificate will show at once whether the bulk on delivery agrees fairly with the quality as represented by the analysis which every dealer in guano ought to be able to produce.

Phosphatic guanos seldom find their way into the hands of agriculturists, as they are greatly in demand by manufacturers of artificial manures, who find them peculiarly well adapted for the production of concentrated superphosphates and similar manures.

One of the most recent importations of an excellent phosphatic guano is that from Lacepede Island, a small guano island in the South Pacific.

The following partial analyses represent the composition of four cargoes of Lacepede guano :—

	No. 1.	No. 2.	No. 3.	No. 4.
Moisture and organic matter .. .. .	16·32	19·01	21·15	19·85
*Phosphoric acid .. .. .	35·88	34·04	33·16	33·87
Lime .. .. .	42·22	40·71	40·29	40·85
Magnesia, oxide of iron and alumina ) carbonic acid, &c. .. .. . )	4·23	4·49	4·39	4·41
Insoluble siliceous matter .. .. .	1·35	1·75	1·01	1·02
	100·00	100·00	100·00	100·00
* Equal to tribasic phosphate of lime	78·33	74·31	72·39	72·94

Lacepede guano, it will be seen, is rich in phosphate of lime, and closely resembles in its general character Malden Island guano.

It appears in the shape of a light-brown powder, which, on exposure to a strong heat in a platinum capsule, leaves a perfectly white ash.

The brown colour is due to organic matter, varying to some extent in different samples. In virtue of the organic matter, Lacepede guano contains a small proportion of nitrogen, but no appreciable quantity of ready-formed ammonia.

The following analysis shows the detailed composition of one of the best samples of Lacepede guano which has been brought under my notice :—

*Detailed Composition of Lacedpede Guano.*

Moisture .. .. .	7·80
*Organic matter .. .. .	11·38
†Phosphoric acid .. .. .	34·62
Lime .. .. .	40·70
Oxide of iron .. .. .	·39
Alumina .. .. .	·74
Magnesia .. .. .	1·26
Carbonic acid .. .. .	·79
Sulphuric acid .. .. .	·88
Alkalies and loss in analysis .. .. .	·50
Insoluble siliceous matter .. .. .	·94
	100·00
* Containing nitrogen .. .. .	·63
Equal to ammonia .. .. .	·76
† Equal to tribasic phosphate of lime .. .. .	75·58

During the last twelve months a good deal of fish-guano, or dried fish, has been sent to England from America. Fish-guano, if dry and powdery, is an excellent concentrated fertiliser, approaching Peruvian guano in character.

The following analyses illustrate the variation in the composition of dried fish, or fish-guano :—

COMPOSITION OF DRIED FISH (FISH-GUANO).

	No. 1.	No. 2.	No. 3.	No. 4.	No. 5.
Moisture .. .. .	8·68	25·98	6·88	22·15	13·64
*Organic matter .. .. .	74·85	59·87	57·35	62·12	70·86
†Phosphoric acid .. .. .	6·63	5·22	14·42	6·76	6·58
Lime .. .. .	6·63	5·29	17·67	6·82	6·96
Magnesia, carbonic acid, &c. ..	2·80	3·49	3·49	1·81	1·65
Sand .. .. .	·41	·15	·19	·34	·31
	100·00	100·00	100·00	100·00	100·00
* Containing nitrogen ..	11·69	9·21	8·52	7·42	8·03
Equal to ammonia .. ..	14·19	11·18	10·34	9·01	9·75
† Equal to tribasic phos- phate of lime .. .. }	14·47	11·39	31·48	14·76	14·36

Dried fish, it will be seen by the preceding analyses, is a valuable fertiliser, and a very different material from much of the stuff which in England is sold to farmers under the name of fish-manure, at a low price varying from 2*l.* 2*s.* to 4*l.* 4*s.* a ton.

The analyses which I have made of samples of such fish-manures, during the last twelve months, confirm my previous experience that these and similar refuse-manures, which are sold at from 2*l.* to 4*l.* a ton, contain much water and valueless earthy matter, and are seldom worth more than half the price at which they are sold to small farmers, who, misled by the strong smell of rotten fish, and tempted by the low price at which these manures are offered for sale, are apt to pay far more for them than they are worth.

Wheat and other cereal grains, as is well known, are often steeped in a solution of sulphate of copper, with a view to the prevention of smut in the grain. Salt and lime sometimes are used for the same purpose, and occasionally coal-tar and preparations containing crude carbolic acid are employed for dressing seed-corn. If proper care be taken to guard against accidents, which may occur when wheat steeped in a solution of blue vitriol is left loose about the premises and accessible to fowls, no objection can be taken to the use of this salt as an efficient means of protecting wheat against smut; still there is some risk that the wheat impregnated with the poisonous copper-salt may be picked up by birds, and do mischief; and as coal-tar, or coal-tar oil, appears to answer equally well the purpose for which sulphate of copper is used, and at the same time, by its peculiar smell, deters rooks and other birds from eating the seed-corn, I would recommend comparative trials to be made with wheat dressed with blue vitriol and with coal-tar, or, better still, coal-tar oil. Occasionally, seed-wheat is dressed with white arsenic, or compounds containing arsenic. These poisonous preparations are highly objectionable, and should not be allowed to be sold openly as wheat-dressings, on account of the risk of accidents in manipulating wheat with arsenical preparations, and the abuse which may be made of poisoned wheat. A short time ago I had occasion to analyse a sample of a preparation which is largely advertised as a dressing for seed-wheat, and found it mainly a mixture of powdered blue vitriol (sulphate of copper), green vitriol (sulphate of iron), and white arsenic coloured by Armenian bole. The peculiar smell of the preparation was due to a little crude carbolic acid or light tar-oil, which appears to have been added to it. This preparation, I was informed, was employed for dressing seed-corn by the tenant of a member of the Royal Agricultural Society, who had the misfortune to find a number of dead partridges on his estate, which were supposed to have been poisoned by the arsenical compound. The examination of some seed-wheat which was found in the field where the dead partridges were picked up, however, revealed neither copper nor arsenic; and the analysis of grains of wheat taken from the crop of a dead partridge likewise indicated neither copper nor



arsenic. It was thus evident that the partridges had not been killed by the arsenical wheat-dressing, and, on further examination, I was able to show that both the wheat found in the field and the contents of the crop of the dead partridge contained appreciable quantities of bichloride of mercury, or corrosive sublimate. I am not aware that corrosive sublimate or other mercurial poisons have ever been employed for dressing wheat for the purpose of preventing smut, and it appears to me probable that the wheat poisoned by corrosive sublimate had been laid about the field with the intention of destroying the game.

My attention was directed last September to a curious substance which made its appearance on the grass in a field of rough pasture, in the occupation of Mr. H. B. Riddell, Whitefield House, Rothbury, Morpeth, who wrote to me on the 29th of September, 1877 :—

“SIR,—I send by this day’s post two boxes containing specimens of a substance which has made its appearance in a field of rough pasture near this house. I observed it at the same place last year, but have never seen anything like it elsewhere ; and, though I have pointed it out to many persons, I have not met any one who had seen it before. I have thought, therefore, that it might be of interest to you. The substance first makes its appearance as a viscous froth, not unlike a mass of ‘cuckoo-spit ;’ it gradually solidifies, and becomes what is sent in the card-box, and after a few days dries into the crystalline powder, a considerable quantity of which is in the wooden box. I have not analysed the crystals ; but it has struck me that, as the field was two years ago somewhat heavily manured with nitrate of soda and superphosphate of lime, the crystals might be derived from the manure.

“Yours truly,

“H. B. RIDDELL.

“*Dr. Voelcker.*”

The examination of the white powder, to which reference is made in Mr. Riddell’s letter, showed that, in addition to some gum and sugar, the bulk of the substance consisted almost entirely of carbonate of lime, with merely faint traces of phosphoric acid, and contained no nitrate of soda whatever.

On further inquiry, I learned from Mr. Riddell that the field in which the white substance appeared is poor partially-drained pasture on the north flank of the Simonside Hills. It rests on the ironstone of the coal measures, not on limestone ; but dykes of limestone cross the sandstone, and the springs are strongly impregnated with lime, chiefly as carbonate.

The spot where the substance in question appeared is not thoroughly drained, though the surface is dry. It first seemed to grow on the grass as a glutinous foam, and gradually dried to a crystalline powder. The field has not been lately dressed with chalk or lime.

ROTHERFIELD TOP-DRESSING EXPERIMENTS ON GRASS LAND.

No. of Plots.	Description of Manure.	PLOTS ONE-TENTH OF AN ACRE. MANURE SOWN JANUARY 20TH. GRASS CUT JULY 31ST, 1875.			GRASS CUT JULY 21ST, 1876. SHOWING THE UNEXHAUSTED VALUE OF MANURES.			GRASS CUT AUGUST 2ND, 1877. SHOWING THE UNEXHAUSTED VALUE AT THE EXPIRATION OF THE 3RD YEAR.		
		Quantity of Manure per Plot of One-tenth of an Acre.	Weight of Grass per Plot.	Increase per Plot over Average of Unmanured Plots.	Decrease per Plot.	Weight of Grass per Plot.	Increase per Plot over Average of Unmanured Plots.	Decrease per Plot.	Weight of Grass per Plot.	Increase per Plot over Average of Unmanured Plots.
		lbs.	cwt. qrs. lbs.	cwt. qrs. lbs.	cwt. qrs. lbs.	cwt. qrs. lbs.	cwt. qrs. lbs.	cwt. qrs. lbs.	cwt. qrs. lbs.	cwt. qrs. lbs.
1	Peruvian Guano	45	18 2 12	7 1 3	..	8 0 2	3 0 0	11 2 24	3 3 22	..
2	Soluble Guano	45	17 2 23	6 1 14	..	7 1 7	2 10 0	10 2 18	2 3 16	..
3	Soluble Guano.	33½	16 1 3	4 3 22	..	7 2 12	2 9 6	9 1 21	1 2 19	..
	Superphosphate	22½	14 2 10	3 1 1	..	6 2 24	1 4 0	9 0 26	1 1 24	..
4	Superphosphate	45	11 1 18	..	..	5 2 23	..	7 3 17	..	..
5	Nothing	..	12 2 7	1 0 26	..	6 2 9	2 17 0	9 0 19	1 1 17	..
6	Fine Bone Dust	67	14 1 14	3 0 5	..	5 3 24	2 2 0	8 0 0	0 0 26	..
7	Superphosphate	22½	..	..	..	..	..	..	..	..
	Nitrate of Soda..	22½	..	..	..	..	..	..	..	..
8	Superphosphate	22½	15 2 7	4 0 26	..	5 2 9	0 0 13	2 9 0	7 3 3	0 0 1
	Kainit..	22½	..	..	..	..	..	..	..	..
	Nitrate of Soda..	22½	..	..	..	..	..	..	..	..
9	Soluble Guano	33½	15 1 20	4 0 11	..	6 0 14	2 18 6	8 0 9	0 1 6	..
	Nitrate of Soda..	11	..	..	..	..	..	..	..	..
	Superphosphate	11	..	..	..	..	..	..	..	..
10	Nothing	..	11 1 0	..	..	5 2 22	..	7 2 16	..	..
11	Dissolved Bones	56	12 2 7	1 0 26	..	6 0 15	1 17 6	7 1 0	..	0 2 2
	Dissolved Bones	56	..	..	..	..	..	..	..	..
12	Soluble Guano	28	13 1 18	2 0 9	..	5 3 20	3 8 9	8 0 0	0 0 26	..
13	Prentice's Grass Manure	56	13 0 20	1 3 11	..	5 2 2	0 0 20	2 0 0	7 0 14	0 2 16
14	4-in. Bone	56	10 1 27	..	0 3 10	5 3 14	2 7 6	8 0 14	0 1 12	..
15	Farmyard Manure	1 Load	15 0 18	3 3 9	..	7 2 7	2 10 0	11 3 7	4 0 5	..

\* \* \* The first Ten of these Experiments were conducted under the direction of Dr. Augustus Voelcker, F.R.S.

In conclusion, I have to report that for the last three years Mr. Charles L. Curtis, Deanyers-Farrington, Alton, Hants, has kindly carried out, under my direction, some field-experiments on permanent pasture, and has favoured me with the results of the experiments, which perhaps may be of sufficient interest to warrant their publication in full in the 'Journal' of the Society (see table, p. 254).

*Analyses made for Members of the Royal Agricultural Society from December 1876 to December 1877.*

Superphosphates, dissolved bones, and compound } artificial manures .. .. . }	195
Bone-dust .. .. .	48
Guanos .. .. .	45
Nitrate of soda .. .. .	45
Sulphate of ammonia .. .. .	8
Potash-salts .. .. .	7
Refuse manures .. .. .	22
Sewage manures .. .. .	9
Limestones, marls, and other minerals .. .. .	18
Soils .. .. .	26
Waters .. .. .	46
Oilcakes .. .. .	136
Feeding meals .. .. .	19
Milk .. .. .	1
Vegetable productions .. .. .	12
Examinations for poison .. .. .	5
	642

XII.—*Quarterly Reports of the Chemical Committee.*

DECEMBER, 1877.

1. A SAMPLE of linseed-cake of a lot of 10 tons bought in October, by Mr. Wm. Holland, Market Deeping, at 10*l.* 11*s.* 3*d.*, on analysis yielded the following results:—

Moisture .. .. .	9.75
Oil .. .. .	11.15
* Albuminous compounds (flesh-forming matters) ..	23.94
Mucilage, starch, and digestible fibre .. .. .	33.22
Woody fibre (cellulose) .. .. .	13.90
† Mineral matter (ash) .. .. .	8.04
	100.00

\* Containing nitrogen .. .. . 3.83  
 † Including sand .. .. . 3.35

This analysis shows that the cake was rather deficient in albuminous compounds, and contained  $3\frac{1}{3}$  per cent. of sand. The

microscopical examination proved that the cake was made from badly screened linseed, and contained an undue proportion of sand, in addition to a number of small weed-seeds, which ought to have been removed by screening from the seed before it was pressed into pure linseed-cake.

The cake was bought and invoiced as pure linseed-cake (with warranty).

The dealers when ordering it of its presumed makers (and who had advertised it as pure linseed-cake of their own brand, and presumably, therefore, as of their own make, with warranty), expressly told the latter "not to send it unless they were quite sure it would bear the test of Dr. Voelcker's analysis;" and, on being informed by their customer of the result of that analysis, immediately sent him cake of other make in exchange, which did stand that test.

The presumed makers, on complaint from the dealers, bound as they were by their own warranty to the latter, could not do otherwise than take back the cake, though they said they knew it was pure and unadulterated, and should not have been likely to have sent it in face of the dealer's specific order had it been otherwise. At the same time, however, as they admitted that it was not made at their own mill, how they could possibly know it was pure it is difficult to understand.

Dealers acting carefully and honestly by their customers, as these did, would not care to have their names mixed up in a case of this kind, and on this account the names of both dealers and makers are purposely omitted.

The case, however, shows the necessity of buying with warranty, and particularly testing by analysis (the warranty in this case protected the innocent dealer as well as his customer), and of getting supplies from the actual makers.

2. Another sample of cake bought as pure linseed-cake at 10*l.* 5*s.* (for a large lot in summer to be delivered in October), was sent by Mr. Fred. Lister, Babworth, Retford, Notts, and on analysis was found to have the following composition:—

Moisture .. .. .	11·32
Oil .. .. .	11·70
*Albuminous compounds (flesh-forming matters) ..	28·63
Mucilage, starch, and digestible fibre .. .. .	31·10
Woody fibre (cellulose) .. .. .	8·40
†Mineral matter (ash) .. .. .	8·85
	100·00
	-----
* Containing nitrogen .. .. .	4·58
† Including sand .. .. .	3·55

Like the preceding cakes, it was made from unscreened linseed, containing, besides sand, numerous small weed-seeds, and was not a pure linseed-cake.

No further information was obtained in answer to the usual inquiries.

3. A sample, bought as nitrate of soda by a Member of the Royal Agricultural Society, was found on examination to contain only .003 per cent. of nitric acid. It thus contained merely faint traces of nitrate of soda, and on further analysis was found to be a mixture of chloride of sodium (common salt) and sulphate of soda (Glauber salt).

This so-called nitrate of soda having been bought at a low price without a guarantee, the purchaser did not feel justified in furnishing the vendor's name and address.

4. The following is an analysis of a sample of a manure, a cwt. of which had been sent for trial to Mr. George Neve, Sissinghurst, Staplehurst, Kent. The manure was sold at 12*l.* a ton, but without any guaranteed analysis:—

Moisture .. .. .	11.12
Organic matter .. .. .	12.74
Bone-phosphate of lime .. .. .	37.17
Sulphate of lime .. .. .	10.05
Crystallised sulphate of iron (green vitriol) .. .. .	2.78
Basic sulphate of iron, containing 7.28 of sulphuric acid .. .. .	25.49
Insoluble siliceous matter .. .. .	.65
	<hr/>
	100.00

This manure, it will be seen, contained in round numbers 37 per cent. of phosphate of lime, some sulphate of lime, and a considerable proportion of sulphate of iron. It contained no appreciable quantity of ammonia, and appeared to be mainly a mixture of animal charcoal and sulphate of iron. Such a mixture can be produced at less than half the price at which the sample of manure sent by Mr. Neve was sold.

MARCH, 1878.

1. A sample of cake, sold as the "best Pure Linseed-cake than can be made," was sent to me for analysis and opinion on the 15th of January, 1878, by Mr. Martin Pate, Ely, Cambridgeshire, and was found to have the following composition:—

Moisture .. .. .	9.94
Oil .. .. .	10.25
*Albuminous compounds .. .. .	26.56
Mucilage, starch, and digestible fibre .. .. .	37.14
Woody fibre (cellulose) .. .. .	9.70
Mineral matter (ash) .. .. .	6.41
	100.00
* Containing nitrogen .. .. .	4.25

The cake was poor in oil, and had been made from anything but clean linseed, for it was contaminated with buck-wheat, broken corn, and small weed-seeds. In this and the two following cases no further information could be obtained in answer to the usual inquiries respecting the sellers of the cakes, &c.

2. Mr. E. C. Clarke, Manor Farm, Haddenham, Thame, Oxon, sent a sample of linseed-cake for an opinion as to its genuineness. The examination showed that it was not a genuine linseed-cake, but an adulterated or inferior compound linseed-cake, containing amongst other ingredients, in addition to linseed, cotton-cake and locust bean-meal.

3. A sample of oil-cake was sent by Mr. Josh. Mackinder, Peterborough, who specially requested me to test it for the presence of rape or other seeds.

The cake, which was branded  Pure, had the following composition:—

Moisture .. .. .	8.01
Oil .. .. .	11.15
*Albuminous compounds .. .. .	24.44
Mucilage, starch, and digestible fibre .. .. .	37.52
Woody fibre (cellulose) .. .. .	11.03
†Mineral matter (ash) .. .. .	7.85
	100.00
* Containing nitrogen .. .. .	3.91
† Including sand .. .. .	2.80

This cake was made from dirty linseed, containing, in addition to nearly 3 per cent. of sand, rape, wild mustard, polygonum, and numerous other small weed-seeds, which usually occur in badly screened linseed. Moreover, it was an old stale cake, slightly mouldy at the edges, and had a disagreeable rancid smell like old oil paint, and certainly was not a cake which should have been sold as pure linseed-cake and branded  Pure.

4. In the last Quarterly Report reference was made to a sample of linseed-cake, sent by Mr. Lister, Upper Morton



Grange, Retford, which was sold as pure, and found by me to be an inferior linseed-cake, made from badly screened linseed.

A letter has since been received from Mr. Lister, who informs me that the matter has been settled, he having obtained a reduction in the price nearly to what I stated should be made by the dealer—a reduction, Mr. Lister says, he should not have received had it not been for my analysis and report.

5. I have also to direct attention to the occurrence of castor-beans, which I detected by the microscope, in a sample of a compound feeding-cake that proved injurious to cattle.

6. The following is an analysis showing the composition of a sample of a "Meat and Bone Manure," sent by Mr. Clement Baguley, The Oldfields, Pulford, Wrexham:—

Moisture .. .. .	26·17
*Organic matter .. .. .	23·96
Oxide of iron and alumina .. .. .	8·73
Phosphate of lime .. .. .	·87
Carbonate of lime .. .. .	5·68
Alkaline salts and magnesia .. .. .	5·39
Insoluble siliceous matter (sand) .. .. .	29·20
	100·00
* Containing nitrogen .. .. .	1·98
Equal to ammonia .. .. .	2·41

The manure was thus very wet, and contained 29 per cent. of sand, and about 20 per cent. of other mineral matters of no intrinsic fertilising value. It yielded only 2½ per cent. of ammonia, and although sold as a "Bone and Meat Manure," did not contain quite 1 per cent. of phosphate of lime. It was scarcely worth 2*l.* 2*s.* per ton. Mr. Baguley bought 10 tons, at 5*l.* 10*s.* per ton, from the manufacturer. Not finding the bulk, on delivery, equal to the sample by which it was bought, Mr. Baguley went to the works, and wrote to me that he was satisfied with the appearance of things, and finally arranged to pay according to my valuation. Mr. Baguley also put into my hands the following letter, which he had received from the vendors:—

"DEAR SIR,—Yours of the 8th instant is only to hand this morning. If the sample was fairly taken, the manure is certainly not worth what I have charged you for it.

"There is no mistake in the article sent that I can find out, and I cannot account for its inferiority, unless the fact of its being the face of the heap, the first sent out, and the long exposure to the atmosphere of the doorway, may account for it in some way.

"Its not having been put through the disintegrator, and through being

screened, possibly the richer part and pieces of bone may have been left out, may also have something to do with it.

"However, as the manure as supplied is not of the value charged—that is, if sample sent to Dr. Voelcker fairly represents the bulk—and as Dr. V.'s valuation is below what I can sell it at to manure-makers, I think the fair course for both parties will be for you to return it to me, and to charge me with all payments you have made, and I will replace it with some of what I am now sending out.

"I shall be glad if you will call upon me next time you are in Liverpool, and I will let you see what manure-makers are paying for it, and also let you see the article now we have got half-way through it.

"Was sample taken from each or only from some of the bags?"

"Yours truly, " — — —."

"C. Baguley, Esq., The Oldfields, Pulford, Wrexham."

The preceding letter was accompanied by the following note addressed to me:—

"The Oldfields, Pulford, Wrexham, 14/3/78.

"DEAR SIR,—In answer to your last, I beg to enclose filled-up form, likewise — — — own explanation, which I am inclined to believe.

"I had sown the manure before receiving this, on the agreement that he returned the deficiency, if any, in value between price paid and your valuation. He now writes to say that he has forwarded 2 tons blood-manure, value 9*l.* per ton, which he thinks will amply repay the deficiency. It is possible that I may ask your opinion of that same.

"I remain, yours respectfully,

"Dr. Voelcker."

"CLEMENT BAGULEY.

7. A sample of "Nitrophosphate Manure" for grass, sent by Mr. George Wigham, Laverick Hall, Cramlington, sold at 9*l.* a ton, less 12*s.* for cash, on analysis was found to have the following composition:—

Moisture .. .. .	17.29
*Organic matter .. .. .	9.15
Phosphate of lime .. .. .	1.61
Oxide of iron and alumina .. .. .	4.66
Carbonate and sulphate of lime .. .. .	20.49
Alkaline salts and magnesia .. .. .	2.85
Insoluble siliceous matter (sand) .. .. .	43.95
	100.00
* Containing nitrogen .. .. .	.49
Equal to ammonia .. .. .	.59

This manure contained only about  $1\frac{1}{2}$  per cent. of phosphate of lime, and less ammonia than common farmyard-manure. It contained 44 per cent. of sand, much carbonate of lime and other earthy matters of no intrinsic fertilising value, and was scarcely worth as a manure 15*s.* per ton.

Mr. Wigham bought 3 tons, at 9*l.* a ton, from the Ceres Nitrophosphate Company, Ceres Works, Stratford, London, E., payment to be made to the order of Mr. Otto Schleicher.

The Ceres Nitrophosphate Company's circular embodies a printed certificate of analysis by Mr. F. Sutton, analytical and consulting chemist to the Norfolk Chamber of Agriculture, showing the following composition of the company's grass-manure:—

Moisture .. .. .	13·
Organic matter .. .. .	35·10
Biphosphate of lime .. .. .	8·70
Equal to tribasic of phosphate of lime .. .. .	13·70
<hr/>	
Insoluble phosphates .. .. .	3·91
Sulphate of lime and alkali .. .. .	13·57
<hr/>	
Nitrogen .. .. .	2·52
Equal to ammonia .. .. .	3·06
Equal to sulphate of ammonia .. .. .	12·24

(Signed) FRANCIS SUTTON.

The manure was obtained through Mr. Joseph Armstrong Herdman, High Horton, Cramlington, a farmer's son, who, in answer to an advertisement in one of the Newcastle papers, was appointed agent to the Company a short time ago.

The invoice was sent to Mr. Wigham direct from the Ceres Nitrophosphate Company's Works, Warlow Road, Stratford, E., with the following notice.

"Our forwarding clerk omitted to pay the carriage here, and we should therefore take it as a favour if you would kindly do so at your end, and deduct it from invoice.

"Yours truly,

"CERES NITROPHOSPHATE CO., OTTO SCHLEICHER."

Mr. Wigham had to pay 4*l.* 2*s.* for carriage, that is, a great deal more than the 3 tons of this so-called grass-manure was worth.

8. Another sample of grass-manure, sold at 8*l.* 10*s.* a ton, by the same Ceres Nitrophosphate Company, was sent to me by Mr. William Bannister, farmer, Westdean, Lewes.

It had the following composition:—

Moisture .. .. .	18·10
*Organic matter .. .. .	7·15
Phosphate of lime .. .. .	1·04
Oxide of iron and alumina .. .. .	4·77
Carbonate and sulphate of lime .. .. .	24·20
Alkaline salts and magnesia .. .. .	2·21
Insoluble siliceous matter (sand) .. .. .	42·53
	100·00
* Containing nitrogen .. .. .	·44
Equal to ammonia .. .. .	·53

A comparison of the composition of the sample sent to me by Mr. Wigham with that of the sample sent by Mr. Bannister shows that both samples may be considered practically to be the same. Like the sample sent by Mr. Wigham, that analysed for Mr. Bannister is scarcely worth 15s. per ton.

Mr. Bannister obtained the manure through the Ceres Nitrophosphate Company's agents, Messrs. J. and N. C. Bull, Newhaven, Sussex, who, Mr. Bannister informs me, were only appointed a few months ago, and who likewise state that they have no liability, not being allowed to receive payment, and whose commission, by their own confession, is 1*l.* per ton.

Having had previous transactions with Messrs. Bull, and being much pressed for an order, Mr. Bannister at last consented, on condition that the manure should be analysed.

The invoice was set to Mr. Bannister direct from the office of the Ceres Nitrophosphate Company, Warlow Road, Stratford, and, curiously enough, with the same intimation which Mr. Wigham received, namely:—

“MR. W. BANNISTER,

“DEAR SIR,—Our forwarding clerk has omitted to pay the carriage here, and we should therefore be glad if you would kindly do so at your own end, and deduct it from invoice.

“Yours truly,

“CERES NITROPHOSPHATE CO., OTTO SCHLEICHER.”

### XIII.—*Annual Report of the Consulting Botanist for 1877.*

By W. CARRUTHERS, F.R.S.

THE number of applications by Members of the Society has considerably increased during the past year, having exceeded sixty.

The samples of seed for crops which have passed through my hands have been generally satisfactory, and no case has occurred

to me this year in which either killed or spurious seeds have been foisted upon the purchaser. The samples that I have had to condemn have been defective either through the presence of worthless or injurious weeds, or through bad or careless harvesting, so that too large a proportion of unripe grains were collected, or the grains were injured in threshing or in other and subsequent treatment.

It is satisfactory that, as far as my experience goes, the Members of the Society have not been imposed upon by the killed and coloured seeds which recent prosecutions have shown to be again found in the market. The extent to which killed or dead seeds are present in any sample may easily be determined by the purchaser, and no farmer should sow low-priced seed, or seed in any way suspicious, without experimenting himself in germinating a fair sample, or submitting it for examination. I believe no danger is to be feared from the trade generally, but unprincipled dealers in large towns are now known to systematically increase their profits through adulteration. The worthless article is chiefly imposed on general dealers who supply seed but have no practical knowledge of this department of their business, and who retail in good faith what they have purchased in the lowest market as good seed.

The reflection in the Annual Report of last year on the inferior character of seed supplied to a Member of the Society by a Farmers' Association, led to a remonstrance from a firm supplying seed to such an Association, which I placed before the Committee, and which, in their opinion, fully justified the condemnation which was printed in the Report.

In the course of the year the Committee resolved to make arrangements for supplying information as to the insect dangers of the farm. This was intimated to the Members of the Society. The great alarm caused by the threatened appearance of the Colorado Beetle directed much attention to insects which appeared among the crops; and every strange or unknown insect was too often supposed to be a stage of the life of the dreaded Beetle. The Society, by the distribution of coloured illustrations of the Beetle amongst all its Members, supplied them with the means of recognising it in any of its forms. But, happily, no authenticated case has yet been reported of its appearance in Britain, except as specimens supplied to naturalists for scientific purposes. Eight applications have been made to me in the course of 1877 in regard to insects, and the Members have received satisfactory information from the experienced entomologist who has undertaken to answer these inquiries. The insects sent were well known, and, with one exception, were innocent creatures.

**ADDITIONS TO THE LIBRARY IN 1877.****I.—PERIODICALS PRESENTED TO THE SOCIETY'S LIBRARY.***Presented by the respective Societies and Editors.***A.—ENGLISH, AMERICAN, AND COLONIAL PERIODICALS.**

- Agricultural Gazette. Nos. 157-209. 1877.  
 ——— Students' Gazette. Vol. II.  
 American Agriculturist. Vol. XXXVI. 1877.  
 Athenæum (Journal). Nos. 2566-2618. 1877.  
 Bath and West of England Society, Journal of the. Vol. IX. 1877.  
 Bell's Weekly Messenger. 1877.  
 Bristol Mercury. Vol. LXXXVIII. 1877.  
 Bussey Institution, Bulletin of the. Parts I.-II. 1877.  
 Chamber of Agriculture Journal. Vol. XVII. 1877.  
 Coates's Herd Book. Vol. XXIII. 1877.  
 Country. 1877.  
 Country Gentleman's Magazine. Vol. XIV. 1877.  
 Economist. Vol. XXXV. 1877.  
 Essex Standard. Vol. XLVII. 1877.  
 Farmer. Vols. XXVIII. and XXIX. 1877.  
 Farmer's Herald. Vol. XXV. 1877.  
 Field. Vols. XLVIII. and XLIX. 1877.  
 Geological Society, Journal of the. Vol. XXXIII. 1877.  
 Highland and Agricultural Society of Scotland, Transactions of the. Vol. IX. 1877.  
 Indian Agriculturist. Vol. II. Nos. 7-12. 1877.  
 Institution of Civil Engineers, Proceedings of the. Vols. XLVII.-L. Parts I.-IV. 1876-77.  
 Institution of Mechanical Engineers, Proceedings of the. 1877.  
 ——— of Surveyors, Transactions of the. Vol. IX. 1877.  
 Investor's Monthly Manual. Vol. VII. 1877.  
 Irish Farmer's Gazette. Vol. XXXVI. 1877.  
 Kansas, Fifth Annual Report of the Legislature of. 1876.  
 Live-stock Journal. Vols. V. and VI. 1877.  
 Madras Presidency. Annual Report of the Superintendent of Government Farms. 1876.  
 Maine Board of Agriculture. Twenty-first Annual Report of the Secretary 1876.  
 Mark Lane Express and Agricultural Journal. Vol. XLVI. 1877.  
 Midland Counties' Herald. Vol. XLI. 1877.  
 Nature. Vols. XV. and XVI. 1877.  
 Neilgherry District, Report on the Agricultural Condition of the. 1876.  
 Newcastle Courant. 1877.  
 New Haven. American Journal of Science and Arts. 1877.  
 New South Wales, Journal of the Agricultural Society of. Part I. 1877.



- North British Agriculturist. Vol. XXIX. 1877.  
 Ohio. Thirtieth Annual Report of the State Board of Agriculture for the year 1875.  
 Ontario, Annual Report of the Commissioner of Agriculture and Arts. 1876.  
 Quebec, province of. Report of the Commissioner of Agriculture and Public Works. 1866-7.  
 Royal Asiatic Society, Journal of the Bombay Branch. Nos. 34-34A. 1876-7.  
 \_\_\_\_\_, Journal of the. Vol. IX. 1877.  
 Royal Geographical Society, Journal of the. Vol. XLVI. 1877.  
 \_\_\_\_\_, Proceedings of the. Vol. XXI. 1877.  
 Royal United Service Institution, Journal of the. Vol. XX. 1877.  
 Smithsonian Institution. Annual Report of the Board of Regents. 1875-6.  
 \_\_\_\_\_, Contributions to Knowledge. Vol. XXII. 1877.  
 Society of Arts, Journal of the. Vol. XXV. 1877.  
 Statistical Society, Journal of the. Vol. XL. Parts I.-IV. 1877.  
 Veterinarian, The. Vol. L. 1877.  
 Veterinary Obstetrics, A Text-book of. Parts 1-11.  
 Washington. Report of the Commissioner of Agriculture. 1875-6.

## B.—FOREIGN PERIODICALS.

- Berlin. Landwirthschaftliche Jahrbücher. Band VI., Hefte 1-6; and two Supplements. 1877.  
 Buenos Aires. Añales de la Sociedad rural Argentina. Vol. X. 1876.  
 Gorizia. Società Agraria. Atti e Memorie. Anno XVI. Nuova Scric. Vol. II. Nos. 1-3. 1877.  
 Heidelberg. Naturhistorisch-medicinischen Vercin. Verhandlungen. Neue folge. 2<sup>er</sup> Band. Heft 1. 1877.  
 Lima. Revista de Agricultura. 1875-6.  
 Meaux. Société d'Agriculture, Sciences, et Arts. Compte rendu de la Séance à Rentilly. 1876.  
 Montevideo. Boletín Oficial de la Comisión central de Agricultura de la República oriental del Uruguay. 1877.  
 Munich. Landwirthschaftliche Verein in Bayern. Zeitschrift. 66<sup>er</sup> Jahrgang. 1876.  
 Paris. Annales Agronomiques. Tome troisième. Fasc. 1-4. 1877.  
 ——. Journal d'Agriculture pratique. Vols. I. and II. 1877.  
 ——. Journal de l'Agriculture. Vols. I.-IV. 1877.  
 ——. Société des Agriculteurs de France. Bulletin mensuel. 9<sup>me</sup> année. Vol. IX. 1877.  
 ——. \_\_\_\_\_ Compte rendu des Travaux. Annuaire de 1877.  
 Rio de Janeiro. Archivos do Museo Nacional. Vol. I. 1876.

## II.—BOOKS PRESENTED TO THE SOCIETY'S LIBRARY.

*Names of Donors in Italics.*

## A. ENGLISH, AMERICAN, AND COLONIAL BOOKS AND PAMPHLETS.

- Collins, Charles Edwin.* Life of Henry Collins. 1877.  
*Fleming, George.* Veterinary Obstetrics. 1877.  
*Goodlet, William.* Remarks on the Duke of Argyll's Essay on the Commercial Principles applicable to Contracts for the Hire of Land. 1877.

- Lawes, J. B., F.R.S., and Gilbert, J. H., F.R.S.* On the Formation of Fat in the Animal Body.
- Loan Collection of Scientific Apparatus at South Kensington, Catalogue of. 1877. *Presented by the Science and Art Department.*
- Reid, G. H.* An Essay on New South Wales. 1877.
- Royal College of Veterinary Surgeons, Charter and Bye Laws of the. 1877. *Presented by the Council of the College.*
- Science Conferences at South Kensington. 2 vols. 1876. *Presented by the Science and Art Department.*
- Wilson, Dr. Andrew.* On the Colorado Potato Beetle. 1877.
- Von Mueller, Baron.* Select Plants eligible for Industrial Culture in Victoria. 1877.

## B. FOREIGN BOOKS AND PAMPHLETS.

- Anon. Aarsberetning angaaende de offentlige Foranstaltninger til Landbrugets Fremme i Aaret, 1875. Christiania, 1876. *Presented by the University of Christiania.*
- . Abhandlungen zur Geologischen Specialkarte von Preussen. Berlin, 1877.
- . Boretning den Høiere Landbrugsskole i Aas, July 1874–5. Christiania, 1876. *Presented by the University of Christiania.*
- . Censimento generale dei Cavalli e dei Muli. Two vols. Roma, 1876. *Presented by the Italian Minister of Agriculture.*
- . Compte rendu du Congrès International Agricole à Bordeaux. 1876. *Presented by the Committee of the Congress.*
- . Congresso Generale degli Agricoltori Italiani. May 1875. Milan, 1877. *Presented by the Committee.*
- . Nederlandsch Rundvee-Stamboek, 1876. Edited by *P. F. L. Waldeck*. Schiedam, 1877.
- . Notizie e Studi sull' Agricoltura, 1876. Roma, 1877. *Presented by the Italian Minister of Agriculture.*
- . Relazione intorno alle Condizioni dell' Agricoltura nel quinquennio, 1870–4. Vol. III. Rome, 1877. *Presented by the Italian Minister of Agriculture.*
- Behmer, R.* Das Landwirthschaftliche Prämürungswesen von Thieren und Maschinen. Berlin, 1877.
- Bortier, P.* Méthode nouvelle pour la Culture de la Pomme de Terre. Bruxelles, 1877.
- . Papier d'Aubier de Tremble. Bruxelles, 1877.
- Janke, Dr. H.* Das Fruchtrecht des Besitzers. Berlin, 1862.
- . Die Directe Besteuerung des Spiritus. Berlin, 1869.
- . Die Grundsätze der Schafzüchtung. Berlin, 1867.
- . Die Moderne Fleischschafzucht. Prag, 1875.
- . Ein Forstbesuch in Tetschen. Prag, 1877.
- Kette, W.* Die Lupine als Feldfrucht. Berlin, 1877.
- Petersen, C.* Anleitung zum Betriebe der Milchwirthschaft. Danzig, 1877.
- Ronna, A.* Rothamsted. Trente années d'expériences Agricoles de MM. Lawes et Gilbert. Paris, 1877.
- Schübelen, Dr. F. C.* Die Pflanzenwelt Norwegens. Christiania, 1877.

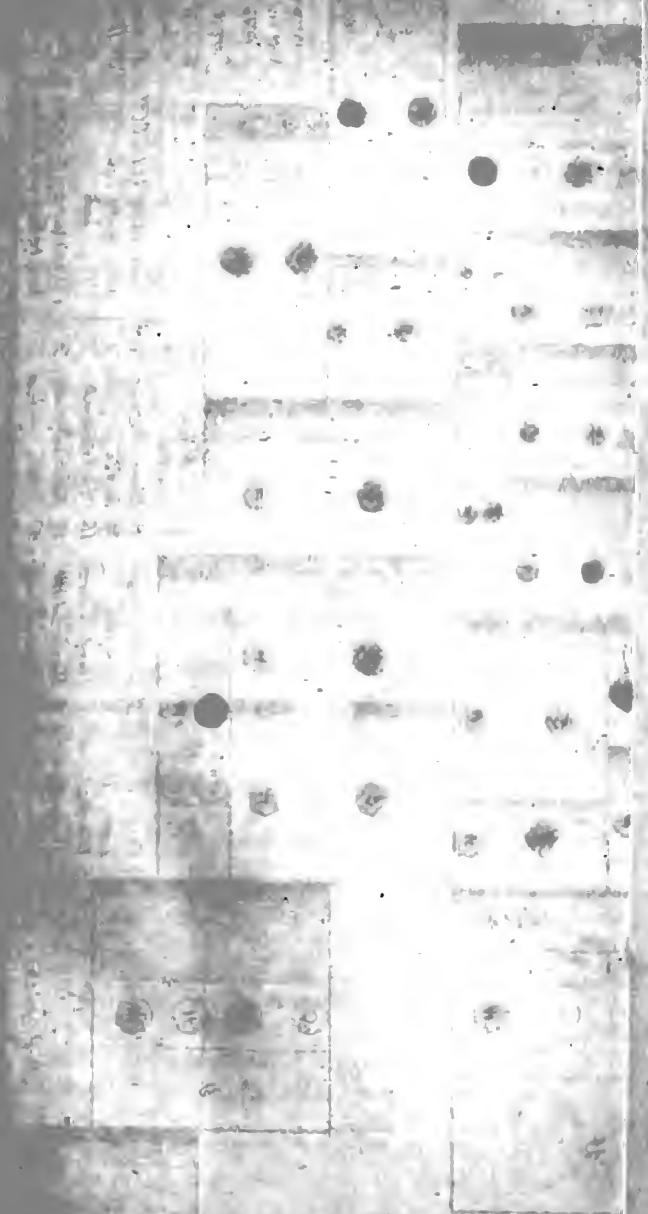

# Diagram Map OF ENGLAND AND WALES.

Exhibiting the Relative Areas of Pasture, Green and Cattle Crops, Corn Crops, Wheat and Uncultivated Land in each County; together with the Comparative Yields of Wheat per acre, and the Proportions of Cattle, Sheep and Horses, per Hundred acres under Crops and Pasture.

- Cattle**
- Under 10 per 100 acres in Crops and Pasture
  - 10 and under 15 per 100 acres ditto
  - 15 and under 25 per 100 acres ditto
  - 25 and above per 100 acres ditto
- Sheep**
- Under 50 per 100 acres in Crops and Pasture
  - 50 and under 75 per 100 acres ditto
  - 75 and under 100 per 100 acres ditto
  - 100 and above per 100 acres ditto
- Horses**
- Under 3½ per 100 acres in Crops and Pasture
  - 3½ and under 4 per 100 acres ditto
  - 4 and under 5 per 100 acres ditto
  - 5 and above per 100 acres ditto

- Uncultivated Land, Woods, Water, Roads, Towns
- Permanent Pasture or Meadow not broken up in Rotation, exclusive of Heath and Mountain Land
- Green Crops and Grasses under Rotation
- Corn Crops other than Wheat
- Wheat
- Average Yield of Wheat
  - Under 25 bushels per acre
  - 25 and under 30 bushels per acre
  - 30 and under 32 bushels per acre
  - 32 bushels and above per acre

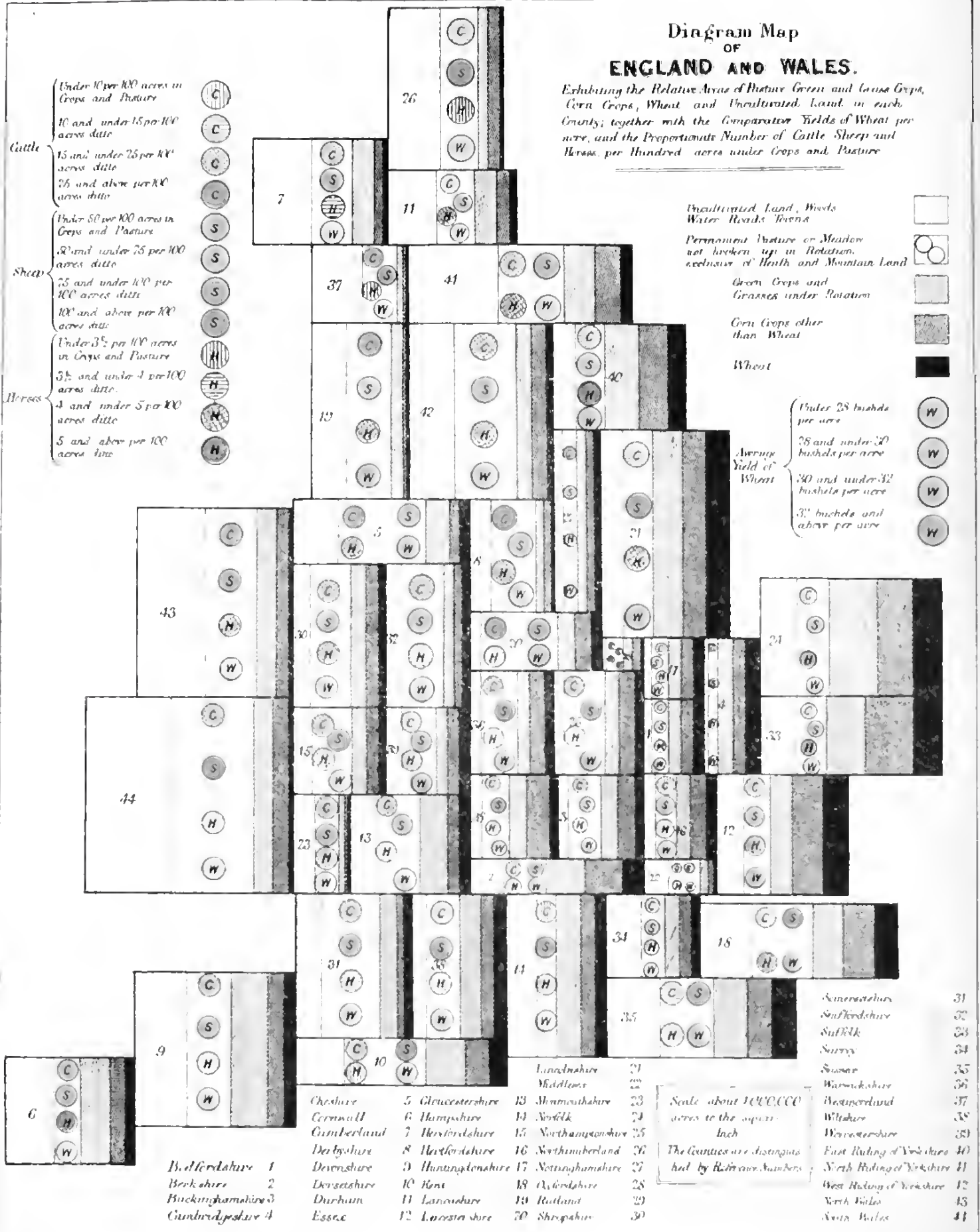

Cheshire	5	Gloucestershire	13	Shropshire	23
Cornwall	6	Hampshire	14	Suffolk	24
Cumberland	7	Hertfordshire	15	Northamptonshire	25
Derbyshire	8	Huntingdonshire	16	Northumberland	26
Devonshire	9	Lincolnshire	17	Nottinghamshire	27
Dorsetshire	10	Leicestershire	18	Oxfordshire	28
Durham	11	London	19	Rutland	29
Essex	12	Lancashire	20	Shropshire	30

Scale about 100,000 acres to the square Inch

The Counties are distinguished by Roman Numbers

Somersetshire	31
Suffolkshire	32
Suffolk	33
Surrey	34
Sussex	35
Warrickshire	36
Wiltshire	37
Worcestershire	38
East Riding of Yorkshire	39
West Riding of Yorkshire	40
Yorkshire	41
North Wales	42
South Wales	43

# MEMOIR

ON THE

## AGRICULTURE OF ENGLAND AND WALES,

PREPARED UNDER THE DIRECTION OF

THE COUNCIL OF THE,

### ROYAL AGRICULTURAL SOCIETY OF ENGLAND

FOR

THE INTERNATIONAL AGRICULTURAL CONGRESS,  
PARIS, 1878.

EDITED BY

H. M. JENKINS, F.G.S.,

SECRETARY OF THE SOCIETY AND EDITOR OF ITS 'JOURNAL.'

LONDON :

PRINTED BY WILLIAM CLOWES AND SONS, STAMFORD STREET  
AND CHARING CROSS.

1878.

APPROXIMATE EQUIVALENTS OF FRENCH AND ENGLISH  
MONEY, WEIGHTS, AND MEASURES.



£1 (one pound sterling) .. .. .	= (about) 25 francs.
1 shilling (one-twentieth of a pound) ..	= (about) 1 franc 25 centimes.
1 penny (one-twelfth of a shilling) ..	= (about) 10 centimes.
£1 per acre .. .. .	} = (about) 62 fr. 50 c. per hectare.
1 shilling per acre .. .. .	
1 acre .. .. .	= (about) .4 hectare.
1 rood (one-fourth of an acre) .. ..	= (about) .1 hectare.
1 perch, or pole, or rod (one-fortieth of a rood) .. .. .	} = (about) .025 hectare.
1 quarter .. .. .	
1 bushel (one-eighth of a quarter) ..	= (about) .36 hectolitre.
1 peck (one-fourth of a bushel) ..	= (about) .09 hectolitre.
1 quarter per acre .. .. .	} = (about) 7.2 hectolitre per hectare.
1 bushel per acre .. .. .	
1 lb. avoirdupois .. .. .	= (about) .45 kilo.
1 cwt. avoirdupois .. .. .	= (about) 51 kilos.
1 lb. per acre .. .. .	= (about) 1.12 kilo per hectare.
1 imperial stone (14 lbs.) .. .. .	= (about) 6.3 kilos.
1 Smithfield stone (8 lbs.), used only for dead meat .. .. .	} = (about) 3.6 kilos.
1 tod (28 lbs.) of wool .. .. .	



## EDITOR'S PREFACE.

---

THE contents of this volume are confined as much as possible to the Agriculture of England and Wales ; but the first article gives a General View of the Agriculture of the three kingdoms which constitute Great Britain and Ireland, and in the articles upon Land Law and Taxation it has been impossible to separate entirely the English from the Scotch and Irish branches of the subject. It has also been difficult to draw rigid lines of demarcation between the subjects assigned to the different authors, but care has been taken to prevent avoidable repetition.

Several causes have combined to give English Agriculture a diversified character. The varied character of the soils of the country, the inequalities in the climate of different districts, and the situation of farms in relation to the large towns, are all potent causes of differences in farm-management. Again, under the influences of Free-trade, an insular position, and a dense population chiefly engaged in manufactures and commerce, England has become a vast warehouse and mart for the agricultural products of the civilised world. Further, social and political considerations, and the natural love of a country life, which is one of the characteristics of the English people, have led capitalists to purchase land at a price which yields a smaller immediate interest for money than any other form of investment, while they induce the tenant-farmer to be satisfied with a less, and more uncertain, rate of profit from his annual operations, than is expected by the merchant, who turns his capital over several times in the year, and thus has many chances of neutralising an isolated loss.

It will be easily understood that the numerous phases of

English Agriculture, the causes of which have just been indicated, may be differently regarded and interpreted by different minds ; and it must therefore be distinctly stated that, although this volume has been prepared under the direction of the Council of the Royal Agricultural Society of England, the authors of the several articles are alone responsible for the statements of fact and opinion contained in their respective contributions.

H. M. JENKINS.

## CONTENTS.



INTRODUCTION .. .. . Page 11

### CHAPTER I.—*Home and Foreign Supply of Food.*

Functions of Government in regard to the Supply of Food—Value of Cereal and Animal Food imported from Abroad—Rapid Rise in the Value of Meat—may be checked by Importations from America—Proportion of Home and Foreign Supply of Food in this Country—England now chiefly dependent on the latter for further Increase—Cost of Carriage equal to the Rent of Land here—Agricultural Statistics sufficiently accurate for use—Their main Features—Diminution of Corn in Ireland—Present Agricultural Prosperity of that Country—Extent of the various Crops and numbers of Live-Stock—Quantities and Value of Home and Foreign Produce, respectively, consumed annually in this Country .. .. . Pages 12-18

### CHAPTER II.—*Changes and Progress in Agriculture in recent Years.*

Reaping and Mowing Machines—Steam Plough—Double-Furrow Plough—General use of Steam-power—Successive Corn Crops—use to which this might be put in time of War—capable of checking a permanent great Rise in Price of Wheat—Autumn Culture and Steam-power, with imported Manures, have given great command of Crops—Mr. Lawes' Experiments: their Value and some of their special Lessons—The Experiments at Woburn—Extension of Land-drainage and Improvement of Farm Buildings and Labourers' Cottages—Change within 30 years, more in general diffusion of Improved Practice, and better Breeds of Stock, than in the introduction of New Systems—Greatest change caused by the Prosperity of the Country and the rise in the Value of Animal Food—vast consequent Increase in the Capital Value of Live-Stock and Landed Property .. .. . Pages 18-24

### CHAPTER III.—*Soil, Climate, and Crops.*

Extent of Country and Proportion of various Crops—as influenced by Climate, Situation, and Rainfall—Weight and relative Value of Corn Crops—Examples of Soils of greatest and least natural Fertility—and of an average soil unmanured and specially manured—Plants which predominate in Uncultivated Land .. .. . Pages 24-27

CHAPTER IV.—*Distribution of Landed Property.*

Tendency to Diminution in number of small Estates—Proportion of Landowners to whole Population as one in a hundred—These, being Heads of Families, equivalent to one in twenty—Hence one-twentieth of Population interested in Landed Property—Increased to one-fifth by the interests of Tenant Farmers as Part Owners of Agricultural Property.—One-fifth of the Land held by the Peerage—Not cultivated by Owners but by Farmers—relative Extent of their Holdings in England and in Ireland—Trade and Colonies enable us to dispense with checks on Increase of Population—That checked in Ireland by Potato Famine—Decrease of smallest Holdings there on return of Prosperity—Diminution of Agricultural Population—and of Yeomen farming their own Land—Experiment of Peasant Proprietors in Ireland .. .. . Pages 27-33

CHAPTER V.—*Landowner, Farmer, and Labourer.*

The Landowners, their position, duties, and influence—Their number, and the immense Capital Value of their Property—The Tenant Farmers, the proportional extent of their Holdings, their Numbers and Capital—The Labourers—condition now better than at any previous period, comparing their Wages with the Price of Bread—Each of the three classes constantly recruited by Changes of Property and Employment—Result of the System, compared with that of other countries, shows larger Returns at less Cost—Special Features of System in England—in Scotland—in Ireland—Tenancy-at-will in England—Leases in Scotland—Middlemen in Ireland, and the Results, .. .. . Pages 33-41

CHAPTER VI.—*Land Improvement.*

Hindrances by Settlements and Incumbrances—Expedients adopted to overcome the incapacity of Owners to provide Capital for Improvement—State Loans for Land Improvement—Followed by Loans from Land Improvement Companies—Total Amount so expended—Parliamentary Inquiry into the mode of working these Loans, and their results—General Testimony to their remunerative character—Land Drainage the most remunerative Improvement—Greater Caution required in Expenditure on Buildings—Labourers' Dwellings, judiciously executed and placed, as remunerative as any other outlay of Landowner's Capital—Better Cottages wanted rather than more of them—Examples of remunerative Expenditure .. .. . Pages 42-48

CHAPTER VII.—*Recent Rise in the Value of Land.*

Great Rise in the Value of Land since the Repeal of the Corn Laws—only partly due to the outlay of Capital in Improvements—Greatest Rise has been in the Grazing Counties, on Grass Lands, and in Scotland—The cause of this—The Scotch Landowner better trained to his Business—Landowning the only Business in which special Training is not deemed necessary—Security for Tenant's Capital required—Admirable Principle of Drainage Loans—Extended Powers of Sale in the case of Settled Estates desirable—Settlements should be limited to Lives in being .. .. . Pages 48-54

CHAPTER VIII.—*The Government in its Connection with Agriculture.*

No Minister of Agriculture, and no Government Control exercised, or State Schools for Agriculture, or Flocks or Herds maintained by Government—The Inclosure Commission the only State Department connected with the Land—Its various Functions—Main Drainage Commissions for Control of Floods—These beneficial where not permitted to remain too long stagnant—Great Engineering Works seldom required—Exchange of Intermixed Lands inexpensive and simple in its operation—Extent to which the Power of Exchange is used .. .. . Pages 54-57

CHAPTER IX.—*Waste Lands and Copyholds.*

Inclosure of Waste Lands, its extent and results—Quality and occupation of persons to whom Waste Lands passed—Extent of Public Roads constructed and Value of Lands devoted to Public Objects, at the cost of the Owners of Common Rights, equal to one-eighth of value of the whole land inclosed—Enfranchisement of Copyhold Lands and Buildings—Number completed—Extinction of this objectionable kind of Tenure desirable—Mode of accomplishing this .. .. . Pages 57-61

CHAPTER X.—*Church, Crown, and Charity Estates.*

Tithes commuted from payment in kind to Money—Unexpected effect of this in preventing a rise in the Income of the Church, and increasing that of the Landowners—Parish Clergy a body of resident Landowners equal in number to more than one-fourth of those over 200*l.* a year, the removal of whom might prove a change of great magnitude in its social effect—Her Majesty's Woods, Forests, and Land Revenues managed with great judgment—and now yield a net Return to the Exchequer exceeding the Civil List paid to the Queen—General Conditions on which the Farms of the Crown are let—Charity Estates, their Extent and annual Value—now placed under the general direction of Government—Their Magnitude compared with the Cost of the Civil Administration of the Country .. .. . Pages 62-66





# BRITISH AGRICULTURE.

---

## INTRODUCTION.

THE object of this book is to describe the present state of agriculture in the British Islands, for the information of the Agricultural Congress which will be held during the period of the International Exhibition at Paris, and in which the agriculture of the United Kingdom will be practically illustrated by live-stock, machinery, implements, and agricultural products. It begins with a description of the annual supplies required for the food and woollen clothing of the population, and of the sources whence these are derived, and the proportion in which they are the produce of home and foreign growth. A narrative is then given of any considerable changes which have occurred in the objects and processes of agriculture in recent times, and of the value of the improvements which have been made. The vast increase in agricultural wealth arising from the demands of a prosperous people will be noticed, and the influence which has thus been exercised on the modes of husbandry. The great business which has arisen in the importation and manufacture of manures and of cattle-food will be referred to. A sketch will be given of the extent and agricultural resources of the country, of its climate and soil, and the peculiarities of management arising therefrom, and of the different classes employed in its agriculture and their influence upon, and relation to each other. The leading features of the agricultural management of the three nations which compose the British people will be described, and the general results of their system. Reference will also be made to the public institutions connected with agriculture, the revenues arising from land devoted to charitable, educational, and religious objects, and their management, and the slight direct connection of Government with the land, and its general freedom from State control. Farm capital, with the price and rent of land and the wages of labour, and the general condition and educational arrangement of the agricultural population, with the financial system and legislation as affecting

General con-  
tents of this  
volume.

agriculture, will be treated in greater detail. The practice of agriculture, the characteristic crops and breeds of cattle and their management, and the system of cultivation, will be described, and the aids which chemistry and mechanics in recent times have afforded to the cultivation of the soil and the rearing and feeding of live-stock.

---

## CHAPTER I.

### HOME AND FOREIGN SUPPLY OF FOOD.

ONE of the most important functions of Government is to take care that there shall be no hindrance to the people supplying themselves with food and clothing, which are the first necessaries of life. And as these are, in one form or another, annual products of the earth, dependent for their abundance on the skill, capital and labour employed in its cultivation, much of the safety and welfare of a country arises from the condition of its agriculture. That of England has attained an exceptionally high productiveness. The best of our land has long been occupied, and, though there is yet much of the inferior class that admits of improvement, it has become our interest as a nation to look also for further supplies from the broader and richer lands of other countries, which, to their advantage and ours, the beneficent principle of Free-trade has placed within our reach.

The progressive increase of foreign supplies during the past twenty years is marvellous, the value of foreign cereal and animal food imported having risen from 35,000,000*l.* in 1857, to 110,000,000*l.* in 1876. The greatest proportional increase has been in the importation of animal food: living animals, fresh and salted meat, fish, poultry, eggs, butter and cheese, which in that period has risen from an annual value of seven to thirty-six millions sterling. More than half the farinaceous articles imported, other than wheat, are used in the production of beer and spirits.

The imports of animal food during the first fourteen years of free-trade were comparatively small, the difference of price here and in foreign countries not then affording a margin sufficiently encouraging to justify costly arrangements of transit. But as the price of meat in this country moved steadily up, rising in a few years from fivepence to sevenpence, ninepence, and even a shilling a pound, enterprise with skill and capital were called into rapid action to meet the growing demand. It became clear that an article so valuable could cover the cost of carriage for much longer distances than corn; a pound-weight of meat

Value of cereal and animal food imported from abroad.

Rapid rise in value of meat, the comparatively high price of which pays for long transport.

being many times more valuable than a pound of corn. All kinds of salted meat were expected, and came; but fresh meat (except as live animals), from its perishable nature, was not anticipated in any considerable quantity. The cost of transporting live animals from any great distance must obviously present a very important difficulty. And a further and most serious objection arose, in regard to those from nearer European ports, in the risk of such live animals bringing with them across the seas the contagion of cattle-plague, or other pests, dangerous to the live-stock of this country. All this could be avoided by the importation of fresh meat, and a plan with this object, recently adopted by an American company, has been attended with a large measure of success. The steam-ships in which the meat is carried have chambers fitted in such a manner that the meat can be kept fresh during the voyage by currents of air cooled by ice. During the last winter and spring large shipments have thus been successfully made, and most of them have arrived in good condition. Should this plan prove, on the whole, safe and successful, we shall have the vast prairies of America added to our own pastures as new sources of supply. This will be a great benefit to the consumers of meat in this country, but probably more by preventing a further rapid rise in the price of meat than by effecting a reduction upon it. The American people are themselves much greater consumers of meat, man for man, than the English, and when prosperity returns to that country their home consumption will increase, and the surplus for exportation be diminished. Moreover, the English market will take only the best quality. Under any circumstances the English producer has the advantage of at least a penny a pound in the cost and risk of transport, against his Transatlantic competitor,—an advantage equal to 4*l.* on an average ox. Of this natural advantage nothing can deprive him; and with this he may rest content.

Fresh meat from America may prevent rapid rise of price in Europe.

The proportion in which the people of this country are dependent for their principal articles of food on home and foreign supply, was the subject of an inquiry by me in 1868, in a paper read to the Statistical Society. At that time I found the foreign supply to be in the proportion of one-fifth of the whole. In the ten years since that time the importation of meat has more than doubled, butter and cheese have risen nearly one-third, wheat more than a third, and other grain has doubled. More than one-fourth of our total consumption of agricultural produce is now obtained from other countries.

Proportion of home and foreign supply of food in the United Kingdom.

But it is a question of interest, both to the home and foreign producer, to ascertain more closely the proportion of the two chief articles, bread and meat. In the past ten years there has

been a gradual reduction of the acreage and produce of wheat in this country, and a more than corresponding increase in the foreign supply; the result of which is that we now receive our bread in equal proportions from our own fields and those of the stranger. In regard to meat, and other animal products, ten years ago the proportion of foreign was one-tenth of the whole. It has now risen to nearly one-fourth.

This country thus derives from foreign lands, not only one-half of its bread and nearly one-fourth of its meat and dairy produce, but must also depend on the foreigner for almost the entire addition that may be further required by an increase of its population. In the last ten years there has been no increase in the acreage or production of corn, and little in that of meat. The extent of green crops and grass has slightly increased, from the double impulse of the rise in wages, and the increasing demand for dairy produce and meat. But, excluding good lands capable of being rendered fertile by drainage, we appear to have approached a point in agricultural production beyond which capital can be otherwise more profitably expended in this country than in further attempting to force our poorer class of soils. It is cheaper for us as a nation to get the surplus from the richer lands of America and Southern Russia, where the virgin soil is still unexhausted; or from the more ancient agriculture of India, which, with its cheap and abundant labour more skilfully applied, and its means of transport extended and better utilised, seems destined to become one of the principal sources of our future supply of corn.

The cost of carriage depends very much on distance, and as the chief supply of wheat comes from great distances, California, the Black Sea, and India, the cost of transporting a quantity equal to the produce of an acre in England is seldom less, and often more, than 40s. Hay and straw are so bulky that they can only bear the cost of carriage from near continental ports. Fresh meat from America, from the costly methods necessary to preserve it, will, on the produce of an acre, cost equal to 40s. for transport to this country. This natural protection enjoyed by the British farmer in his proximity to the home market, as compared with the foreign farmer who seeks our market for his produce, thus gives him an advantage equal to the present average rent of his land, and forms some reasonable compensation for the higher taxes and wages which he has to pay as compared with his competitors in most foreign countries.

The total home produce can now be very correctly calculated from the annual agricultural returns. The collection of these returns was instituted in Ireland at the time of the potato famine in 1847, and they have been published continuously since that

England now chiefly dependent on foreign supply for further increase.

Cost of carriage equal to the rent of land in England.

Agricultural statistics of the United Kingdom.

time. The information is collected by the constabulary, a semi-military force, stationed in all parts of the country, and is arranged by the Registrar-General, and annually printed.

Not for twenty years afterwards were there any complete returns from Great Britain. After long perseverance I succeeded in obtaining a Resolution of the House of Commons in favour of the collection of agricultural statistics, which was in consequence carried out for the first time in 1867, the collection of the returns being made by the officers of Inland Revenue, and their arrangement for publication by the Statistical Department of the Board of Trade. The experience gained by ten years' repetition of the various inquiries has created such a fund of local knowledge among the officers of the Inland Revenue that there can now be no doubt entertained of the substantial accuracy of the returns. Minute accuracy is not expected or required, but the comparisons from year to year show the relative accuracy obtained to be sufficient for all practical purposes.

Their accuracy sufficient for practical use.

It appears from these returns that though there was an exceptional decrease in the acreage of wheat in 1876, arising from the great floods in the autumn seed-time of 1875, which prevented a considerable proportion of the land being sown, no great change has occurred during the past ten years in the production of wheat in Great Britain. It has somewhat diminished in England and largely in Ireland, but the diminution is quite made up by a corresponding increase in barley. Oats remain much the same, and the total extent of arable is very slightly altered.

Their main features.

The permanent pasture during the same period has increased 8 per cent., no doubt from the increased cost of labour and the gradual rise in the value of live-stock and its produce. This increase of 8 per cent., amounting to nearly one million acres, not having diminished the extent of corn, must represent an addition of that breadth gained by reclamation during the ten years; and, as some considerable extent of land is yearly taken from cultivation by the increase of towns and the construction of new railroads, this shows an important gain by agricultural enterprise.

Increase of pasture.

The general extent of green crops has very slightly altered in the ten years, potatoes alone showing some diminution. A large increase, however, in the proportion of mangold is shown by a rise of 100,000 acres more than in 1867. This is a root-crop peculiarly well suited to the deep soils and dry and warm climate of the south-east and southern counties; and its keeping properties, continuing well into the following summer, are a great recommendation to the stock farmer. A rise of 40 per cent. in the breadth cultivated, within so short a period as ten years, is a convincing proof that the great value of this plant

Increase of the mangold crop.

is at length beginning to be generally recognised, and there seems a probability of its continued extension. In live-stock there has been a moderate increase in Great Britain during the past ten years.

Diminution of corn and increase of grass in Ireland.

In Ireland the change of crops has been greater than in England or Scotland, the extent of land under corn having diminished in ten years by 12 per cent. Wheat has fallen to less than one-half, there is an increase of 28 per cent. in barley, but a decrease of nearly 10 per cent. in oats. Potatoes have fallen 12 per cent., while turnips have slightly increased. On the whole there has been a diminution of 267,000 acres of land under corn, and an addition of 203,000 acres to permanent meadow and grass. The reduction of the acreage of wheat, for which the climate of most parts of Ireland is too moist, and the considerable decline in potatoes, the tempting but precarious crop upon which that country has hitherto too much relied, are evident signs of prudence and prosperity. In the same period, though there has been a reduction in the number of sheep, that is much more than compensated by an increase in cattle; and as the expenditure on drainage and land improvement, and in the building of farm-houses and labourers' cottages, has been greatly increasing, year by year, the state of agriculture in Ireland, chiefly owing to the high price of live stock, and the increasing demand for store animals to be fattened in Great Britain, now appears to have attained a position of general progress and prosperity greater than has ever been previously experienced in that portion of the United Kingdom.

Present great agricultural prosperity of that country.

The extent of land under the various crops in the United Kingdom in 1877, was, in wheat, 3,321,000 acres; barley, 2,652,000 acres; oats, 4,239,000 acres; potatoes, 1,393,000 acres; other green crops, 3,566,000 acres; flax, 130,000 acres; hops, 70,000 acres; bare fallow, 633,000 acres; grass under rotation, 6,441,000 acres; permanent pasture, 24,000,000 acres (besides mountain pastures and wastes); woods and plantations, 2,511,000 acres.

The number of live-stock of various kinds in 1877 was, of horses, 2,834,000; cattle, 9,693,000; sheep, 32,157,000; pigs, 3,964,000.

By the aid of the agricultural returns, and those of the annual imports of foreign and colonial produce, I have constructed the following Table, showing the comparative quantities of home and foreign growth, and the value of agricultural produce at present required for the annual consumption of the people, and live-stock, of this country. The grass, green crops other than potatoes, and straw used on the farm, are not included, nor the value of the increase of horses.



TABLE SHOWING COMPARATIVE QUANTITY AND VALUE OF HOME AND FOREIGN AGRICULTURAL PRODUCE CONSUMED ANNUALLY.

	Home Growth.	Foreign Growth.	Total.	Value of Home Growth.	Value of Foreign.	Total Value.
Wheat .. .. .	Cwts. 55,000,000	Cwts. 55,000,000	Cwts. 110,000,000	£ 32,187,500	£ 32,187,500	£ 64,375,000
Barley .. .. .	41,000,000	11,000,000	55,000,000	19,800,000	4,950,000	24,750,000
Oats .. .. .	64,000,000	12,000,000	76,000,000	28,800,000	5,400,000	34,200,000
Beans and Peas .. .. .	14,000,000	5,000,000	19,000,000	6,300,000	2,250,000	8,550,000
Indian Corn .. .. .	..	20,000,000	20,000,000	..	7,000,000	7,000,000
Total Corn .. .. .	177,000,000	103,000,000	280,000,000	87,087,500	51,787,500	138,875,000
Potatoes .. .. .	111,000,000	5,000,000	116,000,000	16,650,000	750,000	17,400,000
Butchers' Meat, Ham, and Pork .. .. .	24,500,000	6,300,000	30,800,000	87,000,000	22,050,000	109,050,000
Cheese and Butter .. .. .	3,000,000	3,100,000	6,100,000	13,500,000	14,000,000	27,500,000
Wool .. .. .	1,214,000	3,160,000	4,374,000	8,500,000	22,120,000	30,620,000
Milk .. .. .	..	..	..	26,000,000	..	26,000,000
Hay for horses, agricultural and not agricultural .. .. .	80,000,000	..	80,000,000	16,000,000	..	16,000,000
Straw sold for Town con- sumption .. .. .	40,000,000	..	40,000,000	6,000,000	..	6,000,000
Total .. .. .	436,714,000	120,160,000	557,274,000	260,737,500	110,707,500	371,445,000

Quantity and value of home and foreign agricultural produce, respectively, consumed annually in the British Islands.

The total value of the home crop is more than the double of that which we import, but the proportion of vegetable and animal food is singularly close, as will be seen by this farther arrangement of the figures :—

	Home Growth.	Foreign.
Value of corn and vegetable produce	£125,737,500	£52,537,500
Value of animal produce .. ..	135,000,000	58,170,000

The quantity of Indian corn imported in 1876 was nearly 40,000,000 cwt., an amount quite exceptional and unprecedented, and therefore not included in its full amount in the preceding Table.

## CHAPTER II.

### CHANGES AND PROGRESS OF AGRICULTURE IN RECENT YEARS.

The most striking features of recent agricultural progress.

BEFORE entering on a more detailed description of the principles which regulate the agriculture and general management of landed property in this country, it may be useful shortly to notice its more recent progress, and those changes of practice which science or art, or the circumstances of his position in regard to competition or labour, have forced on the British farmer. With a few exceptions the change will be found rather in the more general diffusion of a knowledge of good principles and practice than in any considerable advance upon either.

The reaping and mowing machines.

The most striking feature of agricultural progress within the last twenty years has been the general introduction of reaping-machines, one of which can do the work of ten men. This has multiplied the effect of human labour tenfold, and that at the most critical season, the harvest, when the entire crop ripens within a fortnight, and must with all possible expedition be saved without loss of time. For haymaking, a similar machine is in the same proportion available. It would be difficult to reckon the vast saving which the introduction of this most important invention has made at these most critical periods, haytime and harvest.

The steam-plough.

Next to it is the steam-plough, which, on heavy land and in large fields, especially where coal is moderate in cost and water easily available, is both economical and expeditious. A steam-plough capable of ploughing ten acres a day, will do the labour of ten men and twenty horses, and will execute the work much more effectively, and with no injurious trampling of the tender soil. But it is as yet a costly implement, beyond the reach of small farmers except when hired as an auxiliary, and not capable of doing its work with economy within small enclosures. The

I.  
GENERAL VIEW  
OF  
BRITISH AGRICULTURE.

BY  
JAMES CAIRD, C.B., F.R.S.,

AUTHOR OF 'ENGLISH AGRICULTURE IN 1850 AND 1851.'

I.

GENERAL PART

BRITISH AGRICULTURE

THE HISTORY OF

saving of labour is great in suitable localities, but it is not so uniformly applicable, nor does it so certainly and quickly repay its cost, as the reaping-machine. On light and friable soils the double-furrow plough, balancing itself with greatly less friction in proportion than the single plough, is found to do the same work with one man and three horses as two single ploughs with two men and four horses. This is equal to a saving of 100 per cent. in man-power, and 25 per cent. in horse-power, and it will become more generally available on the lighter soils if any serious pressure arises from scarcity of labour. In the threshing of corn, and cutting of straw and hay for fodder, and the grinding and bruising of corn and cake for horse and cattle food, the aid of steam-power has long been used by the farmers of this country.

The double-furrow plough.

General use of steam power in manipulation of crops.

Next to the economy of labour may be ranked the increase of produce by the expedient of taking two corn crops in succession where the land is clean and in high condition, and can bear the application of special manure, and where the agriculturist is free to follow a rational system of farming. The four-course system of alternate corn and green-crops—wheat, turnips, barley, clover—had two great advantages, first by alternating restorative and cleansing crops with corn; and second, by regular distribution of labour throughout the year. The introduction of guano, nitrate of soda, and other ammoniacal and phosphatic manures, has now rendered the farmer comparatively independent of this alternate system of cropping. As the supply of nitrate is believed to be capable of lasting for a very long period, we may reckon with considerable certainty on its continuance at a moderate price. It might become an instrument of great national value if any unforeseen occurrence should cut off one of our main supplies of wheat, that of Russia, for example. If only the twentieth part of the corn land of the United Kingdom were called on to bear an additional wheat crop, the loss would be at once made good, and with no perceptible strain on our agricultural system. If all Europe were shut against us, we should be quickly able to meet the increased home demand by double-cropping to the extent of one-tenth of our corn-land, and without any greater change in the demand for nitrate of soda than has already been met by the advancing supplies of recent years. It is unnecessary to consider the position of this country, were even a heavier calamity to befall us, obtaining as we do from the foreigner so large a proportion of our food, for it is not conceivable that the producers of corn in any country would desire to see the best market in the world long closed to them. But it is clear that we possess in this power of taking a second crop of wheat a latent reserve force which might, on very short notice, be

Successive corn crops.

Use to which this might be put in time of war.

brought into action, and which should dispel all fear of our being starved into submission in case of war; and this without reckoning anything on the immense reserve power of cereal production which is stored up in the pasture lands, ready in case of need.

Likely to check a permanent rise in the price of wheat.

It is a power, moreover, that will check any considerable permanent rise in the price of wheat. A decline in the acreage under wheat, when not caused by a bad seed-time, is the natural result of low price; but when the price rises, increased acreage quickly follows. Were the price to rise steadily, and show signs of permanency, the second-crop system would extend, and continue to do so until the increase of produce was found to check the rise in price. Barley may be taken after barley with more success on many soils than wheat; and where there is reason to suppose that a second crop of wheat, however carefully the ground may have been managed and manured, may be likely to fail, barley may, with great probability, be expected to succeed.

Autumn culture and steam-power, with imported manures, have given great command of crops.

The use of nitrate of soda or other sources of ammonia, combined with phosphatic manures, promises to be a more permanent resource to British agriculture than Peruvian guano, which unites the same properties in itself, but seems likely soon to become exhausted. Autumn culture, aided by the command of time which steam-power has given to the agriculturist, and that supplemented by spring top-dressings of nitrates and phosphates, have made continuous corn-cropping possible and profitable, without injury to the land, whenever soil and circumstances render such a practice necessary. The old plan of relying on the resources of the farm by depending on the manure made upon it, while the corn and meat were sold away, will not always answer now. Commerce and mercantile enterprise have provided other means for maintaining fertility at a cheaper cost, and in a more commodious and portable form. One cwt. of nitrate of soda will give a more certain return of corn than fifty times its weight in farmyard-manure, and can be carried to and spread upon the ground at one-fiftieth of the labour. The proof of this, in Mr. Lawes' experiments, has been before the country for more than thirty years, and yet it is only beginning to be generally recognised.

Great value to British agriculture of Mr. Lawes' experiments.

To Mr. J. B. Lawes the agriculture of this country is more indebted than to any other living man. For 33 years he has conducted, at his own cost, a series of experiments on his estate in Hertfordshire, the results of which have been annually published, and the farm itself, with every detail of the work, has been laid open to public inspection and criticism. Among other valuable results, one most useful fact has been elicited.



that of that mass of dark, strongly smelling substance called dung, its sole property as a manure depends upon the small quantity of chemical salts and of organic nitrogen which it contains, the bulky organic matter being only useful in making the land work better, and rendering it more capable of absorbing and retaining moisture. Beginning in 1844 with wheat, the staff of life in this country, he for eight years concentrated his attention upon it, dividing his experimental field into 22 plots, upon 2 of which no manure has ever been applied, and upon the other 20 a carefully considered variety of manures has been continuously used. In 1852 he commenced a similar series of experiments with barley, and in 1869 on a smaller area with oats. Experiments with leguminous crops had been for a series of years continued, but this species of plant being found, when grown too frequently on the same land, to be peculiarly subject to disease, which no conditions of manuring appeared capable of obviating, they were discontinued. With regard to red clover, when the land becomes clover-sick, it was found that no manure could be relied on to secure a crop, and continuous crops of it are therefore impossible. Experiments on the various root-crops were continued for series of years, and the result published; also on sugar-beet; and in 1876 a commencement was made with potatoes. His experiments on the corn-crops go on without cessation. In 1856 an important series of experiments was commenced on grass-land, which, with very little change on each of the 20 plots, has been continued to the present time. The average of the past twenty years shows that the natural produce may be doubled, and even trebled, by the continuous use of special manures. Seeing that nearly two-thirds of the cultivated area of this country, and all the uncultivated, are in grass, this series of experiments is of very great interest and value. After 33 successive wheat-crops it is not surprising that the soil begins to exhibit symptoms of exhaustion. The rotation experiments show that this may be corrected by interposing a heavily dunged green-crop, such as mangold, while the introduction of red clover between the corn-crops is also found to add greatly to the corn-producing power of the soil. To attain a maximum-paying produce, he finds that the land should be dunged heavily for mangold, to be followed with wheat or barley or oats, according to soil and climate, for several years in succession; then interpose clover, and follow it with corn-crops, keeping the land perfectly clean, and manuring all the corn-crops with nitrate of soda and superphosphate. When the land shows need of change, begin again with heavily-dunged green-crops. Successive crops of barley he finds to pay better, and are more certain than either wheat or oats, and give more corn in

Some of their  
special lessons.

proportion to straw. If a heavily-dunged green-crop is occasionally introduced, it is not necessary to give any other manure to the corn-crops than nitrate of soda and superphosphate. Potash (which may be supplied by dung) is very necessary in a grass-manure, especially for clover, which, unlike corn, is injured by ammonia. The grass experiments show that by giving food to the plants, the strongest and best varieties appropriate what they most need, and, by the law of the strongest, put the weakest down. In the best plots the weeds almost disappear, while on one plot, to which no manure is applied, the weeds form 50 per cent. of the produce.—Besides these experiments on crops, Mr. Lawes has carried out investigations on the feeding of live-stock, and on the different values of their food, both as affecting the processes of fattening and the quality and value of the manure.\*

The Woburn experiments.

The Royal Agricultural Society has commenced a series of experiments on the growth of crops and the fattening of live stock, with a special relation to the manures applied and the food used, and to the effect of the manures resulting from specific kinds of food. The Duke of Bedford, with great liberality and public spirit, has undertaken the cost of these experiments, and has placed suitable land and buildings at the disposal of the Society, whose Council, under the guidance of Mr. Lawes, and of Dr. Voelcker, their consulting chemist, regulate and superintend them. They are open to public inspection, and under such management the most useful results may be anticipated.

Extension of land drainage, and improvement of farm labourers' cottages, and housing for live-stock.

There has been a great extension of drainage in recent years, and in the construction of improved farm-buildings, and in the better lodging of farm-labourers in more commodious cottages. And in regard to live-stock there has been a wider diffusion of the best breeds, and generally an earlier maturity obtained in the process of fattening. The use of improved implements and machinery has greatly extended, as also has the general application of locomotive steam-power to the threshing and other preparation of crops for market or feeding purposes. Cheap descriptions of corn are largely employed in the fattening of stock, and also oil-cake, cotton-cake, and rape-cake. For these, and for bones, guano, and nitrate of soda used as manure, the annual expenditure cannot now be less than twelve millions sterling.

Large annual expenditure on cattle food and portable manure.

The change in the last thirty years more in the general diffusion of improved prac-

But, with the exception of the reaping-machine and steam-plough, and the more general use of steam-power, and other implements and machines, there is really little that is new in the practice of the last quarter of a century. The present system of drainage was previously well understood. Bones,

\* A more full description of the plan and results of Mr. Lawes' operations is given by Dr. Voelcker in his contribution to this Memoir.

guano, and nitrate of soda were fully appreciated by those who then used them. Covered buildings and autumn cultivation had been introduced. Mr. Hudson of Castleacre, in Norfolk, then manured his land for every crop. In running my eye over the account which I wrote of English agriculture in 1850, I find descriptions of good farming in nearly every part of the country, the details of which differ very little from the practice of the present day. Mr. Pusey and Sir John Conroy in Berkshire; Mr. Thomas in Bedfordshire; Mr. Beasley in Northampton; Mr. Paget in Notts; Mr. Torr in Lincoln; Mr. Mechi, Mr. Fisher Hobbs, and Mr. Hutley, in Essex; Mr. Huxtable in Dorset; Jonas Webb in Cambridgeshire; Mr. Morton in Gloucestershire; the Messrs. Wells and Outhwaite in Yorkshire; Mr. Fleming of Barrochan, Mr. McCulloch of Auchness, and Mr. George Hope, in Scotland; Lord Lucan, Mr. St. John Jeffryes, and Mr. Boyd of Castlewellan, in Ireland, and many others, then carried out the business of farming in a manner that would bear favourable comparison with the prize-farms of the present year. And, as to breeds of cattle, the brothers Colling's and Messrs. Booth's and Mr. Bates's Short-horns, George Turner's and the Messrs. Quartley's Devons, Mr. Bakewell's Leicesters, Jonas Webb's Southdowns, are not surpassed by the best of the present day. The change has been not in any considerable progress beyond what was then the best, but in a general upheaval of the middling and the worst towards the higher platform then occupied by the few.

Towards this end, but beyond all efforts of the agriculturists themselves, or of the engineers and chemists who have done so much to aid them in developing the capabilities of the land, has been the influence of the general prosperity and growing trade and wealth of the country. Thirty years ago, probably not more than one-third of the people of this country consumed animal food more than once a week. Now, nearly all of them eat it, in meat or cheese or butter, once a day. This has more than doubled the average consumption per head; and when the increase of population is considered, has probably trebled the total consumption of animal food in this country. The increased supply has come partly from our own fields, but chiefly from abroad. The leap which the consumption of meat took in consequence of the general rise of wages in all branches of trade and employment, could not have been met without foreign supplies, and these could not have been secured except by such a rise of price as fully paid the risk and cost of transport. The additional price on the home-produce was all profit to the landed interests of this country, and is now being shared among them, partly in rise of rent, partly in

tices, and better live-stock, than in the introduction of new systems.

Influence upon agriculture of the general prosperity of the country in the rise of the price of meat, and the consequent increase in the capital value of live-stock,

increase of profit, and chiefly in rise of wages and expenses, and local rates. Within the last twenty-five years, the capital value of the live-stock of the United Kingdom has risen from one hundred and forty-six to two hundred and sixty millions sterling, a gain of one hundred and fourteen millions.

and in that  
of land.

It will be subsequently shown, when treating of the value of land, that within a somewhat shorter period the increase of the land-rent of this country, when capitalised at 30 years' purchase, shows an increased value of three hundred and thirty-one millions sterling. When we add to this the increase of farm-capital, through the rise in the value of live-stock, one hundred and fourteen millions, there is the amazing sum of four hundred and forty-five millions sterling as the gain to the agriculturists,—the landowners, and farmers—and, in higher wages, to the agricultural labourers of the United Kingdom, from the improvement of land and the general prosperity of the country. I may, perhaps, be excused for quoting the concluding words of my volume, written in 1851, at a time of great agricultural depression, when I stated that I believed the landlords and tenants of England possessed energy and capacity sufficient to meet and adapt themselves to the Free-trade policy, “which, in its extraordinary effect on the welfare of all other classes of the community, would, sooner or later, bear good fruits also to them.”

---

### CHAPTER III.

#### SOIL, CLIMATE, AND CROPS.

Extent of the  
country, and  
proportions of  
various crops,

THE total extent of the United Kingdom is 76,300,000 acres, of which 26,300,000 are in mountain pasture and waste, and 50,000,000 in crops, meadows, permanent pasture, and woods and forests. Of the crops, one-fourth is in various kinds of corn, one-eighth in green crops, one-eighth in grass under rotation, and one-half in meadows and permanent pasture. About a thirtieth of the whole surface of the Kingdom is in woods and forests. These proportions show the prevailing system of husbandry, and reveal the cause of its increasing productiveness. Three-fourths of the whole are green crops, which feed and clean, or grass which rests and maintains, the remaining fourth in corn. This preponderance of restorative over exhaustive crops greatly exceeds that of any other country, and is very much due to the climate.

as influenced  
by climate,

The climate of the eastern side is drier than that of the west, the fall of rain at equal altitudes being as 25 inches in the east to 35 in the west. The drought and heat are greatest in the

east, centre, and south-east in spring and summer. The whole western side of the country is comparatively mild and moist, and specially adapted for green crops and pasture. The east, having generally a deeper soil and greater heat in summer, is best suited to wheat and barley. It produces 64 per cent. of all the wheat and barley grown, and 74 per cent. of the pulse crops. The west, on the other hand, contains more than twice the extent of permanent pasture, and produces nearly double the number of cattle. The waters of the Gulf Stream envelop the British Islands. Their vapours, carried over every part of the Kingdom by prevailing west winds, temper the cold of winter, and the heats of summer. This favours the growth, on the west especially, of succulent herbage and green crops, and we are free from the extremes experienced on the Continent. Grass and green crops flourish in all parts of the country, and both in the low lands and on the mountain pastures of the west and north, sheep feed unsheltered and unhoused during both winter and summer. Beasts of prey are unknown.

The annual rainfall in the lower parts of the country varies and rainfall. from 25 to 35 inches. In the mountainous districts these figures may be doubled. But, limiting our consideration to the cultivated lands, it must be obvious that an annual rainfall upon an acre of land, in the one case of 2500 tons and in the other of 3500 tons, accompanied by corresponding humidity of atmosphere, will greatly modify the respective systems of husbandry practised. Accordingly, the eastern half of the country may be correctly described as the corn and fattening region, and the western half as the dairy and breeding region of the Kingdom. The winter temperature is more severe in the east than the west, and that of the summer warmer and more sunny and better suited to the ripening of wheat; while that of the west, being less scorching and more cloudy, is better adapted to pasture and oats. The value of live-stock is so much greater than corn, that it is not found profitable to push the limit of cultivation to a greater height than 800 feet in the east and 500 in the west, and these limits are becoming more circumscribed by the increasing cost of labour and the continued rise in the value of live-stock.

The soil varies greatly in fertility, and its cultivation is regulated both by the amount it yields and the cost of cultivating it. The most profitable and productive soil is that which is at once fertile and easy of cultivation. A rich loam which yields a ton of wheat to the acre is less costly in labour than a poor clay which yields little more than half that weight. Weight and relative value of corn crops. Between corn and straw an average crop of wheat, barley, and oats, will weigh two tons an acre; about two-fifths being corn



and three-fifths straw, though the proportion of straw to corn in wheat and oats is greater than in barley. A ton of wheat, at the average price of the last fifteen years, is worth 11*l.* 14*s.*; a ton of barley, 9*l.* 12*s.*; and of oats, 9*l.* But the wheat is more costly to grow, as it is four months longer in the soil, and therefore takes more out of it than either barley or oats, and requires either a better soil or more enriching preparation. On soils of equal quality the average weight of barley and oats yielded by an acre exceeds that of wheat in about the same proportion as it falls short of it in value per ton. Hence, where the soil and climate are equally suited to the production of these varieties of corn, the choice of one or the other is more a question of convenience than profit, and depends much on the local value of the different kinds of straw.

Examples of  
soils of the  
greatest and  
least natural  
fertility,

The fertility of a soil may be expressed by examples taken, 1st, in the natural state of pasture, and 2nd, on similar soils after treatment. The maximum of fertility in the natural state is a rich pasture capable of fattening an ox and two sheep on an acre. Such soils are exceptional, though in most counties they are to be met with. The Pawlet Hams in Somersetshire, for example, is a tract of rich alluvial soil on the River Parrott, stretching along the sea-board. It is in permanent pasture, and is let for grazing at 5*l.* to 6*l.* of rent an acre. Some of the marsh lands of Sussex and Kent are of equal fertility. And on certain limestone lands, not alluvial, in various parts of the country, both east and west, feeding pastures of great fertility are met with. Such lands, as they require neither labour nor manure, yield the largest rents to their owners. The profit to the stock feeder beyond the rent paid to the landowner depends on the skill with which he conducts his business.—The minimum of fertility may be exemplified by a bleak mountain pasture, where ten acres will barely maintain a small sheep.

and of an  
average soil  
unmanured,  
and specially  
manured.

The artificial maximum and minimum of fertility which result from the treatment of soils of the same quality is more instructive, and may be clearly exemplified by taking two of the experiments which have been carried on by Mr. John B. Lawes of Rothamsted, in Hertfordshire, for the last thirty years. Confining the comparison to the average of the last twelve years, the following is the weight in pounds of an average crop:—

	Corn.	Straw.	Total.
1st. Wheat grown continuously without manures	730	1120	1850
2nd. „ „ „ with special manure ..	2342	4928	7270



The soils here are exactly similar and in the same field, strong land on clay with a substratum of chalk ; the management is the same, in so far as culture is concerned ; both crops are kept equally clean and free from weeds, the same seed is used, and they are exposed to the same changes of weather. The only difference is, that in the one case nature has for thirty years been unassisted by manure, and in the other the soil receives every year the various kinds of manure which have been found most suitable to the crop. The result of this treatment is a return of three times the weight of corn and four times the weight of straw, for an expenditure in manure which leaves a profit of 100 per cent. on its cost. In both cases the wheat is grown continuously year after year.

The plants which predominate in uncultivated land depend both on the nature of the soil and on the climate and situation. On poor gravel, furze grows in abundance ; on peaty uplands, short heath ; on cold, wet bottomed soils, rushes cover the ground. Natural woods of birch and oak are found in sheltered Highland glens, and self-sown Scotch firs spread themselves in the neighbourhood of extensive pine forests.

---

#### CHAPTER IV.

##### DISTRIBUTION OF LANDED PROPERTY.

THE distribution of landed property in England, so far as ownership is concerned, is, by the growing wealth of the country, constantly tending to a reduction in the number of small estates. This tendency is further promoted by the law, which permits entails and settlements, thus hindering the natural sale of land so dealt with ; and also by rights of primogeniture, which prevent subdivision of landed property among the family in case of intestacy. Cultivation thus passes out of the hands of small owners into those of tenant-farmers, causing a gradual decrease of the agricultural population, and a rapid increase of the towns. This has been much accelerated by a policy of Free-trade, which has at once opened up the markets of the world for our commerce, and for the produce of our mines and manufactures. These are advantageously interchanged for the corn and other agricultural products of foreign lands. This will go on while the commerce is found mutually profitable. And it will be profitable so long as by superior skill and enterprise, combined with exceptional mineral advantages, we can undersell other countries in the produce of our manufactories

Tendency of landed property to diminution in the number of small estates.

and mines, while they can supply us with corn at a cheaper rate than we can grow it at home. Our present relation with foreign countries is becoming like that of a crowded capital, which draws its fresh supplies of vegetables, milk, and meat, from the market-gardens, meadows, and rich grazings in its vicinity, but looks to more distant lands for the corn and other commodities which bear long transport from cheaper and more distant farms. More than one-half of our corn is now of foreign growth, and nearly one-fourth of our meat and dairy produce; whilst year by year our corn-land is giving place to the more profitable produce afforded by the milk and grazing and market-garden farms, which are gradually extending their circle. Such produce renders the land more valuable, more tempting prices are offered for it to the small landowners, and their numbers decrease. Wealthy men from the mines and manufactories and shipping and colonial interests, and the learned professions, desire to become proprietors of land; and some competition exists between them and those landowners whose increasing wealth tempts them on suitable opportunities to enlarge the boundaries of their domains. Thus small proprietors are bought out, and agricultural landowners diminish in number; while, side by side with them, vast urban populations are growing up, having no other connection with the land than that of affording the best market for its produce.

Proportion of landowners to whole population, 320,000 to 33,000,000.

The Domesday Book for the United Kingdom, lately published, divides the landowners into two classes—those who have less than one acre of land, and those who have one acre and upwards. The former comprise 70 per cent. of the whole; but as none of this class has so much as an acre, and they hold altogether less than a two-hundredth part of the land, they may be regarded as householders only. Excluding these as not properly agricultural landowners, it may then fairly be said that one person in every hundred of the entire population is a landowner. Subdividing that figure by the average numbers of each family, it may be concluded that every twentieth head of a family is an owner of land.

Increased by the interests of tenant farmers as part owners of agricultural property.

But the tenant farmers are entitled also to be reckoned as part owners of agricultural property, for in the crops and live and dead stock they own equal to one-fifth of the whole capital value of the land. Part of this is incorporated with the soil, and it is all as indispensable for the production of crops as the land itself. As cultivators, they employ and possess individually a larger capital than the peasant proprietors of other countries in their double capacity as owners and cultivators. They are 1,160,000 in number, and when added to 320,000 owners of one acre and upwards, make 1,480,000 altogether, engaged in the owner-

ship and cultivation of the soil. When reckoned as heads of families they comprise more than one-fifth of the total male adult population; and it is thence not unreasonable to infer that, in that proportion, the people of this country are more or less interested in the preservation of landed property.

When we come more closely to analyse the landowning class, the aggregation of land amongst small numbers becomes very conspicuous. One-fourth of the whole territory, excluding those under one acre, is held by 1200 persons, at an average for each of 16,200 acres; another fourth by 6200 persons, at an average for each of 3150 acres; another fourth by 50,770 persons, at an average for each of 380 acres; whilst the remaining fourth is held by 261,830 persons, at an average for each of 70 acres. An interesting compilation from the Domesday Books by the 'Scotsman' newspaper, shows that the Peerage of the United Kingdom, about 600 in number, possess among them rather more than a fifth of all the land, and between a tenth and an eleventh of its annual income.

One-fifth of the land held by the Peerage.

The great bulk of the land in the United Kingdom is not cultivated by the owners, but by tenant-occupiers. Of these there are 561,000 in Great Britain, and 600,000 in Ireland. Excluding the mountains, wastes, and water, the cultivated land is held by these at an average of 56 acres each in Great Britain, and 26 acres in Ireland. But the proportion of large and small farms in the two countries is very different, nearly half the land in Ireland being held in small farms under 15 acres each, while less than a fifth of Great Britain is so occupied. 86 per cent. of the farmers in Ireland hold nearly half the land, while 70 per cent. in Great Britain hold less than a fifth. Agriculture is the principal occupation of the people of Ireland, the revenue from the land there forming twice as much as that from all other sources, whilst in Great Britain it is but a seventh of the whole. Hence in Ireland the possession and occupancy of land is the great political question, while in Great Britain it has ceased to have prominence.

Not cultivated by owners but by tenant-farmers;

relative extent of their holdings in England and Ireland.

This country, from its insular position and the great resources it possesses in minerals of iron and coal, and the outlet it finds in extensive colonies, has advantages which have hitherto enabled it to disregard those prudential considerations which, in some other countries, have checked the rapid increase of population. Where full employment and the means of subsistence are abundant, population increases in geometrical progression, and therefore in a far more rapid proportion than the increased productiveness of the soil, which, after a certain point, is stationary. The population of England increases more rapidly than that of France, because our enormous foreign trade,

Trade and Colonies enable England to dispense with checks on increase of population.

amounting in value to 20*l.* per head of our population, enables us to add the food resources of other countries to our own. Our surplus population, not wedded to the soil by property, emigrate to countries of the same language, at the rate of 100,000 a year; partly to the United States, and partly to our own colonies. Our agriculture is no longer influenced by considerations of the means of finding employment for surplus labour, but is now being developed on the principle of obtaining the largest produce at the least cost, the same principle by which the power-loom has supplanted the hand-loom. In this process many ancient ties are loosened, and among them that adhesiveness to the soil which for generations has more bound the English labourer than the owner of the land to the parish of his birth; the man of most ancient known descent being in very many cases the labourer. The process is a wholesome one so long as the command to multiply and replenish the earth has not been fulfilled. And the general rise of wages among the labouring class both in town and country, with the diminution of pauperism, in the last five years, would seem to be a satisfactory proof that there is still room in this country, and no need to check the growth of population.

Such a check, however, took place in Ireland at the time of the potato-famine in 1846. The population was then eight millions and a half. Within five years it had fallen to six millions and a half, nearly one-fourth of the people having either emigrated or died. The deaths from fever and famine had ceased in 1850, but the emigration continued, partly to Great Britain and the colonies, but chiefly to the United States. The population had fallen in 1871 to 5,412,000, and was then almost the same as that of 1801, seventy years before. There is no darker page than this in the history of our country in the present or preceding century. Millions of money were lavishly spent by the Government in direct relief, and in relief and improvement works to give employment, with a view to palliate the collapse which befell a people who had no resources when the potato failed them. The landowners in the more distressed districts were nearly as much broken down as their tenants. They had either encouraged or not discouraged the continued subdivision of small farms, as well as the rapid increase of the people, by which, so long as the potato could be relied on, their rents were increased. The famine-stricken land was everywhere abandoned by the starving occupiers, and thrown tenantless upon the owners' hands, making many of them bankrupt. An 'Encumbered Estates Act' was passed, to sell off the lands of those proprietors whose incumbrances had overwhelmed them, and substitute others more capable of fulfilling the duties of land-

Checked in  
Ireland by  
potato famine  
in 1846. Its  
results.

owners. In a few years land to the value of twenty-five millions sterling was disposed of, twenty-four of which were distributed among creditors. In order to secure the landowners' prompt attention in future to the condition of the people, the incidence of the Poor-rates, which had previously been placed wholly on the tenant-occupier, was divided equally between him and the landowner. In fifteen years, emigration and the sale of encumbered estates had removed the most needy class of the population. Prosperity then began again to dawn upon agriculture in Ireland, works of improvement followed the introduction of capital, supplied partly by Government loans and partly by the new landowners. Labour having become less plentiful, was better employed and more liberally paid, and the more energetic of the small farmers were ready to enlarge their holdings on every favourable opportunity. As time went on, a great change was found to have taken place, the old eagerness for the occupancy of land returned, but not for its subdivision. In less than thirty years, 270,000 of the smallest holdings were merged into adjoining larger farms, one-half of the small holdings of 1845 having totally disappeared. The tide of emigration began to turn, extreme poverty ceased, the proportion of paupers to the population became much lower, and the cost of poor relief nearly one-half less, than in either England or Scotland. This was accompanied by better wages to the labourer, higher profits to the farmer, and a rise in the value of land, all fostered by a growing demand for the kind of produce which the soil and climate of Ireland are specially adapted to yield. But the lesson left by the previous disaster has led to the gravest distrust in the system of very small holdings, in a country producing neither wine nor oil, and where the occupier is not the owner of the land.

Decrease of smallest holdings on the return of prosperity in Ireland.

It is worthy of note that the strictly rural parishes of England exhibit some decline of population. In one-fourth of the registration-districts there has been a diminution of the agricultural population in the ten years ending 1871, amounting altogether to 108,000. And it is quite certain that this continues. It arises from the natural draft to the better-paid labour of the mining, manufacturing, and other industrial centres, which are augmented both by this immigration and by natural increase. Diminished population in the rural districts is followed by a rise of wages; and this leads to greater economy of labour, both by the introduction of labour-saving machinery and the conversion of arable land to pasture, where the nature of the soil admits. The higher price of meat and dairy-produce also contributes to this change. But the loss in numbers of the agricultural districts is amply made good by the gain in the rest of the country, the population now employed in agriculture being small com-

Diminution of agricultural population in proportion to other classes in England.



pared with that of the other industries. Fifty years ago a fifth of the working population of England was engaged in agriculture. At the present time there is less than a tenth.

Class of yeomen, farming their own land, now in very small proportion to that of tenant-farmers.

The land of the United Kingdom may be said to be now almost wholly cultivated by tenant-farmers. The class of yeomen, or small landowners farming their own land, is found here and there in England, but scarcely at all in Scotland, and now bears but small proportion to the whole. Many of the larger landowners retain a farm under their own management for home supplies, or for the breeding of selected stock; very few as a matter of business, or for profit. The general system is, that the landowners make the permanent works on their estates, their income being paid in rent by tenant-occupiers; the tenants in their turn direct the cultivation, provide the farm-stock and implements and all the necessary capital and skill, and employ and pay the agricultural labourers by whose work the land is cultivated. The system is so general in the United Kingdom, that we really cannot be said to know any other, and yet, with reference to almost every country but our own, is so exceptional in Europe, that some description of it may here be useful.

Peasant proprietors in Ireland.

The circumstances of Ireland eight years ago appeared favourable for the creation of a class of peasant proprietors, and Parliament resolved to give the principle a trial. Two opportunities presented themselves; first, in 1869, on the disestablishment of the Church, which possessed upwards of 10,000 small holdings of land, in the benefices situated all over the country. The pre-emption of these was offered to the tenants on terms most favourable to them, both as to price and payment, and nearly two-thirds of the offers were promptly accepted. Again, in 1870, the Irish Land Act contained provisions expressly favouring the system; but, though great advantages in regard to terms of payment were also offered by that Act, the results hitherto have been comparatively small. The cause of the difference is very plain. In the first case the disposal of the lands was imperative, and did not occasion the subdivision of property; while the vendors, the Church Commissioners, having no one to consult but themselves, offered these small holdings at low fixed prices without competition. In the second case, on the other hand, it is the duty of the Landed Estates Court to get the best price they can for the landowner, who may very naturally object to allow small portions to be sold here and there out of his estate to suit the convenience of individual tenants. The farmers, moreover, begin to find themselves very secure in their possession as tenants, under the clauses of the Act, and have thus less inducement to buy the fee-simple; and



the landowners, participating in the general prosperity, are no longer under pressure to sell at the low prices hitherto realised. It is thus not from any defects in the Land Act, but from the improved condition of the country, and the increased security given to farmers' capital by the Act itself, that this branch of it has become less operative than was anticipated.

---

## CHAPTER V.

### LANDOWNER, FARMER, AND LABOURER.

THE landowners are the capitalists to whom the land belongs. Their property comprises the soil and all that is beneath it, and the buildings and other permanent works upon it required for the accommodation of the people, and of the working stock employed in its cultivation. Thus, where the land itself may be worth 35*l.* an acre, the buildings, roads, fences, and drainage may have cost the landowners 15*l.* an acre more. The landowner has thus two capitals in the land, one of which is permanent and growing rapidly in value with the prosperity of the country, the other liable to decay and occasioning cost in repair. In nearly all permanent improvements arising from the progress of agriculture he is also expected to share the cost. And he is necessarily concerned in the general prosperity and good management of his estate, and in the welfare of those who live upon it, with which his own is so closely involved. He takes a lead in the business of his parish, and from his class the magistrates who administer the criminal affairs of the county, and superintend its roads, its public buildings, and charitable institutions, are selected. Nor do his duties end here, for the landowner, from his position, is expected to be at the head of all objects of public utility, to subscribe to, and, if so inclined, to ride with the hounds, showing at once an example to the farmers and tradesmen, and meeting them on terms of neighbourly friendship and acquaintance. The same example is carried out in his intercourse with the clergy and schoolmaster, and his influence, where wisely exercised, is felt in the church, the school, the farm, and the cottage.

This class in the United Kingdom comprises a body of about 180,000, who possess among them the whole of the agricultural land from 10 acres upwards. The owners of less than 10 acres each, hold not more than one-hundredth part of the land, and may here be regarded as householders only. The property of the landowners, independent of minerals, yields an annual rent of sixty-seven millions sterling, and is worth a capital value of two

The land-owners; their position, duties, and influence:

their number, and the immense capital value of their property.

thousand millions. There is no other body of men in the country who administer so large a capital on their own account or whose influence is so widely extended and universally present. From them the learned professions, the church, the army, and the public services are largely recruited.

The tenant-farmers; the proportionate extent of their holdings, and the emulation that exists among them.

The tenant-farmers are the second class, and a much more numerous one. Their business is the cultivation of the land, with a capital quite independent of that of the landowner. They occupy farms of very various extent, 70 per cent. of them under 50 acres each, 12 per cent. between 50 and 100 acres, and 18 per cent. farms of more than 100 acres each. 5000 occupy farms of between 500 and 1000 acres, and 600 occupy farms exceeding 1000 acres. Many of them are men of liberal education, and some of these are found in most parishes and in every county. A spirit of emulation exists among them, elicited by county, provincial, and national exhibitions of agricultural stock, and by a natural desire, in a country where everything is open to comment, not to be behind their neighbours in the neatness, style, and success of their cultivation, or in the symmetry and condition of their live-stock. They are brought into the closest relations with their labourers, and although, occasionally, feelings of keen antagonism have arisen, there is generally a very friendly understanding between them. The farmer knows that it is for his interest that the labourers should find their position made so comfortable as to value it.

To the farmer is committed the management of the details of the parish, as those of the county to the landowner. His intimate knowledge of the condition of the labourer, and constant residence in the parish, fit him best for the duty of Overseer of the Poor, member of the Board of Guardians, Churchwarden, and Surveyor of the Roads. He is frank and hospitable to strangers, as a rule; in favour of the established political institutions of the country; loyal as a subject; generally available in case of need as a mounted yeoman; and constantly in requisition as a jurymen in the Courts of Law.

Their numbers, and capital.

The farmers are six times as numerous as the landowners, there being 560,000 in Great Britain, and 600,000 in Ireland, the holdings there being on a smaller scale. They employ a vast capital in the aggregate, upwards of four hundred millions sterling, and, unlike that of the landowners, much of it is in daily use, circulating among tradesmen and labourers.

Land-agents.

Between the landlords and farmers there is an intermediate class, the land-agents, to whom on most large estates the details of transacting business with the farmers, and looking after the cultivation and buildings and general condition of the property, are committed. These gentlemen, in most cases, are prepared by

a course of special training and education for the very important and delicate duties thus intrusted to them. Where they possess such an amount of general knowledge as enables them to carry their employer with them in all equitable arrangements for maintaining the property in a state of high agricultural efficiency, they perform a most useful function, and add very greatly to the welfare and comfort of all connected with the estates which they administer. A very eminent living authority rests the tenure of property on the fulfilment of duty; and a most important part of that duty is to see that no good land upon it is suffered by neglect or mismanagement to remain unproductive.

The third class comprises the agricultural labourers, who are necessarily much more numerous than both landowners and tenants. They cannot be said to have any other capital than the furniture of their dwellings, their well-acquired experience in all the details of husbandry, and the bodily strength to use it. The English labourer, of the southern counties especially, has hitherto had but little education, except in his business. The Scotch have had their parish schools for three centuries, and the Irish a national school system for the last forty years. The legislation of 1876 has removed this blot on the English system, by enacting that no child shall be employed at any kind of labour until he is of the age of ten, nor above that age unless he can show a certain degree of proficiency in education. This excellent rule is a virtual compulsion of education, as parents and employers alike are liable to penalties for its infringement. And as it is now accompanied in all parts of the kingdom by the establishment of duly regulated schools, no child can avoid an elementary education.

The state of the agricultural labourer of the Southern counties has long been the subject of reproach, and, till a recent period, not without good reason. In many parishes the average rate of wages was below the means of maintaining a man's bodily strength adequate to good work, and the result was that two men at low wages were kept to do the work of one well-paid labourer. The employer was a loser by this; and though he might be aware of it, he could not help it, for there was a redundancy of labour seeking employment, and which had to be maintained either by wages or poor-rates. The labourer himself was uneducated, having little knowledge of any district outside his own parish, no means of moving beyond it, while he risked the loss of his legal right to the parish relief in illness or old age, if he left it. In such circumstances it was hardly possible for the agricultural labourer to attain any degree of independence. There was no margin for saving, no surplus out

The labourers:

their state in some of the southern counties long a subject of reproach, but now mending.

of which an enterprising man could make the venture of moving his labour to places in which it would command a better return. And during the long period that this continued, his condition was low, and still shows itself in his small stature and slow gait. From the pressure of this system he was at last emancipated by the extension of his legal right of relief from the parish to the Union, a district much more extensive, and by the simultaneous increase in the demand for labour arising from the rapid development of the other industrial resources of the country. The great extension of steam-communication with America, and the encouragement thereby afforded to emigration, drew off rapidly the surplus agricultural population of Scotland and Ireland; wages in both countries quickly increased, and this soon extended its influence southwards. Agricultural labourers' unions were formed in the depressed districts just when this wholesome feeling was spreading throughout the country, and to their efforts much of the natural effect of other causes in producing a rise of wages has been ascribed. This increase of wages was attended by a most useful result, for it forced upon farmers the more extensive use of machinery, and, in the end, brought about a higher scale of wages to the labourer, while the additional cost to the farmer is met to some extent by superior skill, and greater economy in the application of labour. It is worthy of note that the increase of agricultural wages has been greatest in Scotland, where labourers' unions have not taken root.

Condition now better than at any previous period, comparing their wages with the price of bread.

The general condition of the agricultural labourer was probably never better than it is at present. Compared with that of 300 years ago, in the time of Elizabeth, wages have risen sixfold, while the price of bread has only doubled. Two centuries later, in 1770, the farm-labourer's wages was 1s. 2d. a day, when the price of wheat was 46s. a quarter. In 1846, immediately before the repeal of the Corn Laws, wages were 1s. 7d., when wheat was 53s. At the present time wages have risen 60 per cent., while wheat has not increased in price. In other words, the labourer's earning power in procuring the staff of life, cost him five days' work to pay for a bushel of wheat in 1770, four days in 1840, and two-and-half days in 1870. He is better lodged than he ever was before; though, in many parts of the country, there is still much room for improvement in that respect. Compared with the labourer in towns, his position is one of greater comfort; he lives in a better atmosphere, he is more free from anxiety, and has a closer and more friendly relation with his employers, and with the schoolmaster and clergyman of his parish. He is kind to animals, understands how to manage them, and in his family shows a good example, on the whole, of sobriety and industry.

To these three classes are committed the agricultural interest and industry of the kingdom. The two first have duties entrusted to them by the constitution, for the management of the public and local interests of their counties and parishes, in addition to their special business as landowners and agriculturists. Each of the three classes is constantly being altered and recruited by changes and additions. Landed property of the value of several millions sterling a year changes hands, and as there is necessarily a larger body of persons capable of competing for small properties, there is a natural tendency to sub-division on sale. In every county many farms change their tenants at Lady Day or Michaelmas, new men with new ideas being substituted for the old, some of whom have died, some retired from business, and some moved elsewhere. Labourers move about more than they used to do, and learn something useful in each change, and large drafts of them pass off to the other industrial pursuits of the country, and to the colonies. The feeling of being bound to the soil or the parish of his birth has lost much of its strength, and every facility is now presented to the unmarried agricultural labourer for improving his position if he desires to alter it.

Each of the three classes constantly recruited by changes of property and employment.

In short, our system is that of large capitalists owning the land; of smaller capitalists, each cultivating five times more of it than they would have means to do if they owned their farms; and of labourers free to carry their labour to any market which they consider most remunerative. It has been the gradual growth of experience in a country of moderate extent, where land is all occupied, where capital is abundant and constantly seeking investment in land; and where other industries than agriculture are always demanding recruits from the children of the agricultural labourer, who find, besides, a ready outlet in those British colonies where the soil and climate are not much different from that which they leave, and where their own language is spoken. And doubtless this facility of language has greatly helped the people of this country in encountering the trials and difficulties of emigration. But the want of it may be successfully overcome, as the example of Germany has proved in the tens of thousands of her people who have gone to the United States. There, and in the vast continent of Australia, there is room enough to take, with advantage, the surplus population of every country in Europe for many generations. Instead of struggling at home as cultivators of small patches of land, where nothing but the most sparing frugality enables them to live, the working men of all countries are invited and assisted by Australia to take a share on equal terms with our own people in the great enterprise of colonising a new continent,

where liberty, order, and remunerative employment are offered to all comers; where the climate is pure and healthy for Europeans, and where every industry, agricultural, manufacturing, or mining, affords a field for enterprise.

The result of the system compared with that of other countries shows larger returns at less cost.

A system is best tested by its fruits. Compared with all other countries, our threefold plan of landlord, farmer, and labourer, appears to yield larger returns, with fewer labourers, and from an equal extent of land. Our average produce of wheat is 28 bushels an acre, as against 16 in France, 16 in Germany, and 13 in Russia and the United States. We show a similar advantage in live-stock, both in quantity and quality. We have far more horses, cattle, and sheep in proportion to acreage than any other country, and in all these kinds there is a general superiority. Our most famous breeders of live-stock are the tenant-farmers. The best examples of farming are found in the same class. The improved breeds of cattle, the Leicester and Southdown sheep, and the extended use of machinery, manures, and artificial foods are chiefly due to them. And the neatness of the cultivation, the straight furrow, and the beautiful lines of drilled corn, the well-built ricks and docile horses, exhibit at once the strength and skill of the labourers. If that mode of husbandry which lessens the exchangeable value of bread and meat by an increase of production and supply, is the best for the community, from whom a smaller proportion of their labour is required for the purchase of their food, then our system of subdivision of labour by landowner, farmer, and labourer, the three interests engaged in its production, will stand a favourable comparison with that of any other country.

Special features presented by it in each of the three countries; in England,

in Scotland,

There are characteristic features in the business relation between the landowner and farmer which deserve notice, in its application to the three countries, England, Scotland, and Ireland. In England the general system is tenancy at will, by which the connection may be terminated on six months' notice. The result is, that the notice is rarely given, changes of tenancy are comparatively few, and systems of management are slowly altered. In Scotland there has long been tenancy on a nineteen years' lease. The certainty of the tenure up to a fixed time prompts immediate enterprise to make the most of that definite period, and changes of tenant at its conclusion have become frequent. There can be no doubt that this has been attended with a more hearty and ready appreciation of improved processes on the part of both landlord and tenant, and a higher scale of wages to the labourer. It still needs, however, some equitable rules to secure continuance of the tenant's interest in good farming to the close of the lease. And the Scotch tenants are



also hampered by an unreasonable law which prohibits them from transferring their leases even to a solvent and unobjectionable successor, and, still worse, from bequeathing the lease to their widows or any of their children except the heir-at-law. Ireland has a system of its own. Till a very recent period the tenant made all improvements, such as they were. He reclaimed the waste, built his own poor habitation, and he and his family occupied the land, and subdivided it amongst them. He thus tacitly acquired a hold on the soil much greater than in the sister countries, and which was generally acquiesced in by the landlords, many of whom were non-residents. These three systems were the natural growth of circumstances, and have become deeply intertwined with the habits and feelings of the agricultural classes in the several countries. in Ireland.

Three-fourths of the land in England have long been held by a comparatively small body of great landowners. From the Revolution in 1688 till the Reform Bill of 1831, all political power was in their hands. They were the patrons of agriculture, and their tenants, being accustomed to continue undisturbed, neither asked nor expected legal security of tenure. But habit and custom gave such security in reality, though not in law; and to this day there are families of tenants-at-will who can count back a longer period of unbroken succession in their farms than the great landowner at whose will they hold them. Origin of  
tenancy-at-  
will in England

The first Reform Bill gave tenant-farmers, paying a rent of 50*l.* and upwards, the right to vote in the election of members of Parliament, and thus strengthened their hold on the consideration of their landlord, but at the same time gave him an unfortunate interest in the continuance of a system which kept them dependent on his will. This continued for one generation more, until in 1867 the franchise was lowered to 12*l.*, and in 1871 vote by ballot introduced. By those measures the numbers and political strength of the tenant-farmer class were largely increased. Household suffrage in counties is believed to be not far off, and thus the hitherto paramount political influence of the landowner in the counties is gradually being replaced by the wider basis of the representation of each of their varied interests. The first result of the latest extension of the constituency, and their protection by ballot, has been a strong agitation on the part of the farmers to obtain a legal right to be compensated, on removal, for their unexhausted manures and improvements. Simultaneously with it, a labourers' league has been formed in some districts to concentrate the latent power of the dispersed but numerous body of agricultural labourers. Both of these movements have been attended with a moderate measure of success. The Agricultural Holdings Act, passed two years ago, recognises for the first

time a legal right in the English farmer to compensation for unexhausted improvements, cumbered indeed with conditions which have made it unsatisfactory to both parties. A considerable step has however been gained, as all parties are brought to look carefully into their position, and thus the mutual connection, while losing something of sentiment, will in time gain more of business and enterprise.

Landowner's  
necessities  
prompted  
leases in  
Scotland.

In Scotland the necessities of the landowners prompted them, at a much earlier period, to seek relief from the embarrassments of entail by obtaining legislative power to borrow money for the improvement of their settled property. And, when the means were thus provided for executing permanent works, the energies of the tenant-farmers were wisely enlisted in carrying these into remunerative effect by the now well-recognised form of a lease of nineteen years, at a fixed rent, to assure the tenants such a period of possession as should at once evoke their best exertions. This system has now been in practice for three generations, and its results are seen in a higher state of general cultivation than that of the sister countries; greater competition for farms and a higher scale of rent; more independence; and at least as keen an intelligence shown in adopting improvements. For a long period the Scotch landowners have been compelled to look into the management of their property in a different manner from those of England. Upon them the liability was directly placed of finding the money for the public establishments of their counties, the churches, prisons, and police. They had the determination of questions of road-making; and having to contribute directly a large proportion of the county expenditure, they took an active interest in its administration. This brought them into closer business contact with the farmers; and recent legislation has tended to increase this connection by the principle of imposing all county rates in certain proportion directly on landowners and farmers, and giving to both a representation at the same county or parish board. There is thus a better fusion of the two interests than in England, and a readier appreciation on the part of the landowner of the outlays requisite on his part to enable his tenant to make the most of the land he farms. The time seems rapidly approaching when the Scotch system of equal valuation and rating, imposed directly upon both landowner and farmer, will be imitated in England, and lead to the principle of local administration in each county by representatives of every interest at a county board.

Non-residence  
of landowners  
produced  
system of  
middle-men in

In Ireland the relation between landlord and tenant is altogether different from that of England and Scotland. Previous to the famine of 1846, the great landowners were non-resident, and the land was still in a great measure in the hands of middle-

men on leases for lives, with leave to subdivide and sublet for the same time. These men had no permanent interest in the property; their business was to make an income out of it at the least cost, and their intermediate position severed the otherwise natural connection between landlord and tenant. The famine of 1846 prostrated the class of middle-men entirely, and brought the landowner and the real tenants face to face. But the hold which the latter had been permitted to obtain, led them to consider the landowner very much as only the holder of the first charge on the land; and they were in the habit of selling and buying their farms among themselves subject to this charge, a course which, as a matter of practice, was tacitly accepted by the landowner. He had security for his rent in the money paid by an incoming tenant, who, for his safety, required the landowner's consent to the change of tenancy, and the landowner's agent then received the "price" of the farm (for that was the term used), and handed it over to the outgoing tenant, after deducting all arrears of rent. This suited the convenience of landowners the most of whom had no money to spend on improvements, many of them non-resident and taking little interest in the country, and dealing with a numerous body of small tenants with whom they seldom came into personal contact. In the north of Ireland this custom of sale became legally recognised as tenant right. The want of it in other parts of Ireland produced an agitation which ultimately led to the Irish Land Act, under which legislative protection is given to customs capable of proof. The custom of "selling" the farm, subject to the approval of the landowner, by a tenant on yearly tenure, is rapidly gaining ground in Ireland; and so firmly are the people imbued with this idea of their rights, that the clauses of the Irish Land Act, which enable the tenant, by the aid of a loan of Government money, on very easy terms, to purchase the proper ownership of his farm, are rarely acted upon, from the belief that the farm is already his, under the burden of a moderate rent-charge to his nominal landlord. Circumstances have thus brought about a situation in which the landowner cannot deal with the same freedom with his property as in England or Scotland, either in the selection of his tenants or in the fair readjustment of rent, and this has, in a great measure, arisen naturally from the neglect of his proper duties as a landlord in not himself executing those indispensable permanent improvements, which the tenant was thus obliged to undertake, and who in this way established for himself a claim to a co-partnership in the soil itself.

---

Ireland, and its  
consequent  
evils.

## CHAPTER VI.

## LAND IMPROVEMENT.

Settlements and incumbrances hinder the free action of many landowners in the management of their property.

HAVING now endeavoured to explain the respective positions of the three interests engaged in the cultivation of the soil in each of the three countries forming the United Kingdom, I will proceed to consider the circumstances which embarrass the free action of a large proportion of the landowners, and the modes by which these are more or less overcome. A very large proportion of the land is held by tenants for life under strict settlement, a condition which prevents the power of sale, and it is also frequently burdened with payments to other members of the family, and in many cases with debt. The nominal income is thus often very much reduced, and the apparent owner of five thousand a year may have little more than half of it to spend. In such cases there is no capital available for the improvements which a landowner is called upon to make, in order to keep his property abreast of the advance in agricultural practice. This was pressingly felt at the time of the repeal of the Corn Laws, and the withdrawal of protective duties from native produce. Parliament, therefore, when it enacted a free import of the necessaries of life, provided State loans on favourable terms to the landowners for the drainage and reclamation of their estates.

Expedients adopted to overcome this.

The potato disease of 1846 and 1847 was a serious calamity at the time, but it was the occasion from which arose the great stride made in agricultural enterprise in this country during the last thirty years. It led at once to the removal of all protective duties on foreign agricultural produce, and obtained for the people of this country access to supplies from foreign lands, where wages were lower and good land more abundant. Landowners and farmers bestirred themselves to meet the inevitable competition to which they became exposed; and their efforts were promptly aided by the State with reproductive loans to tide them over the early years of trial. As the sums voted by Parliament for these loans became exhausted, Land Improvement Companies were formed to carry on the good work on the principles which had already proved successful, though the Companies necessarily charged somewhat higher terms than those which the credit of the State had enabled it to afford without loss.

State loans for drainage and reclamation of land, and in Ireland for buildings also, issued on favourable terms:

The State loans were limited, in Great Britain, to drainage and reclamation, the landowners being left to their own resources for buildings, roads, and fences. In Ireland these were and still are included, that country having always been favoured in matters of State assistance. The rate of payment was by annual instalments of  $6\frac{1}{2}$  per cent., which in twenty-two years redeemed the principal, and at the same time

paid the annual interest at  $3\frac{1}{2}$  per cent. In many cases the tenant undertook the whole of this annual payment in addition to his rent, and the landowner thus had his land permanently improved, and returned to him free of all charge, at the end of twenty-two years. Not unfrequently the landowner was satisfied with 5 per cent. from his tenant, and paid  $1\frac{1}{2}$  out of his own pocket for this permanent advantage. Especially was this the case in regard to buildings, the return from which is not so direct or immediate as from drainage or reclamation.

The same principle is followed by the Land Improvement Companies, whose loans, like those of the State, are secured by priority over all other charges, but continue for twenty-five or thirty years, in inverse proportion to the rate annually paid. It has been proposed to extend the term still farther, in order to reduce the rate of annual repayment; but this is a questionable advantage, for each generation has improvements of its own to carry out, and it is a good general rule that the cost of the past should be paid off before new charges are placed on the land.

The total amount of money charged on the land of the United Kingdom for agricultural improvements under the system of periodical redemption, in the last thirty years, amounts to about fifteen millions sterling—twelve in Great Britain and three in Ireland. About eight millions of it was advanced by the State, and seven millions by private companies. A large proportion of the first has now been repaid, having been returned to the public exchequer, principal and interest, and is no longer a charge upon the land. Two-thirds of the whole have been spent on drainage, the remainder on farm-buildings, labourers' cottages, embanking, water-courses, farm roads, reclamation, planting for shelter, and enclosing. The expenditure through such loans goes on with great regularity at an average of half a million sterling a year, and the loans are being redeemed and the charge extinguished at about the same rate. The extent of work still to be done far exceeds what has been accomplished, and so many new demands arise to meet the changes in husbandry that the system is likely to be a permanent one. It may therefore be useful to consider its present mode of working, the objections which have been made to it, and whether any improvement can be introduced which might facilitate its operation.

An inquiry into this subject was undertaken by the House of Lords in 1873. The Committee comprised men of acknowledged eminence on both sides of politics, great landowners conversant with such subjects, and having more or less practical knowledge of agricultural affairs. Twenty-three witnesses were examined from various parts of the kingdom, all of whom had

followed by  
loans from  
Companies.

Total amount  
so expended.

Inquiry by  
Parliament  
into the mode  
of working  
these loans,  
and their  
results.

experience of the system. Various instances were adduced to show the unremunerative nature of certain improvements, the explanation of which was either injudicious and imperfect execution of the works, or inadequacy of capital, or energy, or knowledge, to follow them up by good culture,—want of knowledge and experience on the part of the landowner or his agent, or the usual circumstances of a similar nature which are found here and there to occur in all large operations, which must often be unwittingly entrusted to weak or dishonest management. As this inquiry embraced the execution of works in all parts of Great Britain, spread over a period of twenty-six years, and embracing an expenditure then exceeding ten millions sterling, the comparatively few and exceptional instances of failure might be taken as a strong proof of the general success of the system. Except in such buildings as required restoration from the continued neglect of landowners to repair—a case very common both north and south—some return seems always to be reckoned upon, even for expenditure on new buildings. On all other kinds of improvement there was a general testimony to their remunerative character. And those of the witnesses most competent to speak, the tenant-farmers who had themselves repaid the cost of the works, declared that they had received from the money spent on land-improvement much more than a return of capital and interest.

General testimony to their remunerative character.

Object of continuing Government control after issue of public money ceased.

The Committee very truly remark that it is an anomaly that private transactions should be submitted to the control of a Government office. This was perfectly legitimate, so long as the money advanced was a public loan. When the supply of public money ceased, and that of private persons or companies was substituted, the existing Government machinery of inspection and control, which had been found on the whole to work well, was continued by Parliament on the ground that the improvement of the land of this country was a matter of public interest. But this was not with the view of protecting the interests of the remainder-man and mortgagee, for that is no part of the duty of Government; but in order to give a first charge on the inheritance, and so enable landowners, whether under settlement or otherwise, to obtain money for improving their estates, which is an object of public importance, at a lower rate of interest than would otherwise have been possible. This preferential charge could be given only with the tacit assent of other parties already creditors of the estate; and the condition which hitherto has assured that assent, has been the certificate, under statutory powers, of an acknowledged Government authority, that their security had not been thereby injuriously affected. The continuance of the Government inspec-



tion has thus been wholly in the interest of the landowner, especially if he is under settlement or entail, where the tenant for life is otherwise unable to raise money for the improvement of his property.

Besides the public and private loans spent on land improvement, a much larger sum has been laid out on the same object by landowners from their own resources.

It may be useful to consider in their order the several objects of land-improvement, and the return they are capable of yielding under suitable economical management.

Land drainage one of the most certainly remunerative improvements.

The first improvement, in all cases where it is required, is drainage, for until the land is freed from stagnant water and thus rendered capable of yielding its fullest assistance to the further efforts of the agriculturist, all other outlay is vain. There is never any difficulty in deciding upon the expediency of drainage in these islands, because wherever it is required and is judiciously executed it at once becomes remunerative. The under drainage of arable and good grass-land, in a climate where drainage is advantageous, renders the land so much warmer and more wholesome for plants and animals, everything upon it becomes so much more thrifty, and all operations so much more easy and certain in their results, that it is sure to pay. No doubt the increasing cost of labour and materials is seriously felt, but the value of land and of most kinds of agricultural produce is likewise increasing.

With regard to outlay on farm buildings, there is not the same certainty of return. Farm buildings are of two kinds, those for the accommodation of live-stock and the manipulation of the crop, and those for the housing of the farmer and farm labourers. In regard to the first, it is only necessary to refer to the increasing prices of live-stock to show the advantage of making adequate and comfortable provision for their food and shelter. But the time has gone by for great corn barns. The corn is now much more economically treated by stacking it in the field where it grows, and threshing it out by locomotive engine-power when required. The partial conversion of these large barns into feeding-sheds, or in the grazing counties into haysheds, is the best mode of turning them to account; and where farm buildings have been kept by the proprietor in good repair, their conversion to objects of modern husbandry need not be very costly. It is only where they have been completely neglected, and require entire renewal, that the expense is greater than can be met by the immediate return. Even then it is capable of proof that the economy of labour and of food, the better quality of the manure, and the greater thrift

Greater caution required in expenditure on farm buildings.

of the stock, will, as a rule, be ample compensation for the charge. Additions to existing buildings for a specific object, planned and executed with judgment, will always be remunerative. But the more common fault of putting up very costly buildings, planned with little reference to the value and extent of the farm, or little practical knowledge on the part of land-agent or architect, too surely ends in disappointment to both landowner and farmer.

Labourers' dwellings, when judiciously placed, as remunerative as any other outlay of landowners' capital.

Labourers' cottages are reckoned the least remunerative of all. New cottages, even though built in blocks of two or four together, cannot at present be built by contract for less than 150*l.* each, if planned with due regard to comfort and decency, and at a greater cost if the expense of haulage of materials is included. To repay this in twenty-five years, both principal and interest, a weekly rent of 4*s.* is required. But labourers in the southern counties have been unable to pay more than 1*s.* or 2*s.* out of their weekly wages, so that the landowner who lets good cottages at that rent is really paying also 2*s.* or 3*s.* a week towards the wages of his farmers' labourers. By this, all the parties are misled. The landowner's duty to his estate is to provide it with all permanent buildings required for its proper cultivation. He must do so if he cultivates the land himself, and he ought equally to do so if he lets it to be cultivated by another. The farmer, whether landowner or tenant, must then furnish the farm with the "plant," the live and dead stock necessary for its cultivation. Both parties are entitled to look for a return for their investment; the landowner's safe and improving capital yielding him a smaller annual return than the farmer's, which is liable to the vicissitudes of seasons, and wear and tear, and must also cover his personal industry and skill. The labourers' dwellings are as indispensable as the stables and barns, and no arable farm can be said to be complete which has not the command of an adequate number of cottages for the workpeople. These, with the farm and all other necessary buildings, should be let to the farmer at a rent which should include a fair return on the landlord's capital, and the farmer and the labourer should be left to deal with each other on the basis of adequate remuneration for useful service, regulated by the ultimate rule of demand and supply. On this footing the return on labourers' cottages will become as remunerative as that of any other outlay of landowners' capital, because it will be controlled by the real necessity and requirements of the farm.

Better cottages wanted rather than more of them.

This will apply chiefly in cases where new cottages are attached to farms, and fresh outlay for that object is to be made. But, in the vast majority of cases, labourers' cottages already exist in sufficient numbers. Better cottages are required in many

parts of the country, rather than more of them. It has been well ascertained that during the last thirty years the agricultural population has diminished. The circumstances which have led to that continue in full strength. Increased facilities of locomotion between different parts of the country, and for emigration across the seas, tend more and more to carry off the energetic portion of the agricultural population. This has raised the rate of farm wages and the cost of cultivating arable land. The prosperity of the wage-earning class in other occupations has, at the same time, vastly increased the demand for butcher's meat and dairy produce, and so greatly increased the returns from grass land. The natural result is a gradual conversion of suitable arable land to grass, and this diminution of extent is accompanied also by the introduction of labour-saving machines. There is thus in both ways a tendency to a diminution of our agricultural population, the one operating in carrying off the ablest to more remunerative fields of industry, the other in lessening the home demand for agricultural labour. It is a fact of great importance in the consideration of this question that, within the period between the census of 1861 and 1871, there has been a decrease of the country population in every county of England except five, and it is only in the suburban counties and in the manufacturing and mining districts that an increase has taken place. Future provision for agricultural labourers' dwellings ought therefore to be in the direction of improvement rather than increase.

Abundant proof might easily be adduced from most parts of the country that on the main heads of agricultural improvement there should be no lack of good return. The fact that the outlay goes on without diminution, notwithstanding the great increase in the cost of labour and materials, would alone upset all reasoning, and isolated instances, to the contrary. A very instructive paper on this part of the subject was produced by the managing director of the Lands Improvement Company. It showed a return of forty cases of outlays, not picked cases, but taken as they happened to come, with the increased rentals subsequent to the improvements. Upon an outlay in the aggregate of 195,000*l.* there was an increased rental of 31,000*l.* This increase had been obtained within seven to ten years. In only five instances did the increase fall short of repaying the annual charge which redeems the principal as well as the interest. In every other case it left a profit beyond this, in many cases a large profit. On the whole, the increase is equal to a return of 15 per cent. on the expenditure, and if this is capitalised at the common estimate of thirty years' purchase of land rent, the sum expended will be found to have been in-

Examples of  
remunerative  
expenditure.

creased more than fourfold. If landowners generally could reckon on anything like the average return of these forty cases, they would have the means, under the Lands Improvement Acts, of improving their estates, not only without present loss, but with a large immediate profit. But no distinction was made or could be made in this return between that increment which arose from improvements and the general increase of rent due to the prosperity of the country, the increased value of produce, and the development of particular districts by the opening of railways and roads. Still in one way or other the landowner in these cases has been made entirely safe.

And in the nature of things in this country such must be the case wherever reasonable judgment has been shown in expenditure on land improvement. The improver is dealing with a limited article, for the produce of which there is an ever-increasing demand. Nature has given us a climate more favourable to the production of meat and milk, vegetables and grass, than that of any other European State. These, in proportion to their value, are the least costly in labour, and therefore the least affected by a rise of wages. The growing demand for them, and their consequently increasing value, exercise a constant pressure for increased production, which can still to some extent be obtained by improving the land we have. A large proportion of the improvable land under cultivation admits of this, and much of that vast tract which has hitherto been left to nature might also be profitably reclaimed for the rearing of sheep and cattle.

---

## CHAPTER VII.

### RECENT RISE IN THE VALUE OF LAND.

THERE has been, within the last twenty years, a very considerable increase in the value of land in this country. The income-tax returns are most instructive on this point, and, as they show the rental of land in England, Scotland, and Ireland separately, they afford the means of comparing the rate of improvement in each country. That improvement does not seem to have begun in England till 1858, the gross annual value of "Lands" in 1857 having been returned at 50,000*l.* less in that year than in 1846. From 1858 the rise has been progressive and continuous, and with an average increase of 470,000*l.* a year. The rise seems to have begun somewhat earlier in Scotland, and the average yearly increase has been 82,000*l.* The returns from Ireland cannot be distinguished prior to 1862, and show an average

Great rise in the value of land since the repeal of the Corn Laws, only partly due to the outlay of capital in improvements.

yearly increase from that year of 39,000*l.* The total rise within a period of eighteen years has been a little over 20 per cent; but, as will be seen by the annexed Table, the proportion of increase on the Scotch rental has been greater than on that of England. The small rise in Ireland presents a striking contrast to England and Scotland.—The capital value of the total increase at the present selling price of land in this country will be reckoned something prodigious, especially by those of us who are old enough to recall the dismal prophecies of the agricultural ruin which would surely follow the free admission of foreign corn.

GROSS ANNUAL VALUE OF LAND ASSESSED to the INCOME-TAX in 1857 and 1875.

	1857.	1875.	Increase.	Increase per Cent.	Capital Value of Increase at 30 Years' Purchase.
	£	£	£		£
England ..	41,177,000	50,125,000	8,948,000	21	268,440,000
Scotland ..	5,932,000	7,493,000	1,561,000	26	46,830,000
Ireland, from } 1862.. .. }	8,747,000	9,293,000	546,000	6	16,380,000
	55,856,000	66,911,000	11,055,000	..	331,650,000

This vast increase in the value of landed property within the short period of twenty years is very remarkable. It has been already shown that the improvement expenditure effected by loans has been fifteen millions. If we assume that even three times as much has been effected during the same period by private capital without loans, we here see that the capital wealth of the owners of landed property has been increased by three hundred and thirty-one millions sterling in these twenty years, at a cost to them which probably has not exceeded sixty millions. This increase, as elsewhere explained, has arisen chiefly from the great advance in the consumption and value of meat and dairy produce, and is thus only in part the result of land improvement.

But though in the aggregate the landowners of England have become richer by more than one-fifth, and those of Scotland by more than one-fourth, the progress has not been uniform. In the purely corn districts, and on the chalk and sands of the drier counties where grass does not thrive, the increase has been small. On the poor clays there has been none. It has been greatest in the grazing counties and in the west and north. The increase shown in Scotland deserves special attention. In that country the larger proportion of grazing land no doubt partly explains

Greatest rise has been in the grazing counties, and in Scotland: the cause of this.

this, but, on the other hand, entails are more strict, and land is understood to be more heavily mortgaged than in England, so that in these respects Scotland has no advantage. It was this greater disability of the entailed Scotch proprietor which drove him earlier to seek a remedy. A little more than a century ago, in 1770, the first Improvement of Land Act was passed, the famous Montgomery Act, the preamble of which clearly explains its origin. "Whereas much mischief arises to the public, which must daily increase so long as the law allowing such entails subsists, if some remedy be not provided," and then it provided a remedy very similar in principle to the drainage Acts passed for both countries eighty years later. But the power of raising money would not alone have sufficed. It was necessary also to take care that that money should be wisely expended, and the astute heads who devised the Montgomery Act enlisted the aid of the tenant-farmers, by giving them the security of nineteen years' leases, and thus obtaining their co-operation in the execution of the works, and in the subsequent operations necessary to make them remunerative. This co-operation between landlord and tenant in Scotland had been in full action for more than two generations before the Drainage Loans introduced by Sir Robert Peel in 1848, when both landlord and tenant in Scotland at once eagerly availed themselves of the very liberal terms on which these were offered; and that goes on to this day. The facilities given by the Improvement of Land Act, 1864, which enables limited landowners to operate with their own means without the intervention of the Improvement Companies, were at once recognised in Scotland, which has availed itself of them to an extent six times greater, in proportion, than England. In Scotland, as was stated by one of the witnesses, "the tenants are practically the applicants for improvement loans." They readily meet their landlords much more than halfway in contributing to the repayment; and instead of lagging behind, or waiting to be spurred on to further enterprise, they compete even too much with each other for the possession of farms on terms which have now become more remunerative to the landowners than to themselves. There is not in England, generally, a similar spirit of agricultural enterprise.

To what is this difference between the two countries to be attributed? Chiefly to three causes, in which the Scotch landowner has the advantage: earlier education in, and appreciation of, the benefits of land improvement; a better knowledge of the business of land owning; and the general system of leases. To the first, reference has already been made. The better knowledge of their business has naturally flowed from it to the Scotch landowners. They are trained to it by fathers who have been

The Scotch landowner better trained to his business.



in their day likewise taught to look into the management of their property. Sir Walter Scott mentions the discussions with which his youth was familiar when visiting his country relations, the comparative merits of "long" and "short" sheep, the reclamation of waste, and the advantage in a bare country of sheltering woods. "Aye be sticking in a tree," was the dying advice of an old Scotch laird to his son, "it will be growing when you're sleeping." The "home" farm was always found in the personal occupation of the Scotch landowner, and the Edinburgh University has for many years had a Chair of Agriculture. It is true that among the greater landowners of Scotland the English schools and universities have long had a special attraction, but even their tone has failed to eradicate from the young Scotchman's mind the inborn love of the farms and fields, and the country employments of his fathers.

This knowledge of business is a matter of great moment to those who employ so vast a capital as the English landowners, a capital far beyond the entire value of our railways, mines, ironworks, canals, and gasworks put together. Men of the highest capacity, with special training and qualifications, are employed in the management of these. Constant watchfulness of the progress of invention, by which large results may be obtained on a given expenditure, is absolutely necessary to procure a profit in the general competition. The landowners of large estates entrust the management of their property to agents, more or less qualified, many very capable, but often hampered by the pressing need of their employer for the largest return of rental at the least cost. The landowner himself too seldom takes such an active and intelligent interest in the details of management as would convince him of the need to keep his farms in a similar state of high working order. It is not with him really a question of business. Let us take, by way of comparison, a manufacturer, merchant, or shipowner, employing each a capital equal to that of a landowner who has a rental of 5000*l.* a year. What would be thought of the prospects of a woollen manufacturer who, without the slightest preparation or special knowledge, embarked 100,000*l.* in that business? Or of a man who took over a mercantile concern of the same extent, without having ever before written or read a business letter? Or of a young military officer giving up his commission to take the direction and responsibility of a great ship-owning house? And yet this is in effect what is done every day by the majority of English landowners. They complain that the business so undertaken "is not sufficiently lucrative to offer much attraction to capital." And people are surprised that within the narrow limits of the British Isles, with a teeming, wealthy, meat-consuming

Landowning  
the only business in which  
special training  
is not deemed  
necessary.

people, so large a proportion of the cultivated land is still permitted to remain only partially productive.

Security for tenant's capital, whether by leases or otherwise, should be given.

The third point of difference between the two countries is the system of yearly tenancy in England, while leases of nineteen and twenty-one years may be said to be the rule in Scotland and the exception in England. It is in the nature of a yearly tenancy that there should be insecurity. Agricultural investments demand time to be fully remunerative. How can a man subject at any time to a year's notice to quit be expected to improve? That he does so in very many cases is due to the confidence of a long-standing connection between landlord and tenant. There does not live a more upright honourable man in any class than the average English landowner. But, with every acknowledgment of his desire to be just and fair in his dealings with his tenantry, it is vain to look for enterprise and progress where there is no real security. Whether that may be best attained under the Agricultural Holdings Act, or by special agreement without a lease, or by giving such security with two years' notice in addition to a lease, in one way or other security must be given to induce such an adequate flow of capital into the business of farming as will render it effective.

Owners in fee simple, as well as tenants for life, very frequently use the powers given by the Land Improvement Acts. The principle of annual repayment of the loan, by which the estate is at once put under improvement and the debt redeemed, commends itself to every man who desires to retain and improve his property. He borrows, at a fixed rate of interest, on a security the augmenting value of which is all his own. Besides this, there are few landowners who have not either inherited, or found it necessary themselves to create, mortgages on their estates. This is common to all countries, and no change in the laws affecting land is likely to alter it. The limited owner and the full owner are alike subject to it. If further expenditure is required, the money in the ordinary way must be raised on less advantageous terms than the previous loans. It probably cannot be raised on any terms by the limited owner. But the admirable principle of Sir Robert Peel's Drainage Loans, the essence of which is that no charge shall be sanctioned which does not promise a return greater than the annual cost of a gradual repayment of the debt, may, without injustice to the previous creditor, permit them to be made a prior charge upon the land, and will thus secure the most advantageous terms to the borrower, whether he holds under settlements or in fee simple.

Admirable principle of Drainage Loans.

Extended powers of sale in the case of

But there are many cases of land improvement which can be only partially reached by these Acts, and which require to be dealt with in a different manner. In the home counties, for

instance, and in the neighbourhood of some of our great centres of population, there are large tracts of comparatively infertile land, let at low rents as farms, and yielding little satisfactory return to anybody connected with them. Cases may be met with where the limited owner, who has inherited such a property from a succession of men in a similar position of legal incapacity, finds himself, in the midst of general progress, constrained to keep perhaps half-a-dozen parishes in a state almost of stagnation. The country itself is most likely well-timbered and very picturesque, with easy railway access to the metropolis or town, and highly suitable for residential occupation. He could sell it readily, if he had the power, in small properties for that purpose, retaining still an important family estate. It would not be difficult to point out cases in which this might be done with immense advantage to the landowner, the neighbourhood, and the public. Take, for example, a limited owner of 10,000 acres of such land, yielding a gross rent of 10,000*l.* If he were enabled to sell 2000 acres, which might fetch a residential price of 100*l.* an acre, or 200,000*l.*, retaining his family seat and 8000 acres: his rental would then be 8000*l.*, plus the interest at 4 per cent. of 200,000*l.* = 8000*l.* These sums together would make an income of 16,000*l.*, or 60 per cent. more than he had before. He would thus at once find himself in funds and in spirits to go on with the improvement of the remainder of his estate, while the neighbourhood would have the advantage of a circulation of fresh capital and ideas, to brighten a scene formerly rendered gloomy by dissatisfied indifference. Landowners who are precluded by entail or settlement from using this natural advantage of their position, are deprived of an incalculable benefit to themselves and their families.

settled estates  
would be very  
advantageous.

To a certain extent this has already been discovered, and there are probably no settlements of land now made without considerable powers of sale. The principle is recognised, and may with great benefit be extended and made general. Settlements of land to a limited extent, like settlements of any other kind of property, are likely to continue. I desire to avoid any discussion at present of their advantage, or otherwise, as a question of polity, but am anxious to see them, at least, limited to lives in being, with large powers of sale, so as not to hamper in the smallest degree the most beneficial disposition of the land. This, with an improved system of land transfer, long promised and anxiously hoped for by men of all parties, will render the country less dependent on palliative measures, such as the Land Improvement Acts. But these have proved, and continue to be found, of indispensable service, as, without them, the improvement of land would still be impossible over a large portion of this kingdom.

Settlements  
should be  
limited to  
lives in being.

The large capital of tenant-farmers entitled to legal security.

But even increased freedom for the energies of the landowner will fail if not adequately backed by an intelligent and enterprising tenantry. The rapid changes which have taken place in late years, both in the improvement of live-stock and in the better cultivation of the land, are in the main due to them. The vast business which has grown up in the importation and manufacture of manures and feeding-stuffs, shows their willingness to enter upon new lines of expenditure which promise useful results. They have a large capital at stake, and they justly desire freedom of action in regard to cultivation, and security for that portion of their capital which, being necessarily incorporated with the soil to produce a future return, may be confiscated wherever it remains unprotected by contract or by law.

---

## CHAPTER VIII.

### THE GOVERNMENT IN ITS CONNECTION WITH AGRICULTURE.

No Minister of Agriculture, and no Government control exercised, or State schools, or State flocks or herds maintained by Government.

THERE is no Minister of Agriculture in Great Britain, and no attempt is made by Government to interfere with the cultivation of the soil, or between the landowners, the tenants, and the labourers. There are no State flocks, or herds, or horse-breeding establishments, nor any State schools of agriculture. In Ireland such schools, and several experimental farms, were established at the cost of the Government, at the time of the potato famine. In the disorganised state in which that country then was, some benefit ensued. But the general principle of our political system is that every trade and business should be self-supporting, subordinate only to the general laws, and controlled by the rule of free competition. The political influence possessed by the landed interests insures for them adequate representation in the Government, and their great wealth endows them with the means of promoting all objects of general interest to them as a class. The Royal Agricultural Societies in England and Ireland, and the Highland and Agricultural Society of Scotland, are the self-supporting national institutions of each Kingdom for the promotion of Agriculture. And, besides great provincial societies in various parts of the country, there are in every county one or more local Agricultural Societies for the same object. These are all self-supporting, having neither stipend from the State nor being subject to its control. The good result of this principle is seen in the successful manner in which they have evoked friendly competition amongst all classes connected with the land, and disseminated in every part of the

country a knowledge of the best breeds of live-stock, and of the most improved instruments and processes of agricultural development.

The only department of the State which has a direct connection with the land is the Inclosure Office, which combines several objects, more or less appertaining to landed property, but with no power to interfere except when applied to for the means of facilitating improvements. The costs of all proceedings effected through this department are provided by those who make use of it. Its original object was to promote the inclosure of waste lands, and thereby to increase the home produce of food, and afford increased employment to the agricultural labourers. These objects, so far as they were necessary, have to a great extent been otherwise accomplished, and the agricultural labourer has become happily independent of such aid. The duty of this branch of the office now is not to promote inclosure with the object of dividing the land amongst severalty owners, except in cases where by no other means could its improvement be effected, but to encourage the improvement of "commons" under a system of regulation, by which the land may be drained, planted for ornament and shelter, and the surface be improved for pasturage, without excluding the public from its enjoyment by subdivision into severalty ownership. Advantage of the office has from time to time been taken by Parliament for objects of an analogous character. The Drainage and Land Improvement Acts are administered by this Commission, the object of these Acts being, as already explained, to permit landowners to borrow money for permanent improvements, and to charge their lands with the cost of these on the principle of such annual payments as within a definite period will reimburse both principal and interest. The control exercised by the Government department insures that the proposed improvement shall be both beneficial and well executed, and that the future possessor of the property may not find himself on his succession called on to pay for unprofitable outlays made by his predecessor. But any Government control in such circumstances is really the fruit of the artificial system of entail and settlement.

The office is also entrusted with the formation of commissions for the drainage of districts liable to floods, under which works embracing large areas of country are carried out under a general system, the cost being levied on the landowners in proportion to the advantage they receive. In the execution of this duty it has been found that the applicants in many cases have erred in not including the whole of the area which should naturally fall under one control, and so failing to secure uniformity over the whole of the catchment basin affected.

The Inclosure Commission the only State department directly connected with the land.

Its various functions.

Formation of Main Drainage Commissions.



Floods beneficial, except where permitted to remain too long stagnant.

Floods in river valleys in autumn, and winter, and spring, provide rich irrigation for the land, the mud in which subsides when the waters are for a time partially stagnant. They are very beneficial if not permitted to remain too long. Land subject to such floods should never be broken up from grass, as in no other way can it in this country be more profitably used. Before under-drainage became so general, the floods came down much more loaded with sediment, and therefore much more enriching than now, when the rains of the uplands pass through and are filtered by the soil. Summer floods are injurious but they are rare, and if once in twenty years they injure or even carry off the hay, there is some compensation in the heavy crops of aftermath that follow. If the natural beds of the rivers were kept free from obstruction there would be far more benefit than injury from floods.

But in earlier times, before steam-power was known, water-power was found a valuable aid for both mills and navigation. Weirs and dams were then constructed, and water rights have grown up which greatly hamper arterial drainage. Towns on the river banks, though generally built above flood-mark, are injured by long-continued floods; and their interests, as well as those of the land, are concerned in removing all artificial obstructions. There is no longer any necessity for these, as steam-power can everywhere be substituted for water-mills, and the tedious delays of barges be superseded by the quicker and more certain conveyance by railways. The barge navigation was attended by one benefit, as, in order to maintain adequate depth of water, it was necessary to keep the bed of the river free from the natural growth of weeds which otherwise impede the current, and cause deposits of mud which gradually contract the outfall. Questions of compensation, however, arise when rights of any kind are touched, and hence the need of some authority to control and reconcile opposing interests.

The Inclosure Commissioners have power, upon application being made to them, to recommend the formation of drainage districts, which may embrace either the whole or a part of a river basin. So far as their experience has gone, it is in favour of placing each river basin as a whole system under competent authority, with power to that authority to form sub-districts for the management of each, with representatives at the general board which controls the whole. As the object is not to prevent floods, but to limit the period of their stagnation, it is seldom that any grand engineering operation is required.

Great engineering works seldom required.

Power to exchange intermixed

Another most useful branch of the office is the very extensive power entrusted to the Commissioners to carry out exchanges



and partitions of lands. By their aid any two landowners can, at very trifling expense, correct any irregularity in the boundary of their respective estates, or even exchange entire farms or estates. This may be done without any risk or investigation of title, by the simple process of attaching to the lands exchanged all the accidents of title, tenure, and incumbrance, which formerly belonged to each other. The only questions requiring the decision of the Commissioners are: Is the exchange beneficial to the two estates? Are the parcels proposed to be exchanged equal in value? or within one-eighth of an equality in value? When satisfied of this, the Commission authorises the exchange, and the one parcel immediately, for all purposes, takes the place of the other. So that if the title of either be thereafter found faulty, the person who may recover will have, not the land with the faulty title, but that which the Commissioners have put in its place, and clothed with all its liabilities. Certain notices must be given; the order of exchange is not confirmed until three months after the notice, and if during that period any person dissents who is entitled to any estate in, or charge upon, either of the lands proposed to be exchanged, the Commissioners withhold their confirmation while the dissent continues. From time to time the powers of the Commission have been extended to comprise all cases omitted from the original statute. All hereditaments, corporeal and incorporeal, may now be exchanged with ease and at a very moderate cost. Inequality in value to the extent of an eighth may be compensated by a rent-charge annexed to the less valuable, and charged upon the more valuable property.

lands, inexpensive, and simple in its operation.

The extent to which this beneficial and inexpensive power is used is very considerable. It is mostly in the rectification of boundaries, or the exchange of intermixed lands, and in many cases to facilitate building operations, and embraces annually from 6000 to 10,000 acres, having a value of from 400,000*l.* to 500,000*l.*

Extent to which it is made use of.

---

## CHAPTER IX.

### WASTE LANDS AND COPYHOLDS.

THE past result of the inclosure of waste lands under the control of the Government may be learned from a return to an Order of the House of Commons, made in 1873, which showed the extent of commons and common field lands then in England and Wales to be 2,632,000 acres, about one-fourteenth part of the whole surface of that country. Probably one million acres of the

Inclosure of waste lands:

its extent,

whole are capable of improvement by reclamation, drainage, or planting. Previous to the passing of the General Inclosure Act of 1845, 2500 inclosures had been sanctioned by private Acts of Parliament, under which 2,142,000 acres of waste land were inclosed. The inclosures since 1845 have added 600,000 acres, so that up to the present time 2,757,000 acres altogether have been thus redeemed from waste.

and results.

The results of the inclosures since 1845 present some interesting facts in regard to the subdivision of land, and the addition made to the number of small landowners in the country, and the public works of improvement carried out under the process of inclosure, which are worthy of record. This is altogether independent of the individual and public advantages arising from the reclamation and agricultural improvement of the land itself. The 600,000 acres dealt with since 1845 have been divided among 26,000 separate owners, in an average proportion of  $44\frac{1}{2}$  acres to each lord of the manor, 24 acres to each common-right owner, and 10 acres to each purchaser of the lands sold to defray part of the expenses. In many cases the expenses were raised by rate among the persons interested, but this was optional, since such persons had the alternative of selling a portion of the land for that purpose. With that object 35,450 acres were sold, chiefly in small lots, to 3500 purchasers. The lords of the manors, 620 in number, received as compensation for their rights in the soil, on an average, about one-fifteenths of the acreage of the wastes. These wastes of manors were, under the Act of 1845, made subject to the setting out of allotments for public purposes, and in this respect were distinct from the commonable lands, which are undivided private property, and were not made subject to public allotments.

Quality and occupation of persons to whom waste lands passed.

As this is the largest and most general distribution of land into small properties that has taken place in this country in recent times, it was desirable to know the quality and occupation of the persons into whose hands these lands have passed. To discover this, the legal description both of allottees and of purchasers of sale allotments, was taken from inclosures in which that description is given, one in each of the following counties, viz. Bucks, Cumberland, Chester, Devon, Essex, Hants, Herts, Lancaster, Norfolk, Oxford, Stafford, Sussex, Worcester, and, in Wales, Carnarvon and Carmarthen. Upon this basis, and so far as such an average can be accepted, the proportionate numbers of the different classes of the 26,000 landowners amongst whom the land has been divided are as follows:—Yeomen and farmers, 4836; shopkeepers and tradesmen, 3456; labourers and miners, 3168; esquires, 2624; widows, 2016; gentlemen, 1984; clergymen, 1280; artisans, 1067; spinsters, 800; charity trustees,

704; peers, baronets, and sons of peers, 576; professional men, 512; and about 3000 others in gradually diminishing proportions, but comprising nearly every quality and calling, from the Crown to the mechanic, quarryman, and domestic servant. The influence of this change has not been confined to particular counties, but has been more or less felt in all. It has made an appreciable addition to the number of small landholders in England, bringing upon hitherto comparatively unproductive wastes the individual interest and intelligence of a numerous and varied body of persons, by whose industry the best of these lands have been made not only useful to their owners, but have become available for sale and purchase, and, in their improved condition, for bearing their just share of county and parish rates and public taxes.

More than two thousand miles of public roads have been constructed in connection with these enclosures since 1845, at the cost of the common-right owners, in addition to the numerous accommodation roads set out for their special use in giving convenient access to their several allotments. Other works of a public nature, such as embanking and straightening the course of rivers connected with inclosures, have been executed. The value of lands devoted to public objects, at the cost of the owners of common rights, is equal to one-eighth of the whole value of the land inclosed.

The total estimated value of the wastes inclosed amounts to 6,140,000*l.* The value of the land taken from the best of this for public purposes (comprising land for recreation, field-gardens, public quarries, fuel, schools and churches, burial-grounds, public roads, and other purposes) has been estimated at 282,140*l.* To this must be added the cash, raised by rate, or sale of property, and expended on the construction of public roads and other public works connected with inclosures, 473,500*l.*, making together, 755,640*l.* Comparing this with the fee-simple value above mentioned, it appears that nearly one-eighth of the whole value of the wastes inclosed has, under the direction of the Commissioners, and with the assent of the proprietary interests, been devoted to objects of public utility and convenience. Thus, in the course of one generation, an extent of land equal to that of a county has been redeemed from a condition of waste, and has been divided among a far larger and more varied body of landowners than that of any county in England. Valuable public roads of great extent have been constructed, opening up for business and pleasure many otherwise inaccessible localities, and at no cost to the public. The area of production and employment has been increased, and in the same proportion that of public and local taxation has been extended. A great number

Extent of  
public roads  
constructed,

and value of  
lands devoted  
to public  
objects, at the  
cost of the  
owners of com-  
mon rights,  
equal to one-  
eighth of  
whole value  
of the land.  
inclosed.

of small landed properties have been created, and labourers' field-gardens in the rural districts have been afforded in larger proportion to the extent of the land than appears by the Agricultural Returns to exist elsewhere in England.

Though the best of the land was probably first dealt with, there can be little doubt that much of that which still remains uninclosed may be advantageously brought under the operation of the new law, which, in the altered state of the circumstances since 1845, provides more fully for the public interests of the neighbourhood, and especially of large populations; and at the same time may yet be found, in less populous quarters, the useful instrument of adding some considerable extent of available land to the solid resources of the country.

Enfranchisement of copyhold lands or buildings.

Lands or houses held by copyhold tenure may be enfranchised through the Copyhold department of this Commission. These are held by record in the book of the lord of a manor, anciently on certain terms of service, now commuted into a money payment. The tenants of a manor, which was held by the lord from the Crown under ancient grant, gradually acquired the right to be placed on the court roll of the lord on the same conditions as their predecessors, and became entitled to demand copies of these conditions, which, so long as they were fulfilled, gave them a title to their estates. The conditions of the tenure are governed by the customs of the manor as shown in the rolls of the Manor Courts, and by constant and immemorial usage; and the title is simply a copy of the court roll, authenticated by the steward of the manor. Two conditions are essential: first, that the lands are parcel of, and situated within, the manor; and secondly, that they have been demised, or are demisable by copy of court roll immemorially.

Number completed.

The ease with which a title can be given is the only advantage which this kind of tenure possesses, the uncertain nature of its services, reliefs, escheats, fines and heriots, and rights to timber, being a great obstacle to any kind of improvement. In 1841, the Legislature, with a view of removing these disadvantages, passed an Act for commuting manorial rights, and facilitating the enfranchisement of copyhold property. This was amended and extended by subsequent Acts of the Legislature. Since 1841 upwards of twelve thousand enfranchisements have been completed under the Copyhold Acts, and they are now proceeding, through the instrumentality of the Copyhold Commission, at an average rate of 600 a year. Besides these, a very large number have been effected throughout the different parts of the country, without the intervention of the office, owing to the stimulus to voluntary enfranchisement

given by the Copyhold Acts. But though the number seems large, it represents probably but a moderate proportion of the whole, as wherever there is a manor there are many copyhold properties; and much yet remains to be accomplished before this injurious and obstructive kind of tenure shall altogether cease to exist. The Copyhold Commission was formed with the intention gradually to abolish copyhold tenure, beginning by offering facilities for voluntary enfranchisement, after which it should proceed to its object of extinction on the compulsory principle. Accordingly, after ten years' trial of facilities under the voluntary system, compulsory powers were given to either lord or tenant to demand enfranchisement, with further facilities again in 1858, which led to a rapid increase in the number of enfranchisements. Under the present Acts either lord or tenant (except where the copyhold is held without a right of renewal) may now apply to the Copyhold Commissioners to compel enfranchisement upon terms to be fixed by two valuers, one appointed by each, or by their umpire. And in small cases, not exceeding 20% of annual value, the amount may be assessed by a single valuer, nominated by the Justices of the locality.

The complete extinction of copyhold tenure is still far from accomplishment. And so long as any considerable extent of the land of this country, embracing a vast number of the smaller estates and houses, remains subject to manorial fines, whether certain or arbitrary; joint rights in timber, under which the tenant cannot cut without leave of the lord, nor the lord enter the land to cut without leave of the tenant; vexatious demands for heriots, and a species of control worse than double ownership; a very great bar is presented to the profitable use of such property, an evil naturally most felt in the populous parts of the country. The Copyhold Commission has now been in operation for thirty-five years, so that full time has been given to prepare and provide for the final extinction of this kind of tenure, as originally contemplated by Parliament. The simplest mode of doing so would be by enacting that within some definite number of years, say thirty, all copyholds then existing should become freehold. Till the termination of that period the right of either party to compel enfranchisement should continue, and the obvious interest of the lords to make the most of their opportunity would quickly bring about this transformation.

The Tithe department of this Commission also administers questions connected with tithes for the support of religion.

Complete  
extinction  
desirable.

Mode of  
accomplishing  
this.

## CHAPTER X.

## CHURCH, CROWN, AND CHARITY ESTATES.

Tithes for support of religion in England:

In the early period of Christianity in this country, among other ecclesiastical laws introduced from the neighbouring continent, the Scriptural principle of reserving for the support of religion a tenth part of the produce of industry was enjoined. This included not only a tenth part of the produce of the crops and stock payable in gross, but also a tenth of the clear gains from manual occupations and trades. This large proportion of the total produce of those countries which had embraced Christianity was apportioned, more than a thousand years ago, into four divisions: one to maintain the edifice of the church, the second to support the poor, the third the bishops, and the fourth the parochial clergy. Originally all the land in the country was titheable except such as belonged to the Crown and the Church itself. At the time of the Reformation, much of the Church lands in this country passed into the hands of laymen, and continued exempt from tithe, and from various other causes a considerable proportion of the lands of the country has become exempted. As the country became more populous, and its demands upon the produce of the soil more difficult to meet, the payment of tithes in kind was found a great hindrance to improved agriculture, as men were naturally unwilling to expend capital for the purpose of increasing the produce, if another who ran no risk, and bore no part of the toil, had a right to share in that increase. Forty years ago it was determined that this should cease, and it was enacted that, instead of payment in kind, tithes should be commuted into a payment in money, calculated on the average receipts of the preceding seven years, the annual money value to vary according to the annual price of corn on a septennial average, but the quantity of corn then ascertained to remain for ever as the tithe of the parish.

commuted from payment in kind to a money payment.

A very important change of principle here took place. Up to that time, the income of the Church increased with the increased value yielded by the land, the original object that the Church should progress in material resources in equal proportion with the land being thus maintained. From 1836 that increment was stopped. Since that time the land rental of England has risen 50 per cent., and all that portion of the increase which previous to 1836 would have gone to the Church has gone to the landowners. A tenth of that would not, however, by any means adequately represent the loss to the Church and the gain to the landowners; for the tithe in kind was the tenth of the gross produce, which was equal to much more than a tenth



of the rent of arable land. In 1836 the money value of the tithe, as compared with the land rental, was as four millions sterling to thirty-three. In 1876 the tithe was still four millions, but the land rental had risen to fifty. If the old principle of participation had continued, the annual income of the Church would now have been two millions greater than it is. Neither party anticipated a result to such an extent when the Tithe Commutation Act was passed, for not for twenty years after that time had the rent of land in England recovered the heavy fall it experienced at the close of the war in 1815. It was not until the vast development of industry, under a policy of Free-trade, had so increased the general prosperity, that the value and rent of land began steadily to rise. It then became plain that under the operation of a law intended simply to encourage agricultural improvement, the community, represented by the Church, are gradually losing a part of their natural inheritance. The same change is in operation in the vicinity of the great cities and towns, where population and wealth increase and accumulate. An acre of land in such situations, which yielded in its natural state a rent to the landowner of 3*l.*, and to the tithe-owner of 10*s.*, when converted to building may produce a ground rent of 300*l.*, besides the reversion to the landowner at the end of a long lease of the whole of the property erected on it by his lessee. No doubt, since the Reformation, the Church has been limited by law to the agricultural increased produce, and was not entitled to demand a share of the building value. But it was not contemplated that the landowners should thus obtain the whole growing value of the land without leaving any part of it for the support of religion. The operation of this change has been chiefly in favour of the better class of lands, those which from their quality and position have risen most in value. On the poorest kinds of arable land—the cold clays, and the thinnest chalk—the increased cost of labour has, in some exceptional cases, brought about a lowering of rent, while the tithe can undergo no diminution. The landowner in such case has to bear the loss, just as in the other he gets the gain.

In a country like this, in which the inevitable tendency of increasing wealth leads to the gradual diminution of small estates, there would be some considerable loss to the ranks of small resident proprietors by any change which should lead to the absorption of Church property. In every parish of the kingdom there is a resident landowner, who, as the clergyman of the parish, receives in residence, glebe, and tithe, about a tenth part of its rental, which he spends within it, and in return for which he is the minister of rich and poor. The number may be about 12,000 in England alone, with an average annual value of 300*l.* As

Unexpected effect of this, in preventing a rise in the income of the Church, and increasing that of the landowners.

Parish clergy equivalent in number to more than one-fourth of the resident landowners, over 200*l.* a year.

their income is in no way affected by the question of rent, their position is one of perfect impartiality between landowners and their tenants, and they are the natural referees of the poorer inhabitants. In proportion to the whole number of landowners in England the removal of this numerous body would strike out more than a fourth of those receiving above 200*l.* a year, and probably much more than one-fourth of the resident landowners. This, irrespective of the question of religion, would be a change of great magnitude in its social effect, which deserves careful consideration.

#### CROWN ESTATES.

Besides the domain and Great Park attached to the Royal Castle of Windsor, 14,000 acres in extent, there are comprised in the Royal patrimony upwards of 70,000 acres of land in the Kingdom let in farms to agricultural tenants, and also house property in London, and land let on building leases, and considerably more than 100,000 acres of Royal forests. For the last twenty years this great property has been managed by two Commissioners, under the superintendence of Her Majesty's Treasury, with great judgment and care, and at the moderate cost of less than 3 per cent. on the total receipts. The gross revenue has for some years shown a steady annual increase, and now amounts to 469,000*l.* A large expenditure is annually made in maintaining and improving the property, but the surplus now paid annually to the Exchequer has risen above, and is likely to continue more and more to exceed the annual amount of the Civil List. This is a sum assured by Parliament to the Sovereign, at the beginning of each reign, to defray the expenses of the Royal Household, by an arrangement continued from Sovereign to Sovereign from the time of the Revolution in 1688. The surplus income from the hereditary estates of the Crown, which was then precarious and uncertain, is by this arrangement during the reign of the Sovereign paid into the public Exchequer, and a fixed sum of 385,000*l.* is, in lieu of it, annually paid to the Queen for the maintenance of her State, and for the salaries and expenses of Her Majesty's Household. In the period of forty years since the commencement of the present reign, all expenses, both public and private, have largely increased, but no new demand on that account has been made on the public for an increase of the Civil List. And as the hereditary estates are now yielding to the public Exchequer more than it pays to the Queen, the remarkable and probably unique example is presented in this country of a great Sovereign whose household and Royal dignity are thus maintained without any cost to her subjects.

Her Majesty's  
Woods, Forests,  
and Land  
revenue,

now yield a  
net revenue  
to the public  
Exchequer  
exceeding the  
amount of the  
Civil List.

I am indebted to the Earl of Powis for the following interesting particulars in the business relations of the Crown with its agricultural tenants:—

The average rental of the agricultural land of the Crown Estates is at present rather more than 32s. 6d. per acre. Nearly the whole of it is let in farms of various sizes, on agricultural leases of 21 years' duration, subject to the reservation of all trees and substrata. The tenants are to reside on the premises: to cultivate according to the best mode of husbandry in the district: within the last three years of the termination of the lease not to sow two white crops in succession, or to plant on the same land more than one crop of potatoes. The tenants to be entitled to one-half of the money expended by them in the last year of the term in the purchase of linseed, cotton, and rape-cake consumed on the premises, but not to an amount exceeding one-half of the average expenditure for such articles during each of the three preceding years. The right of shooting and sporting is not reserved from the tenants, except under very special circumstances. New buildings are constructed, and existing buildings improved, and under-drainage, roads, and other permanent improvements executed at the cost of the Crown. Terms of renewal are proposed to desirable tenants, two years before the expiration of lease.

General conditions on which the Crown Farms are let.

#### CHARITY ESTATES.

The value and extent of land held in trust for charities in England alone is very considerable. Inclusive of rent-charges and fixed annual payments, the gross annual rental exceeds 1,558,000*l.*, derived from 524,000 acres of land, and the houses built thereon. Besides this, the Charity Trusts possess in Government Stock and other personalty, nearly 20,000,000*l.*, yielding an annual income of 640,000*l.* Their total income from real and personal property is thus close upon 2,200,000*l.*

Charity Estates:

their value.

This great property is held in separate endowments in all parts of England, in number estimated at about 50,000, which are administered by various bodies of trustees, such as Municipal Trustees, Ministers, and Parish Officers, and in many cases by persons who may be termed private trustees, or such as are not trustees in virtue of holding any especial office. These have been placed by Parliament under the general superintendence of a Government Department, the Charity Commission, which reports annually to Parliament upon the administration of the charities over which they possess necessary power of control.

The principal objects to which the funds were appropriated by the founders of the charities are education, apprenticing, and

Their magnitude compared with the cost of the civil administration.

advancement of orphans; endowment of clergy, lecturers, and for sermons; Church purposes and repairs; maintenance of Dissenting places of worship and their ministers; public parochial uses; support of almshouses and pensioners; distribution of articles in kind and money; medical hospitals and dispensaries. The property which has thus in the past been voluntarily devoted by benevolent persons as an endowment for charitable objects in England, is equal to more than one-half of that possessed by the Established Church. If we add the amount annually expended in the United Kingdom on the relief of the poor and in aid of education, it appears that the annual expenditure on objects of charity, exceeds the whole cost of the civil administration of the country.

I have now brought to a close this general view of the present state of British Agriculture, the preparation of which I was invited to undertake by the Council of the Royal Agricultural Society; very inadequately executed, I fear, but with as much care and accuracy as a wide experience enabled me to command. I have sought to place in a clear light the leading characteristics of our various systems as influenced by soil and climate, by the progress of population and wealth and its increasing demands, and by the distribution of landed property and the relations subsisting between the classes engaged in its cultivation. I have entered with some minuteness into those special features which chiefly distinguish ours from Continental agriculture, in order to facilitate comparison with that of other European countries. The Papers which are to follow will fully develop the several branches of the subject, each being the work of an accomplished writer specially acquainted with that part which he has undertaken. The state of the law as affecting agriculture, the pressure of public and local taxation, the requisite amount of farm capital, and the general subject of practical agriculture, will each be comprehensively treated. The cultivation of fruits, vegetables, and hops, will be described. The condition of the agricultural labourers will receive special notice. The influence of chemical discoveries on modern agriculture will be the theme of the distinguished Chemist of the Society, Dr. Voelcker; and a description of the position and widely extended usefulness of the Royal Agricultural Society itself, by the Secretary, will fitly complete the subject.

II.  
ENGLISH LAND LAW.

BY  
FREDERICK CLIFFORD,  
OF THE MIDDLE TEMPLE, BARRISTER-AT-LAW,

AND  
J. ALDERSON FOOTE,  
OF LINCOLN'S-INN, BARRISTER-AT-LAW.

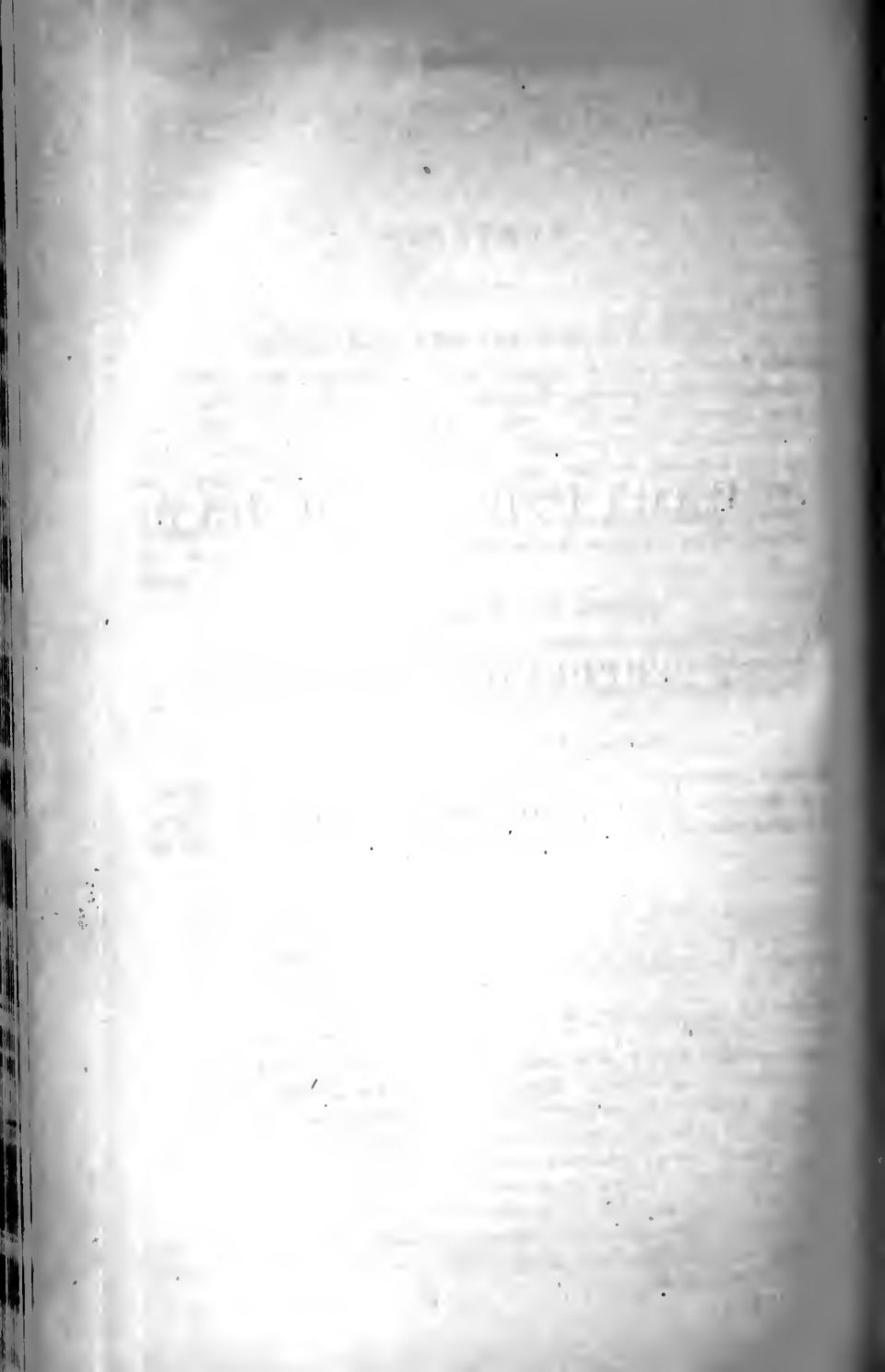



## CONTENTS.

### CHAPTER I.—*Succession and Ownership of Land.*

Feudal Tenure — Right of Alienation of Land — Manors — Military Tenures abolished—Primogeniture—Gavelkind—Limited operation of Primogeniture Law—" Estates tail "—The Statute *De Donis*—Fines and Recoveries —Settlements—Entail—Settled Estates—Not prescribed by Law—Power of Entail limited by Law—Examples of English Settlement—Leaseholds regarded as Personalty—Tenancy for Life—Leases by Life Tenants—Permanent Improvements, cost of, charged on Land—The Law of Mortmain—General policy of English Law adverse to perpetual succession in Land  
Pages 71–83

### CHAPTER II.—*Yearly Tenancies.*

Agricultural Tenants—Tenancies at Will—Emblements—Yearly Tenancies—Advantages and Disadvantages to Landowner—Their effect upon Tenants —Local Customs—Effect of Customs—Continuing Tenancies Pages 83–90

### CHAPTER III.—*Forms of Agreement.*

Written Agreements—Forms of Written Contract—Memorandum of Terms of Tenancy—Agreement for Tenancy—Freedom of Contract—Exclusion of Customs must be express .. .. . Pages 90–94

### CHAPTER IV.—*Leases.*

Leasing powers of Life Tenants—Legal effect of Lease—Tenant's Covenants —Covenants as to Husbandry—End of Tenancy—Payments to Outgoing Tenant—Landlord's Covenants—Arbitration—Forfeiture .. Pages 94–99

### CHAPTER V.—*The Agricultural Holdings Act.*

Farmers—Legal doctrine as to Emblements—Founded upon Public Policy—Growth of Tenant's Claims—Legal presumption against—First recognition of, by Statute—Its permissive character—Unexhausted Improvements assumed to be the property of Tenant—Application of Act—Tenant's title to Compensation—First-class Improvements—Their presumed Duration—If the Landlord is absolute Owner—Previous Consent of Landlord—If Landlord's Ownership is limited—" Letting Value " of Holding must be increased by Tenant's improvements—Questions as to Tenant's Outlay—Improvements of Second Class—Duration of Tenant's Claim for—Landlord's prior consent

to, not necessary—Notice—Assessment in respect of—Third-class Improvements—Period of Duration—Consent and Notice to Landlord not required—Exceptions to Tenant's Claim—Conditions of Compensation—General Conditions affecting Landlord and Tenant—Deductions from Tenant's claim—As to Landlord's Claim under Statute—Procedure in establishing Claim—Referees—Umpire—Powers of Referees—Award—Facts to be set out in—How to be disputed—Jurisdiction of County Courts—Appellate Court—Creation of charge on Estate—Notice to Quit—Customary time of, extended by Act—To Yearly Tenancies—Landlord may resume Possession of part of Holding for certain purposes—Fixtures—Farm Buildings—Steam-engines—Machinery—Landlord's Option of Purchase—Landlord's consent to erection of, unnecessary, excepting Steam-engines—Conditions of removal by Tenant—Results of Act—Indirect Benefits to English Agriculture  
Pages 99-118

# ENGLISH LAND LAW.

---

## CHAPTER I.

### SUCCESSION AND OWNERSHIP OF LAND.

THE soil of England is divided at the present time, according to a recent Parliamentary Return, among some 250,000 landholders, in addition to a much larger class, numbering about 671,000, who own less than one acre each of what may be called the most valuable of all the subjects of possession. In this sense, at least, it may be called the most valuable, that there is nothing else which represents so large an amount of capital in proportion to the yearly profits to be derived from it; and it is obvious that a means of investment, which attracts capital at a less rate of interest than any other, must necessarily possess unique and intrinsic advantages of its own. The nature and reality of these advantages belong to a question of political economy, the discussion of which would be out of place in the present paper, in which it is proposed to consider very briefly the laws by which the succession to and the ownership of this valuable possession are at present regulated in England, and to trace shortly the history of their past development.

It is the peculiarity of English law that any absolute ownership of the soil is, theoretically, a thing unknown. All Sovereign States are regarded as possessing over their own territory the "right of eminent domain" (*domaine éminent*), which is the name given by jurists to the paramount power possessed by the head of every State of disposing, in case of necessity or for the public safety, of all the land, private property or not, within its limits. But in addition to this right, the introduction of the feudal system into England vested the ultimate seignory or lordship of all the soil in the Sovereign personally; and all that a landowner can even now possess is, in theory, some portion of the Sovereign's right, ceded either tacitly or expressly at the time

Feudal tenure.

when his tenure or holding commenced. This tenure, rendered uniform in its character by a statute passed on the accession of Charles II. after the Restoration (12 Car. 2, c. 24), has gradually become of little importance in its present effect; but, as the foundation upon which the whole of the English land law has been built, it can never be entirely disregarded. It is indeed difficult to believe that two hundred years ago the burdens and liabilities involved in it were grave in their character, and general in their operation; and to a generation which enjoys the free possession of the soil, emancipated from the shackles which so long impeded the development of its resources, the evils which their ancestors were compelled to tolerate are scarcely known except by tradition, or by the imprints they have left upon the laws under which their substance has passed away.

Right of alien-  
ation of land.

The great bulk of the soil of England, comprised in the fiefs or holdings thus created by the Sovereign's pleasure, was originally alienable under peculiar conditions. The right which the original tenant possessed was not passed on in its entirety to the alienee, in whose favour the transfer was made. He became a sort of under-tenant of the first tenant or grantee of the Crown, in whom a seignory or lordship remained to enable him to fulfil the services which were imposed as the consideration for, and as inseparable from, the royal bounty. The sub-holdings thus created became the *manors* of the lords by whom they were granted, and a variety of minor tenures, too complicated for discussion here, thus came into existence. It will be sufficient to say that the tenants of these manors, as of those older ones which had a different origin, consisted mainly of two great classes. First, the freeholders of the manor, who occupied what the Saxons called the *bokland*, and held exactly the same relation to the lord that the lord bore to the Sovereign, enjoying a definite and secure tenure in return for ascertained services. Secondly the copyholders, or occupiers of the *folkland* of the manor, originally nothing more than the serfs of the lord, who were permitted to hold certain portions of the demesne as a matter of favour, and whose rights grew in the course of centuries into a custom adopted and enforced by the common law of the country. It was not until the reign of Edward I. that this process of sub-infeudation was put an end to by a statute called, from certain words with which it sets out, the Statute of *Quia emptores*. From that time the alienee of any portion of a fief became the immediate tenant of the Sovereign, as if he had been named in the original grant. The services which belonged to such holdings were originally of almost endless variety, some burdensome in the extreme and some almost nominal in their nature; but from this period the tenure ceased, at any rate, to be

Manors.

complicated by the introduction of a number of intermediate lords, and the way was prepared for the ultimate simplification of the whole feudal system by the enactment in the seventeenth century, which has been already mentioned. By that statute the military tenures, which had by that time become almost unendurable to the independent agriculturists and yeomen of the country, were swept away with all their burdens and liabilities; and, except in the case of copyhold tenancies, the tenure known as free socage became the general law of the land. The term *socage*, derived from the Saxon word "Soc" signifying a liberty or privilege,\* was used to denote any tenure of land in which the services to be rendered were certain and definite in their nature; and although there was also a variety known as "villein socage" or "privileged villeinage," the services belonging to this tenure were, generally speaking, such as a freeman could render without degradation. By the middle of the seventeenth century these services had in most cases resolved themselves into the payment of mere fealty and homage, which is the sole condition upon which, at the present day, the great bulk of English land is held of the Crown. When land is held in freehold from intermediate lords, there are still instances to be found where a customary rent is due; but, practically speaking, there is at the present time for the great bulk of the soil of England some absolute owner, either in actual or potential existence, who owes nothing in respect of his tenure but the fealty of a subject to his Sovereign. What is meant by saying that in some cases such an owner has only a potential existence, will be better understood when we have explained the manner in which the rights of landowners are frequently limited to the duration of their own lives.

It is frequently asserted that the right of primogeniture, which gave the lands of the father to his eldest son, was always an essential part of the English common law, but the statement is an erroneous one. The ancient English common law of inheritance was the law of gavelkind, by which the land of the father descended in equal shares to his sons, who could alienate

\* Socage is often said to be derived from the Saxon word for a plough, and to denote an agricultural tenure, which imposed upon the tenant the duty of cultivating his lord's land. There is, no doubt, a Saxon word to which the term might etymologically be traced, but the root which is in reality its origin is a perfectly distinct one, and bears the meaning given to it in the text. Nothing is more clear than that such agricultural services were "base" in their nature, performed only by the serfs or villeins of the lord of the demesne; and a little consideration will show that a tenure depending on such conditions could never have become, either by common law or by statute, the ordinary holding of English freemen, or indeed have been ever applicable, except in isolated cases, to those who held directly from the Crown. (See Kerr's 'Blackstone,' p. 67, n.) The mistaken etymology referred to has been used by some writers to support a theory that the groundwork of English tenure generally was based upon the needs of agriculture.

Military  
tenures  
abolished.

Primogeniture.

Gavelkind.

it at pleasure on attaining the age of fifteen. By "gavelkind land" was meant originally land held on condition of the payment of *gavel*, a Saxon word signifying "rent," or "a customary performance of husbandry works." It was thus clearly distinguishable from land held on the feudal system, by tenants bound only to render certain military services in return, and a different rule of inheritance was applied to it. Among other incidents of gavelkind tenure may be mentioned the immunity of the land affected by it from forfeiture or escheat for felony or treason, expressed in the old maxim, "The father to the bough, the son to the plough," and showing that the duty of cultivating the soil was anciently considered paramount even to the rights of the Sovereign or chief. The law of primogeniture was indeed unknown to the ancient English, as it was to the Romans, the Germans, the Hindoos, and even to the patriarchs. In all these communities the land of which a man died possessed was divided among his children, generally in equal shares; and it was the requirements of the feudal system that first firmly established in England the right of the eldest son to his father's possessions, as being the person in general most able to discharge the military and other obligations which were attached to them. The custom of primogeniture was indeed fostered and diffused by every successive conquest and occupation of the soil. Though no part of the Roman law originally, it became so in many of the conquered provinces from the peculiar character of the military tenure by which privileged veterans of the army obtained allotments of the soil. Romans, Saxons, and Normans in turn granted to their followers, and in some cases even to the native possessors of the conquered territory, fiefs or holdings in return for certain definite services in time of need; and no other law but that of primogeniture was found applicable to the tenures thus called into existence, or adapted to ensure the fulfilment of the obligations which were inseparable from their maintenance. It was not, indeed, until the middle of the thirteenth century that the rule was generally accepted in England, nor did its operation ever in fact become universal. The law of gavelkind still lingers in the shape of a recognised custom in Kent and some other parts of the country, but its rarity has caused it to have now little more than an antiquarian interest. With the exception, however, of these very limited districts, the law of primogeniture, first introduced at the time of the Conquest, has for six hundred years at least been established as the common law of the country, and has given form and colour to almost every phase of its history and development. The extent of its actual and direct operation at the present day is, however, very trifling. An absolute owner of land may



devise it, by will, equally among his children or to whomsoever else he pleases. His disposing power is wholly unfettered. All that the law says is that, in the event of his dying without a will, the land shall go to his eldest son to the exclusion of other children. It has been stated that two per cent. of the land that annually changes hands is affected by the law of primogeniture, but this is probably largely in excess of the truth. It is obvious that the proportion of persons dying without wills to the whole number of annual deaths, or even to the number of wills annually proved, will furnish no trustworthy guide; since no persons are so unlikely to die intestate as those who have landed property to bequeath, and a considerable number, even of those who do, no doubt frequently adopt the natural course of the law in place of making a will, who would have taken the trouble to devise their property specifically to their eldest sons, if the law had given it a different destination. The object of this law has been mainly secured in two other voluntary and indirect ways—by the operation of the law of entail, and the law of settlement. It will be necessary very briefly to consider the result of these influences.

With the object of insuring that the royal lands should always be in the hands of some one able to discharge the burdens inseparable from them, a large number of original grants were made conveying to the tenants of the Crown what was called an estate tail. This estate or interest was created by a grant to the intended tenant and the heirs of his body, with a reversion to the grantor in case no such heirs should come into existence. Under such a grant the tenant took nothing, strictly speaking, but an estate for life, nor did his son, upon whom that estate devolved, stand in a better position. But it was not long before the law allowed such a tenant, upon the birth of an heir to satisfy the terms of the grant, to defeat both the interest of his son and the reversion of the lord by alienating the whole estate, and the practice, once sanctioned by legal authority, soon came into very general use. To remedy what was then regarded in the light of an evil, the Act known as the statute *De Donis* was passed (13 Ed. 1, c. 1) towards the end of the thirteenth century, by which the power of the tenant in tail to alienate his lands for a longer period than that of his own life was effectually checked. The result of this legislation was, that for nearly 200 years a series of life estates in a large proportion of English soil prevailed without interruption, and the evils inseparable from a system of limited ownership in land were never more graphically illustrated. To borrow the words of Blackstone, children grew disobedient when they knew it was not in the power of their father to interfere with their right to succeed, him, farmers took leases at haphazard and were ousted to their

“Estates tail.”

The statute *De Donis*.

ruin, and creditors were defrauded of their just expectation by the discovery of an entail which had hitherto been kept a secret. The progress of civilisation demanded a release from such a bondage, and in course of time the desired remedy was found.

Fines and recoveries.

It was at the end of the fifteenth century, in the reign of Edward III. (1472) that the device known as a *common recovery*, by which the state of things above described was practically put an end to, was first employed. Of this process it is unnecessary to say more than that it was a legal fiction, which, by a kind of *fraus pia*, enabled the tenant in tail to whom issue had been born to convert his limited interest in the land into its absolute ownership, with the unfettered right of alienation and devise. Nearly the same result was accomplished a few years later by another legal fiction known as *levying a fine*, which received parliamentary sanction by a statute passed in the reign of Henry VIII. (32 Hen. 8, c. 36), and all the estates which had been fettered by previous legislation for 200 years were from this time practically emancipated. For two more centuries, speaking in round numbers, land-owners enjoyed a freedom of alienation hitherto unknown or confined to a privileged minority; and the rapid growth and independence of the order of yeomen and landed gentry, in the days of the later Tudors and earlier Stuarts, has been attributed in great measure by some writers to the liberty thus bestowed. By the seventeenth century a new means of fettering the landowners' hands was introduced, not by the Legislature, but by private individuals and for private ends. This was by the establishment of the system of family settlements, which resulted in again throwing a large portion of the soil into the possession of those whose rights were limited by the duration of their own lives, and constituted indeed a privileged kind of tenancy rather than an ownership in the proper sense of the word. The practice of settling estates owes its origin to the ingenuity of Sir Orlando Bridgman, and other eminent lawyers of his time, and was adopted in the troubled periods of the Commonwealth and Restoration, with the main object of evading that forfeiture for felony or high treason which was then unhappily so common a calamity. It would require a volume to give anything like an adequate idea of its intricacies, but the main principle in which it originated was to confer a life estate upon the immediate tenant, and, by the interposition of a trustee, to secure the devolution of the lands upon his eldest or other son in any event. The son, in turn, stood in no better position, and upon the attainment of his majority generally resettled the estate in the same manner. The first tenant in tail under such a settlement was able to "bar the entail," and in that manner make his ownership of the land absolute, by the

Settlements.

Entail.

process of fine or recovery already mentioned; but to do this effectually, the concurrence of the tenant in possession, though only possessed of a life estate, was necessary. The restriction has been preserved by the modern Act for abolishing fines and recoveries (3 & 4 Will. 4, c. 74), which allows any entail to be put an end to by the simple process of enrolling a disentailing deed in the Court of Chancery, the consent of the "protector" of the settlement, who may be either the tenant who has the life estate preceding the estate tail, or any person or persons nominated by the original settlor, being still a necessary preliminary to the exercise of the powers conferred by the statute. Even without the consent of the "protector," a tenant in tail may dispose of his lands under the Act in such a way as to defeat any subsequent claim by his own issue, as he might formerly have done by levying a fine. He cannot, however, without such consent, defeat the right of those entitled to the lands in the event of the failure of the estate tail by there being no heirs of his body to take it. The cumbrous and antiquated machinery which tended to fetter the successive inheritors of the land, and to stereotype a form of estate so ill-suited to modern requirements, has by this beneficial enactment been entirely swept away.

Modified chiefly by the statute of William IV., the system of Settled estates. settled estates is still in full operation in England; and it has been estimated that probably more English land is thus artificially tied up than remains at the free disposal of the nominal owners. Although the Court of Chancery has certain statutory powers of directing the sale of settled estates where it is thought advisable, yet the habit which has grown up in most wealthy families of resettling the land before any person becomes entitled to the absolute ownership, results in making no inconsiderable portion of English soil for all ordinary purposes practically unsaleable. Much has been said and written on the merits and demerits of such a system; and the question is often raised whether the assumed benefit to the particular family compensates, by its indirect operation on the welfare of society, for the injury to the State which is generally admitted to be the result of restraining the alienation of the State's most valuable possession. The discussion of such a question is obviously beyond the limits of the present paper; but it has been necessary to refer to it, in order to explain that it is chiefly in this form that the rule of primogeniture manifests itself in England at the present day.

The English law is sometimes criticised as though it encouraged, or even made compulsory, the continuance of large estates in the hands of one family, and favoured the accumulation and transmission of such estates by men who have acquired wealth Not prescribed by law.

Power of entail  
limited by law.

in trade. Such criticisms, it will be seen, have no real foundation. We have shown how small is the effect produced in practice upon the succession to property by the law which prescribes that upon intestacy land should devolve upon the eldest son alone. We have also shown how large estates in England are kept unbroken, and handed down in the male line, not by force of law but at the wish and by the act of the persons chiefly interested. What is done, therefore, is done voluntarily by the individuals, the law merely giving effect to certain family arrangements, under which it is desired that estates should pass from father to son, or to the next heir, without essential change or diminished acreage. So far, indeed, is the law from encouraging this prevailing wish among English landowners, that it places obstacles in its way, by facilitating, as we have seen, the release of estates from entail, and, further, by limiting the period during which a landowner, by deed or by will, may tie up either land or money with a view to benefit remote descendants. This is what is known in English law as the rule against perpetuities. No attempt to restrain the alienation of land is effectual beyond a period of 21 years after the expiration of a life or lives in existence when the will or deed begins to operate. Thus, the English law peremptorily forbids all attempts to perpetuate families by an indefinite restraint upon the future alienation of property. It allows to an absolute owner of land full liberty of sale, and full liberty also as to the objects of his testamentary bounty. He may divide his property, landed or personal, among all his children, or leave it to one of them, or to strangers, at his pleasure; the only obstacle to his free dealing with his property is that the law will not permit him to fetter in turn the freedom of his successors in title beyond the period just mentioned.

Examples of  
English settle-  
ment.

The reason for prescribing this period of 21 years after a life or lives in being, is because then the first unborn heir in the direct line of the entail must, at the end of that period, have attained his majority and have acquired in his turn a legal power of disposition over the property to which, by force of the instrument, he succeeds. The usual course of family settlement in England will best be illustrated by examples. Thus, A. on his marriage settles his property on himself for life, reserving a dower or jointure for his widow, and a power to charge the inheritance by way of mortgage with portions for daughters, and fixed sums or yearly allowances for younger sons. The settlement further provides that, on the death of A., the whole shall devolve in the form of an estate tail upon his eldest son and the heirs of this son's body; or, in the event of the eldest son's death without issue, then upon the next son; and so on, providing for the probable con-

tingency of death or failure of issue. Thus, A. becomes what is called the life-tenant; B., his eldest son, the heir of entail, or next successor. When B. comes of age, A. and B. may join to cut off the entail; the law, as we have shown, lending itself to this proceeding, so as to favour the free disposition of property. If A., the father, be dead, B., on coming of age, acquires the power of disposing of the property absolutely, and thus putting an end to the entail altogether. Or again, M. has a son, N., who wants to marry. M., being anxious to keep his estates unbroken, settles them on himself for life, reserving a jointure for his widow and charges in favour of his younger children as in the case last supposed. Then the settlement provides that, upon M.'s death, his eldest son, N., shall enjoy the estates for life, with a similar jointure for the widow and charges for the younger children of N.; and upon N.'s death the estates are made to devolve upon his eldest son, O. When O. comes of age, at 21, M., N., and O., or such of them as are then alive, may join together and destroy the entail; and when O. succeeds, he may by simple alienation put an end to the entail altogether. That the policy of the law in favour of alienation is not without practical effect may be seen by reference to the constant advertisements of sales of land in the 'Times' and other English newspapers, which show that large quantities of land are disposed of annually.

While, if a person dies without a will, the English law gives the land to his eldest son, it must be borne in mind that all his personal property (excluding the widow's share) is divided equally among his children; and that leaseholds, whether lands or houses, are regarded as personal property for the purposes of such distribution. As a very large proportion of house property is held upon lease, this fact is not immaterial in considering the succession to real property in England; and the leasehold interests in agricultural land, of which we shall presently speak, are similarly treated.

We may now consider very briefly the nature of the disadvantages under which a tenant for life only of an estate labours in dealing with his possession, and the manner in which the rights of tenants for farming purposes, constituting the large majority of the agricultural class, are affected by their landlord's limited powers. By the common law no tenant for life only could make a lease for a longer period than that for which his own interest was to endure, and at his death any lease granted by him became void against those entitled to the lands after him, or, in the case of an estate tail, even against his own issue. Under certain restrictions, a power of making a lease for not more than 21 years, by which their issue, though not the reversioner, should be bound, was conferred upon tenants for life by a statute passed

Leaseholds regarded as personalty.

Tenancy for life.

Leases by life  
tenants.

in the sixteenth century (32 Hen. 8, c. 28), and the same privileges were at the same time given to a man possessed in right of his wife, who had hitherto laboured under a similar disability. The Act remained in force until 1856, when the statute 19 & 20 Vict., c. 120, was passed for the amendment of the law on the subject, and enabled all life tenants to lease by deed for 21 years, under certain terms and at the best reasonable rent. The whole subject of leases will be considered in its proper place.

The statute just referred to further authorised the Court of Chancery to sanction, under certain circumstances, the sale of settled estates, or of the timber growing upon them, and to direct the investment of the proceeds upon similar trusts. From time to time it has been felt that these enactments hardly touch the real evil of a limited ownership by which the tenant-farmer is chiefly affected. The possessor of a life-interest only, who probably requires the greater part of the revenues of the land for his personal wants, and has besides the duty of saving something for those of his children who take no provision under the settlement, is seldom inclined, or even able, to employ capital in effecting improvements of a permanent character on the property of which he is the transient possessor. He may die before the benefit from the increase in the yearly produce, which is due to the improvement, has even begun to make itself felt; it is almost always improbable that he will live to be compensated in full for the money which he has irretrievably sunk; and while the person entitled in remainder will reap much of the advantage of his outlay, his own means of providing for those for whose welfare he is most anxious are proportionately diminished. In theory, no state of society more disadvantageous to agriculture can be conceived than one in which most of the soil of the country is under the control of life tenants, with limited powers and interests, and let by them to yearly tenants, whose chief interest it is to get as much as possible out of it before it passes from their possession. Yet under this theoretical disadvantage, as regards both yearly tenancies and life estates, English agriculture has attained whatever eminence it now enjoys.

The tenant for life occupies the same position with regard to the owner who is invested with the absolute ownership, that the tenant from year to year bears with regard to the tenant for life; and inasmuch as it is unavoidable, in the present artificial state of society, that the great bulk of the soil of the country should be in the hands of those whose ownership is limited in the one way or the other, it has been found imperatively necessary that the Legislature should make some effort to counteract the evils



which such a condition of things would of itself naturally and inevitably create. In one direction this has been done by giving the life-tenants those leasing powers of which mention has been already made—a reform the necessity of which began to make itself felt as early as the sixteenth century—but the other main step in this direction was not taken until a comparatively recent date. In 1843 an Act was passed to enable tenants for life, or for terms determinable on lives, and mortgagees in possession, to make certain improvements of a permanent nature, such as drainage works, on the estate, and to charge the costs on the revenues of the land itself, by obtaining special leave from the Court of Chancery for that purpose. In the next Session the Commissioners of the Treasury were empowered to grant loans to landowners for similar purposes, and a sum of 2,000,000*l.* was set aside for this special object. The definition of an owner in that enactment, the spirit of which has been adopted in its essential parts by the later and more comprehensive statute to be presently mentioned, included every person in possession or in receipt of the rents and profits, but provided that a tenant for life or years, at a rent not less than two-thirds of the clear yearly value, or holding for a term not exceeding fourteen years at any rent, should be deemed to be owner for the purposes of the Act jointly with the reversioner. The limited amount of money available for carrying out the objects of the statute rendered it necessary to pass the Private Money Drainage Act in 1849, giving owners, as above defined, power to borrow from private individuals for the same purposes, with the sanction and under the control of the Inclosure Commissioners. In the next year a further sum of public money was set aside for the same object, with the same machinery for controlling its application; but the Improvement of Lands Act, 1864 (27 & 28 Vict., c. 114), has superseded all previous enactments on the subject. The owners on whom the borrowing powers which it creates are conferred are the persons in receipt of the rents and profits of the land; and where such persons are tenants for a remaining term of less than twenty-five years, or for life or lives not renewable, then the tenants jointly with the reversioners. The powers so conferred have been still further supplemented by those sections of the Agricultural Holdings Act, 1875 (ss. 42, 43, 44), hereafter mentioned, which provide that a landlord, who pays his tenants compensation for permanent improvements under that statute, may obtain a charge on the holding for the amount paid, on application to a county court judge, who may fix the rate of interest and mode of repayment as he thinks fit. These charges may be taken by the Commissioners for the Improvement of Lands, who are authorised to advance money by the previous

Permanent improvements, cost of, charged on land.

statutes, and can be assigned over by them to any other person. The cheapness and simplicity of the procedure thus prescribed should recommend it for general adoption; and whatever may be the evils inseparable from a limited ownership of land, the English Legislature cannot at any rate be charged with having omitted the attempt to provide a remedy.

The law of  
mortmain.

No sketch of the ownership and succession of land in England would be complete which omitted reference to the laws affecting gifts for charitable uses. What is called, though not quite accurately, the Statute of Mortmain, was passed in the reign of George II., taking effect in the year 1736, but was really founded on principles long recognised by the English law. It was entitled, "An Act to restrain the Disposition of Lands, whereby the same may become inalienable;" and its recital, or preamble, sets forth the reasons which led the Legislature to adopt it:—"Whereas gifts or alienations of lands, tenements, and hereditaments in mortmain are prohibited or restrained by Magna Charta, and divers other wholesome laws, as prejudicial to and against the common safety: nevertheless, this public mischief has of late greatly increased, by many large and improvident alienations or dispositions made by languishing or dying persons, or by other persons, to uses called charitable uses, to take place after their deaths, to the disherison of their lawful heirs."

This statute does not go on wholly to prohibit such gifts, but enacts that no lands, nor money to be laid out in purchasing lands, shall be given or in any way conveyed to any persons in trust, or for the benefit of any charitable uses whatsoever, unless such gift is made by deed, duly witnessed, and enrolled in the Court of Chancery within six months after execution, and unless also such gift is absolute, without power of revocation, and is further made to take effect immediately after execution. Moreover, all such gifts are declared void if the donors die within twelve months after executing the deed. Thus, in England, no gift of any estate in land for charitable (including religious) uses can be made by will, which only takes effect, of course, on the death of the testator.

Certain exceptions were introduced into the statute in favour of the two Universities of Oxford and Cambridge, or any of the colleges within those Universities, or the great schools of Eton, Winchester, and Westminster.

General policy  
of English law  
adverse to per-  
petual succes-  
sion in land.

Since the passing of the Mortmain Act, statutes have been enacted to facilitate the grant of sites for schools, and for other purposes of public utility. But the general law remains still more strongly opposed to that perpetuity of title in the case of Corporations, which is forbidden in the case of individuals; and

the Courts are strict in upholding both the letter and the spirit of the Mortmain Act. No conveyance of land can be made to any Corporation unless the Crown has granted it a licence to hold land. The Charity Commissioners, a public body appointed by the Crown, exercise large powers of control over incorporated charities in respect of any land held by them. The Ecclesiastical Commissioners, a body similarly appointed, exercise a like control over Church-lands, and themselves hold land for Church purposes. A parish priest, or a Cathedral Chapter, or a Bishop, cannot give a mining or building lease of his Church-lands without the consent of the Ecclesiastical Commissioners; and the consent of the Charity Commissioners must in like manner be obtained for such lease by the governors or managers of a Charity. The Board of Trade also has jurisdiction over the holding of land by companies. Every joint-stock company registered under the Joint-Stock Companies Acts has power to hold land, but no company, not being a trading company, can hold more than two acres of land without the consent of the Board of Trade.

---

## CHAPTER II.

### YEARLY TENANCIES.

IT has already been mentioned as one of the leading features of the English agricultural system, that a fractional part only of the soil is ever in the hands of its absolute owners. The cultivator is for the most part merely the occupier of the land which he tills, enjoying none of the rights of property, and in many cases those of possession only in name. The causes to which such a state of things is due are many and various, but the obvious fact that the English landowner has not chosen to embarrass himself with the actual culture of the soil, in whose yearly profits his riches consist, has been prominent at all stages of English history; and the condition of modern society in this country promises no material alteration. At no time, indeed, have the relations of English tenants or occupiers towards the owners of the soil shown at any time much susceptibility to sudden or important change. The common law of the realm, upon which they rest, has always been slow and stubborn in admitting reform, and the attempts of the Legislature to modify and control its operation are for the most part of comparatively recent date.

Tenants of land for agricultural purposes may be broadly divided into three main classes: (1) tenants by a parol demise

Agricultural  
tenants.

from year to year; (2) yearly tenants under written agreements intended to extend over a considerable but uncertain time; and (3) tenants under a lease or a binding agreement for a lease for a fixed term, usually varying from 8 to 19 years. That description of tenancy which is created by a lease for a life or lives, or for a term longer than 25 years at the outside, reserving a rent less than the actual yearly value, and generally purchased by a money payment or premium to the original lessor, constitutes in reality a fourth kind of tenure by itself, which is not generally agricultural in its character, and need not be considered here. But it is almost essential to a proper comprehension of the second and third classes of tenancy mentioned above to consider in the first place the nature and origin of a simple tenancy from year to year, and its adaptability to the interests of the owner of the soil, as well as of its possessor.

Tenancies at will.

It is generally conceded that the oldest and simplest form of holding known to the law of this or any other country was a tenancy at will; and this tenure, as well as that from year to year into which it grew, were necessarily familiar to the earliest cultivators of the soil, long before the heritable tenures which conferred an estate or property in the soil rested upon any legal foundation. Yearly tenancy, however, in its modern form, is practically the outcome and result of the superior or heritable tenures already described, and must be considered as subservient and ancillary to them. It was impossible for the lords of manors or the proprietors of fiefs to occupy, either by themselves or their serfs, the extensive tracts of land on which a plough might be driven in no other name; and after the passing of the statute of *Quia emptores* in the thirteenth century, by which the system of sub-infeudation that had previously existed was put an end to, it was no longer possible for the landowner to alienate any part of his estate without losing all the rights of seignory and lordship which he had up to that time been always able to reserve. Tenancies at will, in which the occupier paid a rent certain, but was liable to be evicted at any time at the pleasure of the owner, were of course known long before this enactment, but there can be no doubt that from the date of the statute referred to they came every year into more general adoption. Disadvantageous as such a holding must necessarily have been, not only to the occupier but to the true interests of the landowner himself, its inconveniences were in some measure diminished by the common law or custom of the country as to emblements, which gave to the tenant at will the property in such crops as he had actually sown, but which had not yet arrived at maturity when his holding was terminated by the will of the lessor. In most cases it was in effect necessary for the due assertion of this right that

Emblements.

the tenant, though nominally evicted, should practically retain possession of the land on which his crops were growing until the completion of the current year. By the time that the sixteenth century arrived, in the reigns of Henry VII. and Henry VIII., the courts of law had already begun to hold that a tenant at will of land for agricultural purposes who had entered and paid rent, was in reality a tenant for a year certain, and so from year to year afterwards, entitled to six months' notice before the lands which he cultivated could be taken from him. Thus, a species of qualified security in his holding was given to the tenant who had hitherto been only indirectly protected, which has satisfied the necessities of a large portion of the cultivators of the soil up to the present day. Controlled only by the custom of the country, which is, when universal in its operation, identical with the common law, and when only of local extent, is within those limits equivalent to it, agricultural tenants have in many parts of England occupied the soil from year to year for generations, on no other terms than those declared and formulated by the common law in the sixteenth century; and greater fixity of tenure, though, perhaps, never altogether lost sight of, has at any rate been found not entirely indispensable. According to a recent authority, tenancies from year to year, depending for the most part on parol agreement and local custom alone, are the rule and not the exception in at least ten of the forty English counties,\* including the largest; and a system which has so long prevailed over an area so considerable must necessarily have certain advantages and recommendations of its own. It is natural that the landowner should in many cases prefer an arrangement by which he retains the power of taking his property back into his own hands at his option, by the simplest possible procedure, and with little risk of an expensive and troublesome litigation; and under no other system would it be possible for him, while parting with the actual possession of his material wealth, to preserve so completely the power of controlling it. Against these advantages must be set the fact that the guarantee which is given to him for the regular and continuous receipt of his rent is very imperfect, and that he is liable at any time to lose the profits of the greater part of a year, by having his property suddenly thrown on his hands when he has no tenant ready to take the place of the defaulter. More worthy of consideration, perhaps, is the danger which he incurs of meeting with a tenant who has not

Yearly tenancies.

Advantages and disadvantages to landowner.

\* The counties referred to are Derbyshire, Gloucestershire, Herefordshire, Monmouthshire, Lancashire, Cheshire, Oxfordshire, Somersetshire, Shropshire, Worcestershire, and Yorkshire in the North and East Ridings (Dixon's 'Law of the Farm,' chap. 3).

sufficient capital at his disposal, or not sufficient confidence in the goodwill of his landlord, to cultivate the soil as a man would do who contemplated a series of years during which his livelihood was to be drawn from it; or with one who might be tempted by temporary embarrassments or greediness to take as much as possible out of the land while it remained in his possession, with the intention of throwing it back upon the hands of its owner in an impoverished condition as soon as it ceased to be profitable to him to retain it. Against this peril the landlord may of course protect himself by particular stipulations as to the mode of culture, there being no reason in the nature of the thing, as has been said in a court of law, why a parol agreement for a yearly tenancy should not be as special and obligatory in its provisions as a written contract or even a lease. But in many cases, and probably in a large majority, a parol agreement for a yearly tenancy is made in a less complicated manner, and merely incorporates as its conditions the customs which prevail in the particular district where it is entered into. In these customs the landlord usually finds sufficient though not the best protection; but the uncertainty and variety by which they are characterised renders it at once more difficult to ascertain their effect, and more dangerous to rely on their validity, than his true interests would require.

Their effect  
upon tenants.

The advantages of a simple tenancy from year to year to the occupier are even more problematical. In theory, the tenant has no security that any year during which he is spending his labour and his money on the land may not be the last of his occupation; and though his right to six months' notice to quit his holding may save him from losing what he has sunk in the crops of the year, he was, up to the year 1875, entirely dependent upon the custom of the country for any further protection. But although the value of this protection is impaired by the multifariousness and uncertainty of local customs, yet in practice throughout England tenants have suffered only in exceptional cases. In many districts of England tenancies from year to year are not unfrequently transmitted from father to son, and the land remains in the hands of one family for generations. Between landlord and tenant, at least in the majority of cases, a feeling of mutual confidence prevails, and leases are never asked for or wanted by the tenantry on a considerable number of the great family estates in England. The tenant who holds from year to year feels that he has not burdened himself and his family with the responsibility of having permanently undertaken a holding which may prove more onerous than profitable, and that he is at all times able to avail himself of any opening for his capital and industry that he may perceive elsewhere; while he also feels



safe in the hands of the landlord, with whose family he and his have been so long connected. The law, however, as recently settled, has not left these patriarchal relations intact.

The customs of the country, upon which the rights of both landlord and tenant, in the case of yearly tenancies by parol, so largely depend, are so varied and uncertain in their nature, that no attempt at stating their general effect with precision could be successful. Strictly speaking, they must be local in their operation—to distinguish them from the common law—they must have existed from time immemorial, and they must have been voluntary in their origin. But this is all that can be universally predicated of their essence; and the number of manifold forms in which they exist, to modify the rights of lessor and lessee, is so great as to render their general discussion quite unmanageable. The most striking example of the effective operation of this unwritten law has been already alluded to, and when mere custom can of its own strength result in converting a precarious holding at the will of the landlord into a comparatively secure and legal tenancy, that can only be determined at the end of each successive year, it would seem that scarcely any limit is to be assigned to the possible results of the same agency. Attempts, however, to extend the implied rights of the yearly tenant still further upon the same principle have proved ineffectual. It was decided in 1778, that a general demise for a term not specified could not be extended by an alleged custom to a three-yearly tenancy, or to any term longer than a year which was required by the course of husbandry usual in the district; and in that case the Court said that to allow such an implication would be to repeal in many cases some of the most important provisions of the Statute of Frauds (29 Car. 2, c. 3), which requires writing for the creation or transfer of any interest in land, except a demise for a term not exceeding three years at a rent amounting to at least two-thirds of the full improved value (*Roe v. Lees*, 2 W. Bl. 1171). Even in that case, it was intimated that it was not impossible that a general tenancy might in some cases be regarded as a holding from two years to two years, without a special provision to that effect, where that period was necessary to allow such a crop as was contemplated by the parties to come to maturity, as in the case of liquorice or madder. The cases referred to must be so exceptional, that the dictum is of little practical importance, but when it is remembered that in 1550, a custom that a lessee for years should retain the land for half a year beyond his term was held bad and invalid, the change that 200 years had brought about in the spirit of the law becomes abundantly manifest (*White v. Sayer*, Palm. 213). It may be mentioned here, as a further proof of the strength to

which unwritten law had attained by the end of the eighteenth century, that it was determined by Lord Mansfield, in 1781, that a customary stipulation might be superadded even to the express covenants of a lease, where they did not, in terms or by necessary implication, exclude it (*Wigglesworth v. Dallison*, 1 Sm. L. C. 598).

Effect of  
customs.

The main points to which those customs relate that have received the sanction of the law may be very briefly summarised. In most cases they refer either to the commencement of the tenancy, the mode or course of cultivation, the right to the way-going crops, or the compensation to which the outgoing tenant is entitled for unexhausted improvements. According to the most recent authorities, tenancies commencing at Michaelmas are the rule in about fifteen of the forty English counties, in ten Lady-day is the favourite period, and in six either Candlemas (Feb. 2nd) or May holdings are adopted; whilst in the remainder tenants appear to enter either at Michaelmas or Lady-day indifferently. It is stated that Lady-day tenancies are considered preferable for arable farms, and the customs which regulate the rights of the outgoing tenant must of course vary considerably, according as he surrenders his holding just after seed-time and tillage, or at the completion of his harvest. As to the mode of cultivation, the most universal restriction is that which binds the tenant to consume on the premises all the straw and manure which is made there; though even this stipulation is often relaxed, especially in the case of lands close to a large town, where straw finds a ready and profitable market, and from which artificial manures are readily to be procured. With regard to the rotation of crops, though a course of three or four years is frequently prescribed, yet the tenant is often simply prohibited from taking two white crops in succession, and in some districts the obligation to cultivate his farm according to the rules of good husbandry is the only one that is laid upon him. It must be remembered that such stipulations are far less necessary to protect the landlord in the case of a yearly tenancy than in that of one for a longer term, it being always in his power to put a summary end to the mischief, by giving a six months' notice to the offender by whom his land is being impoverished; but it may be mentioned that in some of the principal counties where yearly tenancies are generally adopted, a four-years' course is in most cases agreed to by implication of custom, and strictly adhered to. Of this, the counties of Gloucestershire, Oxfordshire, Worcestershire, and the North and East Ridings of Yorkshire, may be selected as examples. With regard to the right of the outgoing tenant to the crops which are in the ground at the termination of his tenancy, and to compensation

for the unexhausted value of the improvements he has effected during his holding, the subject is too large to be more than mentioned here, and will be separately discussed in connection with the Agricultural Holdings Act of 1875. Apart from the operation of this statute, the customs applicable to yearly tenancies differ in no way from those which prevail where the outgoer has held under a lease or agreement for a term of years. The tenant's right to the way-going crops is, comparatively speaking, general and uniform in its operation, being in itself little more than an extension of the common law as to emblements which has been already spoken of; but, except in certain districts, the customary right to compensation for unexhausted tillage, drainage, and manure, is quite inadequate of itself to meet the necessities of agricultural tenancy without statutory aid, and varies not only in different counties, but even in neighbouring parishes, in a manner at once perplexing and unsatisfactory. Under such a system, the chief consolation of an outgoing tenant is often that, although he leaves money of his own in the soil, he found that of another man there when he came in; but the natural desire of each successive occupier not to run the risk of losing more than he gained from his predecessor, makes it quite certain that the land will have a tendency to deteriorate under a tenure so precarious, unless the prudence and liberality of the land-owner are sufficiently great to compensate for the restrictions which impede the enterprise of the tenant.

The description of yearly tenancy, which results from the occupier continuing in possession and paying rent after the expiration of his term, has not yet been mentioned, but that it can be created in this manner has long been settled law, nor will an increase in the yearly rent prevent the other terms of the former tenancy from being adopted. It is obvious, however, that only those stipulations can be incorporated into the new agreement which the law implies, that are in themselves consistent with and applicable to a yearly holding; and the adaptability of particular conditions to such an altered state of things has often been the subject of judicial decision. It has been held that a covenant to enable the tenant to retain and sow a certain quantity of the arable land with wheat at the seed-time next after the expiration of his term, with liberty to leave it standing till the next harvest and thresh it on the premises, is not incapable of application to a yearly tenancy. So of covenants that the tenant shall be paid for tillages at the expiration of his lease, that he shall leave all the manure for the use of the incomer, that he shall not take successive crops of corn, and that he shall follow a specified course of husbandry throughout his occupa-

Continuing  
tenancies.

tion. A tenancy from year to year, which is in this manner begotten by the law on an expired lease or agreement, is in reality not a tenancy by parol at all, and differs in no important particular from an ordinary yearly holding under the conditions of a written agreement, the consideration of which has hitherto been necessarily postponed. In such a case the terms of the holding are ascertainable with as much precision as in those tenancies which are created by a lease or an agreement extending over a term of years; and the sole feature in which it resembles the ordinary parol tenancy from year to year, consists in its liability to determination at the end of any year by the six months' notice which the common law prescribes. The operation of custom on such a tenancy is of course as frequently excluded by the conventional terms adopted by implication, as in all other cases where the parties rely for the determination of their rights upon the certainty and precision of a written instrument.

---

### CHAPTER III.

#### FORMS OF AGREEMENT.

IT is obvious that however satisfactory may be the results of a parol tenancy, defined only by the unwritten custom of the country and the limits of loose verbal stipulation, in isolated cases where landlord and tenant are alike anxious to preserve the relation which has arisen between them, and willing to hold themselves bound by a moral obligation though the legal definition of their rights may be insufficient, yet a tenure so primitive must be imperfectly adapted to the requirements of the country at large; and it would be indeed a matter for surprise if a more stringent and accurate mode of constituting a tenancy had not long ago been firmly established. To no description of contract is the old doctrine "*littera scripta manet*" more applicable than to that by which the relation of landlord and tenant is created, and the very fact that its operation is intended to extend over a period of time longer than that which most other agreements contemplate, is sufficient to render it most essential that some trustworthy record of its terms and provisions should be preserved. It was with this view that the Legislature enacted in the Statute of Frauds (29 Car. 2, c. 3), that no demises should be valid which were not put in writing and signed, except leases for a period not exceeding three years at a rent amounting to two-thirds at least of the full yearly value, and that demises which affected to do more than this should result in creating

Written agree-  
ments.

estates at will only. Such a tenancy at will is converted, as has been already stated, into a yearly holding by entry and payment of rent, but to confirm the tenant's right for a longer period a written document is absolutely necessary. Until the year 1845, this was all that was required to create an actual demise for a term of any length; but the Real Property Act (8 & 9 Vict. c. 106) then further provided that leases which the law required to be in writing should be void unless made by deed, that is, under seal, and the difficulty which had long been felt, of distinguishing between an actual demise and an agreement for a lease, was thus rendered of comparatively small importance. But as an actual lease gives the right to either party to sue on the covenants or terms contained in it, and enables the landlord to recover rent from the day of the demise without proof of entry or occupation, the distinction is still sometimes material. It is sufficient here to say that the test by which the Courts are guided in deciding the question is in all cases the intention of the parties deduced from the contract itself; and a clause providing that the instrument shall operate only as an agreement for a future lease, and not as a present demise, affords the simplest and most secure method of avoiding any uncertainty on the subject. It should be added that a lease void under the statute last mentioned, by reason of not being under seal, may nevertheless be good as an agreement for a future demise, the provisions of which may be enforced by either of the parties to it.

The terms of a tenancy, however they may have been determined, may be evidenced in any one of several different ways. They may be contained in a memorandum signed by the tenant only, which amounts in general to mere evidence of a parol contract; or in an agreement signed by both parties, which contemplates a future demise or lease; or in a document purporting to be a demise for a term, but valid only as a mere agreement by reason of its assuming to extend over a longer period than the three years allowed by the statute; or lastly, in an actual lease, which must be by deed if it falls within the condition just mentioned.

Forms of  
written contract.

(1.) *Memorandum of Terms of Tenancy.*—The first class of document generally takes the form either of a proposal to take, an acknowledgment by the proposed tenant of the terms of the holding, or a declaration as to the custom of the country. Any such instrument, if signed by the tenant alone, amounts, as has just been stated, to evidence of the agreement only, and does not by itself constitute a contract. If signed by the lessor also, it becomes a valid agreement, or—if for a short term and purporting to create the relation of landlord and tenant at once—even an actual demise, and in such cases must be properly

Memorandum  
of terms of  
tenancy.

stamped before it can be used in evidence. The convenience of any such imperfect memorandum of the terms of the holding appears very doubtful, since parol testimony is generally in strictness admissible to vary or add to the conditions expressed, and the certainty which is the chief object of employing a written instrument at all is thus unattainable. If this result is secured, the document at once becomes either an agreement or an actual lease, and might just as well have taken that form in the first instance.

Agreement for  
tenancy.

(2) and (3.) *Agreement for a future Demise.*—The distinction between this species of contract and a lease has been already pointed out; but the legal position of a tenant who enters either designedly under such an agreement, or under an instrument void as a present demise by reason of its exceeding the statutory term, is peculiar. He may at any time compel specific performance of the landlord's undertaking to let; and on refusal to grant or accept a lease, either party may bring an action against the other to recover damages for the breach of the agreement. But the mere fact that such an agreement has been entered into affords in itself no defence to an action of ejectment; and the tenant who has entered and paid rent on the faith of it has no direct defence except that provided by the common law, which constitutes him, as already explained, a tenant from year to year, whose holding can only be terminated by a six months' notice to quit. The conditions expressed in the agreement are in other respects considered applicable to his occupation; and in the majority of cases, other than those of a parol demise from year to year, both parties are content to acquiesce in the imperfect relation thus constituted until the expiration of the contemplated term.

Freedom of  
contract.

It is hardly necessary to observe that the perfect freedom of contract thus enjoyed by landlord and tenant, as by all other parties to an agreement, is absolutely essential for the protection of the rights of each, in a country where such varieties of soil, of climate, and of custom exist. No attempt at stereotyping a form of agreement, which should be applicable to all cases indiscriminately, could be otherwise than pernicious to the interests of agriculture in general. The very fact that the diversities of custom already mentioned have grown up, not merely in adjoining counties, but in adjoining districts and even parishes, is the strongest imaginable proof that compulsory uniformity, which has proved itself impossible in the experience of previous generations, would be found equally impracticable now. No general agreement could be devised which would not in some degree either exclude or adopt the customs which already exist; and as the customs so excluded or adopted were found to differ



in each successive district to which the system was applied, so the effect of its application would indefinitely and on no certain principle of variation be modified. It was the recognition of this truth which caused the Legislature, in dealing with some of the most important questions to which the usual stipulations of agreements and the requirements of agricultural custom apply, to provide that the Agricultural Holdings Act, 1875, should be permissive only in its operation. Under this Act (which will be more fully discussed hereafter) its provisions may be adopted or excluded in whole or in part in any written contract of tenancy. Practically, therefore, the same entire liberty of contract that was enjoyed before the passing of the Act remains still within the reach of both parties. It will probably be some time before the full effect of a statute which virtually amounts to the creation of a new and comprehensive agricultural custom, which may be negatived by stipulation like any other, makes itself generally felt. In one instance, which may be taken as a type of many, where landowners, though honestly desirous of establishing fair relations between their tenants and themselves, have shown a repugnance to having their agreements drafted for them by Act of Parliament, circulars were issued to the tenants explaining the alteration in the law, and suggesting that the voluntary system of agreements which had hitherto prevailed on the estate (Sir T. D. Acland's) should be adhered to. Most of the holdings in this case were under an agreement running from year to year, with covenants for and schedules of compensation on a definite scale, and with no clauses as to cultivation except such as reserved to the landlord a power to prohibit the sale of exhausting crops, and to fix a minimum limit for the acreage under green crops, and a maximum for corn. In cases where agreements of this character are actually in use, and have shown by results their sufficiency for the peculiar requirements of the district, the provisions of the Act will probably be found superfluous.

The stipulations that are usually contained in written agreements of tenancy need not here be discussed separately, since they differ in no respect, except as to the technical nature of the remedies by which they are enforced, from the covenants ordinarily inserted in a lease, and will be more conveniently considered under that heading. But it may be observed that just as it has been rendered necessary by the Legislature to exclude the Agricultural Holdings Act in express language, if it is not desired to incorporate it with the agreement, so the operation of the recognised local customs can only be avoided by express stipulation to that effect, custom being regarded by the common law as the substratum of all agreements which concern its

Exclusion of  
customs must  
be express.

peculiar province. It would no doubt be more generally advantageous to English agriculture if agricultural custom was an element less various in its operation, and capable of being ascertained with greater precision, but at present it is only impossible to escape from the uncertainty which universally attends it, by an agreement sufficiently full and precise to leave no room for its intrusion. The most safe and satisfactory way of accomplishing this object, is without doubt to establish the relation of the parties on a permanent and secure footing *ab initio* by means of a lease, the nature of which instrument is the next subject for consideration.

---

## CHAPTER IV.

### LEASES.

THE right of the absolute owner of land to demise its possession for any term, however long, at such rent as he may choose to accept, is one which affects his own interests alone, and has never been impeached; but the powers of those whose ownership is limited to the duration of their own life, or depends for its permanence upon any other contingency, have been from time to time the subject of legislative enactment. It is unnecessary to recapitulate the statutes which have been passed on the subject, from the earliest in the sixteenth century (32 Hen. 8 c. 28) until the present day, but the effect of the most recent legislation may be briefly stated. By the statute 19 & 20 Vict. c. 120 (1856), tenants for life under settlements made since that date may demise for any term not exceeding twenty-one years, at the best rent that can reasonably be obtained, and under certain other minor restrictions; and whatever the date of the settlement from which he derives his title, a tenant for life may make an agricultural lease for the same period by the special authority of the Court of Chancery (21 & 22 Vict. c. 77, s. 2). A similar privilege of demising land without application to the Court is given by the Act of 1856 to all persons entitled for the time being to the rents and profits or the possession, whether as tenant by the curtesy, tenant in dower, or holding in right of a wife who is seised in fee. Tenants by curtesy and in dower are simply widowers and widows, respectively, to whom the law assigns certain life estates in the lands of which the deceased wife or husband died possessed. Tenants in tail were formerly controlled by the statute of Henry VIII., which enabled them, under considerable restrictions, to demise land which had been usually let for agricultural purposes; but such leases were binding only

Leasing powers  
of life tenants.

upon the lessor's issue, and not upon those entitled in remainder or reversion. This statute was, however, repealed by the Act for abolishing Fines and Recoveries in 1833 (3 & 4 Will. 4, c. 74), which conferred upon tenants in tail general powers of making a valid lease for a term not exceeding twenty-one years, provided that a rent was reserved amounting to two-thirds at least of the rack-rent at the time of the demise. The leasing powers of ecclesiastical corporations and incumbents of benefices are similarly regulated by a series of enactments reaching from 1541 (32 Hen. 8, c. 27) until the present day, a recapitulation of which would be of little interest.

A lease is simply a contract by which the right to the possession of land is immediately transferred, and the relation of tenancy constituted, without the necessity of any further condition, such as entry and occupation, being fulfilled. No formal words are essential to its validity, and although the phrase "*demise, grant and to farm let*" is usually employed, any terms sufficiently indicating an intention to transfer the possession at once for a determinate time will be effectual. At common law, indeed, not even writing was necessary, and except in the cases mentioned below, a lease may still, strictly speaking, be effected by parol. The Statute of Frauds (29 Car. 2, c. 3), as already mentioned, first enacted that all leases, except such as did not exceed the term of three years from the date of making, with a rent reserved amounting to at least two-thirds of the full annual value, should create estates at will only unless made in writing; and by a later enactment (8 & 9 Vict. c. 106) all leases required by law to be in writing will be void unless made by deed. The operation of a lease, rendered void under this statute, as an agreement, and the general distinction between the two classes of instrument, has been also mentioned.

The legal characteristics and requirements of a valid lease having thus been indicated, the nature of the contract of tenancy arising from it must next be considered. It has been said that the essence of such a contract is that the right to the possession of the land should be at once irrevocably transferred to the tenant, in consideration of a certain rent; but the possessory right thus acquired is subject to a variety of conditions, which bind the lessee throughout his occupation. The covenants or formal stipulations which are most usual and most necessary in the instruments which constitute the relation of tenancy, there being little practical difference in this respect between leases and mere agreements, may be divided into several leading classes.

1. *Covenants by the Tenant for the Fulfilment of those Obligations to the Landlord which are the direct and necessary results of*

Legal effect of lease.

Tenant's covenants.

*the creation of the Tenancy.*—Under this head come the tenant's undertaking to pay the agreed rent, to insure the farm-buildings, to keep in repair, not to commit waste, not to assign or under-let, and to give up possession when the term is by effluxion of time or in any other way determined. Of these it is only necessary to say that they are either implied by the law, and inserted only as a matter of prudence, or else so usually required that their omission from the instrument creating the tenancy occurs only in exceptional cases. The common stipulation against breaking up old grass-land, being intended to insure that the land shall be given up in the same state as that in which it was taken, may also perhaps be classed under this heading; though from another point of view it may be regarded as belonging to that group of conditions which prescribe the mode of cultivation. It is generally considered unsafe to omit a clause to this effect, unless the tenant is thoroughly to be relied upon; but, like all restrictive covenants, it is no doubt prejudicial to the interests of an honest and enterprising occupier, though the landlord may have good reasons for insisting on it. The covenant against assigning or under-letting the subject of demise, though generally regarded as essential, is not included in a provision for all usual covenants, and must be specially stipulated for. The most general mode is to provide that the term shall be forfeited, and the landlord acquire a right of re-entry, upon any assignment or under-lease by the tenant without his license in writing. It is obviously essential to the protection of the landlord's interests that his land shall not be allowed to pass into the possession of a stranger, of whose solvency and agricultural skill he is entirely ignorant.

2. *Covenants which regard the Mode of Culture.*—These refer, first, to the rotation of crops and manner of tilling generally; and secondly, to the obligation which is very generally imposed of consuming upon the farm all the hay, straw, and green crops produced, so as to insure their return to the soil in the shape of manure. Of those which come under the first head, the limits of this paper will allow only a brief mention, but it may be said that they vary in different parts of the country more than perhaps any other of the usual terms of tenancy. Crops for this purpose may be regarded as belonging to four main classes, white or corn crops, fallow, seeds, and forage. A certain amount of rotation is secured by agreeing that these shall follow each other in a prescribed order, white crops and crops grown for seed being regarded as exhausting to the land and the others as beneficial. A four years' course is the most regular, but a shorter rotation is sometimes adopted, and in rarer cases, a five-yearly or even a six-yearly course of crops is prescribed to the tenant. The

Covenants as  
to husbandry.

simplest mode that is at all general is to stipulate merely against taking two successive corn crops from the same land; but with a good tenant, who brings capital and experience to his holding, it is doubtful whether any restrictions are really necessary; and recent experiments on the possibility of continuous corn cropping indicate that the whole system of dictating any rotation at all to the occupier may possibly prove an economic mistake. Two modes have been suggested by which trustworthy tenants may be left practically unfettered, without the interests of the landlord being appreciably imperilled. The first is by adopting a form of lease or agreement given as peculiarly favourable to the occupier in Cooke, "On Agricultural Tenancies" (p. 421), in which general covenants for good husbandry and compensation to the land in the form of artificial manure for all natural manure, hay, or straw taken off it, are added to a proviso for re-entry by the landlord in case the tenant shall be adjudged by arbitration to be persisting in an injurious system of culture. The other mode is that indicated in a paper published in the Royal Agricultural Society's 'Journal' (vol. viii. p. 256), according to which the tenant merely covenants to fatten an agreed amount of live-stock on his farm every year, and to consume on it all the manure produced; a suggestion which has not met with general acceptance. The stipulation with regard to the materials of manure, as already mentioned, is most frequently relaxed when the holding is near a large town, which offers a ready market for their sale, and from which artificial manures may be easily obtained to compensate the land for the productive power thus taken away from it.

3. *Covenants which contemplate the Surrender or Termination of the Tenancy.*—Since the interests of landlord and tenant become directly opposed to each other as soon as the last year of the term commences, or when the tenant receives notice to quit, stipulations are commonly inserted in a lease to prevent the latter from leaving the land in an impoverished condition, and to prescribe the acreage which must be left in corn or fallow (usually at least one-half of the arable land to be left in green-crops or fallow), for the incoming tenant. A general covenant to cultivate according to the rules of good husbandry up to the time of quitting, together with an arbitration clause, ought with a good tenant to be found sufficient; and the rights of pre-entry for purposes of tillage, which are to be given to the incoming occupier, may either be left to the operation of the local custom, or provided for by special agreement. It may be added that cultivation according to the rules of good husbandry is not an obligation which the common law implies, or which is included in the ordinary covenant against committing waste. End of tenancy.

Payments to  
outgoing  
tenant.

The question of the payments to be made to an outgoing tenant, either by the landlord or the incomer, is a most complex one. The allowances for growing crops are of comparatively small importance, their value being always readily ascertainable, and the tenant having generally received, at the commencement of his tenancy, the benefit of any imperfections which exist in the customary or conventional terms of the holding. The really important question refers to the unexhausted value of the manure which has been expended on the land, and the capital which has been sunk in drainage and other permanent improvements; but the discussion of this subject finds its proper place under the heading of the Agricultural Holdings Act.

Landlord's  
covenants.

4. *Covenants by the Landlord.*—Certain of the landlord's usual covenants refer to the subject of tenants' compensation which has just been alluded to; but in addition to these, the tenant generally stipulates for quiet enjoyment, which protects him from eviction or disturbance by the landlord or any one claiming under him, and gives him a remedy by action in case the lessor's title should prove defective, where not expressly limited so as to exclude this right. The mode and time of entry on the lands demised are also very frequently the subjects of special agreement, though it is often said that these are matters more suitable than any others to be decided by the custom of the country. The incoming rights of one tenant are so closely connected with the outgoing rights of another, and vary so widely according as the tenancy is to commence at Lady-day or at Michaelmas, that it is impossible to treat of them adequately in detail. Where the custom is not dispensed with by the agreement, they will be controlled by it; but where the contract between the parties excludes the operation of customary rules, as well as the provisions of the Agricultural Holdings Act, the parties may of course regulate the conflicting rights of the incomer and outgoer in the manner they deem most suitable to the requirements of the holding.

Arbitration.

From the foregoing brief summary of the usual conditions of a tenancy depending upon a written instrument, it will be seen that, however carefully the terms may be expressed, some difference between landlord and tenant is at least a possible contingency. In contemplation of such an event, and also to provide a method of valuing the compensation to be paid to the outgoer on the termination of the tenancy, special clauses for the appointment of arbitrators or an umpire are frequently inserted. The effect of such provisions at law has long been a subject of litigation, but it appears to be now settled that where the agreement is that either of the parties shall pay a certain sum only after it has been ascertained in a particular manner, no legal



proceedings can be brought until this condition has been complied with. On the other hand, a bare agreement to refer does not take away the common law right of either party to appeal to the ordinary tribunals of the country; though an action will lie against one who adopts this course instead of submitting to arbitration, for breach of his agreement.

These remedies are sufficient to meet the ordinary and legitimate differences which occur between landlord and tenant, but cases will occasionally arise where the landlord's ground of complaint demands a more summary removal. The penalty of forfeiture, which confers upon the landowner the right of re-entry in specified cases, may be attached to any of the usual covenants; and the common form of proviso generally employed has in fact this extensive operation. Essential as this provision is for the security of the landlord against an insolvent or incompetent tenant, it is obvious that its strict enforcement would in many cases result in extreme hardship to the occupier who had inadvertently or carelessly incurred so grave a penalty; and the rules of equity, now adopted by the common law, have always construed such a condition in a lease or agreement of tenancy in a liberal spirit. If the breach of covenant alleged by the lessor is not wilful or really detrimental to the property, and if the damage occasioned by it is capable of fair assessment and pecuniary compensation, the English courts will in general relieve the occupier against the forfeiture he has incurred, taking care that the landlord is not a pecuniary sufferer by his misdoing. Even with this modification, the proviso for re-entry in case of forfeiture is a serious weapon in the hands of the landlord; and it may be added, that the ordinary right of the outgoing tenant to emblements or growing crops is forfeited with the rest of his estate. The discussion of the cases in which the landlord's right of re-entry is absolute, as indeed of the other remedies by which the stipulations contained in a lease may be enforced, would alone be sufficient to occupy a treatise of no inconsiderable extent.

---

## CHAPTER V.

### THE AGRICULTURAL HOLDINGS ACT.\*

THE year 1875 marks a new point of departure in English agriculture. We have seen that by far the greater part of the

---

\* The review of this Act is founded mainly upon a Paper by Frederick Clifford, of the Middle Temple, Barrister-at-Law, published in 'The Journal of the Royal Agricultural Society' for March, 1876, and since reprinted (London: Clowes and Sons, Charing Cross).

Farmers.

soil in England is tilled by farmers. These were men who (as the name imports) in the earlier history of agriculture were little more than the bailiffs or agents of the landowner, holding his land at will, and handing over to him its surplus produce in the form of a money rent, or in kind. Money rents have long since become in England the almost invariable return given to the landlord by the farmers, who, under lease or by agreement, become entitled to the usufruct. In a few districts there is a corn rent, or the rent is paid half in money, half in corn, but these are rare exceptions to the general rule. As was natural from the origin of the laws which governed the relations between landlord and tenant, the landlord's rights from the first were large, well-defined, and comparatively easy to enforce. On the other hand, the rights of the farmers whom he allowed at his mere will to cultivate the soil were indefinite and of slow growth. Following the harsh maxim of the Roman law, they could remove no buildings which they had once placed on the land they hired: and the very tree, the plant, and the seed which they placed in the soil became not theirs, but the property of the landlord, as soon as it had taken root.

Legal doctrine  
as to emble-  
ments.

The first relaxation of this rule in favour of English tenants at will is found in the Common Law doctrine as to emblements (*fructus industriales*). The word emblements means, in strictness, growing crops of corn, but was gradually enlarged so as to include roots planted, and other annual products of agriculture. The English Courts of Law founded their decisions not on statute, but mainly on reasons of public policy, since it is for the common benefit that reasonable encouragement should be given to agriculture. "If, therefore," says Sir W. Blackstone, "the tenant-at-will sows his land, and the landlord, before the corn is ripe or before it is reaped, puts him out, yet the tenant shall have the emblements, and free ingress, egress, and regress, to cut and carry away the profits. And this for the same reason upon which all the cases of emblements turn, viz. the point of uncertainty; since the tenant could not possibly know when his landlord would determine his holding, and therefore could make no provision against it; and having sown the land, which is for the good of the public, upon a reasonable presumption, the law will not suffer him to be a loser by it." And again: "The tenant . . . shall have the emblements to compensate for the labour and expense of tilling, manuring, and sowing the lands, and also for the encouragement of husbandry, which, being a public benefit, tending to the increase and plenty of provisions, ought to have the utmost security and privilege that the law can give it. Wherefore, by feudal law, if the tenant for life died between the beginning of September and the end of

Founded upon  
public policy.

February, the lord who was entitled to the reversion was also entitled to the profits of the whole year; but if he died between the beginning of March and the end of August, the heirs of the tenant received the whole. And from hence our law of emblements seems to have been derived." The doctrine of emblements, as Blackstone elsewhere explains, extended only to corn sown, roots planted, or other annual artificial profit. It is otherwise of fruit trees, grass, and the like, which are not planted "annually at the expense and labour of the tenant, but are either a permanent or natural profit of the earth; for when a man plants a tree he cannot be presumed to plant it in contemplation of any present profit, but merely with a prospect of its being useful to himself in future, and to a future succession of tenants." Here, then, in the doctrine of emblements, we have a first legal recognition in England of tenant-right; and when husbandry was rude, and could hardly be said to exist as an art, there was no great hardship in a rule which secured to the husbandman, with certain limitations, the crops of the year, but gave him no farther rights in the soil. The year's crops would represent pretty accurately the return to which he was entitled for his industry; unexhausted improvements would be to him words without meaning.

Gradually, as some amount of capital and skill came to be imported into English agriculture, there arose a variety of local customs already mentioned, recognising the tenant's claims, on the termination of the tenancy, to compensation for tillage and manures, the benefit of which then remained in the land, wholly or in part. This varying compensation was paid by the landlord or, more generally, by the incoming tenants, and such payments were recognised and enforced by the Courts of Law. It was unequal, of course, but that the farmer became entitled to any compensation at all is the main fact of interest in our present retrospect.

Local custom was thus enforced by Courts of Law long before it was embodied in statute, or was recognised by the English Legislature. It therefore softened in practice the precariousness of tenure, and the application of the rigorous rights of ownership over the soil. In Lincolnshire local custom came to be especially favourable to the tenant, and there, accordingly, farming attracted men of the greatest skill and with the largest capital, and agriculture reached probably its highest perfection in England. The result was seen to be of equal benefit to landlords and to tenants. Farmers knew that, if disturbed in their occupations, they would receive a fair proportion of the capital they had invested in the soil, and therefore put their money into the land, in the shape of labour and manure, without

hesitation. On the other hand, rents were paid more punctually, and were increased at intervals without much complaint; while the community benefited from the tenant's enterprise, which furnished more abundant crops, and filled the markets with fat sheep and cattle.

Legal  
presumption  
against.

Thus we have seen that the principles of English law were against the right of a tenant to any interest in the soil farmed by him, even though created by his own capital, labour, and skill. The presumption was that all things annexed to the soil, or indistinguishable from it, belonged to the landlord. This general presumption, it has been shown, was limited only by the rule as to emblements, and by the prevalence of local custom, the Legislature recognising no right on the part of the tenant to what was termed the unexhausted improvements made by him at the end of his tenancy. It was felt at length that the new interests which had sprung up in the soil should not be left to the good feeling and forbearance of any class, however well-disposed, as a rule, they might be towards the persons dependent upon them. After repeated discussion, therefore, and prolonged inquiry by Select Committees, Parliament adopted, in 1875, the principle so often insisted upon, that a tenant should be encouraged to invest his capital in the soil by having statutory security for so much of that capital as may be reasonably supposed to remain in the soil at the end of his tenancy. This is what is known in England as the tenant's interest in unexhausted improvements made by him. Such was the object of the Act we are now considering\* and its leading principle will be best understood when we state that it is based upon freedom of contract. The Act is permissive, not compulsory, and recognises throughout its provisions the perfect competency of tenants as well as landlords to manage their own affairs and make their own bargains. If they think fit to exclude the operation of the Act altogether, they are free to do so by written contract, and each may, as heretofore, make the best terms he can for himself, or lay down the conditions which in his opinion best meet his own case. If the tenant chooses to forego all claims to compensation, he may do so; on the other hand, he may exact more liberal compensation than any which the Act allows. If the landlord assents, both may contract themselves entirely out of the Act in either case, for nothing in the Act prevents a landlord and tenant, or persons contemplating this relation, from making any agreement they think fit, or will interfere with the operation of such agreement (Section 54).

First recogni-  
tion of, by  
Statute.

Its permissive  
character.

As the freedom of contract just described existed before the

\* 'The Agricultural Holdings (England) Act, 1875' (38 & 39 Vict. cap. 92).

Act was passed, it may be asked, what new rights does the Act secure to tenants? The answer is, that whereas, in the absence of contract or custom, the presumption of law used to be that unexhausted improvements belong to the landlord, the Act now reverses this presumption, and assigns the property in such improvements to the tenant, to the extent defined and limited by the Act itself. This change in the principle of the English law is of considerable importance in itself; but there is good reason for believing that its influence in guiding and determining the practice of landlords and the conditions of tenancy will be more considerable still. We pass, however, now to the provisions of the statute, confining our attention to its leading features.

Unexhausted improvements assumed to be the property of tenant.

Though it became law in the Session of 1875, the 'Agricultural Holdings Act' did not come into operation till February 14 in the following year. It does not apply to holdings which are non-agricultural, or which are under two acres in extent. All new tenancies of agricultural or pastoral lands, or of lands in part agricultural and in part pastoral, comprising more than this acreage, are subject to the provisions of the Act, unless there is a written agreement to the contrary, signed by the tenant as well as by the landlord or his agent. If no such agreement is come to between the parties, the Act will govern the conditions of the holding, whether it be a tenancy at will, or one from year to year, or for a term of years, or for lives. Tenancies existing before February 14, 1876, are not affected by the Act, provided they are tenancies under lease, or for lives; but all tenancies from year to year, or at will, were brought under its provisions, unless either the landlord or the tenant gave notice, two months after the date mentioned, that he desired that the existing tenure should remain unaltered by the Act. Thus, if both parties were silent, the new law, as in the case of new tenancies, immediately stepped in to regulate the relations of landlord and tenant, and establish the tenant's right to the prescribed compensation.

Application of Act.

Having thus shortly explained the easements to which the Act applies, we may now examine somewhat more fully the provisions which govern a tenant's title to compensation for the improvements he has made in his holding. These are divided into first, second, and third class improvements, each class being subject to different conditions; and all must have been executed after February 14, 1876. Here, then, is fixed the new era in English farming. Before this period all such improvements, though made with the tenant's capital, were the property of the landlord, subject only to any contract entered into between the parties, or to the local customs already mentioned. Since

Tenant's title to compensation.

then, the law presumes them to be the property of the tenant, for which he is entitled to certain money compensation at the end of his tenancy, unless he has himself consented to waive this right, or to vary it otherwise than as provided in the Act. The subjects of compensation are thus specified:—

First-class improvements.

*As to First-Class Improvements.*—These are thirteen in number, and come under the head of permanent improvements, for which the highest scale of compensation is awarded. They are ranged in alphabetical order, thus:—

- |   |  |
|---|--|
| <ol style="list-style-type: none"> <li>1. Drainage of land.</li> <li>2. Erection or enlargement of buildings.</li> <li>3. Laying down permanent pasture.</li> <li>4. Making and planting osier beds.</li> <li>5. Making water-meadows, or works of irrigation.</li> <li>6. Making gardens.</li> <li>7. Making or improving roads or bridges.</li> </ol> | <ol style="list-style-type: none"> <li>8. Making or improving water-courses, ponds, wells, or reservoirs, or works for supply of water for agricultural or domestic purposes.</li> <li>9. Making fences.</li> <li>10. Planting hops.</li> <li>11. Planting orchards.</li> <li>12. Reclaiming waste land.</li> <li>13. Warping land.</li> </ol> |
|---|--|

Their presumed duration.

The Act presumes that these thirteen improvements continue unexhausted for a maximum period of twenty years. But the legal presumption may be rebutted. In all cases of dispute, valuers are to be appointed, and it is for them to make an award in the case of each improvement and each class of improvement, and to decide whether, at the time the tenancy ends, the particular improvement is or is not exhausted. In no case can the tenant claim compensation for an improvement after the maximum period specified in the Act as applicable to each class. Nor does a tenant acquire by virtue of the Act an absolute vested interest extending over this maximum period. His interest is conditional, depending upon what is decided to be the unexhausted value of the improvement when the tenancy determines. Of course it is open to the landlord and tenant by special agreement to fix prospectively the period during which the improvement shall be deemed unexhausted, instead of leaving that matter to be dealt with retrospectively.

The tenant's claim for compensation in respect of the thirteen improvements of the first class *may* continue for twenty years, dating from the end of the year of tenancy during which the outlay has been made. Thus, assuming that the year of tenancy upon a holding to which the Act applies expired at Michaelmas, 1876, and any one of these thirteen improvements were made upon this holding, with the safeguards and conditions imposed by the Act, between February 14 and Michaelmas, the twenty years began to run with the next year of tenancy, 1876-7.



In dealing with an absolute owner, the basis of the tenant's compensation is the cost price of each improvement, with a proportionate deduction for each year subsequent to that in which the outlay is made, until either the term of twenty years expires, and the improvement thus becomes, in a legal sense, exhausted; or until the period of actual exhaustion fixed by the valuers in the particular case. Thus, the longer the tenancy continues, the smaller the compensation which falls to be paid by the landlord. Assuming that the improvement is one which, in the valuer's opinion, remains unexhausted during the full term limited by the Act, the tenant will be entitled to receive back again, out of the land, in twenty equal yearly instalments, the money which he put into or upon the land; and if he leaves his holding before the end of twenty years, and is thus unable to recoup himself, the landlord will become bound to pay the instalments which may remain due. Obviously also, if the tenancy continues for twenty years, dating from the end of the year of tenancy in which the outlay is made, no compensation can be claimed. It is as though the tenant had lodged to his credit in a bank a capital sum, to be drawn out in given proportions within a limited term by the occupier for the time being; and by length of occupation he himself may exhaust the credit. Of course care is taken in the landlord's interest that the improvements when taken over by him are "in tenantable repair or good condition;" and the sum found due to the tenant may therefore be reduced by "any sums reasonably necessary to be expended" in putting the improvements into this condition.

If the landlord is absolute owner.

There is an important limitation to the rule as to the amount and duration of the tenant's claim. He can demand no compensation for a first-class improvement, unless he has made such improvement with the previous consent, in writing, of either landlord or agent. Again, it must be noted that compensation for a first-class improvement is given upon the foregoing basis only if, at the time when such consent was given, the landlord was the absolute owner of the premises. It is, therefore, the business of the tenant, upon asking and receiving the landlord's consent to make any one of the thirteen permanent improvements, to ascertain also whether the landlord is such "absolute owner," that is to say, whether he is "capable of disposing, by appointment or otherwise, of the fee simple or whole interest of or in freehold, copyhold, or leasehold land." If he be freeholder, copyholder, or owner of leaseholds, then it is immaterial to what extent his land may be mortgaged, encumbered, or charged; he is "absolute owner" for the purposes of the Act, and the tenant will have a lien upon the

Previous consent of landlord.

land for the repayment of so many of the twenty or other less number of instalments as still remain due.

If landlord's ownership is limited.

"Letting value" of holding must be increased by tenant's improvements.

If the landlord has not this disposing power over the land— if, for instance, as in the ordinary case of settled estates, he holds them merely for life—then the tenant's claim to compensation is further limited by the principle of "letting value." The compensation is then not to exceed "a capital sum fairly representing the addition which the improvement, as far as it continues unexhausted at the determination of the tenancy, then makes to the letting value of the holding" (§ 7). This new principle introduces an additional element of uncertainty into the measure of compensation. The cost price of an improvement is easily ascertained, and the assignment of the number of years for exhaustion may not be difficult. But there is more room for difference of opinion and for dispute upon the question whether the improvement has added to the letting value of the farm, not when such improvement was originally made, but in its state of greater or less exhaustion at the end of the tenancy. In dealing with a limited owner, therefore, tenants have not the same security for unexhausted improvements as they possess in dealing with an absolute owner. In the latter case, the tenant receives back the capital he spends, either in money or in kind,—in kind so long as his holding lasts; in money when the holding is determined, if the improvement is found to be unexhausted when the claim arises. In dealing with a limited owner, he still receives back, during the tenancy, what the land or occupation yields to him in kind for the improvements he has made; but at the end of the tenancy, instead of receiving back the amount of his outlay, less a proportionate part for each year up to the period of exhaustion, he must prove that the letting value of the holding is increased by this particular improvement: his compensation in money depends upon the additional rental which the improvement will yield in the remaining years (within each maximum period fixed by the Act) during which it will be deemed to continue unexhausted. The extent to which the improvement adds to the letting value of the holding is to be decided, in case of dispute between the parties, by the referees or umpire, for whose appointment provision is made in the part of the Act relating to procedure.

Questions as to tenant's outlay.

As the tenant is entitled to payment from the absolute owner of "the sum laid out" on the improvement, less a proportionate part for each year during the period of exhaustion, it follows that, when the claim arises, the landlord can raise no question upon the economy or extravagance of the particular outlay. It may be that a tenant has spent more money than he need have

spent had he used the proper means, or set about the improvement in the most economical method; but the landlord cannot dispute the amount ascertained and vouched for as having been spent by the tenant. As, however, the landlord's consent must be asked before an improvement of the first class can be made, he can always protect himself by limiting the sum to be spent upon the improvement, or the period during which compensation can be claimed; or he may require that the work shall be executed under inspection. As will presently be seen, another principle is applied to compensation for second- and third-class improvements, and the landlord is protected by the words of the Act against any undue expenditure upon them.

*As to Improvements of the Second Class.*—These improvements, though not permanent, are durable, and, unless the valuers think the improvements are exhausted when the tenancy determines, or will be exhausted before the maximum period mentioned in the Act, the tenant is entitled to compensation for them for seven years following the year of tenancy in which his outlay is made. Second-class improvements are six in number, specified as follows:—

- |   |                     |
|---|---------------------|
| 1. Boning of land with undissolved bones. | 4. Claying of land. |
| 2. Chalking of land.                      | 5. Liming of land.  |
| 3. Clay-burning.                          | 6. Marling of land. |

Thus, if one of these improvements be made at any time during the year of tenancy ending Michaelmas, 1876, the seven years begin to run with the next succeeding year, and the claim to compensation will cease after Michaelmas, 1883. But, as in the case of first-class improvements, the landlord's liability does not necessarily continue during the seven years. It depends upon the period of exhaustion as found by the valuers. In the Act the rule applicable to the tenant's compensation for second-class improvements (§ 8) follows, with the exception of one important word, the rule laid down in the case of first-class improvements made under an absolute owner. For the latter class of improvements the tenant, as we have seen, is entitled to "the sum laid out" by him, less a proportionate part of this sum for each year after the improvement was made up to the period of exhaustion. But a tenant's claim for second-class improvements can only be for "the sum *properly* laid out" by him, with a proportionate deduction for each subsequent year during which his occupancy continues and the improvement remains unexhausted. The language of Section 8 does not permit a landlord to dispute the propriety of this particular kind of improvement. Proof that the tenant has spent his money is

Improvements  
of second class.

Duration of  
tenant's claim  
for.

proof of the necessity of such an improvement and of the title to compensation for it. But the landlord may seek to reduce the claim on the ground that too much has been done; that the work of boning, chalking, marling, &c., has been injudiciously carried out, or has proved partially ineffectual through want of proper skill or care.

Landlord's  
prior consent  
to, not neces-  
sary.

Notice.

The reason why it is competent for the landlord under § 8 to question whether the sum spent by the tenant has been "properly laid out" is to be found in another distinction drawn in the Act between the two classes of improvements. If the tenant chooses to make a second-class improvement he need not obtain the previous consent of the landlord, and may establish a conditional claim even contrary to the landlord's express wish. All he is bound to do (§ 12) is to give the landlord notice, not less than one week and not more than six weeks beforehand, of his intention to make the improvement. This notice gives the landlord the opportunity of inspecting the work done, and of seeing that it is properly done, though the Act provides no machinery for such supervision. The notice also gives the landlord the opportunity of at once stopping the improvement by giving the tenant notice to quit, because there is an express provision that the tenant can no longer claim compensation for second-class improvements executed after receipt of notice to quit (§ 12). Moreover, if the tenant has either given or received notice to quit, he is forbidden to make any of the six improvements unless he receives the landlord's written consent (§ 12). Thus no tenant under notice can commit the landlord to an expenditure which will mainly fall upon the latter, and which will certainly set up a troublesome claim, and perhaps end in expensive litigation. A tenant under notice can have no right to farm for his successor, and compel his landlord to contribute possibly six-sevenths of the money.

Assessment in  
respect of.

Claims for improvements of the second class are to be assessed upon one basis only—that laid down by the Act in the case of absolute owners. They are not affected by the status of the landlord. How much, therefore, or how little they have added to the letting value of the holding is immaterial. If the referees find that the improvement is good for the full term of seven years, the claim for a second-class improvement abates every year by one-seventh of the amount "properly laid out" upon such improvement, beginning with the year of tenancy in which the outlay is made. But the amount of compensation awarded varies, of course, with what is found to be the "life" of the particular improvement, as in the case of improvements of the first class.

Third-class  
improvements.

*As to Third-Class Improvements.*—These fall within the

category of temporary improvements, and are placed under the two following general heads:—

1. Application to land of purchased artificial or other purchased manure.
2. Consumption on the holding by cattle, sheep or pigs, of cake or other feeding-stuffs not produced on the holding (§ 5).

These improvements may continue unexhausted, and therefore remain the subjects of compensation, till the end of two years following after the year of tenancy in which the outlay is made (§ 6). The amount of compensation in respect of them is “such proportion of the sum *properly* laid out by the tenant on the improvement as fairly represents” its value to the incoming tenant at the end of the tenancy (§ 9). Upon the proper laying-out of the money upon manure and feeding-stuff will depend the benefit to the new tenant, and therefore these two questions practically resolve themselves into one for the consideration of the valuer.\*

Hitherto we have found the Act requiring as a condition precedent to compensation for first-class improvements consent by the landlord, and in the case of second-class improvements notice to the landlord. The tenant is relieved from both these conditions in the third description of improvements, and it would be obviously impossible to require either condition from him as a preliminary to the manuring of his land or the feeding of his stock. This would be to make the landlord the farmer. Still there are important reservations to his power of claiming compensation. No such claim, for example, can be made if, after the manure has been applied or the stock has been fed on the particular land so treated, he has taken from this portion of his holding “a crop of corn, potatoes, hay, or seed, or any other exhausting crop” (§ 13). Again, he is not entitled to compensation for the consumption of cake or other feeding-stuff where, under custom or agreement, he claims payment from

Period of duration.

Consent and notice to landlord, not required.

Exceptions to tenant's claim.

\* The first question which the valuers will have to face is the proportion of the original cost which may “fairly represent the value of the improvement, at the determination of the tenancy, to an incoming tenant.” An approximation to this value for cake, bones, &c., has long been made by clauses in agreements, and by custom in Lincolnshire, Nottinghamshire, and other counties. Mr. Lawes, in his valuable contributions to the ‘Journal of the Royal Agricultural Society,’ has given a reliable testimony to the unexhausted value of manures applied under certain conditions; and it would, undoubtedly, be a matter of congratulation to valuers and to the agricultural public if investigations of a similar character could be carried out under other and varying conditions of climate and of soil. But even now, with the limited information we possess, I am inclined to think that practical men, taking into consideration the customs of their own counties, and guided by the direction of the Act, will not find any insuperable difficulty in the construction of this clause; and I believe that in many cases, if difficulty should be anticipated, agreements will be made between landlord and tenant which will define in terms the proportionate payments to be made.—*Note by Mr. J. D. Dent, of Ribston Hall, Wetherby, in Royal Agricultural Society's ‘Journal,’ March, 1876.*

the landlord or incoming tenant for "the additional value given by that consumption to the manure left on the holding at the determination of the tenancy" (§ 14). Thus, where the Act applies, a tenant may claim for artificial manures under the Act, and for consumption of feeding-stuffs either under the Act, or under agreement or custom, at his option.

Conditions of compensation.

Two other important restrictions govern the claim. First, in ascertaining the amount due to the tenant, he is not credited with any larger outlay during the last year of his tenancy than the average amount of his outlay for like purposes during the three preceding years, or during any shorter period if his tenancy has not lasted so long (§ 15). Thus if he spends on manure and cake or feeding-stuff 800*l.* in 1876-7, 700*l.* in 1877-8, 654*l.* in 1878-9, and 800*l.* in 1879-80, when the tenancy expires, the basis of compensation in respect of the last year's outlay will not be 800*l.* but one-third of 800*l.*, 700*l.* and 654*l.* added together, or 718*l.* The object of this limitation is to prevent a disproportionate expenditure upon artificial manure or cake in the last year of the tenancy.

The second restriction is that if any hay, straw, roots, or green crops have been sold off the holding within the last two years of the tenancy, the estimated value of the manure that would have been produced by the consumption of these growths on the holding is to be deducted from the compensation claimed, "except as far as a proper return of manure to the holding has been made in respect of such produce sold off" (§ 15). In other words, the land rented has a first claim upon the crops here specified, and provision is made for their return to the soil in the shape of manure, or for an equivalent return from bought manure or from purchased feeding-stuff. This equivalent must be rendered before the bought manure, and the cake or feeding-stuff used during the same period, can count to the credit of the outgoing tenant.

Like the tenant who makes a second-class improvement, the tenant making a third-class improvement is exempt from the necessity of considering the nature of his landlord's interest in his property, and his compensation is the same under any tenure. In estimating his compensation, it is for the valuers to decide as best they can what proportion of his outlay "fairly represents" to his successor the value of the manuring and stock-feeding of the two previous years. The farmer must therefore be careful to keep accounts and vouchers, which will serve as the basis of valuation in case he quits the holding.

General conditions affecting

Having examined the subjects of compensation under the Act, we may now notice the general conditions affecting landlord and



tenant. The claim of the latter to compensation for any class of improvements is subject to deductions :

(1.) For taxes, rates, and tithe rentcharge to which the tenant is liable as between himself and the landlord. (2.) For rent (§ 16). (3.) The value of any benefit (such as surrender of rent, supply of materials, &c.) which the landlord has given or allowed to the tenant as a consideration for his making the improvement at his own expense (§ 17). (4.) Compensation claimed by the landlord at the end of the tenancy for waste committed or permitted by the tenant (§ 19); and (5.) Compensation claimed by the landlord for the breach by the tenant of any covenant in the lease or agreement under which the tenant holds (§ 19).

The landlord's statutory claim to compensation under the two last heads can only be made if the tenant claims compensation under the Act for an improvement. The landlord must allege the waste or the breach by way of counter-claim, "and not otherwise" (§ 19). Again, the landlord's counter-claim cannot go back more than four years before the tenancy ends: any waste or breach of covenant alleged by him, if it relates to acts of commission or omission in a matter of husbandry, must have occurred within this period (sub-sect. 19). This proviso is a safeguard against the revival of old defaults which the tenants, owing to the remoteness of the acts or the neglect relied on, may find it difficult to rebut. In the event of waste alleged in respect of buildings, and matters not relating to husbandry, the four years' limitation does not apply.

*Procedure.*—The tenant's claim must be made in writing one month at least before the tenancy determines, and he must then furnish "as far as reasonably may be, the particulars of the intended claim." Upon bankruptcy this claim passes to the tenant's assignees, who may urge and realise it for the benefit of the estate. The landlord's counter-claim, if any, on account of waste or breach of covenant, must be made within fourteen days after receiving the tenant's notice of claim. If the parties do not agree upon the amount and time of payment of compensation, the differences between them must be settled by reference to some person who may be jointly appointed by them; or if they cannot agree upon a single referee, each chooses one. These referees are to estimate the unexhausted value of the tenant's improvements. Before doing so, they must appoint an umpire to decide between their respective awards. If they fail to make such appointment, it may be made by the Judge, of the County Court of the district; or either party may call on the Inclosure Commissioners, or the County Court Judge to make such appointment, without leaving it to the referees. Having once submitted to the reference, neither party can withdraw from it, or

landlord and tenant.

Deductions from tenant's claim.

As to landlord's claim under statute.

Procedure in establishing claim.

Referees.

Umpire.

Powers of referees.

if he does so, the referees, or the umpire, may proceed in his absence. They can "call for the production of any sample, voucher or other document, or other evidence which is in the possession or power of either party, or which either party can produce." They may also take evidence upon oath, and any person giving false evidence may be indicted for perjury, provided that such evidence is given "wilfully and corruptly" (§ 26).

Award.

After taking such evidence as they deem necessary, the referees make their award, which must be in writing, signed by them, and produced within twenty-eight days after appointment, though this period may be prolonged. If they do not agree, or if the specified period expires and their award is not ready, their authority is transferred to the arbitrator or umpire, who is clothed with the same power of taking evidence. His award, or that of the referees, must specify "as far as reasonably may be"—(1.) The improvements, acts, or things for which compensation is awarded (§ 32); (2.) The time at which each such improvement, act, or thing, was executed, committed or permitted (*ib.*); (3.) The time at which each improvement, for which compensation is given, becomes, for the purposes of the award, exhausted (§ 31); (4.) The sum laid out by the tenant on each improvement (§ 32); (5.) If the landlord, at the time of the consent given to a first-class improvement, was not an absolute owner, the extent to which such improvement adds to the letting value of the holding (*ib.*); (6.) The sum awarded in respect of each improvement, act, or thing (*ib.*); (7.) A day, not sooner than one month after delivery of the award, for the payment of the money awarded for compensation, the costs of reference, or otherwise (§ 34). The costs of the reference include the remuneration of the referee or referees, and of the umpire, "including other proper expenses" (§ 33); and the referees or umpire may order those costs to be paid by either party, according to their opinion of the "reasonableness or unreasonableness of the claim;" or they may decide that the costs may be paid in unequal proportions; or may leave each party to bear his own costs.

Facts to be set out in.

How to be disputed.

Being furnished with the particulars of the award, either landlord or tenant may dispute it by appealing under certain conditions to the Judge of the County Court. Neither party can appeal unless the sum claimed for compensation exceeds 50*l.* Nor can the award be disputed except upon one of the grounds following (§ 36):—1. That the award is invalid (§ 36, subsect. 1); 2. That compensation has been awarded for improvements, acts, or things, breaches of covenants or agreements, or for committing or permitting waste, in respect of which the party

claiming was not entitled to compensation (§ 36, sub-sect. 2); 3. That the compensation has not been awarded for improvements, acts, or things, breaches of covenants or agreements, or for committing or permitting waste, in respect of which the party claiming was entitled to compensation (§ 36, sub-sect. 3). The County Court Judge will then dispose of the case, or may at his discretion remit it to be heard in whole or in part by the referee, or referees, or umpire, with such directions as he may think fit. The Judge's decision is final upon the facts; but if a question of law arises, he is bound, at the request of either party, to state a special case for decision by the High Court of Justice. The money awarded as compensation, whether to landlord or tenant, must be paid within fourteen days.

Jurisdiction of County Courts.

Appellate Court.

*Charge of Tenant's Compensation.*—Upon payment of a tenant's claim, a landlord may not desire to sink the whole of this money in the land, for the benefit of his heir or of the person entitled in remainder. In such cases the County Court at its discretion may, on application by him, create a "charge on the holding," in respect of the compensation so paid. The effect of the charge is to provide for the repayment to the landlord, his executors, administrators, and assignees, of the sum advanced by him as compensation (§ 42, sub-sect. 3). In other words, this sum, representing an addition to the value of the soil, does not become absorbed in the realty, for the sole benefit of the heir-at-law, but forms part of the personal estate, and is therefore available in favour of younger children. It is left to the discretion of the Court to order repayment of the whole or any part of the money, "with such interest, and by such instalments, and with such directions for giving effect to the charge as the Court thinks fit" (§ 42, sub-sect. 1). And the Act contains restrictions, the effect of which is to protect the interest of persons entitled in remainder where the landlord creating the charge is only a limited owner.

Creation of charge on estate.

*Notice to Quit.*—One of the most important provisions in the Act is that which extends the period of notice to quit in the case of agricultural tenancies from year to year which are affected by the Act (sections 51 & 58). As the law stood before February 14th, 1876, supposing a tenant from year to year entered on his holding at Michaelmas, 1875, and the landlord within a few months found him to be an undesirable tenant, his tenancy could be determined by notice given at Lady Day and ending at the Michaelmas following. A half-year's notice expiring with a year of tenancy was necessary, but the Act has extended this period by six months, and requires a year's notice expiring with a year of tenancy. The result is, in certain contingencies, to give a tenant what may be practically equal to two years' pos-

Notice to quit.

Customary time of, extended by Act.

session; for if the tenancy begins to run from Michaelmas, 1876, notice cannot be given under the Act until Michaelmas, 1877, expiring at Michaelmas, 1878.

In 1874, before Lord Beaconsfield became Prime Minister, he said that, in his opinion, much that was thought unsatisfactory in the existing tenure of land would disappear if a tenant-farmer could be sure of a two years' notice to surrender his holding. The suggestion was thrown out as an alternative to a plan of compensation for unexhausted improvements; and there is therefore no inconsistency in the shorter term of notice fixed by the Bill, supplementing, as it does, provisions allowing such compensation. Of course landlords and tenants are free to regulate as they please the length of this notice, like every other part of the contract of tenancy. Unless, however, the landlord and tenant mutually agree in writing to exclude the whole Act, or this particular provision, every yearly tenancy beginning after February 14th, 1876, is affected by it. It also applies to all yearly tenancies existing at that date, unless within two months afterwards one of the parties to the contract of tenancy notified to the contrary.

To yearly tenancies.

Landlord may resume possession of part of holding for certain purposes.

*Resumption for Improvements.*—In the case of holdings let upon yearly tenancies, landlords are empowered by the Act to serve a tenant with notice to quit part only of the holding. This was a power not before possessed by the landlord, but he can only exercise it for certain objects recognised as being of general importance and utility, that is to say:—1. Erecting farm-labourers' cottages or other houses, with or without gardens. 2. Providing gardens for existing farm-labourers' cottages, or other houses. 3. Allotment to labourers of land for gardens or other purposes. 4. Planting trees. 5. Opening or working any coal, ironstone, limestone, or other mineral; or a stone quarry, clay, sand, or gravel-pit; or constructing any works or buildings to be used in connection therewith. 6. Obtaining brick-earth, gravel, or sand. 7. Making a watercourse or reservoir. 8. Making any road, tramroad, siding, canal, or basin, or any wharf, pier, or other work connected therewith. The Act secures to the tenant adequate compensation for being thus deprived of part of his holding.

Fixtures.

*Fixtures.*—We have traced in part the growth of a more liberal system in English agriculture, mitigating the effect of the old rule—*Quicquid plantatur solo, solo cedit*. A statute passed in 1851 required the landlord's written consent to give the tenant a qualified property in farm buildings erected by him. This consent is still necessary to create a valid claim to compensation under the Agricultural Holdings Act. So, also, the tenant, before erecting any steam-engine, must still give the landlord

Farm buildings.

Steam-engines.

written notice of his intention. If the landlord assents, or is even silent, the tenant may go on, and his rights under the Agricultural Holdings Act will then arise in respect of the steam-engine. If, however, the landlord, on receiving notice of the intention to erect a steam-engine, objects, in writing, to such erection, the tenant will proceed at his own risk; the new Act will no longer protect him; and his rights, whatever they may be, will depend upon custom or otherwise (§ 53, concluding sub-sect.). Engines and machinery, unlike buildings, are not named among any one of the three classes of improvements, but are more properly treated as fixtures; and the distinction in the Act between the two kinds of interests created by the tenant, and here recognised by the Legislature, is that the specified improvements in classes one, two, and three, are treated as inseparably annexed to the soil, as in fact they are—buildings, to a modified extent, excepted—and as therefore properly the subjects of compensation by the owner of the soil; while fixtures are removable, and need not necessarily therefore be the subjects of compensation. The old maxim of law, however, still applies to improvements as well as fixtures. Being annexed to the land, both become the property of the landlord upon payment of their fair value. The tenant cannot pull down the buildings erected at his cost, and cart off the materials; he cannot say of the fixtures, “I will not sell—I have a use for them elsewhere.” The landlord may take them at his option.

Machinery.

Landlord's option of purchase.

The effect of the Act of 1851 was to give the tenant certain rights of property in engines or machinery erected at his cost, with the previous consent of the landlord. The Agricultural Holdings Act dispenses with the necessity of procuring the landlord's previous consent for affixing to the holding this class of fixtures, steam-engines excepted. In the absence, be it always understood, of express agreement, or of written exclusion of the Act from the contract of tenancy, an agricultural tenant, whose holding exceeds two acres, may now affix to his holding “any engine, machinery, or other fixture, for which he is not under this Act or otherwise entitled to compensation.” These fixtures may be put up not only without the assent, but contrary to the express wishes of the landlord; and, if they have not been so put up pursuant to some obligation, or instead of some fixture belonging to the landlord, they will become the property of the tenant, and be removable by him, upon the following conditions (§ 53):—

Landlord's consent to erection of, unnecessary, excepting steam-engines.

1. Before removing any fixtures, the tenant must pay all rent owing by him, and perform all other obligations to the landlord in respect of the holding. The landlord, in fact, has a lien upon the fixtures for the amount of rent or compensation.

Conditions of removal by tenant.

2. In removing any fixture, no "avoidable damage" must be done to any building, or other part of the holding.

3. Immediately after removing any fixture, the tenant must make good all damage occasioned by such removal.

4. The tenant cannot remove any fixture unless he gives the landlord one month's previous notice, in writing, of the intended removal.

5. At any time within the month of notice, the landlord (as under the Act of 1851) has an option of purchasing any fixture comprised in the notice of removal. He may thus select which he thinks worth purchase, and leave the tenant to remove the rest. This option must be signified to the tenant, in writing, before the end of the month; and the fixture selected by the landlord becomes his property, and must be left by the tenant, who will be paid for it according to its fair value to an incoming tenant. If the parties differ, the value is to be settled by reference, but without power of appeal; the decision of the referee, or referees, and umpire, will be final.

Results of Act.

This is the Statute which the English Legislature have passed, recognising the just confidence reposed in most English landlords by their tenantry, but recognising, too, in the words of the Prime Minister, that "laws should be founded, not on honour, but on justice."

Such a statute, embodying a principle previously unknown in English legislation, could hardly be expected to be at once and completely incorporated into contracts of agricultural tenancy. Hitherto, therefore, experience shows that both landlords and tenants have been timid in adopting the provisions of the Act. With a view to ascertain what had really been its beneficial results, circulars were sent, towards the end of the year 1876, on the part of the Farmers' Club, to the leading farmers and land agents, as well as to the various Chambers of Agriculture, throughout the country, and 258 answers were received. The results of these answers are summed up in an able paper\* by the Secretary of the Club, Mr. Druce, as follows:—

Firstly, as a general rule, the Act is excluded by landlords in respect of tenancies from year to year, or at will, which were current when it came into operation.† Secondly, it is also to a large extent excluded in respect of tenancies which began since

\* 'Journal of the Farmers' Club,' February, 1877, p. 13.

† To this general rule, however, important exceptions are noted in the Appendix. For example, Earl Brownlow, the Earl of Lonsdale, and Lord Tredegar are among the landlords who at once boldly adopted the Act. On the other hand, instances might be given in which, as upon Sir Edward Kerrison's estate, the tenants, having the choice given to them, preferred on the whole to remain under existing agreements.



the Act came into operation. Thirdly, the provisions of the Act relating to payment of compensation for unexhausted improvements, especially those of the second and third classes, have been adopted by special agreement, and in many cases the time fixed by the Act for notice to quit has been likewise adopted in new agreements, and has thus been extended from six to twelve months. Fourthly, the Act, and the debates upon it in the Houses of Parliament and elsewhere, have caused greater attention to be paid by landlords to the compensation of tenants for unexhausted improvements, and have resulted in more liberal leases and agreements than were formerly granted.

It may be fairly assumed, on the whole, that, permissive as this and all other legislation on this subject is and should be, the Act will work, directly and indirectly, unmixed good to landlords not less than to tenants. Hitherto many landlords have been deterred from adopting the Act, from no unwillingness to secure equivalent advantages to their tenants, but from apprehensions of disputes and of litigation under the compensation clauses. As the provisions of the Act come to be better understood, the examples of those landlords who have incorporated the Act into their agreements will be gradually followed.

Meanwhile the benefits indirectly resulting to agriculture from the Act are already considerable, and must every year increase. In the first place, the effect of this statute is to multiply written agreements relating to the letting of land, if, indeed, it does not make such agreements universal. The want of a strict definition of engagements between landlord and farmer in this country has often been pointed out, and it will be a considerable gain to English agriculture if this frequent cause of difficulty and dispute can be removed. Then, in many districts in England, the prevailing agricultural customs have become inapplicable, and yet have the force of law unless they are expressly excluded by the agreement or are inconsistent with its terms.\* In the Agricultural Holdings Act a sound rule has now been laid down upon broad lines; and this rule, permanently embodied in a legislative enactment, is sure in time to be generally followed as the basis of agreement wherever it is applicable.† Again, limited owners up to this time could hardly be expected to give their tenants a certain guarantee of compensation for outlay; but the powers they now possess under the statute to charge their estates with the amount of compensation removes one great hindrance to agricultural improvement. Lastly, there is an evident desire on the part of landlords to recognise the

Indirect  
benefits to  
English  
agriculture.

\* Speech of Viscount Portman, House of Lords, May 13, 1875.

† Speech of Lord Henniker, House of Lords, March 12, 1875.

spirit of the Act; and the example already set in granting more liberal covenants, especially those relating to compensation and a longer term of notice, will, there is good ground for believing, spread every year. The Agricultural Holdings Act, therefore, may reasonably be regarded as being, directly and indirectly, a considerable boon to tenant farmers in England, and the Legislature has certainly not passed it in vain.

III.  
TAXATION  
AS AFFECTING  
THE AGRICULTURAL INTEREST.

BY  
CAPTAIN CRAIGIE,  
SECRETARY OF THE LOCAL TAXATION COMMITTEE OF THE CENTRAL CHAMBER  
OF AGRICULTURE.

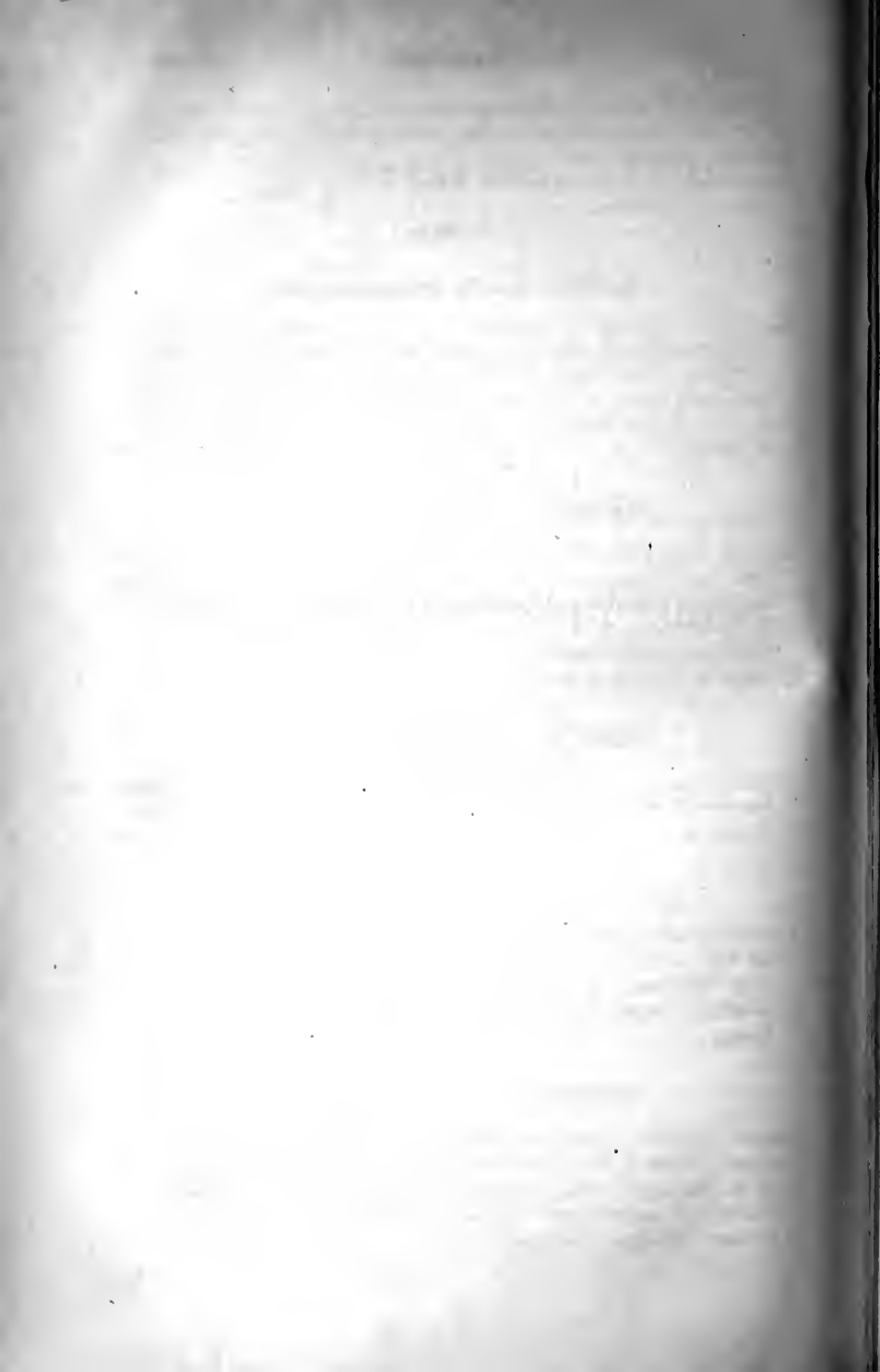

## CONTENTS.

CHAPTER I.—*The Agricultural Interest.*

Elements composing the Agricultural Interest—Number of Agriculturists with independent Incomes—Dependent Members of the Agricultural Classes—Property of the Agricultural Classes—Landowners' Capital and Income—Tenant's Capital and Income—Earnings of the Labourer—Ratio of Persons and Capital engaged in Agriculture to the Wealth and Inhabitants of the Kingdom .. .. . Pages 123–127

CHAPTER II.—*Distribution of Taxation.*

Amount of Taxation—Analysis of Taxation—Distribution of Taxation—Light and voluntary character of Working-class Taxation—Recent Fiscal changes—Taxation of the Agricultural Classes—The Agricultural Labourers' Taxes—Taxation of the Upper and Middle Classes of Agriculturists—Malt Tax—Agricultural Share of Taxes on Expenditure—Agricultural Share of Taxes on Property or Income .. .. . Pages 128–137

CHAPTER III.—*Imperial Direct Taxes.*

Probate, Legacy, and Succession Duties—Stamps—Land Tax—Income Tax—Pressure of Income Tax on Land Rental—Assessment of the Tenant's Income Tax .. .. . Pages 138–143

CHAPTER IV.—*Local Direct Taxes.*

Local Rates—Share of the Rates levied on Land—The Poor Rate—Its Origin—Its Fluctuations—Its Purposes—Agricultural Share of the Poor Rate—Local Distribution of the Poor Rate—Highway Rates—County Rates—Sanitary Rates—Education Rates—Variations in the Systems of Local Rating .. .. . Pages 143–151

CHAPTER V.—*Pressure of Taxation.*

Relative Pressure of Local and Imperial Taxes on Agricultural Incomes—Varied Origins of the Incomes here contrasted with those of Agriculturists to be taken into account—Peculiarities of Rate-incidence—Relative total Taxation of separate sorts of Incomes—The Landlord's Taxation—The Farmer's Taxation—Conclusion .. .. . Pages 151–158

COMMISSIONERS

REPORT OF THE COMMISSIONERS

of the State of New York, in relation to the  
Education of the People, and the  
Improvement of the State, for the  
Year 1852.

CHAPTER I.—OF THE STATE OF EDUCATION

IN THE STATE OF NEW YORK, FOR THE  
YEAR 1852. The Commission-  
ers have the honor to acknowledge  
the assistance of the several  
Departments of the State, and  
of the several Boards of Education,  
in the preparation of this Report.

CHAPTER II.—OF THE STATE OF EDUCATION

IN THE STATE OF NEW YORK, FOR THE  
YEAR 1852. The Commission-  
ers have the honor to acknowledge  
the assistance of the several  
Departments of the State, and  
of the several Boards of Education,  
in the preparation of this Report.

CHAPTER III.—OF THE STATE OF EDUCATION

IN THE STATE OF NEW YORK, FOR THE  
YEAR 1852. The Commission-  
ers have the honor to acknowledge  
the assistance of the several  
Departments of the State, and  
of the several Boards of Education,  
in the preparation of this Report.

CHAPTER IV.—OF THE STATE OF EDUCATION

IN THE STATE OF NEW YORK, FOR THE  
YEAR 1852. The Commission-  
ers have the honor to acknowledge  
the assistance of the several  
Departments of the State, and  
of the several Boards of Education,  
in the preparation of this Report.



# TAXATION

AS AFFECTING

## THE AGRICULTURAL INTEREST.

---

### CHAPTER I.

#### THE AGRICULTURAL INTEREST.

IN any attempt to trace the bearing of the general fiscal system of the United Kingdom on what is distinctively termed the agricultural interest, it is needful to define with some precision who are the persons and what is the taxable property which that interest may be held to embrace.

For the purposes of such an inquiry as this, that section of the British people may fairly be reckoned agricultural who either own or farm the soil, or furnish the labour indispensable to its cultivation, together with such members of their families as may be considered wholly dependent on the profits of ownership, occupation, or tillage for their livelihood. A concern in all that affects agricultural prosperity extends, no doubt, also to a fringe of auxiliary callings like those of the land agent, the seedsman, and the maker or purveyor of agricultural requisites. Still, it would be hardly accurate or convenient to include these possessors of more remote and secondary interests in the roll of agriculturists, whose taxation it is sought to determine.

It is not, however, so simple as it seems to reckon up the members of the agricultural community. The attempt to draw a sharp and rigid line of demarcation between classes, professions, and incomes is always liable to be deemed arbitrary, and is peculiarly difficult in a country such as this, with an increasingly dense population and a growing inter-dependence in its social relations. Plurality of calling is no infrequent occurrence. The joint household purse of many a family is fed by revenues drawn from the most diverse sources. Even within the agricultural community itself, two or more of the usually separate

Elements composing the agricultural interest.

functions of ownership, occupation, and personal labour, characteristic of our system, may to a greater or less extent be merged in one and the same individual. But even beyond an element of the calculation so disturbing as the blending of classes, the available statistical information we possess is far from complete. The Census Commissioners themselves express some doubt as to the correctness of their enumeration of farm-labourers; the yearly Agricultural Returns give the total only of separate holdings, not of separate farmers; while the voluminous rolls of the new 'Doomsday Book' make but little claim to precision, and notably require considerable discount for repeated or duplicate entries of nominal landowners.

Nevertheless, after guarding against such possible sources of error, after passing over altogether as not distinctively agricultural the holders of less than one acre of land, and after duly allowing for double tenancies, a rough general survey of the numerical strength of the agricultural classes throughout the whole United Kingdom will reveal a total of 300,000 landowners, 1,000,000 occupiers of farms, big and little,\* and upwards of 1,500,000 farm-labourers. Thus somewhat over 2,800,000 individuals appear to be engaged in the ownership, cultivation, and tillage of land.

Lest these figures should convey a wrong notion of the numbers of the typical class to which the term of landlord is popularly applied, it should be noted that not two-thirds of those here enumerated possess so much as ten acres of land apiece; and only one-fifth of the whole, or some 60,000 individuals, own an estate of over 100 acres of British soil. A more correct appreciation of the standing of many of these occupiers is also got, if it be borne in mind that the farms of at least 300,000 are less than ten-acre plots; that the Census Commissioners will not allow even the name of farmer to more than 250,000 persons in England and Wales; while little more than 90,000 occupiers in Great Britain, and 30,000 in Ireland, cultivate farms exceeding 100 acres in extent. These facts, and the consequent approximation in point of *status* between individual members of the upper and lower agricultural classes, must be remembered when their general taxation is being computed.

To the numbers thus arrived at, how many persons should be added as being properly dependent members of the several agricultural sections? Bearing in mind the necessity of allowing for families where income of a non-agricultural character supplements the receipts from land-rental or farm-earnings,

---

\* Of this million of occupiers, 530,000, or more than half, are to be found in Ireland alone.

Number of agriculturists with independent incomes.

Dependent members of the agricultural classes.

admitting that the workers here included are not all heads of families, and recalling other qualifying considerations which suggest themselves, there would appear to be good ground for reckoning on an average of two dependent individuals for every one more or less directly engaged in agriculture. This would raise the numbers directly interested in all that concerns the land and its cultivation to between eight and nine million persons of all ages, a total that represents more than a fourth of the inhabitants of the United Kingdom.

The next point to be determined is the capital possessed by the agricultural classes, and the income derived by them from its profitable use. In the widest sense of the term this capital will include not only the value of the soil itself, the outlay in landlord's improvements, and the tenant-farmer's investment for the purpose of his business, but it will cover also the less palpable but not less needful factors of the brain-power devoted to the task of cultivation, and the energy of muscle and sinew provided for the manual labour of the farm. To the three former elements alone a direct money-value may be given. From the combined employment of all five constituents income is returned and distributed to the several classes concerned, in the form of rent, interest, profits, or wages.

Property of the agricultural classes.

The landlords' share of this income, as measured by the gross rental yearly assessed for income-tax in the United Kingdom, is 67,000,000*l.* Of this sum it is to be noted that about 5,000,000*l.* represents the fixed and separate, but equally landed, revenues of the lay and clerical titheowners. Some three-fourths of the rest, or 46,000,000*l.*, may be most properly regarded as landlords' rent in its more primary sense, and 16,000,000*l.* as the interest of sums laid out in fitting the soil for profitable cultivation, by means of enclosure, buildings, drainage, and so forth. The extent of these investments goes some way to account for the recent rise in the nominal rental of land, and it is too often overlooked when proposals are made to subject land, as a source of wholly unearned revenue, to exceptionally heavy taxes. Taking the natural rent at 30 years' purchase, and the landlords' investments and titheowners' property at 25, these figures would appear to indicate the existence of a titheowners' capital of 125,000,000*l.*, an ordinary landlords' capital of 1,380,000,000*l.* in the soil itself, and of 400,000,000*l.* in its improvements, or, in the aggregate, 1,905,000,000*l.* Throughout this Paper the tithe-rent charge is included in the term "land," and fully shares its taxation. The payment of tithes by the occupier is not properly a tax, but a simple rendering of rent to the titheowner, who, since the days of King Ethelwolph, the first hereditary monarch of the English Saxons, has, in one form or

Landowners' capital and income.

another, owned a co-existing share of the produce of the soil with the landlord proper. In England, it may be remarked, one-fifth of these tithes are now vested not in ecclesiastical but in lay proprietorship.

Tenant's capital and income.

The capital provided by the tenant for the ordinary work of the farm bears also some variety of character. Differing greatly in different districts, on different soils, and sorts of farms, there does not appear to be much general agreement as to the average value of the farmer's plant in the stock, implements, and material accessories of his business. Where a mean has to be struck between the high-farming which finds, at the least, profitable employment for 15*l.* an acre, and the low level of the scale, which a West of Ireland tenant would think ample, it is easy widely to err; but there is some ground to believe that an average of (say) 8*l.* per acre over the cultivated area of 47,000,000 acres throughout the United Kingdom may fairly enough represent the working capital of the British tenantry. This gives a sum of 376,000,000*l.*

For purposes of taxation the income-tax Acts assume the tenant's earnings to be measured by one-half his rent in England, and one-third in Scotland and Ireland—assumptions to which practical effect is given in the reduced poundage-rate imposed. It has been argued, on the one hand, that this is too favourable to the farmer, and charges his profits too lightly; while, on the other, authority is not wanting for the very opposite contention. Since, however, this estimate is in point of fact that acted on in the adjustment of taxation, and since it coincides very closely with an average return of 9 per cent. on the farming capital employed, I am disposed to believe that it is not, on the average, at all too low an estimate, and that no great error can result from its adoption. Omitting for convenience the deferential favour shown to other than English tenants, I therefore take the aggregate taxable income of all the occupiers of the United Kingdom at one-half the gross value of the land-rental—which, it will be remembered, includes the tithes—or a total sum of 33,000,000*l.* a year.

Earnings of the labourer.

So far as the labouring section of the agricultural community is concerned, no money capital has to be assumed, nor does any direct tax, with its tell-tale assessment, reveal in official figures the earnings which they enjoy in return for the labour they expend in the common business. As in all agricultural questions, the wideness of the field impedes an easy computation of what sort of revenue these earnings represent. Ten years ago, a late eminent statistician, Mr. Dudley Baxter, in his elaborate work on national income, calculated their receipts as reaching 52,200,000*l.* A notable rise in wages, to which the larger labour

bills of farmers testify, makes it seem no exaggeration to assume that 58,000,000*l.* of income, or something like an average of 24*s.* per cultivated acre, or 14*s.* a week for each worker, is now annually received in the shape of wages or their direct equivalent by the farm-labourers of the three kingdoms.

It may thus be assumed that the agricultural interest embraces not less than eight and a-half million persons \* possessing 2,300,000,000*l.* of aggregate capital, and enjoying among them a yearly revenue of 158,000,000*l.* What ratio do these figures bear to the population, wealth and income on which the whole taxation of the United Kingdom is imposed? To the first point an answer has already been given. The agriculturists and their immediate dependants are one-fourth of the people. Less easy of statistical demonstration is the proportion borne by their capital to the general wealth of the nation. Whether the calculation be made by the methods employed in 1845 by Mr. Porter, in 1860 by an able writer in the 'Edinburgh Review,' or in 1867 by Mr. Dudley Baxter, it would now be difficult to reduce the estimate of British realised wealth much below 8,600,000,000*l.*, a figure which, I believe, it very probably exceeds.† Of this amount the agricultural classes may claim to own rather more than one-fourth.

Ten years ago, Mr. Baxter's widely accepted estimate of national income placed the gross revenue of all classes of the people at 814,000,000*l.* It seems impossible at the present moment to reckon the aggregate gross income of all classes of the population at a less figure than between 1,000,000,000*l.* and 1,100,000,000*l.* Ten years ago 280,000,000*l.* of the whole income of the country was held to arise from capital, and the rest from earnings. Now there is some ground to believe that 370,000,000*l.* springs from the former and the balance from the latter source. The total income of the agricultural classes (158,000,000*l.*) thus represents about one-seventh of that received by the nation as a whole, while probably one-half of this agricultural income springs from the invested property of owners or occupiers, and half from the earnings of the tenant and the labourer. If, therefore, the approximate accuracy of these estimates be admitted, it would appear that the income returned by the combined capitals of the landowner and the farmer (80,000,000*l.*) is no more than  $3\frac{1}{2}$  per cent., in contrast with the average of  $4\frac{1}{2}$  per cent. yielded by all descriptions of British capital.

\* Namely, 2,800,000 persons engaged in agriculture, and two dependent individuals upon each, see *ante*, "Number of agriculturists with independent incomes."

† Mr. Giffen, Principal of the Statistical Department of the Board of Trade, has, since this estimate was framed, submitted another to the Statistical Society of London, which offers, as the most moderate computation of British capital, a sum of 8,548,000,000*l.*

Ratio of persons and capital engaged in agriculture to the wealth and inhabitants of the kingdom.

## CHAPTER II.

## DISTRIBUTION OF TAXATION.

HAVING thus obtained some notion of the numerical strength and financial resources of the agricultural classes, it is, in the next place, necessary to inquire what is the entire amount and distribution of British taxation.

The public revenue accounted for by the Chancellor of the Exchequer in 1877 was 78,600,000*l.*; that received at the most recent dates by local authorities throughout England, Scotland, and Ireland (deducting of course all subventions from one source of revenue to another) was 49,000,000*l.*

This sum of 127,600,000 is nevertheless not all raised by taxes. From the imperial side of the account must be deducted 10,000,000*l.* for rents of crown lands, miscellaneous receipts, and the actual costs of postal or telegraphic business. From the local revenue in like manner must be eliminated 16,600,000*l.*, two-thirds of this being sums borrowed within the year and not forming part of the annual levy, and the rest made up of income from corporate property or miscellaneous sources.

This reduces the general taxation, properly so called, to 101,000,000*l.*, whereof two-thirds is raised by imperial and one-third by local imposts.

The widest and most elementary division of the whole fabric of imperial and local taxes is the rough-and-ready classification adopted by Lord Halifax (then Sir C. Wood) in his Budget Speech of 1851, and recognised as legitimate by so good an authority as the present Chancellor of the Exchequer (Sir Stafford Northcote). It was a division into "taxes on property" and "taxes not on property." Adhering to the method thus employed, with only a slight correction for some local items, the following Table will not only give the ratio now existing, but will at the same time show the tendency of recent financial changes.

Date.	Taxes * on Property.	Taxes * not on Property.	Total Taxation.	Percentage of Taxes on Property to Total Taxes.
	£	£	£	
1840	19,000,000	45,000,000	64,000,000	30
1850	25,000,000	45,000,000	70,000,000	36
1860	30,000,000	53,000,000	83,000,000	36
1877	42,000,000	59,000,000	101,000,000	42

To determine how this taxation in detail specially affects the agricultural classes a closer investigation, and a somewhat varied

\* See note on facing page.

Amount of  
taxation.

Analysis of  
taxation.



apportionment of taxes is required. Following in some respects the method of classification resorted to in 1867 by Mr. Dudley Baxter, as giving a clear outline of national finance, I would submit, as fairly representing the figures of the present day, the subjoined

ANALYSIS OF TAXATION.

	Amount of each Tax.	Amount of each Group.	
<b>I. TAXES ON PROPERTY AND INCOME.</b>			
(a) Taxes on capital or on income from capital:—			
(1) <i>Imperial</i> , viz.:—			
Probate, legacy, and succession duties .. .. .	£ 6,000,000		
Stamps on deeds .. .. .	2,100,000		
Land tax .. .. .	1,100,000		
Railway duty .. .. .	700,000		
Income tax (Schedules A and C, and parts of B and D) .. .	3,600,000	£	
(2) <i>Local</i> , viz.:—		13,500,000	
Owners' share of rates .. ..	..	16,950,000	
(b) Taxes charged on income not arising from capital:—			
Income tax (Schedule E, and parts of B and D) .. .. .	1,700,000	1,700,000	£
			32,150,000
<b>II. TAXES ON EXPENDITURE.</b>			
(a) On articles of consumption, viz.:—			
On Spirits, including licences .. ..	21,500,000		
" Wine .. .. .	1,900,000		
" Beer .. .. .	9,300,000		
" Tobacco .. .. .	7,900,000		
" Tea .. .. .	3,700,000		
" Coffee, fruits, &c. .. .. .	900,000	45,200,000	
(b) On business, traffic, or establishments:—			
(1) <i>Imperial</i> , viz.:—			
Post office and telegraph net revenues .. .. .	2,200,000		
Stamps on bills and business transactions, law fees, and sundries .. .. .	3,000,000		
Inhabited house duty .. .. .	1,400,000		
Licences for carriages, dogs, servants, game, plate, and so forth .. .. .	1,600,000	8,200,000	
(2) <i>Local</i> , viz.:—			
Occupiers' share of rates ..	10,350,000		
Tolls, dues, fees, and duties ..	5,100,000	15,450,000	
			68,850,000
			£101,000,000
	Total .. ..		

NOTE.—The general classification attempted in the Table on the preceding page recognises only the primary form of each tax. It is needful for my present

Viewing the whole taxes of the country as thus grouped, the first division will be found composed of a series of imposts, each of special or particular incidence, and charged directly on certain forms of capital or income, while the second and larger division will embrace all less direct taxes, which usually take the form of fiscal additions to the outlay of the people at large. So marked, however, is the distinction between the way in which these two branches of taxation affect the upper and middle classes of the country on the one hand, and the lower classes on the other, that no intelligent appreciation of the quotas borne by the agricultural, or any other section of the community, is possible without a still further attempt to discriminate between the incidence of taxation on one or the other of these great social grades. There is not a little difficulty in fixing the proper line between these classes. I have not, however, attempted to depart from the system usually adopted, whereby the earnings of manual labour are left in the lower, and all other incomes relegated to the higher class. No doubt a closer analysis, distinguishing, if it were possible, the lower middle class—in which direct taxes are added to a relatively heavy share of those on consumption—would reveal a great divergence from an average rate of burden distributed over the wide area of each class, as above defined. For the finer calculations of financiers, it is also true, note has to be taken not only of the nominal amount of each tax imposed by the Legislature but also of the extra cost to the payer of the impost, frequently inseparable from the otherwise convenient form of its levy; but this is too minute and delicate a matter to be set forth in the broad lines of the present inquiry.

Distribution of  
taxation.

In framing the following Table (p. 131) I have combined the estimates of financial authorities—such as Leone Levi and Dudley Baxter—varying these only so far as good reason appears for so doing in recent fiscal changes, or in the known consumption of taxable commodities in later years.

Light and vol-  
untary cha-  
racter of work-  
ing class  
taxation.

The percentage of taxation borne by the upper and middle, or propertied classes, thus appears to be half as great again as that on the working classes. Bearing in mind the greater real pressure of the same percentages on the lower range of incomes,

---

purpose to go a little farther than this. In the case of the Inhabited House Duty, for instance, I believe it advisable to follow the usual opinion of economists that this charge falls practically not upon the income of the house-owner but on the expenditure of the house-occupier. So too with local rates. These, though paid by the occupier, are assumed above to fall upon the property taxed; while here again there are strong economic reasons for similarly allotting a share to the outlay of the occupier. This share has been taken to be one-fourth in the case of land and one-half in the case of houses. Only the remainder of the rates on these properties, with the whole of those on minor hereditaments, is hereafter regarded as incident on the owners.

DISTRIBUTION OF TAXATION.

	MIDDLE AND UPPER CLASSES.		LOWER CLASSES.	
	9,000,000		24,000,000	
	£580,000,000		£480,000,000	
	Share of Tax.	Amount of Tax.	Share of Tax.	Amount of Tax.
<b>I. TAXES ON PROPERTY AND INCOME.</b>				
(a) On property or income from property.		£		£
(1) Imperial * .. .. .	All	13,500,000	..	..
(2) Local .. .. .	All	16,950,000	..	..
(b) On Income not from Capital				
(1) Imperial * .. .. .	All	1,700,000	..	..
	..	32,150,000	..	..
<b>II. TAXES ON EXPENDITURE.</b>				
(a) On the Consumption, viz:—				
Of Spirits .. .. .	$\frac{2}{7}$	6,100,000	$\frac{5}{7}$	15,400,000
„ Wine .. .. .	All	1,900,000	..	..
„ Beer .. .. .	$\frac{1}{3}$	3,100,000	$\frac{2}{3}$	6,200,000
„ Tobacco .. .. .	$\frac{1}{3}$	3,200,000	$\frac{2}{3}$	4,700,000
„ Tea .. .. .	$\frac{1}{3}$	1,200,000	$\frac{2}{3}$	2,500,000
„ Coffee, &c. .. .. .	$\frac{1}{3}$	600,000	$\frac{2}{3}$	300,000
(b) For Post-office net revenue ..	$\frac{9}{10}$	2,000,000	$\frac{1}{10}$	200,000
„ Sundry Stamps and Fees ..	$\frac{9}{10}$	2,000,000	$\frac{1}{10}$	1,000,000
„ Inhabited House duty ..	..	1,400,000	..	..
„ Establishment and other Licences .. .. .	All	1,600,000	..	..
(c) „ Local Rates (Occupiers' share) .. .. .	$\frac{3}{4}$	8,350,000	$\frac{1}{4}$	2,000,000
„ Local Tolls, Dues, &c. ..	$\frac{3}{4}$	3,800,000	$\frac{1}{4}$	1,300,000
Total .. .. .	..	67,400,000	..	33,600,000
Percentage of Taxation upon Gross Income .. .. .	..	11½	..	7
Average Taxes per head .. ..	..	£7 10s.	..	£1 8s.

\* See previous Table (ANALYSIS OF TAXATION) for details.

this difference may appear not unreasonable. There is, however, a further marked peculiarity in the form of their taxation,

which very greatly reduces, at all events, the inevitable share of the taxes of the lower class.

This variety in the form of burden appears from the following summary :—

	Upper Class.	Lower Class.
Taxes on income and property	5½ per cent.	Nil.
Taxes on consumption . .	2¾ per cent.	6 per cent.
Taxes on other outgoings . .	3¼ per cent.	1 per cent.
	<hr/>	<hr/>
Total . .	11½ per cent.	7 per cent.

These figures show that only indirect taxes practically reach the manual labour classes ; while these taxes are, moreover, all on accessories, not necessities of life, nearly four-fifths of the whole taking the form of imposts on spirits, beer, or tobacco. This feature causes, of course, very great irregularity in the amount paid by different individuals. Large sums of extra taxation, poured freely into the coffers of the State by a minority of intemperate individuals, greatly swell the apparent normal taxes of the class. Could these be abstracted from the total average contribution, as some writers on taxation have tried to do, a working-man need not be a total abstainer to obtain for himself a taxation far lighter than that here shown. He may, by simply eschewing spirits and tobacco, enjoy a fair modicum of other taxable luxuries without being called on from one year's end to another to pay for all the benefits and protection of civilised Government much more than a single sum of sixpence out of every pound of his wages.

A great fiscal change has of late years been effected in British finance. Less than half a century ago we had tariffs wholly or nearly prohibitory on articles even of the first necessity. Customs duties, now all but restricted to certain stimulants and luxuries, then ranged over some 500 different commodities. Taxes on corn, taxes on sugar, taxes on windows, on bricks and on glass, taxes on bacon and on butter, on cheese and on soap, on candles and on paper, are all things of the past. Tea pays but one-fourth of the duty it bore five-and-twenty years ago. It may, indeed, be safely affirmed that, so far as the consumer is concerned, the average burden of taxation can occasion but little inconvenience. Large as its aggregate may be, it is supported with an ease which to our forefathers was unknown, and to most modern nations is even yet hardly imagined. This change has brought a larger share of taxes on the property of the country, and thrown a gradually increasing degree of relative pressure on a less numerous section of the community—

a course, no doubt, requiring caution in itself. So far, however, as this transfer has already proceeded, we have not yet, perhaps, reached the anticipated, and of course possible, danger of dissociating the responsibility of paying for the maintenance of political institutions from the practical possession of political power.

But it may be questioned whether the same apportionment of taxes to classes as is here shown holds good throughout the specially agricultural as well as the other sections of the community. Since the number of the landowners has been already shown to include 200,000 persons who do not possess 10 acres apiece, since more than half of the English occupiers cultivate less than 20 acres each, and since among the Irish farmers the small cultivator still more largely predominates, it is clear that with agriculturists many more than those in the nominal labouring class will really enjoy no more than working-class incomes. Belonging, therefore, so far as taxes on expenditure are concerned, to the lower order of incomes, such persons will have to bear at the same time a further and exceptional liability in their share of some of the more direct imposts which ordinarily fall on propertied classes of a higher order.

Taxation of the agricultural classes.

If these petty cultivators be excepted from the class, the taxation falling on the grade of agricultural labourers is the very lightest exacted anywhere. The labourer who neither smokes nor chews tobacco, who neither drinks his beer, nor rises to the higher taxed luxury of spirits, is practically an untaxed member of the community. Even where he desires it, the narrower wage of the average farm-workman leaves far less margin for that voluntary taxation by means of the gin-palace, to which, in too many cases, it may be feared, the more highly-paid artisan subjects himself.

The agricultural labourers' taxes.

It is not easy to fix the average payment the labourer will make. The articles on which he pays are few in number and very irregularly consumed in different districts. A not unfair sample of the English farm-labourer's present taxation may, however, be gathered from the following Table, in which a common average is struck of the consumption of taxed commodities by ten labourers' families in Yorkshire, Essex, and Hampshire. The figures are abstracted from Returns given in Mr. Dudley Baxter's book on taxation; and I have selected (as these Returns were furnished ten years ago) only those based on the higher scale of earnings, as tallying more readily with present circumstances. Each household, it should be said, enjoyed 43*l.* 6*s.* 8*d.* of average yearly earnings, and consisted of a mean number of 5 $\frac{2}{3}$  persons.

Taxed Articles Consumed.	Average Consumption per Family per Annum.	Rate of Tax.	Total Taxes.
Tea .. .. .	14 lbs.	s. d. 0 6	£ s. d. 0 7 0
Beer .. .. .	40 galls.	0 2	0 6 8
Tobacco .. .. .	5½ lbs.	3 3	0 17 0
Total family taxation .. ..			1 10 8

Spirits in no case appears as a sufficiently large item in these returns materially to affect the calculation, and coffee has too limited a consumption to be included in it. These figures show an average burden of no more than 3½ per cent. expended by the rural labourer in taxes on consumption, and practically these taxes alone affect him. This payment is only one-half of that attributed to the wage-earning classes generally, and no more than 5s. 5d. per head per annum. It is here worthy of note, that when Mr. Baxter wrote, the average charge upon these families exceeded 2l. each. A reduction of one-fourth of their total taxation has thus apparently been effected in the last ten years by the abolition of duties then existing, especially that on sugar.

It may be interesting to contrast with this estimate one showing the ordinary taxes on consumption paid by urban workmen. Based, like the above statement, on some of the data of Mr. Baxter's returns, the following figures represent an average of the expenditure on taxed commodities by eleven families in Yorkshire, and in the north, south, and east of London, the trades pursued being those of carpenters, shoemakers, ironworkers, &c., the numbers in family about equal to those already given, and the average family income 68l.—

Taxed Articles Consumed.	Average Consumption per Family.	Rate of Tax..	Total Taxes.
Tea .. .. .	19 lbs.	s. d. 0 6	£ s. d. 0 10 6
Coffee .. .. .	7 lbs.	0 2	0 1 2
Tobacco .. .. .	6½ lbs.	3 3	1 1 2
Beer .. .. .	86 galls.	0 2	0 14 4
Spirits .. .. .	1½ gall.	7 9	0 11 8
Total family taxation .. ..			2 18 10



The average of consumption is here, it will be seen, a strictly temperate one, and does not reach anything like the level to which intemperate outlay raises the whole class; nevertheless it illustrates the relative lightness of the agricultural labourers' taxes.

Turning now to agriculturists of a higher grade, it will be asked, How does their taxation compare with that of their fellow-citizens who enjoy parallel incomes? There is, I believe, no good reason as regards taxes on individual outlay to draw any marked distinction between the expenditure on taxed commodities defrayed out of the agricultural, the trading, or the professional incomes of the upper and middle classes. The peer, with a rent-roll of 10,000*l.* a year, and the commercial magnate of equal wealth, may not on the average, in spite of special divergences, contribute on their establishment- and household-outlays very unequally to the Exchequer. The humbler tradesman and the tenant-farmer, just earning 150*l.* a year, will probably find but little diversity in the extent of their yearly use of tea or of coffee, of tobacco, of wine or of spirits. There would thus appear little room to doubt that agricultural incomes share equally with all others of the middle and upper class in the imperial taxes on consumption.

Taxation of the upper and middle classes of agriculturists.

This practical equality has, it is true, been challenged in one particular by an asserted predominance in the agricultural consumption of a beverage which is the subject of special taxation. Before a Select Committee of the House of Lords in 1846, and again in the 'Reasons for a Repeal of the Malt-Tax,' submitted by a deputation from the Central Chamber of Agriculture in 1870, it was urged that the necessities of their business make farmers much larger users of beer than other employers, and therefore special sufferers by a tax which artificially augments the cost of the beer used on the farm to the extent of 6*d.* or 7*d.* per acre. The evidence on this point is, however, hardly conclusive enough to necessitate a definite augmentation of the agricultural share of taxes on consumption in excess of the general ratio above determined.

Although the discussion of fiscal consequences more remote than the special object of each tax lies usually beyond the scope of this Memoir, it is impossible to overlook other controversies—loud enough to have repeatedly secured the ear of Parliament—which have arisen on this question of the malt tax. Although aimed at the consumer of beer, the tax is levied by a duty of 2*s.* 8½*d.* per bushel on the malt on which that beverage is founded. Complaints have thus arisen that one of the chief of English farm crops is taxed in the first stage of its manufacture, that the price of lower-class barleys is artificially depreciated,

that certain courses of cropping are interfered with, and that fiscal restrictions impede the use of a valuable digestive addition to the ordinary food of stock. In reply to such arguments, it has been suggested that barley may possibly owe something of its high value and profitable character to the legislative restraint which deters the brewer from employing ingredients elsewhere successfully resorted to; it is asserted that whatever be the theoretical offence of a tax levied in this way, the producer is not the real sufferer; while to any change of incidence is opposed the difficulty of giving isolated consideration to an impost so intimately related to the whole system of alcoholic taxes. Either a wider acceptance of some of these views, or, still more probably, the high prices lately enjoyed by barley-growers, and the well-founded dread of tampering with one of the few remaining taxes which lay the powerful classes of consumers under equitable tribute to the National Exchequer, have of late years deprived of their former vigour the complaints of agriculturists in this particular.

Agricultural  
share of taxes  
on expenditure.

If, then, it be acknowledged that, as regards articles of ordinary consumption, the agricultural classes are taxed on a scale not greatly varying from that of other persons, much the same answer must be returned as to the average incidence of the other imperial taxes on personal expenditure. The relatively small sum paid on farm-houses as inhabited house duty, not exceeding 19,000*l.*, is probably in part, at least, due to their value so frequently falling below the limit of the tax, and to their being charged as trade premises. Nominally occurring, however, among taxes on outlay, the exceptionally large share of local rates borne by farm occupiers demands attention. Assuming, as has here been done, that one-fourth of the rates levied on land rental is a payment coming out of the tenant's pocket, we are confronted with 2,000,000*l.* of special and peculiar taxes, whose incidence has been frequently a subject of complaint. Beyond contrasting the charge of 6 per cent. on his income thus falling on the farmer, with the average of the less than 1½ per cent. imposed on house occupiers of the upper and middle classes generally, it may be well to defer a closer inquiry into these local charges to a later stage of this Paper.\*

Agricultural  
share of taxes  
on property or  
income.

The position of upper and middle class agricultural incomes in reference to direct charges is the next point of inquiry. The Table subjoined shows the shares of each of these imposts, which a careful inquiry indicates as falling collectively on the owners and occupiers of British farms.

\* See p. 153.

Taxes on Property or Income.	Amount falling on Upper and Middle Class Incomes generally.	Share of Tax specially affecting Agricultural Incomes.
	£	£
Legacy, Succession, and Probate Duties, including court fees .. .. . }	6,000,000	900,000
Stamps on Deeds .. .. .	2,100,000	600,000
Land Tax .. .. .	1,100,000	825,000
Income Tax (1) on income from capital ..	3,600,000	855,000
Ditto (2) on earnings .. .. .	1,700,000	135,000
Railway Duty .. .. .	700,000	..
<b>Total Imperial Taxes .. .. .</b>	<b>15,200,000</b>	<b>3,315,000</b>
<b>Add Local Rates, owners' share .. ..</b>	<b>16,950,000</b>	<b>6,000,000</b>
<b>Total .. .. .</b>	<b>32,150,000</b>	<b>9,315,000</b>

If these figures be accepted it would appear that, with the widest differences in details, the common average pressure of this section of taxes on the 580,000,000*l.* which make up the whole series of incomes enjoyed by the upper and middle classes is  $5\frac{1}{2}$  per cent. These incomes spring, however, from the most varied and diverse sources. The ownership or the farming of land, the possession of house property, the interest of personal wealth or capital, the business of the merchant, tradesman, or manufacturer, as well as the earnings of professional and salaried persons, all help to swell the total, and between each sort of income great divergence of burden may on investigation be found to exist.

Only the first two of these series of incomes can be reckoned "agricultural," and upon these exclusively falls the 9,315,000*l.* shown in the right-hand column of the Table. Now, these agricultural incomes together make up just 100,000,000*l.*; so that a burden of more than  $9\frac{1}{4}$  per cent., or nearly twice as much as the collective average on all sorts of income belonging to the middle and upper order of society, is charged on the agricultural class in the shape of direct taxes on property or income.

## CHAPTER III.

## IMPERIAL DIRECT TAXES.

A BETTER insight into the character of the special taxes last mentioned, and a truer appreciation of the chief burdens that affect the British agriculturist will be gained by looking at each impost in detail, when it will be noticed that every effort has been made to avoid overstatement in the quotas credited to the agricultural classes.

The group of duties falling on transmission of real and personal estate at death make up the largest item of the imperial taxes here enumerated. On the capital of owners of land there will fall of these charges—the share of the succession duty borne by land as distinguished from houses or other real property, together with a minor quota both of the probate duty chargeable on leasehold estates and of legacy duty on lands devised for sale. Assuming that rather less than half of the succession duty (which is taken at 830,000*l.*) will fairly represent the ratio borne by land *per se* to the other real property of the country, a sum of 400,000*l.* is allotted as agricultural under this head, to which must be added at the most modest computation (as those familiar with the question will admit) at least 100,000*l.* more on account of the leaseholds and devises above referred to. But there is yet to be added the share of these duties to which the capital of the agricultural tenant is subject. Bearing in mind the extra severity of the probate duty on the smaller personal estates usually possessed by farmers, no estimate of the burden thus entailed can take the average combined pressure of probate and legacy duties on so much of the tenants' income as represents the interest on his invested capital at less than 3 per cent. His share of this tax cannot therefore well be placed below 400,000*l.* When the very different magnitudes of landowners' and farmers' capital are remembered, these figures incidentally illustrate the often-quoted excess of pressure exercised by what are called "Death duties" on personal as distinguished from real property—a statement truthful in itself, but one which, owing to a remarkable narrowness of fiscal view, has been occasionally supposed to prove the lighter general taxation of real estates. As a matter of fact, however, whatever financial favour is in this one aspect showed to realty is very much more than counterbalanced by another series of exceptional and heavy taxes.

In the case of the next tax dealt with, "*Stamps on Deeds*," I have taken a somewhat smaller share than was allowed in

Probate,  
legacy, and  
succession  
duties.

Stamps.

1869, in statistics furnished by the Inland Revenue Department, or in those adopted by Mr. Goschen in his recent Report. In the former case the whole, and in the latter instance three-fourths, of this item was reckoned to fall on real estate. Believing that not more than two-thirds so falls, I have taken 600,000*l.*, which is less than one-half of this reduced quota, as fairly representing the share likely to be contributed to the revenue in the form of stamps on such deeds as are connected with the transfer and management of landed property.

The so-called *Land Tax* was, strange to say, by no means in its origin or intent a special impost on the soil, as its present name might appear to imply. The legitimate successor of one of the oldest of our taxes—the “subsidy” usually voted by our Parliaments up to the middle of the seventeenth century—the land tax, was meant to be what we now call a general income or property tax. In its present shape it took its rise from the assessments of the financiers of the Long Parliament, who, during the altered social circumstances of the Commonwealth, discovered the inadequacy of earlier methods of providing for the cost of Government. When in the reign of Charles II. a variety of excise duties increased the indirect fiscal liabilities of the whole community, so-called “aids,” or direct charges on realized estates, accompanied them. After the Revolution of 1688, still larger revenues were needed, and a more systematic organisation of these direct charges being attempted, the present tax was formally established. It, however, referred not to land alone, but to all known and notable sources of wealth, and, curiously enough, the earlier statutes lay more stress on the taxation of personal than real estate.\* The first Land Tax Act, passed in 1692, set out by enacting, “That every person, body politic and corporate, having any estate in ready monies, or in any debts owing to them, or having any estate in goods, wares, merchandise, or other chattels, or personal estate whatsoever within this realm or without, shall yield and pay unto their Majesties four shillings in the pound according to the true yearly value thereof; that is to say, for every hundred pounds of such ready money and debts, and for every hundred pounds worth of such goods, wares, &c., or other personal estate, the sum of four-and-twenty shillings.”† It then imposes a further duty of 4*s.* in the pound on offices or employments of profit, and only in closing stipulates for a supplementary charge on land rental in these terms:—“And to the end a further aid and

\* See 13th Report of the Inland Revenue Commissioners, 1870.

† It should be explained that 6 per cent. being at this time the legal interest of money, an annual charge of 24*s.* per 100*l.* of capital was equivalent to a tax of 4*s.* on each pound of yearly interest.



supply for their Majesties occasions may be raised by a charge upon all lands, tenements, and hereditaments, &c., be it enacted that all manors, messuages, lands and tenements, and all quarries, mines, tithes, tolls, &c., and all hereditaments, of whatsoever nature they be, shall be charged with the sum of four shillings for every twenty shillings of the full yearly value."

Although minute rules were laid down for the "better discovery of personal estates," and although these reappeared in the Acts of 1697, fixing the quota to be levied, and even in 1797, a century later, these efforts seem practically to have failed, and while the share of the tax on land was retained, personal estates were, in 1833, formally exempted. When, either accidentally or through carelessness in the more difficult task of local assessment, the produce of personal estate under the Land Tax Act had been reduced to nearly nothing, Mr. Pitt, in 1798, made the burden perpetual at the quotas for each district fixed on the valuation of the previous century. He gave at the same time a power of redemption, which was so largely acted upon, that in that year and the next 436,000*l.*, or more than one-fourth of the tax, was finally redeemed. Since that date redemption has proceeded more slowly, the total thus wiped out being now 826,000*l.*

The amount levied as land-tax in Great Britain (for Ireland is exempt) is now 1,100,000*l.*, and I have taken three-fourths of this as actually falling on land rather than houses, that being something like the ratio which held good between these sections of real property, when the tax was stereotyped at the beginning of this century.

The distribution of the tax is of the most curiously irregular character. Not only is there great discrepancy between the relative values of different districts now and in the seventeenth century, but other strangely disturbing features attended the earlier assessment when the local returns are said to have varied in their magnitude according to the loyalty of particular areas to the reigning Sovereign. This may partly explain the very light quota paid by Scotland. By far the heavier weight falls on the agricultural counties. A few years ago the rate of charge in Bedford, Berkshire, or Wilts exceeded 3 per cent., while in the populous areas of Lancashire, Durham, or Yorkshire it fell below 1 per cent., and in individual instances the anomalies of its incidence are very much more glaring. It must not be overlooked that, although the 825,000*l.* I have allotted to land proper may be the measure of the special payment exacted yearly, the landowners might in fairness claim to have added to the burden thus imposed a similar share (three-fourths) of the annual value of the land-tax redeemed. To effect this redemption, capital has



been sunk, the interest of which thus yearly lost would be equivalent to another tax of 620,000*l.* per annum, for which I have not here taken credit.

Greater interest centres in the code of imposts, collectively known as the "*Property and Income-tax.*" Introduced by Mr. Pitt in 1803 and discontinued in 1816, the income-tax was revived by Sir Robert Peel in 1843 to repair a chronic deficit and provide the means of largely reducing indirect taxes. Since that time it has formed a conspicuous element of our financial system. Although, unlike the last impost, this tax now extends to Ireland, it should be borne in mind that its pressure on that division of the United Kingdom is not equally severe with that elsewhere, since the land rental of Ireland is now assessed under a somewhat inadequate valuation. Including this assessment, however, the gross annual value of the land of the country is placed at 67,000,000*l.* But from this figure must be deducted all properties wholly exempted as being under 150*l.* a year, or so far as by recent legislation they enjoy abatement to the extent of 120*l.* a year where below 400*l.* A considerable number of minor landed incomes, thus probably escape contribution; while a tax of 3*d.* in the pound on the remainder brings in 790,000*l.*

As regards all but the smallest owners, the income-tax is, of course, virtually a second and more uniform land-tax. Although charged at the same poundage rate as other assessed incomes, it has yet been shown by Mr. Gladstone, in his great Budget speech of 1853, that this nominal equality of rate must not be assumed too readily to mean an identity of burden. Thus, under Schedule A of the tax, all the rent of every inch of land in the country, less some very strictly limited deductions,\* appears in the gross assessment. Under Schedule D, however, through which trades and professions pay, a very different practice holds good. The return of profits is here self-assessed, and large amounts, we are officially told, thus escape the proverbial vigilance of tax surveyors. Mr. Gladstone, in the speech referred to, gave one instance where twenty-eight persons, whose voluntary assessment for income-tax under this schedule showed only 9000*l.* of annual profits, at the same time claimed compensation for disturbance of their business premises on the scale of an annual profit of 48,000*l.* a year, and were actually awarded compensation by a competent jury at the rate of 27,000*l.* a year, or three times

---

\* One, it should be noted, is the land-tax, on the amount of which an owner is of course, not properly chargeable. Except north of the Tweed, probably not more than one-half, however, of the landlords appear to take the trouble to claim and secure this small allowance.

their tax assessment. The Inland Revenue Commissioners, in 1868, formally estimated the gross amount of income thus fraudulently withheld from assessment under Schedule D at no less than 57,000,000*l.* a year—a sum not far short of the whole land rental of the kingdom. Although I have allowed, in estimating the gross income of the middle and upper classes, for some margin of unreturned profits, as well as for incomes not reaching the limit of the tax, I have not ventured to assume that quite so great a fraud as this is still committed, since the lower duty of recent years is known to have exercised a healthy and bracing effect on the public conscience. Still it remains undoubted that nothing like the same precision of assessment can be applied to trading as to landed incomes. Instances of reckless overcharge may exist, or special business considerations may occasionally induce acquiescence in too highly-scaled assessments, but, on the whole, there is little room for doubt that 3*d.* in the pound on easily ascertained income from land is a much heavier tax than 3*d.* in the pound on the produce of voluntary trade assessments; and, in point of fact, this excess of pressure has been justified as giving indirect effect to the opinions of some economists that higher rates should be charged on landed than on other incomes.

But the inequality does not end here. Trade incomes are calculated with full deduction of the average repairs of all premises, implements, and utensils employed in business, for bad and even doubtful debts, for parochial rates, for wages, clerks, shopmen, or assistants, for stationery and the other petty outlays. The landowner has no such allowances. Speaking collectively of both house and land rentals, Mr. Gladstone, on the occasion before referred to, lent his high authority for the statement that quite 16 per cent. should be deducted from the nominal figures of Schedule A to ascertain the net income which actually paid the tax. Although treating now of land alone, it can therefore be no extreme estimate to put at some 8 or 10 per cent. the margin of outlay incurred for repairs, management, arrears, and so forth, and yet taxed as if it were net income received.

The manner of assessing the tenant-farmer to income-tax differs in another way from the ordinary practice. Schedule B, which deals with him, takes the gross rent of land, including the tithe-owner's as well as the landowner's share of rental, one-eighth deduction being allowed from this figure, which is further subject to the general exemptions and abatements that define the limit of the tax. These very materially reduce its scope and incidence. In England 38 per cent., in Scotland 44 per cent., and in Ireland no less than 70 per cent. of the gross rental thus escapes chargeability. The tenant is moreover charged not the full rate of the tax borne under other schedules, but a

lower one, calculated on the theory that the farmer's profits are in England equal to one-half, and in Scotland and Ireland to one-third only of his rent, an assumption not always realised in late years, but apparently, as has been already shown, not very far removed from a fairly accurate average. Should his profits actually fall below this assumed proportion, a right of relief is secured to the farmer where this can be shown by his books. But either the too usual absence of methodical book-keeping, or, as is sometimes said, the difficulties attending the date fixed for this appeal, prevent much resort to this provision. The net produce of this schedule is now 200,000*l.* a year, a tax which must be viewed as borne solely by the larger grade of farm occupiers.

CHAPTER IV.

LOCAL TAXES.

THERE now remains but the agriculturally incident share of Local rates. the local rates to be considered. These, for a general review, must first be regarded irrespective of the assumed division of the ultimate incidence between the owners and occupiers of rated property. So far as England by itself is concerned, we now possess tolerably clear statistics of local finance which, though not yet complete in all points, enable a fairly close estimate of the distribution of the several local rates to be thus attempted :

Rate.	Levied in			Total.
	The Metropolis.	The Urban Districts.	The Rural Districts.	
	£	£	£	£
Poor Rate (proper) .. ..	1,500,000	2,800,000	3,300,000	7,600,000
Highway Rate .. .. .	..	400,000	1,500,000	1,900,000
County Borough and Police Rates .. .. .	800,000	1,400,000	1,400,000	3,600,000
Sanitary and other Improvement Rates .. .. .	1,900,000	6,400,000	400,000	8,700,000
Education Rates .. ..	400,000	300,000	200,000	900,000
	4,600,000	11,300,000	6,800,000	22,700,000

Now it is not of course the whole sum levied even in strictly rural districts which falls exclusively on agricultural land. A still further analysis is required to get even approximately at this Share of the rates levied on land.

share. After, however, taking sample cases from all parts of the country, I am confident no great error will be committed by assuming that 80 per cent. of the rateable value, and therefore 80 per cent. of the rates of these areas will be found to fall on land apart from houses and other property. To these, however, must be added a small though a certain share of the urban rates. The large acreage of land included in many English urban sanitary districts—and even in occasional boroughs—forbids me to estimate this share at less than 5 per cent. If these data be accepted, the rates falling on land alone appear to be in England,—

	£
(1.) In the metropolis . . . . .	practically <i>nil.</i>
(2.) In the urban districts, 5 per cent.	560,000
(3.) In the country 80 per cent. . . . .	5,400,000
	Total . £6,000,000

To this must be added for

The share of rates on land in Scotland	600,000
The share of rates on land in Ireland	1,400,000

Total on land in United Kingdom . £8,000,000\*

These local rates present a body of taxes important in their amount and peculiar in their incidence. Assuming that the rateable value of land bears now the same percentage to its income-tax assessment as in 1870, the net rental on which this quota of the rates is levied is no more than 57,000,000*l.* a year, so that were they uniform over the whole United Kingdom, they would alone represent a tax of no less than 14 per cent. on this valuation.

These local rates are, however, very far from uniform in their pressure. Although there may be a certain minimum everywhere levied, they are wholly local in their origin, administration, and incidence. The agricultural incomes of one county union, or parish, do not, therefore, necessarily bear the same burden as those of another. The chief rates deserve notice in greater detail, although the absence of full information from other divisions of the United Kingdom restricts attention chiefly to those levied in England alone.

Poor-rate.

The English *Poor-rate*, a special tax levied for the relief of destitution, is the most important of all the local burdens which affect agricultural districts. Although no formal enactment, as in Prussia, Denmark, or Sweden, confers on English paupers

\* Three-fourths of this sum, being the assumed share of rates on land borne by the owners, will be remembered to have been entered among the direct charges on agricultural income at p. 137.

a right to relief which he can legally enforce, a more or less qualified obligation on certain authorities to relieve the destitute has so long existed, as to lead, in practice, to the usual assumption that the pauper has to be maintained at the public cost.

Very early in our history, stringent laws against vagrancy and begging were passed, and attempts were made to regulate the charity of individuals. Social changes, and the dissolution of the monasteries in the sixteenth century, led to more systematic but unsuccessful efforts to stimulate and organise voluntary aid to the poor by means of alms collected more or less directly under ecclesiastical sanction. Finally, in statutes of the reigns of Henry VIII., Edward VI., and Queen Elizabeth, we find the germ of our modern Poor Law system; while an Act passed in 1601, in the 43rd year of the latter reign, finally established the parochial tax, now familiar as the Poor-rate. This rate was imposed by law on every inhabitant, parson, and other and every occupier of lands, houses, and certain named sorts of fixed property. Although intended to sweep up what it termed the whole "ability of the parish," the taxation of stock-in-trade and personal property which the Act required, but which must always have been attended with great difficulty, and which was in early times of very secondary importance, was gradually dropped in practice, and is now annually suspended by a special exemption Act. The Poor-rate thus became—in spite of the apparent belief of its framers that they could tax the occupiers of lands or houses without affecting these properties themselves—a direct and heavy impost on the several hereditaments which were incidentally named in the statute, and which seem to have been specifically indicated more as measures of ability than as the objects of a tax.

The dimensions of this rate were not, however, great until the close of the eighteenth century, when a lavish distribution of outdoor relief arose, and an extensive employment of the tax in supplementing the scale of wages (necessitated by a period of war and high prices throughout the country), quadrupled the tax in the lifetime of a single generation, and involved the levy of a Poor-rate of more than 9,000,000*l.* in the year 1818. Although lower totals subsequently prevailed, the pernicious consequences of mal-administration entailed a very oppressive burden on the ratepayers, both agricultural and urban; and the Report of the Poor Law Commissioners of 1833 revealed a state of matters in which this tax, which in the previous century had showed an average of but 2*s.* per head on the population, was then in some districts 30*s.* and even 40*s.* a head, and threatened to swallow up the whole rental of property.

This Report secured the great Poor Law Reform of 1834, which in three years reduced the rate by 36 per cent., and



supplied a better system. For Poor Law purposes the country was then mapped out into 650 unions or groups of the parishes which formed the older area of this as of other functions of local government. The districts so formed are usually unique in their area, and non-coincident with either county, municipal, or other boundaries; their limits being generally determined by the locality of the several workhouses, the use of which was a prominent feature of the reformed system.

Its purposes.

The primary object of this rate is the relief of destitution, but to this obligation legislation has added duties more or less closely kindred, among which are to be noticed the cost of providing exceptional treatment for lunatic paupers; the cost of locally registering births, deaths, and marriages; the costs of public vaccination; the costs of local assessment, and those incident to the preparation of jury lists and the registration of Parliamentary electors.

A variety of other local rates are also now collected with and under the general name of Poor-rate, but the above items are the chief matters properly so regarded and administered by Boards of Guardians—bodies partly elective from the rate-payers on a scale of graded voting, and partly formed of resident local magistrates.

Agricultural share of the poor-rate.

Perhaps the best notion of the apportionment of the whole 7,600,000*l.* of the Poor-rate (proper), and especially of the share of each of its objects borne by agricultural incomes, may be got from the following statement, which is based on the actual figures given for the metropolis, and on the ratios between urban and rural areas already adopted in the calculations I have submitted.

Number of Paupers.			Areas.	Expenditure out of Poor Rate Proper.				
In the Work-house.	Out-door.	Total.		Maintenance in Workhouse.	Out-door Relief.	Maintenance of Lunatics.	Other Outlays.	Total.
40,000	59,000	99,000	(1) Metropolis ..	£ 464,000	£ 245,000	£ 183,000	£ 608,000	£ 1,500,000
103,000	547,000	650,000	(2) England (excluding the Metropolis) .. ..	1,070,000	2,516,000	700,000	1,814,000	6,100,000
143,000	606,000	749,000	(3) All England ..	1,534,000	2,761,000	883,000	2,422,000	7,600,000
47,000	252,000	299,000	(4) Urban Districts, being 46 per cent. of (2) .. .. .	492,000	1,157,000	322,000	834,000	2,805,000
56,000	295,000	351,000	(5) Rural Districts, being 54 per cent. of (2) .. .. .	578,000	1,359,000	378,000	980,000	3,295,000
47,000	249,000	296,000	(6) "Land" only, being 80 per cent. of (5), and 5 per cent. of (4) .. ..	486,000	1,145,000	319,000	826,000	2,776,000



Thus it will be seen that two-fifths of the agricultural share of this particular rate is expended in out-door relief distributed among upwards of a quarter of a million paupers. A little more than a fourth goes to maintain in workhouses and asylums a smaller contingent of the pauper army, while the remainder is either absorbed in providing the necessary buildings, staff, and accessories incident to a system of poor relief, or devoted to other matters which, for the sake of convenience, are administered by Poor Law authorities.

The average poundage rate throughout all England, is now returned as 1s. 2 $\frac{3}{4}$ d. Though this is a lower point than has sometimes prevailed, its value as an index of burden is but little, owing to the shifting which has taken place in the standard of assessment, which is now a closer approximation to the full value than at any previous period. Thanks, however, to improved administration and the recent prosperity of the working classes, there is no question that a welcome reduction has of late been effected in the numbers of English paupers, who now form only 3 per cent. of the population against 5 per cent. thirteen years ago; while the total charge imposed by the system of relief, which eight years ago equalled a poll tax of 7s. on each head of the population, has now sunk to 6s. a head.

The pressure of the Poor-rate varies, however, greatly in different localities, and is peculiarly amenable to reduction by careful administration. A very marked contrast is presented between the northern and north-western section of the country and the eastern, south midland, and southern counties: On the one hand we see the average outlay for relief in Durham or Lancashire to be less than 4s. 3d. per head of the population; while, on the other hand, in Wiltshire 9s. 7d. per head will be expended, in Cambridgeshire 8s. 10d., and in Sussex 8s. 8d. The distinctively agricultural districts usually show more pauperism than the dense, busy, and wealthy centres of industry. Yet the more northerly of our distinctly agricultural counties show that heavy pauperism is no necessary characteristic of a country population. Dorset, in the south, by placing one sixteenth of her population on the pauper roll, spends 8s. 4d. a head of her people in relief, and thereby subjects her land to a tax of 1s. 9d. in the pound. Hereford, in the west, and Suffolk, in the east, spend 7s. 5d. and 6s. 11d. per head, and thereby incur a tax of 1s. and 1s. 4d. in the pound respectively. In the north, on the contrary, Westmoreland resorts to the Poor-rate for assistance in the case of only one thirty-seventh part of her inhabitants, and, spending but 4s. 10d. per head in relief, her rental escapes with a tax of 8 $\frac{1}{2}$ d. in the pound.

Local distribution of the poor-rate.

Individual instances of separate unions, selected as distinctly

agricultural, tell the same tale. I have taken seven of these in the counties of Lancashire, Yorkshire, Shropshire, Warwickshire, Nottinghamshire, Gloucestershire, and Kent, where land alone forms 86 per cent. of the rated rental, and there I find an average Poor-rate of only 9¼d. in the pound. Yet, turning to the counties of Norfolk, Essex, Northampton, Buckingham, Denbigh, Devon, and Wilts, in seven apparently similar unions of nearly equal area, and with 80 per cent. of land in their assessment, the average Poor-rate is more than twice as high, or 1s. 7½d. in the pound. Although, therefore, like the Land-tax, the Poor-rate has become what in its original intent it never was meant to be, a heavy and exceptional charge on one form of property, and as such weights agriculture heavily in the general scale of British taxation, it should not be forgotten that in one sense a great part of its burden, as regards districts if not individuals, holds something of that voluntary character which I have noticed in our indirect and avoidable taxes. Its average rate on land of some 6 per cent. may, by discreet administration of relief, be reduced as low as 3 per cent., a result which would not only afford a very important relief from taxation, but would secure the great attendant advantage of a less pauperised and more independent population.

Highway-rates.

The *Highway-rates*, or local charge for road-repair, represent the old common law liability of each parish, by which it was held responsible for its own highways. The duty of repairing these was, in early times, enforced by statute on all the inhabitants; and as in the case of other ancient local taxes, personal as well as real estate was, three hundred years ago, directed to be taken into account in measuring individual contributions.\* Not till the reign of George III.† was the maintenance of all roads charged exclusively on the occupiers of lands and houses in the definite shape of a Highway-rate. The total amount now levied for this purpose is little more than one-fifth of that required for poor relief, but the average charge in different areas varies very greatly with local circumstances, the proximity of good material for road repair, and the skill and carefulness of the administration. So far as they are levied in rural districts, Highway-rates are of two sorts: (1) those administered by Boards acting for districts formed of groups of parishes, in which case the rates are collected along with the general Poor-rate; and (2) those still levied parochially under an older system. Co-existent with these systems, for the past 100 years, has been another mode of repairing certain main roads by means of tolls levied by Turnpike Trusts. These trusts are now, however, being rapidly

\* See 18 Eliz. c. 10.

† See 7 Geo. III. c. 42.

permitted to expire, and considerable dissatisfaction is at the present time expressed at the additional burden thrown upon comparatively limited areas for the maintenance of thoroughfares more or less usually devoted to other than local traffic, but no longer kept up by special tolls levied on those who use them. Under these circumstances a large increase of Highway-rate has been experienced in certain parts of the country, still further varying the agricultural aggregate of taxation beyond the more common average.

Probably the oldest of English local imposts are the *County-rates*.  
*County-rates*, with which are now included *Police-rates*. The share of these taken as falling upon land, though diminished as in the case of the metropolis—where a large area of purely urban property pays *County-rates*—must still include urban contributions, since many towns within county bounds either do not possess or do not exercise all usual municipal functions. But, on the other hand, municipal charges are not infrequently found to fall on land lying within borough limits. Collected along with the *Poor-rates*, the *County-rates* are administered by the Justices in Quarter Sessions. The dimensions of these rates are, however, very largely determined by the control of central authorities—their chief objects being to defray the cost of criminal justice, local gaols, constabulary, and lunatic asylums. Recent legislation has recognised the imperial rather than local character of these charges, and by State subventions the local ratepayers have been relieved from part of the outlay thus incurred for the public service, while by an Act of last Session the county prisons have been wholly transferred to the Central Government, to be managed on a uniform system and at the cost of the general taxpayers of the country. These alterations have been due to the admission by the Legislature of the peculiar pressure of local rates for properly national purposes on both agricultural and urban ratepayers. Further important changes are believed to be now pending as regards the administration of county rates, which, along with other county matters, it is proposed to entrust to mixed boards of a more or less elective character.

Among *Sanitary and Improvement-rates* I have classed the *Sanitary rates*, general charge on rural districts for Officers of Health and Inspectors of Nuisances required by recent legislation, and the special charges for sewerage, water-supply, and other local works in separate parishes. To these I have added the taxes raised by sewer, drainage, and embankment authorities, for the purposes of land protection and reclamation in such districts as the Fens, where various works of this nature exist. The last, and, in some respects, the immediately preceding varieties of these burdens are, it may be said, not essentially taxes. They correspond,

however, with similar but much larger town imposts for the specific advantage of rateable property, and being, at all events, statutable applications of individual contributions for a public purpose by public bodies, they cannot be wholly excluded from a general survey. The extent of these taxes is relatively small; while the new Sanitary-rates, the administration of which is entrusted in each union to the rural portion of the Boards of Guardians, have as yet only begun to be felt in country districts.

Education-rates.

The *Education-rates* are also modern imposts. Dating only from 1870, they are levied where School Boards are voluntarily formed, or where they are enforced by the Central Government in consequence of the failure otherwise to provide the local facilities now required for elementary education. At the date of the last Report from the Privy Council, 2346 of the 14,000 non-municipal parishes of England were placed under these new Boards and subjected to this new rate. Several of these areas possess so much of an urban character that I have credited their rates to town districts. The School Board-rate is thus necessarily varied in its pressure, and confined to particular districts, since the funds which in one locality are thus raised by a tax on all ratepayers, are in others provided by voluntary subscriptions. The average incidence of this rate in those rural areas where it is levied exceeds the present amount of the imperial income-tax; and being charged on their full rentals, it represents to farmers a wholly new tax of twice this magnitude. In upwards of sixty cases, indeed, a tax of 1s. in the pound, or 5 per cent. and upwards, on rental, has thus occurred, and considerable irritation is consequently felt in agricultural districts at the large additional taxation involved in the Education-rate.

Variations in the systems of local rating.

Not only do the local taxes generally exercise a very heavy pressure on British agriculture, but the mode also of their imposition practically tends, especially in England, to discourage the application of fresh capital to the cultivation of the soil, by exposing to immediate assessment funds which, till they were thus applied, bore only the much lighter fetters of imperial taxes.

The English valuation for local taxes does not, as is the case in Scotland and Ireland, recognise any claim on the part of new agricultural improvements to a postponement of the special liabilities of older landed property. The provisional exemption of agricultural enterprise, by which a Scotch farmer is secured from higher assessment during the currency of his usual 21 years' lease, and by which Irish agricultural improvements are also viewed with fiscal favour, does not hold good south of the Tweed.

Scotch and Irish rates.

Nor is this point the only one in which material differences

mark the mode of levying local taxes in the three divisions of the United Kingdom. In England all are charged on and collected from the occupier. In Scotland certain rates such as County-rates are levied directly on the landowner; while others such as Poor and Education-rates are charged in moieties on the landlord and the tenant. The latter practice prevails also to some extent in Ireland.

In Scotland, too, for a much longer period than elsewhere, attempts were made to continue the older liability of personal as well as real property to the Poor-rate by assessing "means and substance" as well as land rental to the tax. This practice there, as elsewhere, encountered many difficulties, but it only legally ceased seventeen years ago, and over about one-third of the rateable area of that country an endeavour is still made to mitigate the rigid inequality of a rate which, as regards occupiers, measures their ability to pay solely by their rental. This practice, which, so far as it goes, is favourable to agriculturists, consists in the imposition of a graded rather than an equal rate, charging the rentals of dwelling-houses, offices, shops, and farms at varied scales; occupiers of land frequently paying only one-third or one-fourth of the poundage rate levied on residential premises. To a minor extent the principle here acknowledged is, in the case of special works of a sanitary character, acted on in England, where land pays one-fourth of the rate charged upon houses.

---

## CHAPTER V.

### RELATIVE PRESSURE OF TAXATION.

SUCH varieties of systems as those last alluded to are, however, no more than exceptions to the ordinary rule that local taxes for the most part fall with uniform directness on the rentals of certain fixed sorts of property. Among these, land is necessarily conspicuous, and it thus appears that agriculturists are in consequence, more largely affected by taxes levied in local areas than by those received into the national exchequer. This is at once apparent if the conclusions already reached in this inquiry be recalled to mind, and the several percentages of charge on purely agricultural and on upper and middle-class incomes generally be contrasted. Following the general classification of taxes before resorted to, the pressure of the several forms of taxation may be thus grouped:—

Relative pressure of local and imperial taxes on agricultural incomes.



	On all Upper and Middle Class Incomes collectively.	On purely Agricultural Incomes.
I. TAXES ON PROPERTY OR INCOME.		
(1) Imperial taxes, average .. .. .	2½ per cent.	3¼ per cent.
(2) Local taxes (owner's share of rates), average	3 "	6 "
II. TAXES ON EXPENDITURE.		
(1) Imperial taxes on consumption, average ..	2¾ "	2¾ "
(2) Imperial taxes on other outlays, average ..	1¼ "	1¼ "
(3) Local indirect taxes, and occupier's share of rates, average .. .. .	2 "	2½ "
Total taxation .. .. .	11½ "	15¾ "

While therefore the incomes of the whole upper and middle classes of society bear an average burden of  $6\frac{1}{2}$  per cent. of imperial, and 5 per cent. of local taxes, those of agriculturists pay  $7\frac{1}{4}$  per cent. of the former, and as much as  $8\frac{1}{2}$  per cent. of the latter imposts.

Varied origins of the incomes here contrasted with those of agriculturists to be taken into account.

But though these are the general results of the calculated share of each set of taxes, certain qualifying considerations still demand attention. A knowledge of the average taxation of the whole series of upper and middle-class incomes requires to be supplemented by some acquaintance with the very varied incidence, especially of local taxes, on the several distinctive forms of income of which the collective total is made up. But for the extent to which some of these participate in certain of the fiscal liabilities of agricultural incomes, a much wider contrast than that just given would be apparent. The incomes grouped together in the first column of the Table come from separate and distinct sources. One-third of the whole is derived from salaries, or personal earnings; one-fourth is furnished by the interest of invested capital; agriculture itself furnishes one-sixth of the total; a precisely similar quota springs from the rental of house property; while the remainder, or about one-tenth part of the whole, represents the net revenue of railway, canal, mining, and other rated properties. Out of all these forms of income is paid so much of the local rates as is deemed to fall upon the occupiers of dwelling-houses, while on one fraction of the joint agricultural income must fall the share of rates assigned to the occupiers of land. The remaining, or land-owners' section of the agricultural income, that of the house-owner, of the holder of railway, canal, or other rated property, form together about five-twelfths of the whole upper and middle-class revenue, and this section bears exclusively the incidence of the owners' share of local rates.



The mode in which this incidence affects these owners is, however, exceptional. These rates are no payment by them out of net income already received. They are deductions from revenue which, but for the rates, would be receivable by the owners, so that the accurate measure of their pressure is a slightly lower percentage than would appear if it were calculated on the net rental which reaches the landlord's pocket.

Peculiarities of rate-incidence.

From the total of the rates, officially returned as such, I believe it is also necessary, when we come to discriminate thus closely into the question of relative burden, to eliminate, as not possessing a thoroughly fiscal character, such rates on land as those required for drainage and embankment, and such rates on houses as are mere payments for commodities, like gas or water, or which are avowedly investments for the private or peculiar benefit of rated properties.

Reducing, therefore, the gross percentage by both of the two last considerations, a careful analysis of the items of what I have called owner's rates will show that the percentage by which they reduce the landlord's agricultural income is 8 per cent., that on the house-owner's income it is  $6\frac{1}{2}$  per cent., and that on the average holders of railway and other specially-rated incomes it is  $3\frac{3}{4}$  per cent. Adopting, therefore, the ratios thus slightly reduced, I will try roughly to present in a tabular form \* a closer analysis of the relative fiscal position of agricultural incomes with those of each of the several sections into which upper- and middle-class revenues may be divided.

Relative total taxation of separate sorts of incomes.

Since, however, it is desired not only to show the probable charges borne by both partners on the collective revenues of the agricultural firm, but to discriminate between the apparent shares of the land-owner and the land-occupier in all these burdens, I attempt also to supply separate estimates of their relative taxes. It is often argued that, whatever may be the case in regard to houses, and the partial incidence of the town-rates on their occupiers, political economy forbids us to regard a rate on land as ultimately incident elsewhere than on the owner of the soil. A regard, however, to the primary pressure inseparable from the modern increment of rates, a remembrance of the friction and frequent absence of exhaustively rigid bargaining between landlord and tenant, as well as the undoubted difficulty which the farmer, whose capital is attached ever so lightly to the soil, must feel in removing it, with every change of local burden, have all led me to follow in this matter the opinions which have been repeatedly given on good authority, and which credit an average of one-fourth of the rates on land to the occupier, and

\* See p. 155.

three-fourths to the owner of the farm. These proportions have been adopted in the preceding Tables, and are assumed in that given on the opposite page, where I have selected as the uniform income for typical comparison a yearly revenue of 399*l.*, a point where, in consequence of the otherwise heavy pressure of middle-class taxation, a special abatement of 120*l.* has been lately accorded in the case of income-tax.

Such a Table as this necessarily offers but a very rough and general view of relative taxation. Were it extended to incomes of other dimensions, many further varieties would appear; and with larger revenues the percentage of indirect taxation would be materially lessened. If, however, the picture now presented be even approximately correct, the British agriculturist must be acknowledged to bear a very considerable share of the taxation of his country.

The Landlord's  
taxation.

The landowner, even when he takes into consideration both the stamp-duties attending the transfer of his property during life and the relatively lighter ratio of his duties on succession, will still find himself paying in one respect on a lower scale than the capitalist of equal income, whose investments are in Bank Stock or in the Funds; but he will place against this item the extra, if somewhat irregular, liability of the land-tax chargeable on his acres, and the large sum diverted from his rental to the public service in the shape of local rates. By these the balance is much more than redressed, his yearly taxes doubled, and more than 16 in place of little over 8 per cent. of his income is thus spent for him by the kindly intervention either of central or of local government authority.

The farmer's  
taxation.

It may not be without interest in connection with the contrasts here drawn, to go one step further, and, in the case of the second agricultural tax-payers in this Table, to point out in detail in what form his several taxes may be actually contributed. Such a tenant-farmer as that referred to in column 2 may farm 600 acres, for which he will pay in rent and tithes 798*l.* a year, while he employs 5000*l.* of capital in his business.

He may be supposed first to encounter the requirements of the State when, on succeeding to this sum, he proves his father's will, and pays down a probate duty of 100*l.*, and a legacy duty of 50*l.*; payments which, if regarded as spread over the probable thirty years of his tenancy, gives the first item of 5*l.* per annum.

His income-tax is a lighter burden. From his gross rent one-eighth is first of all deducted for tithes elsewhere chargeable, and his profits being assumed to be half his rent, he is then charged at 1½*d.* in place of 3*d.* in the pound. Since, however, by this assumption he is allotted an income just under 400*l.* a year, he has a further abatement allowed in the shape of

RELATIVE TAXES PAID BY SEPARATE INCOMES OF 399L. A-YEAR, FROM THE UNDERMENTIONED SOURCES.

TAXES.	Agricultural Incomes.		Other Upper and Middle Class Incomes.			
	(1). From Ownership of Land* only.	(2). From Occupation of Land only.	(3). From Ownership of House Property.*	(4). From Ownership of Railway, Canal,* Mining, and other Rated Property.	(5). From Ordinary Personal Capital.	(6). From Professions or Salaries.
1. On the transmission of property during life or at death .. .. .	£ s. d. 5 18 0	£ s. d. 5 0 0	£ s. d. 7 9 0	£ s. d. 9 4 0	£ s. d. 9 12 0	£ s. d. ..
2. On income, including Land Tax, Income Tax, and Railway Duty .. .. .	7 10 0	2 17 0	4 5 0	8 2 0	3 10 0	3 10 0
3. On the consumption of taxed commodities .. .. .	9 18 0	10 16 0	10 1 0	10 7 0	10 16 0	10 16 0
4. On other items of expenditure (except occupiers' rates) .. .. .	6 17 0	7 8 0	6 19 0	7 3 0	7 8 0	7 8 0
5. Share of rates falling on occupiers .. .. .	3 6 0	23 0 0	3 7 0	3 9 0	3 12 0	3 12 0
6. Share of rates falling on owners .. .. .	32 0 0	..	26 0 0	15 0 0	..	..
Average Annual taxation .. .. .	65 9 0	49 1 0	58 1 0	53 5 0	34 18 0	25 6 0
Percentage on gross income .. .. .	16½	12¼	14½	13½	8¾	6½

\* In each of these cases the gross income is assumed to be 399l., from which the owner's share of rates is deducted, leaving, as the basis on which other taxes on income or expenditure are computed, only the reduced revenue thus disposable.

a full 3*l.* tax on 120*l.*; thus reducing his payment to 2*l.* 17*s.* per annum.

Less easily noted are his taxes on articles of consumption. His household supply of tea pays a duty of 6*d.* in the lb., of coffee one of 2*d.*, and of currants and other fruits one of  $\frac{3}{4}$ *d.*; items on which together a yearly taxation of 2*l.* 2*s.* is easily reached. On every pound of tobacco he smokes he pays 3*s.* 3*d.* to the Exchequer; and here he contributes 2*l.* per annum. If but little wine—say four dozen a year—is used in his family, this still means a tax of some 16*s.* a year. More frequent will be the calls on his beer-barrel, through which, at 2*d.* per gallon, he may pay 2*l.* 10*s.* altogether. In an ordinary case he may at home and at market use 3 or 4 gallons of spirits, in one form or another, throughout the year, and thus pay 1*l.* 10*s.*; but since a typical case must present in some degree all the usual features of a common average, this hypothetical farmer must be assumed to have occasional fits of greater and more irregular indulgence in these to consume another 4 gallons of spirits, and thus to pay 1*l.* 16*s.* more. All these items would account for the 10*l.* 16*s.* entered in my Table.

On every third letter that he posts (for the post-office can carry three letters for the cost of two stamps) the farmer pays a tax of one penny. A penny goes also to the Exchequer on every cheque he draws, and on every receipt-stamp he uses. A larger stamp is required on his bills or promissory notes, and in one or two other of the transactions of his business; so that 30*s.* a year is soon totalled in such minor payments. He is hardly likely never to go to law, and, when he does, he pays in court fees. He cannot use the services of a solicitor, a banker, an auctioneer, or even of a hawker, pedlar, or vendor of patent medicines, without running some risk of having indirectly to contribute to the charges falling on these particular callings. In all these little matters half as much, or 15*s.* per annum, may be almost imperceptibly reached. On his house, just above the limit of the tax, he may pay 13*s.* of inhabited house duty. He may have for business or pleasure three dogs on his farm, and here again a licence-duty of 15*s.* is exacted. His carriage, if it be but a two-wheeled dog-cart, costs the same annual sum, and his groom or man-servant 15*s.* more. He has still one turnpike-gate left on his way to market, and here he pays regularly a local toll. This, with his share of market-dues and other local imposts, soon reaches 26*s.* per annum, and thus his miscellaneous taxes of 7*l.* 8*s.* are accounted for.

His local rates remain. Like a keen man of business, I will assume that when he took his farm he was successful in throwing on his landlord the rates then current; which were a poor-rate

of 1s. 2d., a county-rate of 5d., and a highway-rate of 5d. in the pound; thus reducing the rent he would have otherwise given by, it may be supposed, 70l. a year. Since that time, however, his parish has had its highway-rate increased by 2d. in the pound, from one of the neighbouring toll-bars having been abolished, and the road handed over to the charge of the rate-payers. The poor-rate of his union has risen also 2d. in the pound. Half at least of this increase it is not unlikely the farmer himself and his brother guardians might have saved by a stricter administration of out-door relief; but half may be due to the inevitable rise of official salaries. The Sanitary Authority also now levies a rate of 1d. in the pound to provide modern safeguards for the public health of the surrounding populations. While, last of all, his parish has fallen under the rule of a School-Board, who will levy for many years to come a rate of 3d. in the pound to repay the sums they have borrowed for the somewhat pretentious school-house and scholastic appliances destined to educate on the most recent pattern the children of the neighbouring villagers. All these several additions to the local charges of the farm will, no doubt, one day come to be reckoned and allowed for as landlord's charges in future lettings, but meantime they amount to the tax of just 23l. a year shown in the Table, and have to be paid by the tenant out of the margin of his profits. This forms the last item of the taxation of 12¼ per cent. which the income of the tenant-farmer bears for the public service of his country at large, his county, his union, or his parish.

Gathering up, therefore, finally, the conclusions brought out Conclusion. by a general review of British taxation, the results arrived at appear to be these:—The aggregate taxes collected in the United Kingdom are upwards of one hundred millions annually. Two-thirds of this large sum are paid into the national exchequer, and accounted for by imperial authorities; and one-third is raised and administered by local authorities. Great changes have been noted as occurring within recent date among the indirect imperial taxes, leading to the practical restriction of those now levied on articles of consumption, to the accessories or luxuries rather than the necessaries of life. Viewed as distributed between the two vast grades of society, those who win their bread by manual labour and those who gain a livelihood in some other way by means of already accumulated capital, or by active skill and industry, I have attempted to show that of the whole taxation the average share on the former class represents a pressure of 7 per cent. on their income against 11½ per cent. on that of the latter. A great divergence appeared, however, between the relative taxation of agricultural and of other incomes in each of these classes.

While the labouring section of the agricultural community has been seen to bear a lighter taxation than other workmen, agriculturists of the middle or upper classes have appeared to be taxed considerably in excess of the general average of their class. This, it has been shown, may, in the case of several imposts, be traced in part to usage more or less prescriptive, and in part to what has been deemed the eminently taxable character of the chief form of agricultural capital—the land. A still further discrimination has made it clear that, thanks to the incidence of local taxes, the landlord's average taxation—falling, as this does, not only on what may be regarded as the natural rent of the soil, but with equal pressure on the revenue he derives from capital devoted to its improvement—exceeds 16 per cent. ; while that of the tenant-farmer is upwards of 12 per cent. Opinions may indeed vary as to some of the details which lead to these results. Minute accuracy cannot be claimed for calculations into which hypothesis must occasionally enter. Still, however, as the result of patient enquiry, I am disposed to regard these conclusions as fairly enough representing, when contrasted with the position of other incomes, the general pressure of taxation on British agriculture.



IV.

FARM CAPITAL.

BY

ELIAS P. SQUAREY,

OF THE MOOT, DOWNTON, SALISBURY.

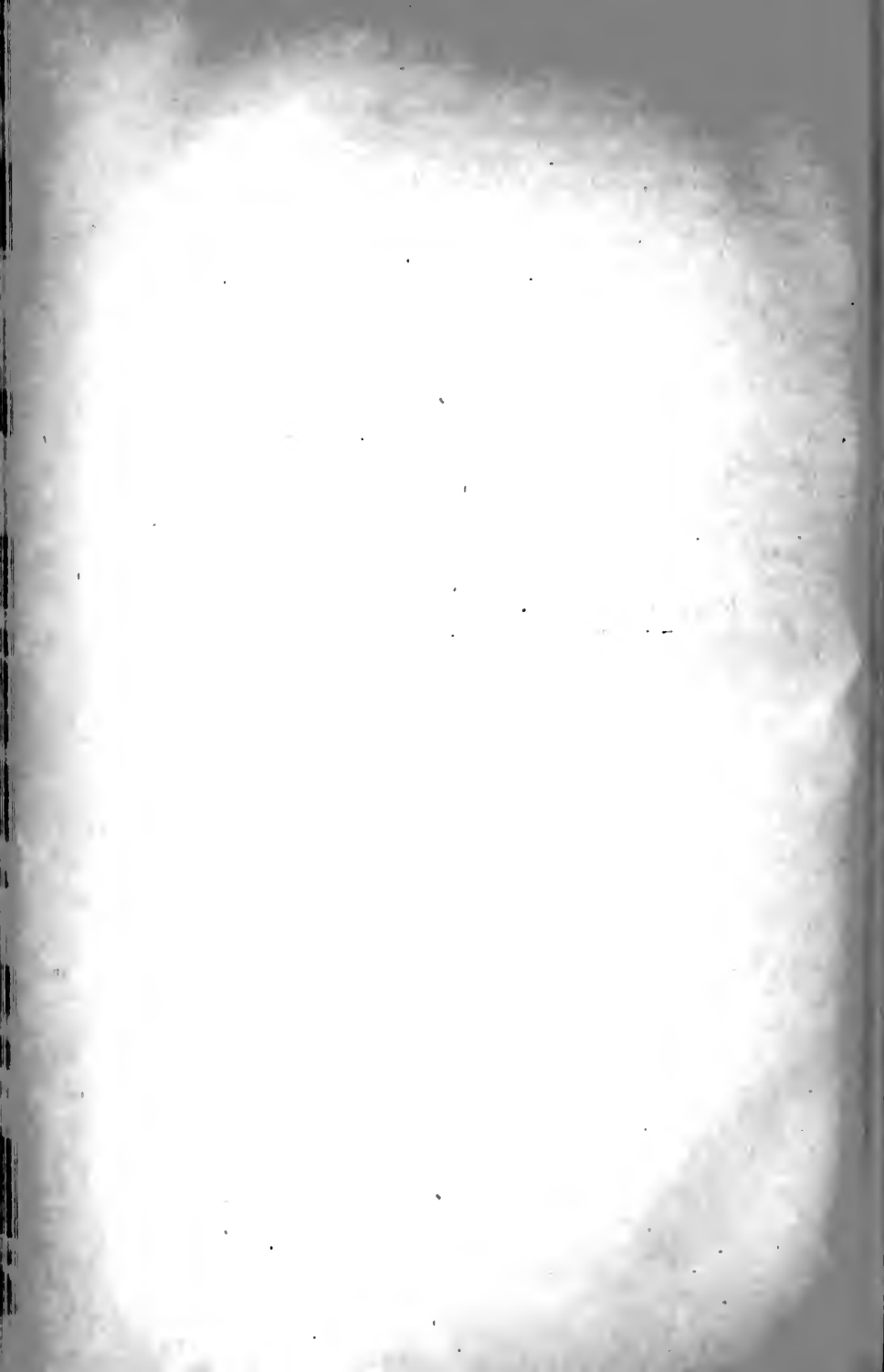

## CONTENTS.



Introductory—Landlord's Capital—Tenant's Capital—Proportions of Landlord's and Tenant's Capital—On a Dairy Farm—On an Arable Farm—On a Mixed Farm—On a Grazing Farm—Tenant's Capital less on Fertile Land—Irrigation—Drainage—Labourers' Cottages—Do not pay as an Investment—Circumstances which affect Tenant's Capital—Compensation to Outgoing Tenant—Implements—Stock—Manures—Cost of Labour—Circumstances which attract Capital to or repel Capital from Farming—Capital often insufficient—Increased Expenses—Agricultural Holdings Act—Profits of other Businesses—Farming an attractive Pursuit—Freedom of Cropping—Causes of existing Depression—Banks—Value of Land and Interest thereon—Rent—Companies for Improvement of Land—Their Procedure—Action of Inclosure Commissioners—Repayment of Loans by Landowners—Benefit to the Public—Schedules .. .. Pages 163—178

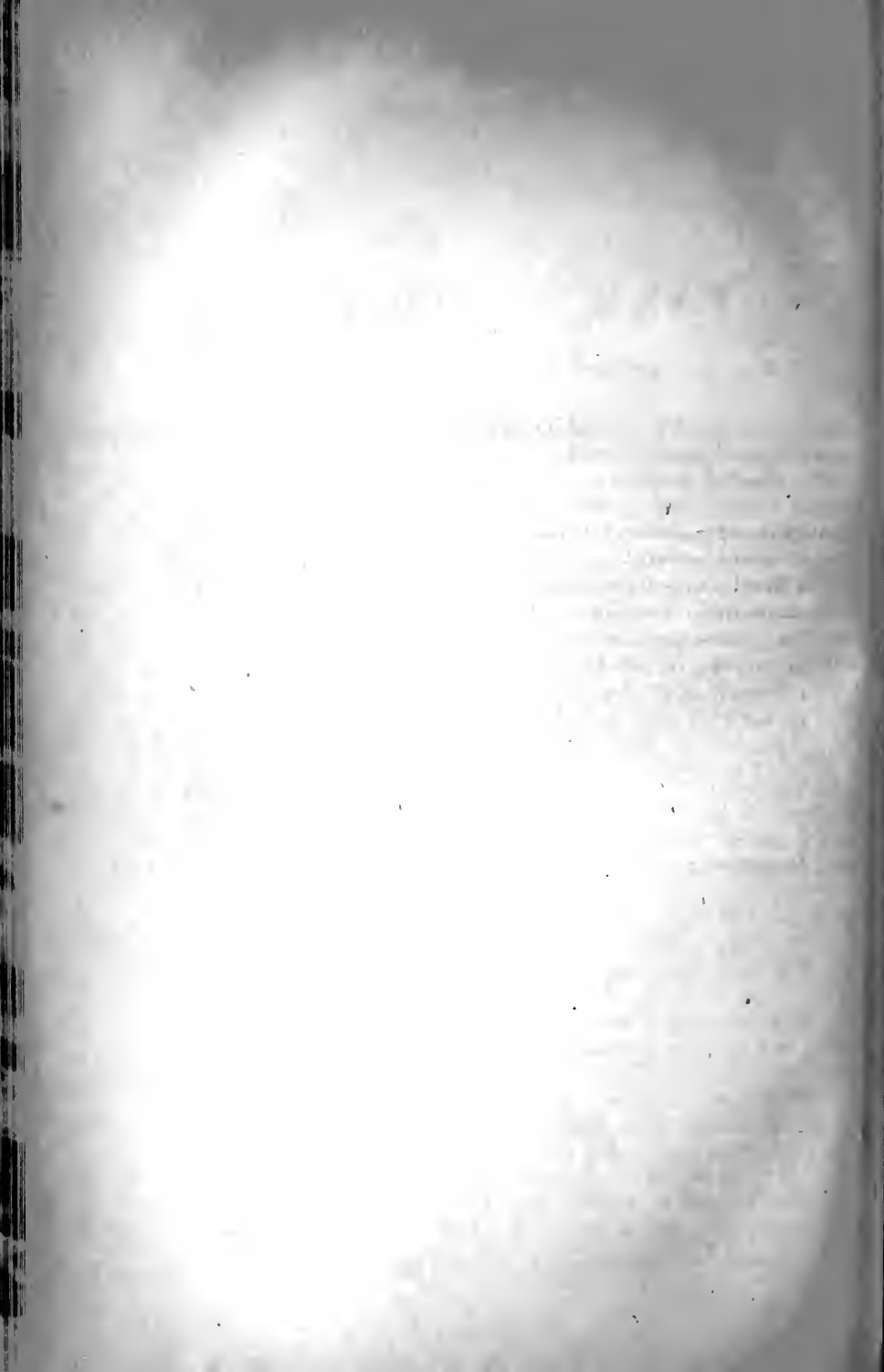

## FARM CAPITAL.

---

*Introductory.*—The capital applied in agriculture in its widest Introductory. sense may be regarded as “fixed” capital and “movable” capital.

The conclusion of political economists, that land, in its natural unimproved condition, is not capital, and that the value of the expenditure in labour and other forms of supposed improvements, more or less permanent, and of certain or uncertain benefit, is theoretically the only true expression of capital in land, is fully recognised. Having regard, however, to the past and present continual exchange of land for capital in the form of money, by means of sales, mortgages, and charges, it may be convenient for the purposes of this Memoir, in estimating the respective contributions of capital by the landlord and tenant, to treat land in its natural form as part of the landlord’s capital, inasmuch as landed property represents in the market an amount of capital dependent upon its degree of natural fertility, its situation and climate, and the sum prudently expended in the shape of buildings, drainage, irrigation, or other specialities incident to its particular application.

In this view, therefore, it may be convenient to divide the subject as follows:—

A. *Landlord’s Capital.*—The “fixed” or landlord’s capital is: Landlord’s capital.

1. The land upon which agricultural operations are carried out.

2. The buildings, more or less extensive and complicated, fitted for various farming-applications, roads, cottages for labourers, fencing, water-supply, &c.

3. The expenditure in arterial and thorough drainage, warping, irrigation, marling, chalking, and other more or less permanent methods of increasing the productive capacity of the soil.

B. *Tenant’s Capital.*—The “movable” or tenant’s capital is: Tenant’s capital.

I. The live-stock, whether kept for the production of meat, milk, wool, &c., or as power for cultivating and marketing produce.

II. The corn growing or in stock, the food stored for animals in the shape of hay, straw, fodder, and roots, or growing in the shape of natural or artificial grass, clover, sainfoin-roots, or other fodder-crops.

III. The implements adapted for special cultivation, preparing for market, and marketing the produce.

IV. Capital in the form of money to meet the current expenditure incident to the preparation of the land for the seed, the manuring, seeding, cleansing, harvesting, and marketing the corn-crops, to the consumption or sale of the root and fodder-crops, to the purchase of artificial foods, to pay the Government and parochial rates and taxes, tithe-rent charges, and, where the land is let, the rent.

Under the existing conditions of English agriculture, it is almost invariably the fact that the landowner does not cultivate his land. He relieves himself of the responsibility of supervision, the risks of business, and the provision of the movable capital, by letting his land for a period, on terms, and subject to reservations agreed on, to a tenant, who provides such movable capital more or less completely, and undertakes its cultivation. So fixed and invariable is this arrangement, that, even in cases where the landowner, either by choice or necessity, undertakes the occupation of his land, it is usual and desirable to place himself in the position of tenant, by separating the accounts, and charging himself with the amount of rent which might be obtainable if the land were let.

Proportions of  
landlord's and  
tenant's  
capital.

The capital provided by the landlord and tenant respectively is of ever-varying proportions, dependent upon the quality of the land and the nature of its application. In the following illustrations an endeavour has been made to give an approximate expression of these proportions. It is obvious, however, that they must be accepted as merely approximate, inasmuch as, under the practice of one district, improvements which are ordinarily effected by the landlord are in another district carried out by the tenant, on the terms that he recoups his outlay under the "custom of the country," or by a "tenant-right," of which the nature is defined, or through the granting of a lease for a period during which, having regard to the rent reserved, he may reasonably expect to repay himself such outlay.

These illustrations are based on the assumption that the whole working-capital of a farm includes the cost or value of the land, the buildings, &c. (see secs. 2, 3), and the stock, crops, &c. (see secs. I. II. III. IV.), so that the analysed proportions may be given in percentages.

On a dairy  
farm.

*Illustration A.*—A dairy farm of 200 acres, comprising not more than 15 per cent. of arable land, and of the assumed annual value, excluding



tithes, of 50s. per acre = 500*l.* The value of such a farm in the market may be taken at 30 years' purchase on the annual value (500*l.*) = £15,000

The cost of buildings on such a farm, including farm- house, with dairy-accommodation, water-supply, and two cottages for labourers, may be taken at .. .. .	£2550
Drainage assumed at .. .. .	1000
Roads and fencing assumed at .. .. .	500
	4,050

Leaving as cost of land in its natural condition .. .. £10,950

The tenant's capital may be taken at 12*l.* per acre = 2400*l.*, and the total capital applied to the farm stands as follows:—

*Landlord's Capital* :—

Land in its natural condition .. .. .	£10,950	= 63 per cent.
Buildings, improvements, &c., as set out above .. .. .	4,050	= 23·2 "

*Tenant's Capital* .. .. . 2,400 = 13·8 "

Total capital employed .. .. . £17,400 = 100·0 "

*Illustration B.*—Mixed arable and pasture farm of 500 acres of assumed annual value of 30s. per acre, excluding tithes = 750*l.* per annum. On an arable farm.  
Assumed capital value × 30 years = 22,500*l.*

*Landlord's Capital* :—

Land in its natural condition .. .. .	£17,500	= 61·4 per cent.
House, farm-buildings, 6 cottages .. .. .	4,000	} = 17·5 "
Roads, fencing .. .. .	1,000	

*Tenant's Capital* :—

12 <i>l.</i> per acre .. .. .	6,000	= 21·1 "
	£28,500	= 100·0

*Illustration C.*—Mixed upland, arable, and pasture farm of 1000 acres. On a mixed of assumed annual value of 20s. per acre, excluding tithes = 1000*l.* per annum farm.  
× 30 years' purchase = capital value of .. .. . £30,000

Farmhouse .. .. .	£1400
Buildings, homestead, two field-barns, yards, sheds, water-supply .. .. .	3000
13 cottages .. .. .	1950
Roads and fencing .. .. .	1000
	7,350

Cost of land in its natural condition .. .. . 22,650

*Tenant's Capital* :—

10*l.* per acre on 1000 acres .. .. . 10,000

*Landlord's Capital* :—

Land .. .. .	22,650	= 56·6 per cent.
Buildings, &c., as above .. .. .	7,350	= 18·4 "
<i>Tenant's Capital</i> .. .. .	10,000	= 25·0 "
	40,000	= 100·0 "

On a grazing farm.

*Illustration D.*—Grazing farm of 300 acres, not requiring drainage. Annual value 63s. per acre, exclusive of tithe = 945*l.* per annum  $\times$  30 years = £28,350

House .. .. .	800
Sheds, yards, granary, water-supply, &c. .. .. .	1000
Two cottages .. .. .	300
Roads, fencing .. .. .	500
	2,600

Value of land .. .. . £25,750

*Tenant's Capital* :—

15*l.* per acre on 300 acres .. .. . £,4500

*Landlord's Capital* :—

Land .. .. .	25,750	=	78·38	per cent.
House, buildings, &c. .. .. .	2,600	=	7·9	„

	28,350		
<i>Tenant's Capital</i> .. .. .	4,500	=	13·71
	£32,850	=	100·0

Tenant's capital less on fertile land.

The foregoing illustrations point to the general conclusion, that the more naturally fertile lands, even if artificially improved by drainage, require, relatively to the total value, a less proportionate contribution of capital by the tenant. Doubtless there are numberless deviations from this conclusion; for instance, in the costly and highly organised management of hop-lands and fruit-gardens, the proportion of the tenant's capital engaged bears a much larger proportion to the fee-simple value of the land with its buildings upon it, than occurs under the more ordinary type of agriculture. Again, it must be borne in mind that these illustrations have reference rather to the present cost of construction, in a fair and reasonable form, of those buildings which ordinarily are found on farms of average character in a scarcely satisfactory condition: hence in the analysis of the value of the bare area of land, and of the buildings on average farms, the proportions may not be expected to conform accurately to the illustrations set out above. But, assuming the land to be without roads, farm buildings, residence, water supply, cottages, roads, and fences, these obvious necessities for the letting and management of a farm could scarcely be adequately supplied at a cost less than the amounts estimated above. It may be remarked, that whilst in certain directions the cubical contents of barns are greatly diminished as compared with those required before the introduction of steam threshing-machinery, yet the very perfection and value of the implements now employed necessitate storage for these and for the manipulation of the large bulks of corn dealt with under the altered conditions; and the economy in one direction is balanced in degree in another.

Irrigation.

*Irrigation.*—Irrigation is so exceptional an expenditure, con-

fined to special districts of English agriculture, that no reference has been made to it in the estimates formed above; but it may be interesting to remark that the cost of irrigation, where applied on the large streams of the valleys of the south of England, when not associated with mills, may be taken at an average of 30*l.* per acre. The natural value of the land before irrigation being taken at from 60*l.* to 80*l.* per acre, this operation alone would represent a landlord's improvement of more than 30 per cent., whilst with the streams of less volume the landlord's expenditure in hatchwork, levelling, and other arrangements for fitting the land with irrigation works, would be not more than 10*l.* to 15*l.* per acre.

Certain recognised modes of more or less permanently improving land by the application of chalk, marl, clay, or lime, and in some cases of bones to pasture land, representing an expenditure of from 3*l.* up to 10*l.* per acre, are occasionally undertaken by the tenant, and are recouped to him by a scale of tenant-right, of which examples now in force are given in the annexed Schedule A (p. 177). Where, however, the expenditure approaches 8*l.* to 10*l.* per acre, the usual course is for the landlord, either with his own means, or through the agency of the various societies for the improvement of land referred to hereafter, to effect these operations, charging the tenant a percentage on the outlay, to be agreed upon.

*Drainage.*—Thorough drainage is so material and important an improvement, that it is desirable to say a few words specially on it. It was formerly, and is still occasionally, undertaken by the tenant. The average cost of drainage has been considerably increased of late years through the greater value of manual labour, and in some degree through a slightly enhanced cost of manufacture of the pipes. Up to 1871 and 1872, the average drainage of an estate requiring this operation might be calculated to be effectively carried out at about 6*l.* to 6*l.* 10*s.* per acre. Since that time the cost has been increased by at least 15 per cent., and there is certainly a hesitation at the present time on the part of tenant-farmers to agree to pay the full interest of 7*s.* or 8*s.* per acre on the cost of the work. This conclusion is clearly indicated by the decreased expenditure on drainage in the year 1875-6, as disclosed by the Inclosure Commissioners' Returns. In the year 1873 the expenditure on drainage was 96,297*l.* 16*s.* 11*d.*; in the year 1874, 95,185*l.* 11*s.* 11*d.*; in the year 1875, 79,448*l.* 11*s.* 8*d.*; in the year 1876, 61,492*l.* 13*s.* 0*d.* In Lincolnshire and some other districts in England a tenant-right for drainage-expenditure, extending from 10 to 13 years, still exists, whilst occasionally the operation is carried out on the footing that the landlord provides the drainage-tiles, and the tenant performs the labour.

Labourers' cottages.

*Labourers' Cottages.*—Cottages for the residence of the labourers and artisans engaged in various agricultural operations are invariably provided by the landlord. They are usually erected at points convenient to the homesteads, so that a supervision of the cattle and premises can be secured. The cottages are ordinarily built of brick or stone, and occasionally of loam, or other suitable material for the purpose, and are covered with tile, slate, or thatch, according to circumstances and locality. They usually contain a living-room and scullery or washing-place, with a small pantry for food on the ground-floor, and three bedrooms over. The cubical contents of a cottage containing two rooms on the ground-floor and three bedrooms, vary usually from 7500 to 9000 feet. Where a large number of cottages are erected on an estate, a proportion—say 2 in 7—contains only two bedrooms. The present cost of building cottages with five rooms in pairs or blocks of three, with the necessary offices and water-supply, varies from 140*l.* to 210*l.* per cottage, dependent, of course, upon the size, the character of materials, and the greater or less perfection of workmanship. The gardens are generally laid out with an area of 15 to 20 poles to each cottage. The rent paid by a labourer working on the farm to which these cottages are attached varies from 1*s.* to 1*s.* 6*d.* per week, in the southern counties, to 2*s.* 6*d.* or 3*s.* 6*d.* in the midland or northern districts of England. The income in the shape of rent which is obtainable from the farm-labourer bears no reasonable proportion to the interest, as an investment, of the money spent on the erection of cottages. They clearly must be regarded as much a part of the working-arrangements of the farm as the barn, stables, &c., and the loss of income between the rent receivable and the reasonable interest of money on their cost is balanced by their value to the tenant as part of his holding. As a rule, one cottage per 75 acres of mixed arable and pasture land may be considered to afford ample labour for the cultivation of the land. The result of the unproductive character of investments in the erection of cottages has been that on estates of the largest and wealthiest proprietors they are almost invariably of a sufficient and most comfortable character, whilst on the smaller properties this requirement has been less perfectly met. It may, however, be remarked that the erection of superior cottages, with good gardens, let at moderate rentals, from philanthropic rather than commercial motives, if carried beyond the reasonable agricultural requirements of the district, has had the tendency, under certain conditions, to reduce the wages of the agricultural labourers. They have been unwilling to leave these pleasant homes, their numbers have increased beyond the existing market for their labour, and their wages have consequently been depreciated.

Do not pay as an investment.

*Tenant's Capital.*—The capital employed by a tenant in the cultivation and management of a farm has been already referred to under the head of “Movable Capital.” It is of very varying value, and depends for its amount very much upon the character and quality of the soil, the period of entry upon the farm, and the covenants or custom under which the tenant is bound to enter. These may provide for his own preparations for the ensuing crops, or for his liability to take off, by valuation or otherwise, the crops, hay, straw, fodder, root-crops, sainfoin-roots, and tenant's fixtures, or for his simply taking possession of the land on the termination of his predecessor's tenancy, without payment of any kind. Again, the amount of capital is regulated by the value of tenant-right, or compensation for unexhausted manures or feeding-stuffs, or for improvements, more or less permanent, effected by the outgoing tenant, of which he has failed to derive the full benefit, and for which he is entitled in some cases to be paid by the incoming tenant. In the past, and up to a comparatively recent time, tenant-right has been of limited application in England; but an appreciation of their respective positions by the landlords and tenants, incident to the passing and subsequent operation of the “Agricultural Holdings Act, 1875,” and, still further, a sense of the justice and necessity to the tenant, and of the advantage to the community generally of the application of the principles of tenant-right, has led to the extension of the previously existing system, modified by a great variety of circumstances. This re-arrangement of their mutual relations cannot fail to be of profit to the State, and satisfactory to the landlord and tenant. Under the co-operation of a well-considered and fairly adjusted tenant-right, the fertility and capacity to produce the maximum of crops are maintained in the soil, and the continuous process of degradation of productive power in a tenancy near its termination is likely to be avoided.

Circumstances which affect tenant's capital.

Compensation to outgoing tenant.

*Implements.*—The implements of the agriculture of 1877 are in remarkable contrast to those in use at the commencement of the century. The plough, of rude though serviceable construction, the wooden roller, and the harrows for cultivation; the scythe and the reap-hook for cutting the harvests of grass and corn; the wooden flail, and the primitive winnowing-machine of those days are now replaced, in greater or less degree, by the steam-plough and cultivator of enormous power and adaptation, and by the draught-reducing turnfurrows of the horse-ploughs of Messrs. Howard, Ransome, and others; the reaping, mowing, and hay-making machines, with the elevators for stacking the produce; and, lastly, the steam threshing and winnowing machines of the present day. It may be confidently asserted that, even in the most distant and least advanced districts of English

Implements.

farming, these wonderful adjuncts of labour are in use, in greater or less degree, and that it is only through their aid that the present farming-operations are possible with the decreased supply of manual labour. The money absorbed in the adoption of the least expensive of the implements enumerated above is very greatly in excess of that invested in their older types, and bears a large but scarcely definable proportion to the increased capital referred to as the contribution by the tenant.

Stock.

*Stock.*—Live stock, which includes the animals kept as motive power as well as for the production of meat, milk, or wool, form the largest proportion of the tenant's capital under ordinary mixed agriculture. Horses for draught or pleasure-purposes have attained apparently a permanent value, dependent on their character, at least 40 to 70 per cent. above that of 25 years since. Sheep have followed in the same ratio; and notwithstanding the enormous importations of wool and of meat, whether alive or dead, from the Continent, America, or Australia, the prices of mutton and wool are greatly in excess of their former amount. Cattle, as well as dairy produce, have risen in value in the same degree, whilst apparently equally modifying conditions, in the shape of importation, have existed. This general advance in price obviously forms an important item in the amount of tenant's capital, and may be taken to add at least 30 per cent. to that which was formerly considered sufficient.

Manures.

*Manures.*—In this direction, also, a new element of expenditure, and certainly of very largely increased production, has arisen. Since the introduction of guano in 1840–41, of nitrate of soda about 1845, and Liebig's suggestion of the use of superphosphate of lime, the application of these various elements of fertility have gone on in an ever-increasing proportion. No statistics are available to give an expression of the total expenditure on artificial manures in England at the present time, but it undoubtedly may be estimated at some millions annually, and their use, depending on the result of local experience, may yet be advantageously extended.\*

Cost of labour.

*Cost of Labour.*—The cost of labour per acre in English agriculture extends from almost a minimum, on the purely pastoral lands, to 25*l.* to 30*l.* per acre on the best cultivated hop-lands. The cost per acre of manual labour in the cultivation of the two illustrative farms B and C may be taken as follows:—On Farm B, assuming that the improved machinery for the economy of labour is employed, including the occasional use of steam-ploughs, the amount expended in manual labour may be taken

\* The increase in the importations of guano may be thus illustrated:—In 1840, 20 casks were imported; and in 1870, 280,311 tons.



at about 35s. per acre. On Farm C, under the same conditions, the manual labour should cost from 25s. to 28s. per acre. The cost of piecework for various operations has scarcely followed the advance which has taken place in daily wages in the last ten years.

*Circumstances which attract Capital to or repel Capital from Farming.*—Combinations of circumstances occasionally operate, and may be expected to continue to operate, in stimulating at one period and reducing at others the amount of capital employed by tenants in their occupations:—continuous depression of prices, either generally or of special classes of produce; disorganisation of the supply and cost of manual labour, and in degree the profit or otherwise to be obtained in other businesses, all contribute to affect this question; but, as a rule, it may be accepted that tenant's capital has not flowed liberally into farming investments in England, and is more or less deficient in the amount which might be profitably employed. Farms are too often taken with a capital which is insufficient to meet those contingencies of price and season to which farming is especially subject,—hence a sequence of unproductive seasons or exceptionally low prices, disease or accidents to stock, may imperil the success of a farmer, however industrious and able, who has embarked in a business for which his capital is inadequate. The amount of tenants' capital required is and has been constantly increasing. Implements, though more effective, are more expensive, more complicated, and more numerous. Live-stock of all descriptions seems also to have reached a permanent platform of value at least from 30 to 40 per cent. in excess of that which existed fifteen to twenty years ago; but probably the most material influence on the farmer of late years has been the disturbed relations between himself and his servants. The actual increment of wages may be estimated according to locality at from 15 to 25 per cent., and it is unsatisfactory to find it reported that with this increase of wages there has been a concurrent depreciation in the value and quality of the labour given, and that consequently the practical cost of operations generally in farming has been enhanced beyond the rate thus stated. This latter state of things may be merely temporary, and may be succeeded by a conviction on the part of the workmen that higher wages can only be paid so long as improved results are arrived at.

The "Agricultural Holdings Act, 1875," to which reference has been made, was the first legislative attempt to define the rights which, in the absence of a written contract, ought to belong to the tenant for improvements more or less permanent; and also for those conditions of feeding, stocking, and management at the end of the tenancy, which, if neglected, as they too

Circumstances which attract capital to or repel capital from farming.

Capital often insufficient.

Increased expenses.

Agricultural Holdings Act.

often were, would reduce the current productiveness of the farm. Although the application of the "Agricultural Holdings Act" has been in most cases declined by the landowners, there has been a loyal and willing disposition on their part to reconsider their agreements and arrangements with their tenants, under which the principles underlying the "Agricultural Holdings Act" have been largely and beneficially operative, especially in the second and third classes of improvements scheduled in that Act. Any legislative attempt of a protective character, with a view to enhance the value of agricultural produce, and to stimulate the employment of capital in agriculture, even if it could be secured, would certainly fail to lead to a larger application of tenants' capital to farming, inasmuch as if any increased price could be shown to result, or was likely to result, from its operation, it is obvious that the value of the land upon which the operation was to be carried out would be enhanced to the landlord, in the shape of rent, in proportion to the value of the increased price likely to be secured.

Profits of other  
businesses.

Reference has been made to the influence which the value of money and the profits arising from commercial and other businesses and professions may exert in attracting or repelling the investment of capital in farming. The disposition to manage land and to rear and improve animals, is an instinct with the majority of men, and is indicated in the flower-pot of the poorest cottage as well as in the home farm of the wealthiest landowner: indeed, it may be predicted that if a youth born and brought up on a farm is to apply himself to commercial or professional pursuits, his relations with land and its attractive belongings must be broken at a reasonably early age. It is the dream of many a successful business man to return to his native neighbourhood, and in some form or other to be connected with land. This instinctive desire undoubtedly operates, by enlarging the demand for farms, to increase the rental of land, and in corresponding proportion to diminish the profits attaching to farming as a business. It will be conceded that the occupation of farming in a well-placed district, without serious drawbacks from ground-game and other local disabilities, affords to a man of average ability as pleasant a life as he can find in any other business or profession; and it is doubtless this aspect of farming which leads to the acceptance by farmers of a smaller interest on the capital engaged than is offered in other commercial pursuits. Just in proportion, probably, as farming is made a more purely commercial undertaking, as machinery enables the farmer to dispense with the services of a proportionate number of workmen, and as the farmer himself secures a more recognised position in the administration of the local concerns of his district, so probably it may be expected that capital

Farming an  
attractive  
pursuit.

from other channels will flow liberally and permanently into farming. An element of attraction, also, is to be found in greater freedom on the part of the tenant in the cropping and general application of his land. In the earlier and many lately existing agreements governing agricultural management, hay, straw, and fodder were bound to be consumed on the land. No green crops might be removed from it, and the efforts of the landlord and land-agent were directed to maintain the fertility of the land by the most stringent restrictions. With the introduction of artificial manures, and further through the construction of railways delivering town-manure and refuse at various points to which these matters might be cheaply transported, the necessity for the restriction of covenants as to farm-management and the sale of hay, straw, fodder, and green crops has been greatly reduced and in some places removed. No good tenants can now be obtained on farms where facilities for the sale of such produce exist, if the stringent regulations of a lease of 1850 are insisted upon. This modification of covenants has been greatly induced by the increased value of hay and straw, and the accessibility of markets through the vicinity of railways, during the past few years.

Freedom of cropping.

At the present moment the agricultural interest in certain districts is suffering under an unusual depression consequent on seasons adverse to the profitable management of particular soils, concurrently with a disorganised condition of the labour market. That this condition is acute, is apparent by the large area of land and number of farms in the market to be let. It may be observed, however, that commercial and manufacturing interests have been equally, if not more severely, depressed. It is possible that the present application of these lands may, under new conditions, be modified, and their value temporarily affected, whether for sale or letting, if such conditions are to be permanent; but it is not probable that any large area will revert into an unproductive condition, except those soils which have been stimulated into an abnormal fertility without regard to economical results.

Causes of existing depression.

*Banks.*—The extension of the banking-system to almost every agricultural district in England has contributed largely to the convenience of farming-operations, whilst the banks themselves have, undoubtedly, profited very considerably by the moderate and safe advances which they are enabled to make to their farmer customers.

Banks.

*Value of Land and Interest thereon.*—The value of purely agricultural land, as an investment, varies in a most remarkable degree, and appears to depend not so much upon the amount of interest obtainable from the investment as from an inherent

Value of land and interest thereon.

taste in some localities for its possession merely as land, which appears to be wanting, or at all events very faintly present, in other cases. At the present time the net income from land applicable only to farming-purposes, varies from 2 up to  $4\frac{1}{4}$  per cent. The causes operating to produce this wide divergence in value are usually the presence or absence of wealthy individuals seeking to accumulate large estates for residential or domain purposes. Some localities are specially accepted by land-buyers, whilst estates in other districts can only be sold upon terms equivalent to those which first-class Railway Debentures or Mortgages afford to purchasers, viz. from  $3\frac{1}{2}$  to 4 per cent. Doubtless there is an ever-accruing increment in the capital value of land by the daily accumulation of wealth, and its theoretical tendency is to increase the number of years' purchase of net income upon which freehold or capital value is arrived at, or, on the other hand, to reduce the net percentage as an investment. An impression prevails among many thoughtful minds, that future legislation under a possibly more democratic representation may be influenced by the idea, whether well or ill founded, that land does not bear its proportion of taxation; \* and that, as it lies readily open to the tax-gatherer, so it is more likely than personal property to be affected in this direction.

Rent.

*Rent.*—The rent of land is that surplus of money which on an average of years, may be expected to remain after paying the fixed and fluctuating charges, such as tithe-rent charge, rates, and taxes, the cost of labour, seeds, manure, replacement of live and dead stock, tradesmen's bills, interest on capital invested, and such remuneration for his services as a farmer may think himself entitled to, or be content to receive. Looking at the elasticity of the greater proportion of the payments by a farmer, and the varying capacity of men to administer and supervise, the changing combinations occurring in farming, the sanguine expectations of one tenant, and the doubts of another, it is obvious that wide divergences may exist in the disposition to pay more or less rent, and in the capacity to produce, after satisfying the requirements enumerated above, what may be accepted as an average amount available for rent. Such agreement is, however, arrived at; and, as a rule, the rent of land over a district may be accepted as being almost uniform, except so far as the natural quality of the land to yield more or less produce is concerned. In England the tithe-rent charge, parochial rates and taxes (except land-tax and landlord's property-tax), are usually paid, in addition to rent, by the tenant. This, however, is scarcely material, as, if paid by the landlord, the value to the tenant and consequently the amount of rent is

---

\* On this point, see the preceding Article.—EDIT.

proportionably increased. In adjusting the question of rent, the acceptance by the tenant of the liability, more or less qualified, to repair, or exemption therefrom, obviously governs the amount to be paid. Such amount is further influenced by the reservation of game or other kindred rights by the landlord, and generally by the character of the covenants under which the land is to be managed. Rent is generally contracted to be paid half-yearly, but occasionally quarterly, though rarely collected more than twice a year. It is becoming usual to make the rent due in the last quarter before the expiration of the tenancy, payable in advance if demanded. The amount of rent varies from 20*l.* per acre on the best hop-lands and fruit-farms down to 2*s.* 6*d.* per acre on the thin sandy heaths of Dorsetshire and the Eastern Counties. No precise formula can be adopted in fixing its amount, nor has any scheme, under which the landlord receives a proportion of the value of farm-produce, in lieu of a fixed money-rent, ever yet worked permanently and satisfactorily. The ordinary tenant seems to prefer to take his chance of bad years as well as good ones, of low prices as well as high prices, whilst to the landowner it is obviously all-important to know as nearly as may be the actual average income which is likely to accrue to him from his property.

*Companies for Improvement of Land.*—Reference has been made above to the Companies incorporated by Act of Parliament for advancing money for the purposes of agricultural improvements. Their short history is as follows:—In the year 1847 the Government obtained a vote for the application of 4,000,000*l.* for drainage purposes in the United Kingdom, to be repaid by annual instalments in twenty-one years, on the basis of 3 per cent. simple interest. This amount was almost immediately absorbed by various landowners, and, under private enterprise, the following Companies were established by Act of Parliament for carrying out improvements of a more varied and extensive character, viz.: “The General Land Drainage Company,” “The Lands Improvement Company,” “The Land, Loan, and Enfranchisement Company;” and “The General Act.”

Companies for improvement of land.

A landowner desirous of charging the inheritance of his estate with the cost of any of the improvements enumerated in the Schedule B, annexed (p. 178), applies to one of the Companies for an advance to enable him to carry out the necessary work. This application is submitted by the Company to the Inclosure Commissioners for England and Wales, accompanied in the case of buildings with plans and specifications. These, after examination at the Inclosure Office, are referred by the Commissioners to an inspector, who visits the site of the proposed works, and reports to them upon the scheme, and how far the intended outlay will be beneficial to the estate, and the probable increase of rental

Their procedure.

Action of En-  
closure Com-  
missioners.

which will arise from such outlay. The Commissioners being satisfied upon these points, issue a sanctioning order provisionally charging the estate with the cost of the work. The improvements can then be proceeded with, the Commissioners requiring to be informed by the landowner or the Company when any of the buildings are in skeleton, *i.e.*, before the timber-work and roof are enclosed in order that their inspector may see them in that state, if necessary. This rule, however, is relaxed under certain conditions. Upon the Commissioners being apprised that the works are finished, the inspector again visits, and reports whether they have been properly carried out in accordance with the plans and specifications, and if the work generally has been executed in a satisfactory manner. In that event the Commissioners certify the execution to the Company, and the amount expended is paid over to the landowner, and an absolute or final order of charge is executed by the Commissioners. This order may include all expenses incident to the transaction, which are generally calculated to amount to about 7 or  $7\frac{1}{2}$  per cent., including the Company's commission of 5 per cent. for the use of their Act, and for carrying through the arrangements with the Inclosure Commissioners. The Company undertakes to carry through these details with the Commissioners, and to provide the necessary capital sum expended on the works and in expenses, in return for an annuity or charge for 25 or 31 years. The present terms are from 6*l.* 10*s.* 8*d.* to 6*l.* 14*s.* 1*d.* per cent. for 25 years, and from 5*l.* 16*s.* 8*d.* to 6*l.* 7*s.* 7*d.* per cent. per annum for 31 years, based on a scale of simple interest, varying from  $4\frac{1}{4}$  to  $4\frac{1}{2}$  per cent., the balance being a sinking-fund sufficient to replace the principal sum, if re-invested half-yearly at the same rate of simple interest, in 25 or 31 years.

Repayment of  
loans by land-  
owners.

The operations of the Companies are conducted upon purely commercial principles, and their rates for loans depend upon the market value of money. The total amount which has been expended under the supervision of the Inclosure Commissioners is 11,527,865*l.* 0*s.* 8*d.* up to 1876.

Benefit to the  
public.

No special legislation during the present century has been productive of more benefit to the public and individuals than these Acts. Through this channel the above large amount of money has been devoted to improvements which, as a rule, could not otherwise have been undertaken, and has produced a return in value of produce greatly in excess of the actual percentage charged by the Companies, whilst the freeholds at the expiration of the term will enjoy the full benefit of the improvements, unencumbered by any charge. The Inclosure Commissioners, as guardians of the freehold, have shown a wise and prudent yet liberal discretion in the exercise of the important and valuable power entrusted to them.



## SCHEDULE A, ABOVE REFERRED TO (p. 167).

*Tenant's Allowance for Improvements.*

For the encouragement of good farming, the landlord agrees to allow the tenant for improvements made and for unexhausted artificial manures and feeding-stuffs purchased by him, and used on the farm during the last two years of the term as follows (provided that the quantity so used shall not be in excess of the average quantity used during the last four years), the amount of such allowances to be determined by valuation, viz.—

1. For chalking with the written consent of the landlord, if done within the last two years of the tenancy, the whole cost. If done the previous year, six-eighths of the cost; and so on, diminishing the allowance by one-eighth for each year which shall have elapsed since such chalking.
2. For liming, where no crop has been taken, the whole cost (excepting haulage); and where one crop only has been taken, half the cost (excepting haulage).
3. For bones, used upon grass-land with the written consent of the landlord, if used within the last year of the tenancy, and where the crop has not been mown, the whole cost (excepting haulage); if used in the previous year, seven-eighths of the same cost; and so on, diminishing the allowance by one-eighth for each year which shall have elapsed since the boning; but the same cost in no case to exceed 4*l.* per acre.
4. For purchased artificial manures of good and genuine quality, if used during the last two years of the tenancy on lands from which no corn, pulse, or other seed, hay, potato, or other exhausting crop, has been taken, one-half of the cost, such cost not exceeding 2*l.* per acre for one year's dressing, or 3*l.* per acre for lands so manured in two successive years; for such as may be used in the last year of the tenancy, and where the roots or green crops shall be left on such lands unfed, the whole of such year's dressing to be allowed.
5. For feeding-cakes (except such as may be consumed by horses and working-oxen), one-third of the cost-price of so much thereof as shall have been used on the farm during the last year of the tenancy, and up to the 25th day of March following the expiration of the same; and one-sixth of the cost-price of so much as shall be used on the farm in the previous year.

Proper proof and evidence of use and application, and proper bills and vouchers showing the description and cost of all manures and feeding-cakes claimed to be allowed for under this clause, to be produced; and the total of such allowance to be subject to a deduction of the market-value of all straw, hay, roots, green crops, and manures removed off the farm during the last two years of the tenancy.

*Allowance for Sainfoin-roots, Tillages, &c.*

The landlord to pay the tenant for all sainfoin-roots under four years' growth, and for all tillages and usual half-tillages, and other preparations done for the benefit of the incoming tenant, during the last two years of the tenancy (where no corn-crop has been taken) at their value to the incoming tenant.

*Temporary Sheds, &c., to be allowed for or removed.*

The landlord to allow the tenant the value to the incoming tenant of all or any temporary sheds and buildings erected by him on the farm, or to

permit him to remove the same at the expiration of the tenancy, provided he gives notice in writing to the landlord, two months before the expiration of the tenancy, of what buildings he claims. In the event of removal, the tenant to make good all damage to ground and premises caused by such erection or removal.

---

SCHEDULE B, ABOVE REFERRED TO (p. 175).

The improvements (Schedule B) are as follows :

1. The drainage of land, and the straightening, widening, deepening, or otherwise improving the drains, streams, and watercourses of any land.
  2. The irrigation and warping of land.
  3. The embanking of land from the sea or tidal waters, or from lakes, rivers, or streams, in a permanent manner.
  4. The enclosing of land.
  5. The reclamation of land and its chalking.
  6. The making of permanent farm-roads and permanent tramways, and railways for agricultural or farming purposes.
  7. The clearing of land.
  8. The erection of labourers' cottages, farm-houses, and other buildings required for farm purposes, and the improvement of and addition to labourers' cottages, farm-houses, and other buildings for farm purposes already erected, so far as such improvements or additions be of a permanent nature.
  9. Planting for shelter or for periodical cuttings, which will increase the permanent value of the land.
  10. The constructing or erecting of any engine-houses, water-wheels, saw and other mills, kilns, shafts, wells, tanks, reservoirs, dams, leads, pipes, conduits, watercourses, bridges, weirs, sluices, flood-gates, or hatches, which will increase the value of any land for farming or agricultural purposes.
  11. The erecting of any engines or machinery of a permanent nature, so as the same be erected in connection with and in the effecting of any works of or improvements in drainage or irrigation hereby authorised.
  12. The construction or improvement of jetties or landing-places on the sea coast or on the banks of navigable rivers or lakes, for the transport of cattle, sheep, and other agricultural stock and produce; and of lime, manure, and other articles and things for agricultural and farming purposes; provided that the Commissioners shall be satisfied that such works will add to the permanent value of the adjoining lands to an extent proportioned to the expenses thereof.
  13. "For the contribution due from any landowner towards any public or general works of drainage or other improvements, the cost whereof shall, by Act of Parliament or Royal Charter, or Commission, be directed or authorised to be assessed or charged upon the inheritance of the lands improved."
  14. "For the purpose of effecting any improvement under this or the recited Acts, it shall be lawful to get and work freestone, limestone, clay, sand, and any other mineral or substance out of the land to be improved or charged; and to make tramroads and other ways, and to burn and make bricks, tiles, and other things to be used in effecting such improvements," and also "for the same purpose, to cut down and use any timber or trees not planted or serving for shelter or ornament."
- Together with ample powers for making roads and drains over and through adjoining lands, and carrying out all other necessary works in connection with and to give effect to such improvements.
-

V.  
PRACTICAL AGRICULTURE.

BY

JOHN ALGERNON CLARKE.

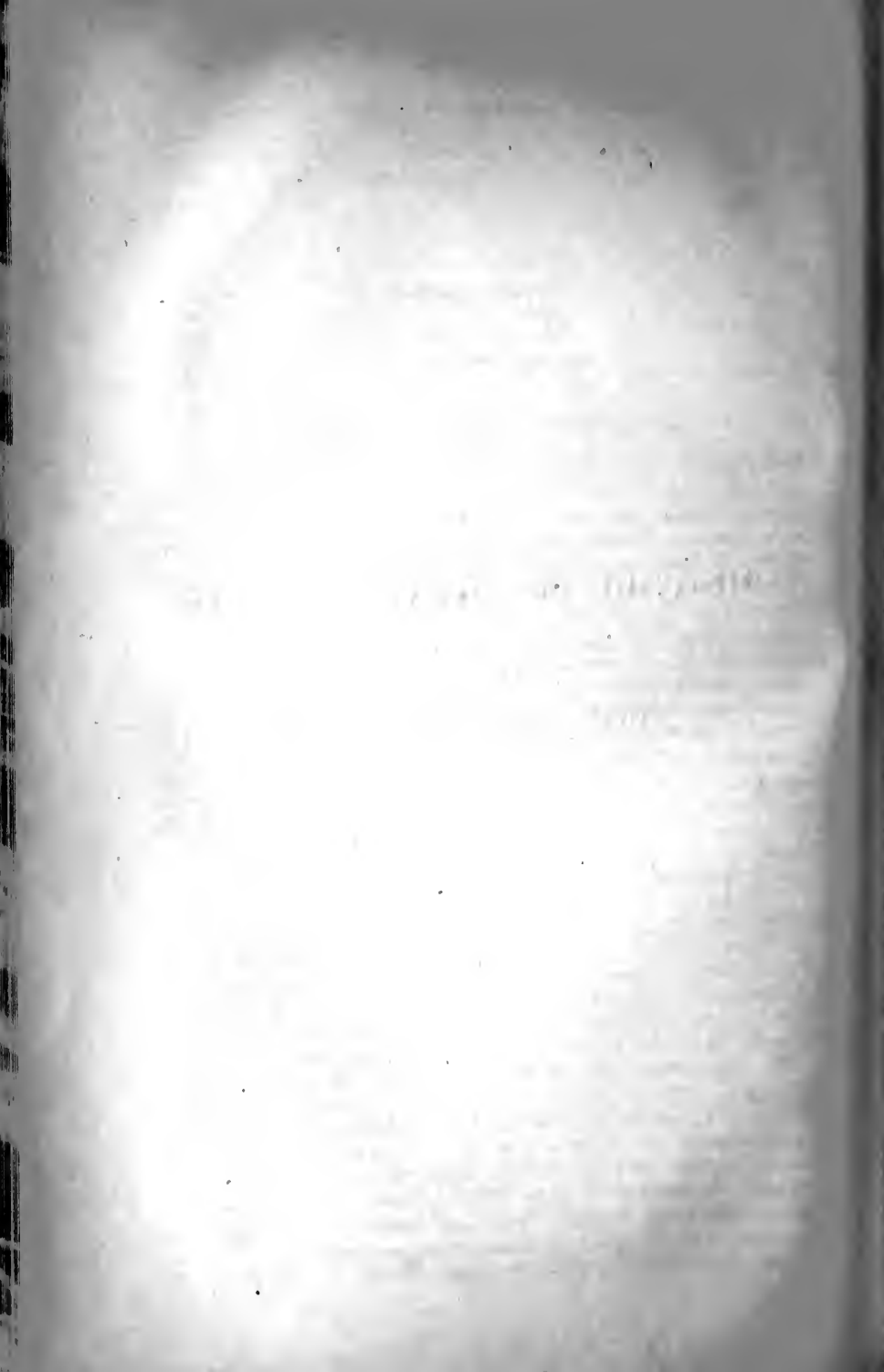

## CONTENTS.

CHAPTER I.—*Physical and Statistical.*

Introduction—Outline of Subjects treated—Climate—Temperature—Rainfall  
 Atmospheric Moisture—Prevailing Winds—Mr. J. Bailey Denton on the  
 English Climate—Hydrography—Geology—Distribution of Soils—Agricul-  
 tural Statistics—Diagram Map—Acreage of England and Wales—Distri-  
 bution of Uncultivated Area—Distribution of Pasture—Distribution of  
 Wheat Areas—Average Yield of Wheat per Acre—Difference in Yield  
 according to Season—Yield as affected by Quality—Total Wheat Produc-  
 tion, according to different Authorities—Standard Average Yield of Wheat  
 —Principal Wheat-producing Counties—Yields of Wheat and Barley com-  
 pared with those of Foreign Countries—The Live-stock Census gives only  
 the Summer Stocking of different Counties—Mr. C. S. Read, M.P., on  
 Summer and Winter Stock of Norfolk—Density of Summer Stocking in  
 proportion to Cultivated Area—Cattle—Sheep—Horses—Head of Live-stock  
 compared with that of Foreign Countries—Consumption of Oilcake—Im-  
 ports of Corn for Feeding—Imports of Artificial Manure      Pages 185-202

CHAPTER II.—*Prices of Agricultural Products.*

Corn Returns—Average Prices of Grain—Estimation of the Home Production  
 of Wheat—Home Crop of Wheat in different Years—Total Home and  
 Foreign Supply—Fluctuations in the Supply—Supplies and Prices—Home  
 Production of Barley—Barley Imports and Prices—Advance in the Price of  
 Meat—London Christmas Market for Thirty-seven Years—Summer Prices of  
 Meat for Twenty-six Years—Advance of Prices in the Metropolitan Market  
 —Mr. James Howard on the Advance in Price—Estimating the Home  
 Production of Meat—Data for Calculating the Number of Cattle killed—  
 Number of Calves and Cattle killed—Estimated Average Dead-weights of  
 Cattle—Number and Weights of Sheep and Lambs killed—Number and  
 Weight of Pigs killed—Total Home Supply of Meat—Foreign Animals  
 imported—Importation of Dead Meat—Total Meat Supply—Mr. J. C.  
 Morton's Estimates—Cheese—Butter—Earl Cathcart on Wool—Home Pro-  
 duction of Wool—Weight from different Counties—Imports and Exports—  
 Values of different Wools—Poultry—Eggs .. .. Pages 202-225

CHAPTER III.—*Management of Cattle.*

Age when beginning to Breed—Seasons for Calving—Spring Calving—Autumn Calving—Removing the Calf from its Dam—The Calf's Diet—Feeding the Calf—Milk Substitutes—Detailed Example of Rearing Calves—Weaning—Ailments of Calves—Grazing Calves—Wintering Calves—Open Yards for Cattle—Stall-feeding—Hammels—Boxes—Size of Yards, Stalls, and Boxes—Arrangements and Fittings of Feeding-houses—Covered Yards—Roots for Fattening Beasts—Mr. J. C. Morton on Money Value of Roots—Cooked Cattle-food—Mr. Warnes's Practice—Mr. Kennedy's Practice—Mr. Russell's Practice—Another Example of Feeding—Mr. Lawrence's Practice—Mr. Horsfall's Practice—Pulping Roots—Cattle Diet without Roots—Mr. Randall's Practice—Straw for Feeding—Steaming Chaff—Mr. Evershed's Practice—Mr. Mechi's Practice—Storing Straw-chaff—Mr. Jonas's Practice—Enhanced value of stored Chaff—Breaking Straw—Fattening Yearling Cattle  
Pages 225-249

CHAPTER IV.—*Management of the Flock.*

Ewes lambing twice in a Year—Selection and Age of Ewes for Breeding—Age of Rams used—Forwarding Ewes for the Ram—Matching Ewes and Rams—Time of putting Ewes to the Ram—Number of Ewes to a Ram—Marking the Ram—Treatment of Lambing Ewes—Losses by Abortion—Mr. Woods on Preventing Abortion—Early Lamb—Grazing Ewes and Lambs—Hampshire and Wiltshire Management—Mr. Rawlence's Practice—Shearing Ewes and Dipping Lambs—Time for Weaning—Mode of Weaning—Grazing Lambs—Preparing Lambs for Winter Food—Dipping—Bottling—Pouring—Smearing—Dips—Smear—Ointment—Time for Shearing—Sheep-washing—Winter Folding—Hurdles and Nets—Storing, Cleaning, and Cutting Roots—Changing the Keep—Dry Food—The Shepherd's Hut—Medicine and Dressing—Mountain Shelter—Wintering Sheep in Yards—Mr. Ruston's Practice—Mr. Randall's Practice—Shed-feeding Sheep .. Pages 249-263

CHAPTER V.—*Management of Pigs.*

Housing Pigs—Arrangements and Fittings of Sties—Age of Sows at commencement of Breeding—Farrowing—Feeding Young Pigs—Management of Store Pigs—Mr. C. S. Read, M.P., on Store Pigs—Fattening Pigs  
Pages 263-266

CHAPTER VI.—*Breeds of Cattle, Sheep, Pigs, and Horses.*

Shorthorns—Prices made—Eminent Breeders—Mr. Strafford's Description of a Shorthorn—Weights—Hereford Cattle—Points—Mr. Duckham's Description of a Hereford—Properties of the Breed—Fairs—Locality of the Breed—Breeders—Devons—Points—Mr. Davy's Description—Fairs—Breeders—South Hams Cattle—Mr. A. Heasman on Sussex Cattle—Points and Merits of the Breed—Longhorns—Bakewell's Improvement—Points and Merits—



The Longhorns as Milkers—The 'Field' on this Breed—Channel Island Cattle—The 'Field' on the History of the Breed—English Breeders—Guernseys and Jerseys—Scale of Points—Norfolk and Suffolk Polls—Mr. Fulcher on this Breed—Welsh Cattle—Pembrokeshires—Anglesea Breed—West Highland Cattle—Galloways—Aberdeenshire—Ayrshires—Leicesters The old Breed—Points of modern Leicesters—Weight of Mutton and Wool—Border Leicesters—Points—The old Lincolns—Improved Lincolns—Great Weights and Fleeces—Locality—Fairs—Breeders—Teeswater Breed—Romney Marsh Sheep—Weights—Devon Longwools—Points and Weights—Points of Cotswold Sheep—Weight and Wool—Locality of the Breed—Breeders—Ryeland Sheep—Southdown Breeders—Points of Southdown Sheep—Babraham and Merton Southdowns—Qualifications—Weights of Mutton and Wool—Hampshire Down Sheep—Mr. E. P. Squarey on this Breed—Hampshire Down Breeders—Sheep Fairs in Hants and Wilts—Weight and Wool—Creation of the Oxfordshire Downs—Points—Weights and Wool—Breeders—Origin of the Shropshires—Points of the Breed—Weights and Wool—Locality—Dorset Horned—Early Lamb—Exmoor Sheep—Welsh Mountain Sheep—Radnors—Cheviots—Points—Fairs—Black-faces—Points—Fairs—Lonks—Herdwicks—Points—Local Breeds not altogether superseded—Ancient Varieties of Pigs—Berkshires—Mr. Coleman's Description—Breeders—Tamworth Pigs—Improved Dorsets—Essex Pigs—Suffolk Pigs—Large-breed Whites—Small-breed Whites—Points—Middle-breed Whites—Horse-breeding—Suffolks—Points—Breeders—Clydesdales—Points—Breeders—Old-English or Shire-bred—Points—Breeders .. .. . Pages 266-315

## CHAPTER VII.

*Characteristic Crops which prevail in the Rural Economy of the Country*  
*—Different Courses of Cropping, as affected by Climate and Locality*  
*—Succession of Crops.*

Agricultural Itinerary—Soils of Kent—Rotation on Heavy Land in the North—Canary-seed—Crops in the Isle of Sheppey—Crops of the Isle of Thanet—Rotation on the Chalk—Market Gardens—Fruit and Hops—Romney Marsh—Sheep Management—Soils of Middlesex—Rotation of Crops—Sale of Hay, Straw, and Green Forage—Market Gardens—Soils and Crops of Surrey—Soils and Crops of Sussex—Soils of Hampshire—Course of Cropping in the Woodlands District—Crops in the Southern District—Rotations on the Chalk—Mr. Wilkinson on Advantages of Barley after Wheat—Arguments for two Turnip Crops in Succession—Sainfoin—Wiltshire—Dorsetshire—Devonshire—Cornwall—Soils of Somersetshire—Rotations on New Red Sandstone—Heavy-land Rotations—Gloucestershire—The Cotswold Hills—Rotations—Rafting—Paring and Burning—Crops in the Vales—Herefordshire—The Five-course Husbandry—Details of the Tillage—Oxfordshire—Crops in the Chiltern District—Mr. C. S. Read on Extra Crops—Trifolium—Shropshire—Wheat-land District—Corve Dale—Light Land—Clover alternating with Seeds—Warwickshire—Heavy-land Farming—

Details of its Husbandry—Mr. Lane's System of Extra Cropping on Loam Soil—Beans and Turnips—Peas and Cabbage—The Eastern Counties—Essex—Rotations—Mr. Mechi's Wheat after Wheat—Suffolk—Stetches—Rotations—Norfolk—Rotations—The Earl of Leicester's Improvements—The Four-course Shift improved—Autumn Tilling and Forking—Lincolnshire—Soils—Heath and Cliff—The Wolds—The Middle-Marsh—Rotations on the Clays—The Warp-lands—Isle of Axholme small Farms—Yorkshire—East Riding—Soils—The Wolds—Vale of York—Holderness—North Riding—Rotations—West Riding—Scmi-garden Rotations—Licorice—Special Crops on the Warp—Cheshire—Potato Culture—Lancashire—Selling Straw and Hay—Seeds—Bought Stable Dung—Liverpool Manure—Intensive Culture on small Farms—Free Sale of Produce .. Pages 316-354

### CHAPTER VIII.—*Manures.*

Artificial Manures—Major Dashwood's Practice—Mr. Treadwell's Practice—Mrs. Millington's Practice—Mr. Forester's Practice—Staffordshire Examples—Mr. May's Practice—Mr. Keeling's Practice—Mr. Clay's Practice—Mr. M. Walker's Practice—Mr. G. Gibbon's Practice—Mr. Hosegood's Practice—Mr. Charles Howard's and Mr. Checkley's Practice—An Example in Norfolk—Artificials in Lincolnshire—Artificials in Cambridgeshire and Suffolk—Superphosphate—Guanos and Nitrate—Quantities applied—Manures of limited Application—Fish—Seaweed—Composts—Durable Applications—Boning—Rape-cake—Marling—Chalking—Claying—Liming—Farming without Manure—Liquid-Manure Irrigation—Mr. Mechi's Practice—Other Examples—Farmyard-Manure—Open and Covered Yards—Greater Value of Covered-yard Manure—Saving in Straw—Dung-heaps—Dung-pits .. .. . Pages 354-362

### CHAPTER IX.

#### *Motive Power—Implements and Machines—Steam Cultivation.*

Ox-Teams—Farm-Horses—Number kept on different Soils—Management—Breeding—Colts—Breaking—Feeding—Cost of Horse-Power—Mules and Asses—Water Power—Wind Power—Steam Power—Amount of Steam Power used in Agriculture—Fixed and Portable Engines—Noted Homesteads—Messrs. Tuxford's Machinery on Lord Bateman's Farm—Messrs. Clayton and Shuttleworth's Machinery—Covered Stackyard—Messrs. Ransomes, Sims, and Head's Machinery—Simple Arrangement for Food-preparing Machinery—Steam Ploughs and Cultivators—The Fisken System—Wire-Rope System—Messrs. Barford and Perkins' Machinery—Messrs. John Fowler and Co.'s Machinery—Messrs. Howard's Machinery—The Double-Engine System—Horses Displaced—Messrs. Howard's Farms on Boulder Clay—Mr. Ruck's Practice on Calcareous Clay—Improvement of Poor Clay Pasture—Messrs. Fowler's Knifing—Mr. Smith of Woolston's Clay-land Husbandry—Non-inversion of the Soil—Autumn Ridging for Mangolds—Labour-saving Implements of late introduction Pages 362-375

# PRACTICAL AGRICULTURE.

## CHAPTER I.

### PHYSICAL AND STATISTICAL.

AGRICULTURAL England—from the warm hop and fruit grounds of Kent and the dry chalk Downs of Sussex to the bleak northern Cheviots and the stormy fells of Cumberland; from the rich wheat and root lands of East Yorkshire to the moors of the West Riding and the mosses of Lancashire; from the fat marsh lands and high-cultured wold and heath farms of Lincolnshire to the mountain ranges of Carnarvon; from the arid barley lands of East Anglia and the corn-growing clays of Essex to the moist uplands and lofty sheepwalks of South Wales; from the hay meadows of Middlesex and the sands of Surrey to the sheep-clad hills of Dorset, the rank pastures of Somerset, and the corn and dairy farms, mild garden grounds, apple-orchards, and granite wilds of Devon and Cornwall—who shall adequately portray its arable and pastoral husbandry in the pages of a brief memoir? All that any writer can hope to accomplish is inadequately to picture English farms and homesteads of hill and vale—whether occupations held by capital or wrought by the labour of small cultivators, under the dry climate of the east, the humid atmosphere of the west, the chill north, or the more genial south—to describe very briefly the varied systems of cultivation upon loams and sands and clays; the adaptation of crops and management to different soils and climates, and to the demand of great cities for special products; diversities of practice in tillage, manuring, harvesting, food-preparing, as conducted by the most eminent managers; and the breeding, rearing, and fattening of live-stock upon the richly cultivated plains, in the mid-regions between the lowlands and uplands, and on the unsheltered heights of moorland and mountain. He may relate only in short sketches how arable and pasture are reclaimed from barren wilds, water-laden bogs, and tidal estuaries; how steam-power and mechanical inventions have remodelled old methods of husbandry; how manufactured

Introduction

Outline of subjects treated.

manures and feeding-stuffs are employed to enhance the yield of grain and augment the production of meat, milk, butter, cheese, and wool; how public spirit and emulation in the national, county, and local exhibitions have promoted the improvement of every breed of cattle, horses, sheep, and swine. And he may treat still more concisely of prices and of the methods of commercial transactions by which the farmers' raw materials, motive-powers, tools, and plant, are purchased, and by which the products of his land and premises are disposed of and distributed to consumers.

Climate.

The diversified and fickle climate of England and Wales may be described in brief by reference to Tables of temperature, rainfall, atmospheric moisture, and prevailing winds.

Temperature.

It will be observed that the range of the thermometer is much shorter in the western than in the eastern districts; the difference between the January and the July temperature being, for instance, only 18·3 degrees at Truro, in Cornwall, while it is 29·6 degrees at Cobham, in Kent; and, again, only 21·1 degrees at Lancaster, while it is 30·1 at York. The differences between day and night temperatures are quite as marked.

MEAN, MAXIMUM, and MINIMUM TEMPERATURES in Degrees Fahrenheit.

	Spring.			Summer.			Autumn.			Winter.		
	Mean Maximum Temperature.	Mean Minimum.	Mean Daily Range.	Mean Maximum Temperature.	Mean Minimum.	Mean Daily Range.	Mean Maximum Temperature.	Mean Minimum.	Mean Daily Range.	Mean Maximum Temperature.	Mean Minimum.	Mean Daily Range.
Helston (Cornwall) ..	58·2	44·0	14·0	68·6	53·6	15·0	59·6	48·3	11·0	48·5	39·8	8
Chiswick (Middlesex)	58·0	39·9	18·0	73·1	51·1	22·0	58·8	42·0	17·5	44·1	33·2	11
Nottingham.. ..	56·7	41·0	15·7	75·2	56·4	19·0	57·3	45·3	12·0	42·6	34·9	8
Thwaite (Suffolk) ..	54·0	40·4	14·0	70·6	52·9	18·0	56·8	44·5	12·0	42·0	33·7	8

Thus, while the mean temperatures of two counties, such as Cornwall and Middlesex, vary only 1·2 degrees in summer, there are 7 degrees difference between their mean daily ranges; for at sunrise, in summer, the air in Cornwall is  $2\frac{1}{2}$  degrees warmer than it is in Middlesex, but the extreme heat of the day in Cornwall falls  $4\frac{1}{2}$  degrees short of that in Middlesex.

As a general rule, the annual temperature of England decreases one degree for every 111 miles from south to north, and one degree for every 66 miles from west to east, while the mean temperature of the middle of England is from 2 to 4 degrees

colder than that of the east. Altitude exerts a considerable influence upon temperature; and though considerable variations occur, it may be stated in general that there is a diminution of one degree of heat for about 300 feet perpendicular elevation.

Westerly gales, often saturated with moisture from the Atlantic, pour down upon the western parts of the kingdom much more rain than falls on the eastern side. In the west, a greater quantity also falls in autumn and winter than in summer, while in the east this is reversed. The minimum average annual rainfall on the western side of England is about 32 inches in the lower districts, and the maximum 146 inches on the mountains. And there are wet days in a year amounting to a minimum of 135 for the lower grounds, and a maximum of 250 on the hills. On the eastern side of England, the minimum annual rainfall is about 20 inches, and the maximum 33 inches; the number of wet days in a year being about 115 in the driest up to 185 in the wettest localities. (See Table, page 11.)

The hygrometric condition of the atmosphere in the western and eastern parts of England does not vary so much as might be expected. Thus the evaporation from a sheet of water amounts to 21.5 inches in a year on the western side, and 26.7 inches on the eastern side of the kingdom. The quantity ranges from 0.4 inch in December, and a like amount in January, up to 4.2 inches in June—the evaporation in each month being somewhat greater in the eastern than in the western counties. The dew-point in January is in the north-west 31 degrees, in the south-west 40 degrees, in the north-east 30 degrees, and in the north-north-east 31 degrees. In August it is 52 degrees in the north-west, 58 degrees in the south-west, 51 degrees in the north-east, and 56 degrees in the south-east.

The prevailing winds blowing over England for two-thirds of the year, are from points varying between south and north-west, as appears from the following Table:—

GENERAL DIRECTION of the WIND.

Place.	N.	S.	E.	W.	S.W.	N.W.	S.E.	N.E.	Number of Observations.
Lancaster (Lancashire)	30	51	17	47	92	26	35	67	365
London .. .. .	16	18	26	53	112	50	32	58	365
Truro (Cornwall) ..	63	67	90	129	173	162	114	82	880

Summing up the general characteristics of the climate, it may be stated in the words of Mr. J. Bailey Denton, that the western

Rainfall.

Atmospheric moisture.

Prevailing winds.

Mr. J. Bailey Denton on the

## MEAN MONTHLY TEMPERATURE in Degrees Fahrenheit.

## WESTERN SIDE OF ENGLAND.

	January.	February.	March.	April.	May.	June.	July.	August.	September.	October.	November.	December.	Difference between greatest Heat and Cold.
Keswick .. .. .	36.3	38.6	48.5	44.8	51.1	55.7	58.4	58.0	52.8	48.1	41.3	36.9	22.3
Lancaster .. .. .	36.5	38.0	37.2	44.2	51.1	55.7	57.7	57.0	54.2	47.3	40.3	36.6	21.1
Manchester .. .. .	36.7	39.3	41.8	47.1	53.2	58.2	60.8	60.4	56.3	50.0	42.9	39.0	24.1
Exeter .. .. .	40.9	41.1	43.4	48.3	54.9	59.9	61.1	61.1	57.3	51.0	46.4	42.3	20.1
Truro .. .. .	42.8	42.6	44.6	48.6	54.0	58.8	60.1	61.0	57.7	51.1	47.0	43.8	18.3

## EASTERN SIDE OF ENGLAND.

York .. .. .	33.4	39.0	42.9	48.2	57.0	61.1	62.4	63.5	57.2	47.8	40.8	36.4	30.1
Boston .. .. .	35.9	35.0	45.3	47.1	54.7	62.0	62.4	62.6	57.3	48.6	42.9	41.1	27.5
Norwich .. .. .	36.8	37.5	40.9	45.3	51.5	57.9	61.3	61.3	56.6	51.5	41.9	39.2	24.5
Chiswick .. .. .	37.1	38.0	41.8	47.4	54.7	60.6	62.2	61.8	56.1	49.2	43.5	38.4	25.1
Cobham .. .. .	35.3	38.5	43.9	48.0	56.1	60.5	60.5	65.0	57.5	47.1	43.1	38.7	29.6



AVERAGE MONTHLY RAINFALL in Inches.

WESTERN SIDE OF ENGLAND.

Place.	January.	February.	March.	April.	May.	June.	July.	August.	September.	October.	November.	December.	Total.
Keswick (Cumberland) ..	4.87	2.63	4.60	4.24	3.02	4.12	4.94	5.85	4.41	9.00	8.35	6.06	62.72
Lancaster (Lancashire) ..	3.46	2.99	1.75	2.18	2.46	2.51	4.14	4.58	3.75	4.15	3.75	3.95	39.71
Manchester (Lancashire)	2.31	2.56	2.09	2.01	2.90	2.50	3.69	3.66	3.28	3.92	3.36	3.83	30.14
Exeter (Devonshire) ..	3.32	2.35	2.34	1.97	2.14	2.26	1.91	2.59	2.60	3.69	4.67	2.74	32.58
Truro (Cornwall) .. ..	4.66	3.79	3.44	2.54	2.41	2.79	2.64	3.04	3.68	4.08	6.11	4.90	44.08

EASTERN SIDE OF ENGLAND.

York (Yorkshire) .. ..	1.72	1.02	1.19	1.50	1.41	2.35	2.65	2.93	2.08	2.09	1.75	1.31	22.02
Boston (Lincolnshire) ..	1.59	1.45	1.52	1.50	2.17	2.41	2.77	2.83	2.24	2.72	2.26	1.44	24.90
Norwich (Norfolk) .. ..	1.97	1.45	1.16	1.79	1.91	1.77	3.10	2.76	2.48	2.94	3.02	1.74	26.09
Chiswick (Middlesex) ..	1.95	1.66	1.43	1.40	1.85	1.79	2.05	2.75	2.37	2.92	2.70	1.53	24.40
Cobham (Kent) .. ..	2.24	2.38	1.72	1.21	3.19	1.44	2.27	2.93	3.57	2.88	4.41	1.96	25.25

English climate.

side of England is much wetter than the eastern side; that the air on the western side is more constantly humid than that on the eastern; that cold increases in England with every degree of north latitude, and that commonly, though not invariably, the differences in the extremes of heat and cold are greater as the east is approached; that the high grounds of the western and northern parts of England are more exposed to prevalent winds than the eastern and southern parts; and that the hygrometric state of the atmosphere on the eastern side being nearly at all times such as to absorb a great quantity of moisture, the evaporation is more active than on the western side of England,—from a sheet of water it actually exceeds the rainfall.

Hydrography.

The principal watersheds and main outfalls for the drainage of England and Wales require a few words of description.

The directions of the hill and mountain chains influence both the lines of the rivers and the quantity and force of the water discharged. The Cumbrian, Welsh, and other western mountains, occasion a fall of rain in the western counties some 50 per cent. greater than in the midland and eastern districts. Some impervious rocks shed off the rains and melting snows in torrents; while fissured strata, cleaved slate, and absorbent chalk or sandstone, imbibe a large portion of the downfall, much of it to be thrown out again upon porous declivities, or clay plains, or deeplying valleys. The great surplus of water, not lost by evaporation, which escapes from the western or central watershed, runs towards the sea in a generally eastern direction; for the largest English rivers, except the Severn, empty themselves upon the low east coast. The principal points of discharge are the estuaries of the Humber, the Wash, the Thames and the Severn; their respective drainage areas being very large. Then the Yorkshire Ouse, the Trent and other Humber rivers radiate into Westmoreland, Staffordshire, Warwickshire, Leicestershire, including all Derbyshire and Nottinghamshire; the sluggish Wash rivers, the Ouse, Nene, Welland, with minor streams, embrace in their system of flat valleys parts of Lincolnshire, Rutland, Leicestershire, Northamptonshire, Bedfordshire, Buckinghamshire, Huntingdonshire, Cambridgeshire, Suffolk, and Norfolk; the Thames and its feeders extend inland into Buckinghamshire, Oxfordshire, Gloucestershire, Wiltshire, Berkshire, Hampshire, besides Surrey, Middlesex, Kent and Essex; and the Severn stretches back through the counties of Gloucester, Worcester and Salop, into Warwickshire, Staffordshire, and Montgomeryshire; while the Wye and other tributaries ramify through the counties of Monmouth, Hereford, Radnor, and Brecknock. In addition to these chief arteries of the central counties, there are innumerable streams from the Lake district, the Welsh highlands, and the southern,

eastern, and northern provinces, aggregating into considerable estuaries round the coast line—such as the Eden, Lune, Ribble, Mersey, Dee, Conway, Towy, Taff, Usk, Avon, Parrett, Taw, Tamar, Dart, Exe, Test, Arun, Rother, Stour, Medway, Crouch, Blackwater, Colne, Orwell, Yar, Tees, Wear, Tyne and Tweed. Now, although outfall improvements yet remain to be effected, the principal outlets may be considered able to evacuate any amount of water likely to flow to them, because in most instances the drainage exigencies of the alluvial deltas, added to the demands of deep-water navigation, have caused them to be opened, embanked, and watchfully preserved. Thus, the great works which have procured an unimpeded outflow for the Ouse, Nene, Welland and Witham rivers, through the muddy shoals of the Wash, are justly celebrated as triumphs of engineering. Similar improvements of the Trent, Yorkshire Ouse, and associated streams, have facilitated the confluence of their waters with the Humber. In East Norfolk, not only the mouths of the streams have been guarded, but the very existence of the seaport of Yarmouth has been secured by artificial ramparts of sand and beach. Below Chester the river Dee has been straightened, and a large tract of its white sands reclaimed. In Somersetshire the flat land has been embanked from the sea, and the mouth of the Parret and its connected rivers confined from spreading into shallow water; while several harbours and estuaries along the south coast have skilfully contended with the waves and shifting shingle of the Channel. It is not so much the river mouths or the inland courses which are defective as drains for conveying away the surplus water from land. The main streams, branches, becks, and brooks have neither been left to follow their natural levels, nor have their currents been directed by art; but they have been dammed into reservoirs, intercepted for canals, held back as feeders for deep-water navigation, or lifted to gain a water-power for myriads of mills, especially in the northern, western, and central counties. Hence, in most of the low-lying districts of England, the broad meadows, coarse pasture, and wet arable lands fringing the rivers, are permanently damaged by the prevention of good husbandry and periodically visited with grievous losses and inundation; while frequent disasters, with great destruction of property and even of human life, fall upon upland valleys. Over vast breadths of the country, too, where main drainage is not under systematic supervision as a first necessity for agriculture, water-courses are commonly found wandering in irregular channels, impeded in their flow, and too often choked with a semi-aquatic, semi-sylvan growth of vegetation. Improvements in the arterial drainage of England have been prevalent of late years, but, in spite of legislation on this subject, the

absence of systematic supervision of the discharge of flood waters, the regulation of irrigation works, and the storage of water for the supply of villages and small towns, is one of the blots on English local government. The extension of subsoil drainage, too, though only a minor proportion of the drainable land has been effectively relieved of wetness and rendered a more porous and friable matrix for the rooting of plants, has intensified the evil of insufficient main arteries, by pouring into them a larger proportion of water and in quicker time than formerly.

Geology.

Unique among all the kingdoms of the world is England in respect of its geological structure, comprising in its comparatively small area portions of nearly all the great strata—primary, secondary, tertiary, and quaternary, which are to be found over the whole globe. Hence the wondrous diversity of soils, the sudden transitions from light to heavy land, or the intermingling of breadths of clay, sand, and limestone upon the area of a single farm, sometimes of a single field. Looking at a geological map of England and Wales, one might think it convenient for description of the husbandry to treat as distinct districts the principal formations which, in coloured strips, are seen ranging generally from south-west to north-east; the older rocks most westward, and the series superposed upon each other in succession until the most recent beds appear in the east. One might treat in one division the granite, trap, slates, shales, and schists of West Cornwall, Devon, South and North Wales, the Lake region, and Northumberland; in another, the Silurian soils of Herefordshire, Carmarthen, Radnor, and Shropshire; in another, the marls and rich loams of the Old Red Sandstone of Herefordshire, Monmouth, and Brecon; in another, the mountain limestones and grits of Somerset, Derbyshire, West Yorkshire, Cumberland and Westmoreland; in another, the coal-fields of Gloucestershire and Glamorgan, of Shropshire and Flint, of Cheshire, Staffordshire, Derbyshire, and Leicestershire, of Lancashire, the West Riding, Cumberland, Durham and Northumberland; in another, the loams and marls of the New Red Sandstone, the most extensive geological formation in England, stretching from Torbay in Devonshire, through Somerset, Gloucestershire, Worcestershire, Warwick, Nottingham, York, to the mouth of the Tees in Durham, and from Warwickshire, through Staffordshire and Cheshire to Lancashire; in another, the lias clays, running in a narrow belt through the whole country from the Dorset coast to Yorkshire; in another, the oolite and brash lands, also occupying an irregular strip of country from Dorset to Yorkshire; in another, the Oxford and Kimmeridge clays; in another, the

Hastings sand and the Wealden clay of Kent, Sussex and Surrey; in another, the belts of greensand and gault soils in Somerset, Wilts, Berks, Bucks, Bedfordshire, Cambridgeshire, and Kent; in another, the chalk soils in Kent, Sussex, Surrey, Wilts, Hants, Berks, Oxfordshire, Bucks, Herts, Cambridgeshire, Suffolk, Norfolk, and Lincolnshire to the Yorkshire cliffs; in another, the plastic and London clays of the Isle of Wight, Kent, Essex, Surrey and Middlesex, and the crag and Bagshot sands of the Isle of Wight, Surrey, Essex, Suffolk, and Norfolk; in another, the clays, loams, and gravels of the drift distributed over all parts of the kingdom; in another, the scattered deposits of peat, whether mountain bogs, or fen levels; and in another, the marsh-lands and valleys of marine or river-side alluvium.

But the very multiplication of varieties of different soils derived from disintegration of the underlying rocks and the extent to which the regular strata have been overspread by accumulations of drift, forbids such lines of demarcation being drawn between the different systems of farming. And the geology of England is referred to here only for the purpose of indicating the general distribution of the chief groups of clayey, calcareous, and siliceous soils. Clays will be dealt with in a separate section. Calcareous soils, of a compact, adhesive, tenacious character, are found on the chalk-marl, oolite, and drift formations; calcareous gravelly soils occur upon the drift covering the Oxford and blue lias clays; calcareous soils also prevail on the upper and lower chalk, and the shelly and great oolite formations; and calcareous soils of a porous, friable description prevail on the coral-rag, lower oolite, magnesian limestone, and carboniferous limestone. Light, sandy, and gravelly soils rest upon the plastic clay, iron-sand, and Hastings sand, the sand of the coal formation, and on the millstone grit and old red sandstone; flinty gravels are found on the drift covering the plastic clay and the weald clay; clayey and sandy gravels are upon the drift-beds of the new red sandstone and coal formations, and upon the Silurian and clay-slate formations; calcareous and ferruginous sands are upon the new red sandstone, and the trap or basaltic rocks; and sandy loams form the surface of the greensand beds, and most of the marine and lacustrine alluvium.

This land of a tessellated subdivision and arrangement of soils may be best treated of county by county, with regard to some features of its husbandry, while the characteristic crops and breeds of animals demand sub-sections for themselves. For the purpose of presenting at one view some of the principal points in the distribution of uncultivated area, of pasture, of green crops, of corn-crops, of the areas and yields of wheat in

Distribution of  
soils.

Agricultural  
statistics.

Diagram-map.

particular, and of the relative density of the head of live-stock in the different provinces, I have designed the Diagram-map which accompanies this division of the Memoir (see *Frontispiece*). Writing on agricultural statistics in the Royal Agricultural Society's 'Journal' in the year 1856, Mr. C. Wren Hoskyns introduced the novelty of a statistical map of England, representing, by stripes of differing character running across a square, the proportional areas under the several descriptions of crop; observing that the reader who looked in the diagram for rivers and mountains, cities and sea-ports, bays and promontories, and other usual accessories of a map, would turn away with a smile from such hydrography, in which parishes, hundreds, and even county-boundaries, were ignored. The device was excellent, expressing as it did to the eye, through the medium of geometrical form, an idea of the comparative magnitude of areas which had been previously stated in numbers of acres. But it contained no intimation as to geographical distribution of the several proportions of surface under each kind of produce; and the present Diagram-map has therefore been constructed so as to present at a glance the general configuration of England and Wales, the relative situation and size of each county, and an epitome of its principal agricultural statistics exhibited upon each. The scale upon which it is drawn is about one square inch to every million acres.

I will here enumerate some of the chief facts to be drawn from this statistical picture.

The total area of land of all descriptions and of water in England and Wales is, according to the Agricultural Returns, 37,319,221 acres; and of this, the area under all kinds of crops, bare fallow, and pasture, in 1877, was 27,043,192 acres; the area of orchards, market-gardens, nursery-grounds, or of arable or grass-land used also for fruit-trees, was 206,952 acres; and the area under woods, coppices, and plantations, was 1,452,588 acres; leaving 8,616,489 acres, or nearly one-fourth of the entire surface, as uncultivated land, roads, railways, rivers, lakes, estuaries, foreshores, towns, collicries, quarries, works, gardens, and occupations under one-fourth of an acre.

Aereage of  
England and  
Wales.Distribution of  
uncultivated  
area.

Looking at the Diagram-map, it will be seen that the counties having the largest proportions of uncultivated area within their boundaries are—Northumberland, Cumberland, Westmoreland, Durham, the North Riding of Yorkshire, Lancashire, North Wales, South Wales, Middlesex, Surrey, and Cornwall. In these counties the cultivated area is from about 55 up to more than 60 per cent. Counties having two-thirds up to three-fourths of their area under cultivation are the West Riding of Yorkshire, Cheshire, Derbyshire, Kent, Sussex, Hampshire,



and Devonshire. In the remaining counties more than three-fourths of the total area is under crops and grass. But it should be remarked that the uncultivated area in some counties, as, for example, Lincolnshire, cannot really be so large as the statistics would indicate; considerable errors having probably arisen from including extensive foreshores, and even so-called but actually cultivated "marshes," as "water." Permanent pasture occupies more than half the cultivated surface in Northumberland, Cumberland, Westmoreland, Lancashire, the West Riding of Yorkshire, Cheshire, Derbyshire, Shropshire, Staffordshire, Leicestershire, North Wales, South Wales, Herefordshire, Monmouthshire, Middlesex, and Somersetshire. It is one-fourth up to one-half in Durham, the North Riding of Yorkshire, the East Riding of Yorkshire, Lincolnshire, Nottinghamshire, Rutland, Huntingdonshire, Bedfordshire, Hertfordshire, Northamptonshire, Buckinghamshire, Berkshire, Oxfordshire, Worcestershire, Gloucestershire, Kent, Surrey, Sussex, Wiltshire, Dorsetshire, Devonshire, and Cornwall. The permanent grass forms less than one-fourth of the cultivated area in Norfolk, Suffolk, Essex, Cambridgeshire, and Hampshire. Of the arable land, the major portion is in root and green crops, and in grasses under rotation, in Cumberland, Westmoreland, Lancashire, Cheshire, North Wales, Cornwall, Devonshire, and Hampshire. These crops occupy 40 to 50 per cent. of the arable land in Northumberland, Durham, the North Riding of Yorkshire, the East Riding of Yorkshire, Lincolnshire, Norfolk, Nottinghamshire, Derbyshire, Staffordshire, Shropshire, Herefordshire, South Wales, Monmouthshire, Gloucestershire, Berkshire, Middlesex, Surrey, Sussex, Wiltshire, Dorsetshire, and Somersetshire. In the remaining counties green and grass-crops in rotation occupy below 40 per cent. of the arable land.

Distribution of  
pasture.

Of the land under corn, no county has quite half in wheat; the greatest proportion in any county under wheat being in Shropshire, Herefordshire, Worcestershire, Gloucestershire, Warwickshire, Bedfordshire, Huntingdonshire, Cambridgeshire, Lincolnshire, Essex, Sussex, Wiltshire, Somersetshire, and Devonshire. Next in order for large area of wheat in proportion to the total arable crops, are the East Riding of Yorkshire, Nottinghamshire, Derbyshire, Staffordshire, Northamptonshire, Buckinghamshire, Herefordshire, Norfolk, Kent, Surrey, Berkshire, and Hampshire.

Distribution of  
wheat areas.

It will be seen by the black patches on the Diagram-map that the wheat-crop prevails most on the eastern side of England, and in the midland and southern counties. The area of wheat in England and Wales in 1875 was 3,240,344 acres; in 1876 it fell to 2,916,765 acres; and in 1877 it was

Average yield  
of wheat per  
acre.

3,087,355 acres. But for the nine years, 1866 to 1875, the extent did not vary quite 5 per cent. from the average of about  $3\frac{1}{2}$  million acres. As indicated by the green spots, shaded in four different manners to represent four different rates of produce, the average yield of wheat per acre is greatest in the East Riding of Yorkshire, Lancashire, Lincolnshire, Huntingdonshire, Northamptonshire, Cambridgeshire, and Kent; in all these counties exceeding 32 bushels, and in Kent reaching the maximum of  $33\frac{3}{4}$  bushels. It is under 32, but up to 30 bushels in the West Riding of Yorkshire, Nottinghamshire, Leicestershire, Rutland, Norfolk, Bedfordshire, Middlesex, Worcestershire, Warwickshire, Oxfordshire, Berkshire, and Sussex. The average yield is 28 and under 30 bushels in Cumberland, Westmoreland, the North Riding of Yorkshire, Derbyshire, Staffordshire, Suffolk, Hertfordshire, Buckinghamshire, Gloucestershire, Monmouthshire, Somersetshire, Wiltshire, Dorsetshire, Hampshire, and Surrey; and in Northumberland, Durham, Shropshire, North Wales, South Wales, Herefordshire, Devonshire, and Cornwall, it is below 28 bushels per acre.

Difference in  
yield accord-  
ing to season.

While the total area under wheat in any year has, until lately, scarcely varied 5 per cent. from the average, and the Returns of the Board of Trade, indeed, may not be accurate within much less than that—so that the difference between the greatest and smallest area given may reach as much as 9 or 10 per cent.—the most prolific total yield may be one-third more than the worst. That is, from inquiries made (which are referred to in the chapter on “Prices”), a harvest may give only 25, or it may give up to 34 bushels per acre as an average for England and Wales; and a further difference may be superadded by the difference in quality; as in a year of fine quality the average weight per bushel may be 62 lbs., and in a season of inferior quality only 60 lbs., making a difference of about 3 per cent. in the total weight of wheat grown. The standard average weight of English wheat per bushel may be taken at 61 lbs. In the Trade and Navigation Tables hundredweights are reduced into imperial quarters, on the assumption that foreign and colonial wheat imported averages a little under 61 lbs. per bushel.

Field as  
affected by  
quality.

Total wheat  
production,  
according to  
different au-  
thorities.

The yield of our home crop has been estimated from an elaborate collection of the opinions of growers given for their several districts. In the year 1856 Mr. James Caird put the general average of England and Wales at  $26\frac{1}{2}$  bushels. In 1868, the same authority raised his estimate to 28 bushels, which is also Mr. M'Culloch's estimate in 1853. Messrs. Lawes and Gilbert, in 1868, in a Paper in the Royal Agricultural Society's 'Journal,' quoted estimates of various authorities ranging from 28 up to 32 bushels, remarking that, “perhaps the most gene-

rally assumed average is 30 bushels." According to the Rothamsted computation, the average of England and Wales, extending over a period of sixteen years—1852 to 1867—is  $28\frac{3}{4}$  bushels for England and Wales,  $27\frac{3}{4}$  bushels for Scotland; or for Great Britain  $28\frac{5}{8}$  bushels; while for Ireland it is  $23\frac{7}{8}$  bushels, and for the United Kingdom  $28\frac{1}{4}$  bushels. In 1851 the 'Mark Lane Express' collected the opinions of five hundred correspondents in England for the ten years—1852 to 1861—in which the yields of the several counties range from  $22\frac{1}{4}$  up to  $34\frac{1}{4}$  bushels, making a general average for England of 29 bushels. In 1867 'The Farmer' published an estimate of the produce per acre for that year on the different geological formations instead of for counties; the average coming out 31 bushels on the Drift, 27 bushels on the Tertiaries,  $28\frac{1}{2}$  on the Chalk and Green Sand,  $21\frac{1}{2}$  on the Wealden, 29 on the Oolite and Lias, 19 on the New Red Sandstone, &c.; the general average for that defective year being 26 bushels. In 1870 the 'Chamber of Agriculture Journal and Farmer's Chronicle' made an inquiry into what constitutes a normal or average yield of wheat; the estimates collected being obtained from hundreds of leading farmers, distributed through the Poor-law Unions, and each stating his opinion from his own district or part of a Poor-law Union. From this information the classification on the Diagram-map has been made.

Multiplying the mean yield for each county by the average number of acres grown in that county, the total production of the kingdom was calculated; and the total production divided by the total acreage gave the general average yield per acre. The result brought out was, that the standard average wheat production of England is  $29\frac{9}{10}$  bushels per acre; of Wales, 27 bushels; of Scotland, 29 bushels; of Great Britain,  $29\frac{9}{10}$  bushels; of Ireland, 25 bushels; of the Islands, 28 bushels; and of the United Kingdom  $29\frac{1}{2}$  bushels per acre. At the average area for the four years, 1868–71, the normal produce would be, for England, 12,484,000 qrs.; for Wales, 473,000 qrs.; for Scotland, 470,000 qrs.; for Great Britain, 13,427,000 qrs.; for Ireland, 840,000 qrs.; for the Islands, 43,000 qrs.; and for the United Kingdom, 14,310,000 qrs. But this total production has not been maintained; for while the average area of wheat in the United Kingdom for the years 1868–71 was 3,870,000 acres, it had fallen off to 3,514,000 acres in 1875, and to 3,124,000 acres in 1876. In Great Britain, the area sank in eight years from 3,688,000 acres in 1869 to only 2,995,000 acres in 1876, or a decrease of nearly one-fifth; and for 1877 it is 3,168,500 acres.

Half the total wheat-produce of the United Kingdom is grown in eleven English counties, namely, Lincolnshire, Yorkshire, Essex, Standard average yield of wheat. Principal wheat-pro-

ducing coun-  
ties.

Norfolk, Suffolk, Cambridgeshire, Kent, Hampshire, Sussex, Wiltshire, and Gloucestershire. Nearly one-fourth of the whole is grown in three counties, namely, Lincolnshire, Yorkshire, and Essex. In fact, Lincolnshire, which heads the list with a maximum crop of  $1\frac{1}{4}$  million quarters, reaps and thrashes above a fifth more wheat than all Scotland and Ireland.

Yields of  
wheat and  
barley com-  
pared with  
those of foreign  
countries.

For the credit of English husbandry, it will be well to compare its standard yields of wheat and of barley (the latter estimated from the same elaborate collection of returns from growers upon which the produce of wheat is founded) with the yields of those cereals in foreign countries—this information being supplied in the Board of Trade Agricultural Returns for 1876.

ESTIMATED YIELD per Acre of WHEAT and BARLEY in Imperial Bushels per Statute Acre in the undermentioned Countries.

Country.	Wheat.	Barley.*
England .. .. .	$29\frac{9}{10}$	
Wales .. .. .	27	
Scotland .. .. .	29	
Great Britain .. ..	$29\frac{9}{10}$	
Ireland .. .. .	25	
Islands .. .. .	28	
United Kingdom ..	$29\frac{1}{2}$	37
Holland .. .. .	$28\frac{1}{2}$	42
Belgium .. .. .	$20\frac{1}{3}$	35
Wurtemberg .. ..	18	$21\frac{1}{4}$
Bavaria .. .. .	$16\frac{1}{2}$	20
Egypt .. .. .	$15\frac{1}{2}$	$20\frac{1}{4}$
France .. .. .	$13\frac{1}{2}$	$18\frac{3}{4}$
Greece .. .. .	$13\frac{1}{4}$	$18\frac{3}{4}$
Austria (Proper) ..	$12\frac{3}{4}$	$13\frac{1}{2}$
Portugal .. .. .	9	11
Hungary .. .. .	$8\frac{1}{2}$	$13\frac{1}{2}$
Russia .. .. .	$5\frac{1}{2}$	8

The live-stock  
census gives  
only the  
summer  
stocking of  
different coun-  
ties.

The density of the stocking with cattle, sheep, and horses, is shown in the Diagram-map by three colours, each with four degrees of shading; the facts being calculated from the Agricultural Returns. It must be understood that the figures in the Census on the 25th of June, give the head of live-stock in each county on that day in the middle of the summer, and not the number which would be found in the county on an average day; or, in other words, on an average of the four seasons. So that Norfolk, for instance, with its small propor-

\* In Continental countries, barley includes bere.

tion of grass-land, appears in the return on the map in the class of counties possessing the smallest head of horned stock in proportion to cultivated area; while Leicestershire, with its very large proportion of grazing land, appears among the very highest stocked with cattle. In a winter Census this would be exactly reversed; Norfolk, with its large proportion of arable land, would then have in its farmyards a heavy stock of cattle in proportion to its arable and pasture together; Leicestershire, with its small proportion of arable, would necessarily have a much smaller number of cattle, not in proportion to its arable, but in proportion to its arable and pasture together. As to Norfolk, Mr. C. S. Read, M.P., in giving evidence before the Select Committee of the House of Commons on Cattle-Plague and Importation of Live Stock, in the present year, said that "though the agricultural returns may be satisfactory in the gross, they are misleading when you come to localities. For instance, they are collected in June, when we in Norfolk have no cattle. I wrote to three graziers, one in North Norfolk, one in South Norfolk, and one in West Norfolk, just at haphazard, to ask them to give me the number of cattle that they had over two years old that they had returned to the Board of Trade last June, and the number that they had in the previous December. The total that they had last month was 98, and the total that they had last December was 414. Those were over two years old; and when it has been so frequently said that I exaggerate the import of cattle from Ireland to Norfolk, I can only say that the Great Eastern Railway last year brought into Norfolk no less than 86,000 stores, and at least two-thirds of those came from Ireland."

Mr. C. S. Read, M.P., on summer and winter stock of Norfolk.

The figures on the map are given for every 100 acres cultivated; but the stock are not precisely upon the cultivated acres, seeing that districts of moorland and mountain graze many cattle as well as sheep upon their uninclosed area; so that Wales, for example, shows a high stocking of both cattle and sheep in proportion to cultivated area, not because that area is specially well stocked, but because the animals upon the hills are included in the returns. But, remembering this unavoidable disturbing element in the comparison between the stocking of some, but not of all counties, the facts appear as follows:— For every hundred acres cultivated there are in summer 25 cattle and above, in Westmoreland, Lancashire, North Wales, Cheshire, Derbyshire, Leicestershire and Cornwall. There are 15 and under 25 cattle per 100 acres cultivated in Cumberland, the North and West Ridings of Yorkshire, Nottinghamshire, Shropshire, Staffordshire, Herefordshire, South Wales, Monmouthshire, Gloucestershire, Somersetshire, Devonshire, Dorsetshire, Warwickshire, Buckinghamshire, Middlesex, Northampton-

Density of " summer stocking in proportion to cultivated area.

Cattle.



shire, and Rutland. There are 10 and under 15 cattle per 100 acres cultivated in Northumberland, Durham, the East Riding of Yorkshire, Lincolnshire, Huntingdonshire, Bedfordshire, Surrey, Sussex, Wiltshire, Oxfordshire, and Worcestershire. There are under 10 per 100 acres in Cambridgeshire, Norfolk, Suffolk, Essex, Hertfordshire, Kent, and Hampshire. The highest number of cattle is  $30\frac{1}{2}$  for every 100 acres in Cheshire and in Lancashire; and the lowest 8 to  $8\frac{1}{2}$  in Suffolk and Hampshire. The sheep stocking is thus: flocks of 100 and more for every 100 acres cultivated, are an average in Northumberland, Lincolnshire, Cambridgeshire, Rutland, Kent, Dorsetshire, and North and South Wales. There are between 75 and 100 sheep per 100 acres cultivated in Cumberland, the North Riding of Yorkshire, Leicestershire, Northamptonshire, Warwickshire, Herefordshire, Monmouthshire, Oxfordshire, Berkshire, Sussex, Hampshire, Wiltshire, Somersetshire, Devonshire, and Cornwall. There are between 50 and 75 sheep per 100 acres cultivated in the West and East Ridings of Yorkshire, Nottinghamshire, Norfolk, Suffolk, Huntingdonshire, Bedfordshire, Buckinghamshire, Gloucestershire, Worcestershire, and Shropshire. And there are fewer than 50 sheep per 100 acres cultivated in Lancashire, Cheshire, Derbyshire, Staffordshire, Essex, Middlesex and Surrey. The highest stocking of sheep in English counties is 138 per 100 acres in Westmoreland (which some Welsh counties very much exceed), and the lowest is  $20\frac{1}{2}$  in Cheshire.

Sheep.

Horses.

Horses used in agriculture, unbroken horses, and mares used solely for breeding, are in more uniform numbers. There are 5 and more for every 100 acres cultivated, in the East Riding of Yorkshire, Cambridgeshire, Norfolk, Suffolk, Essex, Middlesex, and Cornwall. There are 4 and less than 5 per 100 acres in Durham, Lancashire, North and West Ridings of Yorkshire, Lincolnshire, Nottinghamshire, Derbyshire, Cheshire, Shropshire, North and South Wales, Herefordshire, Monmouthshire, Worcestershire, Warwickshire, Oxfordshire, Berkshire, Buckinghamshire, Hertfordshire, Bedfordshire, Huntingdonshire, Kent, Surrey, Sussex, Hampshire, and Devonshire. There are  $3\frac{1}{2}$  and less than 4 per 100 acres in Cumberland, Staffordshire, Leicestershire, Rutland, Northamptonshire, Gloucestershire, and Somersetshire. And there are fewer than  $3\frac{1}{2}$  per 100 acres in Northumberland, Wiltshire, and Dorsetshire. The greatest strength of teams, in proportion to arable and pasture together, is  $5\frac{1}{2}$  to  $5\frac{3}{4}$  per 100 acres in Cumberland, Cambridgeshire, Norfolk, Suffolk, and the East Riding of Yorkshire; being mainly due to the excessive quantity of arable in proportion to the grass; and the lowest numbers of horses are  $2\frac{3}{4}$  and 3 per 100 acres of cultivated land in Northumberland and Wiltshire.



The comparative high stocking of the kingdom, appears from the following statistics of the number of animals per 100 acres cultivated in different countries, as calculated from the facts given in the Agricultural Returns of the Board of Trade. The second, third, and fourth columns show the number of cattle, sheep, and horses (not only agricultural horses, but horses of all kinds, as estimated) for every 100 acres of cultivated area. But as the proportion of animals kept depends to a considerable extent upon the amount of uninclosed country, waste, or forest, which is available for stocking, I have given in the first column the proportion which the cultivated area bears to the whole extent of land, exclusive of lakes and rivers.

Head of live-stock compared with that of foreign countries.

NUMBER of ANIMALS per 100 ACRES CULTIVATED in different COUNTRIES.

Country.	Percentage of Total Area, which is Cultivated.	Cattle, per 100 Acres Cultivated.	Sheep, per 100 Acres Cultivated.	Horses of all kinds, per 100 Acres Cultivated.
England .. .. .	76	16.8	75.5	4.4
Wales .. .. .	57	23.6	105.6	4.7
Scotland .. .. .	23	24.4	150.7	4.1
Great Britain .. ..	56	18.5	89.3	4.4
Ireland .. .. .	77	26.2	25.5	3.0
United Kingdom ..	62	21.1	68.0	4.0
Holland .. .. .	63	29.4	18.7	5.0
Denmark .. .. .	68	21.0	31.3	5.3
Belgium .. .. .	66	25.5	12.0	5.8
Bavaria .. .. .	61	26.9	11.8	3.1
Sweden .. .. .	11½	18.1	13.5	3.8
Prussia .. .. .	49	20.5	46.7	5.4

It will be seen that England has under cultivation a much greater proportion of its whole superficies of land than any country in Europe; that while Wales has a large percentage of area uninclosed, and Scotland far more, so that only 23 per cent. of its area is cultivated, Ireland has 77 per cent., or a slightly larger proportion than England has of area under cultivation; the result being that the United Kingdom has under arable and pasture 62 per cent. of its total area of land, which is about the same as in Holland and Bavaria (if the official figures for those countries may be relied on), somewhat less than in Belgium and Denmark, and much greater than in Prussia. Thus, in proportion to the total area of land, as well as in proportion to the area under crops and grass, we have in the United Kingdom as many cattle as Denmark, and twice as many sheep; fewer cattle than Bavaria, but six times as many sheep; and

fewer cattle than Holland, but nearly four times the number of sheep. Belgium has more cattle than we have, but only one-fifth of the sheep in proportion to cultivated area. The horse stock in Holland and Denmark exceeds ours. But an excess of horses used in agriculture detracts from the produce available as food; and, area for area, England raises more animals for the butcher than any Continental country.

Consumption  
of oilcake.

In connection with this high stocking of the farms of the United Kingdom may be taken the fact, that in the year 1876 we imported 190,225 tons of oilcake, and 1,998,130 quarters of linseed, all but a portion of it undoubtedly used for feeding purposes, either as linseed or when made into cakes, and equivalent, at about 14 tons of cake per 100 quarters of seed, to about 280,000 tons of oilcake. The linseed and oilcakes together were equivalent to a year's consumption of about 470,000 tons, or one ton on every 100 acres of land under cultivation.

Imports of corn  
for feeding.

The imports of maize amounted to 39,958,000 cwts., valued at 12,744,000*l.*; of barley, 9,770,000 cwts.; of oats, 11,204,000 cwts.; of peas, 1,609,900 cwts.; and of beans, 4,601,000 cwts.; these grains mainly imported for feeding purposes, with the exception of a portion of the barley used for brewing and distilling, being valued at 10,920,000*l.*

Imports of  
artificial  
manure.

The manures imported in the same year included 211,000 tons of guano, less 53,000 tons exported; 165,000 tons of nitrate of soda; a large proportion of the 4200 tons of bones, burnt or not, or as animal charcoal and phosphates, and other materials for the manure-makers not enumerated. But the artificial manures applied are principally manufactured in this country.

---

## CHAPTER II.

### PRICES OF AGRICULTURAL PRODUCTS.

Corn Returns.

*Corn.*—A standing complaint of British farmers is brought against the Corn Returns, or the system by which the average prices per imperial quarter of British wheat, barley, and oats are ascertained and declared for the purpose of computing the annual amount of tithe rentcharge, which is based upon the average of those prices for the year. The quantities of these different grains sold, and the prices realised in 150 selected markets, according to weekly returns received by the inspectors and officers of Excise, under the Act of 27 and 28 Vict., cap. 87, are not believed to constitute a fair test of the amount of produce grown, or of the prices actually made by the growers. Probably a considerable proportion of the corn sold in the sample markets is not entered in the returns by the millers and merchants; many

of the sales returned are undoubtedly transactions between factors and merchants or millers, representing therefore higher figures than have been paid to growers; and the total quantities returned as sold in each year do not precisely correspond with the known abundance or deficiency in the yield of that year. Another disturbing element is the diversity of weights and measures in vogue; and another, the difference between nominal and actual quantity, which has been introduced by the weights at which corn is carried on the railways—on both of which subjects I shall have statements to make under the head “Methods of Commercial Transactions.” For comparison of one year’s quotations with another, the corn returns are probably within near limits of the truth; they are, at any rate, officially collected, calculated, and published by Government authority, and are based upon recorded sales, approaching 2,600,000 quarters of wheat per annum, or nearly one-fourth of the home-crop really sent to market.

For sixteen years the prices have ranged as follows:—

AVERAGE PRICES OF BRITISH WHEAT, BARLEY, and OATS, per IMPERIAL QUARTER, in 150 TOWNS, in each of the SIXTEEN YEARS 1861–76. Average prices of grain.

Year.	Wheat.	Barley.	Oats.	Year.	Wheat.	Barley.	Oats.
	<i>s. d.</i>	<i>s. d.</i>	<i>s. d.</i>		<i>s. d.</i>	<i>s. d.</i>	<i>s. d.</i>
1861	55 4	36 1	23 9	1869	48 2	39 5	26 0
1862	55 5	35 1	22 7	1870	46 10	34 7	22 10
1863	44 9	33 11	21 2	1871	56 10	36 2	25 2
1864	40 2	29 11	20 1	1872	57 0	37 4	23 2
1865	41 10	29 9	21 10	1873	58 8	40 5	25 5
1866	49 11	37 5	24 7	1874	55 9	44 11	28 10
1867	64 6	40 0	26 1	1875	45 2	38 5	28 8
1868	63 9	43 0	28 1	1876	46 2	35 2	26 3

One feature in the corn-trade seems to be the preponderating influence of the supply and demand of the moment; so that a flush of imports at one particular season, or a hurry of home-grown grain to market during a few exceptional weeks of farmers’ necessities, appears to govern the movement of prices more powerfully than any great-scale consideration of the year’s wants and the whole world’s probable supply. It is highly important, therefore, in connection with the matter of prices, to look at the annual consumption, and home and foreign supply of bread-corn for the United Kingdom.

For convenience I have collected into tables the statistics which tell us what the United Kingdom wants in bread-corn and flour, and what proportions of the total supply depend upon the home harvest and upon imports respectively. In the first Table, the first column names eleven harvest years (that is, periods of Estimating the home production of wheat.

twelve months from September 1st in one year to August 31st in the next) in which the Board of Trade have obtained "Agricultural Returns." The second column states the number of acres under wheat in the United Kingdom, including the islands in each year. Whether absolutely correct or not (and we are sure that a portion must be guess-work, owing to the number of occupiers who decline giving the Government any information), these official figures may be taken as furnishing a tolerably sound comparison between one year and another; and from the way in which enumerators go to work in filling up the blanks made by defaulting occupiers, probably the statistics of acreage under different kinds of crops are more exact than the figures professing to give the numbers of different kinds of live-stock. The "assumed yield per acre" in column three is deduced from the inquiry made a few years ago, and already alluded to, embracing estimates from practical farmers in the Poor-law Unions, forty or fifty per county, as to what constitutes "an average crop;" and additions or subtractions are made upon the standard average of  $29\frac{1}{2}$  bushels per acre, according to the "character" of each year's crop. The estimates of excess or deficiency were, of course, obtained from elaborate information collected in each year. Multiplying the ascertained acreage by the assumed yield per acre, we get the probable total home production in each year; and making an allowance for seed of nearly  $2\frac{1}{4}$  bushels upon the next year's acreage, we arrive at the probable nett produce available for consumption or export.

## ESTIMATED WHEAT PRODUCTION of the UNITED KINGDOM.

Home crop of wheat in different years.

Year.	Acres.	Assumed Yield per Acre in Bushels.	Available for Consumption, after deducting Seed. In Quarters.
1866	3,661,000	Under average .. .. bush. 27	11,440,000
1867	3,640,000	Much under .. .. 25	10,390,000
1868	3,951,000	Much over average .. .. 34	15,790,000
1869	3,982,000	Under average .. .. 27	12,490,000
1870	3,773,000	Over average .. .. 32	14,100,000
1871	3,831,000	Under average .. .. 27	11,970,000
1872	3,840,000	Much under average .. .. 23	10,110,000
1873	3,670,000	Much under .. .. 25	10,550,000
1874	3,833,000	Over average .. .. 31	13,700,000
1875	3,514,000	Much under average .. .. 23	9,124,000
1876	3,124,000	Under average .. .. 27	9,665,000
Average of } 11 Years	3,712,000	Mean of 11 Years .. $27\frac{1}{2}$	11,757,000
Standard } Produce	3,712,000	$29\frac{1}{2}$ bushels per Acre.	12,644,000

From the Trade and Navigation Accounts we find what were the imports of wheat and wheat flour available for consumption after deducting the exports. These, in round numbers, are given in my second Table, in the third column. Then, adding columns two and three together, we have the probable total quantity of wheat and flour available for consumption in the United Kingdom in each year. In the last column I have stated the average price of British wheat in 150 market towns in a period of twelve months, extending from July 1st to June 30th, that is, from just before harvest in one year to the same time in the year following.

Total home and foreign supply.

ESTIMATED CONSUMPTION and HOME and FOREIGN SUPPLY of WHEAT for the UNITED KINGDOM.

Harvest Year, September 1, to August 31.	Home Produce available for Consumption in Quarters.	Imports of Wheat and Flour, deducting Exports in Quarters.	Total available for Consumption in Quarters.	Average Price of British Wheat for 12 Months, July 1 to June 30.
				s. d.
1866-7	11,440,000	7,600,000	19,040,000	58 0
1867-8	10,390,000	9,010,000	19,400,000	69 3
1868-9	15,790,000	7,880,000	23,670,000	51 8
1869-70	12,490,000	9,580,000	22,070,000	45 11
1870-1	14,100,000	7,950,000	22,050,000	53 5
1871-2	11,970,000	9,320,000	21,290,000	55 3
1872-3	10,110,000	11,720,000	21,830,000	57 1
1873-4	10,550,000	11,230,000	21,780,000	61 3
1874-5	13,700,000	11,640,000	25,340,000	46 4
1875-6	9,124,000	13,940,000	23,064,000	46 3
1876-7	9,665,000	12,150,000	21,815,000	55 3
Mean of 11 } Years .. }	11,757,000	10,183,000	21,940,000	54 6

It will be seen that on an average of eleven years, the annual breadth of land under wheat has been 3,712,000 acres; and the yields "under average" have been more numerous than the yields "over average," so that in the last eleven years the crop has averaged  $27\frac{1}{2}$  instead of  $29\frac{1}{2}$  bushels per acre. Our standard average wheat crop, after deduction made for seed, is 12,664,000 quarters; but the average of the last ten years has not been more than 11,757,000 quarters. The average importation (less exports) for the last ten years has been about 10,183,000 quarters; but for the last few years we have imported about  $1\frac{1}{2}$  to  $2\frac{1}{2}$  million quarters a year more than the average, the maximum of 14,081,175 quarters of wheat and wheat-flour, not deducting exports, having been attained in the harvest year ended August 31st, 1876.

The estimated total consumption averages 21,940,000 quarters;



and allowing for increased population, and also for an advance in the quantity of wheaten bread displacing lower qualities of food, we may set down the prospective yearly consumption at 22,500,000 up to 23,500,000 quarters—varying according to the high or low range of prices. For though the consumption of bread is probably more uniform than that of any other article, still it must vary to some extent, according to its cheapness or dearness, and the money position of the industrial population who eat most of it; and besides, there is also a considerable use of wheat for feeding animals in years like the last, when wheat happens to be exceptionally cheap.

Fluctuations  
in the supply.

Reproducing here what I have written elsewhere, I may point to the circumstance that in the first two years of the series the total supply ran rather short. The immense harvest of 1868, being met by only a small importation, gave about 2,000,000 quarters more than the usual consumption required; and as the total supply in the next year just equalled that year's consumption, the balance of 2,000,000 remained over towards feeding the wants of the harvest year 1870–71. Again, the great home harvest of 1870, met by only a small importation, gave a total supply equal to the consumption; so that there was still a surplus of about 2,000,000 quarters left over toward the consumption of the harvest year 1871–72. Now, in that year, a deficient harvest, with a moderately large importation, yielded a total supply which fell short of the consumption; a still worse home crop in 1872, amounting to only 10,110,000 quarters, was met by a very large importation, namely, 11,720,000 quarters, but still fell short of a full consumption; and another home harvest nearly as bad in 1873, though supplemented by an importation of 11,230,000 quarters, did not provide up to a full consumption. So that the whole surplus supply of 2,000,000 quarters must have been all swallowed up; and, moreover, it is impossible that there could have remained at the close of the harvest year 1873–74 a balance of any moment toward the supply of the year 1874–75. What happened in that year? Providence blessed us with a magnificent yield, amounting to 13,700,000 quarters; but, what we have never experienced before, this was accompanied by a large importation; indeed, the then unprecedented quantity of 11,640,000 quarters—making together a total supply of 25,340,000 quarters—the biggest known up to that time, and 2,000,000 or 3,000,000 quarters more than the consumption required. The causes of this immense importation were, the exceptionally good harvests in the principal corn-exporting countries, and the extra growth of wheat and extra shipments of wheat stimulated and enticed by four year's progressive rise in prices in this country. As will be seen on

Supplies and  
prices.



reference to the last column of the Table, the average price rose from 45s. 11d. in 1869-70 to 53s. 5d. in 1870-71, 55s. 3d. in 1871-72, 57s. 1d. in 1872-73, and 61s. 3d. in 1873-74, and this in spite of a great importation both in 1872-73 and in 1873-74.

The surplus of that year's enormous supply (stored up in our granaries and mills under our free commercial system, which imposes no customs duty on imported food) was not so much as 2,000,000 to 3,000,000 quarters, because the drop in price from 61s. 3d. down to 46s. 4d., which was the average for the year 1874-75, induced not only an augmented consumption of bread, but a very large appropriation of wheat for feeding animals. Taking these points into consideration, it does not appear probable that more than 1,500,000 quarters remained over from the supply of that year toward the consumption of 1875-76.

The home growth for 1875-76, I estimated at only 9,124,000 quarters available for consumption. Unfortunately, the harvest yielded not only a wretched quantity per acre, but a quality so generally inferior that we had a much larger proportion of tail corn than usual; intimating that, in the absence of a handsome rise in price, an exceptionally great quantity of inferior wheat was ground for feeding animals.

An importation far greater than even the immense arrivals of 1874-75 was required; and it came to the extent of about 13,940,000 quarters, when the exports were deducted, though the price kept down at about 46s. per quarter. Nevertheless, in spite of this, the total supply barely reached the average quantity; and little surplus can have remained over toward the supply of the year 1876-77. Then, a harvest in 1876, somewhat below an average, left another vast importation a necessity; but it did not follow that, because an average price of 46s. 3d. had been sufficient to attract to our shores the unprecedented imports of 1875-76 which foreign countries spared out of their superabundance, would again be a sufficient inducement for shipments of a like bulk. The average has risen to 55s. 3d. per quarter from September 1876, to June 1877; and yet the total arrivals (less exports) have scarcely exceeded 12,000,000 quarters, leaving the total supply for the year ending August 1877, a million quarters below the average consumption. The prospects for the next year are opening with a home crop of variable yield, late harvested, and threatening to thrash out one-fifth below an average, and necessitating an importation in 1877-78 approaching 13,000,000 quarters. The price must be just what is enough to draw the requisite cargoes from other countries; this, of course, depending upon many conditions beside the character of the harvest in foreign lands.

Of barley, the standard average yield per acre, as estimated Home production of barley.

from the returns I collected a few years ago, is 37 bushels, the total produce of the United Kingdom amounting to 11,668,000 quarters (without deducting for seed), grown upon an average area of 2,523,000 acres. One-half of this quantity is produced by fourteen English counties, as stated in the annexed Table, while over one-fourth is grown by the four counties—Yorkshire, Norfolk, Lincolnshire, and Essex.

	Acres. Average of Five Years.	Yield per Acre in an Average Season.	Average Production in Imperial Quarters.
		Bushels.	
Yorkshire .. .. .	187,000	39	911,000
Norfolk .. .. .	188,000	36½	857,000
Lincolnshire .. .. .	146,000	39½	717,000
Essex .. .. .	101,000	39½	498,000
Total in the four Counties ..	622,000	..	2,983,000
Suffolk .. .. .	132,000	36	594,000
Devonshire .. .. .	82,000	30	307,000
Wiltshire .. .. .	63,000	37	300,000
Hampshire .. .. .	63,000	36½	287,000
Cambridgeshire .. .. .	55,000	39½	271,000
Oxfordshire .. .. .	51,000	39½	251,000
Northamptonshire .. .. .	52,000	38½	250,000
Nottinghamshire .. .. .	47,000	41	250,000
Cornwall .. .. .	52,000	32	208,000
Kent .. .. .	41,000	40	205,000
Total in the fourteen Counties	1,262,000	..	5,696,000
In the remaining twenty-six counties ..	624,000	..	3,001,000
England .. .. .	1,886,000	37	8,697,000
Wales .. .. .	162,000	37	749,000
Scotland .. .. .	239,000	37	1,105,000
Ireland .. .. .	219,000	37	1,012,000
United Kingdom and Islands .. ..	2,523,000	37	11,668,000

In estimating the probable barley yield it is necessary to determine what this grain will be required for; as in some seasons the proportion of good malting barley to tail will be, perhaps, as low as 1 per cent. of the latter, in which case the grain is usually first-rate; or it may extend to as high as 15 per cent., and then the crop is always indifferent.

Barley imports  
and prices.

The quantity of barley imported in 1875 was 3,094,000 quarters, and in 1876 it was 2,736,000 quarters; so that we import only about one-sixth to one-fifth of an average total supply; and the price therefore depends chiefly upon the quantity and quality of the home crop;—a condition of the market which does not

apply to wheat. The average price, as given in the Corn Returns, was, for 1876, 35s. 2d. per quarter; for 1875, 38s. 5d., and for 1874, 44s. 11d. per quarter.

*Meat.*—The statistics of the London Christmas market for thirty-six years indicates the advance which has taken place in the price of meat. Advance in the price of meat.

Year.	Beasts.	Price per Stone of 8 lbs.		Year.	Beasts.	Price per Stone of 8 lbs.		London Christmas market for thirty-seven years.	
		s.	d.			s.	d.		
1841	4,500	3	8 to 5	0	1860	7,860	3	4 ,, 5	6
1842	4,541	3	4 ,, 4	8	1861	8,840	3	4 ,, 5	0
1843	4,510	4	8 ,, 4	4	1862	8,430	3	4 ,, 5	0
1844	5,713	4	0 ,, 4	6	1863	10,372	3	6 ,, 5	2
1845	5,326	3	6 ,, 4	8	1864	7,130	3	8 ,, 5	8
1846	4,570	4	0 ,, 5	8	1865	7,530	3	4 ,, 5	4
1847	4,282	3	4 ,, 4	8	1866	7,340	3	8 ,, 5	6
1848	5,942	3	4 ,, 4	8	1867	8,110	3	4 ,, 5	0
1849	5,765	3	4 ,, 4	0	1868	5,320	3	4 ,, 5	8
1850	6,341	3	0 ,, 3	10	1869	6,728	3	6 ,, 6	2
1851	6,103	2	8 ,, 4	2	1870	6,425	3	6 ,, 6	2
1852	6,271	2	8 ,, 4	0	1871	6,320	3	10 ,, 6	2
1853	7,037	3	2 ,, 4	10	1872	7,560	4	6 ,, 6	0
1854	6,181	3	6 ,, 5	4	1873	6,170	4	4 ,, 6	6
1855	7,000	3	8 ,, 4	2	1874	6,570	4	4 ,, 6	8
1856	6,748	3	4 ,, 5	0	1875	7,660	4	4 ,, 6	6
1857	6,856	3	4 ,, 4	8	1876	7,020	4	4 ,, 6	4
1858	6,424	3	4 ,, 5	0	1877	7,510	4	6 ,, 6	2
1859	7,560	3	6 to 5	4					

But the advance in prices is greater than appears from this statement of quotations for choice Christmas animals. In the principal British markets in summer for twenty-six years, the current rates were:— Summer prices of meat for twenty-six years.

Year.	Beef. Per lb.	Mutton. Per lb.	Year.	Beef. Per lb.	Mutton. Per lb.
1849	d. 4½	d. 5	1864	d. 6¼	d. 6¾
1851	d. 4¾	d. 5	1868	d. 7	d. 7½
1855	d. 6¾	d. 6¾	1871	d. 8	d. 8½
1859	d. 6	d. 6½	1875	d. 8¾	d. 9

These are the estimated average prices paid to the feeder or his representative for the live animal.

The wholesale price by the carcass of prime beef and mutton in the Metropolitan Meat Market per stone of 8 lbs., has increased, as in the following comparison made by Sir H. S.

Thompson in 1864, and completed by Mr. James Howard in 1876:—

Advance of prices in the Metropolitan market.

WHOLESALE PRICE OF PRIME MEAT PER STONE OF 8 lbs. in the METROPOLITAN MARKET in the UNDERMENTIONED PERIODS.

Kind of Meat by the Carcass.	Average Price for 5 Years ending 1853.		Average Price for 5 Years ending 1863.		Increase in 10 Years.		Average Price for 5 Years ending 1873.		Increase in 20 Years.		Average Price for 1874 and 1875.		Increase in 22 Years.	
	s.	d.	s.	d.	Price. d.	Per cent.	s.	d.	Price. d.	Per cent.	s.	d.	Price. d.	Per cent.
Beef.. ..	4	2½	5	0½	10	20	5	6½	16	32	5	8½	18	35½
Mutton ..	4	5	5	9	16	30	6	4	23	43	6	5	24	45

In a Paper read before the London Farmers' Club last year, Mr Howard observed upon this statement, that between 1853 and 1863, an advance of 20 per cent. took place, in the Metropolitan Market, in the price of prime beef in the carcass, and as much as 30 per cent. in mutton. In the following ten years, viz., to 1873, the total advance was 32 per cent. in beef, and 42 per cent. in mutton. The prices in 1875 were, again, higher than in 1873; beef having advanced ½*d.* and mutton ¾*d.* per lb. and he adduced the following in corroboration:—"From the examination of the books of a large country butcher, placed at my disposal, I find that during the past twenty-five years the retail price of meat has increased 4*d.* to 5*d.* per lb., and, singularly enough, it has risen by gradual steps. At the end of each five years the advance has been just about 1*d.* per lb. Of course, during this long period there have been occasional checks to this upward tendency, but these have invariably been of short duration. I may say that, from inquiries I have made, the advances in London butchers' prices correspond closely to those I have named."

Mr. James Howard on the advance in price.

Estimating the home production of meat.

In evidence before the Select Committee of the House of Commons on Contagious Diseases of Animals, in 1873, I gave an estimate of the Annual Home Production of Meat; and, by inquiries subsequently made respecting the ages at which animals are killed, and their average dead-weights, I have been enabled to confirm, while to some extent correcting, that estimate of what the United Kingdom annually raises in beef, mutton, veal, lamb, and pork.

Taking the Board of Trade Census of cattle and sheep as a basis for calculation (though it probably falls below the actual numbers, owing to the large proportion of stockowners who decline to fill up returns, and whose herds and flocks have therefore to be guessed at by the enumerators), we have the number of breeding cows and heifers described as "in milk or

in calf," the number of calves and young cattle "under two years of age," and the number of other cattle "two years of age and above," as found in the United Kingdom on June 25th. How many veal calves, and how many fatted cattle, and drafted cows and heifers, and bulls, does our great herd yield annually for the butcher? And what are average weights per carcass, by which to estimate the total weight of beef and veal? Again, what proportion of the total number of sheep and lambs enumerated on June 25th is annually converted into mutton, what number of lambs are killed, and what is the average weight per carcass for mutton and for lamb? To answer these questions requires information of an elaborate character upon which to build general estimates; and it is a difficult problem, not an easy computation, to deduce from the figures taken on one particular date in the year what are the proportions of different classes of animals annually killed.

In the Returns, there are 100 cows and heifers in calf or in milk in every 251 of the total herd, but only 48 calves for each 100 dams; and this is a puzzling feature of the Census until a scheme is constructed in conformity with, and therefore verified by the number of cattle of different ages found existing in June. This can be done by allowing for the greater proportion of heifers added to the breeding stock, the greater number of calves dropped, and the greater number of dams drafted for fattening, in some seasons of the year than in others. The assumed hypothesis on the several points was confirmed by the information and opinions obtained from a large number of breeders in many different counties; and the same was the case with respect to the rates of mortality at different ages, and the proportion of cattle killed at different ages.

Among the probably sound *data* thus obtained, for calculating our home production of meat from the numbers of animals found at the Census in June, are the following:—Of every 100 cows and heifers 38½ per cent. calve in the first quarter of the year; 37½ per cent. calve in the second quarter; 10½ per cent. in the third quarter; and 13½ per cent. in the fourth quarter of the year; 100 cows give 80 calvings in a year; they are drafted for the butcher after four calvings, or five years of breeding; and their mortality is 8 per cent. per year.

Data for calculating the number of cattle killed.

The average mortality of calves in their first year is 11 per cent.; 16 per cent. of the total drop of calves are killed for veal, and the average age of veal calves when killed is two months. Of cattle killed, not including drafted cows, 50 per cent. are two to three years old, 42 per cent. are three to four years old, and 8 per cent., including bulls, are older.

The results of the whole calculation, which need not be given



in detail here, appear in the subjoined Tables, which I quote from numbers of the 'Chamber of Agriculture Journal and Farmer's Chronicle,' for October, 1875.

This scheme accounts for the number of dams enumerated at the Census in June, the number of young animals enumerated as "one year old and under two years" (as in the Irish Census), the number enumerated as "under two years old," and the number of cattle enumerated as "two years old and above;" and no calculation very different from this will fit the facts as revealed in the Board of Trade Returns. The result brought out is that, of our home stock in the United Kingdom, we annually kill for meat 436,400 veal calves, 528,300 draft cows and heifers, and 970,600 other cattle and bulls.

Number of calves and cattle killed.

Estimated average dead-weights of cattle.

From the opinions collected from breeders and graziers of many different varieties of cattle in England and Scotland, and from other inquiries made by Mr. C. S. Read, M.P., I average the dead-weight of veal calves at 8 imperial stones, of cattle two to three years old at 40 imperial stones per head; cattle three to four years old, 54 imperial stones per head; older cattle and bulls, 64 stoncs; and draft cows, 50 stoncs per head.

Number and weights of sheep and lambs killed.

From the information collected with regard to sheep, I conclude that of the total fall of lambs 18 per cent. are killed for "lamb," at the average age of fifteen weeks, with an average dead-weight of 3 imperial stoncs; that the average age of sheep (excepting drafted ewes), when killed, is 21 months, and of ewes  $5\frac{1}{2}$  years; and that the average dead-weight of sheep, of all breeds and ages (except lambs) is  $5\frac{1}{2}$  imperial stoncs per head. Of the 18 per cent. of lambs killed, 13 are probably killed before the census, leaving only 5 per cent. to be enumerated in the June returns. Allowing for mortality, which in breeding flocks is very heavy, and for the enumeration of ewes five times, and of other sheep, including rams, twice, the result comes out that, for 33,000,000 sheep and lambs, of which about one-third are lambs, enumerated in June, there are annually killed about 2,000,000 lambs, and about 7,000,000 sheep.

Number and weight of pigs killed.

The probable, though very uncertain, yearly produce from pigs, I vary from a calculation of Sir H. S. Thompson and Mr. James Howard;—namely, 3,000,000 sucking pigs and porkers, averaging 5 imperial stoncs dead-weight, at 5 months old, and 1,800,000 bacon pigs averaging 20 stoncs at  $1\frac{1}{4}$  years old. The estimated total home supply of meat appears, then, in the Table on p. 39.

Total home supply of meat.

Foreign animals imported.

The foreign supply is known, as far so numbers of animals and weights of dead meat are concerned, from the Trade and Navigation Accounts. Of the imported live animals no record is kept of the proportion killed soon after arrival, and the



NUMBER OF COWS and HEIFERS in the UNITED KINGDOM and the NUMBER ANNUALLY DRAFTED for MEAT.

Enumerated at each Census, Mortality 8 per Cent. per Year deducted.	Dams Calving in the First Quarter of the Year.	Dams Calving in the Second Quarter.	Dams Calving in the Third Quarter.	Dams Calving in the Fourth Quarter.	Dams enumerated at the Census on June 25th.	Number of Drafted Cows killed for Meat before the Census. Mortality at the Rate of 8 per Cent. per Year deducted.	Number of Drafted Cows enumerated as "Two Years old and above." Mortality at the Rate of 8 per Cent. per Year deducted.	Total Number of Drafted Cows for Meat.
Enumerated the first year	290,000	325,000	90,000	102,000	807,000	..	..	..
Ditto, second year	265,000	299,000	83,000	93,500	740,500	..	..	..
Ditto, third year	244,000	276,000	77,500	86,000	683,500	..	..	..
Ditto, fourth year	225,500	254,500	72,000	79,000	631,000	..	..	..
Ditto, fifth year	208,000	233,000	66,000	72,000	579,000	279,700	..	..
Ditto, sixth year	192,000	None	None	67,000	259,000	184,300	64,300	..
Total .. ..	1,424,500	1,387,500	388,500	499,500	3,700,000	464,000	64,300	528,300

## NUMBER OF CALVES DROPPED per YEAR, and NUMBER probably KILLED for VEAL.

Cows and Heifers In-Milk or In-Calf, enumerated on June 25th.	Number of Calvings per Year, 20 per Cent. less than the Number of Dams.	Number of Live Calves dropped, 24 per Cent. less than the Number of Dams.	Number of Live Calves at Two Months Old. Mortality at the Rate of 3 per Cent. for Two Months deducted.	Number of Calves killed for Veal, 16 per Cent. at the Average Age of Two Months.	Number of Veal Calves killed before the Census on June 25th.	Number of Veal Calves enumerated on June 25th.	Total Number of Calves enumerated at the Census as "under One Year Old." Mortality at the Rate of 8 per Cent. for Ten Months (11 per Cent. per Year) deducted.
Dams calving in the first quarter of the year, 38½ per cent. of the whole, or, 1,424,500	1,139,600	1,082,600	1,050,100	168,000	168,000	None	820,000
Dams calving in the second quarter, 37½ per cent., or, 1,387,500	1,110,000	1,054,500	1,022,900	163,700	103,700	60,000	880,000
Dams calving in the third quarter, 10½ per cent., or, 388,500	310,800	295,300	286,400	45,800	45,800	None	210,000
Dams calving in the fourth quarter, 13½ per cent., or, 499,500	399,600	379,600	368,200	58,900	58,900	None	280,000
Total 3,700,000	2,960,000	2,812,000	2,727,600	436,400	376,400	60,000	2,190,000

NUMBER OF YOUNG CATTLE ENUMERATED AT THE CENSUS AS "UNDER TWO YEARS OLD."

Number of Calves enumerated as "under One Year Old."	Veal Calves enumerated.	Number of Calves for Stock, with Age at their First Census.	Number of Young Cattle at their Second Census, Mortality at the Rate of 10 per Cent. per Year deducted.	Heifer Calves added to the Herd and enumerated as "In-Calf" at their Second Census.	Number of Cattle enumerated as "One Year old and under Two Years."	Total Number of Cattle enumerated as "Under Two Years Old."
Born in First Quarter of the Year 820,000	None	820,000 3 to 6 Months old	780,000 1 $\frac{1}{4}$ to 1 $\frac{1}{2}$ Years old	80,000	700,000	1,520,000
Born in Second Quarter 880,000	60,000	820,000 0 to 3 Months old	760,000 1 to 1 $\frac{1}{4}$ Years old	None	760,000	1,640,000
Born in Third Quarter 210,000	None	210,000 9 to 12 Months old	190,000 1 $\frac{1}{4}$ to 2 Years old	90,000	100,000	310,000
Born in Fourth Quarter 280,000	None	280,000 6 to 9 Months old	260,000 1 $\frac{1}{2}$ to 1 $\frac{3}{4}$ Years old	80,600	179,400	459,400
Total 2,190,000	60,000	2,130,000 0 to 12 Months old	1,990,000 1 to 2 Years old	250,600 1 to 2 Years old	1,739,400 1 to 2 Years old	3,929,000 0 to 2 Years old

NUMBER OF CATTLE ENUMERATED AS "TWO YEARS OLD AND ABOVE," AND NUMBER AT DIFFERENT AGES PROBABLY KILLED FOR BEEF.

Number of Young Cattle, with Age at their Third Census, Mortality at the Rate of 6 per Cent. per Year deducted.	Heifers added to the Herd and enumerated as "In-Calf," at their Third Census.	Number of Young Cattle killed for Meat before their Third Census.	Young Cattle enumerated as "Two Years old and above," at their Third Census.	Number of Cattle, with Age at their Fourth Census, Mortality at the Rate of 4 per Cent. per Year deducted.	Heifers added to the Herd, and enumerated as "In-Calf" at their Fourth Census.	Number of Steers, fattening Heifers, and Bulls.	Number killed before their Fourth Census.	Number enumerated as "Two Years old and above," at their Fourth Census.
Born in the First Quarter of the Year 663,000 2 1/2 to 2 1/2 Years old	150,000	5,000 under 2 1/2 to 2 1/2 Years old	508,000	488,000 3 1/2 to 3 1/2 Years old	60,000	428,000	..	..
Born in Second Quarter 726,000 2 to 2 1/2 Years old	100,000	None under 2 to 2 1/2 Years old	626,000	601,000 3 to 3 1/2 Years old	225,000	376,000	..	..
Born in Third Quarter 94,000 2 1/2 to 3 Years old	None	10,000 under 2 1/2 to 3 Years old	84,000	81,000 3 1/2 to 4 Years old	None	87,000	..	..
Born in Fourth Quarter 170,000 2 1/2 to 2 1/2 Years old	16,400	5,600 under 2 1/2 to 2 1/2 Years old	188,000	152,000 3 1/2 to 3 1/2 Years old	5,000	141,000	..	..
1,653,000 2 to 3 Years old	266,400 under 2 to 3 Years old	20,600 under 2 to 3 Years old	1,376,000 2 to 3 Years old	1,322,000 3 to 4 Years old	290,000 under 3 to 4 Years old	1,032,000 under 3 to 4 Years old	350,000 under 3 to 4 Years old	682,000 3 to 4 Years old

Cattle enumerated as "Two Years old and above" at their Fourth Census .. .. . 682,000  
 " Killed before their Fifth Census. Under Four to Five Years old .. .. . 450,000

Number enumerated as "Two Years old and above" at their Fifth Census—Four to Five Years old. Mortality at the rate of 4 per Cent. per Year deducted .. .. . 223,000  
 Oxen and Bulls killed before their Sixth Census. Under Five to Six Years old .. .. . 100,000

Number of Oxen and Bulls enumerated as "Two Years old and above" at their Sixth Census. Mortality at the rate of 4 per Cent. per Year deducted .. .. . 118,000  
 Bulls, &c., enumerated and killed in two or more additional years .. .. . 50,000

Number of stores, fattening Cattle, Heifers, and Bulls, enumerated as "Two Years old and above" .. .. . 2,450,000  
 Number of drafted Cows as enumerated as "Two Years old and above" .. .. . 64,300

Total number of Cattle enumerated as "Two Years old and above" .. .. . 2,514,300

FIGURES OF THE NUMBER OF CATTLE ENUMERATED AS "TWO YEARS OLD AND ABOVE," AND NUMBER AT DIFFERENT AGES PROBABLY KILLED FOR BEEF, IN THE UNITED STATES, 1870-1880.

WEIGHTS OF HOME CALVES, CALVES, SHEEP, LAMBS, AND PIGS, ANNUALLY KILLED for MEAT in the UNITED KINGDOM.

ANIMALS.	Age when Killed.	Number.	Average Dead Weight per Head, in Imperial Stones.	Weight of Meat in Imperial Stones.	Weight of Meat in Tons.	Price per Ton.	Value of Meat.
						£	£
Cattle .. .. .	2 Years and under 3	20,600	40	824,000	..	..	..
Cattle .. .. .	3 Years and under 4	350,000	54	18,900,000	..	..	..
Cattle .. .. .	4 Years and under 5	450,000	64	28,800,000	..	..	..
Cattle and Bulls .. .. .	Older	150,000	64	9,600,000	..	..	..
Drapes, or drafted Cows and Heifers .. .. .	..	528,300	50	26,415,000	..	..	..
Total Beef .. .. .	..	1,498,900	..	84,539,000	..	..	..
Veal Calves .. .. .	2 Months	436,400	8	3,491,200	..	..	..
Total Beef and Veal .. .. .	..	1,935,300	..	88,030,200	550,188	70 (7½d. per lb.)	38,513,160
Sheep .. .. .	..	7,000,000	5½	38,500,000	..	..	..
Lambs .. .. .	15 Weeks	2,000,000	3	6,000,000	..	..	..
Total Mutton and Lamb .. .. .	..	9,000,000	..	44,500,000	278,125	84 (9d. per lb.)	23,362,500
Suckling Pigs and Porkers .. .. .	5 Months	3,000,000	5	15,000,000	..	..	..
Bacon Pigs .. .. .	1½ Years	1,800,000	20	36,000,000	..	..	..
Total Pork and Bacon .. .. .	..	4,800,000	..	51,000,000	318,750	65 (7d. per lb.)	20,718,750
Total Home supply of Meat .. .. .	..	..	..	..	1,147,063	..	82,594,410

proportion kept as stores or dairy stock ; but, after deduction for mortality of the few stores and of the cows, all are ultimately turned into meat ; and I here adopt the average dead weights as valued by Mr. C. S. Read, and corrected by my own inquiries. And I have, too liberally, allowed as high a price per lb. for the foreign as for home-bred animals.

Importation  
of dead meat.

Of dead meat we imported in the year, 1876,

	Cwts.
Beef, fresh or slightly salted .. .. .	170,711
Fresh pork .. .. .	26,539
Meat, principally fresh mutton .. .. .	95,400
Meat preserved otherwise than by salting .. .. .	280,859
Total Fresh Meat .. .. .	573,509
Beef, salted .. .. .	243,342
Pork salted .. .. .	350,151
Bacon .. .. .	2,809,990
Hams .. .. .	349,455
Total Salted Meat, &c. .. .. .	3,752,398
Total Dead Meat, &c. .. .. .	4,326,447

Total meat  
supply.

The Estimated Total Meat Supply of the United Kingdom, in an average of grazing seasons, and at the rate of importation of the year 1876, is therefore, as follows :—

ESTIMATED AVERAGE ANNUAL MEAT SUPPLY of the UNITED KINGDOM, with the relative PROPORTIONS furnished by HOME ANIMALS, IMPORTED LIVE ANIMALS, and IMPORTED DEAD MEAT.

	Weight in Tons.	Per Cent.
Meat from Home Animals .. .. .	1,147,063	78 $\frac{3}{4}$
Meat from Imported Live Animals	93,138	6 $\frac{1}{2}$
Imported Fresh Meat .. .. .	28,675	2
Imported Salt Meat .. .. .	187,646	13
Total Meat Supply .. .. .	1,456,522	100

But the importation of Fresh Meat has been considerably more than doubled in eleven months of the year 1877.

The population of the United Kingdom being now about 33,000,000, the average consumption of fresh and salt meat, according to this estimate, is about 7 imperial stones per head.



ESTIMATED MEAT SUPPLY FURNISHED BY IMPORTED FOREIGN LIVE ANIMALS.

Animals Imported in 1876.	Number.	Average Dead Weight per Head in Imperial Stones.	Weight of Meat in Imperial Stones.	Weight of Meat in Tons.	Price per Ton.	Value of Meat.
Oxen and Bulls .. .. .	168,958	46	7,772,068	..	£ ..	£ ..
Cows .. .. .	58,520	40	2,340,800	..	£ ..	£ ..
Calves .. .. .	44,098	7	308,686	..	£ ..	£ ..
Total Cattle .. .. .	271,576	..	10,421,554	65,134	70 (7½d. per lb.)	4,559,380
Sheep and Lambs .. .. .	1,041,494	4	4,165,976	26,099	84 (9d. per lb.)	2,192,316
Pigs .. .. .	43,558	7	304,906	1,905	65 (7d. per lb.)	123,825
Total Imported Foreign Animals	..	..	..	93,138	..	6,875,521

But undoubtedly a considerable proportion of the salted meat is exported for consumption on board ship.

Mr. J. C. Morton's estimates.

*Dairy Products.*—The total Dairy Produce of England can be only roughly estimated. In the Society's 'Journal' in 1875, Mr. John Chalmers Morton approximately summed up the milk industry of England alone, from a consideration of the probable average yield of milk per cow. In 1874 the census found in June in the English counties 1,614,477 cows or heifers in-milk or in-calf. Assuming an average yield of 420 gallons of milk annually drawn per cow, which is probably no more than is given by the average cow beyond the requirements of her calf, and considering the comparatively low production for dairy purposes of Herefordshire, Devonshire, Sussex, and some other suckling counties, the quantity of milk dealt with in English dairies is, upon the whole, not more than 650,000,000 gallons annually. Taking the average daily consumption of a mixed population at one-fifth of a pint each, or nearly 9 gallons yearly, the 21,500,000 of people in England drink, or swallow in puddings and other cookeries, nearly-one-third of this milk, leaving not more than 450,000,000 gallons for the manufacture of butter and cheese. Mr. Morton considers that the whole cheese-making of the country is from the milk of about 450,000 cows, mainly in Cheshire, Lancashire, Staffordshire, Warwickshire, Derbyshire, Leicestershire, Shropshire, Gloucestershire, Berkshire, Somersetshire, and Wiltshire; and as these cows probably yield more than an average quantity of milk, while in the cheese-districts the calf is taken away from the mother earlier than elsewhere, and that the breeds encouraged are such as give quantity rather than extreme richness of milk, it may be fairly assumed that the average yield per cow is as much as 480 gallons per annum. Of course the average of well-kept cows is much higher—some dairymen getting 600 or 700 gallons, while there are instances of cows yielding 900 and 1000 gallons each in a year, when fed purposely for giving large quantities of milk. This makes the total quantity of milk employed in cheese-making in England nearly 220,000,000 gallons; equal to the manufacture of nearly as many pounds of cheese. If the whole of the United Kingdom may be taken to make 250,000,000 lbs., or 2,232,000 cwts., this is about one-half more than the 1,540,000 cwts. imported in 1876. At an average price of 3*l.* 15*s.* per cwt., the value of the annual home product of cheese will be 8,370,000*l.*

Cheese.

Cheshire, Cheddar, and Stilton cheeses, of a quality considered close to perfection in texture, flavour, and aroma, are produced by only a small proportion of the dairies of England; and the bulk of the cheese sold at the great periodical markets is classed as

of medium or inferior quality. The prices current on the first Saturday in January 1877 from the latest market sales were—fine new Cheddar, 60s. to 94s. per cwt.; fine new Cheshire, 78s. to 90s. per cwt.; fine new Wiltshire, 74s. to 82s. per cwt.

There are no *data* available for computing the total production of butter. But it is considered by some authorities that the average yearly produce per cow, when well kept, in milk and butter, and the value of her calf, reaches from 16*l.* to 18*l.* Milk is commonly retailed in towns at 1*s.* 4*d.* per gallon, which is nearly double the price obtained by the country dairyman who supplies the town milk-vendors wholesale. The price of fresh butter commonly varies from 1*s.* to 1*s.* 6*d.* per pound; and the prices of Irish butter in January 1877 were from 120*s.* to 160*s.* per cwt., according to quality.

*Wool.*—What is the annual production of wool in England and in the United Kingdom? Statisticians on the subject believe that, within the last twenty years, a considerable change has taken place in the average weights of fleeces, partly owing to improved breeding, in all counties suitable for the heavier classes of sheep, and partly from an extension of crossing with larger breeds. And it is considered that the average varies from year to year as much as from a quarter to half a pound per fleece, according to season. Earl Cathcart, in his Paper on “Wool in Relation to Science with Practice,” in the Society’s ‘Journal’ for 1875, gave an estimate of home-grown wool, taking the weights of fleece from Messrs. J. and J. Hubbard of Bradford, and applying them to the average numbers of sheep returned for each county in 1867, 1868, and 1869.

I have now calculated and give in tabular form the figures for the average number of sheep in 1875 and 1876.

From unwashed wool a deduction of one-third is made, to arrive at the weight of clean wool; and the average weights of fleece allow for sheep being slaughtered at all times of the year—so that, on an average, their fleeces do not attain a full or mature weight.

According to this estimate, the 13,758,000 sheep in England and Wales, one-year old and upwards, produce on an average 78,976,000 lbs. of wool, the average weight of fleece being about 5¾ lbs.; and the 18,448,000 sheep in Great Britain produce 22,277,000 lbs. of wool, with a weight of fleece averaging about 5½ lbs. While the 4,690,000 sheep of Scotland yield fleeces averaging 4¾ lbs., the 3,000,000 sheep of Ireland are considered to yield fleeces averaging 6 lbs.: and the totals for the United Kingdom are 21,492,000 sheep, one-year old and upwards, yielding 119,473,000 lbs. of wool, averaging about 5½ lbs. per fleece. At a ten years’ average price of English wool,

Butter.

Earl Cathcart  
on wool.Home produc-  
tion of wool.

## ESTIMATED AVERAGE HOME PRODUCTION OF WOOL.

COUNTY.	Number of Sheep 1 Year Old and above, Average of 1875 and 1876.	Average Weight of Fleece.	Pounds of Wool.	REMARKS.
Bedfordshire . . . . .	464,000	6	2,784,000	{ Half-breds, 6 to 7 lbs. Leicesters, 7 to 8 lbs. Downs, 4 to 4½ lbs.
Berksire . . . . .				
Buckinghamshire . . . . .				
Cambridgeshire . . . . .	211,000	6	1,266,000	
Cheshire . . . . .	68,000	4	272,000	
Cornwall . . . . .	269,000	7½	2,017,000	{ Unwashed, and one-third allowed off for clean wool.
Cumberland . . . . .	357,000	5	1,785,000	
Derbysire . . . . .	160,000	5½	840,000	
Devonsire . . . . .	611,000	7½	4,582,000	{ Unwashed, one-third allowed off for clean wool.
Dorsetshire . . . . .	333,000	4½	1,581,000	{ Horns, 5½ lbs. Downs, 3½ lbs.
Durham . . . . .	136,000	4	544,000	
Essex . . . . .	257,000	5	1,285,000	{ Kents and half-breds, 5 to 6 lbs. Downs, 3 to 4 lbs.
Gloucestershire . . . . .	262,000	7	1,834,000	
Hampshire . . . . .	372,000	6	2,232,000	
Herefordshire . . . . .	210,000	5½	1,155,000	
Hertfordshire . . . . .	118,000	5	590,000	{ Half-breds, 5 to 6 lbs. Downs, 4 to 4½ lbs.
Huntingdonsire . . . . .	99,000	6½	668,000	
Kent . . . . .	650,000	6	3,900,000	
Lancashire . . . . .	199,000	5½	1,094,000	
Leicestershire . . . . .	288,000	6½	2,144,000	
Lincolnshire . . . . .	933,000	8	7,461,000	
Middlesex . . . . .	27,000	5	135,000	{ Half-breds, 5½ to 7 lbs. Downs, 4 to 4½ lbs.
Monmouthshire . . . . .	137,000	2½	342,000	
Norfolk . . . . .	402,000	4	1,608,000	{ Half-breds, 5 lbs. Downs, 3 to 4 lbs.
Northamptonshire . . . . .	337,000	6	2,022,000	
Northumberland . . . . .	573,000	6	3,438,000	
Nottinghamshire . . . . .	163,000	6½	1,018,000	
Oxfordshire . . . . .	199,000	5½	1,094,000	
Rutland . . . . .	66,000	7	462,000	
Shropshire . . . . .	296,000	5½	1,628,000	
Somersetshire . . . . .	488,000	7	3,416,000	
Staffordshire . . . . .	182,000	5½	1,048,000	
Suffolk . . . . .	264,000	4½	1,254,000	{ Half-breds, 6 lbs. Downs, 4 to 5½ lbs.
Surrey . . . . .	67,000	4	268,000	
Sussex . . . . .	362,000	4	1,448,000	
Warwickshire . . . . .	233,000	5½	1,339,000	
Westmoreland . . . . .	217,000	5	1,085,000	
Wiltshire . . . . .	440,000	3½	1,540,000	
Worcestershire . . . . .	137,000	5½	753,000	
East Riding of Yorkshire . . . . .	294,000	8½	2,499,000	
North Riding of Yorkshire . . . . .	436,000	5½	2,507,000	{ Masbam, 5 lbs. Scotch, 4 to 4½ lbs.
West Riding of Yorkshire . . . . .	441,000	5½	2,535,000	
Wales . . . . .	2,000,000	4½	9,500,000	{ General average as per Mr. Bottomley's estimate in 1870.
Total, England and Wales . . . . .	13,758,000	5½	78,976,000	
Scotland . . . . .	4,690,000	4½	22,277,000	{ General average, as per Mr. Bottomley's estimate in 1870.
Total, Great Britain . . . . .	18,448,000	5½	101,253,000	
Ireland . . . . .	3,000,000	6	18,000,000	
Isle of Man and Channel Islands . . . . .	44,000	5	220,000	
Total, United Kingdom	21,492,000	5½	119,473,000	

according to the Bradford Chamber of Commerce, of 19 $\frac{1}{4}$ d. per lb., the value of the average annual product of wool of the United Kingdom is 4,604,000*l.*

The heaviest average fleeces are in the East Riding of Yorkshire, 8 $\frac{1}{2}$  lbs.; Lincolnshire, 8 lbs.; Cornwall, 7 $\frac{1}{2}$  lbs.; Devonshire, 7 $\frac{1}{2}$  lbs.; Gloucester, 7 lbs.; Rutland, 7 lbs.; Somersetshire, 7 lbs. The lightest are in Monmouthshire, 2 $\frac{1}{2}$  lbs.; Wiltshire, 3 $\frac{1}{2}$  lbs.; Cheshire, 4 lbs.; Durham, 4 lbs.; Norfolk, 4 lbs.; Surrey, 4 lbs.; Sussex, 4 lbs. The largest county flocks of sheep, one-year old and above, are in Lincolnshire, 933,000; Kent, 650,000; Devonshire, 610,000; Northumberland, 573,000. And the greatest produce of wool comes from counties in the following order, namely, Lincolnshire, 7,464,000 lbs.; Devonshire, 4,582,000 lbs.; Kent, 3,900,000 lbs.; Northumberland, 3,438,000 lbs.; Somersetshire, 3,416,000 lbs.; West Riding of Yorkshire, 2,535,000 lbs., North Riding of Yorkshire, 2,507,000 lbs.; East Riding of Yorkshire, 2,499,000 lbs.

Weight from different counties.

Yorkshire and Lincolnshire, yielding 7,500,000 lbs. each, with Devonshire 4,500,000 lbs., produce a fourth of all the wool clipped in England and Wales; and very nearly half the wool of England and Wales is from ten counties, namely, Northumberland, Yorkshire, Lincolnshire, Leicestershire, Northamptonshire, Kent, Hampshire, Somersetshire, Devonshire, and Cornwall. More wool is clipped in Lincolnshire and Leicestershire than in all Wales; more wool in Yorkshire, Lincolnshire, and Kent than in all Ireland; and as much wool in Yorkshire, Lincolnshire, Kent, and Somersetshire as in all Scotland.

While the average home production of wool is 119,473,000 lbs., the export of British and Irish wool is about 10,000,000 lbs. per year; leaving available for home manufacture about 110,000,000 lbs. In the year 1876 the imports were from Australia, 264,000,000 lbs.; from South Africa, 42,000,000 lbs.; from Europe, 36,000,000 lbs.; from India, 24,000,000 lbs.; and from other countries, 20,000,000 lbs., making a total of 386,000,000 lbs. The exports of foreign and colonial wool amounted to 173,000,000 lbs., making the imports available for manufacture, 213,000,000 lbs. An average foreign supply during the last three years is about 200,000,000 lbs.; so that the total annual supply of wool may be taken at about 310,000,000 lbs., of which 110,000,000 lbs. are of home growth.

Imports and exports.

As to the comparative value of different wools, a Bradford authority stated the price of different descriptions of wool for the year 1872 as exhibited in the Table on p. 46. But in that year there was less difference between the value of lighter wool and that of other deep wools, as Irish and Warwick, than is usually the case.

Values of different wools.

## COMPARATIVE PRICES OF WOOL in 1872, PER TOD of 28½ lbs.

	Highest.	Lowest.	Average.
	s. d.	s.	s. d.
Lincoln, Hogg .. .. .	65 0	63	64 0
„ Wether .. .. .	60 0	58	59 0
Irish, Hogg .. .. .	26 6	26	26 3
„ Wether .. .. .	25 6	25	25 3
Stafford, Warwick, and Midland Counties pasture-wool generally—			
Hogg .. .. .	63 0	60	61 6
Wether .. .. .	59 0	57	58 0
Half-breds, Norfolk, &c.—			
„ Hogg .. .. .	..	..	59 0
„ Wether .. .. .	..	..	55 0
Downs—			
„ Hogg .. .. .	..	..	55 0
„ Wether .. .. .	..	..	49 0

*Poultry.*—It would be futile to attempt any estimate of the total production of eggs, of poultry for the table, and of feathers; though M. Leonce de Lavergne, in his ‘Rural Economy of England,’ ventured to state the annual produce of our birds (not including game) at 800,000*l.*; and Dr. Wynter, in his ‘Curiosities of Civilisation,’ enumerated 2,000,000 fowls, 350,000 ducks, 104,000 turkeys and 100,000 geese, as sold yearly in the London markets. It is true, however, that poultry-keeping and even bird-farming have very greatly extended of late years; that attention to this branch of the farmer’s business has substituted good management for neglect throughout most parts of the kingdom; and that, as a result of the still increasing taste for breeding and exhibiting the most perfect and highly developed specimens of native and imported varieties, valuable and profitable birds of pure breed, or crosses from properly matched breeds, have largely taken the place of inferior poultry which possessed no merit either as egg-layers, mothers, or table-birds. The demands of great cities for dainty diet have encouraged improvements in poultry production, till Surrey and Sussex no longer enjoy a monopoly of high prices for early chickens; Buckinghamshire, which annually raises hundreds of thousands of its milk-white Aylesbury ducks, is imitated by other counties able to supply the large centres of population in the North; Christmas turkeys and geese are grazed in flocks and fattened for the market in other parts of England besides the eastern counties; Dorking fowls, or crosses between Dorking and Brahma, or between Dorking and Cochin, are sent to market from



all parts of the country, of perhaps double the average weight of the birds killed a few years ago ; and the home egg-trade has very greatly increased, though there exist no figures by which it can be compared with the enormous importation. In the year 1876 we imported from the Continent, chiefly from France, 6,274,924 "great hundreds" of eggs, at ten dozen per hundred, amounting to no fewer than 752,990,880 eggs, or more than 2,000,000 eggs per day. The Custom-house valuation of the year's import was 2,610,231*l.*, at 8*s.* 4*d.* per ten dozen.

Ordinary prices are, for fowls, 5*s.* to 15*s.* per couple, according to size and season ; ducks, 6*s.* to 10*s.* per couple ; geese, 8*s.* to 12*s.* each ; and turkeys, 10*s.* to 16*s.* each.

---

### CHAPTER III.

#### MANAGEMENT OF CATTLE.

While under the first division of this paper I have briefly sketched the characteristic features of English husbandry, its soils, crops, and breeds of animals, I collect here the principal points of information to be given with respect to the breeding, rearing, and fattening of live-stock,—reserving, however, the subjects of dairying and summer grazing for the separate section on Pastoral and Dairy Farming.

*At what age Cattle commence Breeding.*—Practice varies much as to the precise age when heifers first begin to breed. Of course by placing them in a breeding condition at too early an age, their growth is stunted, their constitution is weakened, and the progeny are not well developed in size and stamina. The greater injury is suffered by the female. As a general rule, a bull is not used before he is a year and a half old, and a heifer is not put to the bull till she is two years old. But this rule has to be varied from. Thus, when the female is to be a milker, she is commonly allowed another half-year ; that is, her calf comes when she is between three and four years old. The reason for this is that milking by hand exhausts the cow more than suckling, a calf seldom milking its mother dry ; the maturer cow can better stand the drain, and at the same time can better nourish the foetus of her next calf. The other variation from the rule is when the animals are not to be afterwards retained for the herd. High-fed heifers may be put to the bull at under two years old ; otherwise they may probably miss breeding at all.

*The Season chosen for Calving.*—The best season of the year for calving is a very important question to English breeders, (to whom the rearing of valuable calves is of greater importance

Age when  
beginning to  
breed.

Seasons for  
calving.

than is commonly understood in the milk and butter producing countries of the Continent), although one might suppose it to be easily settled by answering, "The best time to drop a calf is just when you happen to want it." In dairy-farming, say that you want milk in quantity almost the year through, you can time your calves to fall any month, from say October through the winter and spring up to midsummer. But, apart from dairying, there are two great calving seasons, each having its advocates. As a matter of fact (deduced by a calculation referred to under another section of this Memoir), the 3,700,000 cows and heifers of the United Kingdom enumerated as in-calf on the 25th of June, represent about 807,000 heifers added to the herd in a year, drafted and fed-off after about four calvings on an average. To account for the number of calves enumerated at the Census, or killed for veal, and for the number of young cattle under two years old found at the Census, it has been found necessary to assume that these 3,700,000 dams calve in the different quarters of the year about as follows:  $38\frac{1}{2}$  per cent. in the first quarter,  $37\frac{1}{2}$  per cent. in the second quarter,  $10\frac{1}{2}$  per cent. in the third quarter, and  $13\frac{1}{2}$  per cent. in the fourth quarter of the year.

Spring calving.

The point in the controversy between the advocates of spring calving and calving later in the year cannot be put more strongly than by Mr. Thomas Duckham in a paper read to the London Farmers' Club; and I will therefore give the gist of his arguments, showing what effect the extensive adoption of each system is calculated to produce upon the breeding and milking qualities of the dam, and upon the constitutional development and generative powers of the offspring; and setting forth also the economical considerations which should decide the question. If a heifer is to calve early in autumn, she must be put to the bull in the middle of winter, when both heifer and bull are being fed upon dry, and, to some extent, artificial food—just the sort of food declared by authorities to be unfavourable to successful impregnation—while rich, juicy, succulent vegetation is the most favourable to breeding. In a few months time she is turned out to the pastures, to graze the young and succulent grasses, which are precisely calculated to develop her milk; whereas, it being yet too early for her milking properties to come into action, she converts the said food into fat, to the injury of her lactic secretions, and to the danger of her own life by puerperal fever, from being too fresh when the time of parturition arrives; to which must be added the by no means trifling consideration that she will be heavy in-calf through the hot season when flies are a torment, and thus run considerable risk of abortion. "The puny offspring," says Mr. Duckham, "shows that it is an animal

born out of due season, and, if reared, it must be treated as a hot-house plant until the following spring; and by the unnatural season at which it was calved, the animal is to a great extent deprived of the genial rays of the sun and the invigorating and refreshing breezes, the fond caresses of its dam and the free exercise of its body, all of which are essentially requisite for the young calf's healthy growth. The dam has to be kept through the winter upon good and expensive food, or she will give no milk."

Suppose that a heifer is to calve late in autumn, the very same objections are in force, except that there is less danger of <sup>Autumn</sup> puerperal fever at calving. The natural tendency of the cow is to yield most milk directly after calving; but the circumstances under which she has been kept for many months check rather than favour its production, and the lacteal organs have become much less active before the cow obtains the spring succulent food which is most conducive to the production of milk. The calf, too, has to be raised like a hot-house plant, *i.e.* it is house-fed, and subject to unnatural treatment at a period of its life when the foundation of its constitution should be substantially laid. When dairying is a consideration, the cow is comparatively unprofitable during the best season for milk. Suppose, now, that a heifer is to calve in April or May, she must be with the bull in July, or early in August, at a period when both animals have been partaking of young and succulent vegetation. While in-calf, she can be kept in the most inexpensive manner during the winter; and as spring advances, and the day of parturition draws near, her food should be improved, and she can be allowed a few hours daily in the pastures. The young, rich, juicy grasses will then purify her blood and develop her milking properties. In a few days after calving the heifer finds in the pastures the food best calculated to meet her wants, at a time when her natural tendency to produce milk is most active. The calf has free liberty in the open air, its vital organs, as well as every muscle, being brought into healthy action by fresh air and exercise, and the foundation of a robust constitution early laid. Compare this with the winter "hot-house" treatment, to which the words of Dr. Hitchman of Derby (a Shorthorn breeder) are applicable;—"Exclude a young growing animal from light, keep him warm by means only of the carbonic acid gas which he has breathed from his lungs, and by the decomposition of his wetted bedding and the ammoniacal gases which emanate from his secretions, and you plant the seeds of scurvy, black-leg, and those other complaints which carry off calves suddenly and hopelessly."

There is no doubt that one reason why we hear so much of

high-bred stock proving barren, and so much of their loss of milking property, is due to the system of autumn calving. Nevertheless, agriculture is by no means an art of rigid certainties and invariable formulæ; and though spring may be theoretically the right time for calves to drop, calves are still reared with advantage when coming at other seasons, particularly where there exists no adequate proportion of natural pasture. Calves must fall in September or October, because the arable-land farmer has his greatest supply of food in the winter; and by house-feeding, with a milk diet largely supplemented and very speedily replaced by all sorts of good things, the calves grow very rapidly, and a greater number can be reared in this way than by simply letting one cow suckle one calf.

Calves, again, intended for veal, are dropped in October and house-fed, turning out in spring nearly as big as yearlings under the spring-calving and suckling system.

Milk and butter are at their highest value in winter; and hence dairy farmers in many districts, as in the best dairy regions of the Continent, prefer that their cows shall calve in November, December, and January.

Removing the  
calf from its  
dam.

*Treatment of Calves.*—When a calf is to be raised by hand, it is a question how long it should be allowed to remain at first with its mother. Some dairymen take it away at once, not suffering the cow even to see it; unless, indeed, the dam be a heifer, when a few days of suckling will make her easier to milk afterwards. By escaping all “worrit” after her progeny, she is supposed to give her milk more kindly to the pail; but, if better for the dairy, this is certainly worse for the little calf. A very common practice is to leave the calf for three days with its dam.

In Devonshire, by a prevailing though not universal custom, the calf is taken from the dam at eight or ten days old, and given, for the first week, about 5 pints of new milk twice a day; then some of the new milk is withdrawn, and an equal quantity of skimmed milk added for two or three weeks; when all the new is taken away, and a few turnips and oatmeal are given until the time for turning to grass. Commonly, except in the severest weather, the calf never enters a shed until calving, working, or fattening. This shows the constitution and hardihood of the Devon breed, also the mildness of the south-western climate.

To what extent the practice of suckling prevails can hardly be ascertained, but references are made to this point in my notices of the different breeds. Hereford calves, for example, are generally suckled on their dams for three to six months, while the bull-calves often run with them for eight or nine

months. When breeders do not follow the simple but expensive course of letting the calves run with their mothers, it is common to make a cow suckle two calves. In rearing by hand, many modes of management are in favour. In all cases the first food is new milk, warmed to the temperature of the mother's milk. This continues for a fortnight at the least, and then some stock-masters, with a view of gaining a little butter, and rearing the greatest number of calves, begin to substitute skim-milk for new milk. During the third week of the calf's life, they let one-third of his allowance consist of skim-milk, boiled and allowed to cool to the natural temperature, and, during the fourth week, fully half the allowance is skim milk, and half new milk.

The calf's diet

One of the most annoying things in calf-raising is the carelessness or wilful laziness of servants in scamping over this troublesome boiling and warming up (more troublesome still when mixtures and porridges have to be prepared); and one chill meal will injure, or may kill, a tender calf.

The quantities given at each meal vary according to the breed, size, and state of the calf. For a healthy Shorthorn are commonly used—in the first week about 3 pints at once, given three times, say 4 quarts per day; gradually increased till, in the fourth week, the quantity is 5 pints at once and three meals, making up 8 quarts per day. At one month old, when the calves eat hay, finely sliced roots and cake, two meals a day may suffice; the quantity at two months old being 4 quarts at a meal, or 2 gallons daily. A minor detail, but of some importance, consists in the mode of giving the meal. Good managers not only induce calves at starting to drink out of a bucket, by causing them to suck up the milk through the herdsman's (in old-fashioned times it used to be the dairymaid's) fingers; but they continue this practice, to prevent the little animals swallowing too much at a gulp, and to allow of an admixture of saliva while the food is passing through the mouth. A nose-bag with small apertures is sometimes put on when giving the bucket-food. A recent invention for properly giving the calf his morning and evening meals is Tucker's calf-feeding bucket; another is White's artificial dam, and another Brooks and Co.'s Lac Trephoer; the first being well spoken of. A muzzle (of wire or leather, cup-shaped, with a band sewn at each side to buckle behind the ears) kept on, except at feeding time, will prevent the calf taking up straws and swallowing them before the power of digestion can cope with such food. Sometimes a mass of undigested straws has been found in a dead calf's stomach. Of course, the time for wearing the muzzle is until the calf has been observed to "chew the cud."

Feeding the calf.

Milk -  
substitutes.

I have spoken of new milk and skim-milk, half and half. But before the calf is a month old it is now usual to substitute porridge for a portion of the milk, different managers making use of different articles. I believe boiled linseed-gruel or jelly is as good as anything. A pound of linseed makes a gallon and a half of gruel. Some people prefer the gruel of linseed and wheat-meal together, in the proportion of two of the linseed to one of the wheat-meal, boiled and mixed with the milk. Others use oilcake-porridge, the cake crushed fine, boiling water poured on it (about four parts of water to one of cake), letting it stand half a day, with occasional stirrings. Other breeders use oatmeal, pea-meal, and bean-meal, and flour of the carob or locust-beans, making the porridge by pouring hot water upon the meal and mixing with the milk gradually so as not to let the mixture get lumpy. Irish moss is used, also treacle-dip; but this in moderate proportion, seeing that cow's milk is not very sweet. Hay-tea, made of old hay, macerated in water hot, but under the boiling-point, is an admirable thing to mix with milk, as it contains a large amount of nutriment in a soluble form. Wise managers make use of several of these liquid compounds, so as not to let any one of them pall upon the appetite of the calf. And by occasionally using them separately in turn, judiciously plying the laxative or astringent articles of diet according to the state of the calf's bowels, there is a likelihood of keeping the calves healthy;—thus oilcake, flax-seed, or oatmeal is used, when the body is bound, pea-meal and bean-meal, &c., when the bowels are loose.

Detailed  
example of  
rearing calves.

Innumerable examples might be adduced of the best English management of calves. I must be content to describe the details of one. Mr. Henry Ruck, of Eisey, near Cricklade, in Wiltshire, rears calves thus—and in rearing fifty to sixty animals has not lost one in two years. He takes the calves from a dairy after they are ten days old, as up to that time they require their mother's milk, which is unfit for butter making. The price is 30s. each. For the first three or four days they have 2 or 3 quarts of milk at a meal; then gradually some food in the shape of gruel is added, and by degrees water is substituted for milk. Mixing oilcake with the gruel is the secret of success. Half oilcake is used, the best that can be purchased. Take a bucket, capable of holding 6 gallons, put into it 2 gallons of scalding water, then add 7 lbs. of very finely ground linseed-cake, which is obtained by collecting the dust that falls through the screen of the crusher, and passing it through a roller-mill; well stir the oilcake and water together, and add 2 gallons of hay-tea. This hay-tea is made every morning by filling a small tub with sweet hay, pouring on



scalding water; this is used in the evening, and a sufficient quantity of scalding water is added to the hay-leaves, which are covered down for next morning. The hay-tea is very sweet, dark in colour, and the extract of the different herbs probably assists digestion. Again the mess is stirred, and 7 lbs. of mixed flour well worked in. This mixture consists of one-third wheaten flour, one-third barley, and one-third bean-flour. Sufficient cold water is added to fill the 6-gallon bucket, and the whole is well stirred. Two quarts of this, with 2 quarts of cold water, are sufficient for a calf at a meal, and the mixture has about the right temperature. The food is given at regular hours—say 6 in the morning, and 6 at night. Each bucket of gruel is a meal for from twelve to fifteen calves, and costs about 1s. 6d.; or 3d. a day for each calf. The food is always measured with a two-quart cup, so as never to overload the stomach of a young calf. After fifteen days, when the calf chews the cud, some of the difficulty and danger are passed, and when the calf eats well, the quantity of gruel is gradually diminished. The calves are tied up while being served, and they suck through the cow-man's fingers, as this prevents bolting, and a proper quantity of air is also taken in. As soon as they can eat, crushed corn, sweet hay, and roots, are placed within their reach; vetches also when available, and mangolds when practicable. The calves live in a cool well-ventilated house, are kept very clean and quiet, supplied with fresh water daily, and the manure is frequently removed.

During the first winter Mr. Ruck uses the following mixture of food for his calves:—5 cwts. of straw-chaff, 10 cwts. of pulped mangolds, 1 cwt. of oilcake, and 4 cwts. of mixed crushed corn; put together and allowed to heat moderately. This gives a ton of food superior to hay at a cost of about 50s.

Weaning from milk and bucket-food altogether comes at various ages, according to the customs of different managers; three to four months being the most common age, though many calves are reared without tasting any milk after they are two months old. Weaning.

The most prevalent ailments of young cattle are scour or diarrhoea, and hoose or catarrh, from which great losses often occur; and another special danger to which they are liable is quarter-ill, or black-leg. Ailments of calves.

Weaned calves and yearlings are usually run thinly upon the sheep pastures during the summer, changing them according to circumstances, as they seem to require it; sometimes from a good to inferior pasture, or *vice versâ*, or any salutary change that the farm will afford. It is found a capital thing to have meadows on soil quite different from that of the general grazings, Grazing calves.

where the prevalent herbage of a lot of grass-land, perhaps a few miles from the home farm, may prove a corrective to the laxative or other qualities of the grass on the home farm. In autumn an aftermath is often provided, to which the young stock may be taken as the old pastures begin to lose their freshness. When the aftermath, too, falls off, recourse is had to more oil-cake and other artificial feeding stuffs.

Wintering  
calves.

As autumn approaches, the young animals are housed at night, the shelter consisting of open yards, well bedded, with sheds into which the calves can retire at pleasure. Indeed, this is the sort of accommodation that calves and yearlings should enjoy through the winter, in preference to closed up stalls or boxes. I am sorry to say that the essential requisites of air and exercise are but little considered over wide areas of this kingdom; and farm buildings are, as a rule, contrived without due regard to the wants of the young animals. A common error with architects being the notion that calves and yearlings should be kept warm, without allowing for their freely moving about and respiring uncontaminated air. As to the winter food of yearlings, they are too often injured by an injudicious use of straw-chaff; though straw might be employed much more largely than at present in the feeding of adult cattle. One of the best managers of stock gives to each of his yearling cattle 25 to 40 lbs. of roots, 6 to 8 lbs. of chaff, and 1 lb. of linseed-meal or oil-cake, with 1 lb. of oats, barley, maize, or other corn, according to the price ruling in the market at the time. This is boiled or steamed with the pulped roots and chaff.

The summer grazing of young and store cattle, is treated of under the head of "Pastoral and Dairy Farming." I come now to that fundamental branch of all arable husbandry, excepting on some classes of small farms, meat-making and manure-making at the homestead.

Open yards for  
cattle.

*Winter Housing and Feeding of Cattle.*—The old practice of feeding cattle loose in open yards, or tied by the neck in semi-open sheds or hovels, prevails to a large extent in England, notwithstanding all the experiences of late years with boxes and covered yards. Of the non-nitrogenous food consumed by warm-blooded animals, chemistry tells us that a considerable proportion is expended in maintaining the natural heat of their bodies—it is so much fuel dissipated by a process strictly analogous to combustion—and that fat, accumulated under certain circumstances, may be regarded as a store of fuel laid up for future emergencies. Of course it is apparent that if fattening cattle are exposed to a low temperature, either their progress must be retarded, or an additional expenditure of food be incurred.

Protect the animals by suitable shelter and covering, that is to say, prevent radiation and conduction of heat from their bodies, and they will eat less and yet lay on more flesh and fat. This is what theory says.

In open yards, however, there are the greatest facilities for converting whole straw into manure, and the cattle thus fed require least attendance and look well when brought to market. Of course, both stock and manure suffer from exposure to prolonged wet and protracted cold weather.

Nearly all the Norfolk beasts are fed in open yards, holding ten to twenty each; and the Norfolk farmers, some of the best managers in the kingdom, find the system well adapted to their husbandry, which, being the four-course, furnishes them with a large quantity of straw for litter. In Lincolnshire this treatment of fattening cattle is not carried to the same extent. The stores and half-fat animals intended for the next summers' grazing are fed in open yards, with open shed-roofs or shelters, for them to run under. Some managers fatten bullocks in yards; but the majority are finished off in stalls or boxes.

Where straw is not superabundant, the open-yard system of fattening is wrong, on the ground of waste; and housing is requisite for the purpose of economising straw. It is argued that as the open-air system is at fault, in failing to utilise to the best advantage one of the main cattle-food products of the farm, either there should be more cattle fed in boxes with the abundance of straw, or else more white-straw cropping is grown than can be dealt with most economically. But this opens up the question of the best system of husbandry adapted to each particular description of land—and that depends upon many other considerations besides the consumption of straw. The old-fashioned, but still prevalent open-yard feeding, with its careless use of straw and its loss of caloric from the animals' bodies, is not to be put right at a single stroke by just shutting up the cattle in houses and cutting the straw for them.

Stall-feeding is about as old-fashioned as feeding in open courts; but it has not died out yet, and bids fair to last for generations to come.

The commonest arrangement is for the animals to stand in pairs, two in a stall, that is, between low boarded divisions, each beast being chained by the neck to a ring that can slide up and down a long staple in a post. A trough or manger, low down, is in front of the animals; and either a small water trough, placed so that both beasts can drink out of it, or else one long trough (higher up than the manger and further from the animals) runs the entire length of the building and supplies all the animals. Stall-feeding.

In a well-made house, sufficiently closed-in to be warm, without being dark or impeding ventilation, cattle do well in stalls. The least amount of litter is required, because the beast's droppings are cleared out every day. The disadvantages are that a great deal of labour in "attendance" is required, and the animals get no exercise whatever—supposed to be necessary for their health. As to this latter objection, all depends upon the length of time the animals are thus in durance.

Mature and fattening animals are thus stalled for half a year together; but milking cows that live in stalls should be turned out daily for an hour or two loose in a yard.

Hammels.

The "hammel" system combines the advantages of open yards and of stalls. Each shed (*i.e.* a compartment of a long hovel, partitioned off) should be of a size to contain easily from two to four beasts, so that they can comfortably walk round it, and the doorway opens into a small uncovered yard; the best arrangement being a long building, subdivided into boxes, with a row of little yards outside. The troughs for the food and also moveable racks are in the yards.

The animals have more freedom than when fed in close houses—they have moderate exercise to keep them healthy without hindering their fattening—they get sun and air, rain, too, if they please, and shelter whenever they choose. They can go to the food when they like, and this, being in the open air, keeps fresh. In fact, nature is consulted so far as is compatible with convenience of administering food and bedding. The cost of attendance is less than on the stall system, the dung being covered over with fresh litter, instead of being removed; and the manure, too, being about one-third part under cover, is little less powerful than that from covered boxes.

Boxes.

"Boxes"—compartments inside sheds completely under cover—preserve the animals from cold and from disturbance. The cattle have a moderate amount of exercise, require less attendance than when in stalls, less straw is required for bedding than in open yards, and the manure, screened from sun, wind, and rain, and absorbing the urine, is superior to that produced by other plans.

Size of yards,  
stalls and  
boxes.

The space suitable for cattle in open yards, with shelter sheds, may be taken at about 100 square feet per head, including the sheds. In covered yards, where the animals have always a dry bed, the area may be reduced to 80 square feet, including that occupied by the feeding-troughs. In single boxes, which are constructed of very varying sizes, Mr. J. Bailey Denton (in his valuable work 'The Farm Homesteads of England') considers 90 square feet a fair standard area, including the space covered

by the troughs and the mean space in stalls may be taken at 40 square feet per ox. These dimensions apply to cattle of mature age, in process of fattening, or yielding milk; though in many cases much larger areas are given; and full-grown Hereford and Shorthorn oxen of course require more room than smaller varieties of dairy cows and young stock.

A convenient width of building for stalls is  $18\frac{1}{2}$  feet within the walls; which gives a feeding-passage at the head,  $4\frac{1}{2}$  feet; a feeding and drinking-trough,  $2\frac{1}{2}$  feet; the stall or standing,  $7\frac{1}{2}$  feet; gutter, 1 foot; back-walk, 3 feet. Cows tied up in pairs have commonly a stall of  $7\frac{1}{4}$  feet width, and fattening bullocks in pairs, a width of 8 feet.

For boxes, the most economical breadth of building is about 25 feet, allowing for two rows of boxes of 10 feet each, with a 5-foot feeding-passage between, and each box may measure 10 by 9 feet. The floors of the boxes lie 1 to 2 feet lower than the ordinary floor-level of the farm buildings.

The cheapest form of house for a large number of cattle is probably one in which the animals are placed in two rows, with a feeding-passage between. One of the best examples of such an arrangement, with central tramway and contrivance for almost automatic distribution of the food, is that of Mr. Edmund Ruck, at Braden, in Wiltshire.

Arrangements  
and fittings of  
feeding-houses.

Cattle require cleanliness and convenience, but not artistic beauty in the fittings of their buildings; and hence some decorative fancies of architects or amateurs in farm-buildings may be considered an entirely misplaced outcome of extravagance in designing. Feeding-troughs of rough brick or of coarsely tooled stone will do; and slate, or smoothly-moulded cement linings are an improvement. Mr. Bailey Denton, however, prefers earthenware lining for the purpose of keeping the trough in the cleanest condition. Water-troughs are best furnished by a self-supplying system; and these troughs should be emptied once a day by a plug or tap, to discharge the stale contents, which are used to wash down the stall.

On the value of covered yards, of which a large number now exist in many parts of England, I cannot do better than quote the experience of Mr. Henry Howman, of Halloughton, Coleshill. In a paper read to the Midland Farmers' Club, Mr. Howman said, "One difficulty to be contended against in making manure under cover is to get sufficient moisture to prevent it getting fine-fanged; and, when an abundance of long straw is put into the yards for litter, this evil is apt to take place, and the manure becomes so light and dry that it has to be carted out into a heap to allow the rain to moisten it and make it tender enough to be ploughed into the land,—by this very act, and the consequent washing

Covered yards.



and draining that takes place, neutralising the good gained by making the manure under cover. Now, I have met the difficulty by not allowing one bit of straw to be placed in the yards for litter without first being put through the litter cutter, and cut into about 6 in. in length; and this, I am convinced, is an absolute necessity for the proper making of the manure. After two years' experience of the plan, against the cost of cutting up the straw, which is done by hand, I gain these advantages—the yards are littered more evenly and regularly, and not so much straw is used; while, in emptying the yards, a great saving of labour is gained, because the manure is forked out so much more easily, and it is ready to be carted on to the land direct from the yards, and all the wasteful and laborious carting it into a heap, to be rotted and washed by the rain, is saved. I think there can be no doubt that the manure made under cover must be more valuable than that made in the open yards; how much more valuable I am not prepared with any comparative figures to show; but the fact that all the valuable fertilising matters are neither diluted by the rain nor drained away must improve the quality."

Mr. Howman's covered-yard premises cost about 2500*l.*; and taking the increased value of the 750 tons of manure made in the year, as compared with open-yard manure, at 3*s.* per cubic yard, this amounts to an improvement, or saving in the manure of 112*l.*, or nearly 5 per cent. on the cost of the buildings. He considers this a sound basis on which to estimate the sum a tenant can afford to pay to a landlord for erecting a covered homestead. The comparison here is with open-yard manure badly managed. But there is no doubt that at least a ton of straw per head of cattle wintered is saved in covered homesteads: and this is a gain of 2*l.* 10*s.* to 3*l.* per head,—say in one season, 125*l.* to 150*l.* upon fifty beasts. For straw is a commodity of high value in England, and it is permitted to be sold off most farms within easy distance of towns.

Mr. Howman observes, truly enough, that "it is not at all necessary to pull down all the present buildings and to rebuild on new lines, as has been done in his case; but yards as they exist at present might be covered over, and so arranged that they could be worked in with the buildings with little or no alteration; this could be planned and carried out by the estate carpenter or builder, and the cost would not be so great as to frighten landlords, who would have to find the capital, or the tenant, who would have to pay the interest." In fact, the tenant could afford to offer such a percentage to the landlord as would be an inducement to him to invest in such an improvement.



“Assuming the form of the existing yards to be as follows:—the barn and main buildings to occupy one side of a square, from which at right angles should run the sheds, with the open fold-yard between them—then to cover over the yards and build up one end would be all that is necessary, and this would cost about 20s. the square yard of ground to be covered. Assume the size of the yard to be 300 square yards, and the depth one yard, that would mean 100 cubic yards of manure, this, at 2s. a cubic yard, the supposed increased value by covering the manure, would give 30*l.*, or 10 per cent. for covering the yards.

“The estimate for roofing only would be 5*l.* a square of 100 ft. ; and 9 in. walls would cost 5s. a square yard to build; but, of course, this depends upon the price of bricks, which varies considerably. The corrugated-iron roofs seem to offer certain advantages for the purpose, and can be erected at a cheaper rate than ordinary slate or tile roofs; they could be erected at about 15s. a square yard of ground to be covered—and the difficulty of the temperature being too hot in summer, and too cold in winter, could be overcome with a little trouble and a very slight expense.”

*Food of Fattening Beasts.*—The old fashioned diet—of uncut hay *ad libitum*, whole or sliced turnips, from a hundredweight per day to much more for large oxen, and linseed-oilcake, beginning with 7 lbs., increased up to 14 lbs. or more per day—has been abandoned by scientific manufacturers of meat, though it has not been altogether superseded on English farms. In a good turnip season on turnip farms the feeders go far beyond the consideration of merely putting flesh on a bullock, and make him, to a certain extent, a waster of food, by passing large quantities of roots through him for the purpose of converting them into manure. And without a large allowance of roots, not cooked, but raw, given during the last few weeks of the fattening process, bullocks do not always give the butcher satisfaction in their internal fat, while their flesh is not so firm as it should be. The credit which the Norfolk cattle maintain in the London market from January to late in spring is greatly owing to the abundance of roots with which they are supplied. Thus, a rule which holds good in a poor turnip country will be inapplicable in another part of the kingdom where the roots possess a far more nutritious quality. Hence, the experience of Scotch feeders is rarely realised in England. Mr. William McCombie, of Tillyfour, in Aberdeenshire, fatted from 300 to 400 beasts annually, selling them in London at an average price of about 35*l.* per head. Yet he never gave them more than 4 lbs. of oilcake and 2 lbs. of bruised oats per head per day. They had what turnips they could con-

Roots for  
fattening  
beasts.

sume, and ate straw *ad libitum*; and Mr. McCombie stated his average return from feeding on Aberdeen yellow and Swedish turnips to be 12*l.* per acre. In the south, the calculation in a rough way would rather be as Mr. J. Chalmers Morton once put it:—

Mr. J. C.  
Morton on  
money value  
of roots.

Take the production of roots at 20 tons per acre, for a good crop, and a crop of trefoil or clover at 30 cwt. per acre, and see how long this will (with proper management) keep a fair-sized ox in a going-on state. Let the daily food be 6 stone roots, 6 lbs. clover-chaff, 12 lbs. of straw-chaff. The artificial food 6 lbs., say, 4 lbs. linseed-cake and 2 lbs. of eorn-meal. This gives from the produce of 1 acre of turnips and 1 acre of clover, 76 weeks' keep for a bullock; or, putting it in a different way, 1 acre of turnips and 1 acre of clover (with straw in addition) will keep 3 beasts through the winter. The artificial food, with cake at 10*l.*, and bean, Indian-corn, or lentil-meal at 8*l.* per ton, will cost 3*s.* 6*d.* per week per head. It is but a moderate sort of bullock that will not pay 6*s.* per week for this keep, which will leave 5*l.* per acre for the roots, and 3*l.* per ton for the clover consumed, besides the manure. Those who do not give clover to their cattle may add 2 lbs. of artificial food per day, and use all straw; but a portion of each is to be preferred for profitable feeding. If a farmer realises 5*s.* per ton for his roots, and 3*l.* per ton for his hay, by feeding bullocks, he does very well, as ordinary good practice goes.

Where unprepared dry food and roots are still retained as the bulky portion of cattle provender, the very general practice now is to replace a portion of the oilcake with corn or meal.

It would be convenient to classify the many different systems of feeding, as the "raw food," the "cooked food," and the "pulped and fermented;" but a mixture of one or more of these methods is so often followed, that the simplest way will be to describe the general management pursued in a number of representative cases.

Cooked cattle-  
food.

Mr. Warnes'  
practice.

Cookery, by boiling or steaming, though of very old date in preparing cattle-food, was revived in importance a few years ago by Mr. Warnes, of Trimmingham, in Norfolk, who claimed to have introduced the system of box-feeding. His fattening compound was thus made:—

"Upon every 6 pails of boiling water, 1 of finely crushed linseed-meal is sprinkled by the hand of one person, while another rapidly stirs it round. In five minutes, the mucilage being formed, a half-hogshead is placed close to the boiler, and a bushel of cut turnip-tops and straw put in; two or three hand-eupfuls of the mucilage are then poured upon it and stirred in with a common muck-fork. Another bushel of the turnip-tops,

chaff, &c., is next added, and two or three cups of the jelly as before; all of which are then expeditiously stirred and worked together with the fork and rammer. The mixture is afterwards pressed down as firmly as its nature will allow, with the latter instrument, which completes the first layer. Another bushel of the pea-straw, chaff, &c., is thrown into the tub, the mucilage poured upon it as before, and so on until the boiler is emptied. The contents of the tub are lastly smoothed over with a trowel, covered down; and in two or three hours, the straw, having absorbed the mucilage, will also, with the turnip-tops, have become partially cooked. The compound is then usually given to the cattle, but sometimes is allowed to remain until cold. The bullocks, however, prefer it warm; but, whether cold or hot, they devour it with avidity." Another modification is,—To 9 or 10 pails of water is added a bushel of swedes, sliced very small; after having boiled a few minutes, about 2 pecks of linseed-meal is actively stirred in; then the process as before, a proportion of barley-straw being used with pea-straw for the chaff.

Mr. Kennedy, of Myremill, in Ayrshire, found his cattle to thrive better on a small than on a large quantity of turnips, provided he gave them bulk of other food; that a bullock of 56 stones imperial, requires only  $4\frac{1}{2}$  to 5 stone of cut swedes per day, and from 16 to 20 lbs. of cooked food, consisting of 1 lb. linseed, or 2 lbs. of oilcake-meal, converted by boiling into a mucilage, which is then poured over a mixture of 2 lbs. bean-meal, 2 lbs. bruised barley or oats, 10 lbs. to 12 lbs. of hay, 14 lbs. of chaff, and some salt, well mixed together, and allowed to lie for 2 or 3 hours that the dry ingredients may absorb the mucilage. But the difference between quality in roots does much towards making a short allowance in Scotland answer as well as a larger feed of roots in a poor turnip country.

Mr. Russell, of Kilwhiss, Fifeshire, found that when cattle were first put to turnips in the autumn, and allowed to have as many as they could eat, animals weighing about 50 stones imperial, will consume daily 220 lbs. (say 2 cwts.) of cut swedes, with oat-straw in racks, and 5 lbs. of cake besides. He followed a modification of Mr. Warnes' system with advantage. At 6 A.M. each beast received a feed, consisting of 1 lb. of cake, 1 lb. of ground grain, well mixed with 5 lbs. of 1-inch chaff; the latter having been well-wetted with cold water before the cake and grain were thrown in amongst it. By 8 o'clock they had an allowance of 50 lbs. cut turnips; and at noon, and in the afternoon, were again fed with the same quantities of food. By this mode of feeding, 4 or 5 lbs. of oilcake and grain become a substitute for 100 lbs. of turnips. This plan is admirable for its simplicity,

economy, and its good results, but, nevertheless, is materially improved upon by more complicated preparation and cooking, more particularly the pulping system, which I shall come to presently.

Another  
example of  
feeding.

A large cattle feeder in Northumberland adopted another modification of Mr. Warnes' system, differing from Mr. Russell's, in that boiling water and a close vessel are used for incorporating the meal and chopped straw, instead of wetting and turning upon a floor. The cattle are fed with turnips, bean-meal, oilcake, and cut straw. The first thing in the morning they get the mixture, then turnips, and at 1 o'clock the mixture again; afterwards turnips. He found that a 3-year-old steer will consume (if fed on this alone) from 16 to 18 stones of turnips daily. The mixture given is 2 lbs. of oilcake, 2 lbs. of bean-meal, 4 lbs. of cut straw, and 1½ oz. of salt daily. This can be purchased and prepared for about 1*d.* per lb., or 2*s.* per head per week. When cattle have this mixture, they consume at least 1 cwt. less per day of turnips. The mixture is prepared in the forenoon by the byreman, and keeps perfectly sweet for 36 hours. In preparing the mixture to serve 24 cattle for 24 hours, 48 lbs. of oilcake, 48 lbs. of bean-meal, 96 lbs. of cut straw, and 2 lbs. of salt, are, in the first place, well mixed together in a trough; 36 gallons of boiling water are then added; after which the whole mass is well turned and incorporated together, and pressed down, and in an hour or two is quite ready for the cattle. The troughs in which the mixture is made are 6 feet long, 2 feet wide, and 2½ feet deep. A trough of this size will contain mixture for 24 cattle, and the time occupied by the man in preparing one full trough is not more than half-an-hour; the cut straw, meal, &c., being all ready.

Mr. Lawrence's  
practice.

Mr. C. Lawrence, of Cirencester, recorded his experience in the Society's 'Journal' thus:—"We find that, taking 24 bullocks together fattening, they consume per head per diem 3 bushels of chaff, mixed with just ½ cwt. of pulped roots, exclusive of cake and corn; that is to say, about 2½ bushels of chaff are mixed with the roots and given at 2 feeds, morning and evening, and the remainder is given with cake, &c., at the middle-day feed. Thus: we use a steaming apparatus of Barford, of Peterborough, consisting of a boiler in the centre, in which the steam is generated, and which is connected by a pipe on the left-hand with a large galvanised-iron receptacle for steaming food for pigs, and on the right-hand with a large copper, surrounded by a steam-tight compartment, in which the cake, mixed with water, is made into a thick soup. Adjoining, there is a slate tank of sufficient size to contain one feed for the 24 bullocks feeding. Into this tank is laid the chaff, about 1 foot deep, upon which a



few ladles of soup are thrown in a boiling state; this is thoroughly mixed with the chaff, with a three-pronged fork, and pressed down with a rammer; and this process is repeated until the slate tank is full, when it is covered down for an hour or two before feeding-time. The soup is then found entirely absorbed by the chaff, which has become softened, and prepared for ready digestion."

Mr. Lawrence used much rape-cake, as the most economical food, notwithstanding all that has been said and written against it. There is doubtless more or less mustard-seed often grown with foreign rape-seed; but this adulteration was found to be rendered quite harmless, when the soup was exposed to a temperature of 212°, and allowed to simmer a few minutes at that heat before it was thrown over the chaff. His adoption of rape-cake was based on the comparative analyses of linseed and rape-cake, which show very little difference in the feeding value, while the market price of one is usually double that of the other. In his experience of this use of rape-cake, extending over a period of 10 years, in feeding from 20 to 24 bullocks annually, he had not a single death during that period, and the animals had been remarkably free from any kind of ailment. Rape-cake not being so palatable to animals as linseed-cake, he did not exceed 4 lbs. per head per diem, and added in the trough of each beast, with the mid-day feed, 2 lbs. of mixed meal. He rarely exceeded this allowance, excepting in the case of very large oxen. He commenced with 1 lb. of cake per head, and increased gradually up to 4 lbs., when he began mixing the meal. The manufacture of a large quantity of the best manure being a great object, it was not Mr. Lawrence's plan to hurry the progress of the cattle to maturity for the butcher.

The cost, on an average, including attendance and fuel, was found to be 6s. per head per week, exclusive only of the expense of chaff-cutting. One man and a lad, at 18s. per week for the two, pulped the roots by hand-machine, fed, littered, and cleaned the cattle, and cooked the food for the 24 bullocks, and also cut and steamed the roots for feeding 24 pigs.

As an instance of the value of a judicious system of feeding, and of the advantage of steamed food, take the experience of the late Mr. Horsfall of Otley. On winter food he fattened his cows while they were giving milk. For four years he gave his dairy cows green rape-cake, which imparted to the butter a finer flavour than any other cake did; and in order to induce them to eat it, he blended with it one-fourth the quantity of malt-dust, one-fourth bran, and twice the quantity of a mixture in equal proportions of bean-straw, oat-straw, and oat-shells, all well mixed up together, moistened, and steamed for one hour. This compli-

Mr. Horsfall's  
practice.

cated mixture of steamed food had a very fragrant odour, and was much relished by the cattle; it was given warm three times a-day, at the rate of about 7 lbs. to each cow (21 lbs. daily). Bean-meal was also scattered dry over the steamed food, cows in full milk getting 2 lbs. per day. When the animals had eaten up this steamed food and bean-meal, they were supplied daily with 28 to 35 lbs. each of cabbages, from October to December, of kohlrabi, till February, or of mangolds, till grass time—each cow having given to her, after each of the three feedings, 4 lbs. of meadow-hay (or 12 lbs. daily). The roots were not cut, but given whole. The animals were allowed, twice a-day, to drink as much water as they desired. Afterwards, Mr. Horsfall discontinued the use of bean-meal, owing to its comparative price, and gave in its place an additional allowance of malt-coombs, with about 5 lbs. of rape-cake, and 2 or 3 lbs. of Indian corn-meal per cow. On this food, in instances actually observed, his cows gave 14 quarts of milk per day, and yet gained flesh at the rate of 2 stones imperial per month.

This scientifically conducted feeding of itself forms quite a study. Mr. Horsfall both regulated and explained his practice by chemical analyses and physiological considerations, showing what an elaborate business meat (or milk) production has become. But everybody is now aware of the advantages to fattening beasts of boiling linseed and bean-meal to the consistence of a thickish soup, making it salt, and pouring it over a heap of mixed straw and hay-chaff, and letting the whole lie until it is thoroughly soaked before being given as food.

Pulping roots.

Of late years pulping has come in fashion. And whether or not the advantage of pulping is derived from its inducing a larger consumption of straw (cut and mixed with the pulp) than cattle will care to eat uncut, it is decidedly a fine thing for the arable farmer who may have been wastefully expending large quantities of straw in litter—a large portion being now saved for use as food. There is economy of food; for the roots, being pulped and mixed with the chaff, render the whole mass of cut stuff very palatable to the animals—no part of the cut hay or straw, or of the chaff from the threshing-machine, being rejected. The animals are not able to separate the chaff from the pulped roots, as is the case when the roots are merely sliced by the common cutter; neither do they waste the fodder as when given without being cut. We can thus utilise mean and inferior hay or straw. After being mixed with the pulp for about twelve hours, a fermentation commences; and this soon renders the most mouldy hay palatable, and the animals eat with avidity that which they would otherwise reject. This fermentation to some extent, I believe, softens the straw, putting it in a state to



be assimilated more readily. The pulper is of great value, particularly upon corn-farms, where large crops of straw are grown, and where there is a limited acreage of pasture; as by its use a larger proportion of the pastures may be grazed, the expensive process of haymaking reduced, and consequently an increased number of cattle kept. The accident of choking large pieces of root is avoided, and hoose is less frequent than under the sliced-root system.

In a good system of feeding with the use of pulped roots, the following routine is adopted: first thing in the morning give an allowance of 2 to 4 lbs. of linseed-cake, followed by a feed composed of cut chaff, pulped roots, and meal. This is repeated, so as to make three feeds per day, and the racks are supplied with hay at night. The corn-meal is mixed with the cut hay and straw-chaff, and pulped roots, say twelve hours before using, so as to allow a slight fermentation to commence. Good feeders, however, always consult nature by occasional changes of food; and they believe in giving whole or sliced but unpulped roots, in considerable quantity, during the latter part of the fattening process.

As a contrast must be set the large amount of experience of cattle fattening with little or no root food at all.

For instance, Mr. W. J. Edmonds, of Southrope, Lechlade, Cattle diet without roots. has recorded the favourable result of fattening cattle, giving each ox 5 bushels of mixed hay and straw-chaff, 4 or 5 lbs. of oilcake, and  $\frac{1}{2}$  a peck of meal (barley, bean, pea or wheat-meal,) increased to 1 peck per day about six weeks after the fattening has begun. The oilcake and meal are boiled for  $\frac{1}{2}$  to  $\frac{3}{4}$  of an hour, and thrown as a rich soup over the chaff, with a little salt, about 8 hours before wanted, or not much longer, lest it should turn sour. And Mr. Edmonds' Christmas cattle with this feeding, and only one peck of roots each in addition, handled remarkably firm, were well fed, and made a good price.

The practice of Mr. Charles Randell, at Chadbury, near Evesham, Mr. Randell's practice. may be here adduced as one of the best examples which English farming affords of cattle-feeding and manure-making without roots. Mr. Randell's statement, which appears in Mr. Joseph Darby's paper in the Royal Agricultural Society's 'Journal' on "Straw as Food for Stock," is as follows:—

"After having heard how readily and profitably straw, aided by roots, cake, and corn, is converted into beef in Norfolk, and other root-growing counties, and the manure, essential for the reproduction of the means of carrying on the process, preserved, you may like to know how the occupier of a clayland farm (where to attempt to grow turnips is in the opinion of some good practical farmers in the neighbourhood a sufficient qualification for a lunatic asylum),

tries to convert his straw into manure which deserves the name without serious loss.

<p>"I have 15 two-year-old steers feeding, 25 milking and in-calf cows, 2 bulls, 6 two-year-old heifers, 15 yearlings,</p>	}	<p>These with their manure are entirely under cover.  In small yards, shedding spouted.</p>
--	---	---

"These 63 animals consume daily as follows:—

"As much steamed chaff, one-fourth hay, three-fourths straw, as they will eat.

	£	s.	d.
4 bushels of Indian corn, costing .. .. .	0	14	0
1½ cwt. decorticated cotton-cake .. .. .	0	12	6
1 cwt. bran .. .. .	0	5	6
1 cwt. malt-dust .. .. .	0	5	6
½ bushel Black Sea linseed (boiled) .. .. .	0	4	6

£2 2 0 per day

for purchased food only. Now this cannot pay in the shape of a direct money return, and can only be excused by estimating highly the value of the manure—an estimate which will be fallacious or otherwise in proportion to the extent to which the manure is protected from rain. If it be made in large open yards, with the surrounding buildings unspouted, the loss is certain; in small yards, where the open space is not—and it should never be—more than as five to two of the spouted shedding, it is questionable; but in covered yards the cost of food may be recovered, while only one-half of the litter is necessary, thus economising straw and carting; for it is obvious that a much smaller quantity per acre of this concentrated and unwashed manure will be required for any crop. The cattle, too, so protected, will give a greater interest for the food consumed.

"It will frequently happen that by rigid economy in the use of hay—the most expensive food, looking at its selling value, that a farmer can give to his cattle—he may be able to sell some to cover in part the cost of purchased food."

Droughts, with general failure of root crops, have effectually taught farmers how to be for a season, at least, comparatively independent of turnips in their winter beef-making; and cattle are found to do well upon cut hay and straw chaff, wetted with linseed or other slop, thrown scalding hot upon the chaff, or even with bean and pea-meal sprinkled upon damped chaff.

Of late years much greater attention has been paid to utilising a larger proportion of straw for feeding rather than mere manure making. The quality of straw varies much, of course, according to the nature and condition of the soil on which it is grown, and still more from the way in which it is harvested. But when cut comparatively green, and carefully managed, many kinds of straw are exceedingly nutritious. Oat-straw, for instance, when cut green, has 19·0 per cent. of sugar, gum, and mucilage; when fairly ripe, 12·0 per cent.; when over ripe, only 4·0 per cent. Of digestible woody-fibre, it has 35·0 per cent. when fairly ripe. This is the proportion of

dry matter. Practically, we may consider that one-half to three-quarters of the dry matter of oat-straw is available as food, that is, easily digestible by the animal's stomach. But the difficulty with straw is, how to render its large percentage of carbonaceous matter readily digestible; how, in fact, to make a large mass of hard dry material fit for an animal's stomach; for, prepare as we may, there remains always a large percentage of indigestible woody fibre.

Straw can be made palatable and savoury, so that animals will eat it without being driven to such fodder by hunger. Mr. Horsfall steamed beans and oat-straw, so that it became a main article of his cows' food. And the cost of steaming straw-chaff, as ascertained by the experiments of Mr. Henry Evershed, comes out thus. Employing a large apparatus capable of steaming 250 bushels per day, representing at 6 lbs. per bushel, a total weight of about two-thirds of a ton, enough for 75 head of cattle eating 20 lbs. each, the expense was found to be 7s. 6d. per ton, in addition to the ordinary cutting of the straw into chaff. The steaming of 5 tons of chaff per week, for 75 beasts would thus cost 6d. per head per week. Of course, with smaller quantities cooked, the expense for fuel and labour would be greater. Where the exhaust steam from a fixed engine can be utilised, the expense will be very little indeed.

Steaming chaff.

Mr. Evershed's practice.

Mr. Mechi, at Tiptree Hall, Essex, cuts his green food, along with straw, into short chaff, mixes this with meal, cake, and pulped roots, and heats all together in coppers by the waste steam and condensed hot water from his engine. Bean-straw, when passed through the chaff-cutter, and then moistened with hot water, becomes soft and mucilaginous, and is highly relished by the stock. Wheat-straw is treated in the same way, but cut very fine, or an eighth of an inch long.

Mr. Mechi's practice.

It is found, however, that cattle will eat straw-chaff, and do well upon a large proportion of it, if the chaff has been simply mixed with pulped roots and subjected to the partial fermentation which takes place in the mass when allowed to lie for several hours.

I do not know any men who deal so successfully with their wheat-straw (as well as barley and pea-straw, which everybody knows the value of) than the best Cambridgeshire farmers. It is a regular thing in that county (and now the practice is rapidly extending) for a compact portable engine and threshing machine to travel with one of Maynard's powerful chaff-cutters. They come into a farmyard, thresh a stack, and next day cut up the straw stack into chaff. This chaff-machine, however, will cut as fast as an ordinary threshing-machine can thresh, and thoroughly sift the chaff from dust at the same time. The

Storing straw-chaff.

Mr. Jonas's  
practice.

late Mr. Samuel Jonas, of Chrishall Grange, Saffron Walden, introduced, or gave notoriety to, the practice of cutting up along with his straw, a small proportion of green fodder, such as rye or tares, 1 cwt. to a ton of straw, while a bushel of salt is sprinkled upon each ton of chaff, to cause a slight fermentation, and to sweeten and preserve the whole. The chaff is trodden down in a barn by a gang of boys, so as to fill the place as solidly as possible, and it remains thus stored for several months together, being stored in spring and not used till October. A very marked superiority is found in the old stored chaff, as compared with chaff fresh cut. It heats considerably, and expands, so that he was obliged to strengthen the walls of his barn and tie them together with iron rods; this expansion showing that some considerable change must take place in the substance of the mixture.

Having a twelve-horse-power engine, Mr. Jonas was able to cut the straw into chaff at once, as it comes from the threshing-machine; which he did with the same hands that would be needed for carrying and stacking the straw. It took three men to straighten the straw in bunches for the cutter, two men to carry it away, and half-a-dozen boys to trample it down. In this way, he chaffed the straw of 8 to 10 acres in one day, at a cost of 1s. 6d. per acre.

The son, Mr. F. M. Jonas, succeeding his father on the same farm, has improved upon the process, as thus described by himself.

"On this farm, which consists of 850 acres of arable land, I cut into chaff every year 100 or more acres of mown wheat or oat-straw, just as described in the 'Journal'; but I use pulped mangold instead of tares, rye, &c., as I can depend better upon the quantity of moisture contained in it; and the improved method costs me less than half what the work used to cost on the same farm as described by my father. In the first place, the three men for moving the straw from the barnworks to the chaff-box are done away with by putting the chaff-box close up to the barnworks, only having a small boy with a forked stick to push the straw to the man feeding the chaff-box. Secondly, I had Mr. Maynard to make a long elevator for the chaff-box, so that it puts the chaff into the barn instead of three men carrying it there in bags. By this means I cut straw into chaff and deliver it into the barn with less hands than are usually employed to stack the straw."

With the use of green crops only, the storage of cut straw could be practised only in the summer months; but with mangold-pulp, the process can be followed all through the principal winter threshing season. The addition of the green stuff or pulped roots causes the straw-chaff mixture to heat. The volatile and odoriferous principles evolved by the fermentation are retained in the straw, which itself undergoes a kind of slow cooking process, and the whole mixture is impregnated with

a very pleasant flavour, not unlike that of good meadow hay. Enhanced value of stored chaff.  
 Analyses of the chaff by Dr. Voelcker give this comparison :—

	Fresh-cut Chaff.	Same after being stored nearly Four Months.
Moisture .. .. .	16·12	12·01
Albuminous compounds .. .. .	4·61	4·17
Mucilage, sugar and digestible fibre	38·29	45·19
Woody fibre .. .. .	33·27	31·10
Mineral matter .. .. .	7·71	7·53
	100·00	100·00

Thus, a considerable proportion of the crude woody fibre had been rendered digestible. Treated in boiling water the change in the assimilable condition of the chaff was shown thus :—

	Fresh-cut Chaff.	Same after being stored nearly Four Months.
Moisture .. .. .	16·12	12·01
Matters soluble in water .. .. .	12·84	22·89
Matters insoluble in water .. .. .	71·04	65·10
	100·00	100·00

Another method of preparing straw as food has been introduced, namely, that of mechanical trituration. Messrs. Ransomes, Sims, and Head, of Ipswich, and Messrs. R. Garrett and Sons, of Leiston, manufacture machines which by a revolving drum or abrading discs tear and rub harsh wheat-straw into shreds until the mass is soft, and in an admirable condition for imbibing the juices of pulped roots, or for absorbing linseed soup, or for being damped and sprinkled with meal. At present, however, the practice of breaking straw, while adapted to Spain and other countries where the straw is of richer quality than in this kingdom, has probably not been adopted in England except by way of experiment. Breaking straw.

*Early Maturity in Beef.*—One of the best illustrations of Fattening! the extending practice of getting off calves to the butcher at yearling cattle. less than two years old, is afforded by the experience of Mr. Howman, of Halloughton, Coleshill, who rears and fattens calves in covered yards. His system is thus described by himself :—

“I keep 15 cows, fairly well-bred, nothing more; and I use a pedigree bull. My stock of calves is made up to 20 by buying my neighbours’.” The



calves are reared, some on skim-milk, and some on new milk, and are enticed to eat as early as possible. About every three months they get an increase of 1 lb. per day in the artificial food, so that at 12 months old the allowance is 4 lbs. per head per day: after that it is increased to 6 lbs. a day, and that is only exceeded as my experience may point out to be beneficial.

"In the summer, grass, clover, and vetches are mown and brought into the yards to them, with long hay; and in the winter, turnips and mangolds, pulped and mixed with straw chaff, with long hay. The artificial food is mixed with the chop, and consists of decorticated cotton-cake, Indian corn, barley-meal, and other tail corn, palm-nut-meal, and locust-bean-meal, all mixed together, and costing between 8*l.* and 9*l.* a ton. You may notice that linseed-cake is not in the list of foods I use, and I may tell you that the only use I make of it is for the youngest calves, and more from a matter of prejudice than because I think it at all superior to the mixture of foods I have named; for I do not hesitate to say, from my experience in meat-making—mutton as well as beef—that the continued use of linseed-cake by farmers, instead of a mixture of cheaper foods, is as unwise as it is extravagant. I do not say that linseed-cake is not a most valuable food in itself, but I say it is too dear; and I go further and say that an equally good result is to be obtained by a judicious mixture of foods, of which decorticated cotton-cake and palm-nut-meal are the foundation, and which shall not cost more than 9*l.* a ton. Now I do not give you this as my opinion only, but I point to the results I have obtained from the two years' experience of early-maturity beef-making under covered yards. In the one year the calves averaged to the butcher, 20*l.* 6*s.* 8*d.*, at 18 months and 1 week old, and last year 14 of them averaged 20*l.* 17*s.* 6*d.*, at 20 months and 1 week old. Now if, instead of using the mixture I have named, I had used linseed-cake, the increased price of food would have been from 25 to 30 per cent., that is to say, the difference between 8*l.* and 12*l.* per ton, and these beasts must have made from 26*l.* to 28*l.* to have paid for the difference in the price of the food. The question is, could I have made them so much better? My decided opinion is that I could not have done so. Well, perhaps you will say that the manure would have been so much better from linseed-cake than from what I used. That is a question that I think has not been yet decided; but, if you believe in Mr. Lawes' Table of the manurial value of the different kinds of food, the decorticated cotton-cake is infinitely superior to linseed-cake. That there is a difference in the quality of manure left from different foods, our practical experience certainly points out; but whether that difference can be accurately measured is not yet certain; but no doubt the experiments that are now being carried out by the Royal Agricultural Society of England on the subject, will be very valuable and exhaustive, and the future generation of farmers will owe a debt of gratitude to that Society for undertaking them. I know that some who have tried the decorticated cotton-cake have not found it to answer, and the reason is not far to seek, for it requires to be used with care and judgment, and never by itself. The stockman must not be allowed to run to the heap and take what he may consider a sufficient quantity; if he does, the result will be indigestion and derangement of the stomach in the beasts; that is my experience in the use of it for the last seven years. It must be mixed with twice the quantity of either Indian corn or barley-meal; and in sending a sample of decorticated cotton-cake to be analysed by Dr. Voelcker, my experience was confirmed by his report, and the valuable advice he gave me in reference to using it; and it is interesting in showing how sound and practical is the opinion of Dr. Voelcker, formed simply from the analysis. He writes: 'Decorticated cotton-cake, in fact, is too rich in nitrogenous compounds to suit, by itself, herbivorous animals; it should be broken up much finer than ordinary oilcake, and then used with twice its weight of Indian corn-meal, or feeding-barley, or any farinaceous meal which is comparatively poor in albuminous matters. A mixture of 1 lb. of decorticated cotton-cake and 2 lbs. of



Indian corn-meal or barley-meal is about the best and cheapest cattle-food which you can buy.' This he wrote to me last February, and what better commentary could you have as to the soundness of Dr. Voelcker's advice than the result of my previous year's feeding of the 14 beasts I have referred to?

"There is one very interesting and important fact I wish to bring before you as a result of the early feeding of these young beasts; it is not an original idea of my own, but one that is too much overlooked, and that is, that the younger a beast is fed, say up to two years old, the greater the average weight of beef per week it will make, and the less food it will take to do it, than is the case with feeding older beasts; and to illustrate this, I will give you the average weight of the beasts exhibited at the last Bingley Hall Show, and compare them with the weight of my 14. Now I do not make this comparison because I think my beasts were as good or as well fed as those exhibited at the Show, but because those weights were the only reliable ones I could get for comparison. In the youngest class of Shorthorn steers, not exceeding 3 years old, there were 7 exhibited, and the average live-weight they made from the day of birth to the date of the Show was 13·76 lbs., per week; the 10 in the class of Shorthorn heifers, not exceeding 4 years old, averaged 11 lbs. per week of live-weight—less than the steers, you see, though heifers are supposed to feed faster; the 7 in the class of Shorthorn steers exceeding 3 years, and not exceeding 4 years old, averaged 11·9 lbs. per week of live-weight. So you see the youngest class averages the greatest live-weight per week, and that you will find to be the rule; the older the beast, the less the average weight made per week. Now, my 14 beasts at 18 months and 1 week old averaged 13·5 lbs. per week, or only  $\frac{3}{4}$  lb. of live-weight less than the average of the heaviest class in the Show, and with how much less food consumed! And if with moderate feeding these animals attained so satisfactory a result at such an early age, does it not show the loss of time, food, and money that must occur in following the ordinary system of feeding, that is, keeping beasts till they are 3 and 4 years old, and then cramming them with more food than they can digest, to 'finish them off' as it is called?"

---

## CHAPTER IV.

### MANAGEMENT OF THE FLOCK.

*Commencement of the Breeding Season.*—It may be just worth Ewes lambing twice in a year. a remark that, by attention and high keep, the ewe will breed twice in a year, and that the practice of obtaining two crops of lambs in a year for fattening was at one time known in Flanders, was also followed by some farmers on the Mendip Hills in Somersetshire, and even now occasionally happens among the Dorset sheep. Instances are known of ewes lambing at Christmas, fattening off their lambs by Lady-day, and producing lambs again in June; of a ewe having lambed four times within 21 months; and probably there are many examples of ewes dropping lambs twice in a year for two years successively. But no such strain upon the constitution of the ewe is either practically adopted in any district, or openly advocated as an advisable method of increasing the supply of fat lambs or stock sheep.

The general practice of English flock-masters may be thus

Selection and  
age of ewes  
for breeding.

described :—Immediately upon weaning the lambs in summer, (which is done at an early period for the purpose of getting the ewes in good condition for breeding), the ewes undergo a very careful inspection; any animal indicating weakness, from age or other incapacity, is removed from the flock and placed on good keeping, to be fattened off for the butcher. No animal of weak constitution, or showing signs of disease of any kind, or possessing any malformation in form or feature, or tumour or ulcer, is retained for breeding purposes; nor is any ewe (unless for some special object) put to the ram after the age of 5 years at furthest. The most common and profitable course is to tup them when yearlings, and sell or feed them off at 3 or 4 years old; as by this means the flock is kept in great vigour, and a sound and strong constitution is preserved. The practice of using ewe lambs for breeding is sometimes adopted, but is reprehensible. A ewe should have attained actual and healthy maturity, namely, about 18 months old, before being put to the ram, so as to be nearly 2 years old when she brings forth her first lamb. By breeding from animals when very young, the whole growth of frame is held back, and the vital powers are weakened.

Age of rams  
used.

The rule is to put every eligible shearling ewe to the ram. Rams are chiefly used as shearlings; older rams being generally such as have come up specially good sheep, or have acquired some fame in prize-lists. With the heavy breeds a disadvantage is experienced from the modern system of feeding up rams till they are too fat to work well. The practice of using ram lambs is less in vogue than formerly, though still common among mountain flocks, as in Wales.

Forwarding  
ewes for the  
ram.

As the time approaches for putting ewes to the ram, and when all danger from drying their milk has subsided, they cannot be put upon pasturage too rich for them, or they are supplied with turnips or cabbages; and the faster they thrive the more security is there for their safety in breeding, for a larger proportion of twins and threes, and the finer, stronger, and healthier single lambs will they produce. At all hazard, and under any inconvenience, the ewes are kept on good pasturage while with the ram. A bite of white-mustard is excellent for forwarding the ewes, and disposing them to take the ram, and is also propitious towards a prolific fall of lambs. The ewes ought to be thus flushed for two or three weeks before the ram goes to them, and the high-feeding should be continued for a few weeks after he has left them.

Matching ewes  
and rams.

Some flock-masters put a number of rams indiscriminately among the whole flock of ewes; giving up all attempts at selection and matching of the dams and the sires according to the deficiencies or superior points of each. But, even when the

produce is to be sold off as lambs for graziers, this is not good management; and the lambs will not possess the level character that is specially prized in lots brought to market. Of course, where the perpetuation of a good breeding flock is the object, the greatest attention is paid to the matching of the ewes.

The time of putting ewes to the ram depends much upon the country and the system of husbandry pursued; in other words, upon climate and upon the farmer's means of provision for the spring. When there is shelter, protection, and a good provision of food for lambing ewes in February and the early part of March, the tupping season begins in the middle of September; in an open or bleak country the end of September or beginning of October is preferred. In the south and west of England, as with the Southdown and Hampshire Down flocks, it is commonly August and September, but in the northern counties, October, when the rams are turned in with the ewes. The Dorset breed ordinarily lambing in December, their tupping season is not later than July; while for raising early house-lambs which, in Dorsetshire, Somersetshire, and Hampshire, are getting fat before Christmas—the bleating of lambs in October and November being a strange sound to a North-country visitor—the ewes are put to the ram in May and June. In hilly, moorland, and mountain districts, the tupping season varies from the latter part of October to the latter part of November, and into December upon the Welsh mountains and the Lake District and Yorkshire fells.

A young active ram is generally put to about sixty ewes, an older ram to about forty. It is customary to ochre the ram underneath, so that progress or want of activity may be watched by the marks left upon the ewes; and calculation as to the fall of lambs early or late in the season is sometimes assisted by using upon the ram red ochre for one week, blue for the next, and another colour for the next.

*Treatment of Lambing-Ewes and preventing Abortion.*—Good managers endeavour to avoid the two extremes of stinting and weakening ewes, and of having them in too high a condition on stimulating food. It is found wise to give turnips or cabbages sparingly, and not to fold in-lamb ewes upon swedes in the pens following hoggetts or other sheep. Swedes and mangolds are best given after lambing. A suitable food for in-lamb ewes is pulped roots mixed with straw-chaff, with hay accessible in cribs, and a daily allowance of a mixture of foods, as crushed oats, beans, malt-coombs, and oilcake. But almost every good farmer has his own system and quantities of extra food for his lambing-ewes.

A well-sheltered lambing paddock, fitted with small straw-

pens or sometimes with low sheds of deal roofed with felt, and a field-house for the shepherd, are commonly provided. And the shepherd has a supply of such medicines as laudanum and linseed-oil, castor-oil, spirits of nitre, Epsom-salts, powdered-ginger, and powdered-chalk; as well as such restoratives and supplementary food for both ewes and lambs, as whisky, gin, gruels, cows' milk, or flour and water sweetened with treacle. It is becoming common, indeed, for owners of flocks and herds to keep proper medicine-chests.

On arable farms, such as on the Cotswold Hills or other situations, where, from altitude, the winter is severe, it is customary to construct a fold-yard, with shelter sheds and abundance of litter, in the turnip-field. Each ewe with her lamb is carefully treated in a small covered pen for three or four days. In bitter weather the lambs are sheltered at nights for a considerable period; and shelter hurdles are always placed about different parts of the field.

Mr. Henry Woods, of Merton, Thetford, Norfolk, agent to Lord Walsingham, has lately collected and published a mass of most valuable information on the management of breeding-flocks and the causes of the prevalent and excessive loss of ewes from abortion—the facts having been gathered from four hundred flock-masters in all parts of the kingdom. In fifty cases of sheep management, where the feeding and results were satisfactory, there were 25,281 ewes; in that number the cases of abortion amounted to 126, and the deaths from all causes during the breeding season were 222. In fifty unsatisfactory cases, there were 21,682 ewes; and in these returns, 22 farmers owned to very heavy losses, while 28 stated a total of abortions amounting to 1884. In 40 of the reports there were totalled 1255 deaths. Thus, 50 satisfactory cases showed one abortion and not quite  $1\frac{1}{2}$  deaths for every 200 ewes; whereas the other cases showed  $17\frac{1}{2}$  abortions and  $11\frac{1}{2}$  deaths for every 200 ewes, though nearly one-half the abortions and one-fifth of the deaths were not recorded.

In a lecture at Watton, on May 28th, 1877, Mr. Woods described the particulars of management of five representative flocks in Norfolk, Warwickshire, Sussex, Kent, and Nottinghamshire, comprising 5109 ewes, in which there occurred only 4 cases of abortion and 31 deaths. He contrasted these with five other and smaller flocks in Lincolnshire, Norfolk, Suffolk, Warwickshire, and Wiltshire, comprising 2240 ewes, in which occurred 576 cases of abortion and 234 deaths.

In his general conclusions, he said:—"A most careful analysis of the returns—in making which I have had some able assistance—shows that sheep fed on turnips *now* are not

Losses by  
abortion.

Mr. Woods on  
preventing  
abortion.



so healthy as sheep were when fed on turnips *some years ago*. As you will have imagined, and as it needs no philosopher to tell you, ewes fed on grass are much more healthy than when fed on turnips.

“It is very evident that sheep are not so healthy as they used to be. One reason is, I think, the land being farmed more highly for turnips; and I have repeatedly remarked that we lose more sheep after a heavy crop of turnips. I do not think the artificial manure of itself is the cause, beyond forcing a turnip into a *bad quality*, which frequently causes us great loss just at lambing-time. I think it must be clear to any person who has followed my remarks in giving details of cases, that swedes are proved to be unhealthy food for breeding-ewes. I might have adduced many other cases from my returns confirmatory of this. In the few instances where the ewes have done well when feeding on swedes, the daily supply has been limited, and there has almost invariably been an allowance of other food—as hay-chaff, with a liberal admixture of bran. I believe that the verdict of a large majority of the thinking and practical farmers and experienced shepherds throughout the country will be this—that if we make it a rule to flush our ewes by stimulating food during the tugging season, to avoid feeding on swedes as much as possible, to limit the supply of other roots as far as circumstances will permit, to give a fairly liberal allowance of digestible, nutritious, and health-preserving dry food, and to run the ewes out on grass as much as possible (taking care never to over-fatigue them) before lambing, there will in future be far fewer cases of abortion and death amongst ewes than we have now to deplore, and many more strong and healthy lambs will be reared than at present. One other point is this. The ewes lost during lambing would appear from my returns to be greatest where short-woolled ewes have been put to long-woolled rams. The evidence, I say, is unquestionable that greater mortality attends lambing where short-woolled ewes are put to large-boned, long-woolled rams, than where the ewes breed after their own kind. Where cross-bred ewes are served by Oxford Down rams, the loss of ewes has been less than in the case of the short-woolled ewes served by long-woolled rams; and I presume the reason is that the half-bred ewes, having their parts more fully developed from the cross, are the better adapted to perform the functions required of them.”

*Raising and Fattening House Lambs*, as practised in the southern counties, from ewes of the Dorset horned breed, commonly using Down or cross-bred rams, is thus conducted. The ewes are brought to take the ram as early as May and June, by feeding them upon trifolium and cut swedes, or mangold

Early lamb.

placed in troughs, giving them also a change on dry pasture for a few hours every day, sometimes half a pint of beans each per day. After the ram is removed, the ewes are changed to a dry pasture, with a fold of tares or other similar forage, and managed as a store flock, without being too highly kept—the object being to keep great numbers and eat the ground bare. The travelling consequent upon daily removal to fresh food is a very beneficial exercise, insuring a healthy offspring. The lambs fall in November and December. Owing to the mildness of the climate in that part of England, it is not generally necessary to resort to the lambing-yard. A shifting fold is used, removed to dry ground each day; a shed being requisite for weakly lambs, in case of very wet and stormy weather.

Italian rye-grass (sown on a portion of the wheat stubble) receives the ewes and lamb; but they also range over the wheat stubble at night, and on young clover by day, to avoid injuring the clover plant, and to have a good layer for the lambs. The ewes are kept thus till the lambs are four or five weeks old. At one month old the male lambs are castrated by cutting and searing, which is found to be safer and to give a more fleshy lamb when arrived at maturity, than the plan of drawing when the lamb is a week or ten days old.

The lambs, being a month old, are taken with their dams to root-feeding, for the sake of keeping up the condition of the ewes, which are being simultaneously fattened. The roots are cut and given in troughs, and the lambs fed in advance of and separate from the ewes,—a lamb-gate being provided for the purpose, having a space between the bars to allow lambs to pass, without being wide enough for the ewes. As soon as it is light in the morning, the shepherd gives hay to both lambs and ewes, and then fills the troughs with cut roots, passing the lambs' portion twice through the cutter, reducing the slices into bits the size of dice. Next, he gives oilcake and peas in covered troughs, the allowance being as much as they will eat. To prevent waste, the oilcake is broken fine—the size of horse-beans—so that the lambs do not take up large pieces and drop them beside the troughs. To induce the young animals to eat cake and peas, it is sometimes necessary to mix a portion of common salt. The ewes next receive their portion of oilcake, *without* peas, beginning with  $\frac{1}{4}$  lb. per day—half in the morning, half before the bait of roots at night. After two or three weeks of this food, the cake is gradually increased up to 1 lb. each per day; and towards the end of the fattening process, half a pint of beans is added. This renders the flesh more firm; the great objection to ewes being fattened while suckling being that they are mostly deficient in firmness and quality of meat.



Hay or hay-chaff, also, is given to the lambs twice-a-day ; but after eight or nine weeks old, they have it three times a day—the last feeding being not later than three o'clock, as the hay not eaten will be spoiled in case of rain. The portions of hay, after having been picked over by the lambs, go to their mothers. The lambs are ready for the butcher at ten or eleven weeks old.

*Summer treatment of Flocks.*—Ewes, with their lambs, are thinly stocked upon the sweetest and best suckling (not the rankest fattening) pastures which the farm will afford, or upon young seeds where permanent grass land is not available. The lambs, after having recovered from the sanguinary, but partly indispensable and partly fashionable, operations of castration, tail-cutting, and ear-marking, at about ten days to a fortnight old (though castration is now becoming more usual at two months old, by the process of searing and the use of blue ointment and lard), and after having grown strong upon their mothers' milk, roam in search of such natural grasses as instinct appears to direct them to for their better sustenance. At any rate, the more spacious pasture room they have to range over the better they prosper. The ewes, with all good managers, are well fed with cake and corn in addition to roots and hay, or what provender forms the bulk of their food in the early spring.

Grazing ewes  
and lambs.

The management of the Hampshire and Wiltshire Down lambs offers one of the very best examples of judicious feeding that can be found. The primary object being to get the lambs to the market in the autumn, no expense is spared to provide frequent changes of food. As soon as the lambs can eat, they are allowed corn and cake in troughs in front. After the turnips are eaten, the flock is placed on water meadows by day, and on late swedes, if any remain, at night ; then on rye and winter oats, Italian rye-grass, &c. If there are no water meadows, a portion of the clover layer forms excellent food ; and this should always be folded off, the lambs having the front pen. At this time they will eat a considerable quantity of food. There are two plans ; either to keep the ewes in close quarters, having a lamb pen a-head, and shifting often twice a-day, or else to let them hie back on the land they have already cleared. The first plan, according to the Editor of "The Sheep and Pigs of Great Britain," is, on the whole, preferable, and may be safely carried out, when the sheep have a night change. If, however, the farmer is necessitated to keep them entirely on the seeds (which of course is very undesirable), more room is necessary ; but even then he must not keep them on the ground long, otherwise lambs eat the young shoots and scour. By going rapidly over the surface (that is eating down close), and then passing on, the plant grows again evenly, and in due time another crop is secured,

Hampshire and  
Wiltshire  
management.

either for the ewes or for hay. It is at this time, when the sheep are on clover, that sliced or pulped mangolds prove of great value. They contain at this season much sugar, and correct the laxative tendency of the clover. Mr. Rawlence's practice, as described by Mr. H. M. Jenkins in his Report of the Bulbridge Farm (in the Society's 'Journal'), may be cited as an instance of successful treatment. Mr. Rawlence being a breeder of rams, a forcing system was adopted. "After lambing, the ewes get mangolds with hay-chaff, for about ten days in the lambing-pens, and, in addition to this food, the ewes with tup-lambs or with couples, get either one pint of oats or one pound of cake; but unless roots are scarce, the remaining ewes are denied artificial food. At the expiration of ten days or a fortnight, the ewes and lambs go on turnips, and remain there till March 20th. About this date the ewes and lambs go into the water meadows by day, and are folded at night on swedes, for the first fortnight or so, and afterwards on Italian rye-grass, or occasionally on rye and winter oats, which have been sown where rye-grass has failed. This treatment is continued until the middle of May, when the lambs are weaned." Vetches, however, are most valuable food for sheep on arable land. By sowing successive crops in the autumn and early spring, some flock-masters secure continuous food from May to August; and lambs thrive very well on such food when taught to eat it. Cotswold lambs are frequently weaned on vetches, the ewes being removed to a short pasture; or, as is the practice in Hampshire, leaving them to follow, only doubling the line of separating hurdles.

Shearing the ewes early in June, or somewhat earlier or later according to climate and locality, generally causes both mother and offspring to improve rapidly in condition; and it is a good practice, not invariably followed, to dip the lambs immediately after shearing time, to destroy parasites which, by causing a high degree of continued irritation or perhaps torment, hinder the growth of lambs more than is commonly imagined. Indeed, the number of deaths occurring from lumps of wool in the stomach resulting from lambs biting themselves, and again, the great extent to which scour, and perhaps the development of intestinal worms, arises from the misery inflicted upon the helpless young animals by ticks and lice, appear to have determined the most careful as well as most humane flock-masters to make use of dipping more frequently than was usual a few years ago. This subject of dipping, along with pouring and smearing, will be referred to further on.

The beginning of July is perhaps the most general time for weaning; though in the sunny south it is June, and in some districts often in May. Experiments made with Leicester lambs

Mr. Rawlence's  
practice.

Shearing ewes  
and dipping  
lambs.

Time for  
weaning.

by the late Mr. Pawlett, showed a gain of 4 lbs. weight per head in one month from weaning on the 10th of June instead of the 10th of July; and the two lots, fed together till the following February, gave a weight of  $5\frac{1}{2}$  lbs. per head in favour of the earlier weaned.

Where the state of the pasturage will allow, the ewes are taken away from the lambs, leaving the young animals for a time in the fields to which they have become accustomed. The ewes are placed for some days upon a piece of bare grass, with a view of quickly drying up their milk; and it is common to draw their udders once or twice. An old plan, still maintained in Wales, is to mix a portion of ewe's milk with cow's milk, and therewith produce an excellent ewe-milk cheese. Mode of weaning.

The lambs thrive best when frequently shifted to fresh grass or other herbage, as grass aftermath or clover, which must not be rank, strong, and succulent; and they should always be thinly stocked. In August they are upon clover allowed to grow almost up to its second flowering, or upon sainfoin, or trefoil, or rye-grass, with a bite of vetches or rape for only part of each day, lest they should over-eat this succulent food. Sometimes a moderate allowance of cabbage is carted to them; and they have access to water and to lumps of rock-salt, which are a health-requisite in the sheep pasture or fold. In August and the early part of September, the young sheep are prepared for their winter food, either by gradually breaking them to a fold of rape or white turnips for a few hours daily, with hay, or cut-chaff, or cut oat-straw, in cribs, or by carting turnips to them upon their pasture before they are confined upon the field of roots altogether. Grazing lambs.

And it is at this period that linseed-cake, or, still better, the astringent decorticated cotton-cake, or a mixture of bran and cake, or of malt-coombs and cake, up to  $\frac{1}{2}$  lb. per head per day, is found of greatest value. Preparing lambs for winter food.

For destroying parasitic insects, curing scab, and promoting the growth and good quality of the wool, several processes are adopted; namely, "dipping," in which sheep or lambs are immersed, all but their heads, in a liquid in a bath-box, and then held upon a draining rack till the surplus of dripping liquid has run back to the bath; "bottling," in which the liquid is applied to the skins of long-woolled sheep by opening the fleece with a stick, and wetting the skin from a glass-bottle having a channel cut in the cork; "pouring," in which the fleece is divided by thumb and finger in "sheds" in several parts of the body along the whole length of the sheep, and pouring on a mixture out of a can with a long spout; and lastly, "smearing," in which ointment is rubbed on the skin by the finger along opened sheds in the wool. Dipping.

One period for the operation is early in summer, Bottling.

Pouring.

Smearing.

when the ewes have been shorn; another in the fly season in midsummer; another in September, another in November; while dressing by the bottle is sometimes requisite in February.

Dips. Arsenical dips, being dangerous, are not so much employed as formerly; compounds of tobacco-juice, hellebore, and other vegetable poisons, with sulphur, soap, soda, &c., are more largely used; but of late years dips prepared with carbolic acid, or otherwise obtained from tar, have come into great favour; some of them, however, while effectually killing all skin parasites, cleansing the skin, and by the after-smell warding off flies for a considerable time, have the misfortune to discolour the wool. The most widely-known dips are Bigg's, McDougall's, Long's, Reid's, Cooper's, and the Glycerine dip; while Little's Chemical Fluid, the latest invention of this class, possesses all the qualifications required in a perfect dip. For both pouring and dipping mixtures, oils are to some extent employed; chiefly on mountain farms. It is mainly in Scotland that smearing or salving is still practised upon high mountain grazings as a defence against the wet and cold of winter. The smear is a compound of American or Archangel tar and grease-butter, sometimes with a portion of Gallipoli oil. Mercurial ointment is still believed by some farmers of the old school to be the best remedy for scab; but its use is now very limited.

Smear.

Ointment.

Time for shearing. The time for shearing has altered considerably of late years. Before Mr. Coke, first Earl of Leicester, commenced his celebrated Holkham sheep-shearings, or the Duke of Bedford his agricultural gatherings, under the same designation, at Woburn, it was the usual custom to clip between the 1st of June and the 1st of August. Since the establishment of the Royal Agricultural Society, the time has gradually changed to the 1st of May, for early clipping; sheep for Show purposes are shorn still earlier; and very few flocks are left unshorn after the 1st, or at most the 2nd week in July. Mountain sheep, as the Cheviots and Welsh, are shorn in July, and some as late as August. The time depends, of course, very much upon the season and the state of the flocks, as well as upon the breed and locality. If the season be cold and the flock in poor condition, it is deemed better to wait for sunny weather; but if the weather be warm in early summer, the sooner the sheep are out of the wool the faster they make mutton.

Sheep-washing. Sheep-washing before clip-day, though generally conducted in a primitive manner, has received greater attention of late years. Except in hilly districts where running waters abound, the process is not now performed by men standing up to their middle in a running stream, and plunging, sousing, and rubbing the sheep one by one, as caught and passed to the bathers for that

purpose. Washing is something more than merely dissolving and rinsing out sand and dirt from the fleece; the yellow greasy secretion, or "yolk," forming a natural soap of oil and potash, unites with the water in a proper washing reservoir, in which soft water is dammed back or detained, and acts as a powerful cleanser and whitener of the whole fleece; and hence arrangements of the kind are becoming common. Sufficient time, say four or five minutes for each sheep, is allowed for soaking; and it is found that the liquor in which a considerable number of sheep have been washed acts almost like soapsuds in removing impurities from the wool. In some places a proper wash-pit of brick-work, with water-tight boxes for the workers to stand in, and a long swim for the sheep, with gravel bottom and gradually shallowing mouth or exit, is constructed. In districts where brooks are not available, large ponds or pools are utilised, a stage is made over the water for "dyking" the sheep, and a vat and swim are arranged by fencing off a portion of the area with posts and ropes along the water-line. The washer stands in a suspended tub, and the sheep are guided in their swim and their heads are held above water by a long handle carrying a cross-piece. Many flock-masters, at least among breeders of Lincoln heavy-woolled sheep, have now adopted the vat-system, in which the sheep are thoroughly well washed in a large rectangular wooden vat partly sunk in the ground, a portion of soft-soap dissolved in boiling water being mixed with the water in the vat. As much as 2s. per tod (28 lbs.) being the difference in value between well-cleansed and badly-washed wool, this extra carefulness in the process is found to pay.

Ten days or a fortnight, according to weather, elapses between washing and shearing, so as to give the yolk time to rise again, and thus prevent serious loss both from diminished weight of fleece and increased harshness in its handling.

Clipping is usually done by the sheep being laid on clean grass, or upon coarse cloth or canvas sheeting spread on the ground; but, with the bigger breeds, a raised clipping-board or stage is employed; and some of the mountain sheep are laid, with their legs tied, upon a long stool, on which the shearer also sits.

*Winter Management of Flocks.*—I have spoken of breaking-in sheep to their winter food. But, for a time after they have been nominally confined to turnips, it is considered good management to remove them to grass at nights. When finally folded upon the root-crop, it is common to remove sheep in wet weather, except upon very light dry soils, or upon heavy-land farms in some counties where straw is used in considerable quantity for bedding the folds; and it is a practice largely followed to allow a range over a stubble or other field in con-

Winter  
folding.

nection with the fold on turnips. The plan of inclosing a portion of the turnip-field, sufficient for several days' consumption, and permitting the sheep free walk over the whole area, is not often followed, except sometimes at the commencement of the season, or for hoggets. The general practice is to inclose a fresh portion of the crop sufficient for one day's consumption, not always of a uniform area or carrying a similar quantity of roots, but regulated to some extent according to the dieting of the animals as well as the state of the land and the weather. The flock is permitted to roam over the cleared portions; the fold increasing in space, but being often limited by the length of fencing available. Young or hogget sheep never follow after ewes or fattening wethers, except under rare circumstances; and it is usual for tegs to occupy the most forward inclosures and always to begin the new plots of roots, while the older sheep follow in a second fold to clear up the hulls.

Hurdles and  
nets.

The fencing employed varies in different parts of the country. In many parts of England, where copses prevail, the hurdles are cheaply made on the farm, of wattled or woven hazel, and are held upright by strong stakes or "shaws," to which the hurdles are hung by "shackles." In other parts they consist of wooden bar "trays," the ends or heads having long points which are driven into the ground by a mallet or "beetle," the holes in some soils being opened for them by a pointed iron bar. On shallow soils, particularly in the north, a short-footed hurdle is used, held in an inclined position by a stay or prop, with a "stob" or pin driven into the ground. And either alone, or in conjunction with trays, dressed yarn netting, of large mesh, supported by stakes, is used in many localities, as being cheap in first cost and removable with little labour. Iron hurdles upon small wheels, expensive at first purchase, but economical from their great durability, are becoming adopted by high-class farmers; their use being especially in favour for hurdling off clover and other grazings when the ground is baked hard and ordinary hurdles can be shifted only with difficulty.

Storing, clean-  
ing, and  
cutting roots.

Cleaning the roots by topping and tailing, slicing, and feeding in troughs are practices which prevail over most parts of England, more especially in the consumption of swedes. But these practices are by no means universal. Thus, the Hampshire and Wiltshire method is to let all sheep, even the ram tegs, cut their own turnips, which, however, are pecked up loose out of the ground for them. The cost of getting into heaps and cutting is avoided, and the sheep certainly do not injure themselves by over-eating roots—a frequent cause of abortion in ewes; but then the custom is to supplement the root food by supplying large quantities of sainfoin and clover-hay in racks, in addition



to the cake and corn given in troughs. As a precaution against frost, portions of the root-crop are commonly (though not in all parts of the kingdom) pulled and stored in the field, either by being thrown into heaps and then covered down with straw, stubble, or earth, or a covering of earth over straw, or by laying a few rows together and turning the soil up against them with a plough. Care is not always taken to cut off the tops a day or two before the sheep go on, as a precaution against frosted tops; and another point not attended to so generally as by the best flockmasters, is easing the change from white-fleshed turnips to yellow-fleshed hybrids, and, of still more importance, to the later diet of swedes, by mingling a proportion of the next food in the cutter during a few days before the replacement of one by the other has to be made entirely.

In the latter part of the winter, when the swedes are coming to an end and mangolds are resorted to, great care is taken to change the keep frequently—plots of winter barley and other bites of green stuff being frequently provided; and the supply of dry food, of linseed or cotton-cake, or cake and meal, is more liberal.

During the entire winter it is almost universal to keep the folds well supplied with hay and straw in racks or between hurdles, or cut into chaff and given in troughs; and a lump of salt in a covered tub or trough is not neglected. On some heavy lands it is customary to bed down portions of the fold with straw in a rainy time. Shelter is generally provided by making low walls or racks of straw between open-framed hurdles; and often, in exposed situations, light field sheds, of posts, hurdles, and straw, are put up. In the case of large flocks, the shepherd frequently has a wooden hut or house on wheels; and where lambing takes place in the fold, he has his bed there, and a fire. Where large lots of fattening sheep are being folded, they are watched by night as well as day, and the field-house serves as a butcher's-shop for instantly slaughtering and hanging-up any fat sheep which may be found threatened with inflammatory or other dangerous disease.

Great attention is paid to the flock, especially to hoggets, throughout the winter, to forestall disease by administering alterative or diuretic drinks, and to counteract over-feeding with roots by occasional removals to pasture. Paring the hoof and applying a caustic dressing for foot-rot is a part of the shepherd's care, often laborious and almost incessant upon soft lands and with heavy sheep. Long-woolled sheep are troubled with clots or balls of hardened soil and dung, hanging to their wool behind, which, at the close of winter, are removed by the shears.

On hill or mountain farms, permanent stone-wall shelters are

provided as a protection from snow-blasts; and both roots and hay and corn are carried to the sheep in the least exposed situations.

Wintering  
sheep in yards.

Mr. Ruston's  
practice.

On clay-lands, the system of wintering sheep in yards having sheds is extending in favour. The experience of Mr. Alfred S. Ruston, at Chatteris, Cambridgeshire, may be quoted on this practice. He made very close observations with 600 to 700 sheep in yards, valued them in and out of the yards, kept a strict diary, calculated the cost of artificial food, noticed what quantity of straw they made into manure, and also the quality of the manure. He says, "I find 6 lamb-hoggs tread down as much straw, and make it into as good manure, as a 12*l.* or 14*l.* bullock. I put the sheep into my ordinary straw-yards, and always reckon 6 sheep for a bullock; so that where I should have had 10 bullocks I put 60 sheep. I find it is very essential to keep a thin layer of dry straw over the yard. In wet days, we litter them twice a-day, and on fine days once, but only use a very small quantity at a time; this just keeps the heat of the manure from rising to injure their feet, and prevents them from treading on wet straw during the day. In one whole winter I had not more than a dozen lame sheep in the yards, and there were far fewer cases in the yards than there were before the sheep came in. When they first come into the yard, and until the end of February, we give them a larger quantity of dry food. They pick the bedding-straw over, and, when practicable, have a stack or good heap in the yard to run to. We also cut them chaff, hay and straw together, feeding them with it several times a day. We give them mangolds (turnips and swedes not being produced extensively on the fen-lands) twice or thrice a day, taking care that the quantity is not such as to make the sheep scour. As the days lengthen, after the end of February, we increase the quantity of roots and reduce the supply of dry food. I find that an acre of mangolds of an average crop will carry 25 lamb-hoggs, say from the beginning of December to the beginning or middle of April. Old sheep will consume more; there may be 20 sheep per acre." Mr. Ruston reckons the profit (or return for the natural food after the artificial is paid for) on a bullock to be 30*s.*; on 6 sheep, no less than 3*l.* 18*s.*, leaving in each case the same value of manure.

Mr. Randell's  
practice.

Mr. Charles Randell, of Chadbury, Evesham, Worcestershire, has frequently wintered ewe-tegs in straw-yards, and avoided lameness; the only precaution necessary being to litter with straw daily, but only just so much as is necessary. In this way the manure is so consolidated by treading, that little fermentation goes on, and the cause of foot-rot in yards is avoided. But

a distinguishing feature in his excellent and, indeed, model practice is the wintering of tegs in yards having sheds, the floors of which are covered with burnt soil. This is added as often as needful, from October, when the sheep go into their winter quarters, till the end of April. It accumulates till it is often  $\frac{3}{4}$  feet deep, and is turned over by degrees, as it becomes saturated with urine and dung. This serves a double purpose—preserving the feet of the sheep against foot-rot, and making a valuable addition to the artificial manure-compost for the root-crops. Burnt soil not being always available for bottoming the yard outside the sheds, straw is used; and when neither can be spared, Mr. Randell has recourse to tan. The feet of the sheep are pared every six weeks. Their food is pulped mangolds, wheat-chaff, and malt-dust, as one mixture; clover, chaff, Indian corn, and cotton-cake, as another.

*Fattening Sheep in Sheds* is practised to some extent, though not very generally, excepting for Show purposes. The most common bed for sheep-houses is straw, freshly littered at frequent intervals, and in small quantities—no more than sufficient for keeping the sheep clean. But some few feeders employ a flooring of boards or spars, having  $\frac{3}{4}$ -inch-wide openings between, through which the droppings pass into an excavated pit below, the floor being in compartments readily lifted for the purpose of occasionally strewing peat-earth, sawdust, or other dry absorbents upon the accumulating manure. The food is green stuff, as clover or tares; and, in winter, cut turnips or mangold, commonly from 14 lbs. up to 28 lbs. per sheep, with hay and chaff, and oilcake, beans, peas, or oats, in various mixtures, from  $\frac{1}{2}$  lb. up to 1 lb. or  $1\frac{1}{2}$  lb., per head per day. The sheep must have access to water.

Shed-feeding  
sheep.

According to Mr. Mechi, a general practical rule is that about 7 lbs. of rape-cake, linseed-cake, or beans, will make 1 lb. of mutton. Experiments made by Mr. Lawes, upon sheep of various breeds, brought out the conclusion that sheep well fed under cover increase weekly about 2 per cent. upon their live-weight; and they will consume about 70 lbs. of roots,  $4\frac{3}{4}$  lbs. of hay, and  $4\frac{3}{4}$  lbs. of cake, per head per week, for every 100 lbs. of their live-weight.

## CHAPTER V.

### MANAGEMENT OF PIGS.

ON almost every occupation in the kingdom, whether the cottager's plot, the grass dairy-farm, the large corn-farm, or even the hill sheep-farm, swine form a more or less important

part of the live stock ; sometimes reared and sold as sucklings and porkers, sometimes fattened on a large scale for bacon, and sometimes bred and disposed of as stores, or kept merely as manure-makers in the straw-yard.

Housing pigs.

The best practice in the housing of pigs is summed up by Mr. J. Bailey Denton thus : " Keeping the boar in a detached building, separated from the other swine ; arranging the sties with feeding-passages under cover for farrowing sows and fattening hogs, and both with access to open yards ; and constructing the sties with an impervious floor, so that they may be cleared of all filth."

Boars housed singly, have room enough in a sty 6 feet square, with a small side yard in addition. A sow requires a space of 10 feet by 6 feet, and a separate yard accessible to the young pigs. When used for fattening hogs, such a sty accommodates four or five.

Arrangements  
and fittings  
of sties.

For feeding-troughs iron is the best material ; and it is usual to have a swinging flap from the top of the dwarf wall in which the trough is set, so that the bottom edge can be closed by bolt against either the front or back edge of the trough as desired. By this simple device, the pigs are excluded from the trough while their food is being placed in it. To prevent the smothering of young pigs by being overlaid by the sow, an excellent contrivance is a bar or rod, placed about 8 inches from the wall all round the sty, and about 8 inches from the ground, thus providing a space for the escape of the little pigs between the wall and their mother.

An impervious floor, cleaned by frequent washing, subdues the objectionable effluvium from warmly housed swine ; but the building must be thoroughly ventilated, either by raised ridge-tiles or openings in the roof.

Age of sows at  
commencement  
of breeding.

The sow is commonly taken to the boar when ten to twelve months old, and as young as eight months in the case of a choice early maturity breed ; and the general practice is to have two litters in a year, namely, in spring and in autumn, avoiding the hot summer weather for farrowing, and also the winter, except when the object is to sell sucking pigs in that season. Sows are seldom kept after they are three years old.

Farrowing.

As to care and attention at the time of farrowing, it is the practice of some of the best managers to allow only a very small quantity of litter in the house or pen, to prevent perhaps an accidental smothering of the pigs. A basket with straw and flannel lining is provided, and fenced off from access by the sow ; as the pigs come they are placed in the hamper and covered up warmly, and they are all given to the sow when the farrowing is concluded. Her first food is milk and bran or pollard, given warm ; but in a few days she returns to her ordinary food.

One of the most eminent breeders of show-pigs commences Feeding young pigs. the artificial feeding of the young pigs at five or six days old ; giving them warm milk mixed with fine sharps, and a small quantity of whole maize. Castration is performed at about six weeks old, and at two months old the animals are weaned. For the first few weeks after weaning, they are fed very often, care being taken that they clean out the troughs after each meal. The food is warm in winter, but not in summer ; and consists of wheat-, maize-, barley-, oat-, and other meal, mixed and wetted with a little cold water, then scalded with boiling water, and sprinkled with salt. Between the feeds, the pigs have whole maize, and mangolds or swedes cut small. Another breeder gives his little pigs meal or whole oats, also ground lentils and oats, and a small proportion of sharps, given wet ; and they have barley and maize after they are three months old. On dairy farms, whey and butter-milk, and on other farms, wash and refuse kitchen-stuff, form an important part of the diet of both young and older pigs.

Store pigs are kept in open yards, sometimes herded during Management of store pigs. the day upon the fallows in spring and early summer, sometimes grazed upon pasture (mischief from their rooting being prevented by ringing), and generally driven for some weeks upon the autumn stubbles. But wash and mangolds, supplemented on many farms by cabbages, and by grasses and green crops cut and carried to them in the yards, form the principal summer food of store pigs, in addition to what they pick up of the farm refuse. In winter they thrive upon what the cattle leave in the straw-yards, with an addition of roots and corn.

Mr. C. S. Read, in his Report on the "Farming of Oxfordshire," described the very important part performed by pigs in Mr. C. S. Read, M.P., on store pigs. making farmyard-manure. On arable land where they are kept as stores, they are generally bought in twice a year—January and June. From twenty to forty pigs are kept in a straw-yard, and are supplied with swedes and mangolds, and one pint each of old beans daily. At first the beans as well as the roots are scattered all over the yard, and the pigs, being thin and active, root over the straw and thus improve the manure. But as they become less active, the beans are thrown on a clear spot. The pigs that are bought in January will be ready to go away in May, and the summer ones will be cleared out by Christmas. They pay better than sheep in proportion to the expenditure on food ; for a teg will often not sell for more, after five or six months' feeding, than a store pig which cost half the money.

Feeding young porkers to be killed at four or five months old, Fattening pigs. and fattening bacon-hogs at twelve up to twenty-four months old, are conducted upon the same general principles as to warm

housing, regular feeding, and a diet of roots and meals, with wash, skim-milk, butter-milk or whey—the roots much more frequently boiled or steamed than pulped, while it is usual where the meals, or a portion of them, are boiled, to finish off the fattening with raw meal. The varieties of practice in feeding pigs are innumerable. In some districts boiled potatoes and barley-meal are the principal food; in others, milk-whey or butter-milk, with brewer's grains, or a mixture of barley-meal, oatmeal, and Indian corn meal; in some cases the animals are fed on peas, in other cases on buck-wheat. But it is generally agreed that pig-feeding does not yield a profit except in the shape of the resulting manure.

*Note.*—The management of Horses is described in the Chapter on "Motive Power."

## CHAPTER VI.

### BREEDS OF CATTLE, SHEEP, PIGS, AND HORSES.

#### CATTLE.

Shorthorns.

*Shorthorns.*—This breed, one of the chief glories of English agriculture, is the product of a hundred years of improvement (indeed, it is exactly a century since "Hubback," the famous sire belonging to the Messrs. Collings, was calved), and originally sprang from Yorkshire and Durham. It now distinguishes no particular counties; for while in the north, in the east, and in the middle of England, it has displaced or amalgamated with and improved other breeds, it has established itself in the south and west; and it may now almost be said that other varieties of cattle hold their ground in excepted counties and districts where Shorthorns do not prevail. There are some 700 or 800 pedigree herds in the kingdom; probably as much as 200,000*l.* worth of pedigree breeding stock is annually disposed of by public auction and private contract; and high prices are given for bulls and dams by breeders from all the countries of Europe, from our colonies, and from America.

Prices made.

Mr. John Thornton's 'Circular; a Record of Shorthorn Transactions,' gave a summary of sixty-four auction sales of 1876, in which 2802 head of bulls and females realised 145,655*l.*, an average of 51*l.* 19*s.* 8*d.* per head. The list does not include the Scotch or Irish draft sales of young bulls and heifers. It was about 800 head more than in any year before 1875; and for prices the sale season of 1876 was looked upon as one of depression, the foreign market being very flat, espe-



cially as the Australian Colonies were closed against British live stock. The highest price of the year was 2000 guineas for a dam at Mr. W. Angerstein's sale: 1250 guineas were given at Mr. E. J. Coleman's; 920 guineas at Mr. J. P. Foster's; and 800 guineas at Mr. W. W. Slye's sale. Mr. Slye's twenty-two animals averaged 199*l.* 15*s.* 9*d.* each; Mr. Angerstein's forty-three animals averaged 197*l.* 11*s.* 5*d.* each; Mr. J. P. Foster's forty-four lots, 165*l.* 1*s.* 9*d.* each; Mr. E. J. Coleman's forty-three lots, 133*l.* 0*s.* 8*d.* each. Two animals were previously sold for 3000 guineas each. In 1877, at fifty-seven sales, 2455 head realised 134,372*l.*, being an average of 54*l.* 14*s.* 8*d.* per head. Some of the sensational figures given may be here recorded. At the Bowness sale of Mr. J. D. Cochrane's Shorthorns from Canada, the Earl of Bective gave 4300 guineas for "5th Duchess of Hillhurst," and Mr. Loder gave 4100 guineas for "3rd Duchess of Hillhurst." The Duke of Manchester purchased "Duke of Underley 3rd" for 3000 guineas. Mr. Allsopp has lately given the Earl of Bective 7500*l.* for two females. At the Earl of Dunmore's great sale, Mr. Larking bought the bull "3rd Duke of Hillhurst" for 3000 guineas. At the renowned New York Mills sale, "10th Duchess of Geneva" was sold for nearly 7000 guineas; the Earl of Bective there gave 3000 guineas for "8th Duchess of Oncida;" and Lord Skelmersdale purchased "Duchess of Oneida" for 6000 guineas, afterwards selling her first produce, a bull calf, to Mr. Foster for 2000 guineas, and refusing 5000 guineas each for her son, daughter, and granddaughter. Colonel Gunter sold "5th Duke of Tregunter" to the Earl of Feversham for 2000 guineas; and sent another dam to America for 2500 guineas. Prices like these have been frequently made and as high offers declined by Mr. T. C. Booth, for such dams as "Lady Fragrant," "Bracelet," and other Warlabys of equal lustre. And Colonel Towneley's "Butterfly" bulls and females commanded similar sums.

At Mr. E. H. Cheney's sale in September 1877, twenty cows and heifers sold for 10,527*l.*, and five bulls for 7896*l.*; "13th Duchess of Airdrie" making 2200 guineas; "13th Lady of Oxford," 1900 guineas; "10th Maid of Oxford," 1605 guineas; "11th Maid of Oxford," 1400 guineas; and the bull, "7th Duke of Gloucester," 1850 guineas. At Messrs. R. E. Oliver and R. Loder's joint sale in the same week, "Grand Duchess 29th" was sold for 2450 guineas, "Cherry Duchess 1st" for 1800 guineas, and "Grand Duke 34th" for 1550 guineas.

So diffused are the Shorthorns throughout the kingdom, that they appear at most English cattle fairs, though the grandest displays are in the northern counties.

Eminent  
breeders.

Pre-eminent among Shorthorn breeders at the present time are Mr. Thomas Christopher Booth of Warlaby, Colonel Gunter of Wetherby, Captain Cheney, the Earl of Dunmore, the Rev. R. B. Kennard, the Marquis of Exeter, Lady Pigot, Lord Fitzhardinge, Mr. John B. Booth of Killerby, the Duke of Devonshire, Mr. G. Drewry, Mr. G. Fox, Lord Skelmersdale, Lord Penrhyn, Mr. J. W. Larking, Mr. Hugh Aylmer, Mr. S. E. Bolden, Mr. Allsopp, Mr. Ashburner, Mr. J. N. Blundell, the Earl of Bective, Mr. R. Loder, Mr. Graham, Colonel Kingscote, Mr. R. E. Oliver, Messrs. Cruickshank, Mr. E. Bowly, Mr. D. McIntosh, Mr. J. P. Foster, Mr. Slye, Mr. J. How, Mr. H. Salt, Mr. T. Lister, Mr. E. J. Coleman, Mr. J. Robinson, Mr. Angerstein, Messrs. Dudding, Mr. J. Lynn, Mr. G. Garne, the Earl of Zetland, Mr. J. Outhwaite, Mr. T. H. Hutchinson, Mr. W. Linton, Mr. Richard Stratton, Mr. F. J. S. Foljambe, M.P., Sir Walter C. Trevelyan, Bart., the Rev. John Storer, Colonel Towneley, Mr. Oriel Viveash, Mr. Joseph Stratton, Lord Sudeley, Mr. B. St. John Ackers, Mr. W. Foster, Mr. James Bruce, the Duke of Northumberland, Mr. John Torr, M.P., Mr. Thomas Willis, the Earl of Feversham, Mr. C. Leney, Mr. W. A. Mitchell, Mr. T. H. Bland, Mr. T. H. Miller. But in naming these breeders from among many other owners of excellent Shorthorn herds, I make no attempt to arrange the list in any order of celebrity.

In describing the points of the breed, I cannot do better than follow in the main the high authority of Mr. Henry Strafford, the ex-editor of 'Coates's Herd Book' which has now been transferred to the Shorthorn Society.

Mr. Strafford's  
description of  
a Shorthorn.

The bull's head is short, but, at the same time, fine, very broad across the eyes, but gradually tapering to the nose, the nostril of which is full and prominent; the nose itself is of a rich flesh-colour, neither too light nor dark; eyes bright and placid, with ears somewhat large and thin. The head, crowned with a curved and rather flat horn, is well set on to a lengthy, broad, muscular neck; the chest wide, deep, and projecting; shoulders fine, oblique, and well-formed into the chine; fore legs short, with the upper arm large and powerful; barrel round, deep, and well-ribbed up towards the loins and hips, which should be wide and level; back straight from the withers to the setting-on of the tail, but still short, that is, from the hip to the chine, the opinion of many good judges being that a beast should have a short back, with a long frame. As a consequence of this the hind-quarter itself must be lengthy, but well filled-in. The symmetry of frame of the Shorthorn is near perfection, while few animals handle so well, with so fine and mellow a touch. The hair is plentiful, soft, and mossy, with a hide not too thin, and in fact, somewhat approaching the feeling of velvet. Colour

varies, ranging from pure white to a bright or rich red. The most fashionable of all is a mixture of the two, forming a deep or light roan, sometimes called hazel, or strawberry.

The cow has much the same characteristics, with the exception of her head being finer, longer, and more tapering; the neck thinner and altogether lighter, and her shoulders more inclined to narrow towards the chine.

Like most well-proportioned animals, the Shorthorn often looks smaller than he really is. The rapidity with which the Shorthorn puts on flesh, and the weight he frequently makes, are such that it is not uncommon to see steers of four to five years old weighing 140 imperial stones—many as high as 150 stones—dead weight. Weights.

I shall not be far wrong in saying that the Shorthorn is generally acknowledged to be the best sort of bullock for stalls, boxes, and yards. And though many practical men are of opinion that the Shorthorns do consume rather more food than the Herefords or Devons, yet it is considered that they make more meat and pay better when liberal feeding is adopted.

*The Herefords.*—The Herefords are divided into four classes:— Hereford cattle.

The mottle-faces have red marks intermixed with the parts usually white—as the face, feet, &c. The horn is long and wavy, with a slight upward tendency, and tipped with black. The skin is particularly mellow, of moderate thickness, and well covered with plenty of soft glossy hair. They are usually good upon the chine. Though considered not so docile as some other classes of Herefords, they display great aptitude to fatten.

The dark-greys are so called from the broad white stripe which extends the whole length of the back, and the parts usually white being thickly interspersed with small red spots. Their horns are rather shorter, with a more upward tendency; they are also smaller in size and smoother in hair than the other classes; better on the chine than the mottle-faces, and have flesh of excellent quality.

The light grey, or white Hereford is closely assimilated to the now common *red-with-white-face* Hereford. This latter is the commonly recognised race.

The general characteristic of the breed as regards colour is a rich or dark red, with a white face, white throat and chest, and white on the neck and along the back, and also inside the legs and on the under-parts of the body.

The quality of hair in the best examples is only surpassed by the Highland Scot, being wavy, soft, and moderately long. Points.  
The best description of horn—wide, with an upward tendency; of a clear yellow or white, and sometimes tipped with black. In the form of their shoulders they stand pre-eminent; and there

is, when fattcd, comparatively little coarse meat about that part. The hips, loin, and rump are generally good; the ribs often not springing out so widely as with some other breeds; but their sides are very good, and their chests well expanded; the outside of the thigh is often too thin, occasioning some deficiency of weight when fed; but the twist is generally full.

Mr. Thomas Duckham, the ex-editor of the 'Hereford Herd Book,' gives the points as follows: "The face, throat, chest, and lower part of the body and legs, together with the crest or mane, and the tip of the tail, a beautifully clear white; a small red spot on the eye, and a round red spot on the throat in the middle of the white, are distinctive marks which have many admirers. The horns are of a yellow or white waxy appearance, frequently darker at the ends. Those of the bull should spring out straightly from a broad flat forehead; whilst those of the cows have a wave, and a slight upward tendency. The countenance is at once pleasant, cheerful, and open, presenting a placid appearance, denoting good temper and that quietude of disposition which is so highly essential to the successful grazing of all ruminating animals; yet the eye is full and lively; the head is small in comparison with the substance of the body. The muzzle is white, and moderately fine; cheek thin. The chest is deep and full; the bosom sufficiently prominent. The shoulder-bone is thin, flat, and sloping towards the chine, well covered on the outside with mellow flesh; the kernel is full up from shoulder-point to throat; and so beautifully do the shoulder-blades bend into the body, that it is difficult to tell in a well-fed animal where they are set on. The chine and loin are broad; hips long and moderately broad; legs straight and small. The rump forms a straight line with the back, and is at a right angle with the thigh, which should be full of flesh down to the hocks, without exuberances; the twist should be good, well filled-up with flesh, and even with the thigh. The ribs should spring well and deep, level with the shoulder-point, the flank should be full, and the whole carcass well and evenly covered with a rich mellow flesh, distinguishable by its yielding with a pleasing elasticity to the touch. The hide is thick, yet mellow, and well covered with soft glossy hair, having a tendency to curl. Such are the characteristic marks of a first-class Hereford."

The Herefords are renowned for their feeding virtues at grass; and good stores are rather scarce, the best being fattened on their native pastures.

The great demand for steers has led many breeders to push them forward, from weaning time, with liberal keep, by which they are brought to a good weight at two years old, the age when they are generally sold.

Mr. Duckham's description of a Hereford.

Properties of the breed.

The white-faces require time to ripen, though they have a remarkable aptitude to fatten quickly; for many are disposed to get what the butchers call "creamy," putting too much of their fat outside, and thus not "proving" as they ought; and it is with age that their meat attains its beautiful marbled appearance, or intermixture of fat and lean. They attain to weights equal to those of the Shorthorns, and carry a vast substance of flesh in proportion to bone; but may be said to be more profitable to the breeder and grazier than to the butcher.

As the rearing system is generally followed in Herefordshire, the milking properties are not so much attended to as in some other counties. Cows, with moderate feeding, make from 32 to 40 stones, with extra keep to 64 imperial stones; and Show specimens go up to much higher weights.

The great majority of the calves are dropped in April, May, June, and July. Yearling heifers are very seldom put to the bull; and the calves are generally suckled for three to six months, running with their dams, unless they come at the commencement of winter. The young steers are fed upon grass, and get turnips and cut straw, with cake in the winter. The rare pastures in the Wye valley push the young animals along quickly; and they come out in their third autumn to the fairs and markets of Hereford, Leominster, Ross, and Ludlow; many of the best, however, being bought direct off the farms. Hereford October fair, with seven or eight thousand steers of this one breed, is a sight for admirers of fine cattle. Fairs.

Herefords not only prevail almost exclusively in their own county, but the native cattle of Salop, Montgomery, Radnor, Brecon, Glamorgan, and Monmouth, are for the most part either changed by crossing with them, or are replaced by them; and great numbers graze the pastures of Somerset, Wilts, Gloucester, Worcester, and Warwick. In fact, few English counties south of Shropshire are without Hereford bullocks; herds are found east as far as Surrey, and west in several counties of Wales. They have been established in Dorset and in Cornwall; they have done well in Ireland; and in Canada, the United States, and the Australian Colonies, the breed has attained great success. Locality of the breed.

The Herefords are not so well qualified for crossing as the Shorthorns; but they have blended well with Shorthorns, and they have produced admirable crosses with Ayrshires and Alderneys, but not particularly well with Devons.

'The Hereford Herd Book,' which Mr. Duckham has recently disposed of to a Society, records in its 9th volume, the herds of 219 breeders, and has a list of 347 subscribers; the number of bulls entered in the entire work has now reached 5176; of cows, Breeders.



with their produce, 4723; and of heifers, 4905. Among the most eminent breeders and exhibitors at the present time are Mr. William Taylor, of Showle Court, Ledbury; Mr. William Tudge, of Adforton, Leintwardine; Mr. J. H. Arkwright, of Hampton Court, Leominster; Mr. Walter Evans, of Llandowlais, Usk; Mr. Thomas Thomas, of St. Hilary, Cowbridge; Mrs. Sarah Edwards, of Wintercott, Leominster; Mr. Thomas J. Carwardine, of Stockton Bury, Leominster; Mr. Philip Turner, of The Leen, Pembridge; Mr. W. Burchall Peren, of South Petherton, Somerset; Mr. Richard Shirley, of Bancott Munslow, Church Stretton; and Her Majesty the Queen.

*Devons* or, as they were once named, North Devons are of a bright red colour, varying a little, either darker or more yellow; they have seldom any white, except about the udder of the cow and belly of the bull. They have long yellowish horns, beautifully and gracefully curved; noses or muzzles white, with expanded nostrils; eyes full and prominent, but calm; ears of moderate size, and yellowish inside; neck rather long, with but little dewlap, and the head well set on; shoulders oblique, with small points or marrow-bones; legs small and straight, and feet in proportion. The chest is of moderate width, and the ribs are round and well expanded; except in some instances, where too great attention has been paid to the hindquarters at the expense of the fore, and which has caused a falling off or flatness behind the shoulders. The loins are first-rate, wide, long, and full of flesh; hips round, and of moderate width; rumps level, and well filled at the bed; tail full near the rump, and tapering much at the top. The thighs of the cow are occasionally light, but in the bull and the ox are full of muscle, with a deep and rich flank. They should have a rich and mellow touch, very silky fine hair; and they are extremely handsome in appearance. The breed is remarkable, too, for the great proportion of weight of the most valuable joints and the little coarse flesh.

According to Mr. J. Tanner Davy, the editor of the 'Devon Herd Book,' the outline of a fat Devon very nearly approaches a parallelogram—angular bony projections are rarely found among the best bred ones, but their frame is level from the top of the shoulders to the tail. The belly is longitudinally straight and well filled out at the flanks, which should be easily found by the unbent fingers; the breast is wide, and comes out prominently between the fore-legs, extending down to within two or three inches of the knee joint and towards the udder in rolls of fat. The neck is rather long and thin, increasing towards the shoulder, which is tapered off to meet it where the neck-vein forms a sort of collar in front of the shoulders, connecting the fat of the shoulder with the fat of the breast.

Devons.  
Points.

Mr. Davy's description.



In the forequarters the Devon probably excels all other breeds, by the shoulders being placed so obliquely that there is no hollow behind them, but the part is well filled out with good flesh and fat, preserving an unbroken line, and promoting a uniform covering of fat throughout every part; commencing at the rump, over the pin bone, edge of the loins, ribs, shoulders, and on to the neck, without patch or excess of any kind. Devon breeders think nothing can compensate for upright shoulders, which are sure to produce hollowness behind them, and a consequent loss of flesh and fat, besides diminishing the capacity of the chest and width of breast. In breeding it is most important to get animals with shoulders placed obliquely; for it is found, in practice, to be much more difficult and to require a longer time to correct the fore than the hind quarters. It is a remarkable fact in the form of the best Devons, that their shoulders are so placed and packed that they can, like a similarly formed horse, go up and down the steep and rugged Northern Devonshire hills with much greater facility than what are called the "large Devons."

The covering over the shoulder-blades is nearly as full as the ribs, which should project at right angles to the back, preserve the barrel shape, and be broad and deep. The loin is wide and flat, projecting in a line with the pin-bone, and is well covered, not only on the top but also on the edge of the bone. The pin-bone must not project to break the even line. The rump is long and well filled out, and the tail, set on level, falls perpendicularly from the line of the back. The buttock is moderately full, tapering towards the hock, with a sufficiency of lean flesh, but not too much, for if the animals are too heavy here, they are apt to be deficient on the sides, back, and rump.

The Devons are of a docile disposition, economical feeders, and excellent milkers; but are of considerably smaller size than Shorthorns or Herefords. The practice of working the steers at three-years old, and, after two years' labour in the team, winter-fattening them for the butcher—their keep up to that time having been grass in summer, and hay, straw, and turnips in winter—is not now so general as it was a few years ago.

Devon cattle have become too valuable for the old-fashioned Fairs. treatment, and are now fed with oilcake, and made ripe at early ages. The principal fairs for this beautiful breed are South Molton, Crediton, and Exeter. These red cattle have not spread very far out of their own quarter of England, that is the counties of Devon, Somerset, and Cornwall; but they are found as grazing stores at some of the midland counties' fairs, and considerable numbers of high-class bulls and heifers have been exported by the most eminent breeders. At the Smithfield Club and other

fat-stock shows, as well as at the Royal and other breeding-stock shows, the Devons always appear with superb classes; and some specimens have won the champion plates of the Smithfield Club in competition with the more massive Short-horns and Herefords.

Breeders.

The herds which have attained the greatest celebrity of late years are those of Mr. James Quartly, Mr. Walter Farthing of Stowey Court, Bridgewater, the late Mr. James Davy (succeeded by Mrs. Langdon) of Flitton Barton, Viscount Falmouth, Mr. John Azariah Smith of Bradford Peverell, Mr. William Smith of Whimble, Sir Alexander Hood, Mr. George Turner, Mr. Thomas Pope, and Her Majesty the Queen.

South Hams  
cattle.

The *South Hams Cattle*, grazing in the district of that name on the South coast of Devonshire, are a red breed, supposed to have originally sprung from the North Devons, but are of larger frame and coarser build. They are good graziers' beasts, and have been materially improved during the last twenty years by selection and better management.

Mr. A. Heas-  
man on Sussex  
cattle.

*Sussex Cattle*.—This breed, of a deep red colour, is becoming more closely assimilated in character to the Devon. Mr. A. Heasman, one of the most eminent breeders and exhibitors, says:

“This useful class of stock was formerly bred principally for draught purposes, being converted into food for the public after they had cultivated the soil of the Weald of Sussex and Kent—some of the heaviest tilled land in the kingdom—and at times being required to start the heavy carriage of the county member from the same muddy district, when it was necessary for him to attend to his parliamentary duties, before locomotive power came into operation or the Highway Act had been amended. Even in those early days the Sussex cattle were fully appreciated, and, always possessing the finest quality of flesh, were never neglected by the grazier.

“When they had been worked for several years, and age at last rendered it necessary that they should be drafted from the team, the farmers of the western part of the county would pay a visit to their brothers in the east; attend the fairs held at Battle, Lewes, or on the borders of Kent, in order to buy up the aged oxen; and, after grazing them a year, supply the markets with animals weighing from one hundred and eighty to two hundred stone.

“Times have very much altered, and the Sussex beasts are no longer what they were, neither are they reared to the same extent or for the same purpose. They have given place to horse and steam power, and now take up their position as one of the useful and established breeds of the kingdom to meet the pressing and increasing demand for beef. Their colour was formerly both

light and dark red—in some instances so dark that it almost amounted to black; but the intermediate or cherry colour is now the favourite, denoting good flesh and better quality for fattening.”

The breed has been too well appreciated by the tenant farmer to be allowed to die out, and great pains and attention have been taken latterly in endeavouring to alter its style and type by breeding from the smallest bone with the greatest amount of flesh. This seems to have been successful, when we compare the present animals with what may be called the old-fashioned sort, one of which, of enormous frame and weight, was fattened many years ago at Burton Park, near Petworth, and called the Burton ox. The Sussex cattle are equal to the best breeds as regards early maturity and weight for age; as is proved by the weights of the animals shown at the Smithfield Club meetings. The Sussex are great favourites with the butcher and consumer. At three years old, well-fed steers will weigh from twelve to fourteen score pounds per quarter. But the Sussex men do not spoil their best animals by overfeeding. Their general features may be described as follows: Nose tolerably wide; muzzle of a golden colour, thin between the nostril and eye; eye rather prominent; the forehead rather wide; horns of moderate length, fine, and rather turning up at the points; neck not too long; sides straight, and not coarse at the point of the shoulder; wide and open in the breast, which should project forward; girth deep; legs not too long; chine-bone straight, but the chine rather too narrow; ribs not always sufficiently broad; loin full of flesh and wide; hip bones not too large, but well covered; rump flat and long; tail should drop perpendicular; thigh flat outside and full in; the coat soft and silky, with a mellow touch.

Points and  
merits of the  
breed.

The Sussex cross well with any breed by using the male animal, imparting substance and firmness of flesh; and the colour of the offspring is generally red. They are of themselves a hardy breed, and have been found to surpass all others in the poorest pastures of their native county. The cows are not good milkers; those with the heaviest calves the worst, though producing sufficient milk to rear their calf. The most successful way of breeding is for them to calve in October and November, letting them have their own calf through the winter, which is weaned in the spring and another calf put to the cow. Managed in this way, each cow rears two calves, and the number of barrens is greatly diminished, which is one of the greatest evils when cows are allowed to drop their calves all the year round.

The Public Herd Book of Sussex Stock has been established about fifteen years, and promises to be of great assistance.

*Longhorns.*—The Longhorned breed is distinguished by the Longhorns.

length of its horns, the thickness and firm texture of its hide, the length and closeness of its hair, and was, at one time, also by the large size of its hoofs and its coarse, leathery, thick neck. It is deeper in the fore-quarters, and lighter in the hind-quarters than most other breeds; narrower in shape, less in point of weight than the Shorthorn, though an excellent weigher in proportion to size. It is more varied in colour than most other breeds; but whatever the colour, there is generally a white streak along the back and mostly a white spot on the inside of the houghs. The Longhorns are good workers, and are celebrated for giving a milk very rich in cream.

Bakewell's improvement.

As modelled by Bakewell, this is their description: "Fore-end long and light; neck thin, head fine but long and tapering; eye large, bright, and prominent. The horns vary with the sex; those of bulls comparatively short, from 15 inches to 2 feet; in some oxen extremely large, from 2½ feet to 3½ feet long. Cows have horns nearly as long, but finer and more tapering. Most of the horns hang downward by the side of the cheeks, and then if well turned, as in many of the cows, shoot forward at the points; the shoulders are fine, thin, and well placed—this was particularly noticeable in the Dishley herd—girth small, as compared with Shorthorn and Middlehorn breeds; the chine remarkably full when fat, but hollow when low in condition; loin broad, and hips wide and protuberant; the quarter long and level; fleshy thighs, with small, clean, but comparatively long legs; carcass round, and ribs well sprung; flesh of good quality; hide of medium thickness; and colour various—the brindle, the finch-back, and the pye most common. As grazier's stock, they undoubtedly rank high; their bone and offal are small, and the fore-end is light, while the chine, the loin, the rump, and the ribs are heavily loaded, and with flesh of the finest quality. In point of early maturity they have also materially improved; in general they have gained a year in preparation for the butcher." Such was the character of the improved Longhorn as established by the leading breeders. Now they have been so improved, that for uniformity of type they can scarcely be excelled by the Shorthorns. They come to hand mellow to the touch. The skin, though thick, is covered with a profusion of rich, soft hair; the rib is well sprung, chine is broad, shoulders are well placed, barrel is round and deep, and the general appearance is in unison, denoting a healthy and vigorous constitution. They are good milkers, and, as a rule, prolific breeders. Their weak point, in these days of high feeding and quick returns, is that they are longer in arriving at maturity than the improved Shorthorn; consequently they give a less return for the quantity of food they consume.

Points and merits.



Their milk is considered richer than that of the Short-horn. This experiment as to the quality of the milk of the Longhorns was made some years ago. In June, six of the best Shorthorn cows of Mr. S. Craven Pilgrim, of Burbage, near Hinckley, Leicestershire, of Bates' blood and bred for their milking properties, were tested against six of Mr. Chapman's Longhorns. The Shorthorns produced 152 lbs. of milk, and the Longhorns 135 lbs. The weight of curd from the Longhorns was  $19\frac{1}{2}$  lbs., but from the Shorthorns only  $14\frac{1}{2}$  lbs. In September, 36 of Mr. Pilgrim's Shorthorn cows were tried against 32 of Mr. Chapman's Longhorns. The former produced 605 lbs. of milk, which made only  $66\frac{1}{2}$  lbs. of curd; while the Longhorns gave 553 lbs. of milk, yielding 69 lbs. of curd.

They have now a Herd-book, and are under the guardianship of a newly formed Longhorn Society.

I may here quote what a writer in the 'Field' has lately said of this breed. "The present position of the Longhorns illustrates the old saying that 'every dog has its day.' Confined now to a few amateur farmers in the midland counties, it is difficult to realise that a hundred years ago they were the most valuable breed in this country; yet such is the fact. Yorkshire has the credit of giving rise to the Longhorn and their supplanters, the Shorthorn. The latter, however, originated in the eastern division, whilst the district of Craven (the original home of the Longhorns) is in the West Riding, bordering on Lancashire, from whence they spread out into the latter county and the south-eastern portions of Westmoreland. Like the Durham cattle, they enjoyed a considerable local reputation, those bred in the fertile vales of Craven being considered the quickest feeders, as they were the handsomer beasts; but it required the genius of Bakewell to draw them from their comparative obscurity, and give a reputation which at that time seemed unassailable.

"Sixty years ago the Longhorn was the most important and fashionable breed of cattle inhabiting the counties of Derby and Stafford; and there still linger in the district wondrous tales of the quantity of milk yielded by some favourite cow, or the more marvellous weights which the oxen and heifers attained when grazed on the rich alluvial pastures of the Trent, the Dove, or the Derwent."

The *Channel Island breeds of Cattle*, popularly classed indiscriminately together as "Alderneys," and once known as "the crumpled horned," include the Jerseys and the Guernseys. They are bred to some extent in England, but are largely imported from their native islands. They have long been celebrated for

their milking and creaming properties, but were originally ill-formed and ungainly in appearance; the redeeming points having always been the fine head, crumpled horns, and capacious well-formed udder. In proportion to their size, the Alderney cows give more milk of richer quality than those of any other breed; the best having been found to yield 10 lbs. to 14 lbs. of butter per week. And since the improvement of the breed in symmetry and beauty, it has become highly sought after for dairies in the vicinity of what may be called fashionable towns, and for ornament as well as profit in villa paddocks and gentlemen's parks. In the large city dairies the Alderneys are not in such repute as Shorthorn and Dutch cows which give large quantities of milk of lower quality, and which, when drafted, fatten with greater rapidity.

'The Field' on the history of the breed.

A writer in 'The Field' says—'At the present time there is no doubt that in England, where the principles of selection have so long been successfully applied to horned stock and sheep, finer specimens of the Alderney have been produced than in their native islands.

"For many years the farmers of the Channel Islands, while sternly prohibiting any importation of bulls, have made the rearing of heifers for the English market a profitable part of their business; but it is only within a comparatively recent period that they have learned from English breeders the advantages to be derived from a careful selection in obtaining symmetry as well as milk.

English breeders.

"Amongst English breeders who have shown what could be done towards obtaining the best points of a milking cow by applying Bakewellian principles of selection, Mr. Philip Dauncey, of Horwood, near Winslow, Bucks, occupies, or rather occupied, the most distinguished position. For nearly half a century he devoted his attention to obtaining great milking qualities, symmetry, constitution, and a uniform fawn colour without white. His success placed him at least half a century in advance of the Channel Islanders.

"Mr. Dauncey produced a breed much more hardy than the original Channel Islanders; his stock lying out on the pastures throughout the year. The imported Alderneys are delicate, and, on first introduction, require slight shelter in the cold weather; but they soon afterwards become acclimatised."

One of the best herds maintained purely for profit was that of one hundred Jersey cows belonging to the late Mr. James Dumbrell, of Ditchling, near Brighton. Another breeder of Alderneys, who bears a name almost classical in the history of agriculture, is Mr. C. H. Bakewell, of Quorndon, near Derby, who has a small but select herd which is managed in a profitable



manner. His average annual return has been from 220 lbs. to 240 lbs. of butter per cow.

Mr. George Simpson, of Wray Park, Reigate, Surrey, and Mr. Walter Gilbey, have been two of the greatest patrons and improvers of the breed; and the Messrs. Fowler, of Bushey and Watford, Herts, and of Southampton, have been the importers of this highly appreciated breed of cattle into this country for nearly a century.

The Guernsey breed are of a self-colour, red, or dun, or Guernseys and patched with white; the Jerseys are smaller, and of a darker Jerseys. olive or fawn-colour.

A marked course of improvement in both breeds has taken place since the Jersey Agricultural Society, founded in 1833, drew up a scale of points of merit, from an examination of the best specimens then in the island. This scale originally fixed a standard of twenty-six points for bulls, and twenty-eight for cows and heifers, and it was amended and the points increased in number in the year 1849. In 1866 the 'Jersey Herd Book' was started, and in 1868 the committee of the Royal Agricultural Society of Jersey called attention in a report to the advantageous results of careful breeding as practised by Mr. Dauncey and others in this country. In a subsequent report, in December, 1871, the committee acknowledged a yearly grant from the State of Jersey of 50*l.*, to be applied solely in premiums for bulls, to check the exportation of good animals from the island.

This remarkable scale of points, by which judges criticise the Scale of points qualifications of Alderney cattle, is as follows:—

*Scale of Points for Bulls.*

Article.	Points.
1. Head, fine and tapering .. .. .	1
2. Forehead, broad .. .. .	1
3. Cheek, small .. .. .	1
4. Throat, clean .. .. .	1
5. Muzzle, fine, and encircled by a light colour .. .. .	1
6. Nostrils, high and open .. .. .	1
7. Horns, smooth, crumpled, not too thick at the base, and tapering, tipped with black .. .. .	1
8. Ears, small and thin .. .. .	1
9. Ears, of a deep orange colour within .. .. .	1
10. Eyes, full and lively .. .. .	1
11. Neck, arched, powerful, but not too coarse and heavy	1
12. Chest, broad and deep .. .. .	1
13. Barrel, hooped, broad, and deep .. .. .	1
14. Well ribbed home, having but little space between the last rib and the hip .. .. .	1
15. Back, straight from the withers to the top of the hip	1
Carried forward .. ..	15
	2 P 2

Article.	Points
Brought forward .. .. .	15
16. Back, straight from the top of the hip to the setting on of the tail, and the tail at right angles with the back .. .. .	1
17. Tail, fine .. .. .	1
18. Tail, hanging down to the hocks .. .. .	1
19. Hide, mellow and movable, but not too loose .. .. .	1
20. Hide, covered with fine soft hair .. .. .	1
21. Hide, of good colour .. .. .	1
22. Fore legs, short and straight .. .. .	1
23. Fore-arm, large and powerful, swelling, and full above the knee, and fine below it .. .. .	1
24. Hindquarters, from the hock to the point of the rump, long and well filled up .. .. .	1
25. Hind legs, short and straight (below the hocks), and bones rather fine .. .. .	1
26. Hind legs, squarely placed, and not too near together when viewed from behind .. .. .	1
27. Hind legs, not to cross in walking .. .. .	1
28. Hoofs, small .. .. .	1
29. Growth .. .. .	1
30. General appearance .. .. .	1
31. Condition .. .. .	1
Perfection .. .. .	31

No prize shall be awarded to bulls having less than 25 points.

Bulls having obtained 23 points shall be allowed to be branded, but cannot take a prize.

*Scale of Points for Cows and Heifers.*

Article.	Points.
1. Head, small, fine and tapering .. .. .	1
2. Cheek, small .. .. .	1
3. Throat, clean .. .. .	1
4. Muzzle, fine, and encircled by a light colour .. .. .	1
5. Nostrils, high and open .. .. .	1
6. Horns, smooth, crumpled, not too thick at the base, and tapering .. .. .	1
7. Ears, small and thin .. .. .	1
8. Ears, of a deep orange colour within .. .. .	1
9. Eye, full and placid .. .. .	1
10. Neck, straight, fine, and placed lightly on the shoulders .. .. .	1
11. Chest, broad, and deep .. .. .	1
12. Barrel, hooped, broad, and deep .. .. .	1
13. Well ribbed home, having but little space between the last rib and the hip .. .. .	1
14. Back, straight from the withers to the top of the hip .. .. .	1
15. Back, straight from the top of the hip to the setting on of the tail, and the tail at right angles with the back .. .. .	1
16. Tail, fine .. .. .	1
17. Tail, hanging down to the hocks .. .. .	1
18. Hide, thin and moveable, but not too loose .. .. .	1
19. Hide, covered with fine soft hair .. .. .	1
20. Hide, of good colour .. .. .	1
21. Fore legs, short, straight, and fine .. .. .	1
Carried forward .. .. .	21

Article.	Points.
Brought forward .. .. .	21
22. Fore-arm, swelling, and full above the knee .. ..	1
23. Hindquarters, from the hock to the point of the rump, long and well filled up .. .. .	1
24. Hind legs, short and straight (below the hocks), and bones rather fine .. .. .	1
25. Hind legs, squarely placed, not too close together when viewed from behind .. .. .	1
26. Hind legs, not to cross in walking .. .. .	1
27. Hoofs, small .. .. .	1
28. Udder, full in form— <i>i. e.</i> , well in line with the belly .. ..	1
29. Udder, well up behind .. .. .	1
30. Teats, large and squarely placed, behind wide apart .. ..	1
31. Milk-veins, very prominent .. .. .	1
32. Growth .. .. .	1
33. General appearance .. .. .	1
34. Condition .. .. .	1
Perfection .. .. .	34

No prize shall be awarded to cows having less than 29 points.

No prize shall be awarded to heifers having less than 26 points.

Cows having obtained 27 points, and heifers 24 points, shall be allowed to be branded, but cannot take a prize.

Three points—viz., Nos. 28, 29, and 31—shall be deducted from the number required for perfection in heifers, as their udder and milk-veins cannot be fully developed; a heifer will therefore be considered perfect at 31 points.

By attention to the rules and by crossings, so as to remove defects in the bull, a lighter head, a broad forehead, finer horns, a more square form, a round barrel, a better chest, cleaner limbs, and a better handling, have been obtained; the rich orange colour within the ear has been retained; and as a fashion in colour, either a rich brown edged with a mouse-coloured band about an inch wide, or a cream colour either on a white or grey ground, is preferred.

Bulls are allowed to serve as soon as they become yearlings; which is injurious to the constitution, but is said to preserve the race small and fine-boned.

By similar attention the general form of the cow has wonderfully improved; most cows reaching 21 points, with a fine head, a lively eye, crumpled horns, a straight back, a round barrel, fine limbs, and a brisk step. Many, from 14 to 20 quarts of milk daily, will produce between 10 and 14 lbs. of rich yellow butter per week. Some cows yield no less than 20 to 26 quarts daily.

*Norfolk and Suffolk Polls.*—The prevailing colour of this breed was a mouse-dun, changed latterly to pale red, red and white, or yellowish and white. Norfolk and Suffolk polls.

Suffolk cattle, according to the earliest records on the subject, were polled, and, originally, dun in colour; later on they are described as red, red and white, and brindled.

From a very early period large numbers of polled Galloway

cattle were brought into the counties of Norfolk and Suffolk. There can be little doubt that these were crossed with one or other (probably both) of the native races, and that thus the present breed of Norfolk and Suffolk red polled cattle was called into existence.

Mr. Fulcher on  
this breed.

Mr. T. Fulcher, writing in the 'Field,' said: "We are by no means disposed to accept the theory that our polls are simply red Galloways. True enough, there is a resemblance between the heads of the two sorts, each being furnished with a thick tuft of hair, covering the forehead. In the Norfolk beast this appendage will, however, be frequently composed of a mixture of red and white hair. More rarely, a large spot of pure white makes its appearance in the face. The deep, blood-red colour of the Norfolk polls is, moreover, many shades darker than we have seen in any specimens of the Galloway breed. These two peculiarities go far to support the conclusion we have arrived at—that the old native race had a due share in the concoction of the present breed. As to when this cross was first resorted to, we have no precise information. Marshall, indeed, mentions that long before his time polled Suffolk, Galloway, and even West Highland bulls were used for crossing with the Norfolk home breeds; but so highly did he appreciate the good qualities of the latter, that he only refers to crossing in order to condemn the practice.

"In the absence of documentary evidence, we have it on the authority of Mr. Money Griggs of Gately (now in his hundredth year, and for upwards of eighty years a tenant on the Elmham estate), that from his earliest recollection red polled cattle were kept in the neighbourhood of this place."

Amongst the good qualities that may be fairly claimed for the red polls are hardiness of constitution, enabling them to thrive on scanty pasturage and to withstand the severe winters and piercingly cold springs usually experienced in the eastern counties; their milking properties are unquestionable, and they have not that tendency to go dry which belongs to the Alderney, Ayrshire, and most other breeds having a reputation as dairy cattle. It not unfrequently happens that a cow will continue to yield a good quantity of milk from one calving to another.

Cows and heifers for dairy purposes are frequently sold to buyers in the counties of Beds, Berks, Bucks, Chester, Hants, Northampton, and Sussex; whilst exportations of breeding stock have been made to Egypt, Germany (north and south), and Austria, where, strange to say, on an estate of Prince Leichtenstein, a breed of red polled cattle has been in existence from time immemorial.

The native *Dorset* breed of cattle, long-horned, white-backed, with short dark stripes over the body, are rarely seen now, though

Lord Portman, in a foot-note to Mr. Ruegg's Report on the county twenty years ago, remarked that some of the features of the old Dorset cow might often be seen in the form of the progeny, crossed as the breed had been by Devons, Herefords, and Shorthorns.

*Welsh Breeds.*—According to Mr. Morgan Evans, the best authority on the subject, the colour of the *Pembrokeshire*, or “Castlemartin,” cattle is black; the horns are of great length, yellowish-white tipped with black, wide-spreading and curving upwards; the head is of medium length, longer than the West Highlands, and somewhat longer than the Devons, approaching the Herefords or the improved Sussex in form. The nose is small and the neck fine, with little tendency to the “throateness” observable in some breeds. The eyes are prominent, but without the untameable gleam of the West Highland or Chillingham cattle, domestication having removed any special traits of wildness and of ferocity. The coat is long, not straight like the Highland cattle, but wavy, or sometimes curly. The forehead is broad. The tail is of good length. Several writers have remarked on the colour of the skin as being of an orange yellow, and the coat on the barest parts of the body as being of a brownish hue. Some of the best breeders in Pembrokeshire are careful to maintain this characteristic in their herds. This, along with a yellow horn and a wavy coat, almost invariably indicates a beast that will feed well either at grass or in the stall. A short, crisp, coal-black coat is not to be compared with one that is long and wavy. The outer covering of hair put on in the winter months should, with outlying cattle, at the end of spring and during the early summer months be of a russet brown. One frequently sees cattle of this breed whose coats are one mass of ringlets; but experience shows that they are not the most easily fattened. The hair on the forehead of bulls is often very much curled, and it is rather to be admired than otherwise for the sake of its picturesqueness, as well as that it indicates other important qualities.

The meat produced by these cattle is excellent, and not to be surpassed in texture and quality. The milking properties of the cows are certainly equal, if not superior, to those of most modern improved breeds. Mr. Evans says, “Welsh black cows are on the average equal to any class of cows in milk-producing capabilities. The only objection to them at dairy farms around the metropolis is their colour. The admixture of black with red and white and roan in the herd is not thought fashionable or pleasant to the eye.”

Taking into account the climate, soil, and average homestead accommodation in the county, the Pembrokeshire cattle can be bred to feed cheaper than Shorthorns or Herefords. Attempts

Welsh cattle.  
Pembrokeshire.



to improve the breed by crossing have not been attended by success, though the Devons amalgamated best.

Again following Mr. Morgan Evans, the Anglesea cattle are very like the Pembrokes. The coat, as with the Castlemartins, should be long and wavy. This generally denotes good quality, and a growing beast easily fattened. In colour they are generally darker than those of South Wales, being a pure black. A little more white is allowed than in the Pembrokes, the scrotum of the bulls and the udders of the cows being very frequently white. A white streak is sometimes found along the chine, but this feature cannot be commended. The horns, which may be broadly described as white with black tips, curving gracefully upwards in cows and oxen, are usually much darker-coloured than in the Pembrokes, and the white portion is not so mellow and creamy in appearance. They are perhaps a little larger than the Castlemartins—standing on short strong legs; but are not so good in the head or shoulder. The head of the ox is very frequently heavy and bull-like. Davies in his time attributed the “bull-like features in the head and dewlap” of the Anglesea ox to the fact that the calves were not weaned in Anglesea until “double the time at which they are weaned in other counties,” together with their not being “gelt until they be about a year old;” but this will hardly account for the persistency of this feature in stock not thus treated. The shoulder is often coarse, and falls in behind the bladebone. In short, comparing them once more with their rivals, they are altogether coarser in the fore part than the Pembrokes, but have better hind-quarters—wider, with bigger thighs and broader loins. The Welsh “runts” as they are called, are not equal to many other breeds for dairy purposes.

The Anglesea cattle are now cultivated to equal perfection in Carnarvonshire and some parts of the adjoining counties as in the “mother” isle; and diminutives of this breed are the principal stock of the mountainous districts of Carnarvon and Merioneth. But they cannot be improved by crossing with English breeds. They will not blend with foreign blood; the colour becomes destroyed and the type broken, and the produce cannot be reduced to a uniform standard.

Of the distinctive *Glamorgan* breed of cattle only a few herds remain.

*Scotch Breeds.*—My department of this Memoir does not embrace any outline of Scottish husbandry; but, as many bullocks from beyond the border are grazed, and Scottish cows kept for dairying in English counties, I must allude to the characteristics of the principal breeds in that division of the United Kingdom.

In the Highlands of Scotland, and in the Hebrides, the Kyloes or *West Highland cattle* prevail. They are so fitted for

Anglesea  
breed.

West Highland  
cattle.



the peculiar climate and herbage, that nothing further is to be desired than that, over that wide tract of country, the general breed should be brought to the perfection it presents in certain districts.

The true West Highland ox has short, muscular limbs; a wide and deep chest, finely arched ribs, and straight back; his skin is thick but mellow, and closely covered with shaggy hair; his head is broad, with the muzzle short but fine; he has a bright, full eye; long, upturned horns; and a bold, erect carriage; so that when of mature size, and in good condition, he exhibits a symmetry of form and noble bearing not excelled by any breed in the kingdom.

Although somewhat slow in arriving at maturity, he is contented with the coarsest herbage, and will ultimately fatten where the daintier Shorthorn could barely exist.

His compact carcass and choice quality of beef render him an especial favourite with the butchers who have a select family trade. The cows yield a very rich milk, but give little of it, and have a tendency to go soon dry.

The *Galloway* has a larger frame than the West Highland, Galloways. adapting him to a longer range of pastures; but his qualities and general appearance are so similar to those of the West Highlander, that he has been called a *Kyloe* without horns. He is, however, of much more docile and placid disposition, which, with the want of offensive weapons, admits of a larger number than of other breeds being kept together in the same yard. His quietness, his aptitude to fatten when once his frame is matured, and the excellent quality of his beef (which is largely developed on those parts which are used for roasting and which fetch the best price), have long rendered the *Galloway* an especial favourite with the graziers of midland and eastern England and the butchers of the metropolis.

The true *Galloway* bullock is straight and broad on the back, and nearly level from the head to the rump; broad at the loins—not, however, with hooked bones or projecting knobs—so that, when viewed from above, the whole body appears beautifully rounded; he is long in the quarters, but not broad in the twist; he is deep in the chest, short in the leg, and moderately fine in the bone; clean in the chop and in the neck; his head is of a moderate size, with large, rough ears, and full but not prominent eyes or heavy eyebrows, so that he has a calm though determined look; his well-proportioned form is clothed with a loose and mellow skin, adorned with long, soft, glossy hair. The prevailing colour is black, or dark brindled.

The *Angus* and *Aberdeenshire* black polled cattle are of great Aberdeenshire. size; on the authority of Mr. M'Combie of Tillyfour, they are unrivalled as meat-making beasts in the north of Scotland, and

also, when crossed with Shorthorn, give some of the most valuable animals for feeding that we possess. Magnificent specimens are shown in the metropolitan market and at the Christmas exhibitions.

Ayrshires.

The *Ayrshire* breed is very celebrated for the dairy, very hardy and active, and capable of withstanding the severities of winter in a bleak and naked country, and yet easily brought into condition with the return of warm weather and good pasture.

The colour is generally red-and-white, in spots—not marbled like the Shorthorns—sometimes white and black, sometimes altogether red or brown. The horns should be fine, twisting upwards; the face long, with a lively yet docile expression; the figure of the body enlarging from the fore to the hind-quarters; broad across the loins; the back straight; the tail fine, long, and bushy at the extremity; the udder white and capacious, coming well forward on the belly; the teats of middle size, set equally, and wide apart from each other, and the milkveins prominent and fully developed. The whole appearance of the animal should be sleek and thriving. In young queys which have not had a calf, the udder should be loose and wrinkled, showing capacity for expansion; and the teats should be perfect and set well apart.

The size and weight of the Ayrshire cow varies very much, according to the quality of the soil on which she has been reared. Compared with the Shorthorn, the Ayrshire is a small breed, weighing from 25 to 45 stones imperial.

At three years old the dairy-cow bears her first calf. For the first season she is considered to yield about a third less milk than in future years. After this she may be kept in the stock for five or six years, according to circumstances, producing a calf each year. If a cow fails to be in-calf, she is fed fat and disposed of, if an inferior animal; if a good milker, and a young cow, she is kept in the stock, though, for that year, reckoned to produce one-third less than a full-milk cow. As the cows get old, they are sent to Glasgow, or other large towns, when near calving, and then sold to cow-feeders, who, after milking them as long as they pay, sell them fat to the butcher. Those farmers who have sufficient green-crop feed off the cast of their dairy-stock at home.

#### SHEEP.

Leicesters.

*Leicesters*.—Leicestershire is one of the few counties which, it is believed, never possessed a native breed of short-wooled sheep; and its ancient long-wools were the basis from which the genius of Robert Bakewell, in the latter part of last century, produced the Dishley or New Leicester, which through

nearly a century has displaced or changed, refined and increased the early maturity and fattening property of many breeds in a majority of English counties, in Scotland, and in Ireland, is still the foundation of the most valuable crosses, and has been found the most potent instrument in improving the native races of sheep in very many of the pastoral countries of the world.

The old Leicester was a long, heavy, coarse-woolled animal, The old breed. with large frame, heavy bone, sharp chine, mean rump, and loose skin; seldom ready for the butcher before three years old, when the wethers weighed 25 to 30 lbs. per quarter, and the coarse fleece about 10 lbs. The Dishley or New Leicester was distinguished by a general squareness of outline, a uniformly broad and straight firm back, terminating in a square rump, and full, deep shoulder; with rather too much tendency to the "soda-water bottle"—full middle and rounding-off ends—however, to please a Lincolnshire man, who likes a thick scrag at one end, and a wide rump and heavy leg of mutton at the other; it had a well-arched rib, full plait, deep wide chest, tapering neck, a small head, covered with short white hair; an open countenance and clean muzzle, a full but quiet eye, and long, thin, well-placed ears. Its offal was light, bone uniformly fine, twist well turned, and its pelt was thin, soft, and elastic, with a mellow handling. Its principal deficiency consisted in a want of size, lightness of wool, and the comparative want of fertility and good milking qualities in the ewe.

Pure Leicesters of the present day vary much in type according to the objects which have governed the breeder in his continual process of selection, and partly also according to the influence of locality; so that in some flocks the size is only about two-thirds what it is in others; and yet the exquisitely symmetrical and beautiful sheep of one flockmaster and the larger frame, coarser sheep of another, have alike descended with a pure strain from the renowned early stocks. In general, it is correct to say that the fore-quarter of the Leicester is remarkably well developed; the shoulders are wide and sloping, consequently there is no rigidity along the back; the bosom is deep and wide, and the fore-flank very full. The animal stands close to the ground. The neck is short, so that the head is raised but little above the line of the back. In Youatt's language: "the neck full and broad at the base, where it proceeds from the chest, but gradually tapering towards, and being particularly fine at the junction of the head and neck; the neck seeming to project straight from the chest, so that there is, with the slightest possible deviation, one continued horizontal line from the rump to poll." The ribs are well sprung, and the carcass is very true; the hips are well covered, Points of modern Leicesters.

but not wide, and tapering to the rump, which is small; the back is covered with fat. An authority in the 'Field' described the head as well set on, the forehead flat and generally bare, or covered with short hair. "Formerly," he says, "a great point was made of bare heads; but now we believe breeders prefer to have short close wool, which protects from the fly. The eye is full and prominent, indicating docility of disposition, and the head is tolerably long and fine; the ears are thin and rather long, and the muscular development is moderate; this is attributable to rapidity of growth. The legs of mutton are not large, and there is a deficiency of lean meat. The skin is thin and very supple, and the wool is fine and fairly long. With a wonderful capacity for external and rapid development, there is little inside fat; hence Leicesters are not favourites with the butchers. Their great merit is their early development and accumulation of weight on a given quantity of food."

Weight of  
mutton and  
wool.

The Leicester wethers at 15 months old commonly weigh 20 lbs. a quarter; but older animals, when well fattened, have occasionally been exhibited of more than three times this weight. The mutton is not so highly esteemed as some, owing to the unusual superabundance of fat; but the flesh of good Leicester crosses has a delicious flavour, with a more agreeable distribution of fat and lean. The average weight of the fleece may be about 7 lbs. to 8 lbs., varying with the character of Leicesters found in different districts.

Among the most noted Leicester breeders at the present time are—Mr. George Turner, of Brampford-Speke, Exeter; Mr. George Turner, junior, of Thorpelds, Northampton; Mr. R. W. Cresswell, of Ravenstone, Ashby-de-la-Zouch; Mr. John Borton, of Barton-le-Street, Malton; Mr. William Brown, of Holme-on-Spalding-Moor, Yorkshire; Mr. T. H. Hutchinson, of Catterick; the Earl of Lonsdale, Mr. Benjamin Painter, of Oakham; Mrs. Perry Herrick, of Beau Manor Park, Loughborough; Mr. Thomas Marris, of Croxton, Ulceby, Lincolnshire.

Border  
Leicesters.

*Border Leicesters.*—While a variety of the Leicester breed, known as Mug Leicesters, rather long-legged, and of a hardy constitution adapted to the moors, is found in Yorkshire, and other descriptions of Leicester exist in other parts of the kingdom, the most noted and valuable branch from the pure Leicesters is the kind denominated "Barmshire" or "Border Leicester," from its pertaining to the border counties of Northumberland, Berwick, and Roxburgh. They are of large size, high-standing, and long, with clean white faces and legs. According to Mr. John Usher, they possess, when well bred, the following points: the head of fair size, with profile slightly aquiline, tapering to the muzzle, but with strength of jaw and

Points.

wide nostril; the eyes full and bright, showing both docility and courage; the ears of fair size, and well set; the neck thick at the base, with good neck vein, and tapering gracefully to where it joins the head, which should stand well up; the chest broad, deep, and well forward, descending from the neck in a perpendicular line; the shoulders broad and open, but showing no coarse points; from where the neck and shoulders join, to the rump, should describe a straight line, the latter being fully developed; in both arms and thighs the flesh well let down to the knees and hocks; the ribs well sprung from the back-bone in a fine circular arch, and more distinguished by width than depth, showing a tendency to carry the mutton high; and with belly straight, significant of small offal; the legs straight, with a fair amount of bone, clean and fine, free from any tuftiness of wool, and of a uniform whiteness with the face and ears. They ought to be well clad all over, the belly not excepted, with a wool of a medium texture, with an open *purl*, as it is called, towards the end. In handling, the bones should be all covered; and particularly along the back and quarters (which should be lengthy) there should be a uniform covering of flesh, not pulpy, but firm and muscular. The wool, especially on the ribs, should fill the hand well. A point is made of their stepping with an active and elastic movement.

One of the main uses of the breed is for crossing with Cheviots, Blackfaces, and Downs. The Leicester and Cheviot cross is also the foundation for a very valuable second cross with the Leicester.

The most distinguished flocks are those of Lord Polwarth, of Mertoun; Miss Stark, of Mollondean; the Rev. R. W. Bosanquet, of Rock; Mr. James Melvin, of Bonnington, Ratho; Mr. Richard Tweedie, of Catterick; Sir George Dunbar, in Caithness.

At the Kelso annual September auction sales, considerably over 2000 Border Leicester rams are sold in four auction rings; and nearly as many are on show at Edinburgh.

*Lincoln Longwools.*—The established breed of sheep in Lincolnshire more than a century ago was of large size but ungainly form; of great length of carcass, but not proportionately wide; the legs long and with heavy bone; the head coarse, with thick ears; face white, with small black spots; the face of the ram furrowed with deep wrinkles; the neck thick; shoulders very forward; a flabby dewlap, and hanging brisket; belly deep; and the flesh was laid on better on legs and rump than along the back and ribs. Slow feeders, with a coarse grain of mutton, they attained to great weights; but their especial merit consisted in their fleeces, which exceeded that of all other breeds in length of

The old  
Lincolns.

staple, namely, 10 to 18 inches, and weighed 8 to 16 lbs. per fleece. The wool was curly-stapled, and noted for its gloss or lustre. The breed was adapted to the rich, moist marsh lands, and capable of enduring the winter exposure on those wet layers.

Improved  
Lincolns.

Great weights  
and fleeces.

Leicester blood having worked a vast change in the breed, the improved Lincoln may now be said to possess a size, expansion of frame, and nobility of appearance equal to that of the Cotswold, with the compactness of form, quality of flesh, propensity to fatten, and fine countenance and light offal of the Leicester; while surpassing both for the weight and value of its wool. An experiment conducted by the Parlington Farmers' Club, in the years 1861-2, showed a larger profit from Lincolns fed upon rape, turnips, and oilcake, than from Cotswolds, Teeswaters, Border Leicesters, Leicesters, Shropshire Downs, or Southdowns. Some of the heaviest dead-weights recorded are as follow:—a three-shear Lincoln wether of Mr. Dawson, in 1827, is said to have weighed  $96\frac{1}{2}$  lbs. per quarter; a wether killed at Holbeach in 1844 weighed  $72\frac{1}{2}$  lbs. per quarter; a ewe exhibited at the Smithfield Club Show in 1846, by Mr. John Clarke, of Long Sutton, weighed  $65\frac{1}{2}$  lbs. per quarter; and Mr. Clarke, of Canwick, exhibited at Lincoln, in 1827, wether sheep each of which weighed 65 lbs. per quarter and yielded 24 lbs. of wool. Recently a fourteen-months-old shearling of Mr. Marshall, of Branston, gave a fleece of  $26\frac{1}{2}$  lbs.; and whole clips of hogg wool of Mr. Marshall and of Mr. J. J. Clarke, of Welton-le-Wold, have averaged about 12 lbs. per fleece. The Lincolns are a fairly prolific breed; about one-third of the ewes dropping twins, while triplets are not uncommon, and four lambs occasionally come at a birth. They are excellent nurses.

Locality.

The improved Lincolns are bred throughout their native county, in Rutland, Yorkshire, Nottinghamshire, Derbyshire, and Cambridgeshire; and also in parts of Norfolk, Huntingdonshire, and Northamptonshire; and some flocks have been established in Scotland and in Ireland. Lincoln rams are largely used for improving other longwool breeds and for crossing; and they are exported on a very considerable scale to South America, the Cape, New Zealand, and the Australian colonies. The cross with merino is found to produce a surprising increase in the length and weight of the wool.

Fairs.

There are great shows of Lincoln sheep at Boston, Caistor, and other fairs; but the grandest sight is that of 40,000 to 50,000 hogs at Lincoln April fair, when the best pens realise from four to five guineas per head at fourteen months old. Some of the most marvellous specimens of fat sheep ever produced, both for weight, form, and wool, won a recent Smithfield Club champion plate for Mr. John Byron.



Large numbers of rams are sold at Lincoln, Boston, Partney, and Peterborough autumn fairs; but the principal trade is by private sales and lettings. The average prices made are very high; and many rams of the most noted flocks command three figures per head, as, for instance, a celebrated sheep of Mr. Thomas Kirkham, of Biscathorpe, which was let five years in succession for a total of nearly 600 guineas; a ram of Mr. Charles Clarke, of Scopwick, which was sold for 157*l.* 10*s.*; a ram of Mr. W. F. Marshall, of Branston, of which the price was 110*l.*; while 80*l.*, 70*l.*, and 50*l.* are not at all unusual top prices.

Among the most eminent breeders at the present time are Breeders. Mr. T. Kirkham, of Biscathorpe; Mr. W. F. Marshall, of Branston; Mr. C. Clarke, of Scopwick; Mr. C. Clarke, of Ashby; Messrs. W. and H. Dudding, of Panton; Mr. J. H. Casswell, of Laughton; Mr. T. Casswell, of Pointon; Mr. E. Paddison, of Ingilby; Mr. John Pears, of Mere; Mr. R. Wright, of Nocton; Mr. Davy, of Owersby; Mr. Havercroft, of Wootton; Mr. F. W. Iles; Mr. J. J. Clarke, of Welton-le-Wold; Mr. T. Cartwright, of Dunston; Mr. E. J. Howard, of Nocton; Mr. John Byron, of Kirkby Green, and Mr. T. Gunnell, of Milton, Cambridgeshire.

The *Teeswater* Longwool breed, so named from its original Teeswater  
breed. locality, the banks of the River Tees in Yorkshire, was at an early period in the history of the New Leicester greatly altered in character by admixture with Leicester blood. The *Teeswater* sheep was a very high-standing, large-framed, clumsy animal, with broad back and round barrel, but a very sluggish feeder. The wool was remarkably long stapled, but thinly set and of coarse quality; but one valuable property of the breed was that it was very prolific, as not only were twins usual, but ewes very frequently dropped three lambs, and there were cases of four and even five lambs at a birth. By crossing with Leicesters the size and constitution have become united to quick-feeding properties; and the present *Teeswaters* have valuable fleeces. There is a great show of them at Market-Weighton Fair.

*Romney Marsh.*—The *Romney Marsh* long-wool sheep are Romney Marsh  
sheep. specially adapted by their hardihood for bearing the extremes of heat and cold peculiar to their district; and particularly are the ewes fitted by their constitution for subsisting upon the exposed grass-lands in winter, scraping away deep snow with their feet to find the herbage, and enduring the bitter blasts which blow off the English Channel. The value of the breed in this respect enables it to hold its ground against the introduction of sheep possessing more fattening properties. Indeed, these Kent sheep, improved in late years, partly by good management and selection in breeding, and partly by admixture

of Leicester or other good blood, have extended their area; the Weald is stocked with them in winter, and they have spread themselves over the greater portion of Kent, displacing the Southdowns in many localities. Half a century back these sheep were distinguished by thickness and length of head, a broad forehead with a tuft of wool upon it, and a long thick neck and carcass. They were flat-sided, had a sharp chine, tolerably wide loin, the breast-end narrow and not deep, and the fore-quarter neither heavy nor full; the thigh was full and broad; the belly large and tabby; the tail thick, long, and coarse, and the bone large; the wool was long and not fine, coarsest on the thighs; but they had much internal fat, and were great favourites with the butcher.

Weights.

The wethers seldom reached market until they were three years old, and weighed from 10 to 15 stones, and the ewes from 9 to 11 stones (of 8 lbs.).

At the present day, tegs of the improved breed can be sent to market from turnips at 17 lbs. to 20 lbs. per quarter; while the two-shear wethers weigh 25 lbs. to 30 lbs. per quarter. Possessing more symmetrical frames, and lighter bone and offal, the best Romney Marsh sheep attain to considerable weights; the heaviest shearlings at a late Smithfield Club Show scaling 260 lbs. each, live weight.

The wool is specially valuable for the length of staple, fineness of quality, and bright glossy character, which makes it in demand for Flanders and France, being principally used in the manufacture of a fabric known as "cloth of gold." The hogg and ewe fleeces weigh on an average 6 or 7 lbs., and the wool of two-shear wethers up to 10 lbs., individual fleeces considerably exceeding these figures.

Devon  
Longwools.

*Devon Longwools.*—While a limited number of Exmoor mountain sheep are found on the northern border of Devonshire, an ancient breed, the South Hams Notts, somewhat resembling the Romney Marsh sheep, graze the pastures in the south, and the hardy, delicate-fleshed Dartmoor, or Oakhampton sheep, feed on the bleak and lofty forests, the most prevalent flocks in central and eastern Devon, in West Somerset, and in parts of Cornwall, are of the Devon Longwool breed. This is a product from crossing, principally with Leicesters, but partly with Cotswolds and also with Lincolns, the native Bampton breed, so named from a village on the Somersetshire border. But most breeders have now ceased to import Leicester or any other blood. They are without horns, white-faced, and closely resemble the Leicester; and Mr. Joseph Darby describes the difference in these terms:—"A well-bred sheep of this variety differs from a pure Leicester in having a longer and larger face, with greater

Points and  
Weights.

width at its forehead and nose, and the ears longer; the frame is more bulky and of far greater length, although not quite so round or compact; but will be found to girt to an equal extent as, if not more than, the Leicester. The Devon Longwool is also higher than the Leicester. In good constitution and hardihood the former surpasses the latter; it will attain much greater weight of carcass and more flesh in a given time, and is likewise reputed to come earlier to maturity." The same authority states that the wether hogs are fattened the first winter on turnips, coming out in the months of March, April, and May, weighing from 22 lbs. to 24 lbs., and in some cases 25 lbs. per quarter. They cut from 9 lbs. to 11 lbs. of clean-washed wool each, although shorn as lambs the preceding year. When high feeding is resorted to, the hogs ripen at earlier periods. The ewes are good wool-bearers, the fleeces of the best flocks averaging 8 lbs. to 9 lbs. each. The lambs cut  $2\frac{3}{4}$  lbs. to  $3\frac{1}{4}$  lbs. of wool each.

The ewes are prolific; the lambing season is early, namely, in January and early in February, and the generality of flock-masters wean in May.

The principal ram-breeders at the present time are Mr. Richard Corner of Torweston, Williton; Mr. R. Farthing, Mr. Bird, Mr. John Wippell, and Mr. Drew of Exeter.

*Cotswolds*.—Native to the Cotswold Hills of East Gloucestershire, which are said to have been so named from the cotes in which sheep were in very ancient times sheltered there, is a breed of sheep remarkable for its combination of massive proportions of frame with a constitution adapted to upland grazing on short pasture. The old Cotswolds were coarse, though colossal; and now the improved breed are the largest sheep in the world; high standing, with fine countenances, handsome locks of wool on their foreheads, long broad backs, characteristic overhanging rumps and full set fleeces, giving them a truly majestic appearance. They have, for the most part, white faces and legs, but some strains are mottled, and still fewer are grey or coloured. The Cotswold points appear in a large, lengthy, and wide frame; ribs specially well sprung from back and chine; level back, full-cushioned rump, good leg of mutton; chest and plaits full and prominent, but a disproportion in depth both in the forequarter and hindquarter as compared with some other breeds. The neck is rather long and arched upward; the head is long and broad; eyes are prominent; the face has a tendency to the Roman profile; and the crown of the head is well woolled, rams carrying locks which hang down in front of their eyes. These sheep stand high and have a noble carriage. Their mutton falls short of the best quality, and mainly from the want of a due intermingling of fat and lean; and their open curly fleeces

Points of  
Cotswold  
sheep.

are not at the present day renowned for length of staple or for weight. It is of less value per pound than either the lustre Leicester or Lincoln wool. Sometimes the weight of a hogget fleece exceeds 14 lbs.; but a good average clip, of which half is ewe wool, is about 9 lbs. per fleece.

Weight and wool.

Cotswold sheep are grazed thinly upon the land; nevertheless, in Mr. Lawes' experiments, some years ago, they were found to consume less food in producing a given amount of increase in weight, and made greater progress in a given time, in comparison with Downs. In the best flocks it is no unusual thing to see 12-month-old hoggets weighing 24 to 26 lbs. per quarter, dead-weight; and the average weight of wethers at 14 or 15 months old is 28 to 30 lbs. The weights to which old sheep may be brought is very great. Thus, Mr. Robert Garne fed a ram up to 86 lbs. per quarter; and in the year 1865, Mr. Barton showed at Cirencester an 8-months-old wether hogget weighing 35 lbs. per quarter.

Locality of the breed.

The Cotswolds have not spread over many districts of England, though they prevail in Gloucestershire, Oxfordshire, parts of Berkshire, Herefordshire, Wiltshire, Monmouthshire, and South Wales; and highly successful flocks have been established in counties as far off as Norfolk. They are in large demand for crossing, not only for producing graziers' lambs from Down ewes, but also to confer noble dimensions and vigorous constitutions upon many breeds at home and abroad, and are exported for this purpose to America, to our Australian colonies, and to New Zealand, as well as to various European countries. Probably as many as 4000 rams are sold by auction every year, while a great number are disposed of by private contract. The principal fairs for this breed are Burford, Stow-on-the-Wold, Marshfield, and Cirencester.

Breeders.

Among the most eminent breeders at the present time may be named Mr. William Lane, of Broadfield; Mr. Robert Garne, of Aldworth; Mr. G. Fletcher; Mr. J. Walker; Mr. S. Smith, of Somerton; Mr. C. Barton, of Fifield; Mr. Russell Swanwick, of the Royal Agricultural College Farm, Cirencester; Mr. Thomas Brown, of Marham Hall, Downham Market, Norfolk.

Ryland sheep.

The *Ryland* breed of sheep, now very limited in extent, is native to the district of dry soil and sweet herbage around Ross, in Herefordshire; but, with a few exceptional flocks in that locality, it is now found only on the colder and stiffer soils of that county, and in parts of Monmouthshire, Gloucestershire, Shropshire, and Warwickshire. The *Ryland* is a small, well-formed sheep, with white face and legs, and a tuft of wool on the forehead; short legs; broad loin; and is noted for the fineness of its wool. With the exception of the nose and feet, the whole

animal is covered with very fine and close wool; and is thus defended from the fly, which is a great pest to the flocks in a wooded country. The shearlings commonly weigh 18 lbs. per quarter, and twenty-months old wethers weigh up to 30 or 36 lbs. per quarter. Their mutton is considered a delicacy, in comparison with that of some other breeds.

*Southdowns*.—The small, short-woolled, hornless sheep, with dark-brown faces and legs, which are native to the Sussex chalk-hills, have been improved and moulded by many years of selection and care in breeding, particularly by Mr. Thomas Ellman of Glynde, Mr. William Rigden, the Duke of Richmond, Mr. Jonas Webb, Lord Walsingham, Sir N. W. Throckmorton, Lord Sondes, Mr. Heber Humfrey, the Prince of Wales, and Messrs. Heasman, till their light fore-quarters, long legs, and hanging bellies disappeared, and their points may now be thus described:—The head is rather short and small; the lips are thin, the chap or under-jaw is fine and thin; the ears are tolerably wide apart, not too thin and delicate, but well covered with wool; the forehead should be well covered with wool, especially between the ears, as a protection against the fly, and it should show no “slugs” or budding horns; the eye is full and bright, but not prominent; and the eye-cap or bone not projecting so that it might form an obstacle in lambing.

Southdown  
breeders.

Points of  
Southdown  
sheep.

The colour used to be speckled or grey; but a uniform dark-brown or snuff-colour now prevails; faces level in tint, with an absence of white hair, being preferred. Brown, varying to fawn, or nearly grey, distinguishes different flocks; and as a rule, the Sussex sheep have a lighter shade than Southdowns bred in other parts of the country or on richer soils. The Sussex sheep have also more wool on their cheeks than is the case with some large strains of Southdowns bred in other counties. The neck is of proportionate length, thin next the head, and enlarging towards the shoulders, where it should be broad and straight on the top, and not what is generally called ewe-necked. The breast should be wide and deep, projecting well forward between the fore-legs. This is considered an essential point with graziers, and in the prize pen, and gives the sheep a greater degree of weight, while it indicates a good constitution and disposition to thrive. The shoulders should be on a level with the back, and not too wide above. If the shoulder-blades are very wide on the top, it is generally found that the animal droops behind them. The back should be flat from the shoulders to the setting-on of the tail. The ribs should project horizontally from the spine, extending far backward, and the last rib should project more than the others. The rump should be long and broad; the tail set on high, and nearly on a level with the spine; the hips

wide ; and the space between them and the last rib on either side as narrow as possible, thus preventing the dropping of the belly. The legs should be of proportionate length ; the hind-leg full in the inside at the point called the twist ; the hock or hough turning rather out. The fore-legs should be straight from the breast to the foot, and not what is generally termed knock-kneed. The belly is well defended with wool, and the fleece comes down well to the knee and the hock. The wool is short, close, curled, and very fine, and free from projecting fibres ; and a skin, not blue, but of a nice cherry hue, is in favour. The Babraham and Merton Southdowns, developed and brought to perfection in the highly farmed counties of Cambridge and Norfolk, attain to larger size, with grander fore-quarters and greater expansion of frame, with specially well-formed shoulders, as well as broad loins, full rumps, and heavy legs of mutton.

Babraham and  
Merton South-  
downs.

Qualifications.

The ewes are prolific and are good nurses ; the breed is hardy, while possessing great aptitude to fatten, and is adapted for the active and working life of grazing the lofty Downs and traveling to manure the fallow and wheat lands. The mutton is proverbially delicious in grain and flavour, and fetches a higher price in the market than any other. From 12 to 14 lbs. per quarter was at one time considered a fair weight for a two-year-old wether, and the finished sheep was often four or five years old, when it weighed perhaps 18 lbs. or 20 lbs. per quarter. Now, the Southdowns are generally fit for the butcher at 13 to 15 months old, and up to the weight just mentioned ; while the dead-weight of two-shear wethers is 20 lbs. or 22 lbs., and up to 30 lbs. per quarter ; some at the Christmas shows appearing with still greater weights.

Weights of  
mutton and  
wool.

The fleece averages at least  $3\frac{1}{2}$  lbs. in the hill, and 4 lbs. to 6 lbs. in the lowland districts.

Southdown flocks have been established in several counties beside the south ; and some are found both in Scotland and Ireland. But the breed, like the Leicester, has proved of most value for its improvement of inferior or coarser breeds : and there are few, if any, short-woolled breeds in Britain which have not derived advantage from crosses of Southdown blood.

Hampshire  
Down sheep.

The *Hampshire or West Country Downs* are a new breed created by the crossing of Southdowns with the old Wiltshire Horned and Berkshire Knot sheep early in the present century. The fine symmetry, small bone, broad back and loins, and feeding propensity of the Sussex sheep were, with varying results according to the different flocks crossed, and the judgment exercised in selection and matching, united with the size, early maturity of growth, and hardihood of constitution of the Hants and Wilts



breed—which possessed great power of enduring long travelling and severe folding, hard keeping and hard working, as manure carriers for the light lands. Mr. Wilkinson (in his Report on Hampshire) describes the original breed as “worthy of being remembered. They were imposing-looking animals, long in leg, high in withers, sharp in spine, large, bony, narrow, with big heads, curling horns, and fine Roman noses.” Until about forty years since, the new breed resulting from the combination of these sheep with Southdowns had produced sheep of two dissimilar characters. In North and East Hampshire, according to Mr. E. P. Squarey, they were large, muscular, early matured animals, giving a fair quantity of wool of moderate fineness; the head large and well set on, of dark brown colour verging towards black, covered with coarsish hair, with Roman nose; the ears thick, of the same colour as the face, and an occasional tendency to recur to the original type by producing “snig” horns; the neck with greatly developed muscles, the legs with large bones, and sometimes the wool growing below the hocks and knees. White spots on faces, ears, and legs were avoided, if possible, by the ram breeders. But the Wiltshire breeders adopted a more largely framed and probably less handsome sheep, were less careful as to uniformity of colour, and did not discard ewes with speckled faces or ears, provided they had size and other good qualities. The Southdown flocks of Berkshire and Dorsetshire became to a great extent merged into the improved Hampshire or West Country Downs. Large areas of the Down pasture lands had been broken up, artificial manures were introduced, the growth of turnips, rape, vetches, trifolium, rye, and Italian rye-grass for sheep-feed, led the breeders generally to turn their attention to the Hampshire system of selling wether lambs in the late summer or early autumn, instead of keeping them till they were sold as shearlings, or still older, for less money than lambs now realise; and for early maturity and greater size the flockmasters crossed their Downs with the Hampshires. Latterly the Berkshire, Wiltshire, and Dorset breeders have produced sheep which for flesh and fleece are generally superior to those of the Hampshire flocks. The late Mr. Humphrey, of Oak Ash, near Newbury, achieved for the Hampshire Downs an improvement comparable to that which Mr. Jonas Webb accomplished for the Southdowns; and this work he commenced by using upon the Hampshires some of the largest rams from the Babraham flock. In Wiltshire, Mr. James Rawlence of Bulbridge, and Mr. Alfred Morrison of Fonthill; in Dorset, Mr. T. C. Saunders of Watercombe; in Hampshire, Mr. F. Budd of Hatchwarren, Messrs. J. and M. Arnold of Petersfield, Mr. J. Rigg, and Mr. J. N. Palmer of Cleddesden, are among the most cele-

Mr. E. P.  
Squarey on  
this breed.

Hampshire  
Down breeders.

Sheep fairs  
in Hants and  
Wilts.

brated breeders at the present time. The most famous fairs for Hampshire Downs are at Overton and Weyhill in Hampshire, and at Britford and Wilton in Wiltshire. At Overton lamb fair, about 65,000 are penned; at Weyhill, on an average, there are 125,000 sheep and lambs, divided into two fairs, the Wilts sheep keeping on their side of the turnpike, and the Hants on the other. At Appleshaw fair, of 100,000 sheep penned, about one-half are Dorset and one-fourth Somerset Horns, and the remainder Wiltshires.

Weight and  
wool.

As an example of the great weight attainable by the breed, it may be mentioned that Mr. Morrison's three shearling-wethers, which obtained the Smithfield Club cup as the best short-woolled sheep in the show in 1872, were estimated to weigh 70 lbs. per quarter. Tegs at a year old readily weigh 20 to 25 lbs. per quarter. The Hampshire and West Country Down wool is of fine quality but short staple, averaging about  $4\frac{1}{2}$  lbs. the fleece; but its value is probably a penny a pound lower than Southdown, and the colour of much of the wool in Hampshire is inferior, being stained by the red soil on which the sheep lie.

A first cross with Cotswold and Lincoln long-wools produces a very valuable graziers' sheep; indeed, Hampshire Downs are being largely used for the purpose in counties far from their native home. The Hampshire ewes are commonly disposed of, after three years' breeding, to breeders who put them early to long-wool rams and then fatten the ewes and lambs together.

Creation of the  
Oxfordshire  
Downs.

*Oxfordshire Downs.*—Barely half a century ago, Mr. Druce, of Eynsham; Mr. Gillett, of Southleigh; Mr. Blake, of Stanton Harcourt; and Mr. Twynham, in Hampshire, began the formation of a new breed, which should combine in perpetuity what crosses gave for one generation,—the weight of a Longwool sheep with the quality of a Down. Some Sussex blood may have been used; but the cross mainly employed as the foundation was that of grey-faced Cotswold rams upon Hampshire Down ewes. Putting the crosses together, by constant attention and weeding out of all unlikely animals and such as were at intervals "thrown back," a most successful result was ultimately attained; the type is now well fixed, and improvement goes on by selection without any admixture of strains from other breeds. This new breed is the latest as well as most remarkable product of the skill of modern breeders; and it certainly possesses, along with uniformity of character and hardiness of constitution, a large frame, aptitude to fatten, mutton of superior quality, and a heavy fleece of thickly set wool.

Points.

According to Messrs. M. Druce and Charles Hobbs, the characteristics of an Oxfordshire Down are seen in a nice dark

colour; the poll well covered with wool and adorned with a top-knot on the forehead; a good fleece of wool, thick on the skin and not too curly; a well-formed barrel on short dark legs (not grey or spotted), with good firm mutton. The ewes are good mothers, and drop a large proportion of twins.

The hogs or tegs are commonly sold fat, at twelve or thirteen months old, at a dead-weight of 20 to 24 lbs. per quarter. The weight of some of the exhibition wethers and rams, as those of Mr. A. F. M. Druce; Mr. Dale, of Marlborough; Mr. John Treadwell, and Mr. Charles Howard, have almost equalled that of the Lincolns and Cotswold Longwools. The average weight of fleece for a whole flock is about 7 lbs.; but shearling rams have clipped up to 20 lbs. per fleece. In 1872, Oxfordshire Downs won the champion plate of the Smithfield Club, as best in the Show. Weights and wool.

The breed is particularly adapted for close stocking, and for confinement entirely in folds. It prevails in the home and mid-land counties; the rams are largely employed for crossing with Hampshire ewes for early lamb; they are sold in considerable numbers to Scotland, Ireland, and various countries of Europe; and both at Oxford and other fairs, and at the auctions and private sales, the rams fetch high prices. Among the chief flocks at the present time are those of the Duke of Marlborough; Sir Henry W. Dashwood, Bart., of Kirtlington Park; Mr. A. F. Milton Druce, of Eynsham; Mr. George Wallis, of Bampton; Mr. John Treadwell, of Upper Winchendon; Mr. Charles Howard, of Biddenham; Mr. Rogers, Mr. Stilgoe, Mr. Charles Hobbs, Mr. Gillett, Mr. Gale, and Mr. George Street. Breeders.

*Shropshires*.—The original heath breeds of the Longmynd range, in Shropshire, and Cannock Chase, in Staffordshire, having horns and black faces, were improved first by Southdown blood and afterwards by selection, until the present Shropshire breed was established. Thus, two of the most celebrated founders of the breed were Mr. Samuel Meire, who made use of both Southdown and Leicester blood, and Mr. George Adney, who, beginning with sheep descended from a Southdown cross, brought his flock to extraordinary perfection by selection in breeding. It is only of late years that a real uniformity of type has been attained and adhered to; and all admixture of Down blood has for a long time been discontinued, as detrimental to the size and character of the breed. Origin of the Shropshires.

A Shropshire sheep resembles a Southdown, but is considerably larger and of greater substance; the face is longer and the ears are larger; the eye is prominent; the forehead is broad, flat, and well covered with wool; the colour of the face is uniformly dark, described as a softened black or very dark grey, inclining Points of the breed.

Weights and  
Wool.

to grey on the jaw ; and the legs are darker than the face. A light neck, unlevel back, spine not straight, upright shoulders, flat ribs, and light rump, are defects in the original stock which have been replaced by the very converse of each ; and the Shropshires are now noted for their symmetry, their grand backs, and their heavy legs of mutton. They carry fleeces of closer-set fine wool, longer in staple than that of the Southdowns. In good flocks the wool averages 6 to 8 lbs. per fleece ; hoggs clipping up to 12 or 14 lbs. Shropshire shearlings commonly weigh 20 lbs. or more per quarter ; and two-shears are fed up to 40 lbs. or more per quarter.

Locality.

They are more prolific than perhaps any other breed, except the Dorsets, the ewes dropping at least one-half twins ; and they suckle better than any sheep of larger breed. They are hardy, and particularly adapted for enduring a wet climate. Though not specially meritorious on the ground of early maturity, they yield flesh of close texture and fine flavour ; their mutton, for the intermixture of fat and rich dark colour, being equal to that of the Southdowns. The breed has extended very rapidly of late years in Shropshire, Staffordshire, Warwickshire, Worcestershire, Herefordshire, and the midland counties ; has been established in Leicestershire and Yorkshire, and very successfully in Ireland ; while rams are sent into many counties for improving inferior breeds and for crossing, to raise lambs for the butcher. Shropshires are the principal sheep at Shrewsbury and other fairs and markets in Shropshire and Staffordshire, and at the auctions of Mr. W. G. Preece, of Shrewsbury, and Messrs. Lythall and Clarke, of Birmingham. Rams at the private sales fetch exceedingly high prices. Among the principal breeders now may be named, Lord Chesham ; Mr. T. Mansell, of Ercall Park ; Mr. John Evans, of Uffington ; Mr. J. Coxon, of Freeford ; Mr. E. Crane, of Shrawardine ; Mr. T. Nock, of Sutton Maddock ; Mr. R. H. Masfen, of Pendeford ; Mrs. Beach, of Brewood ; Lord Wenlock ; Mr. J. Pulley, of Lower Eaton ; Mr. T. Fenn, of Ludlow ; Mr. H. Townshend, of Caldicote ; Mr. C. Byrd, of Littywood ; Mrs. Smith, of Sutton Maddock ; Mr. W. Orme Foster, of Apley Park ; Mr. H. J. Sheldon, of Shipston-on-Stour ; and Mr. S. C. Pilgrim, of Hinckley.

Dorset Horned.

*Dorset Horned*.—The native breed having been driven out of the chalk-region of Dorsetshire by the more thrifty Southdown and West Country Down, is found, for the most part, at the western end of the county on the fertile oolite and sand-loam soils with their good upland pastures, also on the rich sheep-pastures of southern Somerset, and scattered along the Dorsetshire vales which are ever green with water-meadows. The modern or improved Dorset sheep has descended from the original breed—neat,

well-shaped, thick-woolled, white-faced, with a tuft of wool on the forehead, and thin horns, rather bending backward—crossed with the larger Somerset horned sheep; and the most marked improvement in early maturity and grazing qualities have been made by skilful selection during the last twenty years, notably by Mr. H. Mayo. Dorsets are unrivalled for producing the earliest fat lambs for the London and other markets, as the ewes when highly fed will take the ram in April, or at almost any period. They drop a greater proportion of twins and triplets than any other breed, and are most excellent nurses. The lambs yeaned in October or November are, with good feeding, generally ready for the butcher in about ten or eleven weeks, and the ewes quickly fattened afterwards attain to 20 or 25 lbs. per quarter. Southdown rams are generally used when the object is to produce lambs for winter killing. Dorset sheep are usually shorn in the middle of June, when the ewes yield 5 to 6 lbs. of wool, and the lambs  $2\frac{1}{2}$  to 3 lbs. The value is about the same as that of Devon wool; and, according to Mr. Paull, the Dorset lamb's wool is sought after for its peculiar whiteness and the fine point it has. Graziers from the metropolitan counties, from Hampshire, and from the Isle of Wight, purchase large numbers of Dorset ewes at the Wilts and Hants fairs, for the production of early or house-fed lamb.

Early Lamb.

*Exmoors.*—Native to the lofty hill region of West Somerset is the Exmoor or Porlock breed of sheep—with white faces and legs; taper horns, curving downward and outward; close-set, long-stapled fleeces, with wool well up to their cheeks; peculiarly rounded instead of square-formed carcass; broad loins, though with slack girth behind the shoulder; high necks; and famed for their fine-flavoured mutton, and for their very strong constitution, which enables them to endure great cold and privations during protracted falls of snow.

Exmoor sheep.

The ewes are prolific, and excellent nurses; but the breed are sluggish feeders. The common sorts, fat at three or four years old, weigh 12 lbs. to 15 lbs. per quarter; and the fleece weighs 5 lbs. or 6 lbs. But great improvement has been effected during late years by careful and judicious in-and-in-breeding, by Sir Thomas Dyke Acland, Lord Poltimore, Mr. James Quartly, Mr. R. Stranger, Mr. Robert Paramour, and Messrs. Tapp; and eighteen-months old wethers from the flocks of these breeders now weigh 20 lbs. per quarter; while older sheep attain 28 lbs. per quarter.

*Welsh Mountain Sheep.*—Attempts to supersede the native sheep of the Welsh mountains, which vary, but are not materially different, in the northern and southern counties of the Principality, have not been successful. Mr. Morgan Evans de-

Welsh mountain sheep.

scribes their characteristics thus :—They are principally white-faced, but some have rusty-brown faces, some speckled, and others grey. The males are horned, and the ewes generally hornless, though they sometimes have very short horns, and are occasionally found with horns equal in size to those of the rams. The poll is generally clean; but sometimes a tuft is found on the forehead of the ram. The head is small and carried well up; the neck is long, and the poll high. The shoulders are low, the chest is narrow, the girth small, and the ribs are flat. The rump is high, and the tail long. The average weight of ewes is about 7 lbs. per quarter; the wethers weigh, at three years old, 9 lbs. to 10 lbs. per quarter, dead-weight. The mutton is famous for its delicacy. The average clip of wool is about 5 lbs. per fleece; the quality, as a rule, is fine, but in some districts coarse and mixed with long hairs about the neck and back. The ewes generally produce only a single lamb, but are excellent nurses. Crosses of Welsh sheep with Leicesters or Downs are found valuable on the lowlands, and many Welsh sheep are sent to English counties to breed fat lambs.

Radnors.

*Radnor Sheep.*—In the county of Radnor, on the hills of Brecon, and in the western part of Montgomery and parts of Merioneth, remains a breed of the native dark-faced sheep of Wales,—a hardy active race, developed by good management and selection into animals of larger size than the ordinary mountain sheep, and carrying heavier fleeces. They have been improved by the introduction of a cross of Shropshire and of Leicester blood. The old breed, says Mr. Morgan Evans, was very small; and a great point with breeders was a very large tail, heavily woolled, and a quantity of coarse wool or hair about the breech. The best kinds of Radnors have black faces; but many are of a tan, grimy, or grey colour, and some, of questionable purity of strain, have faces partly white. The rams are horned; the ewes should be hornless. They are short-legged, light in forequarter, and, though slow feeders, yield mutton of excellent flavour. At three or four years old the wethers weigh 14 lbs. or 15 lbs. per quarter, dead-weight. The wool, of fine quality, weighs 4 lbs. or 5 lbs. per fleece. The ewes are prolific, and very good nurses.

The principal fairs for Radnor sheep are, Kington, Knighton, and Builth; and large numbers of ewes are sold to adjoining English counties to breed fat lambs, by crossing with Shropshire, Leicester, or Cotswold rams.

Cheviots.

*Cheviots.*—Whether this breed were native to the range of hills of that name situated partly in Northumberland and partly in border counties of Scotland, or whether they sprang from a few sheep which were cast ashore on the Western Isles from the ship-



wrecked Spanish Armada,—it is known that they occupied most part of the mountain pastures in the south of Scotland, as well as on the hills which gave them their name, for a long time before the commencement of the great improvement of the breed in the latter half of last century. The old Cheviots—small, light, ill-formed animals, with brownish-white heads and legs—of very hardy constitution, were completely remodelled by Mr. Robson, of Belford, who crossed them with rams obtained from Lincolnshire; some authorities considering that these were Bakewell Leicesters, others maintaining that they were some of the lighter kind of Lincolns. The modern Cheviot somewhat resembles the Border Leicester, with a thinner neck and lighter forequarter. The faces and legs are white; though individuals occur in the purest flocks in which the colour is mottled grey or a light dun, considered to indicate superior hardiness. Both sexes are destitute of horns, though a “snig” is sometimes found upon the ram. The head is erect, long and clean; and while the neck and throat should be well covered with wool, none must appear on the head. The eye is lively and prominent; the ears are long, open, and well covered with hair. With these different features combined must be exhibited a fine, open, and sprightly countenance, with every indication of hardiness. The legs are moderately long, clean, and fine; the hindquarters are full and well proportioned; the rump is full; the tail is neatly set, long, and well covered with wool, which reaches to the hocks. The body is lengthy; and there is a tendency to lightness in the forequarters, though this is a defect which careful breeding has done much to obviate. The neck and chest should be full; the ribs rounded, and well filled up behind the shoulder. The pelt is thin, and covered with uniformly fine wool, free from dead hairs, coming well down on the quarters, forward on the neck, and completely covering the belly. The fleece, of soft wool of medium length, used for the manufacture of tweeds, weighs, on an average of a good flock, about  $4\frac{1}{2}$  lbs., the weight and fineness depending greatly upon the nature of the herbage on which the sheep are grazed—dry sweet pasture giving a finer texture than coarse grass. Ewes, when fat, generally weigh from 14 lbs. to 18 lbs. per quarter, dead-weight; wethers 18 lbs. to 20 lbs. per quarter, or more, at three years old, fed on artificial food. The mutton is esteemed a delicacy.

They are prolific breeders and good nurses; and are excelled in hardiness at great altitudes, and in power to endure mountain storms, only by the Black-faced breed. They now occupy most of the mountains in the south of Scotland, and in the north prevail in Sutherland, Caithness, and Ross-shire. The great fairs and sales for them are Falkirk, Melrose, Lockerbie, Moffat, Inver-

Points.

Fairs.

ness, Beattock, Hawick, St. Boswell's, Kelso, and Brough Hill. High figures are made for Cheviot rams, which are largely used for crossing with the Border Leicester, the breeds being mixed in different proportions according to the altitude and temperature of the district. Among the principal breeders may be named Mr. Aitchison, of Lynhope; Mr. Bryden, of Kennelhead; Messrs. Carruthers, of Kirkhill; Mr. Elliot, of Hindhope; Mr. Johnstone, of Cappelgill; Mr. John Robson, of Otterburn.

Black-faces.

*Black-faced, Heath, or Scotch Mountain Sheep.*—It is not certain whether this breed was imported from some foreign country to Ettrick Forest by a Scottish king (as tradition relates), or whether it is due to an improvement of the ancient "dun-faces," with brown or tawny hair on their faces and legs, with light forequarters and long tails, which were at one time the most prevalent sheep in Scotland. The Black-faces attained to their present character and high degree of improvement in Lanarkshire and the south-west of Scotland. They prevail also on the higher grounds in the West Highlands and in the midland districts of Scotland; and, though Cheviots have displaced them to a considerable extent, they are still best adapted, by their constitution and peculiar instincts and habits, to the loftiest and bleakest sheep-walks, being found by the mountain tarns and peat-bogs at great altitudes, where the herbage is of the coarsest description, where the storms are furious, the snows deep, and the cold severe. Both sexes have horns. The horns of the ram are of large size, arched, and springing well out from the head, each making two spiral twists, inclining outward, downward, and forward; the horns of the ewe are not spirally twisted, but flat, and are turned clear of the side of the head. The face and legs are black, or black and white, one or other colour predominating, instead of equal patches of both. The face is long and clean, the muzzle is free from wool, and a Roman profile is preferred; the eyes are full of life and fire; the ears are moderately long; the shoulders being high, the neck is sometimes too low as well as long; the back is rather short, and the breadth is not great nor are the ribs particularly well sprung; the frame is deep, and the hindquarter is well-shaped and full.

Founts.

The character of the fleece is the reverse of that of other mountain breeds; for instead of being short, close-set, and fine in staple, the wool is long, soft, open, and waved; coming low down on the thighs and forelegs, so that a ram's wool hangs within two or three inches of the ground. It is free from black spots and "kemps," or hard, wiry, white hairs, which are destitute of the felting property of wool. The quality is coarse, and it is used principally in the manufacture of carpets. The fleece commonly weighs  $3\frac{1}{2}$  lbs. or 4 lbs. The wethers at

three years old are fattened on turnips to about 18 lbs. per quarter, dead-weight; but they can be brought to much greater weight. The quality of the mutton is very fine.

Black-faces are in great demand for crossing with Leicesters. The principal fairs for them are at Lanark, Falkirk, Inverness, Kirriemuir, Stagshaw, and Brough Hill. Among the most eminent breeders are Mr. Archibald, of Overshiels, Stow; Mr. Aitken, of Listonshiels, Mid-Lothian; Mr. Malcolm, M.P., of Poltalloch, Argyllshire; Mr. Moffat, of Gateside, Dumfriesshire; Mr. Murray, of Eastside, Pennicuik; Mr. Craig, of Polquheys, Ayrshire; Mr. Greenshields, of Westown; Mr. Christopher Armstrong, of Alston, Cumberland. Fairs.

*The Lonk Breed.*—Less hardy than the Black-faces, but similar in some respects, are the Lonk sheep pertaining to the fells of Lancashire and Yorkshire, and parts of Derbyshire. The face and legs are streaked with black and white; the yellow horns are strong and curled, but finer than those of the Black-face. The carcass is long, the deficiencies in form being in the light forequarter and narrow loin. The wool is very superior to that of the Black-face, and weighs  $4\frac{1}{2}$  lbs. or 5 lbs. per fleece on an average; artificially-fed Lonk wethers clipping 7 lbs. to 8 lbs. Three-year-old wethers are commonly killed at 18 lbs. per quarter, dead-weight; Show sheep, of course, make double the weight, or more. Lonks.

Among the principal breeders are Mr. Jonathan Peel, of Knowlmere Manor, Clitheroe; Mr. George Dewhurst, of Rawtenstall, Lancashire; Messrs. John Green and Son, of Tilsden, Leeds.

*Herdwicks.*—Tradition attributes the introduction of this breed into Cumberland by the shipwreck of a Spanish vessel on the coast, near Duddon Sands, and it existed in the neighbourhood for a long time before it spread and displaced the native Fell sheep in Cumberland, Westmoreland, and parts of Lancashire. On the authority of Mr. H. A. Spedding, of Mirehouse, Keswick, the legs and faces of the lambs are black, or black with a few white flecks; but by the time they are two years old all the black has become frosty or silver-grey, darkening slightly toward the forehead, except a blue-black mark or patch at the back of the neck, any brown tinge being a defect, as indicating a lesser degree of hardness in the animal. In every flock there are darker coloured sheep, but a black tinge is not objected to. The eye is bright; the forehead has a tuft on it; the ears are white and sharp, and the wool should come well up to them—in the case of rams forming a kind of wave of a dark colour. The fore legs are wide apart; the breast is well forward, and the body is well ribbed up, the commonest defect being a slackness behind the shoulder. The Herdwicks.

hind legs are straight, and well muttoned down to the hocks ; the knees and feet should be large, the feet white, and the bone fine. A Herdwick should stand square and walk well. The ewes are not horned ; but the rams generally are, though not always ; the horns should be waxy and white, and, rising well out of the head, curl once or twice. The mutton is very fine in texture and flavour ; but the wool, of short staple, is coarse and open, and only somewhat better than that of the Black-faces. Of late years it has been so improved as to be nearly free from "kemps" or grey hairs, but it is still greyish in colour.

The average dead-weight of four-year-old wethers, grazed on the fells, varies from about 12 lbs. to 15 lbs. per quarter ; on better pasturage they make 20 lbs. per quarter, and Show specimens up to 25 lbs. per quarter. A common average weight of fleece is  $3\frac{1}{2}$  lbs., though when there has been no overstocking, the average of 4 lbs. is obtained ; and this has been exceeded in some cases.

These sheep climb and leap upon steep rocks, picking the shortest possible bites of herbage ; in which respect they surpass the Black-faces. And it is to their credit that their natural feeding grounds are very inferior to those of the Lonks.

Among the chief breeders are Mr. Edward Nelson, of Gatesgarth, Buttermere ; Mr. C. W. Wilson, of High Park, Kendal ; Mr. George Browne, of Troutbeck, Windermere ; Mr. William Leathes, of Lamplugh Hall, Cockermouth.

Local breeds  
not altogether  
superseded.

In the foregoing brief sketches I have included what I believe are all the distinctive breeds of sheep in England and Wales ; but over large portions of many counties the breeding flocks consist of old local races, improved by generations of crossing, —as, for example, in Norfolk and Suffolk, where Southdowns prevail in some districts, while in others the ewes are of a strain improved by Southdown blood, but retaining some of the characteristics of the native sheep with black faces which are now rarely seen.

### PIGS.

Ancient  
varieties of  
pigs.

The prevailing English hog in very ancient times was undoubtedly a big, long-limbed, coarse-boned, low-shouldered, narrow-backed animal, with huge flop ears and a covering of strong bristles ; and the colour was mostly white, or blue-and-white, or black-and-white. Whether the smaller pointed or prick-eared varieties have existed quite as long, though less extensively distributed, or were subsequently introduced, is an open question. But it is certain that great improvement in native English breeds was effected by crossing with foreign pigs, more especially Chinese and Neapolitan.



Until late years many counties had their distinctive varieties of pigs. The most gigantic breed was that of Cheshire—of which there is a record of a specimen, just a hundred years ago, which weighed, when dead and dressed, 86 stones and 11 lbs., imperial. Next, for colossal proportions, came the Lancashire, Yorkshire, and Lincolnshire sort; and the Rudgwick breed in Sussex and Surrey. Large breeds, also with characteristic peculiarities of form or colour, were peculiar to Kent, Hampshire, Wiltshire, Berkshire, Gloucestershire, Herefordshire, and Shropshire. Breeds of smaller size pertained to Essex, to Norfolk, and to Suffolk; and it is considered that Robert Bakewell wrought a great improvement by refining the large Leicestershire pigs of his day.

During the last quarter of a century, and mainly owing to the stimulus given by the Royal Agricultural and other great shows, the breeding of pigs has been brought to such perfection, and the best and most profitable kinds have been so rapidly multiplied, that most of the old breeds have been displaced or completely remodelled by crossing; and at the present time it is difficult to find any really distinctive breeds, except the Berkshires, the improved Dorsets, the Tamworth variety, and the Suffolk and Essex blacks; and the remainder are classified together as large-breed, middle-breed, and small-breed, principally Yorkshire.

*Berkshires.*—Neither for small porkers nor large bacon hogs, Berkshires. nor for marvellous development at a very early age, can the Berkshires be pronounced equal to some other breeds; but as a middle sort, adapted both for young pork and older bacon, arriving early at maturity, hardy, and thrifty in the farmyard or the field, and with a specially large proportion of lean meat in relation to live weight, this breed during the last twenty years has attained a distinction above all others, and has been more extensively bred for show purposes, as well as more widely adopted or employed for crossing, than any other breed.

The points are described by a most excellent authority, Mr. Mr. Coleman's  
description. John Coleman, of Riccall Hall, York, thus:—"Head moderately short; forehead wide; nose slightly dished, straight at the end, not *retroussé* as in the small breeds; chaps full; ears slightly projecting, occasionally pendant and covering the eyes. Prevailing colour black, white blaze down the nose or white star on the forehead; sometimes uniformly dark; but this is the exception, and never the dead black of the Suffolk or Essex breeds. The pink tinge should be always apparent. The eye is not sunk and closed, as in the breeds remarkable for feeding properties, but large, intelligent, and denoting activity. General effect pleasing. The head is well set; the neck, of moderate

length, is full and muscular; the shoulder well set—so that we have a perfectly regular outline. There is not the extraordinary wealth of chine which is seen in the Suffolk, but the forequarters are well proportioned. Occasionally we find a slight deficiency in the girth, caused by the flatness of the fore ribs. The back is fairly level, and the ribs, as a rule, tolerably sprung; a less perfect barrel, however, than is to be found in the Essex and Suffolk blacks. Loins wide and well covered; quarters often rather short and drooping, this being probably the weakest point in the breed. The tail is usually set lower than the hips, which gives a somewhat common character. The gammon is full and deep; underlines somewhat irregular; the flank is often light. The carcass stands on short legs; and the bone, whilst stronger than in the small sorts, is well proportioned. The strength and character of the coat vary according to sex and management. The effect of confinement and close breeding is to reduce the hair. Bristles indicate a thick skin, coarse offal, and slow feeding; on the other hand, thin, weak, soft hair is a sure evidence of delicacy, especially in the boar. The boar should have plenty of hair; though in the sow, fine long hair is desirable. If the pig is to work for its living, and to officiate as the scavenger of the farm, there must be constitution; and we cannot have this without hair. The great merit of the Berkshires over most other breeds consists in the large proportion of lean meat, and the distribution of fat and lean when properly fed; consequently a given live-weight realises a larger proportion of available meat than in any other breed."

The average dead-weight at a year old may be about 320 lbs.; but specimens have exceeded 500 lbs. at that age.

Breeders.

Among the most noted breeders of Berkshire pigs are Mr. Joseph Smith, of Henley-in-Arden, Warwickshire; Mr. Heber Humfrey, of Shrivenham, Berkshire; Mr. Arthur Stewart, of Gloucester; Mr. Richard Fowler, of Broughton Farm, Aylesbury; Mr. John Pittman King, of Wallingford, Berkshire; Messrs. Harris and Biggs, of Cublington, Bedfordshire; Lord Chesham; Mr. Nathaniel Benjafield, of Motcombe, Dorset; Mr. William Hewer, of Sevenhampton, Wiltshire; Mr. Russell Swanwick, of the Royal Agricultural College, Cirencester.

Tamworth  
pigs.

The *Tamworth* breed are a valuable kind, mainly differing from the Berkshire in their tawny or ruddy colour. Among the chief breeders of this sort are Mr. Edward Lowe, of Comberford, Tamworth; Mr. Henry Sharp, of Packington, Coventry; Mr. Peyton, of Four Oaks, Sutton Coldfield; and Mr. R. H. Masfen, of Pendeford, Wolverhampton.

Improved  
Dorsets.

*Improved Dorset Pigs.*—This black breed is remarkably com-



pact in form, wide across the shoulders and loins, with short neck, small head, short nose, heavy chop or cheek, short legs and thin skin, which, however, is deficient in hair. These pigs give very productive litters, will thrive on very moderate fare, and have a wonderful tendency to fatten. At five months old the dead weight is sometimes 10 imperial stones; at nine months old 20 stones and more have been attained; at twelve months old an average dead weight is 25 stones; and more than 40 stones has been reached at 18 months old.

The origin of the breed is remarkable. Mr. John Coate, of Hammoon, about thirty years ago began to breed from two black sows imported from Turkey, put to a Chinese boar; and their offspring were crossed with a Neapolitan. About the same period Mr. J. Azariah Smith, of Bradford Peverell, began a herd with a black sow of Chinese blood, crossing with an Essex black from the stock of the late Mr. Fisher Hobbs. The improved Dorset pigs take a very high position at the Smithfield Club and other shows.

*Improved Essex.*—These are a black small breed, obtained in the first instance by crossing the native pigs of the country with black Neapolitan and black Chinese. They have small, fine, upright ears, rather long and pointed heads, are not so full and thick in cheek and throat as some other breeds, are not particularly short on the leg, and have little hair. But they are perhaps the earliest and quickest feeders yet produced. They were brought to great perfection by Lord Western and the late Mr. W. Fisher Hobbs. Essex pigs.

*Black Suffolk.*—Both Norfolk and Suffolk had native varieties of small, short, low-standing, prick-eared pigs, generally white in colour; but within about twenty-five years the black Suffolks have attained great celebrity, principally from the breeding of Mr. Thomas Crisp, of Chillesford Lodge; the late Mr. J. Crisp, of Butley Abbey; Mr. G. M. Sexton, of Wherstead Hall, Ipswich; and Mr. S. G. Stearn, of Wickham Market. The black Suffolks have a broad forehead, short and slightly upturned nose; rather short ears, drooping a little forward; jowl very full; grand shoulders; a long body; the tail set on level with the hips; hams wide and deep; a remarkably symmetrical carcass standing on short legs, and with an abundance of long fine hair, indicating strong constitution along with their great aptitude for fattening quickly. They are fairly prolific. Great prices have been realised for both boars and sows for establishing the breed in many parts of the United Kingdom, for improving ordinary stock, and also for exportation. Suffolk pigs.

*Large White Pigs.*—Yorkshire, Lancashire, Lincolnshire, and Leicestershire are the principal, though by no means only, Large-breed Whites.

districts in which prevail the large variety of pigs, descended, probably without cross, from the ancient British breed. It may be, however, that the Yorkshire pigs received their first important improvement from Leicestershire animals which had been selected and refined by Bakewell. They were a wonderfully prolific breed, yielding litters of sixteen to eighteen, but were very slow feeders. However, as bacon hogs at two or two and a half years old, they attained a dead-weight of 40 imperial stones, and have frequently exceeded 50 stones. The sort is more symmetrical in form, though flatter-sided, than the Berkshires or Suffolks; the carcass is lengthy, the back level, shoulders are full, but hindquarters drooping; the head is long and large, the ears are big and overhanging; the hair is not so plentiful as in the smaller breeds. Among the most noted breeders of the Large-breed pigs are Mr. W. B. Wainman, of Carrheads; Mr. R. E. Duckering, of Kirton Lindsey, Lincolnshire; Mr. Peter Eden, of Salford; the Earl of Ellesmere; Mr. Jacob Dove, of Hambrook, Bristol; Messrs. J. and F. Howard, of Bedford.

Small-breed  
Whites.

The *Small White* breed are now found in many counties beside Yorkshire, as, for instance, in Berkshire and in Suffolk. They were moulded into their present perfection, as small porkers, by the late Mr. Samuel Wiley, of Brandsby, Yorkshire; by Lord Wenlock, Earl Ducie, Sir George Wombwell, and by Mr. Crisp, in Suffolk; and have perpetuated their fame in the hands of such successful breeders and exhibitors as Mr. Peter Eden, the Earl of Ellesmere, the Earl of Radnor, the Queen, and Mr. W. Wheeler, of Long Compton, Warwickshire. They are not very prolific, are somewhat delicate, and do not attain to great weights; but, when fully grown, they maintain their condition upon a minimum of food, their flesh is of the choicest quality, and they are largely used for improving the large breeds by crossing. The points of the breed are admirably described by Mr. John Coleman, who says: "The snout should be dished, and so small that when the animal is fat all we see are the upturned nostrils; these should be small; the forehead flat and broad. In fat animals the eyes are invisible, their position being indicated by creases of fat; but in store animals the eyes should be large and lively. Great importance attaches to the size and form of the ears, as by no other mark can we so accurately determine the purity of the breeding; they must be small, and not drooping, but slightly inclined forwards, set widely apart, and covered with short soft hair. In order to complete the short handsome head, the chops must be full and large. The neck is remarkably full, and the head set well on, at a somewhat lower level than the

Points.

line of the back. The shoulders are wide and well covered, sloping back into the carcass. The ribs are full, and the loins wide; the tail set on high. The hams are deep and square, meat down to the hocks, bone fine, and offal light. They are remarkably heavy according to size, and very complete for their age; the coat varies as to length and character, from the thick short staple to the long curly sort which is not so closely set." Imposing specimens of early maturity and fatness are exhibited under six months old.

The *Middle-breed Whites*, not yet established into a fixed type between the large and small breeds, are being extensively adopted as specially valuable for all the purposes of profitable farm-stock, combining early maturity; hardiness of constitution, prolific breeding and good nursing, aptitude to feed, size and weight, and excellent quality of flesh, with fat and lean well intermixed for both young pork and matured bacon. They are more nearly allied to the small than to the large-breed pigs in the shape of the head, though the nose is not so upturned; the ears are larger, and the cheeks are not so full. They are very long and level, with great depth of carcass; their legs are of moderate length, and the bone is moderately fine. They have generally a covering of soft and thinly set hair.

Middle-breed  
Whites.

The Earl of Ellesmere, Mr. Peter Eden, Messrs. Duckering, and Messrs. J. and F. Howard, of Bedford, are among the most eminent breeders and exhibitors at the present time.

## HORSES.

Witnessing the magnificent classes of hunters, hackneys, and harness-horses, thoroughbred sires, brood mares, cobs, and ponies, at the Shows of the Royal Agricultural Society, of the Yorkshire and Lincolnshire Agricultural Societies, and of the Bath and West of England Society, visitors might naturally suppose that the breeding of such horses forms one of the most prevalent, popular, and profitable features in English farming. And it is true that tenant-farmers as well as gentlemen and squires breed a considerable proportion of the hunting, nag, and army horses and trotters of the kingdom; and that while limited to no particular localities, provided there be a suitable country of mixed arable and pasture, this branch of the farmer's business is of special importance in certain counties,—as in Yorkshire (celebrated for its Cleveland bays), in Lincolnshire, in Norfolk and Suffolk, in the midland counties, and in many other parts of England, where almost every farmer of medium-sized or large occupation keeps at least one brood mare, sometimes several, and hunts with the packs of hounds in his neighbourhood.

Horse-  
breeding.

Somersetshire, again, boasts of a valuable breed of ponies, the "Exmoors;" and the Welsh ponies, too, are bred in large numbers on their native mountains. Some of the greatest fairs for riding and carriage-horses are at Horncastle; Lincoln; Howden and Northallerton, in Yorkshire; Brough Hill, in Westmoreland; Newcastle-on-Tyne; and Rugeley, in Staffordshire.

But, in spite of the growing demand and increasing prices for first-class, handsome, and stylish horses, there has been a decline in their production, and the importance of the subject lately commanded an inquiry by Parliament. Apart from the scarcity of valuable and sound stud-stallions, a difficulty is that the tedious and risky character of nag-horse-breeding render it a special or fancy rather than profit-making department of agricultural business.

More attention, however, is given by farmers to the improvement of draught-horses for light and heavy work, not only for the tillage and hauling of the farm but for labour on the road, —including the hundreds of thousands of horses, from strong coachers to massive drays, which are purchased for slow and fast draught-work in vans, drays, waggons, and vehicles of all kinds, both in town and country.

Suffolks.

*Suffolk Cart-horses.*—One of the few really distinctive breeds of agricultural horses is the Suffolk Punch, now almost invariably of a chestnut colour, though occasionally sorrel or bay; of medium size, standing 15 to 16 hands high; distinguished for compactness of form, roundness of barrel, with legs short, clean, and peculiarly free from hair. They are active steppers, and steady in pulling heavy loads; their strength of constitution enables them to labour in the collar for longer periods without food than can probably be endured by other breeds; and they have a special aptitude for getting quickly into condition. But they are said to be more liable to strains of the sinews and the joints than most other breeds. Mr. Manfred Biddell, of Playford, Ipswich, is the authority for the following details as to the points for a good Suffolk. Colour: chestnut golden, or red hue preferred; free from white on the legs, but a white star or shim on the face rather approved than objected to. A few white or silver hairs, well blended with chestnut on the back and hind-quarters, belong to a certain strain of the breed, and have not been objected to; but these must be in too small quantities to be confounded with a roan colour. Height: varying from 15 hands 3 inches to 16 hands 2 inches, on short flat legs, with short strong pasterns, free from much long hair; hard clean legs, with bone of compact quality, being desired rather than large, soft legs. The shoulders very long, laying rather forward

Points.

to suit draught purposes. The hindquarters long, heavy, well and close-coupled with loin and back, having the legs well under the horse. The girth should be large, and the flanks well drooped. If the forehead is a little low, this is not objected to, provided the neck is strong and the head well forward and carried with spirit. In all other respects a Suffolk should be long, low and wide.

The Suffolks have, for many years, been great winners of Breeders. prizes at the Royal and other important Shows, and have lately attained to the distinction of a "Suffolk Stud Book." High figures are paid for horses from the most eminent breeders—among whom are Mr. Richard Garrett, of Carleton Hall, Saxmundham, Suffolk; Sir Edmund C. Kerrison, Bart., of Brome Hall, Scole; Mr. Manfred Biddell, of Playford, Ipswich; Mr. Herman Biddell, of the same place; Mr. Horace Wolton, of Newbourn Hall, Woodbridge: Sir Richard Wallace, Bart, M.P., of Sudbourne Hall, Wickham Market; Mr. Alfred Cracknell, of Thornham, Eye; Mr. William Byford, of Glemsford. The principal fairs for Suffolk horses are at Ipswich, Woodbridge, Stowmarket, Bury St. Edmunds, and Colchester.

*Clydesdales.*—Native to Lanarkshire, Renfrewshire, Dum- Clydesdales. bartonshire, and Ayrshire, or perhaps developed many years ago from a crossing of imported Dutch with the old British pack-horse, is the Clydesdale breed of horses, which has attained to great fame, and is eagerly sought after for improving the cart-horses in many parts of England; while stallions are purchased at exceedingly high prices, both for home use and for exportation to America, other foreign countries, and our own colonies. Of greater size than the Suffolks, standing sixteen Points. hands high, or somewhat more, the powerful Clydesdales are remarkable for their activity and for their peculiarly long stride in stepping; so that their natural pace is brisk, rendering them specially adapted alike for service at the plough and in the farm-cart. For such a heavy and strong horse, the Clydesdale has a fine head, grand arched and muscular neck, oblique shoulders, strong fore-arms, legs moderately clear from hair, deep chest, straight broad back, well-sprung ribs, with a less girth and lighter barrel than the Suffolk, but with better quarters, and tail well set out—this being commonly docked short in Scotland. The prevailing colour is bay or brown, though both black and grey are common. The characteristic defects of the Clydesdales are long legs and light bodies; but these have been to a great extent eliminated by the breeders during late years. They are good-tempered, occasionally found to be hot workers, but are probably able to plough a greater breadth of light and medium soil than any other breed; though they may require

better keep than the Suffolks. A society, with a "Clydesdale Stud Book," has been established under the leadership of the Earl of Dunmore, Lord Rosebery, the Duke of Richmond and Gordon, and other eminent breeders.

Breeders.

Among the most noted studs are those of the late Sir W. Stirling-Maxwell, at Keir, Dunblane; Mr. Lawrence Drew, of Merryton, Hamilton, Lanarkshire; Lord Polwarth, of Mertoun House, St. Boswell's; Mr. R. Tweedie, of Catterick, Yorkshire; Mr. Muir, of Loch Fergus, Kirkcudbright; Her Majesty the Queen.

The principal fairs for Clydesdales are at Glasgow, Rutherglen, Dumfries, Edinburgh, and Ayr.

Old-English or Shire-bred.

*Old-English or Shire-bred Horses.*—Under this inexplicable, or, at least, indefinite and inadequate designation, are classed the modern representatives of the old English heavy cart- and dray-horses, once distinguished as the black horses of the Lincolnshire and Cambridgeshire fens, and of Leicestershire and the midlands. They embrace a variety of types—from the ponderous and slow moving dray-horse, standing  $16\frac{1}{2}$  or 17 hands high, of immense weight and with an excessive quantity of long hair over his fetlocks, to the still heavy and powerful but more compact agricultural draught-horse, and a lighter and more active style of horse for the farmer's plough-team; and in the exhibitions of the Royal Agricultural Society these are grouped indiscriminately together as "Agricultural Horses not qualified to compete as Clydesdale or Suffolk." Black used to be the prevailing colour; but brown and bay are now more frequent, while there are many greys and roans, and some chestnuts.

Points.

Mr. Frederick Street, of Somersham, Huntingdonshire, thus described to the Farmers' Club the points desirable:—"A stallion should not stand more than 17 hands high; he should girth from 7 feet 9 inches to 8 feet 3 inches, and should not measure less than 11 inches below the knee. He should have a wide chest, shoulders well thrown back; a big and masculine head, with full flowing mane; a short back; large muscular development of the loin; long quarters, with tail well set on; good second thighs; large flat clean hocks; flat bone; short between fetlock and knee; not too long or straight in pastern, the feet firm and wide at the heel; and plenty of long silky hair on the legs. A horse should be long, low, and wide; and a main point being action, he should be a good mover in the cart-horse pace, walking, and if required to trot should have an action like a Norfolk cob."

The heavy Old-English horses, surpassing all others for power (no clean-legged breed possessing such bone), are not only valuable for the most difficult farm-work, but command high prices



for heavy draught purposes in towns. They are said to be more predisposed than some other breeds to weak feet and side-bones, and they are not so thrifty of food as the Suffolks.

No grander draught-animals exist than are bred in the Great Level of the Fens, and in some of the bordering and midland counties; the largest and most massive horses in the world being supplied by them to the London market and to other great cities of the kingdom. Of late years they have been more carefully bred with reference to pedigree and the avoidance of hereditary disease; and it has just been determined by the breeders to establish a Stud Book, an association for the purpose having been formed, with the Earl of Ellesmere as President.

As these agricultural horses are by no means confined to eastern and central England, it is not possible to enumerate the breeders who have attained to celebrity in the prize-rings of the great Societies; but I may name a few—as the Earl of Ellesmere, Earl Spencer, the Earl of Macclesfield; Mr. F. Street, of Somersham, Huntingdonshire; Mr. Nix, of the same place; Messrs. Vawser, of March, Cambridgeshire; Mr. William Welcher, of Thetford, Norfolk; Mr. George Street, of Maulden, Bedfordshire; Mr. J. E. Parsons, of Charwellton, Northamptonshire; Mr. Henry Smith, of Cropwell Butler, Nottinghamshire; Mr. Thomas Statter, of Stand Hall, Manchester; Mr. Thomas Rigby, of Carleton Grange, Blackpool, Lancashire; Mr. Stokes, of Caldecot, Northamptonshire; Mr. C. Beart, of Stow, Norfolk; Mr. E. Lister, of Coleby, Lincolnshire.

Among the principal fairs for Shire-horses are Horncastle, Boston, Northampton, Peterborough, Leicester, Rugby, Aylesbury.

At the Earl of Ellesmere's sale at Worsley, near Manchester, in February 1878, twenty-nine mares and fillies averaged 101*l.* 3*s.* each; sixteen stallions averaged 203*l.* 3*s.* 6*d.* each; and the highest price for a stallion was 388*l.* But 100*l.* to 200*l.* are not uncommon prices for sires or dams.

Suffolks, Clydesdales, and Shire-breds embrace the few distinctive strains of cart-horses in England; but the majority of the farm-horses in the kingdom are crosses or improvements of old local varieties, ranging in character from the heavy horse of the midlands to the active Welsh, and the descendants of the pack-horse of Devonshire and the south-west.

## CHAPTER VII.

CHARACTERISTIC CROPS WHICH PREVAIL IN THE RURAL ECONOMY OF THE COUNTRY.—DIFFERENT COURSES OF CROPPING, AS AFFECTED BY CLIMATE AND LOCALITY.—SUCCESSION OF CROPS.

Agricultural  
itinerary.

THESE three heads of the syllabus, comprehensive as they are, may be conveniently grouped together and treated of side by side in their relation to different districts of the kingdom; and I propose to sketch the principal features of the husbandry, in a brief but discursive agricultural itinerary of some of the counties of England. I commence in the south-east; thence travelling westward, and in succession traversing some of the selected midland and eastern counties, and terminating the survey in the north.

Soils of Kent.

*Kent*.—From the suburbs of the metropolis to the white cliffs which gave Albion her name, stretches Kent, with its central “garden of England;” having three great divisions of soil,—the chalk, with detached portions of London clay, and a narrow belt of the tenacious gault, running through almost the entire length of the county along its northern or Thames boundary; the greensand, or Kentish rag, forming a parallel band also through the whole length of the county; and the Wealden district, comprising the valley of the Weald clay and the iron or Hastings sand: to which are to be added the alluvial plain of Romney Marsh, and the rich marsh lands bordering the Thames, the Medway, the Rother, the Stour, and the Swale rivers. On the heavy lands of the first district the farms range from 100 to 600 acres, with farm-buildings more of the old-fashioned than convenient type. A common rotation of crops is tares, barley or canary-seed, beans, wheat, clover, wheat. The tares are not usually fed off by sheep, but made into hay or cut green for soiling horses or cattle. Canary-seed (grown for feeding cage-birds, large quantities being exported) is drilled in March or April, with 6 gallons of seed per acre. This plant likes a rather tenacious soil, as on rich light land it is liable to become root-fallen. It grows nearly as high as wheat; and coming late to harvest, in September or October, the straw is frequently injured by exposure to rain, and so is used chiefly for litter, though the chaff and husk are good food for horses. The yield may be 3 to 4 qrs. per acre, and the price varies much, from 50s. up to 100s. per quarter. In the Isle of Sheppey, famed for its exquisite mutton, tile-drainage has worked wonders for the clay. The old six-course was summer fallow, with dung, chalk, or lime, followed by

Rotation on  
heavy land in  
the north.

Canary-seed.

Crops in the  
Isle of  
Sheppey.

beans, wheat, beans and clover, wheat, oats. Now, oats have to a large extent given way to modifications in which tares, mangolds, carrots, rape, and potatoes are cultivated; but turnips are not general, as the soil is injured by folding, and many sheep-breeders are still compelled at weaning-time to send their sheep away perhaps 30 or 40 miles to turnip-farms for the autumn and winter. The distinguishing implement in field-culture is the antique Kentish turnwrest plough, worked by 4 and sometimes 5 horses; but the tillage is deep and thorough.

In the Isle of Thanet, and on the chalk soils of East Kent, commonly bare of timber and with scant hedges, exposing the whole county to the fury of winds off the Channel, the four-field course of cropping prevails,—half turnips, half peas; barley; half clover, half beans; wheat; varying the half-tilths in the next course. Small farmers, however, frequently take a more exhausting rotation, as, wheat, barley, clover, wheat, barley, beans; which is sustained only by quickly repeated manuring. Here the modern light iron ploughs have but partially displaced the turnwrest, which, though costly in horse-flesh, cuts the roots of weeds asunder and turns the furrow-slices completely over. The light lands are cleaned after harvest by broad-sharing.

Crops of the  
Isle of Thanet.

The Isle of Thanet grows peas well, and a fine quality of Chevalier malting barley. Barley may average about 5 qrs. per acre; and wheat, of which a favourite variety is Golden Drop, which has a stiff straw and is smoother in the bran than when first introduced, yields about 4 qrs. per acre.

On the deep rich loam, of free texture, often a rich mould  $1\frac{1}{2}$  to 2 feet deep, which is found inland from Deal to Sandwich and around Canterbury to Faversham, large breadths of turnips are folded with sheep; but on considerable tracts the usual rotation is, wheat; barley; clover; wheat; barley or oats; beans: such being the natural fertility of the land, that, with clean culture and good manuring, this course can be sown *ad libitum*.

On the top of the chalk range is a poor stiff soil, in some places literally covered with flints and stones; and this land is difficult and expensive to manage, sometimes requiring six or eight horses to plough it. The common rotation is, turnips; barley; half clover, half peas with rape; half wheat, half oats.

Rotation on  
the chalk.

In the fertile and beautiful Holmesdale Valley, "lying on the sunny side of the chalk hill" (says Mr. George Buckland in his Report on the county in the 'Journal,' vol. vi.), "like a forward border under the lee of a garden wall," lies a tract of dry rich soil, and a belt of gault, most troublesome, from its adhesiveness, to work. Hops are grown partially through the valley.

In the north-western corner of the county the prevailing soil is a strong loam, from 5 inches to 2 feet in thickness, and tem-

Market  
gardens.

pered by repeated dressings of London stable-manure. Contiguous to the Thames lies the market-garden ground, resting on a dry subsoil of gravel, sand, or chalk. It is cultivated partly by the plough, partly by the spade. It is no uncommon thing for the market-gardeners to lay on 100 to 120 tons per acre of the very best London dung, brought in two to three-ton loads at about 10s. or 12s. per load, or 7s. for a cartload. Farmers within ten or fifteen miles of the metropolis sell the larger part of their wheat-straw, and a considerable proportion of hay, purchasing from carmen and cowkeepers stable-manure in return.

Fruit and hops.

It is more on the greensand formation of Mid-Kent, "the garden of England," that hop-grounds extend, and filberts are cultivated, and pear and cherry-orchards abound, and gooseberries, raspberries, and currants are crops; that quickset hedges are trained amid hops and fruit to 12 or 16 feet in height, with a close-cut breadth of 2 or 3 feet, and every available nook not cultivated is thickly-planted woodland, with ash, larch, chestnut, and red willow for hop-poles. In particular is the slope of the rag-stone hills, looking over the Weald, astonishingly productive in hops, fruit, and grain.

The farms range from 20 to 100 acres in extent, and the management of the large holdings, apart from fruit and hop culture, is chiefly on a five or six-course system, with turnips and swedes fed off by Down sheep. Mid-Kent is noted for its deep and cleanly tillage, the ploughing being carried 7 to 9 inches in depth.

On the Weald clay, referred to under another section of this paper, and mostly upon the ironsand portion, hops abound.

Romney Marsh.

East of the Weald, and bounded by the English Channel, from which it is defended in some places by shingle beach and sand, and in others by costly embankments or sea-walls, lies Romney Marsh, with its neighbouring flats of Walland and Denge Marshes. On the strong land, of which a minor proportion is in arable, drainage has worked great improvement; wheat and peas or beans are alternated year after year, with occasionally oats and turnips; large breadths of turnip-seed are grown, yielding from 2 to 6 qrs. per acre; and mangold and radish-seed also raised by contract for the wholesale seedsmen. But Romney Marsh is celebrated for its flocks of sheep, which are bred and fattened on its spacious plain.

Sheep management.

It boasts of breeding and fattening pastures; the former able to keep two to three ewes per acre during the winter, and about double that number in summer; while the feeding lands of average quality carry and fatten four or five sheep per acre, and on some exceptional pieces much higher numbers are grazed. The great disadvantage from which the flockmasters of Romney

Marsh suffer is the necessity for sending away their lambs long distances up the country in winter, the period extending to thirty weeks, from September to the beginning of April; the price paid being commonly 5*l.* or 6*l.* per score. As the young animals are then under other care than that of the owner, great numbers of t<sup>e</sup>gs return to the Marsh in spring in a very low condition, and therefore not well fitted for the rich grass.

When the turniped lambs return into the Marsh, they are put on the poorest land or on such fields as the grazier thinks wants improvement by hard stocking. Here they remain until August, distributed, or rather concentrated, at the rate of from five to twelve sheep per acre, according to the powers of the different fields. The wether-t<sup>e</sup>gs are removed in the autumn to the fattening, and the ewe-t<sup>e</sup>gs to the breeding-grounds, among the two and three-year-old ewes. The wethers remain until July or August following, when, as they become fat, they are drawn out and sold to the butchers at the Marsh markets, or are sent to Smithfield. The old ewes, called "barrens," are put to fattening as soon as their milk is dried after their third lambing, on some of the best land, where they run from three to five per acre for the winter. In favourable seasons these are sometimes made fat and sold in the spring soon enough for the same field to take in a lot of wethers and fatten them by the autumn; but this can only be done by light stocking. In very growing summers, it is sometimes necessary to put young beasts on the grass to prevent its "running away" from the sheep.

*Middlesex*, with about two-thirds of its area in meadow, mainly in the north, on the London clay, and its arable and market-garden lands chiefly on loam or brick-earth, is to a large extent a county of meadow-farming,—not only farms, but parks and meadows supplying the London market with hay. The productive powers of the soil are maintained with applications of dung from the London stables and dairies. The live stock are limited to horses, and to a few cattle and sheep grazing the second or after-crop. A usual rotation is wheat (generally Chiddam white, varied with Golden Drop red, and other sorts); on one-third of the arable, one-third under barley and oats, and one-third in beans and peas, clover and roots; while on the inferior and gravelly soils, a fallow crop is followed by one or two corn-crops. A portion of the straw is sold to jobbers with a return of manure. Within a few miles of the London suburbs not only the hay but a considerable proportion of the straw is sent to market, the teams bringing back two loads of dung for one of produce taken in. Wheat, from the value of its straw, is grown as often as may be in proportion to other white corn-

Soils of  
Middlesex.

Rotation of  
crops.

Sale of hay,  
straw, and  
green forage.



crops. Tares, rye, winter barley, and clover are sold green to those who fetch them and return manure in their place. Potatoes, mangolds, and white turnips form the chief root-crops, and are drawn from the farm by purchasers in London and its suburbs, supplying food for man and beast; this being the governing feature in the management of a suburban farm. Live stock are necessarily few, and on some farms are entirely limited to dairy cows and the horses necessary for working the land.

Market  
gardens.

Market-gardening and fruit-growing are being established upon the high-rented land of this county. Frequently the landlord plants apple, pear, cherry, and other fruit-trees at wide intervals, and then lets the ground. The tenant deep-ploughs, with a heavy dressing of manure, and plants potatoes, cabbages, or other coarse vegetables. French beans or peas, with Brussels sprouts in the intervals, winter or spring onions, lettuces, wall-flowers for decoration, and all sorts of garden produce fit for the London market, are gradually introduced, and the farm becomes a market garden.

Soils and crops  
of Surrey.

Surrey is not remarkable as an agricultural county. Market-gardening prevails to a considerable extent in the environs of the metropolis, tracts of hay meadow and pasture land occupy the alluvial flats bordering the Thames and other rivers, and the soils are exceedingly various,—from the thin flinty soils of the chalk downs which divide the county east and west, to the mixed soils of the Lower Greensand, the ragstone and clay of the Weald towards the southern boundary of the county, and the heavy lands of the London clay and the loams and poor heaths of the Bagshot sands on the north. On the easily cultivated lands of the latter extensive formation, the four-course system of cropping prevails on the lighter soils; while on sand loams of better quality, rye, vetches, trifolium, or stubble turnips are grown upon broken-up wheat stubbles, and peas and beans replace clover in the rotation. On strong loams barley is sown after stubble turnips; or frequently the wheat stubble is ploughed immediately after harvest for a crop of tares, followed by rape, and both consumed in the autumn and winter before late-sowing another crop of wheat. On warm lands *Trifolium incarnatum* is invariably sown upon wheat stubble, prepared as a seed-bed either by ploughing and rolling or by the cultivator. Carrots, peas, and vegetables are grown to a considerable extent for the London market. Devon and Welsh cattle, Berkshire pigs, and Hampshire Down or Somerset and Dorset horned sheep are the most prevalent breeds of live stock. The cattle are mostly bought in for grazing or winter feeding in commonly inadequate farm-buildings, while a prominent feature in the sheep management is the raising of fat lambs.



Upon the heavy lands of the London clay, fallow for wheat is the foundation of the course of cropping; bare fallow having been to some extent amended by growing tares to be cut for horses and cattle, though but a small proportion of the fallow is occupied by swedes or mangolds. On the more friable soils, sand-loams and gravels, a five-course rotation, namely, turnips, barley, clover or seeds, wheat and then barley, is general; chalk is applied to the fallows or the turnip-fields up to 10 tons or more per acre, and large quantities of artificial manures are applied for green and root crops.

The Chalk and Greensand district, including a large extent of unbroken Down, with lofty ridges covered by fine sheep-pasturage, is distinguished for its Southdown sheep-farming, its extensive growth of sainfoin—partly for grazing, partly for hay for the London market,—and for the hop-grounds of Farnham. The wheat grown, notably the white Chiddam and Talavera varieties, are celebrated for their high quality. Lime is a manure of extensive application on farms lying within convenient distance of the chalk; and there is a general use of super-phosphate, nitrate of soda, nitro-phosphate, and other manufactured manures.

On the Weald, with its farms of small or very moderate size and its small inclosures (the land being sacrificed to oak-timber), the old course of bare fallow, wheat, seeds, oats, has been improved by the effect of drainage and the consequent extension of the growth not only of tares, but of mangolds, cabbages, turnips and swedes; the green and root-crops being very commonly carried to sheep in yards.

*Sussex* is distinguished mainly for the Weald clays and sands, with an extensive area of hop-grounds in the north and east of the county, and for the Chalk Downs in the south and west, with belts of the good Greensand soils and the loams and heavy lands of the London and plastic clays. On the small or medium-sized occupations of the Weald, with their small inclosures and overrunning hedgerows and timber, the stiff wet clays, only partially under-drained, are cultivated on a system of summer-fallowing, with dunging and sometimes liming, for wheat, followed by three or four corn crops, with intervening seeds or tares, and a small proportion of mangolds, turnips, or cabbage. Ox-teams are still used in the county, though to a less extent than formerly. On the Downs, the rotations vary according to soil, from the four-course to a five-course or a six-course, with two years' seeds; and oats are grown much more extensively than barley. Sheep are the principal stock of the Down farms, being used to range the open sheep-walks by day, and to be folded on the arable fields at night. And great numbers of

Soils and crops  
of Sussex.

lambs bred on the Downs are sold in autumn to be grazed on richer soils, especially in West Sussex. The characteristic breeds of live stock are Southdown sheep and the native Sussex cattle and Sussex pigs.

Soils of  
Hampshire.

*Hampshire*, geologically consisting of the Cretaceous, Tertiary, and Post-tertiary formations—including, indeed, beds of every description of rock, from the Wealden upwards,—presents three great natural divisions, namely, the middle chalk plateau, with its lofty ridges and beacons and watered valleys; the district of lower and middle Eocene, north and east of the North Downs, and another tract of the same formations stretching from the chalk hills to the sea; while extensive deposits of flint-gravel and sand overspread portions of all the geological formations, and alluvial soils border the streams, as on the banks of the Stour and the Avon, the Test, the Anton, and the Itchen.

Course of  
cropping in the  
Woodlands  
district.

The northern Eocene district, with its prevalent retentive clays and clay-loams, interspersed with sands and gravels, on a base of plastic clay like birdlime, is a land of small or moderate-sized farms, heavily timbered, often with double rows of timber trees with brushwood between, growing in enormous hedgerows round the small fields, which are chiefly arable. It is called “the woodlands.” Here the time-honoured husbandry of the clays has been to bare-fallow once in seven years, and then take alternate crops of wheat and beans. The introduction of drainage enabled vetches to be grown on a considerable breadth of the fallow, with swedes and mangolds on the lighter spots, while clover is sometimes sown at intervals of eight years, the lea, if clean, being ploughed up for wheat, but more commonly fallowed, or a crop of oats or beans is taken before the fallow. On the more easily worked soils other courses are adopted, though without any uniform or general system; such as fallow, wheat, beans, wheat, oats or barley, and clover; or on more sandy or gravelly land, roots, barley or oats, clover or peas, wheat, rye, oats, or barley. Live-stock play a subordinate part in the woodland farmer’s business, excepting that he makes a trade of breeding and selling farm-horses. Indeed, the prevailing farm-buildings, with the open yard in which cattle tread straw into manure, with the boarded and thatched barn, rough boarded sheds, with somewhat stronger and sounder stables, are not promising for profitable meat-manufacture with costly purchased foods. The greatest improvements have been made by draining, and the application of chalk; and larger occupations, more spacious inclosures, with less encumbering timber, and better farmsteads, with improved management, distinguish the parts of this district flanking the chalk hills. On the drained, subsoiled, and chalked clay lands, one of the best rotations of cropping adopted

is as follows:—(1) roots, including mangolds, a smaller portion of swedes, white-fleshed turnips, and a few white carrots and cabbages; (2) oats or barley; (3) clover; (4) wheat; (5) green crops, part tares, part trefoil and white clover, with a portion of turnips or rape fed-off by sheep, after the winter tares, or after the trefoil; (6) wheat; (7) beans; (8) wheat; with a few acres of Italian ryegrass (sown at the last hoeing of the wheat), and a few acres of trifolium (sown immediately after harvest), and both consumed in time for the turnips, which begin the series over again.

In the southern Eocene district, skirting the chalk, is a belt of country, described (in the full and admirable Report of the Rev. John Wilkinson, in the Royal Agricultural Society's 'Journal,' vol. xxii), as "a land of coppice, of game, of small farms, of high enclosures, and of the London clay." No settled rotation of crops is followed, the cultivators doing the best they can according to season; but fewer beans and more turnips and barley are grown than in the woodlands of the north; particularly where the ground has received that improvement which lasts for a generation, a dressing of 25 to 30 tons per acre of chalk. In a broad bend stretching from Portsmouth to Romsey, is a better class of loamy soils, with larger holdings, about one-fourth in pasture. Here a four-course system prevails, with a six-course on some of the best-managed farms,—as mangolds, swedes, or common turnips; barley or oats; seeds; wheat; beans and peas; wheat. The agriculture is of a high character, greatly advanced of late years in liberal manuring, cleanly management and feeding of live-stock; and much hay and straw are allowed to be marketed at the seaports, on condition that artificial manure of equal value is brought back, or three tons of stable dung in return for one of straw. In the valley of the Avon and the Stour, there is a mixture of vale and down farming, including four-course farming, on some of the finest turnip and barley soils of Hampshire; there are also water-meadows and flood-meadows, which are a feature in the husbandry of the county, the most famous being those on the river Avon, which from the depth of the alluvial soil, and their gravelly subsoil, surpass the meadows on the Test, the Anton and the Itchen, which rest on clay or peat. Here dairying is much practised for both butter and cheese.

In the middle or Cretaceous district, where the farms are larger, the buildings more adequate, the residences superior, the tenures fixed, and everything on a more liberal scale than prevails elsewhere in the county, there is little uninclosed Down land left—the chalk hills having been, for the most part, converted into arable by the usual practice of paring and burn-

Crops in the southern district.

Rotations on the chalk.

ing, for roots, followed by wheat, barley, or oats, and then seeds. With the exception of a small proportion of permanent grass around the homestead, and the water-meadow which may be attached, the chalk farms are all arable.

The old rotation on the poorer soils was summer fallow or turnips; wheat; barley or oats; grass; clover-lea. On the better soils it was wheat; barley or oats; grass, remaining a second year as "old field," or bare fallowed, or fallowed for turnips. The change to the new four-field course, swedes; barley or oats; grass; wheat; was a great improvement, but was not found sufficient and satisfactory everywhere. Mr. Wilkinson says, "Without water-meadows there was not enough sheep-food, and the swedes could not be fed off in time for the succeeding barley; much farmyard dung, too, was required for the wheat. To meet the first objection, a catch-crop of rye, vetches, or winter oats, was inserted between the wheat and the swedes. But the second and chief objection brought about a new course, introduced from the Wiltshire Downs, and now extensively prevalent among the best farmers in Hants for a portion, say one-third of their arable—namely (1) swedes, (2) turnips, (3) wheat, (4) barley. When, however, there are no water-meadows to provide hay, this system is not applicable, and a combination of three four-courses (namely, the old better-soil course, the new, and the Wiltshire) is found very advantageous; or the Wiltshire is made a five-course by the addition of grass. On the poorer soils another five-course is followed by liberal farmers—(1) turnips, (2) wheat, (3) swedes, (4) barley, (5) grass. Where there is good strong land, and no restriction by landlords, there is a three-years course—(1) wheat, (2) swedes, (3) turnips, or turnips and rape. This liberal system, which, of course, is available for only a portion of the farm, gives much wheat without the dung-cart, and also provides food for many sheep. But the changes which have been rung on rotations in the chalk district of Hampshire are infinite. All, however, have in view the same result—many sheep and much corn,—and proceed on the same general principle of not having more than half the arable in corn at any one time. The succession of barley after wheat, with many, would be a fatal objection to the Wiltshire system. The answer given by the most successful farmers in Hampshire attributes many advantages to this rotation; no other, they say, provides better-distributed sheep-food, kinder barley, stronger wheat, more economical manuring, and more convenient cultivation. If barley follows swedes, the latter are in the way of the former; the consumption of roots must be quickened, or the barley-sowing season will be past. But time waits for no man: so the fold is hurried,

Mr. Wilkinson  
on advantages  
of barley after  
wheat.



and the more haste the less speed. The farmer may be too late after all his exertions. Besides, if the roots be gone early, and the spring be a little backward, what is to carry the flock on? On the other hand, if a green crop follow the swedes, these may be fed off at leisure up to the middle of May, when, indeed, it is too late for barley, but in good time for turnips, and when, also, the grass will be surely ready for the sheep. Then there will be an abundance of green food, a regular succession of it, and facility for its leisurely consumption. I have heard the opinion too often expressed to doubt its accuracy, that barley taken after wheat is a more even crop, and of a kinder quality for malting, than after turnips, the folding on which makes the ground too rank for barley; but what is the barley's bane is the wheat's blessing. This wants manure, and that of the fold is the most economical. The treading of the sheep, too, on the soft turnip-ground (if it rain, so much the better) is highly beneficial, and consolidates the land more than folding on clover-lea would. There is no pressure like their thin, sharp, cloven feet. Wheat thrives in Hampshire as well on turnip-break as on clover-lea or better (though this is not the case elsewhere on chalk soils); and, besides, there is no danger of wire-worm. The labour also is better distributed for men and horses, who, as well as the shepherd, are hurried at a busy time to get in barley after swedes. There is still an opportunity for slipping in a crop of stubble-turnips, of rye, or of vetches, between the wheat and the barley, if wanted, and circumstances are favourable. When two turnip crops are taken in succession, as in the Wiltshire and three-course systems, a large supply of sheep-food is provided, and consequently a larger stock of sheep kept—the great *desideratum*. The second crop of turnips, after folding on the swedes, is more certain, and increased depth of soil can be gained. Deep-ploughing is the universal remedy for a thin staple; subsoil must be turned up from time to time, exposed to the air, and added to the surface soil. But for wheat, deep-ploughing will not do; the ground is not sufficiently consolidated, and the plant will heave in the winter frosts: moreover, there will be brought up charlock and the red poppy, which cannot be kept down by any amount of hoeing which wheat can receive, and which will occasionally grow up with and stifle the good seed. Now, for both of the turnip crops, you can plough as often and as deeply, and hoe as much as you like; while in the second turnip crop there is a certainty of effectually subduing the weeds which escaped in the first year, and of leaving the land perfectly clean for wheat.”

Arguments for  
two turnip  
crops in  
succession.

As in some other counties, sainfoin is a necessity for the Sainfoin.  
chalk farmer who has no water-meadow; and a seventh or

eighth part of the arable is under this crop, sown with the barley crop like clover, and left standing for two, three, or more years, adapting the period to the rotation of crops followed.

Wiltshire.

*Wiltshire.*—This county is in two great agricultural divisions: the north-western or oolite district, and the south-eastern or chalk district.

Chalk district.

The latter is distinguished for its large farms; for its spacious inclosures of arable and its uninclosed chalk downs; for its flocks of West County Down and Southdown sheep, extensively used for maintaining the fertility of the thin soils by folding; for its courses of cropping which raise abundance of sheep-feed, with artificial manures; for its universal growth of sainfoin, and for its water-meadows, luxuriant beside every brook and rivulet. On the flinty and chalky loams the old rotation of vetches and turnips, barley, clover, wheat, has been largely replaced by—1st, wheat; 2nd, barley, half sown with clover; 3rd, half clover mown for hay, half vetches and swedes, with winter turnips and rye sown after the vetches are fed; 4th, half clover, fed-off, or sometimes broken up and sown with green food such as summer vetches; half rye, early turnips, rape, &c.; and after the rye the land is sown with turnips. On the light flinty soils, the down or “beak” land, the course is generally wheat, swedes or turnips, oats or barley, and the grass seeds for two years, sometimes broken up after one year for rape and vetches. Sainfoin is on almost every farm, varying in extent according to the extent of Down allotted to the holding, and also according to the presence or absence of a water-meadow. It is usual to sow a piece each year and let it stand five or six years; about a tenth or rather more of the arable being under this crop.

Rotations.

On the chalk marl, a heavy white land, three-field courses, with subdivisions of each, universally prevail. A general rotation is—1st, wheat; 2nd, half oats, sown with clover, half swedes, vetches, or beans, &c.; 3rd, half clover, mown for hay, half turnips, rape, &c. Another is—1st, wheat, half sown with clover; 2nd, half clover, mown for hay, half swedes, vetches, oats, &c.; 3rd, half clover, fed or summer tilled, half rape, turnips, summer vetches, &c. The best farmers adopt—1st, wheat, one-third sown with clover; 2nd, one third clover mown for hay, and one-third beans, oats, peas, and vetches, one-third swedes, with rye or winter barley or vetches, usually sown on a portion of the swede-field; 3rd, one-third clover, fed, summer tilled, or sown with a green-crop, one-third early turnips or rape, one-third rape or summer vetches; some preferring a clean fallow after the swedes.

On the Greensand soils, varying from poor gravelly land to



rich sand loams, with veins of the gault clay in places, very excessive systems of cropping are pursued; as Mr. Edward Little observed in his Report on the county thirty years ago, the object of those who occupy sand land is to keep it manured as highly as possible and shaded with a crop of either corn or green food. Barley is grown to some extent; on the deep soils wheat is taken every alternate year, and mangold has taken the place of a portion of the turnip break.

Sheep are folded all the year round, alike on the downs, the green crops, the artificial grasses, the roots, and the irrigation-meadows. When grazed upon the open sheep-walk or scantily-pastured downs, the ewes are driven to the folds on the arable fields at night, where they are crowded, often two thousand sheep upon an acre, in daily shifted folds, in winter and spring enriching the ground for barley and turnips, and in summer and autumn manuring it in this way for wheat. Sometimes it is a portion of the ploughed wheat-stubble which is under this treatment; sometimes the folding is upon straw carted to spread upon the land early in winter, and then ploughed in to lie till spring as a preparation for the turnip crop. The same process is also adopted by some farmers for wheat. The sheep are not only employed as manure carriers and dressers of the land, but are also worked for the purpose of firming the seed-bed directly after the wheat is put in, either drilled or hand-sown upon the seam-pressed furrows. A flock of several hundreds are driven in close order to and fro over the ground, solidifying it by their treading; this being done in early morning for about three hours each day, and plots of eight or ten acres daily treated in turn, until the whole has been gone over.

The north-west or oolite district is distinguished by smaller farms, lesser inclosures often over-stocked with hedge-row timber; and noted for its grazing and dairying, as well as for its stone-brash turnips and sheep-farming and its clay-land corn farming. On the oolite or stone-brash lands the four-course rotation is generally followed upon the thin, and a five-field course by holding on the clover for a second year on the deeper soils; but many farmers take two green crops in succession, and some two corn crops together.

On the dairy farms potatoes are much grown; and a belt of sand-loam near Calne supplies carrots, turnips, green-peas, and other vegetables for town consumption. It is on the adhesive calcareous clays and on the strong loams, growing vetches, rye, and other sheep-keep, followed by wheat, the clover or seeds broken up for beans, and wheat again, that steam cultivation has achieved some of its most remarkable transformations both of the soil and management.

Dorsetshire.

*Dorsetshire* has been divided by an old author into *Felix*, *Petræa*, and *Deserta*; representing its strong fertile soils in the vales, its chalk and oolite hill-ranges, and its barren heaths.

Rotations.

On the many-soiled but generally thin-stapled chalk-district, the most extensive in the county, excellent farm-management prevails; and great breadths of the bleak Downs have been converted into arable. The four-course rotation—(1) turnips, swedes, and mangolds; (2) barley or oats, sown with seeds; (3) seeds; (4) wheat; is usual on the better lands, while on the thinner and poorer soils the grass is left for two years. Sheep-breeding and sheep-folding are universal; and for providing plentiful supplies of food in succession for the flock has led to the adoption of the same systems of multiple green and root-cropping which have been stated with respect to Hampshire and Wiltshire. Sainfoin, however, is less extensively cultivated than in those counties.

On the clays, including the rich grazing county of the Vale of Blackmore and the genial soils on the marlstones, no uniform or general rotations of crops are found. Wheat is frequently grown in alternate years, the intermediate crops being roots for stall-fed beasts. Another rotation is roots, wheat, barley, clover. Another: wheat, beans, half clover, half vetches, followed by swedes drawn off. Another is wheat, barley, grass, wheat, vetches, or stubble-turnips. Another is wheat, rape, wheat, clover; and another is mangolds, or turnips and swedes, oats or barley, wheat, oats, stubble-turnips or vetches.

Devonshire.

*Devonshire*.—Famed for its cattle, its cream, its cider, and its climate, Devonshire is pre-eminently a grass-land and green-crop county, though, from the great extent of its boundaries, the acreage of corn grown is also large. Lofty and barren wastes, like the ranges of Dartmoor, locally modify the otherwise mild as well as moist climate. There are tracts of poor sands and gravels, like the wastes of Haldon and Woodbury Common, and the soils on Black Down hills; and the Carboniferous formations occupying a great portion of the county are for the most part covered by a poor clay. But rich sandy loams, and loams on a clayey subsoil, prevail in the fertile vale of Exeter and Honiton, in the valley of the Exe; the calcareous clays and light loams of the South Hams district on the south coast surpass all the county in fertility; and in North Devon are the luxuriant pastures on the hills, which are the home of the native red cattle.

Orchards are in profusion, and woods abound in many localities; but a feature which enriches almost every landscape in an artistic point of view is the enormous number of hedgerows thickly stocked with timber, cutting up the land into diminutive

inclosures, making tillage operations costly, robbing the crops of nutriment by their roots, by their shade hindering the drying of corn at harvest time, and damaging all husbandry by their harbouring of weeds and game and vermin. Improvements have been made by some enlightened proprietors of late years, notably by Sir Thomas Dyke Acland; yet, with the exception of particular districts which are bleak and exposed, the inclosed farms are too generally in fields of a few acres each, with fences occupying, and rendering unproductive perhaps, a tenth part of the arable land.

The old Devon rotation of cropping is (1) turnips; (2) wheat; (3) barley; (4) oats; (5) seeds; remaining for two to six or more years. But in the red sandstone district, and everywhere where improved agriculture has been most extended of late years, this, old course has been replaced by the four- or five-course of turnips barley or oats, clover or grass seeds for one or two years, wheat. Interpolated crops of rye, winter vetches, stubble-turnips and rape are not so much taken as they probably would be if water-meadows were not so prevalent—where warm valleys and the abundant hill-side springs are so favourable to irrigation. On the clay-lands bare fallowing is still very extensively practised.

*Cornwall*, with its growan or gravel soils lying upon the granite, its fertile lands upon the schist or clay-slate, its comparatively unfruitful surface on the serpentine and other igneous rocks, and its varied soils ranging from sands to yellow clays upon trap, Carboniferous and other deposits, and washed on both sides of its narrow area by the Atlantic, bringing moisture and mildness to the atmosphere, is distinguished, apart from its mining industry and its fisheries, for its small farms, its dairying, pork-feeding, culture of potatoes, reclamation of waste land, and a style of agriculture now at a stage of general advancement.

In *Cornwall*, the prevailing courses of cropping include laying down grass-seeds for three years. The old management was (and to a considerable extent still is) to mow the grass once for hay, to break it up by burning the surface, take on most parts of it two white-corn crops in succession; and then lay down again, and on a portion of the broken-up lea sow turnips and potatoes, to be followed by barley or oats. More general now is the practice of skim-ploughing the sward in summer, giving it a late summer fallow, heavily manuring with lime or with dung, ashes, and the sea-sand, which on parts of the Cornish coast is richly calcareous, and ploughing again and sowing wheat in October; turnips or other green-crops follow the wheat, and are succeeded by barley or oats, sown down with seeds for the next two or three years of pasture.

Potato culture forms a very considerable part of the business

of farmers in some districts, particularly near Penzance, the Lizard, and on the banks of the Rivers Looe and Tamar. Great quantities of early potatoes grown upon the dry friable soils in the sheltered Penzance district, with its mild moist climate, are forwarded to the London and other markets in the spring. The early kidneys are full grown by the middle of May, while tubers are extracted by hand from the growing crops as early as the second week in April in some seasons.

Reclamation of the wastes, strewed over with granite blocks, some of immense size, with heath and furze shooting up in the interstices, and sometimes at an elevation of many hundreds of feet above the sea-level, is a costly and difficult enterprise, often involving an outlay of 10*l.* or 12*l.* per acre for inclosing, breaking-up, and procuring the first crop. Manuring with bones or guano for turnips, followed by oats and then grass-seeds for pasture, is the general practice in making such improvements. Considerable breadths of rocky wastes have been reclaimed by miners and other cottagers allowed to hold plots of a few acres on leases of three lives.

Soils of  
Somersetshire.

*Somersetshire* physically consists of a central basin between two hilly districts, one on the west, the other on the north-east. The former hill district, lying west of the Quantock and Brendon Hills, comprises stony soils on the grauwacke and mica-schist formations, with deposits of peat. It is well watered by hill streams in that moist climate, and breeding and rearing of stock characterise the husbandry. An old-fashioned and not altogether abandoned course of cropping is to break up lea which has been grass for several years, taking (1) a crop of oats "to clean the land;" (2) oats or wheat (limed); (3) turnips; (4) oats or wheat; and then laying down again to (5) grass. An improved rotation, described by Sir Thomas Dyke Acland, Bart., M.P., in his full and admirable "Report on the Farming of the County of Somerset," in the 'Royal Agricultural Society's Journal' for 1850, is (1) turnips or rape; (2) oats or wheat; (3) swedes; (4) grass, for two or three years. On the clay-slate soil, retentive of moisture, and on a hill-side not too exposed, the lea lasts three years; but under other conditions, not more than two years. This system of laying down grass after roots has greatly extended during the last twenty years, and is held to be a mainstay of that part of Somersetshire which is devoted to the breeding and rearing of stock.

The north-eastern hill district presents a remarkable variety of geological formations; and is largely under permanent pasture, with dairy farming.

In the central basin of the county, on the New Red sandstone and red marls of the Vale of the Tone, embracing many qualities

Rotations on  
New Red  
sandstone.

of soil, from rich red loams to heavy soil, and again to stony and sandy lands, the old system of (1) wheat; (2) barley; (3) grass for several years, with only small breadths of turnips on the drier soils, has been replaced by the four-course. On the heavy lands a good rotation is (1) swedes, turnips, mangolds, with a small breadth of potatoes; (2) barley; (3) clover and seeds, mown once, and then fed with sheep for two years; (4) beans; (5) white tares, fed with sheep, followed by rape, also fed with sheep; (6) wheat. One course on strong red land is (1) beans; (2) wheat; (3) vetches; (4) barley; (5) clover or seeds—the farmyard-manure being applied on the clover before beans.

On the high lias formation south-east of the Bridgwater Level stone-brash and clay prevail. A common rotation on the stone-brash is, (1) vetches; (2) wheat; (3) barley or oats; (4) clover; (5) wheat; (6) winter beans. But of late years, turnips and other roots have been more extensively cultivated. One rotation is (1) roots; (2) barley; (3) clover; (4) winter beans; (5) wheat, the winter beans being interpolated between the clover and the wheat, in order to destroy the slugs and give the clover roots time to rot. Another is, (1) turnips; (2) spring wheat; (3) sainfoin for four years; (4) wheat; (5) winter beans. Another is, (1) turnips; (2) oats; (3) clover or vetches; (4) wheat; (5) winter beans. And another, (1) mangolds; (2) wheat; (3) clover, fed-off; (4) wheat; (5) vetches, fed-off, followed by mustard, partly fed and partly ploughed in as green manure; (6) wheat. On the heaviest lias clays, the old course of (1) bare fallow; (2) wheat; (3) beans, is still in favour; though since Sir Thomas Acland wrote his Report there has been a very extensive introduction of vetches and clover between wheat and barley crops; and small breadths of mangolds also are grown upon these clays.

*Gloucestershire* is distinguished in physical conformation by the Cotswold Hills, which traverse the whole county from south-west to north-east, and by its vales, including the Vale of Evesham, the Vale of Gloucester, and the Vale of Berkeley; subsidiary districts being a small portion of the valley of the Thames, the Bristol district with its coal-fields, and the Forest of Dean, while extensive alluvial flats border the Severn, the Wye, the Avon, the Isis, the Churn, and smaller streams. The Great Oolite, Fullers' Earth, and Inferior Oolite rocks rise into the Cotswold Hills; Lias clay and limestone, and New Red sandstone, are the foundations of the vales; Lias, Old Red sandstone, New Red marl, Mountain Limestone, and Pennant sandstone, underlie the coal districts; and Old and New Red sandstone and Magnesian Limestone formations appear in the Forest.

Heavy-land  
rotations.

Gloucester-  
shire.



The Cotswold  
Hills.

The Cotswold district of elevated plains with intersecting valleys, the summits rising to an altitude of 600 or 700 feet above the sea-level, has, for the most part, a soil overlying Great Oolite or Bath freestone rock, and known as "stone-brash." It is of a ruddy brown colour, and varies from deep loam to light thin, weak land. The soil on the inferior oolite is very similar, but possesses a greater proportion of sand and Lias clay. These calcareous soils are of a hollow, porous character, requiring consolidation in tillage management; and a peculiarity is that, deep ploughing, so beneficial in many descriptions of soil, is here injurious, by enabling the rains to wash and waste the manure out of the thin stratum of light soil into the porous rubble which lies beneath. Another kind of land, of a lighter colour and containing but few stones, and sometimes of considerable depth, is not so fertile in quality as its appearance indicates.

Rotations.

In this district of large farms, varying from 200 to 1000 acres and upwards, the six-course rotation of crops, formerly the most prevalent, has given way to a more general adoption of a four-field or five-field course, with sainfoin layer on the lightest parts of the farm for four or more years. Wheat stubbles and old sainfoin lea are scarified immediately after harvest, worked, and the rubbish burned; farmyard-manure is carted into heaps, to be in readiness for application in the spring, though on the stronger lands it is put on in the autumn; the land is ploughed 4 to 6 or 7 inches in depth, according to the staple of the soil, and so remains until the spring. In March or April the cultivator, drag, and harrow work out what remains of root-weeds, which are burned; and mangolds and swedes are planted, sometimes on the ridge, sometimes on the flat, with farmyard-dung and artificial manures. Part of the stubble land is frequently left unploughed till the spring; being then "raftered," "rist-baulk" ploughed, or half-ploughed (each thin furrow-slice being turned upon an unmoved strip), cultivated across, and the rubbish burned and the ashes ploughed in. It is common to rafter or half-plough sainfoin layers in January and February, following in about a month either with the breast-plough, worked by hand, which reverses what was done before, or by a scarifier drawn across the baulks, to cut the slices into sods for burning; then a light ploughing turns in the ashes, and a second light ploughing is sometimes given as a preparation for turnip-sowing.

Raftering.

Paring and  
burning.

This Cotswold practice of paring and burning old sainfoin and other leas for turnips is not superseded by the use of artificial manures, though pursued to a less extent than it was twenty years ago. Burning dissipates a quantity of vegetable



matter which might enrich the soil ; but the advantage more than counterbalances this loss, and the following arguments of Mr. Bravender in his "Report on the Farming of Gloucester" (in the Royal Agricultural Society's 'Journal,' vol. xi.) still hold good :—"Very little of the soil is burnt ; but the roots of sainfoin, grass and weeds are converted into ashes ; and the surface couch-grass, which so much infests the district, is got rid of and not buried by the plough to spread and flourish all summer among a scanty crop of oats. That which is driven off is principally carbonic acid. But, admitting that we suffer some loss, how much do we gain by raising an excellent crop of turnips or swedes by the ashes and an admixture of artificial manure, without trespassing on the fold-yard ! And how much do we gain by having acres of broad leaves stretched out, absorbing the carbonic acid from the atmosphere, which is appropriated by the bulb, and which, after passing through the stomachs of the sheep, becomes deposited on the land ! After burning, we consume a crop of turnips on the land ; and white-straw crops should never immediately follow breast-ploughing and burning. I know hundreds of farmers who practise paring and burning, but not one who discontinued it unless compelled. I know some landowners have objected to it as injurious, but not of a single positive injury sustained or loss in letting a farm on which burning has been practised." It must be remembered that the system is not recommended, excepting for the peculiar description of thin soil upon calcareous rubble and rock on which it is found to answer.

The second crop in the rotation is generally barley, sometimes oats, and occasionally spring wheat. Seeds, consisting of ryegrass and red and white clover or trefoil, are sown on the growing crop ; the seeds are mown for hay, the aftermath is grazed, and the layer is ploughed up for the fourth crop in the course, wheat ; the ploughing and sowing being early, namely in August and beginning of September on the lighter lands. Heavy rolling follows the plough, and cultivating and harrowing clean the seed-bed. On the lightest soils it is general to keep the seeds down for two years, thus making a five-field course,—the treading of the sheep giving the requisite solidity to the land, while their droppings enrich it for the wheat. The six-course rotation is still practised to some extent ; oats being taken after the wheat.

On the strong lands in the Vales, where dairy-farming is the distinguishing husbandry, bare fallow is not so common as it was a few years since ; vetches or trefoil being grown, fed off by sheep, and the land then bastard-fallowed ; and on the strong loams mangolds, swedes, and carrots have been largely in- Crops in the Vales.

roduced. Thus, the rotations are, (1) summer fallow, (2) barley, (3) clover, (4) wheat; or (1) fallow with vetches or roots, (2) barley, (3) beans, (4) wheat.

In the Bristol district the rotations most common are, on clay land, (1) vetches, (2) wheat, (3) beans; or (1) turnips and potatoes, (2) wheat, (3) beans, (4) wheat, (5) clover, (6) wheat. On loams, (1) green crops or peas, (2) barley, (3) clover, (4) wheat; and on the light sandy lands, the ordinary four-course rotation.

In the vale of the Thames with its varied soils, one rotation on the clay is, (1) bare fallows, (2) vetches, (3) oats, (4) clover, (5) wheat, (6) vetches, (7) wheat; and the gravelly soils produce roots, vetches, clover, barley, and wheat,—a good course being (1) swedes, (2) barley, (3) clover, (4) wheat, (5) rye and vetches, followed by swedes and turnips, (6) barley, (7) ryegrass, hop-clover, or rape, (8) wheat.

Irrigated meadows are a valuable feature in the vales, the waters issuing from the calcareous rocks of the Cotswolds being especially excellent for the purpose. Indeed, the water-meadows at South Cerney are said to be the earliest found in England.

Herefordshire.

*Herefordshire*, geologically on the old red sandstone, with portions of the Silurian and Mountain Limestone formations, embraces three principal divisions of soil; the light marly loam of the Rylands district, gravelly loam in the neighbourhood of Hereford and in the valley of the Wye, and a more or less tenacious marly clay, which occupies a major part of the county—the whole being intersected by rich grass lands on alluvium fringing the rivers. The holdings are for the most part of medium size, 100 to 300-acre farms being most common.

The five-course husbandry.

Upon the light Ryland soil, and also upon the driest of the gravelly loams, the four-course system prevails; but some managers have introduced the five-course with advantage. The reasons for the change and the method of culture are thus described by Mr. Thomas Duckham:—"I was induced to discontinue the four-course rotation, partly owing to failures with the clover plant and an increasing tendency to disease in the turnip and swede crops, and partly because of the inferior quality of barley which followed the use of cake and corn with the sheep when folded to eat off the turnips; the land having been thereby rendered too high in condition for that crop, produced a large bulk of straw which was early laid, and thus the yield of corn was small and of secondary quality. Under these circumstances, I resolved to try the following five-course rotation, namely, roots, wheat or other corn, barley, clover, wheat. And although I was told at the commencement by some experienced friends, whose judgment I think highly of,

that I 'should not be enabled to keep the land clean,' my experience is not in accordance with that opinion; and as I keep as many sheep as I formerly did, and have actually more cattle, I see no reason for discontinuing the practice.

"My method of cultivation is to clear the wheat-stubbles in the autumn as far as practicable and to cart the stubbles to the fold-yard, as I never burn anything that can be in any way judiciously converted into manure. As soon as this operation is ended, I manure the fallow from the fold-yard, ploughing it in a fair furrow deep with a pair of horses. In the month of October or early in November I plant a portion of this land with Wheeler's improved early cabbage, or some other good sort; one-fourth is set apart for vetches, rye, or winter oats, which are drilled to secure a succession of crops in the spring; the other portion of the fallow is cross-ploughed as early as possible in the winter with four horses, working two abreast, the surface soil being thereby inverted and about four inches of subsoil is brought up, the layer of manure being between the two; this has the effect of keeping the subsoil light, and exposing it to the beneficial influence of atmospheric changes. After breaking down the fallow and thoroughly cleansing it, I give it, where requisite, another light ploughing at such times as I require to plant. About the middle of May an eighth part of the area is planted with mangold-wurzel; in the middle of June one-half is planted with swedes (less liable to mildew than if sown earlier); and as soon as the ground under cabbage, rye and vetches is cleared it is well harrowed, cleansed, and once ploughed for common turnips. I drill all my roots upon the flat, using from  $1\frac{1}{2}$  cwt. to 3 cwt. of superphosphate of lime, or dissolved bones mixed with ashes; not that I attach much importance to ashes as a fertiliser, but because they facilitate an equal distribution of the manure employed. The mangold-wurzels, together with one-third of the earliest of the turnips and one-third of the swedes, are carted off for the cattle; the remaining roots are cut and eaten in troughs by the sheep, which are regularly folded; and the wethers and other fattening sheep have a liberal allowance of linseed-cake and corn reduced to meal, mixed with cut hay. The store sheep follow in the folds used by the fattening sheep, and thus the whole of the land derives an equal benefit from the enriched food given to the fattening animals. As the land is cleared, it is ploughed lightly for wheat or other corn; immediately after harvest it is scarified, cleansed, and sown with mustard for autumn, or rape for spring feed; and after it has again been cleared, it is lightly ploughed for barley, and seeded down for the next year's clover, which is manured as early as possible in the following year from the fold-yard. As I fatten

Details of the tillage.

all the sheep and cattle I rear, a large quantity of good manure is made; this I use twice in the rotation exclusively for green crops. Acting on the principle that a more equal distribution in smaller quantities is preferable to the application of an excessive dressing once in four years only, I use lime, usually mixed with soil, once in the rotation; I have also used it, mixed with salt, as a top-dressing for growing wheat. My pastures are manured from a compost heap made with road-scrappings, sidings, foldyard-manure, lime, and salt; and so marked has been the effect of this application, that the whole nature of the herbage appears to have changed."

Upon all heavy soils the common rotation is, (1) fallow, (2) wheat, (3) beans or peas, (4) wheat, (5) roots, (6) barley or oats, (7) clover, (8) wheat; vetches, however, being now largely substituted for the bare fallow.

Oxfordshire.

*Oxfordshire*, with its basin of Oxford clay, of gravelly and sandy loam, its extensive stone-brash district on the great oolite, its small area of red soils on the inferior oolite in the north of the county, and its chalk or white land on the Chiltern Hills in the south, exhibits great variety and little regularity in its systems of cultivation.

Crops in the  
Chiltern  
district.

The four-course rotation prevails on the chalk and poor clay of the Chiltern district; oats or barley, however, being taken after wheat on the better soils. On the heavy land the ancient course of (1) bare fallow, (2) wheat, (3) beans, has not entirely disappeared; but common courses now are, (1) fallow, (2) oats, (3) clover, (4) wheat; or (1) fallow, (2) wheat, (3) beans, (4) oats; and to a great extent the fallow is sown with vetches or other green crop. Sainfoin occupies a considerable breadth of the stone-brash land, on which Cotswold husbandry prevails; and on the red soils it is customary to take barley after wheat.

Mr. C. S. Read  
on extra crops.

Providing an abundant succession of green food is still managed in the way described by Mr. C. S. Read more than twenty years ago. Directly the wheat is cut the land between the rows of shocks is ploughed, and the sheaves are sometimes removed by hand to the ploughed ground, so that all the surface may be turned over and ready for sowing stubble-turnips the moment the wheat has been carted. Should the field have been manured for the wheat-crop, no further dressing is applied; but, if not, guano or superphosphate is sown with the turnip-seed. These turnips require horse-hoeing, and are set out with narrow hoes, as there is no time for them to grow to any great size. The little crops produced are either fed off, to be followed by barley or oats, or they remain till late in spring for ewes and lambs, and are generally followed by swedes. To procure a constant and varying supply of green crops for the stock in summer, farmers



select a clean piece of wheat-stubble, on which they sow *Trifolium incarnatum* for feeding off. This is best done in August, certainly not later than September; the seed, about 20 lbs. per acre, being drilled in the stubble without ploughing, but twice harrowed. Some farmers simply sow the seed broadcast, and drive the sheep over it to trample it in. If trifolium is sown late, it is very liable to be partially if not entirely devoured by slugs. When the crop is saved for seed, it may produce from 5 to 10 cwts. per acre, and is generally cleared off in time for late turnips. Trefoil is sometimes sown in April on the wheat-crop, and is fed off the following spring, after the trifolium is done; and on most soils turnips are taken after both, the land being ploughed, once, twice, or thrice, and manured according as time, the weather, and the foulness or poverty of the land may dictate. Rye is not very extensively cultivated; but it is sometimes sown after the stubble-turnips and trifolium have been put in, and affords a useful ten-days' feeding as the first green-meat in the spring. Next come vetches, sown in different plots and at certain intervals from September to December; and then again a few from February to April. The quantity of seed is  $2\frac{1}{2}$  or 3 bushels per acre. The first sowing is mixed with a little rye, the next with refuse-wheat or winter oats; but beans are considered best of all, as the old sheep eat them, they hold the vetches up well, and both ripen together if saved for seed. The land for the vetches is generally ploughed but once; but for the later sowings in the autumn, and also in the spring, the ground, if foul, is skim-ploughed or scarified, harrowed, cleaned, and sometimes manured before receiving the seed-furrow.

The vetches are eaten by sheep, confined in hurdles from May to August. At first they consume the tares on the ground; but when the food becomes long and old it is cut and placed in little wicker-cages, which are used for hay in the winter. Fat sheep and lambs, in addition to the green forage, have an allowance of corn, pollard, malt-dust, or cake; or, more commonly still, are supplied with beans. As soon as the vetches are off, the land receives from one to three ploughings for turnips, sometimes dressed with manure or artificials. But the droppings of the sheep are commonly sufficient to produce a good crop of roots. The early vetches are fed off in time for swedes, while turnips follow the later feedings. The late or spring-sown tares are generally grown on land in a state unfit for turnips, and to be afterwards prepared for a corn-crop.

There is not a very large extent of country in which the land will bear with any certainty a green-crop and a root-crop in the same year. The land is often too retentive to be kind for

turnips after vetches fed off. But on the gravels of the Oxford clay formation and on the sandy soils or gravelly loams of some parts of Oxfordshire, double-cropping is carried on in a perfect manner.

Mr. C. S. Read mentions an instance of three good crops in a year—vetches fed off; then a crop of mustard which, when folded, was as high as the hurdles; and then turnips consumed by sheep. The next year this was followed by oats.

Shropshire.

*Shropshire* affords examples of rotations of cropping on very various soils in a moist western climate; the southern and western portions of the county being visited by heavy rainfall, from the influence of their lofty hill ranges and of the still higher mountains of Wales, while the eastern side enjoys a drier and warmer atmosphere.

Wheat-land district.

To the south-east lies the wheat-land district of strong loam and clay of inferior character, with some tracts of more fertile soil. Here the most general course of cropping is, (1) fallow, (2) wheat, (3) clover, (4) spring corn, (5) fallow, (6) wheat, (7) peas or beans. A considerable proportion of the fallow is without a crop; farmyard-manure being commonly applied to the fallow, and often a heavy dressing of lime, though this has been practised less of late years than formerly. Roots are taken upon a portion, and vetches or rape upon another portion of the fallow break. In that wet climate and on that soil, easily injured by trampling, it is customary, after the summer working of the land, to autumn-plough for wheat in narrow ridges of the same breadth as the harrows used upon them; so that when the wheat has been sown broadcast, the horses in harrowing a seed-bed tread only in the water-furrows.

Corve Dale.

In the fertile Corve Dale, and a limited district in the south of the county, the rotations vary from (1) roots; (2) oats, barley, or wheat; (3) seeds for one or two years, alternated with beans in the next course; (4) wheat, on the drier soils; to (1) fallow, principally sown with vetches; (2) wheat; (3) seeds or beans; (4) wheat, on the heavy lands.

Light land.

The largest proportion of the area of Shropshire, however, consists of hills and valleys of prevailing light soil, upon sandstones, limestones, shales, and gravels, with some smaller tracts of stony loam upon a marly clay subsoil, some rich red loams and belts of peat, and the deep alluvial beds of the Severn valley. Sheep farming is the rule, and the courses of cropping are commonly the four-field or five-field system, namely, roots, spring corn, seeds for one or two years, and wheat. On the best and warmest land, green crops, chiefly vetches, sometimes rye, precede the swede crop; and this is followed by spring corn, the next year's crop being peas or beans, and then wheat.



As an example of the way in which the four-course rotation is accommodated to the exigency of not repeating red clover at too frequent intervals, may be cited the practice of Mr. G. T. Forester, of High Ercall, near Wellington. Clover alternating with seeds.

The "shift," or proportion of land under seeds, is divided into three equal parts, and different mixtures sown on each. Thus, on one-third is sown for mowing a mixture of 12 lbs. of red clover, 2 to 3 lbs. of white clover, and 1 peck of Pacey's ryegrass, per acre; on another third is sown, for depasturage, 6 lbs. of alsike clover and 2 bushels of Italian ryegrass per acre; and on the remaining third, also for depasturage, 14 lbs. of white clover, trefoil, rib-grass, and parsley mixed, and 2 pecks of cock's-foot, timothy, and ryegrass per acre.

In *Warwickshire*, with its fertile soils on the New Red Sandstone, varying from sand-loam to red marl, and its smaller tracts of lias clay, presents us with examples of well-adapted rotations. As described by Mr. Herbert J. Little (in the Royal Agricultural Society's "Journal" for 1876), the following husbandry is pursued by Mr. Henry Stilgoe, of Lower Clapton, near Stratford-on-Avon, upon a heavy red marl, with stones, upon a subsoil of blue marl. Warwickshire.

The cropping is generally upon the six-course rotation common to this county, viz.: (1) swedes, mangolds, or (very rarely) turnips; (2) barley, (3) seeds, (4) wheat, (5) beans or peas, (6) wheat or barley. Heavy land farming.

This course, however, is occasionally varied, about 20 acres of seeds on the poorest land being allowed to remain two years down, and being mowed the first and grazed the second year. Besides the above crops, about 8 acres of land are always kept under Lucerne.

Commencing with the fallow land, the usual practice is as follows:—The wheat stubbles having been carefully forked over, the land is manured as early as possible with 15 loads an acre of good farmyard-dung, and ploughed immediately. In the case of mangolds, they are drilled, if possible, the first week in April, at a distance of 22 inches apart, 8 lbs. of seed being put on per acre. They receive an extra dressing of 2 cwt. of nitrate of soda per acre directly after chopping out, and the horse-hoe is immediately afterwards passed through them. Half the crop is fed on the land, and half carted away for cattle in the yards. Details of its husbandry.

The land for swedes is treated in a similar manner to that for mangolds; but these roots get no top-dressing. They are drilled as early as the second week in April upon the flat, at a distance of 22 inches, with the dry drill and without artificial manure. The quality of the roots is excellent, but there is very

often some difficulty in feeding them off. Two-thirds of this crop is fed on the land, and the remainder carted off. It must be understood that under no circumstances are two ploughings given to the land for this or other crops.

The barley crop follows the swedes and mangolds; about  $2\frac{1}{2}$  to 3 bushels is the quantity usually sown.

Seeds are sown upon the barley; a proportion varying with the necessities of the farm, but averaging, nearly one-half the acreage of seeds is mown, the remainder grazed by sheep; and about one-third allowed to remain down a second year, partly for the purpose of improving the poorer portions of the farm, and partly to enable the ewe flock to be kept entirely at home, as keeping is never taken off the farm. The grazed seeds have a good quantity of cake or corn consumed upon them by the sheep, and the second year's seeds are broken up by the steam-plough in either July or August for wheat. Wheat is sown as early as circumstances will permit, generally at the middle or end of October, or the beginning of November. About 7 pecks (or occasionally 2 bushels per acre) is the quantity of seed used. The wheat is always harrowed and carefully hand-hoed.

Beans or peas follow the wheat, the land being again manured for these crops at the rate of 12 or 14 loads an acre. The beans are drilled at a distance of 14 inches apart, and at the rate of  $2\frac{1}{2}$  bushels an acre. They are hoed with hoes 11 inches wide. Peas are sown at the rate of 5 bushels, some early variety of the white kind being chosen. Wheat (or occasionally barley) follows the pulse crop, and concludes the rotation.

Mr. Lane's  
system of  
extra cropping  
on loam soil.

On a brown gravelly loam, Mr. Lane of Broom Court, near Alcester, interpolates extra crops after beans and peas in a six-course rotation, as follows: (1) fallow, nearly all mangolds; (2) barley, or occasionally spring wheat; (3) clover or seeds; (4) wheat; (5) beans or peas, with extra crops; (6) wheat or oats. A small portion of the fallow is appropriated to spring feed, consisting of one acre sown with 1 bushel of rye and 2 bushels of vetches; one acre sown with 1 bushel of winter oats and 2 bushels of vetches; and two are sown each with 3 bushels of vetches. The four acres are afterwards broken up and sown with green-globe turnips.

Beans and  
turnips.

Mr. Lane's peculiar practice in extra cropping is thus described by Mr. Little:—"On the portion of the pulse course allotted to beans (generally about 35 acres) the winter variety is invariably sown, the land having previously received a dressing of 12 one-horse loads per acre of farmyard-manure. The beans are planted early in November after one ploughing, 2 bushels an acre being drilled in double rows 9 inches apart;

and the distance between the double rows is 27 inches. Thirty-one inches was formerly the width adopted, but some difficulty was experienced in cutting them properly with the machine at this width. This method leaves ample room for hand and horse-hoeing, which is vigorously prosecuted throughout the spring. In the third week in May, and just previous to the final horse-hoeing, a seed-harrow, cleverly prepared for the purpose, is run over the land, and drops in the centre of each wide row the very small quantity of half a pound per acre of white turnip seed. The result of this scanty seeding, evenly distributed, is a plant so thinly scattered that no hoeing or chopping-out in any way is required. The horse-hoe follows and completes the operation, at one stroke giving a finishing-touch to the bean crop and at the same time covering the turnip seed." The reaping-machine cuts the beans without injury to the turnip crop, the driving-wheel running upon the stubble. As soon as the bean-crop has been harvested the broadshare is run between the rows of turnips, in order to cut the stubble and destroy any weeds which may remain.

On the pea portion of the break a different course is pursued. "About four or five acres are generally drilled 14 inches apart, and at the rate of 3 bushels per acre, some early varieties being selected which may be suitable for pulling green for the market. Between every third row and at a distance of 42 inches apart every way, drumhead cabbages are planted about the beginning of May. The peas are sold to pick for the Birmingham market; and last year the satisfactory price of 10*l.* 10*s.* per acre was realised, the haulm being left, and the purchaser paying all expense of labour in picking. It will be readily understood with what facility the subsequent cultivation of the cabbage crop is attended. The horse-hoe is enabled to work without hindrance between the rows in each direction, and very little hard labour is therefore required." The cabbage crop is stocked with sheep in winter, with an allowance of half a pound of rape-cake and half a pint of maize, per head. On the portion of land not treated in this way peas are grown for a crop; and immediately after they are harvested, rape, mustard, or turnips are quickly put in. All the extra crops, as described, are succeeded by wheat.

Peas and  
cabbage.

The result of these second crops in each year is a large addition to the produce of the farm. In 1876 the year's crops on 196½ acres of arable were thus apportioned: wheat, barley, and oats, 96½ acres; beans and peas, 42¾ acres; seeds, 27 acres; mangolds, swedes, and vetches, 30¼ acres; and there were added by interpolation 62 acres of roots and green food, as follows:—bean-turnips, 28 acres; oat-turnips, 10 acres; vetch-turnips,

4 acres; clover-swedes, 5 acres; pea-rape or cabbage, 9 acres, and bean-rape, 6 acres. The land is kept in a cleanly condition by diligent forking out of couch and by turning under the surface, by the plough with skim-coulter, the seedlings of weeds introduced by the hay; and the repetition of crops is kept up without an excessive bill for manual labour.

In the drier climate of the Eastern counties the courses of husbandry prevalent upon different descriptions of soil have been considerably altered during the last quarter of a century.

*Essex* is a county of predominating strong lands and loams, on the London and plastic clay formations, and on the chalk marl; there are heavy clays in the northern and central districts; gravelly and mixed soils, with some light loams, in the east; and heavy clay again in the south.

In the adhesive chalky-clay district the old rotation of bare fallow, wheat, and barley, has been replaced by the improved one of (1) fallow, (2) barley, (3) beans and clover, (4) wheat; and on a considerable proportion of the fallow, mangolds and tares are universally grown. The difficulty of harvesting the mangold crop on such land is very great; but deep steam tillage is effecting a change in the texture of the sticky soil, while the facility it provides for prompt cleaning tends to extend the practice of growing green and root-crops upon larger portions of the fallow-break. On the loams and lighter lands the four-course rotation is superseded in great measure by the five-course, that is, introducing two white-straw crops in succession; a six-course being preferred on the stronger soils. Mr. Mechi, by his celebrated system of high farming, has so enriched his Tiptree Farm, that he is obliged to take barley after wheat, and the heavy-cropping red rivett wheat after white wheat.

In the Romford district, and bordering upon Middlesex, the farming partakes to a large extent of the nature of market-gardening,—potatoes, cabbages, and onions, being grown for the metropolis; early white peas, followed by late turnips or rape, have taken the place of swedes in the fallow year, and mangold and kohl rabi are much more largely cultivated of late years.

*Suffolk* has five characteristic divisions of soil, namely, strong loams, sometimes on chalk marl, sometimes on drift clay, occupying the major portion of the county and known as the "Woodlands;" the eastern sand and heath district known as the "Sandlings," extending along nearly the whole coast line; the western soil or "Fieldings," consisting of light soil on chalk and gravel, with some good lands; a small tract of rich loam in the south; and a smaller portion of peaty or Fen land in the south-west.

The Eastern counties.

Essex.

Rotations.

Mr. Mechi's wheat after wheat.

Suffolk.



As in Essex, the custom is to plough heavy lands in stetches Stetches. of ten or twelve furrows each, the harrows, rollers, drills, and horse-hoes being constructed to fit these arched strips, so that the horses walk in single file along the divisional or water-furrows. Variable as are the courses of cropping, the most general is, Rotations. (1) fallow, part bare, part mangolds or tares, with a small proportion of turnips, (2) barley, (3) half clover, half beans or peas, (4) wheat. On the lighter soils the four-course husbandry prevails; (1) fallow, growing swedes, turnips, carrots and mangolds, with a part rye fed off, followed by late turnips, (2) barley, (3) seeds, clover, trefoil, and rye-grass, or sainfoin, (4) wheat. On the rich loams, extra cropping is the practice, stubble-turnips being largely grown on rye, white barley, or vetches, to be followed by white turnips in the same year; and colewort or kohl rabi is often sown on broken up clover layers.

*Norfolk*, one of England's most celebrated counties, for the Norfolk. perfection of its light-land husbandry, for its high-quality barleys, for its sheep-farming and bullock-feeding, as well as for its four-course system and for the lead given to agricultural improvements by its memorable proprietor, the late Earl of Leicester, does not enjoy natural advantages either of soil or climate. Too arid for the growth of deep, luxuriant, early-and-late-season pasturage and for the production of turnips nutritious as those of the Lothians or parts of Scotland farther north, subject to biting north-east winds which sweep over its unwooded plains in spring, and to fervid skies which parch up its seeds and green forage in summer, Norfolk does not encourage by atmospheric influences either the grazier or the arable cultivator. Neither is the surface—for the most part gently undulating, presenting successions of large-field farms, especially in the west, and smaller, but still neatly-hedged inclosures of smaller farms, with more sheltering woodland in the east—that of a country of kindly soil, rich in native fertility. A main portion of West Norfolk possesses only a weak soil of thin, sandy, and flinty loams, resting upon the upper chalk; in the south-west is a tract of poor, light sand, reclaimed from rabbit-warren and sheep-walk; in parts of central Norfolk and in the south-east lie tracts of strong loam and mixed soils; to the north-east extend the fine productive sand loams, including the Blofield Hundred, spoken of as “the garden” of the county; and there are tracts of artificially-drained peat fens and of flat alluvial marshes in the extreme west and bordering the Wash, and also upon the coast and bordering the rivers in the south-east.

On the good lands the four-course rotation is largely replaced Rotations. by the five-course, oats or barley following the wheat after seeds; and on the fallow-break mangolds to a great extent take the

place of turnips. The quantities of oilcake and corn consumed in cattle and sheep-feeding are very great. The strong lands, generally in medium or small-sized holdings, are mainly under four-course husbandry.

On light land in the north-east, a five-course shift, taking two-years' seeds, was formerly universal. Of these Mr. C. S. Read, M.P., says, "In the second year the seeds were broken up in July, and made a 'bastard summer till,' or fallow for wheat. One could imagine no worse preparation for wheat on such lands. The ground could not be consolidated, and every facility was given for the swarms of winter annuals which infest such soils to spring up and smother the plant. The farm manure was wanted for turnips; and a one-year ley, left to its own resources, grew but little wheat." The improved system is to use artificial manures for the root-crop, and to apply the farmyard-dung on the one-year ley, ploughing it once for wheat.

The Earl of  
Leicester's  
improvements.

The agricultural regeneration of West Norfolk, the amelioration of its weak soils by the process of claying and marling, the purchasing of crops by heavy outlay in feeding-stuffs and manures, the maintenance of productive power in the soil from year to year by the compensating four-course shift and the development of sheep-breeding and winter cattle-fattening on an intensive scale, form a unique history; and it was only after Mr. Coke, created Earl of Leicester, had expended 400,000*l.* in the erection of good farm-buildings on his estate, and after his tenantry had simultaneously laid out 500,000*l.* in permanent improvements in manures and oilcake, that the spirited and liberal improver could boast of having converted West Norfolk from a rye-growing into a wheat-growing district. The four-course shift still prevails; but in place of the stereotyped (1) turnips, (2) barley, (3) seeds, (4) wheat—mangolds and a portion of kohl rabi occupy a considerable proportion of the root-shift; and wheat is taken after the mangolds, and also replaces a portion of the barley after turnips—seeing that wheat stands high management better than barley, and the seeds sown upon the wheat grow better, having a firmer seed-bed, and are left unsmothered by a laid crop. Instead of sowing red clover once in eight years, with white clover, trefoil, and ryegrass in the alternate seed year of the course, sainfoin is extensively grown in place of trefoil or white clover, thus resting the soil from any sort of clover for eight years. Giant sainfoin is drilled at the rate of 3 or 4 bushels per acre, and is ploughed up at Michaelmas for wheat. But an innovation upon the almost sacred four-course has been introduced, and is spreading, namely, the growth of a second white corn-crop, generally oats after the ley

The four-  
course shift  
improved.



wheat, but sometimes barley, which gives a finer yield than when taken in the usual order after turnips.

The practice of autumn-tilling stubbles by the grubber, so as to cleanse the fallow land before Christmas, prevails upon some soils; but the light lands of thin weak staple upon a porous subsoil are not commonly so treated; the hand-fork is used to clean out tufts of couch, and one winter ploughing, followed in spring by pulverising by the tines of the cultivator, prepares a fine seed-bed, from which the manure and condition have not been worked out by rains, and in which the moisture, so invaluable in that dry climate, is retained.

Autumn-tilling and forking.

*Lincolnshire* has obtained a proud distinction above all other counties for the rapidity and completeness of the improvements which transformed its barren heaths and flinty wolds into great districts of highly-farmed arable; for the excellence of farm-management, extending in almost unbroken succession for forty or fifty miles together; for its vast reclamations of salt-marshes, by embankment, from the sea; for the unrivalled richness of its fine alluvial grazing-lands; and for its system of tenant-right, which grew up simultaneously with the early amelioration of its surface. This latter, however, the county ought to share with Nottinghamshire, which possesses a similar system of compensation for occupiers' improvements. *Lincolnshire* is also celebrated, in common with Cambridgeshire and some neighbouring counties, for its various works of arterial and steam-power drainage, and the conversion of its region of peat and clay fens into some of the most productive corn-lands in the kingdom. It has, in common with Yorkshire, the peculiar practice of "warping," or covering poor low-lying peats and sands with a thick stratum of unctuous loam, deposited as a sediment from the muddy waters of the Trent and Ouse by artificially flooding the lands for the purpose; and it has recently won a name, in favourable comparison with other counties, for the extensive adoption of good drainage and steam-cultivation upon its heavy clays. *Lincolnshire* is also remarkable for the distribution of its holdings; large farms prevailing on the hills, while in other parts, more particularly in the south-eastern fen and marsh flat, and in a still more marked degree in the extreme north-west, known as the "Isle of Axholme," there are among medium-sized occupations very numerous small farms often little larger than allotments.

*Lincolnshire.*

Two principal watersheds divide the county, namely, the oolite hills, running through the entire length from north to south, known southward of Lincoln as the "Heath," and northward of the city as the "Cliff;" and the loftier chalk range,

Soils.

called the "Wolds," stretching at an angle with the oolite range from the Humber in the south-eastern direction, almost to the shore of the Wash. The Heath and Cliff uplands are chiefly upon the great oolite rock, and partly on the cornbrash, with inferior oolite skirting the western or steepest declivity. The soil varies from thin sandy loam to deep red loam, while there are tracts of rich red land and more extensive areas of clayey loam with fragments of stone, locally termed "creech" land. West of the hills lies the Trent valley, principally of strong lias clay, with some sands and gravels; the New Red Sandstone appears at the north-western extremity of the county, with remarkably fertile sand-loam soils, and some barren sands; while a peat district known as the "Carrs," and natural and artificial warp or alluvial lands border the Trent and other rivers. The central valley consists of Oxford Clay largely covered with drift deposits, sinking southward into the Fen level of peat and alluvium, and having on its eastern side, bordering the Wolds, siliccous, calcareous soils, red land, and soils upon white drift-marl. The Wolds, consisting of the upper and lower chalk, are covered for the most part with a sandy loam, containing flints and fragments of chalk; in some places a thin staple of light sand, in others a deep, fertile, flinty loam. On the eastern slope of the Wolds lie thick deposits of drift-clay and gravel, constituting a district of low undulations named the "Middle Marsh," between which and the coast is a broad belt of alluvial marsh land.

Heath and  
Cliff.

The Heath and Cliff less than a hundred years ago was, for the most part, a region of waste and of rabbit-warrens, covered with heaths, fern, and gorse, the only fences being the furze-capped walls of sand which inclosed the warrens; and in the centre of the wild tract south of Lincoln a tall column named "Dunston Pillar," erected in 1751, was nightly illuminated as a beacon to travellers. A large portion was reclaimed during the last twenty years of last century; Mr. Chaplin's large estate, however, being inclosed as late as the year 1823. It is now a district of large farms, large flocks, fine farmsteads, and stately rickyards. Nearly the whole of the surface is under the plough, and very highly farmed, yielding an average of fully 30 bushels of wheat and 40 bushels of barley per acre; the fertility being maintained by the oilcake-feeding of large flocks of sheep upon turnips and seeds, by making great quantities of rich bullock-manure in yards and stalls, and by the application of artificial manures for the root-crops. The four-course rotation prevails, but the five-course is also in favour. The turnips are sown chiefly on the flat, though on ridges or drills where there is depth enough of soil for the purpose; the Lincolnshire red round, white stone, grey

stone, various hybrids and tankards being the sorts occupying a major portion of the root area, with a smaller proportion of swedes; while, of late years, the growth of mangolds and of kohlrabi has extended. The yard-manure is applied both to the root-crops and to the barley-stubble for the benefit of the growing seeds. Some farmers dress the seed layers in preparation for wheat. Liming and claying are of less value on the limestone than on the chalk soils; but deep ploughing or subsoil ploughing have been practised, where the staple is not too light and porous, to deepen the soil by disintegrating the subjacent rock.

The chalk Wolds, formerly in open field or rabbit-warren, The Wolds. were inclosed chiefly during the early part of the present century; the gorse was grubbed, the rough thin sward burned, and, with the exception of a trifling amount of grass-land, nearly the whole tract is in large farms, with spacious fields bounded by neat whitethorn hedges. Chalking, the application of white or blue marl, boning, and manuring with sheep, made of the thin soil, often only a few inches in depth, a soil of proper texture and capacity for growing turnips and corn. The chalking and marling are still repeated at intervals of a few years; but fertility is constantly maintained by the consumption of great quantities of cake and other feeding-stuffs in the fold and yard, and by heavy applications of artificial manures. Nominally, the four-course rotation of cropping prevails; but as no farmer can impoverish land which must be enriched year by year or it will yield no rent-paying and labour-paying crop, great latitude is commonly permitted to the tenant in departing from the prescribed system. Barley being too strong after turnips, a five-course is frequently taken, namely, (1) turnips, (2) oats, (3) wheat, (4) seeds, (5) wheat; and sometimes the course is four and five-field alternately, the seeds being grazed for a second year. The main portion of the farmyard-manure is used for the root-crops, part on the seeds; though some farmers employ all their farmyard-dung on the seeds in preparation for wheat. Extra or catch-crops of green forage and late roots have been adopted to a small extent, and seed-layers are sometimes broken up and sown with white mustard, which, being grazed by sheep, are thus firmed by the treading. Mangolds and kohlrabi and swedes displace a proportion of the white-fleshed and hybrid turnips which formerly constituted the chief part of the root-crop.

On the strong loams and clays of the middle-marsh and the The middle-marsh. marsh between the Wolds and the coast, are many small occupations, on which the rotations of cropping are very irregular. Bare fallowing is practised to a considerable extent; but, with steam-cultivation, roots, tares, cabbages, and other green crops, have been increased in area. In the central valley, on the limited

Rotations on  
the clays.

tract of red clay belonging to the green-sand formation, the courses are (1) turnips, (2) wheat, (3) barley, (4) turnips) (5) oats, (6) wheat, (7) clover, (8) oats or wheat; and (1) turnips, (2) wheat, (3) barley, (4) turnips, (5) barley, (6) seeds, mown one year and manured, or grazed two years and manured, then broken up for (7) oats or wheat. On the sands, with very porous subsoil, some farmers apply two light dressings of farmyard-manure to the seeds in two successive years, choosing moist weather for the operation. White marl or chalky clay and lime are largely used upon these lands. On the strong clays bare fallow, followed by (2) wheat, (3) seeds, (4) beans, peas, or oats, and sometimes (5) wheat, is a common course; but tares grazed, and swedes drawn off the land, and a proportion of mangolds and cabbages, are grown.

The warp-  
lands.

In the north-western district, on the alluvial or warp-soils, potatoes are largely cultivated. The richest qualities of land yield potatoes and wheat alternately for many years; on the second-class lands crops of beans, barley, oats, clover, flax, turnip-seed, or onions, intervene between the wheat and potatoes; and a lower quality of warp is managed on a four-course shift. Potatoes are often grown after seeds as well as after a fallow-crop, and commonly after beans or flax rather than after a white corn-crop.

Isle of Ax-  
holme small  
farms.

Two varieties of soil prevail upon the New Red Sandstone, namely, clay-loam and sand-loam. Here the holdings range under 50 acres, very few farms having an extent of 100 to 300 acres; while acre, half-acre, and rood-pieces are general on the open field-land. On the clay-loam the most usual husbandry is (1) fallow, (2) wheat or oats, (3) clover, seeds, or beans, (4) wheat or oats. The sand-loam or rich barley-soil is cultivated to a great extent in semi-garden style, the crops being potatoes, onions, carrots, flax, turnip-seed, turnips pulled off, clover mown, wheat, oats, peas, and beans; the vegetables being grown for the supply of Sheffield, Doncaster, and other urban markets.

The rotations of cropping upon the peat, clay, and loam soils of the Fen and marsh districts are referred to in the chapter on the 'Cultivation of Marsh or Fen Land.'

Yorkshire.

*Yorkshire*, England's largest province, embraces, as it were, three counties, named the East, West, and North Ridings, presenting great diversities in their agriculture.

East Riding.

The *East Riding*, stretching between York city and the sea, enjoys a drier and warmer climate than the other two divisions with their rain-arresting moors and fells, though it suffers like the North Riding from the keen winds which, in spring, blow off the German Ocean.

The chalk Wolds, rising to altitudes of 500 up to 800 feet <sup>Soils.</sup> above the sea-level, sever the Riding in a curving direction from the Humber estuary on the south, through the centre and round to the north-east, terminating in the cliffs of Flamborough Head. On the high Wolds, or elevated table-land, diluvial deposits form a generally deep and dark-coloured loamy soil, occasionally with an admixture of clay; while the soil of the lower Wolds is like that of the same formation in Lincolnshire, a light, friable, calcareous loam, varying from three to ten inches in depth. To the west lies the Vale of York, a district of drift-gravels, sands, and clays, with narrow bands of good turnip and barley soil on the upper and lower oolite, and a broader belt of extremely tenacious lias clay skirting the western escarpments of the chalk hills. Eastward the chalk range slopes down into the Holderness district of boulder clay, with some sands and gravels, having alluvial deposits on the Humber and the low flats in the interior of the district. Gravel beds are found in some of the valleys of the Wold district; and sand, gravel, and peat cover most part of the Kimmeridge clay which underlies the Vale of Pickering along the northern border of the Riding.

On the Wolds, a district of large farms and great flocks of <sup>The Wolds.</sup> sheep, the fundamental rotation of crops is the Norfolk four-course; but this is departed from according to soil and circumstances. On the deeper soils wheat, instead of barley, is sown after turnips, instead of after seeds; but on the thin lands, oats or barley follow the root-crop; and the oat-crops are more frequent than barley in a series of rotations, as too close a repetition of barley is considered conducive to night-ripening in the wheat. Turnips drilled invariably on the flat, with a small proportion of swedes and a lesser extent of mangolds sown in ridges, yield a heavy tonnage per acre by the aid of liberal dressings of artificial manure; and the farmyard-manure is chiefly applied to the clover-leas—by some farmers in the autumn, a few weeks before ploughing for wheat, but by others on the young seeds just after the grain-crop has been harvested. Marling and liming are extensively practised; bones are still much used, although concentrated manures have largely replaced them; and it is the universal practice to consume great quantities of oilcake and other feeding-stuffs in rearing the fattening cattle in the yards and buildings. Two great difficulties of the Wold farmers, as in many parts of England, are the disease called “finger-and-toe” in turnips, and the failure or “sickness” of the clover-crop. A five-year, six-year, or seven-year course of cropping is resorted to by way of remedy; by introducing peas and beans, or leaving the seeds down for two years; and mangolds

are, on many farms, grown in considerable proportion in place of turnips in alternate rotations.

Vale of York.

In the Vale of York, on the tenacious clays, the old course of (1) fallow, (2) wheat, (3) beans, is modified by sometimes taking oats instead of beans; and, to a considerable extent, a four-course system is adopted by sowing clover and ryegrass on the wheat. On the sands the four-course is adhered to. In the

Holderness.

Holderness district of strong land, the course of (1) bare fallow, (2) wheat, (3) seeds, (4) wheat, (5) oats, (6) beans, has been exchanged to a great extent for (1) turnips and mangolds, (2) wheat, oats, or barley, (3) one-half seeds, one-half rape, (4) wheat, (5) beans, peas, or tares. On the strong warp or alluvial soils, beans, wheat and oats, with rape on the fallow, are the principal crops; while on the lighter lands a four or five-course rotation is common.

North Riding.

The *North Riding* has, on the west, mountain limestone fells, with rich grass-lands in the intersecting vales; also extensive coal measures. Centrally dividing the Riding are the red sandstone of the Vale of York and the lias clay of the Cleveland district; lofty oolitic moorlands, rising to altitudes of 1200 feet and 1500 feet, stretch eastward to the coast, and in a basin

Rotations.

south-east of this range lie the varied soils of the Vale of Pickering and the Ryedale Valley. The four-course husbandry distinguishes the turnip and barley-lands of the New Red Sandstone, a sand and gravel district; and the dead fallow and two corn-crop system is common on the lias of the Vale of Cleveland. But the most advanced husbandry on the strong lands follows a six-course, thus:—(1) roots, (2) wheat, (3) oats, (4) seeds, (5) wheat, (6) beans; or, less exhausting, (1) roots, (2) wheat, (3) beans, (4) oats, (5) seeds, (6) wheat. The roots, the seeds, and the beans are manured with farmyard-dung as well as artificials; and the other crops with purchased manures—rape-cake being largely applied for wheat.

West Riding.

In the *West Riding* the most prominent geological feature is the coal formation, with magnesian limestone and new red sandstone to the east, millstone-grit to the west and north, and mountain limestone in the Craven district on the north-west—a district in which the scenery is diversified by moorlands and mountains. The eastern extremity of the Riding consists of a flat of rich warp.

Semi-garden rotations.

On the coal formation in the vicinity of the great manufacturing cities, the proportion of grass exceeds that of the arable, and there exists no particular system of cropping. A common rotation is, (1) potatoes, (2) wheat, (3) clover, (4) potatoes, (5) wheat or cabbages. White crops in succession, with a green crop every third or fourth year, are not unusual. The



green crops consist of potatoes, swedes, red clover, tares, carrots, cabbage, and cauliflower-broccoli. Successive wheat-crops are sometimes grown; and there are instances of wheat taken successively for ten years together. The ready markets account for the prevalence of green or market-garden produce; and the supply of town-made manure enables the small and even larger occupiers to crop their good soil with the most exhausting courses; while liming, and the application of artificial manures assist in sustaining fertility.

On the magnesian limestone soils the four-course turnip-husbandry is most common, some farmers ploughing up their wheat-stubble for tares, which are followed by turnips—swedes being grown the next year. In the deep soil of the vales in the neighbourhood of Pontefract is cultivated lieorice, grown for its officinal roots which are two to three feet in length. The plants are set in trenches, and subsequently earthed up like celery, to a height of 18 or 24 inches in the last year of their growth. It is the practice to plant cabbages in the intervals.

On the alluvial or warp lands flax, carrots and cabbage, mustard, and, until lately, considerable breadths of teasles for use in the cloth manufacture, and also woad, are grown in addition to the usual farm crops; and the neighbourhood of Goole and Selby is noted as a great potato-growing district.

On the red loams and sand-loams of the New Red Sandstone formation the ordinary four-course system is practised on the lighter soils, and a longer rotation on the stronger lands. Bare fallow, wheat, beans, and oats prevail upon the poor and wet soils of the millstone-grit; and as well here as in the cultivated valleys of the Craven district, with its mountain grazings on the carboniferous limestone, the moist atmosphere tells against the ripening of wheat, and the springs which rise from the hills subject many of the lowlands to floods. Systematic under-drainage, however, has been executed throughout the North Riding quite as fully in proportion to the needs of the country as in any other part of the kingdom.

*Cheshire* affords examples of peculiarities of management dependent upon the existence of neighbouring markets for vegetable produce. In the vicinity of Warrington, Altrincham, Wallasey, and westward of Birkenhead, double crops of potatoes are grown upon small plots—oak-leaf kidneys, sprouted for two or three inches, being dibbled in upon well-dunged land in January, and covered thinly with soil. The ground is then covered with straw a foot-and-a-half in depth, which is taken off on fine days and replaced at night. This warm treatment brings early potatoes in the middle of April. On a larger scale, a first crop of potatoes is taken up in June, and a second crop planted.

Licorice.

Special crops on the warp.

Cheshire.

Potato culture.

Sometimes cabbages are set in November after the second crop, the land being manured for them; and after the cabbages are removed trenching follows, with another crop of potatoes. Manchester and Liverpool take the produce, and return manure for forcing more. Cheshire is celebrated for its dairy-farming and its boning of pastures, which are referred to in other portions of this Memoir.

Lancashire.

In *Lancashire* are found some of the most striking instances of the productiveness of husbandry, where large consuming centres of population are within easy reach—or rather, where the occupiers enjoy freedom of cropping, with liberty to sell off straw and hay in consideration of manure being purchased in return; for railways, intersecting all parts of England, do now practically place more distant farms in the same favourable position as those suburban holdings, while they have somewhat easier rents. I cannot do better than refer to some of the particulars given in Mr. Samuel D. Shirriff's Report on Prize Farms near Liverpool (in the Royal Agricultural Society's 'Journal,' Part I., of the present year). Mr. Shirriff well observes that "there is no more expensive system of making manure than by compelling a farmer to utilise all his straw at home. The expense of making the straw fit for application to the land is enormous. In outlying districts, far away from railways, a primitive system of agriculture may profitably exist, but only under a correspondingly low rent. The success of the farmers around Liverpool cannot be attributed to low rents. The land is rented at its full value." Their principal revenue in that rainy and growing locality depends upon sales of hay and straw; they apply enormous quantities of purchased manure; they spend over 3*l.* per acre in manual labour, a man's wages (where board is not found) being about 21*s.* per week; the tenant himself is accustomed to work much harder than his labourers, and these work well for long days and fairly earn their money. On Mrs. Birch's first-prize farm of 242 acres of black soil on sand and peaty loam, the rotation is, (1) roots, (2) wheat or barley, (3) barley or oats, (4) seeds, which lie two years and sometimes three. The usual practice is to take oats after the grass, and then beans; but this has been reversed with great success. The mixture of seeds sown consists of 7 lbs. red clover, 4 lbs. alsike, 1 lb. rib-grass, 2 lbs. white clover, or 15 lbs. in all, per acre; with half a bushel of perennial and half a bushel of Italian ryegrass. Mr. Shirriff names as the mixture of the district, red, white, alsike and cowgrass clover, with a small percentage of rib-grass, dogstail, Timothy, cocks-foot, and trefoil, at the rate of about 18 lbs. per acre; with half a bushel of Italian and half a bushel of perennial ryegrass. He

Selling straw  
and hay.

Seeds.

recommends an autumn sowing of *Trifolium incarnatum*. On Mrs. Birch's 242 acres, the labour bill amounts to between 800*l.* and 1000*l.* yearly. The quantity of stable manure used is estimated at 1000 tons annually, with the addition of 8 tons of nitrate of soda, and 1 ton of phospho-guano; nearly all the nitrate being applied to the grass-land for hay. Bought stable dung.

On Stand Farm, six miles from Liverpool, the soil clay on a subsoil of clay and rock, Mr. John Wright cuts 155 acres of hay, and grows 103 acres of oats, 22 acres of barley, 24 acres of potatoes, and 4 acres of turnips, 16 acres being pasture. He keeps 11 working horses, and grazes 400 half-bred wethers in autumn to eat up the foggage on the hay aftermath, clearing them off as they fatten, the whole generally being sold off by the beginning of December. This has a great effect upon the succeeding hay crop. "He uses 4 waggons for the delivery of his produce. They go to Liverpool in the morning with either hay or straw (about 2½ tons per load) and return at night with a load of manure of between 50 and 60 cwts. He drives over 1200 tons of manure from Liverpool annually." Liverpool manure.

This is placed on a large midden-stead (only requiring a roof to make it perfect) cut out of the solid rock, which retains all the liquid manure, the surplus of this being carted on the land for irrigation. He attaches so much value to his hay-crop that he manures his old grass for the grain-crop, and re-sows it with seeds. In addition to the 1200 tons of Liverpool manure, Mr. Wright also uses 13 tons of nitrate of soda, 3 tons of Peruvian guano, and 10 tons of hide salt; this, applied to certain soils, stiffening the wheat-straw and increasing the yield. He has built two sheds on 9-inch pitch-pine posts, with corrugated galvanised-iron roofs; one shed 100 feet long by 30 feet wide, and 18 feet height to the eaves; the other 40 feet, of the same dimensions as to breadth and height. The larger cost 185*l.*, the smaller, 91*l.* And Mr. Shirriff says, "The advantage and convenience of these are immense. What a deal of labour is saved in regard to temporary covering of unfinished ricks! But if you consider the present price of straw (thatch), about 6*l.* per ton (and this is no fictitious price, because straw is steadily and surely becoming more largely used for paper-making), how very soon these sheds will repay the outlay!"

As an illustration of the wonderful results obtained by intensive culture on small farms, take the prize farm of 37 acres arable and 8 acres pasture occupied by Mr. Hugh Ainscough at Banks, 5 miles from Southport. The soil is black, with a moss subsoil. A three-course shift is followed; namely, (1) potatoes and other roots, the potatoes being three to one in proportion to mangolds and swedes, (2) wheat, (3) seeds, generally 10 lbs. of Intensive culture on small farms.

red clover and 1 bushel of Italian ryegrass per acre. All the hay, often a magnificent crop of quite 4 tons per acre, is consumed at home, all being chopped up so as to avoid waste. Mr. Ainscough purchases every year 400 tons of stable and byre manures; this, with the home-made dung, being applied in enormous doses for the green-crops. Of artificial manures he used last year  $1\frac{1}{2}$  tons of Liverpool patent manure, 16 cwts. of Vicker's special manure, 16 cwts. of ground bones,  $\frac{1}{2}$  ton of nitrate of soda, and 14 cwts. of salt; the artificials being applied principally on the grass in spring. Sixteen milch cows are kept, and have, in addition to their hay and roots and summer pasturage, grains (draff), and Indian meal. The calves are sold as they drop and the cows as they fatten, the selling price being generally 1*l.* above the in-purchase money. Mr. Ainscough sells close upon 600*l.* worth of sweet milk annually, and feeds about 14 pigs. The labour is nearly all supplied by the family, with the exception of one hired man.

Free sale of  
produce.

Mr. Shirriff notes the two facts, that, where the straw is sold off, the money realised is more than double its value if consumed at home, and that the quantity of rich horse and cow-manure brought on to the farms to replace the hay and straw removed is far greater than all the home-grown material could produce. Nearly all the occupiers are yearly tenants, mostly subject to two years' notice to quit; and their success is owing principally to the freedom they enjoy in regard to rotation of cropping, and their liberty to send to market whatever description of produce is most remunerative.

---

## CHAPTER VIII.

### MANURES.

Artificial ma-  
nures.

WHILE the enormous waste of manurial matter poured away in the unutilised volumes of our town-sewage reflects little credit on the science and engineering of the age, English agriculture has earned a name for its costly and constant enriching of the soil with imported and manufactured fertilisers. But statistics of the total quantities of guano, of nitrates, of phosphatic and other minerals imported, and an enumeration of the works and manufactories in the metropolis and in many parts of the kingdom which do an immense trade in concentrated manures, would convey a very inadequate idea of the scale on which fertilisers are employed in high-class farm-management. The

expenditure of English farmers in restoring or stimulating the productiveness of their land and forcing the growth of their crops, will be best understood from a few examples; and, in these, the consumption of oilcake, corn, and other foods by animals, is taken in conjunction with the outlay for purchased manures.

At Kirtlington, near Oxford, on 927 acres arable and 145 acres meadow and pasture, of thin loam resting on the stone-brash or cornbrash (oolite), Major Dashwood applies for the root-crop, in addition to farmyard-manure,  $2\frac{1}{4}$  cwts. per acre of the best Peruvian guano and 2 cwts. of superphosphate of lime; barley and oats grown after wheat he top-dresses with nitrate of soda; and wheat after seeds he top-dresses with  $1\frac{1}{2}$  cwt. per acre of nitrate of soda. Corn and cake are given to sheep feeding-off swedes, and cattle are fattened on roots and cakes in foldyards and boxes. Major Dashwood's practice.

At Upper Winchendon, near Aylesbury, Buckinghamshire, on 180 acres arable and 240 acres pasture, on a strong clay-loam, Mr. John Treadwell buys annually 600*l.* worth of linseed- and cotton-cakes, and 200*l.* worth of corn, besides consuming 600*l.* worth of beans and peas grown upon the farm. This heavy expenditure in feeding-stuffs, amounting to 1400*l.*, averages 3*l.* 6*s.* 8*d.* per acre over the whole occupation. Mr. Treadwell's practice.

At Ardley, near Bicester, Oxfordshire, on 820 acres arable and 70 acres pasture, of thin brown loam on the cornbrash, Mrs. Millington applies 4 cwts. of superphosphate per acre for swedes, and 3 cwts. for common turnips; and her cake-bill amounts to 1200*l.* a year. Mrs. Millington's practice.

At High Ercall, near Wellington, Shropshire, on 300 acres arable and 400 grass, of sandy loam and part clay, Mr. G. T. Forester uses 220*l.* worth of artificial manures, and about 300*l.* worth of cake and corn. Mr. Forester's practice.

At Alrewas-Hayes, near Lichfield, Staffordshire, on 408 acres arable and 145 acres grass, of gravelly loam, strong mixed soil, and peaty soil on stonebrash, Mr. Winterton buys 274*l.* worth of artificial manures and 960*l.* worth of cake and corn. Staffordshire examples.

In the same neighbourhood, on 230 acres arable and 131 grass, of mixed soil and sandy loam, Mrs. Sankey annually applies to her crops 230*l.* worth of purchased manures, and enriches the farmyard-manure and the grass-land with 790*l.* worth of cake and corn. These average nearly 3*l.* per acre.

At Elford Park, near Tamworth, Staffordshire, on 335 acres arable and 88 acres pasture, of strong loam upon red clay, with a portion of light land, Mr. G. A. May uses 450*l.* worth of cake and corn, and applies 150*l.* worth of artificial manure. Mr. May's practice.

Near Penkridge, Staffordshire, Mr. C. R. Keeling expends Mr. Keeling's practice.

nearly 800*l.* a year in artificial foods and manures upon a farm of 360 acres.

Mr. Clay's  
practice.

Near Oswestry, Shropshire, on 128 acres arable and 200 acres grass, Mr. John Clay applies 234*l.* worth of bones, lime, and superphosphate, and consumes 234*l.* worth of cake, corn, grains, malt-combs, and bran.

Mr. M.  
Walker's  
practice.

At Stockley Park, near Burton-on-Trent, Staffordshire, on 117 acres arable and 143 acres grass, Mr. Matthew Walker's artificial-manure bill comes to 106*l.*, and his artificial-food bill to 637*l.* a year, or an average of close upon 3*l.* per acre.

Mr. G.  
Gibbons's  
practice.

Mr. George Gibbons, upon only 43 acres arable and 155 acres pasture, near Bath, buys 600*l.* worth of corn, grains, linseed- and cotton-cake, irrespective of the corn consumed by horses; and superphosphate costs him 22*l.* This amounts to nearly 3*l.* 3*s.* per acre.

Mr. Hosegood's  
practice.

Mr. Obed Hosegood, on a farm of 142 acres arable and 275 acres pasture, near Ilminster, in Somersetshire, buys annually 168*l.* worth of nitrate of soda, superphosphate, salt, soot, and lime; and 700*l.* worth of corn and cake.

Mr. Charles  
Howard's and  
Mr. Checkley's  
practice.

Mr. Charles Howard, at Biddenham, near Bedford, consumes 1720*l.* worth of cake and corn; which averages over 2*l.* per acre on his occupation, in addition to his expenditure of about 100*l.* in artificial fertilisers.

Near Woburn, Mr. Checkley consumes about 1400*l.* worth of foods, and uses above 30*l.* worth of manures, or about 2*l.* 6*s.* per acre.

An example in  
Norfolk.

On one light-land farm of 1100 acres in Norfolk, the artificial-manure bill is 1000*l.*, and over 300 tons of oilcake are consumed in a year.

Artificials in  
Lincolnshire.

In Lincolnshire Heath and Wold farming, an outlay of 5*l.* per acre in manures for the root-crop, or more than 1*l.* per acre averaged over the whole farm, is not at all uncommon; while, on the good loams, half-a-ton weight of superphosphate, nitro-phosphate, or special manure, is often applied for a crop either of potatoes or mangolds, and much more liberal doses in growing prize-crops.

Artificials in  
Cambridge-  
shire and Suf-  
folk.

As examples of the scale on which foods and manures are purchased on farms in Cambridgeshire and Suffolk, take the following cases from Mr. Frederick Clifford's exhaustive and valuable little book on 'The Agricultural Lock-out of 1874.' On 800 acres, manures cost 340*l.*; cake and corn, 660*l.* On a farm of 300 acres arable and 70 pasture, cake costs 500*l.*; corn, 550*l.*; and artificial manures, 220*l.*; or a total of 1270*l.* a year.

On 864 acres arable and 50 acres pasture, the total yearly payments for cake, corn, and artificial fertilisers, amount to 2414*l.*



The most largely used artificial manure is superphosphate of lime, owing to its cheapness, the manufacture from mineral phosphates having enabled makers to supply it at something like three-fifths the price formerly charged for the article prepared from bones; while Farmers' Associations in some parts of the country supply their members at half the old price for the manure made from bones and acid. But bone-dust is still used to a considerable extent; and in Yorkshire and elsewhere many farmers buy bones and acid and prepare their turnip manure themselves.

Peruvian and other guanos may be placed next in the favour of English farmers,—a sounder feature having been lately given to the trade by the introduction of the fair and reasonable system of valuing according to analysis an article which varies so extremely in quality in different cargoes. Nitrate of soda is also very largely used; but complaints are universal as to the high rates at which both nitrate and guano are alone procurable. Biphosphated and dissolved guanos, Odams's nitrophosphate, blood-manure, and a great number of special or compounded manures for every species of crop, are also sold by agents in every agricultural market-town, and largely applied in the farm management of every district with the exception of a few backward and benighted localities.

It would be a long list if I were to enumerate all the artificial fertilisers offered for sale on English corn-exchanges; for, as noted by Mr. J. Dent Dent in his very instructive paper on the Census of 1871 (in the 'Journal of the Royal Agricultural Society,' vol. x. N.S.), there were 581 manure-manufacturers in England and Wales in the year 1861, and 1210 in the year 1871. The various guanos are applied at rates per acre from 2 up to 4 cwts.; nitrate of soda, 1 to 2 cwts.; superphosphate of lime, 4 to 8 cwts.; sulphate of ammonia, 1 to 2 cwts.; nitro-phosphate or blood-manure, 3 to 6 cwts.; common salt, 4 to 8 cwts.; Kainit or potash salt, 3 to 5 cwts., but this generally in connection with other manures. Among the manures of limited application are woollen rags, horn-dust, gas-lime, gypsum, charcoal, soot, and the waste products from many manufactures. And it being impossible to adduce any particular manure or mixture as commonly preferred for roots, for corn, or for pasture, I have been content to give a few instances of actual practice in the chapter on Rotations of Cropping, and to state the amounts of money expended by good managers in the purchase of artificials. Thanks to the efforts of the Royal Agricultural Society and other agricultural bodies, the practice of buying subject to analysis is being greatly extended.

Fish. In parts of some counties lying close to the sea, sprats, mussels, and star-fish are put into mixens with earthy and vegetable matters, and form an exceedingly rich and fertilising compost. The cost of sprats is usually about 10*d.* a bushel; 50 or 60 bushels per acre being applied when used alone as a dressing for wheat. Star-fish, or "five fingers," are about 5*d.* a bushel, and are applied at the rate of about 120 bushels per acre. Mussels are generally bought by the waggon-load for about 20*s.*, and 150 bushels are put on per acre.

Seaweed. Seaweed, on some coasts, is collected in considerable quantities, and either applied to the land in its wet or green state, or, which is the better method, made into a compost in the manure-heap.

Composts. Composts made on the farm are of many kinds; one of the commonest being night-soil with ashes or earth, sometimes in combination with poultry or pigeon manure, dried and prepared for the drill by admixture with the ashes of earth, root-weeds, ditch-parings, &c., burned in the cleansing fires of the fallow season.

Bone-dust, between layers of farmyard-dung, is also a very valuable compost. But road-scrapings, pond-mud, and all the products from scouring outfalls and tidying up corners and collecting rubbish are made available in conjunction with liquid drainings of the straw-yard.

Durable applications. Among applications of a durable character are bones on pastures, rape-cake, lime, chalk, marls of various kinds, shell-sand, and clay. From 1 to 2 tons of crushed bones per acre are applied to the clay pastures of dairy-farms in Cheshire, also in Staffordshire, and some other counties, at a cost of 7*l.* to 10*l.* per acre. The results in improvement of the herbage and greater richness of the milk are remarkable, and the effect is more immediate from boiled bones (from glue and size factories) than from fresh ones. Rape-cake or rape-dust, either worked into the soil for roots, or applied in moist weather as a top-dressing on wheat, acts beneficially for several years,—besides being found to be, partially at any rate, an antidote to wire-worm.

Marling. In olden times great trust was placed in the manurial value of those unctuous earths, the various kinds of marl, as testified by the old disused marl-pits in many counties. The practice is very limited in the present day; being resorted to in some light-land districts for improving the texture and quality of the soil, and repeated at intervals of many years. Thus, red land and clay soils in Lincolnshire are dressed with 40 cart-loads per acre of white or blue marl, the effect lasting for a long series of years. And in Norfolk, the marling or claying of friable and light

lands, which was one fundamental process of improvement half a century back, is now rarely repeated; being principally reserved for the consolidation of peats and sands.

Chalking is still a necessary improvement at long intervals on many lands either lying upon or within easy carting distance of the chalk hills. Thus chalk is extensively used on the heavy soils in Kent, particularly upon the pastures. From 12 to 18 tons per acre are commonly applied; no repetition is needed for twenty years, and then only a light dressing. The chalk moulders down under the influence of frost and rain, and is soon worked into the soil. On the Lincolnshire Wolds the light flinty loams are durably improved by applications of 80 to 100 cubic yards of chalk per acre. Chalking.

Claying the peaty soils of the Fen country is accomplished on the shallow peats by very deep trench-ploughing; but on the deep black soils, by digging wide parallel trenches at intervals several feet in depth, and throwing out by spade some feet in thickness of the blue buttery material (an alluvial deposit), which is afterwards spread upon the whole surface of the field. Claying.

Liming with heavy doses, once a fundamental feature of farm-management over a considerable proportion of England, and imposed upon tenants by binding restrictions in covenants and leases, has given way before the introduction of artificial manures. It is chiefly on heavy clays and on newly broken-up land that dressings of 200 to 300 bushels per acre are now applied; and such strong treatment is not repeated for perhaps twenty years. On the limited number of farms where it is still the custom to lime once in every rotation, the quantity is now more commonly 100 bushels, or about 4 tons per acre. On light soils, small doses may be repeated, to compensate for the gradual sinking of the lime into the subsoil. Where lime is employed merely to give to the land a constituent which is short in quantity, mild or old-slaked lime is employed. But, for the most part, the purpose is to promote the decomposition of vegetable matter and to sweeten the soil; and hence it is the more general practice to apply the lime in a caustic state, that is, newly-slacked, sometimes, indeed, as hot as the carts can contain it without injury. When on the fallow for roots, and farmyard-manure is to be used for the same crop, the lime is ploughed in and well incorporated with the soil for some time before the manure is led on. Liming.

Of late years, the practice has extended of applying moderate dressings of lime to old pastures, the increase and improvement in herbage being very marked. There are, however, certain descriptions of land—as for example, on some of the oolite formations—which receive no benefit from liming, but, on the

contrary, are said to be deteriorated by the process, no matter in what condition the lime is applied.

Farming with-  
out manure.

Corn- and hay-farming without farmyard-manure, by aid of deep and thorough steam-cultivation and plentiful applications of artificial fertilisers to compensate for straw sold off, is practised with success by enterprising farmers, such as Mr. John Prout, of Blount's Farm, Sawbridgeworth, Hertfordshire. But very few farms exist on which the ordinary system of converting straw into manure and carting this on to the land is supplemented or altogether supplanted by the system of liquid manuring and irrigation.

Liquid-manure  
irrigation.

Mr. Mechi's  
practice.

At Tiptree Hall, near Kelvedon, Essex, Mr. J. J. Mechi has made celebrated his method of cutting straw for food instead of using it for bedding; of keeping cattle, sheep, and pigs, upon sparred floors, catching the solid and liquid droppings, and conducting them into a cistern or tank, and by steam-power pumping the liquid-manure through pipes laid underground to hydrants, whence, by means of hose, it is distributed over the surface of the fields.

Other ex-  
amples.

Selling the solid-manure from cow-byres, pumping the liquid-manure to a head on the highest part of the farm, thence conveying it by underground-pipes to the fields, and distributing it by half-inch iron-pipes in movable 6-foot lengths, has been adopted only in some other scarce instances. Many good managers, however, economise the liquid-drainings from their farmyards by tanks, and either cart the liquid upon the land or absorb it in compost-heaps. In some situations, where it can flow in channels by natural gravitation, the liquid is used for irrigating ryegrass, other green forage, or permanent grass.

Farmyard-  
manure.

With regard to farmyard-dung, which, in spite of the vast extension of the trade in "bag" manures, and in spite of the increasing sale of straw and other manurial produce, remains yet the English farmers' "sheet-anchor," it cannot be denied that much imperfect and wasteful management prevails in many parts of the kingdom. But there is often this excuse for the occupiers:—the exposure of farmyard-manure to all the drenching rains of winter (with these made cumulative by discharging into the open courts the water from the unsputted roofs of barns, byres, stables, granaries, and cart-sheds), and the draining away of the soluble constituents with which the dung has been enriched at a heavy outlay for roots and fodder and feeding-stuffs, are unavoidable until the proprietors erect farm-premises planned with a view to the economical manufacture and preservation of manure. Nevertheless, all the best-farmed districts abound with examples of well-constructed buildings; while there are numbers

of large estates—such as those of the Duke of Bedford, the Earl of Leicester, and many other proprietors—on which no occupation has been left without a farmstead rebuilt, or remodelled and improved.

The prevailing type of homestead provides for the manufacture of manure in rectangular yards or courts, separated by fences or by low buildings, sheltered from winds by high buildings on the north, open towards the south, and with a small proportion of the area covered by shelter-roofs resting partly on the yard-walls and partly upon pillars. The bottoms of the yards are dished; the liquid draining into a tank, whence it can be pumped out and either distributed over the straw when too dry, or used for forming moist compost, or, in fewer instances, for water-cart irrigation. Owing, however, to the increasing commercial value of straw, as well as the better appreciation of its feeding and manurial value, and the higher quality of dung made under cover, the modern tendency is in favour of yards completely roofed-in. The exceptions are in the great straw-producing districts of the dry-climate eastern counties, where saving of straw for bedding is not a very important object, also on some strong lands, where bulky straw-manure is desired for opening the texture of the soil, and on farms where close and dry housing is not considered conducive to the hardihood and stamina of young cattle.

The analyses of Dr. Voelcker, Professor Church, and other masters of agricultural chemistry, showing that, weight for weight, a ton of manure made under cover is worth about one-half more than a ton made in an open yard, are confirmed by a large amount of experience. This difference arises principally from the smaller proportion of straw and water to the same quantity of animal excrement existing in the covered manure; at least 50 per cent. less straw being required for litter as compared with the open-yard manure; but it is also to a considerable extent due to the preservation of the fertilising salts from waste. There is also economy in the covered-manure system, from the dung cutting out in a richer mass ready for immediate application to the land, without the labour of turning over and mixing to promote fermentation or carting out to lie for a time in wasteful field-heaps.

Thoroughly rotted manure being desired for certain crops, as, for example, mangolds, the practice of forming large dung-heaps during the winter in convenient places about the farm is still very general; and greater attention is paid to due consolidation for the retarding of fermentation and to covering down the heap with a thick layer of earth for arresting the escape of volatile

Open and covered yards.

Greater value of covered-yard manure.

Saving in straw.

Dung-heaps.

Dung-pits.

ammonia. It is far more common to relieve the yards of an excessive quantity of manure from time to time by carting out portions to such field-heaps, than to store the dung in pits, excavated, brick-lined, and protected by a shed-roof for the purpose; though these exist on some farm-lands, forming an admirable means of preserving the manure in the best condition. Pits under sheds, provided on different parts of the farm convenient for application to the land, have been introduced, but very scantily adopted. The major part of the farmyard-manure, however, is carried direct from the yards in which the manure from stalls and stables has been regularly added to that made by cattle, and also from sheep-yards, and is applied in its fresh condition to the land. Care is taken to plough in the manure promptly in warm and dry weather; but, in cold and moist weather, exposure after spreading is not found detrimental; and the top-dressing of young seeds is done at that season when spring rains wash the short manure, to the benefit of the absorbent soil below.

---

## CHAPTER IX.

### MOTIVE POWER. IMPLEMENTS AND MACHINES. STEAM CULTIVATION.

Ox-teams.

*Ox-Teams.*—Slow oxen urging the unwilling plough, or with tedious steps hauling the ponderous-toothed drag through the huge clods of a fallow, are to be seen only in a small number of the English counties; though many a farmer is accustomed to train a bull to work in carting field produce—a labour for which, owing to their great strength, these animals are well adapted.

Ox-teams are employed to a small extent in Wiltshire, Devonshire, Cornwall, Sussex, and some other counties; chiefly as an adjunct to horse-teams, and not to perform the whole draught labour of the farm. It is calculated that, in harrowing or rolling, a pair of horses will do 8 acres a day, when four oxen will scarcely do more than 6 acres a day; and in ploughing, a pair of horses will turn over an acre a day, when four oxen will scarcely accomplish three-fourths. In carting on hilly farms, four good oxen are considered equal to a pair of horses. The custom is to keep double the number required to work at any one time, one-half being yoked out in the morning and the other half in the afternoon.



The usual method of feeding working-oxen is to give them straw and roots in winter, and grass in summer, with an occasional allowance of corn during the busy season. When oxen are bought-in as two-year-olds, employed in doing summer tillage only, used to tread down straw into manure in winter, and finally sold out as four-year-olds, the common calculation is that they improve in value, and that their labour, though tedious and generally limited to a part of the year, is not expensive as compared with that of horses; the keep of a team-bullock costing probably about half that of a farm-horse.

The exigencies of the meat supply, and the ability of modern feeding processes to mature cattle of refined breeds into two-year-old beef, are pressing to banish such animals altogether from draught labour even in the few localities where ox-teams have longest held sway in the mechanical economy of the farm; the problem now occupying attention being that of superseding the greatest possible proportion of costly animal power by yoking the steam-engine to one after another of the heavy and light draught-operations of agriculture.

*Farm-Horses.* For every hundred acres cultivated in England and Wales about  $4\frac{1}{2}$  horses are enumerated as "horses used in agriculture, unbroken horses, and mares used solely for breeding." The 830,000 horses "used solely for agriculture" average about 3 for every hundred acres cultivated; and as 15,000,000 acres out of the total cultivated area of 27,000,000 acres are arable, the number of farm-horses averages about  $5\frac{1}{2}$  for every hundred acres arable. Farm-horses.

The number of horses kept on various kinds of soil and under different systems of husbandry, where high-class management prevails, appears in the following examples.

On a light-land farm under the five-course shift, having two-fifths in corn, two-fifths in seeds, and one-fifth in roots, a pair of horses is required for every seventy or ninety acres, according to the level or steep contour of the fields and whether two or more ploughings are given for the root-crops. Number kept  
on different  
soils.

On a clay-loam farm in Buckinghamshire under a six-course rotation, with roots and catch crops, the proportion of horses kept is three to every sixty acres arable, three horses being used in a plough.

On a Shropshire farm of sand-loam, with part stronger soil, under the four-course system, there is a pair of horses for every sixty-six acres. On selected medium-soil and light-land farms comprising 6000 acres arable in various counties from Berkshire to Yorkshire, the teams average one horse to every twenty-seven acres. On selected heavy-land farms, embracing 15,000 acres

arable in many counties from Wiltshire to Northumberland, the average is one working-horse to every twenty-three acres.

Management.

There is no distinctive English system of managing farm-horses. They are stabled in various ways,—either kept singly in stalls, or in pairs in stalls, or placed together in a long stable; sometimes separated from each other by a swinging bar, a partitioned-off box being reserved for a kicking or restive horse. On some farms the horses are kept in loose boxes; in other cases the old plan is still retained, namely, of feeding in the stable and turning the horses into an open straw-yard, partly under a shelter-roof, for the night; while in many newly built premises the horses lie in covered yards.

Breeding.

On the great majority of large and medium-sized farms it is the custom to breed a sufficient number of cart-colts to keep up the working stud; many managers dispose of the most saleable of their horses after about a couple of years labour in the field. Larger numbers of colts are bred for sale on holdings which comprise a good proportion of old pasture of ordinary quality, tolerably free from stones, with well-fenced moderate-sized enclosures, in a not very steep country, but with a moist climate, and where no excessive demands upon the teams in summer are made by the necessities of clay-land culture. The system of travelling-stallions is almost universal; but in spite of the vast improvement accomplished of late years by competitive Shows of the Royal and the County Societies, and by the introduction of good sires by very many large landowners, many districts still complain of the difficulty of obtaining good sound horses for service on cart-mares.

Colts.

Foals are generally dropped in May, weaned in the autumn, and wintered for two successive years in sheltered paddocks furnished with shelter-hovels; though in some counties, particularly in the rainy and cold north and west, this treatment is deemed too severe, and the young horses are wintered in yards.

Breaking.

They are not always broken in to work as four-year olds; as three-year-olds are commonly trained in some of the midland counties and elsewhere by putting them to part-day hauling in the single-file three- or four-horse teams, often on land which two stout horses could plough without difficulty.

Feeding.

Very varied are the practices of different localities with regard to hours of labour, including single short bouts in winter, and two bouts per day in summer, with a bating time between; the number of men, or men and boys to work and groom the pair-horse, three-horse, or four-horse teams; and the summer and winter feeding. As a rule, the old wasteful system of giving the

horses hay in racks, as well as the Lincolnshire practice of feeding on oat-sheaves cut into chaff, has gone out of favour; and the best managers cut up hay and straw, and give their horses ground corn, or crushed oats, sometimes bran or pollard, with a portion of pulped roots or green tares added to the dry food. In some districts the farm-horses are grazed on the pastures in summer; but the practice of keeping them in stables or yards the whole year round prevails in most tillage districts, and is extending.

The cost of horse-power, depending upon the assumed value of the fodder and forage which, commonly, are not allowed to be sold off, is a matter of varying estimates. Some years ago Mr. John Chalmers Morton deduced averages from statistics of a considerable number of cases,—making the annual outlay per head 23*l.* for food, and 5*l.* 10*s.* for blacksmith's, saddler's, and farrier's bills, and for depreciation (or replacing and maintaining the value of the horse unimpaired), or 28*l.* 10*s.* per horse. Adding 3*l.* 2*s.* for wear and replacement of implements, and 14*l.* 8*s.* for part wages of the team-men necessary to drive and groom the horse, the total yearly cost came out 46*l.* A deduction should be made from this sum for the value of the horse's manure. But, on the other hand, the great rise in the price of horses, in the value of hay and straw, in the price of all articles concerned in the application of horse-power, and in the cost of manual labour, has certainly increased the estimate. In fact, authorities at the present time would not be inclined to value the day's work of a horse, without the share of manual labour connected with it, at less than 3*s.*, considering the number of days in a year on which horses are at rest. Hence, the ploughing of three roods of stiff land per day by a team of four horses, attended by a man and boy, may easily reach 21*s.* or more per acre; and turning over a full acre of light land per day by a pair of horses and one man, may cost the farmer as much as 9*s.* per acre; the average cost of ploughing in England lying between these amounts.

*Mules and Asses.*—Recently there have been some successful attempts to introduce into farm-labour mules and asses, which are economical from their endurance and thriftiness of feeding; and for this purpose high-standing active French and Spanish asses, and mules from Poitou, have been imported.

*Water Power.*—On some few estates in England water-wheels are employed for driving fixed threshing-machinery; and there are many cases—some of them on holdings of moderate or small extent—in which a small wheel, sometimes urged by an artificial stream consisting of the collected waters of the farm under-drains, is made to drive the farmer's mill, crusher, chaff-

Cost of horse-power.

Mules and asses.

Water power.

machine, and other machinery of the feeding-house. Where a regular flow of water of sufficient volume can be depended on, no other motive-power is found to equal in economy an over-shot or a breast water-wheel. Indeed, for the comparatively light operations of the farmstead, a very small stream, or even the drainage of the land itself, is found amply sufficient, when stored during the periods of rest in a reservoir of small area dammed for the purpose. Turbines also are used in some situations, where an adequate head of water is available, for the farm grinding and cutting; these motors having been greatly improved in efficiency during late years by the application of scientific principles to their design and manufacture.

Wind power.

*Wind Power.*—Wind-engines, equally economical in operation and more cheaply erected, are adopted in some places where their fickle, intermittent, and irregular action does not altogether forbid their services in grinding and pumping. One element in their economy is that, being self-regulating, they will work night and day without attention. Windmills actuating scoop-wheels for district drainage at one time distinguished the Great Level of the Fens and some other lowland tracts; and in a few localities they are still retained for baling out the water of ditches on very low-lying farms, and discharging it into embanked main drains or rivers.

Steam power.

*Steam Power.*—No statistics have been collected on an adequate scale as to the average amount of steam-power for every hundred acres now engaged in tilling, threshing, hauling, and other operations of agriculture. Looking, however, to the fact that all except a fractional proportion of the corn-crops of England are threshed by steam; that a majority of the large farms have steam-engines of their own; that on great numbers of medium-sized as well as large occupations are also found engines of small power for chaff-cutting, steaming, &c.; and that farms on which steam-cultivation is practised may be enumerated by hundreds in some, and by tens in almost all counties,—it is evident that the nominal horse-power of the engines used in agriculture bears a very considerable proportion,—it may probably approach one-fourth—in relation to the total force of horse-teams. Where the threshing is not done by itinerary steam-threshing machines, as it is on probably a majority of farms, the nominal power of the steam-engine is fully one-half, and sometimes considerably exceeds one-half, that of the farm-horses; and where the steam-plough is adopted and horses have been displaced, the nominal steam-power frequently equals and in many cases exceeds that of the whole force of horses employed.

Amount of  
steam power  
used in  
agriculture.

Fixed engines and fixed threshing-machines are less numerous in England than in Scotland, where they are common; indeed, in England, only a minor proportion of the occupations are provided with barns of sufficient magnitude for storing straw as well as holding the sheaf-corn for a day's threshing. The more prevalent arrangement is to thresh out-of-doors by a portable engine and machine; while in some districts it is customary to save time and labour in harvest, and to minimise the risk of loss by fire, by stacking and threshing a portion of the wheat and barley in the fields or at an "off" yard. Except in cases where horse-power or a semi-fixed steam-engine of low power is employed for the purpose, the portable engine, when not engaged in threshing, is placed so as to drive the food-preparing machinery in the farm-buildings. Steam-ploughing engines are also used in the same way.

Fixed and portable engines.

Among the most extensive as well as admirably designed and completely furnished farmsteads of which English husbandry can boast are those of Mrs. J. Gerard Leigh, at Luton Hoo, in Bedfordshire (this being by far the largest in the kingdom); Lord Bateman's Uphampton Farm, at Shobdon, in Herefordshire; Sir Henry Dashwood's Northbrook Farm, at Kirtlington, in Oxfordshire; Mr. J. C. Garth's Haines Hill Farm, near Twyford, in Berkshire; the Marquis of Bath's Longleat Farm, in Wiltshire; Netherhampton Farm, on the estate of the Earl of Pembroke and Montgomery; Sir Edward C. Kerrison's Brome Hall Farm, Eye, in Suffolk; Mr. Goodman's farm at Thorney, Cambridgeshire, on the Duke of Bedford's estate; Mr. J. Hegan's farm at Dawpool, in Cheshire; Mr. John Wells's Sancton Hill Farm, near Booth Ferry, Yorkshire; Walls Court Homestead, near Bristol; Colonel Dunn's premises and machinery near Hungerford, in Berkshire; Lord Portman's, at West Lambrook, in Somersetshire; those of the Earl of Radnor, at Coleshill, in Berkshire; of the late Sir John Shelley, at Maresfield, in Sussex; Mr. Brassey's farmstead near Malpas, in Cheshire; that of the late Mr. E. Holland, at Dumbleton, near Evesham, in Worcestershire; Captain Cust's Kenwick Park Farm, near Ellesmere, in Shropshire; Mr. Reginald Corbet's, at Adderley Park, in Shropshire; Mr. Richard Oakley's premises at Laurance End, in Herefordshire; Kenwick Farm on Earl Brownlow's estate in Shropshire; the Honourable Mark Rolle's Bagmore Farm, in Devonshire; Mr. Robert Overman's farmstead at Egmere, in Norfolk, on the Earl of Leicester's estate; Mr. W. Byrch's, at Wretham Hall, in Norfolk; Sir W. Jones's, at Cranmer Hall, in Norfolk. And numerous examples are to be found also on the estates of the Earl of Yarborough and Mr. Chaplin, M.P.

Noted homesteads.

in Lincolnshire; the Duke of Cleveland, the Duke of Northumberland, the Earl of Tankerville, Lord Vernon, Earl Cathcart, Colonel Kingscote, M.P., the Marquis of Exeter, Earl Spencer, Earl Powis, the Duke of Portland, and a great number of other landowners.

The arrangement of apparatus adapted for threshing, dressing, grinding or crushing corn; for raising straw into stacks or chambers; for the conversion of straw into fodder or litter; for cutting and pulping roots, and mixing and steaming food; for crushing oilcake, pumping water, sawing timber, churning, crushing apples for cider, and other mechanical operations in which steam-power has taken the place of horse and manual labour, may be exemplified by reference to two or three of these farm-steadings.

Messrs.  
Tuxford's  
machinery on  
Lord Bate-  
man's farm.

On Lord Bateman's Uphampton Farm (as described in Mr. J. Bailey Denton's 'Farm Homesteads of England') the corn is stacked upon low iron trucks, which can be moved on tramways having a slight inclination towards a covered shed adjoining the threshing-machine; and the stack to be threshed is moved bodily under this shed, where the sheaves are pitched on to the machine. A 12-horse-power fixed engine drives two ranges of shafting at different heights; the lower range being driven by a belt from the 8-foot diameter fly-wheel, and the upper shaft by a rigger of 3 feet diameter on the engine crank-shaft. The straw for the machine is elevated by a "straw climber" into the roof over the machine chamber, there to be cut into litter and afterwards carried forward for a distance of about 70 feet over the straw-barn by means of a 'litter-creeper;' openings at intervals along the bottom of the trough allowing the cut litter to be deposited at any part of the length of the barn for being conveniently thrown out to the stock. A straw-carrier above the litter-carrier bears the straw forward, to be similarly dropped through the floor when it is not required to be cut into litter. The grain, cavings, and chaff are separated by a series of riddles and a fan under the box straw-shakers and drum, the chaff is deposited on one side of the machine, the cavings on the other; the grain is elevated, passed through a white-coater and barley-awner, and then through a dressing-machine and blower. It is delivered into a self-acting sacking apparatus, which weighs each sackful and rings a call-bell for an attendant to remove the full bag and place an empty one in its place; or the finished corn is carried by a worm elevator to the granary.

In the root-house on the ground floor, a root-washer, a turnip-cutter, a pulper, and a grindstone are driven like the threshing-machine, from the lower shaft. In the mixing-house is a



cooking-apparatus, with steaming-pans and a boiling-pan, this being heated sometimes by exhaust steam from the engine, and when this is not at work, by a separate fire connected with the engine chimney. An apple-mill and cider-press are fixed in the mixing-house, and on the chamber-floor a pair of 3-foot peak-stones, a roller-mill, a cake-breaker, a chaff-cutter, and a sack-hoisting tackle are driven by the upper shafting. The machinery was erected by Messrs. Tuxford and Sons, of Boston, Lincolnshire.

At Dawpool, in Cheshire, Mr. Joseph Hegan's farm, an 8-horse-power fixed engine drives by belts two lines of shafting,—the upper one actuating the threshing and dressing machinery, and the lower one imparting motion to the mills and smaller machines. The threshing-machine is one of the complete and perfectly acting machines of Messrs. Clayton and Shuttleworth of Lincoln, who constructed the whole of the machinery; and it will thresh 7 to 8 quarters per hour. The same line of shafting which drives the threshing and dressing machinery, also drives a chaff-cutter on the floor of the straw-barn; the cut straw falls into a mixing-bin in the forage-barn beneath, which is conveniently situated for receiving the produce from the steaming-pans placed in the same compartment, and the pulped roots from one adjoining. In a large chamber next the boiler-house are fixed an oilcake breaker; a roller-mill for crushing linseed, oats, or beans; and a grinding-mill with French burr bed-stone and Derbyshire grey running-stone, 3 feet in diameter,—this mill grinding about 4 bushels per hour of fine flour, or bruising or kibbling a very much larger quantity. In an adjoining compartment is a single-roller bone-mill, capable of crushing and riddling 10 to 15 tons of bone per day of ten hours. At the end of the boiler-house is the pulping-house and forage-barn, with machinery for pulping and steaming roots—the steam being supplied direct from the engine-boiler. A lift- and force-pump supplies the water required.

Messrs.  
Clayton and  
Shuttleworth's  
machinery.

The stackyard is covered; it is 150 feet long by 78 feet wide, and 20 feet deep from the floor-line to the underside of the tie-beams of the principal trusses. It is divided by a paved roadway into two main compartments, which are again subdivided by the trusses into 30 bays, each 30 feet deep by 19 feet wide. It will hold on an average 120 acres of corn in the sheaf.

Covered  
stackyard.

Mr. J. C. Garth's machinery at Haines Hill, Berkshire, constructed by Messrs. Ransomes, Sims, and Head, of Ipswich, has an 8-horse fixed engine, driving one main shaft by a belt from the fly-wheel, while bevel-wheel gearing gives motion to a second line of shaft on the same level and placed at right-angles to the first. A cooking-apparatus is arranged near the boiler.

Messrs.  
Ransomes,  
Sims, and  
Head's  
machinery

The dressed grain from the threshing-machine is delivered into scales and weighed ready for market; the straw is delivered by the rotary shakers on to the floor above, and the chaff into a separate compartment under the straw-shakers. In an apartment adjoining the threshing-machine is a small roller metal mill, for bruising oats and linseed, united with a triangular-toothed bean-cutter; also a pair of 3-foot French mill-stones, fitted with dressing apparatus, a pair of 4-foot Derby stones, a blower, and an elevator for raising the meal to the floor above. In the root chamber are an oilcake breaker and a double-action Gardner's turnip-cutter; while a chaff-cutter is fixed on the floor over this. The second line of shafting drives a saw-bench, fitted with boring augers, and also a double-acting pump. Adjoining the boiler-house is a kiln for drying grain; the fire-door being arranged opposite that of the boiler, so that one engine-driver can attend to both.

Simple arrangement for food-preparing machinery.

A simple and convenient plan for food-preparing machinery is to erect a floor or staging at one end of a barn, placing the chaff-cutter and corn- and cake-crushers on this floor, with the pulping and slicing-machines on the ground-floor; and all the machines may be driven simultaneously by setting down a portable engine outside the barn, or one or two together by a small semi-fixed engine, or, one at a time, by a pair of horses working a horse-gear out-of-doors with a spindle passing through the barn wall. All three methods are to be found extensively adopted; horse-gears for chaff-cutting, pulping, and cake-breaking being the most common.

Steam ploughs and cultivators.

*Steam Ploughs and Cultivators.*—Of that type of steam-tilling machine foreshadowed by the genius of the late Mr. C. Wren Hoskyns, in his 'Chronicles of a Clay Farm,' and embodied in experimental apparatus by Mr. Romaine and other inventors, in which a digging cylinder is driven in connection with a slowly-travelling locomotive engine, no practical example remains at the present time; though Mr. Darby, in the neighbourhood of Chelmsford, has just introduced an engine which, with its horizontal boiler, slowly advances in a broadside direction, and by spades or forks digs a stripe of many feet breadth as it proceeds. Neither is there anything but experimental use made of traction-engines for hauling ploughs or other implements similar to those drawn by horses.

The Fisken system.

The system of working tillage implements by wire rope in connection with a rapidly driven Manilla rope mounted upon high porters with friction-wheels, as introduced by Mr. Fisken, has been adopted by a considerable number of farmers, and also by persons who execute ploughing and cultivating by con-

tract, in various counties. The plan is specially adapted for hilly land, enabling a portable steam-engine of small or moderate power, stationed beside a pond or brook, to communicate motion to hauling-windlasses at a great distance or upon steep surfaces; the area of deep or heavy work done per day is greater than might have been expected from the comparative lightness of the tackle, and, under good management, the wear of the hemp or Manilla rope is not found excessive.

Direct hauling by steel-wire rope, as brought before the world about a quarter of a century back by Mr. John Fowler, Mr. David Greig, Mr. William Smith of Woolston, and Messrs. Howard, is the system distinguishing the many hundreds of sets of apparatus which perform the great bulk of the steam husbandry of the kingdom.

Three distinct modes of application are followed: namely, Wire-rope systems. one in which the engine and windlass are stationary; another in which the engine is shifted along one headland opposite to an anchor with pulley traversing the other; and a third in which two self-shifting engines, with winding drums, are employed on the two headlands, hauling the implement to and fro between them.

The first plan has several modifications. In some cases the old method is retained of laying out the rope round all four sides of the field by means of a pulley at each corner hung to a claw-anchor; the anchors at the ends of the furrow or course traversed by the implement being removed and shifted forward along the headland at every bout by labourers employed for the purpose. To save this manual labour, the self-moving anchor is adopted, the frame carrying the rope-pulley being mounted upon four or more small travelling-wheels fitted with sharp discs which cut through the soil and present a sideway resistance to the strain of the plough-rope. In the anchor of Messrs. Barford and Perkins, of Peterborough, the plough-rope, Messrs. Barford and Perkins' machinery. laid out along the headland, pulls the anchor forward at intervals when the strain is on; the movement is arrested at the required point by rotary tines or claws clutching into the ground in the rear, and the distance passed over is self-regulated by means of a releasing and stopping lever-motion operated upon by a ball set in any given position upon the rope. In the anchor of Messrs. Howard, of Bedford, the rope-pulley gives motion to a small barrel which very slowly winds along a rope fixed on the headland, and also carries the disc-anchor forward until the action is stopped by self-acting mechanism set according to the breadth Messrs. John Fowler and Co.'s machinery. of the work which is being done. Messrs. John Fowler and Co., of Leeds, construct their self-moving disc-anchor so as to wind

itself forward along a fixed headland rope, but in a direction opposite to that of the headland ply of the ploughing-rope—the arrangement giving special security to the position of the anchor.

Messrs. Fowler place their windlass, with its two self-coiling rope-drums, on vertical axes, enabling the ropes to be led off in any angular direction alongside the engine, and they drive by a spindle with universal joints. Messrs. Howard place their windlass—having drums on horizontal axes—at the rear of a portable engine, temporarily connecting the two in the simplest possible manner by a single belt, and the ropes are diverted in direction by guide-sheaves attached to the front of the engine. Messrs. Barford and Perkins place their windlass—also having drums on horizontal axes—in line with the engine, and drive it by an endless pitch-chain. In each case the result is that anchor-men are dispensed with, the engine-driver reverses the action of the windlass at the end of each journey of the implement; and thus only two men, namely, the engine-driver and the ploughman, are required to work the present “roundabout” apparatus, with the addition of a boy to shift rope-porters. The self-moving engine, with travelling anchor on the opposite headland is not so extensively used as the stationary-engine plan upon medium-sized and small farms; and for large farms, the double-engine system is being very widely adopted. The double-engine method is almost the only one employed in executing tillage-work for hire; many contractors owning their three, four, or up to more than a dozen sets of machinery. The power of the engines varies from the so-called “six-horse” up to fourteen-horse power, in reality being equal to the work of double or triple that number of horses.

Messrs.  
Howard's  
machinery.

The double-  
engine system.

Horses dis-  
placed.

On steam-cultivated farms the number of horses displaced is frequently one-third to two-fifths, while those retained are relieved of their most laborious work.

It may be remarked that early estimates of the probable cost of wear and tear and depreciation have been proved by long experience to be excessive; and that, with such powerfully and admirably constructed machinery as that of Messrs. Fowler, Messrs. Howard, and other makers, the total cost of tillage by steam-power, when under fair management, is probably not more than one-half to two-thirds that by horses.

Messrs.  
Howard's  
farms on  
boulder clay.

The Britannia farms of Messrs. James and Frederick Howard, of Bedford, afford a fine example of improvement by steam-husbandry on the boulder clay. Clearing of forest timber and underwood, abolition of old boundaries, throwing field to field and planting new fences, the formation of direct hard-metal roads in place of winding clay lanes or across newly opened

country, deep under-drainage, the laying down of new grass and the cleansing of old and foul tillage land, completely remodelled the estate. Ten miles' length of straggling hedge-rows were stubbed; their removal adding just ten acres to the area available for cultivation. Sound hard roads enable the steam-engine to traverse all parts of the farms in any weather; the fields are so laid out as to be most convenient alike for the single stationary engine or the double moving-engine systems of steam cultivation. The stationary engine can grapple with 10, 20, 30, and up to 55 acres at one "setting down;" and the drainage has been designed so that it replenishes a tank or open pond at every site occupied by the engine during the tillage of the whole estate; these tanks retaining supplies at all seasons, and letting only the overflow pass away by the mains which ultimately conduct it to the River Ouse. At the principal farmstead, a reservoir, cheaply excavated in the clay, holds half a million gallons of water. A considerable proportion of the estate now has a deep brown staple soil, 10 to 14 inches in thickness, lying upon a homogeneous clay. Yet before steam-culture was practised there were but a few inches of the soil above the raw tenacious "gaulty" clay which has now, to so great a depth, been changed by deep stirring and aeration into a dark unctuous earth. It is to be remarked that the gradual levelling of the old high-backed "lands" over a 4-foot deep drainage, has caused no difficulty in the downward filtration of the rain; but the whole of the fields drain well in the wettest of seasons.

The steam tackle is not employed merely as an auxiliary to the ordinary farm teams, to do little more than break up stubbles in autumn and perhaps cross-cultivate in spring; but steam-power executes all the heavy tillage, leaving only the lighter processes and the haulage of manure and of produce to be performed by horses. Thus, in preparing for a mangold crop, the wheat-stubble, instead of being "smashed up" after harvest and left for horse-implements to reduce and ridge in the spring, is at once ridged by a powerful double-breasted plough, the open trenches between the 27-inch wide ridges being simultaneously rooted up by a subsoil tine on the same implement. Frosts and other wintry influences moulder the exposed surface of these ridges into a fine tilth; and, in spring, farmyard-manure is applied, the ridges are torn down by the steam cultivator driven across, and the seed-bed is ready for artificial manure and the mangold seed to be put in by the drill.

Messrs. Howard, like many occupiers of clay land who use their form of machinery, cultivate, plough, ridge-plough, subsoil, drag, harrow, and also drill by the power of their "Farmer's Engine."

Mr. Ruck's  
practice on  
calcareous  
clay.

On Castle Hill Farm, near Cricklade, Wiltshire, Mr. Edmund Ruck manages a calcareous clay and strong loam on a five-course system; vetches, rye, and other sheep-feed, being followed by wheat, this by clover, the lea broken up for beans (manured), and then wheat again. The results of nearly twenty years' experience with Messrs. Fowler's steam plough (apart from the economy as compared with horse and ox-teams) are that the staple soil has been deepened from 5 down to 8 inches; the land drains better and dries more quickly after steam than after horse operations; artificial manures act more effectually, owing to the finer tilth produced; by autumn cultivation vetches and rye can be grown and fed off in spring, in time for a root crop to follow, enabling a much larger flock of sheep to be kept; the seeds are very much better, and clover can be repeated at shorter intervals; the harvest comes a week earlier, the samples of both wheat and barley are better and heavier, the yield of grain has been augmented at least eight bushels per acre; and, by the use of artificial manures with intercultural tillage or horse-hoeing between widely-drilled double rows of barley, Mr. Ruck has been able to grow fine barley crops in succession.

Improvement  
of poor clay  
pasture.

One of the most remarkable specimens of improvement of poor clay pasture-land is on Mr. Ruck's Manor Farm at Braydon in Wiltshire, lying in a low tract of poor clay, having pastures of weak watery grasses—of "hard-head, rest-harrow, and devil's-scabious," with tufts of rush and furze—and a water-table only a few inches below the surface. Mole-draining, by Fowler's steam draining-implement, 3 feet deep at every two yards' breadth, with cross-drains at intervals of four chains, and no pipes laid except at the outlets, was the fundamental operation; and this, followed by lime-composting, liberal artificial manuring, and heavy folding with cake- and corn-fed sheep on the grass, altered the nature of the herbage, and doubled the rental value of the land in four years.

Messrs.  
Fowler's  
knifing.

On some very strong clay soils, deeply drained, a great change of texture has been produced by a novel operation termed "knifing," that is, cutting gashes some 3 feet deep in parallel lines some yards apart, and thus opening and shaking the sub-soil and letting down water and air. The powerful implement employed is Messrs. Fowler & Co.'s knifer, fitted with an immensely strong blade or coulter, this being hauled at slow pace by wire-rope, pulley, and steam-engine stationed ahead.

Mr. Smith of  
Woolston's  
clay-land  
husbandry.

The first farm wholly under steam-culture was that of Mr. William Smith, of Woolston, near Bletchley, in Buckinghamshire, containing 112 acres arable, partly of gravelly clay, but principally a stiff, cold, calcareous clay. Mr. Smith has lately



enlarged his occupation ; but on the original farm he has now pursued his own peculiar system, with implements of his own invention, for twenty-five years. The old bare fallow is abolished ; the land is as clean as a garden ; and remarkably fine crops of roots, wheat, barley, beans, and clover are grown. Yet very little artificial manure is applied, while the farmyard-dung applied for mangolds is of a weak description ; the productiveness being maintained chiefly by mechanical treatment, which both unlocks and perpetually prepares the inexhaustible stores of mineral nutriment for plants existing in the soil, and at the same time continually introduces new stores of organic constituents from the atmosphere.

Mr. Smith does not find it necessary on that land to invert furrow-slices for the purpose of burying and so destroying the seedlings of weeds. On the contrary, he denounces the plough as a planter of root-weeds, and he uses it only for turning over and tightly-tucking the furrows of a clover-lea for wheat-sowing. For several years together his fields are deeply tilled by the tines of his steam cultivator, and by the ridge or double mould-board plough and subsoiler. A single process in autumn prepares a manured wheat-stubble for mangold-sowing in the following spring. The steam-trencher, that is, a ridge-plough with tines which break up the ground in advance, throws the land into drills or ridges, covering up the manure with them ; and the intervals are then bottomed by a subsoiler. Nothing more is required ; and in spring mangold-seed is drilled or dibbled on the powdery crests of the ridges. Bean-stubble is smashed up by the cultivator, and harrowed and drilled with wheat ; and a combined cultivator and drill cross-cultivates and drills beans, or breaks up and drills barley on the land after the root crop. There is an extraordinary economy in this steam tillage as compared with horse-work ; and the increase in produce is so great, that the wonder is why a larger number of farmers have not literally copied the Woolston management. The gain in root-crops and clover is very considerable ; the increase in yield of corn is valued at fully 8 bushels per acre ; and the value of the fee-simple of the land has been raised probably 20l. per acre, from the depth and porosity given to the staple, and the proofs of acquired or developed fertility manifested in the regularity with which the land continues to give heavy and high-quality crops.

Among the greatest labour-saving inventions lately introduced, or so improved as to be widely adopted, are the double-furrow and three-furrow ploughs, dispensing with one out of four

Non-inversion  
of the soil.

Autumn-  
ridging for  
mangolds.

Labour-  
saving imple-  
ments of late  
introduction.

horses, and with one ploughman out of two in turning over the same extent of land.

Mowing-machines now cut a major portion of the clover and meadow hay on all but the area under small occupations; and it may be estimated that fully three-fourths of the white corn in England is reaped by machines, pre-eminent among which are the reapers of Messrs. R. Hornsby and Sons, of Grantham, Messrs. Samuelson and Co., of Banbury, Messrs. Burgess and Key, of Brentwood, Messrs. Howard, of Bedford, and Mr. Walter A. Wood.

Harvest work is now greatly facilitated by stacking-machines, and hay and sheaf-elevators working by horse-power; while sheaf-binders and loading-machines are all but sufficiently perfected to prove a boon to all farmers in that most laborious season.

VI.

DAIRY FARMING.

BY

JOHN CHALMERS MORTON.

---

WITH

A CHAPTER ON

PASTORAL HUSBANDRY.

BY

W. T. CARRINGTON.

УЧЕБНИК

ПО МАТЕМАТИКЕ

ДЛЯ ДЕТЕЙ

СРЕДНЕГО ВОЗРАСТА

## CONTENTS.

---

### CHAPTER I.—*Dairy Cows and their Management.*

General Statistics—The Live-Stock of the Country—Dairy and Grazing Breeds of Cattle—Management of Land and Live-Stock—The Shorthorn Breed—A Staffordshire Dairy Farm—A Cheshire Dairy Farm—Cattle Feeding for the Dairy—The Longhorn Breed—The Hereford Breed—A Hereford Farm—The Ayrshire Breed—The Devon Breed—The Sussex Breed—The Norfolk Polled Breed—The Guernsey and Jersey Breeds—The Kerry Breed .. .. . Pages 381–400

### CHAPTER II.—*The Rearing of Calves.*

Calf-Rearing—Calf-Rearing on Whole Milk—Calf-Rearing on Skim-Milk .. .. . Pages 401–403

### CHAPTER III.—*The Sale of Milk.*

Sale of Milk—County Supply of Milk—On Feeding Cows for Milk—Suburban Milk Dairies .. .. . Pages 404–407

### CHAPTER IV.—*The Manufacture of Cheese.*

The Cheese Manufacture—Cheddar Cheese—Mr. Harding's Practice—Cheshire Cheese—Gloucester Cheese—Derbyshire Cheese—Lancashire Cheese—Dairy Factories—Factory Management—Factory Statistics—Stilton Cheese—Bath Cheese—Cream Cheese—Size and Forms of Cheeses .. .. . Pages 407–423

### CHAPTER V.—*The Manufacture of Butter.*

The Butter Manufacture—A Buckinghamshire Dairy Farm—A Dorsetshire Dairy Farm—Devonshire Butter—Irish Dairy Husbandry—Dairy Implements .. .. . Pages 423–435

---

### CHAPTER ON PASTORAL HUSBANDRY.

Variations in Climate and Soil of England—The Shorthorn Breed of Cattle—Management of a Pedigree Herd—Rearing of Cattle for Sale as Beef—

Summer and Winter Feeding—Other Systems of Rearing Calves—Diseases of Calves—Grazing of Upland Pastures—Method of Keeping Young Cattle without Housing in Winter—Summer Grazing of Cattle—Advantages of using Cake—Profit of Grazing—Import of Irish Store Cattle—Bullock Feeding—The Hereford Breed of Cattle—Management of a Hereford Breeding Herd—Devon Breed of Cattle—Influence of Climate upon Sheep—The Production of Wool and Mutton—The Lincoln Breed of Sheep—The Cotswolds—The Leicesters—The Down Sheep—The Shropshires—Management of Sheep on a Light-land Arable Farm—The Lambing Season—Weaning and Dipping—Advantages of the Folding System—Consumption of Roots by Sheep—General Management of the Flocks—Sheep on Strong-land Arable Farms—On Low-lying Grass—On Hill Farms—Liability to Foot-rot—Sheep on Cold Uplands—Great Increase in the Use of Imported Foods for Stock, and in the Demand for Fresh Meat .. Pages 435-452



# DAIRY FARMING.

## CHAPTER I.

### DAIRY COWS AND THEIR MANAGEMENT.

THE milk-produce of Great Britain, which is the subject of this General Paper, amounts to about 1,000,000,000 gallons annually. We have about 2,250,000 "cows and heifers in-milk or in-calf" in the month of June each year, and we may suppose that they yield rather more than 440 gallons apiece within twelve months. Of this quantity, considering the large number of cows which do little more than rear their calf—which runs with its dam throughout the summer—probably one-sixth is taken by the calf. From the remainder, putting the average daily consumption of man, woman, and child, at fully one-quarter of a pint apiece, we must deduct 1,000,000 gallons a day for direct consumption. These two deductions (167,000,000 and 365,000,000 gallons respectively) leave 468,000,000 of gallons, not one-half of the milk-produce of the country, for the manufacture of cheese and butter in the dairy. And probably two-thirds of this quantity yield cheese, one-third butter. Now, 312,000,000 gallons of milk will produce close on 2,800,000 cwt. of cheese,\* and 156,000,000 gallons of milk will produce 530,000 cwt. of butter.† To these numbers add 1,651,088 cwt. and 1,637,937 cwt. respectively, the quantities of cheese and butter imported last year; and the consumption of the country will thus be found to amount to close on 4,500,000 cwt. of cheese, and 2,250,000 cwt. of butter (English made and foreign ‡) annually. These quantities, then, represent the amount of the demand by which our dairy industry has been created and is maintained. General statistics.

\* Rather less than 1 lb. of cheese per gallon of milk.

† One lb. of butter for every 21 pints of milk.

‡ There is in addition to this supply a large consumption of Irish butter, to which some reference will be made in the sequel.

The live-stock  
of the country.

Before describing our methods connected with calf-rearing, milk-selling, and cheese- and butter-making—the four principal divisions of dairy practice—it may be well to direct attention to the several breeds of cattle from which our milk supply is derived. Within the 2,250,000 of “cows and heifers in-milk or in-calf,” which our annual agricultural returns report in June each year as the tale of dairy-cattle in Great Britain, there are included more than a dozen distinct breeds. And there is nothing which more strikingly illustrates the moulding agricultural influence of varying circumstances—based partly on differences of latitude, but still more on those differences of soil and elevation which are due to our remarkably various geology—than the fact that, within the limits of our little island, and more or less confined to separate localities within it, there are found such long-established and enormous differences as exist between the massive meat-carrying Shorthorns, Herefords, and Polled Angus breeds of cattle—the almost equally large but less massive Longhorns, Black Welsh, Red Sussex, and Red or Black Glamorganshire cattle—the smaller North Devons and West Highlanders—the Norfolk and Galloway breeds of Polled cattle—and the still smaller Ayrshire breed. To these, indeed, may be added, as outlying examples, the two Channel Island breeds, the diminutive piebald Shetlander (not unlike the Breton), the little red or black Kerry, and some others of still more local character—as the Gloucestershire, a dark-red, sometimes brindled cow, with black points, and the Polled Somerset. The surprising permanence of these different types and styles of dairy-stock, crowded as they are within such narrow limits, is, no doubt, largely due to the isolation and seclusion in which our agriculturists have been content to dwell. And the counter-influence of freer and more constant intercourse, consequent on our extended and completed railroad system, on the continually widening field whence the meat and milk for many of our dense centres of population are supplied, and on the frequency and popularity of our agricultural exhibitions, will, no doubt, more and more be felt. It is already seen in the gradually extending supremacy of the Shorthorn over all other sorts of cattle—the larger kinds especially—which are, with some exceptions, losing their distinctive character over whole counties through repeated Shorthorn crosses.

Dairy and  
grazing breeds  
of cattle.

Of those which have been named, the Shorthorns and the Longhorns among the larger breeds, and the Norfolk, the Ayrshire, and the two Channel Island breeds among the smaller—are distinctly and especially dairy cattle. The Herefords, on the other hand, the Sussex and the Devons, the Polled Angus, the Galloway, the black cattle of Wales and the rough

cattle of the Highlands, are especially meat-producing breeds. But, it is the great merit of the Shorthorn that it holds the very foremost place in both of these classes. The exceptional aptitude of the Shorthorn cow to lay on flesh whenever, whether by accident or age, she has become no longer adapted for the dairy, is a very great addition in the eyes of the dairy farmer to her merit as a mere milk producer. And the unusual power of the Shorthorn bull to confer this character upon his offspring of other breeds is rapidly giving a Shorthorn character to the dairy cattle of those counties where Welsh, Glamorganshire, Longhorn, and other less important local breeds, now almost lost in their purity, once prevailed. It has thus come to pass that while the number of so-called pure-bred, or Herdbook Shorthorn cows in the country is still perhaps smaller than the number which would be pronounced pure of some other breeds,—the Ayrshire, for example—yet the great bulk of the cattle in our English dairy districts are year by year exhibiting a constantly increasing Shorthorn character.

There were in ten of the western counties of Scotland, in June 1877, 185,000 “cows or heifers in-calf or in-milk,” and perhaps 120,000 of these, taking into account also the number of Ayrshire herds in other parts of the island, may fairly be taken to represent the whole number of the Ayrshire breed of dairy cattle. In Hereford and Shropshire there were together 77,548, and perhaps 60,000 may be the total number of cows in the whole country of this large meat-carrying kind. It is not so easy to judge of the number of the less noteworthy local sorts, or of breeds like that of Galloway or Norfolk, which can only be held to occupy parts of counties; but of the Polled Angus there may not be more than 25,000 cows; of Sussex cattle not more than 6000 or 7000; of Devons, large and small—for there are two styles, the former of which may rather be designated Dorsets—there are probably as many as 60,000. No doubt the number of cows of the Shorthorn breed, as pure bred as many of those already named, is largely in excess of any number I have quoted, for all the northern and midland counties of England are full of them; but, judging from the entries in recent volumes of the Shorthorn Herdbook, and from the numbers disposed of at the annual sales of Shorthorn auctioneers, I am advised that the entire number of females of this breed which could claim registry in the Herdbook is probably not more than 20,000. In addition to these there are the Highland cattle and the Channel Islanders, the Welsh and Longhorn breeds, and some other sorts of less importance; but, including them all, I do not think that the number of pure-bred “cows and heifers in-milk or in-calf” each June, of the breeds that I have named, can

much exceed half-a-million. In addition to these there are more than three times as many large-framed dairy cows in this country, all of which have received more or less strongly the impress of the Shorthorn cross. The dairy districts of Lancashire, Derbyshire, Staffordshire, and Warwickshire, where Longhorns once prevailed, have thus all more or less a Shorthorn character: the dairy districts of Cheshire, where Welsh and Irish cattle once prevailed, are now almost wholly Shorthorn; and the same may be said of the dairy counties of Gloucestershire, Leicestershire, Somersetshire, Wiltshire, Berkshire, Bucks, &c., where cattle of local breeds formerly were prevalent. On the other hand, in the grazing districts of Yorkshire, Leicestershire, Northamptonshire, Lincolnshire and Buckinghamshire, &c., excepting imported Hereford, Welsh, and Irish cattle (which, however, are now also mostly Shorthorns) one will hardly see any other.

In drawing up a report of the dairy husbandry of this country, which includes the maintenance of all these cattle, as well as the various uses to which their milk is devoted, I propose first to describe the breeds and the farm management of our principal dairy districts, and then to describe the four principal dairy industries, viz.: (1) Calf-rearing; (2) Milk-selling; (3) the Cheese Manufacture, and (4) Butter Dairying.

Management  
of land and  
live-stock.

The proprietors of the 'Agricultural Gazette' have lent me a number of illustrations of the several breeds which I have named, and, in referring to them, I shall at the same time be able to describe the general management of the several dairy districts from which the portraits have been obtained.

I propose in the first place to describe the ordinary dairy Shorthorn and the farm management which obtains in the districts where this is the common dairy cow.

The Shorthorn  
breed.

The portrait (Fig. 1) represents one of three cows which received the first prize as the best dairy cattle in the first Show of the British Dairy Farmers' Association at Islington in 1876. It may be taken as fairly representative of the best class of the ordinary dairy cattle now to be found in most English dairy districts—large-framed cattle of a distinct Shorthorn character, capable of carrying a great weight of good beef with comparatively little offal, as soon as they have finished at the dairy. I saw these three cows milked one morning in May 1877, when their calves were about 12 weeks old. They gave 10, 10, 11 quarts apiece at that milking, and had given nearly as much the evening before. The three cows, with their aggregate of 15 gallons of milk daily, were at that time making at least seven stone of cheese a week, worth more than 3*l.* They were thus yielding



20s. worth of cheese apiece weekly, besides a contribution to the food of the pigsties. The management of Mr. Carrington's farm, where cheese and, to some extent, butter are made in summer, milk being sold in winter, is described by himself in

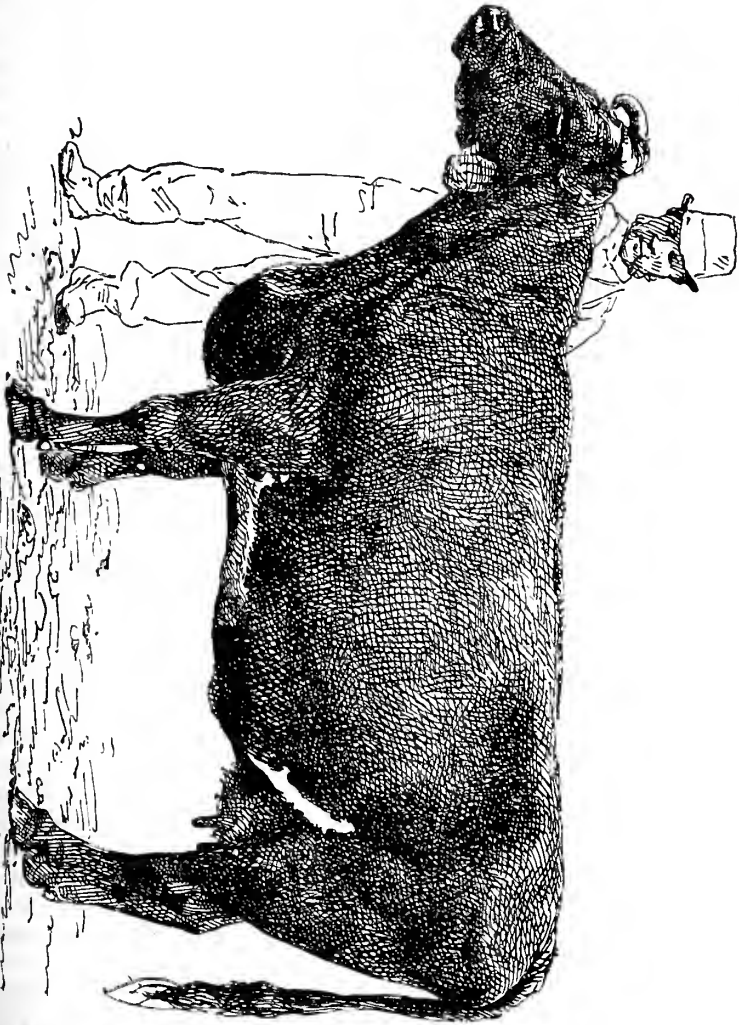

Fig. 1.—Mr. W. T. Carrington's Prize Shorthorn Cow.

the following sentences, taken from the 'Agricultural Gazette' of 1877 :—"Until the last six or eight years," he says, "almost the whole of the milk from my cows (upwards of 100) had been made into cheese, and fine cheese commanding

as high a price as any in the district has been almost always produced. At the smallest of the homesteads, in a village, new milk is now sold throughout the year, and a considerable quantity of milk-butter is made, and the skim-milk is used in rearing heifer calves and feeding pigs. At the other two larger homesteads, though a large quantity of cheese is still made in the summer months, the practice is supplemented by the sale of milk to London, and the making of a large quantity of milk-butter, in the winter months, when both milk and butter are scarce and dear."

A Staffordshire  
dairy farm.

Here, then, we have the whole four departments of dairy management under one tenancy. The adaptation of the farm-cropping in this case may be taken as a sample of the best style of English dairy management; and a short account of these farms may therefore fairly claim a place in a Report on English Dairy Husbandry.

*The Croxden Abbey Farms.*—There are three farms, Croxden, Hollington, and Nothill, near Uttoxeter, forming together an unbroken holding, along with 60 acres of grass-land at some distance, in Mr. Carrington's hands; and altogether they include 640 acres, of which some 80 are now arable, nearly 100 acres of the land most unsuited for tillage having been permanently seeded. The soil is generally a strong loam. The lower fields, receiving water from gravel-beds higher up the valley, are used for irrigation; and about 50 acres of early grass, obtained in this way, form a useful addition to the early spring keep of the farm. The liquid manure is flushed at intervals into the stream, and turned on to one and another of the fields next the several homesteads.

Of the 80 acres of arable land there are in general 2 in potatoes, 10 in mangold-wurzel, 10 in cabbages, 6 in turnips, 8 in clover, 20 in wheat, 20 in oats, and 4 in barley. The cabbage crop (Drumheads) is sown in August, and the plants are before winter transplanted into a plot, 2 or 3 inches apart, in rows a foot apart; and a capital bed of strong, stocky plants is thus ready in May for transplantation, the land being all manured and ploughed and prepared for the plants, which are put in about 3 feet apart all over the ground. These cabbages are used on the pastures for the cows and young stock during the autumn months.

The manure of the farm goes on the mangold and cabbage land, as well as to some extent on the meadows and young grass. Mr. Carrington depends wholly on his dressing of superphosphate and nitrate of soda for his swede crop. The former is applied at the time of sowing, at the rate of 6 cwt. per acre, the latter, 1 cwt. to 2 cwt. per acre, when the turnips are hoed out.



During autumn the cows at grass receive some cabbages and 3 lbs. of decorticated cottonseed-cake daily, and this keeps them in full milk to the end of their time, or within two months of their calving again. The use of decorticated cotton-cake is one of the chief features of the farm management here; and it results not only in the profitable maintenance of both the milking and the fattening process, but in the gradual improvement of the pasture. I saw it given to ewes, young stock, and cattle both in the house and in the field. The cattle at grass have it put down to them in small heaps, in the same way as they are foddered with hay, in a new place every day on the bare ground, from which they pick it up as clean as if it had never been put down. Cows are brought to pail at 2 to  $2\frac{1}{4}$  years old, when they are already well-grown heifers, and with some extra keep they make ultimately as big cows, with less immediate liability to barrenness when brought in thus young than if kept a year longer. The heifer calves, first fed on new milk, are weaned on whey and meal, or, when butter commands a good price, on skim-milk and meal; they are taught to eat linseed-cake and are turned out to grass in June, and left out altogether until brought in to calve two years afterwards. They thus remain out, with an open field-shed for shelter, for a couple of winters, receiving daily at first from  $\frac{1}{2}$  lb. to 1 lb. of linseed-cake, and afterwards more of it with the cotton-cake; getting perhaps 1 lb. of each, along with cabbage or grass, during the first autumn or winter, and 2 lbs. or 3 lbs. of decorticated cotton-cake, with a little hay, during the second winter.

Mr. Carrington feeds a considerable number of cows during winter for the production of milk for sale, some being bought in autumn and fed liberally through the winter, and afterwards dried off and grazed on some of the better pastures, cake being given at the same time. From 80 to 90 Shropshire ewes are kept, and their produce (except part of the ewe lambs kept for the flock) are sold fat at from 13 to 15 months old. The ewes are wintered on the old pastures receiving a few roots, and  $\frac{1}{2}$  lb. of decorticated cotton-cake per head when near lambing.

The pastures as well as the meadows feel the benefit of the constant extra feeding of both sheep and cattle, which improves the grass, benefits the sheep and cattle, and permanently improves the condition of the land.

The land has been drained where necessary 4 feet deep, with pipes. More than 100 acres have thus been regularly drained at the sole cost of the tenant. Unnecessary fences are removed, portions being left for shelter in the midst of the larger fields thus thrown together; and wet places are drained when necessary by occasional drains.

A great deal of grass-land improvement is annually done by sowing 1 or  $1\frac{1}{4}$  cwt. of nitrate of soda, with 2 to 3 cwt. of mineral superphosphate per acre in early spring, and thereafter feeding off the flush of growth which is produced by sheep and cattle, receiving cotton-cake. Some 9 tons of nitrate of soda and 10 to 12 tons of superphosphate are used annually, chiefly in this way, and partly on the arable lands.

On the labour question it may suffice to say that Mr. Carrington keeps several men and boys in his house, who receive 8*l.* to 20*l.* or 25*l.* yearly, with their board and lodging. A cowman, who feeds and cleans 70 cattle in houses all winter, receives 12*s.* a week and his keep all the year round, with cottage-rent and potato-ground, and coals hauled.

There are 50 acres of water-meadow for early spring green food, 10 acres of mangold-wurzel, 10 acres of cabbage, 6 of turnips, and 8 of clover, with about 45 acres in straw crops, one-sixth of the whole land being arable, and five-sixths permanent pasture: and this, with a large purchase of cake and India corn for auxiliary food, and of nitrate of soda and superphosphate of lime for auxiliary manuring, suffices for the maintenance of over 100 dairy cattle of the large stamp here illustrated, the fattening of a considerable number of dry cows, the rearing of a large number of calves and yearlings, the feeding of a large number of pigs, and the maintenance of a small flock of sheep.

If farm examples were selected from other counties, as Gloucestershire and Cheshire, it is probable that a much smaller proportion in the former, a much larger in the latter, would be arable. In an ordinary Gloucestershire dairy-farm the dairy-cattle, about one cow to every three acres, receive nothing but pasturage in summer, and very little but straw, with a few turnips and a little hay, in winter; being thus foddered either in yards provided with shelter-sheds or in the nearest pasture-fields. In Cheshire the cows are brought in to shippens, and tied up in stalls, receiving straw and turnips with a little hay, and are let out daily to watering. The following abridged account of the Cheshire Dairy farm, which received the Prize of the Royal Agricultural Society at their last meeting (Liverpool, 1877), is extracted from the Society's 'Journal;' and may be taken as another example of the best English dairy-farm management.

*Stapleford Hall, near Tarvin*, in the occupation of *Mr. John Lea*, is 250 acres in extent, of which about one-half is arable, only 70 acres, or thereabouts, however, being annually under the plough, the remainder being either permanent grass or grass laid down by the tenant, and from two to ten years old. It lies on the marl of the New Red Sandstone formation, or on the gravel



beds by which that formation is in many places covered, and the soil is heavy and cool, or light and occasionally "burning," accordingly. Mr. Lea takes an oat crop after his grass, which is ploughed up at from two to ten years old, according to its condition. This is followed by a fallow crop, as mangolds, swedes, turnips, or beans; and this by wheat and oats, in which clover and grass seeds are sown. The farm-manure, with a dressing of artificial manure, is applied to the green and fallow crops. An occasional dressing of bone-dust, 10 cwt. per acre, is put on the clover. The clovers and grass-seeds very soon form an admirable pasture, hardly distinguishable from good old grass, and they remain down as long as the tenant thinks proper. Of the whole 250 acres, about 120 acres are in permanent grass, much of this being low-lying meadow-land, which Mr. Lea has drained, and which he mows every year. The premises, of which a plan and index are given (Fig. 2, p. 13), provide ample accommodation for the stock of all kinds, and for their winter fodder.

The live-stock of the farm—confined to cows,\* young stock and pigs—include 70 to 80 dairy cows, of a useful Shorthorn type. Twenty young heifer-calves are reared each year, and as many drafts of the poorest milkers and the older cows are sold off each year. The heifers are put to the bull at 16 months old, and are brought into the herd early in their third year. They are a useful lot of common Shorthorns, and are improving in Mr. Lea's hands. For his latest purchased bull, bred by Mr. George Phillips of Shropshire, he gave 52 guineas at the Bingley Hall Sale, Birmingham. It had taken the first prize in its class there. The produce of the cows is about 4 cwt. of cheese annually, besides about 20 lbs. of butter apiece; a considerable quantity of the milk also being sold from them in December and January. Both the latest and the earliest milkings thus go into Liverpool, at prices varying from 10*d.* to 11*d.* a gallon on the farm. All the earliest bull-calves are fed, and there are generally 20 to 30 fat calves sold early every spring, at prices varying from 3*l.* to 5*l.* apiece. Besides these, upwards of 400*l.* is received annually from the sale of draft-cows; and

---

\* When sheep are kept with cows upon a dairy farm the quantity and even the quality of the cheese are sure to suffer. The latter may indeed be preserved by good management, but the former is inevitably injured. Depasturage by sheep is certain so to reduce the quantity of the finer clovers and grasses in the midst of the pasture, that the cow's nourishment and, by consequence, her productiveness also are injuriously affected. On the Prize Farm at Stapleford Hall, where no sheep are kept, the cheese usually made amounts to 4 cwt. annually per cow. At Waterside farm in Lancaster, another prize dairy farm, on land equally good, there is a large flock of sheep maintained with the dairy stock, and the cheese from cows of even superior quality is less by at least  $\frac{1}{2}$  cwt. each annually.

there are 50 fat hogs of a good middle-sized white breed, which average 7*l.* apiece, half being bred on the farm (2 sows are kept), and half bought as young stores, at about 1*l.* apiece. The other receipts from the farm come from 20 to 25 acres of wheat, 30 to 40 acres of oats, and 6 acres of potatoes; also from the sale of 30 tons, or more, of hay and straw every year, and from the poultry-yard and garden, both of which are most profitably productive.

These two examples may suffice as illustrative of the best style of ordinary English farm management when cheese is the product of the dairy. The treatment of the cattle on such farms is thus described by Mr. Carrington:—

“The cows are wintered on straw or hay and roots; those which have not calved are turned out for a few hours in a sheltered sound field of turf, near the homestead, every day, except when the weather is very bad. I consider the fresh air and exercise beneficial. To those of my cows which are in high condition, I give 1 lb. of Epsom salts and 1 oz. of ginger just before calving, and in some cases I give this dose twice before calving. This I consider a safeguard against milk-fever. Cattle feeding  
for the dairy.

“A few days after calving I commence to give the cows from 4 lb. to 6 lb. of cake or meal, with plenty of mangolds and hay, or cut straw. A cow in full milk, kept on hay and roots alone, rapidly loses flesh, and her milk will neither be so abundant nor so rich in butter or curd as when extra stimulating food is supplied. Decorticated cotton-cake is a valuable food for milch-cows, either alone or in conjunction with maize meal, which is very largely used for all kinds of stock in Lancashire and Cheshire, within easy reach of the Liverpool market. Palm-nut meal (a food very rich in oil) is a valuable food where it can be mixed with chop and pulped roots; it is not, however, palatable to stock unless mixed with other food.

“It was formerly my practice to make cheese from the middle of February to Christmas. I now find it more profitable to make cheese only from about Lady Day to October, and to dispose of the milk in the winter, either by sale to London or by making milk-butter. Cheese made in the winter months is always inferior to grass cheese; and in winter both milk and milk-butter are dearer than in summer.

“Dairy cows should have as early a bite of grass as can be saved for them; and a good water-meadow, therefore, is a valuable adjunct to a dairy farm. But it is better to turn milch-cows out for an hour or two every fine sunny day in April, even if there is no grass for them. They should not generally lie out of doors at night until the first or second week in May.

“An abundant supply of grass should be provided for the cows



in the summer, and, if the supply falls short, they should be fed with green fodder, cake, or meal. No animal better repays liberal treatment than a good dairy cow. It is my practice to grow a large amount of green crop for the cows in autumn and winter. I generally commence with rape and vetches sown together on a small extent of land, and on the headlands of the other root-crops. Ox cabbage is generally given to the cows—spread on the pastures—from Michaelmas to Christmas; and at that period of the year there is no green food to equal it. For winter consumption in the stalls, white turnips, swedes, and mangolds are given, reserving the latter until the last. By a liberal supply of cabbage, and 3 lb. per day of decorticated cotton-cake to each milking cow, I have generally an abundant supply of milk in the autumn months, and the dairy cows are kept in blooming condition. They are generally dry about two months. The heifers are brought into the dairy at from 2 years to 2½ years old. I get them big enough at that age, and they are more likely to breed and milk than if they were left a year longer without a calf. Nearly all my young stock lie out of doors the first two winters, until they are about producing the first calf. My land is generally fairly well sheltered, and I find that young stock with 2 lb. to 3 lb. of cake per day, and a little hay given them on the pastures, thrive well in the winter.

“I have heifers calving down now at 2 years old, which have never lain up since they were small calves, and they are worth more than 20 guineas each. Cattle will not, however, do well in exposed or damp situations where there is no shelter. It is very undesirable by keeping young stock too warm to make them tender and delicate.”

The above will suffice for a general account of the ordinary dairy Shorthorn, and of the farm management commonly adopted where this breed prevails.

*The Longhorn breed*, represented by Fig. 3, page 393, is essentially a dairy breed. The portrait represents the cow belonging to Mr. W. G. Farmer, of Hinckley, Leicestershire, which took the first prize in her class at the Liverpool Show of the Royal Agricultural Society last year. Rather more leggy, and fully as long bodied, perhaps hardly so high, as the Shorthorn—of dark red colour, with black points and white lines along back and bosom, and with long horns—the breed is perfectly well represented by this portrait, taken from a photograph.

The cow does not generally give so much milk as an ordinary Shorthorn cow; but in such experiments as are recorded the milk has proved richer, with a larger percentage of curd rather than of cream, in the case of cows which have been compared at the same age and season of the year. The breed stood at

The Longhorn  
breed.



one time higher in public reputation than it has latterly maintained. Bakewell of Dishley had selected it as the sort on which to try with cattle the same principles of breeding as had proved fruitful of such wonderful results with the Leicester

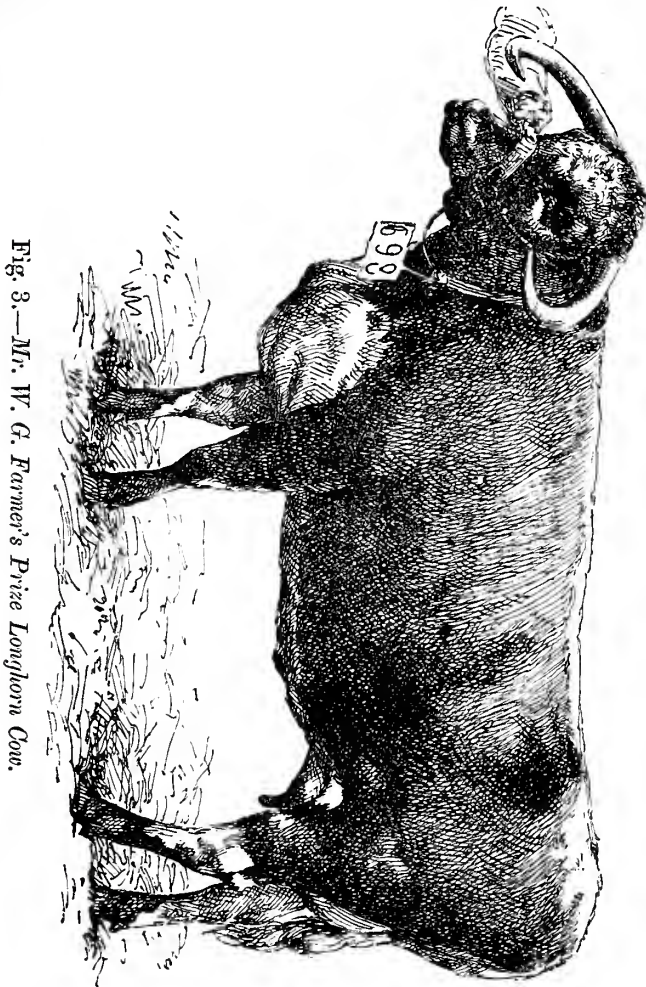

sheep. And he made it at length earlier of maturity, with a greater aptitude to fatten and more readiness to put on beef over rib and sirloin, where the carcass is most valuable. In proportion, however, as it improved in these respects, it became less valuable as a dairy breed. Its merits have always been

maintained by a number of breeders in the midland counties ; and an attempt is now being organised to bring it more prominently into notice at our annual Shows.\*

The farm management where Longhorns are retained as stock in dairy occupations, does not differ from that of Cheshire,

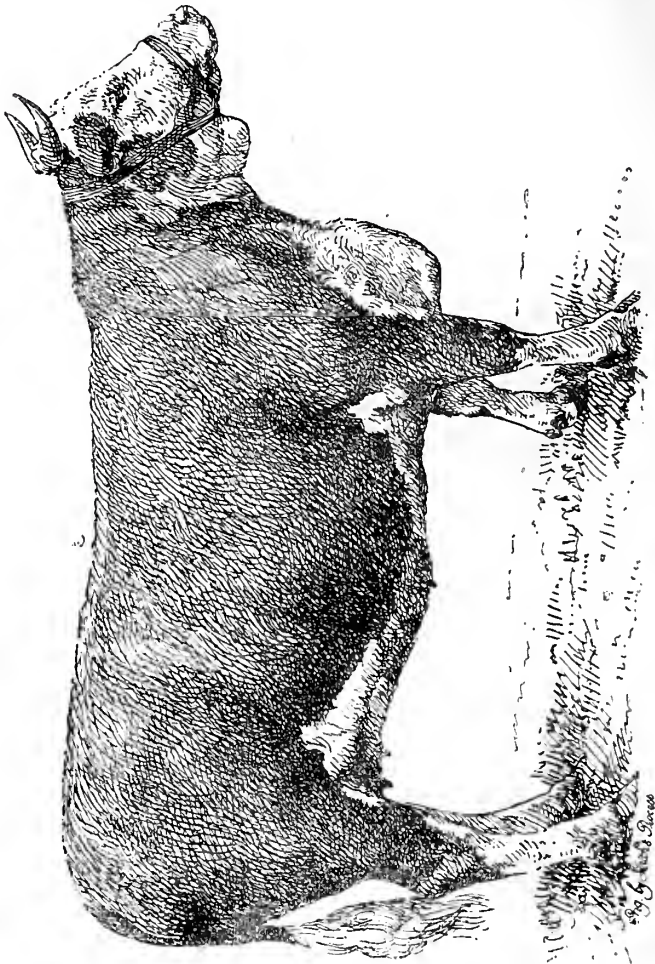

Fig. 4.—Mr. Carcardine's Hereford Heifer, "Helena."

Gloucestershire, or Staffordshire, which has been already described.

\* See J. Nevill Fitt, on "Longhorn Cattle," 'Journal of the Royal Agricultural Society,' vol. xii., New Series.

The *Hereford breed* is not noteworthy for its dairy merits, although herds almost wholly Hereford are in some cases, especially in Dorsetshire, maintained on some dairy farms. The portrait (Fig. 4) is that of "Helena," a Hereford heifer, bred by Mr. T. J. Carwardine of Leominster, which has taken several prizes at our leading cattle shows, and may be taken as a fair representative of the breed. The engraving is copied from a photograph, and one gathers from it a perfectly accurate impression of the breed, so far as it goes. The red colour, of course, cannot be given, but the white face is characteristic; and all the rest, it will be understood, is of a red colour. The Hereford breed.

The Hereford, though in general hardly so large as the ordinary Shorthorn, attains as great a weight at an early age, when fed for beef. It is pre-eminently a beef-producing and beef-carrying breed. The live weights of the fat Shorthorn and Hereford cattle at the annual Smithfield exhibition are almost identical at corresponding ages. Although, however, this breed is rarely cultivated for its dairy qualities, yet there is sufficient testimony to the fact that when bred especially for dairy purposes it satisfies its breeder. Thus, in a lecture before the Brecon Chamber of Agriculture, Mr. Duckham, well known as editor of the 'Hereford Herdbook,' says of the milking properties of the Herefords:—"The Hereford herd of Mr. James, of Mappowder, Blandford, Dorset, has been established thirty years. He tells me that Hereford dairies are becoming very general in that county, and adds, 'In proof that they are good for milk with us, I let 100 cows to dairy people, and if I buy one of any other breed to fill up a deficiency, the dairymen always grumble, and would rather have one of my own bred heifers.' Mr. Olver, Penhallow, Cornwall, says, 'Hereford cows are generally said to be bad milkers. That is contrary to my experience, and I feel persuaded that when such is the case it does not arise from any constitutional defect, but rather from mismanagement in rearing, or a deficiency of the constituents essential to the production of milk in their food.' He adds, 'My cow, "Patience," bred by Mr. J. G. Cooke, Moreton House, Hereford, has yielded 14 lbs. of butter per week; and "Blossom," bred by Mr. Longmore, Buckton, Salop, gave 22 quarts of milk, yielding 2½ lbs. of butter per day.'"

In Herefordshire the cows are wintered on turnips and straw, with a little hay in yards or on dry fields. They calve from February to May, and the calf runs with its dam all through the summer. It is wintered on hay and roots with a little cake in yards, grazed the following summer, and either wintered again and sold in the autumn of the third year, or sold at the Hereford autumn fairs at some twenty months old, for prices which A Hereford farm.

reach 16*l.* to 20*l.*, for two-year-olds. The cows rarely yield anything after the first four weeks beyond suckling their calves on the pastures.

A Herefordshire farm of 200 acres may have 150 acres of permanent grass, of which from 10 to 20 will be orchard. It will be stocked with, perhaps, 12 to 14 cows, of which, taking the account in spring, 2 or 3 old cows have been fattened, and are ready for the butcher. There are 12 or 14 calves running with their dams, and as many yearlings, of which 10 or 11 may be for sale in the autumn, or they may be kept over another year and then sold—large fresh well-made young beasts, worth sometimes nearly 20*l.* apiece—and 2 or 3 are yearling heifers, to be put to the bull next summer, to take the place in the herd of the oldest cows in the following year. Of the arable land, one-fifth may be in turnips and mangolds for winter food for the cattle. These roots with the straw of the corn crops, and the hay from a certain extent, perhaps 60 acres, of old grass will keep the cattle, young and old, together with the small flock of sheep which are also kept on the farm, until it is time to turn them out to grass again next May.

The Ayrshire  
breed.

The *Ayrshire* is the characteristic dairy breed of Scotland, and one of the most numerous pure breeds in the island. It is fairly represented by the engraving (Fig. 5), which is a portrait of "Jeanie," a 5-year-old Ayrshire cow, which took the first prize in her class at Liverpool, 1877, and was exhibited by Mr. A. Cassell, of Gayton, Keston, Cheshire. Of this breed I will only say that the dairy produce of Scotland is almost wholly derived from it; that the area on which it is cultivated is almost wholly arable land, its grasses being sown for not more than three years' duration; and that it is very largely the practice in these districts for the farmer to let his cow stock to a dairyman, called a "Bower," on whom the whole work rests of attendance on the cow, and of the dairy work connected with her—a certain area of (clover and ryegrass) grass-land, a certain allowance of hay and straw, and a certain weight of turnips, being allotted for each cow. A fair average price for cows thus let in Ayrshire is 13*l.* a year. The usual allowance is 5 tons of turnips, 280 lbs. of bean-meal, straw fodder and litter *ad lib.*, and a little hay for a month before being turned out to grass; and about 1½ acre of grass is the usual allowance for grazing. The farmer is at no expense, except in providing a horse for the "bower," who generally carts his own turnips from the field. A fair estimate of yearly yield from these small cows is 390 lbs. of cheese, besides a little butter. To this is added, of course, a certain quantity of pork derived from the consumption of whey.



The Ayrshire is a "model" breed in both senses of the word—for it gives you the ideal form of a cow, and it is the cow rather too much in miniature to be satisfactory to an outsider. It is hardly so large as the Devon. Seen in profile, the body lies between two straight lines, the upper one horizontal, the lower sloping downwards, from the bosom towards the udder, which does not fall below it. It is curious to watch judges scanning a lot of Ayrshire cows as compared with judges looking at Shorthorn stock. The former look down a great deal more than they look up. It is the belly line and the form and character of the udder which, after all, are the main points which determine the award. The Ayrshire cow stands on short legs, and is long in proportion to its height, *i.e.*, on a comparison

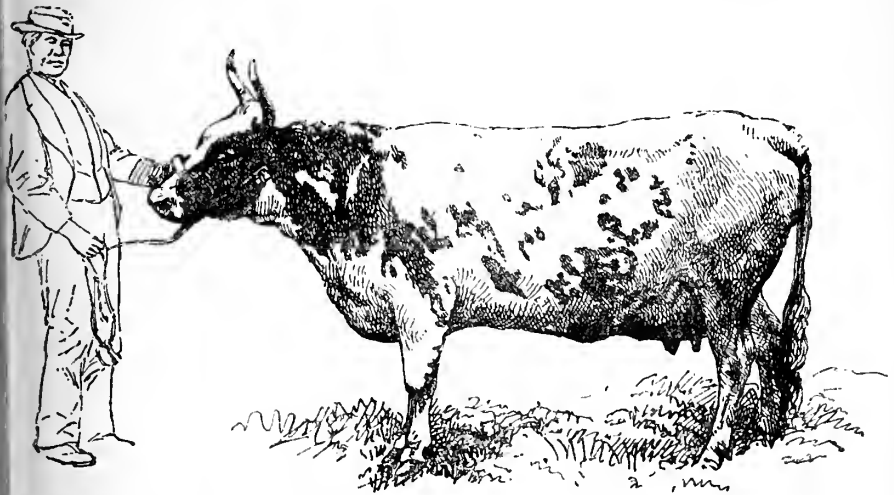

Fig. 5.—Mr. Cassell's Ayrshire Cow, "Jeanie."

with other breeds. A somewhat slender neck carries a head of beautifully feminine character, with horns of middle length, which face you, *i.e.*, stand upwards. The colours are white, with little brown or red—or light or dark brown and red, with little white—or brown or red or even black with white, about half and half. The nose is flesh-coloured or black, and the horns are as often with black points as not.

The *Devon* breed is represented by the portrait of Mr. Webber's heifer, "Lydia" (Fig. 6, p. 398), first in her class, all of which were commended at the Bath and West of England Society's Meeting at Croydon in 1875. Of small size and red colour, without any patches of white, the Devons are not a dairy breed.

*par excellence*, but they leave their comparatively bleak home in the districts of North Devon, and are sold as stores at three years old, either to be grazed in the richer valleys of the southern division of the county, or possibly for use in the butter dairies of the same county and of Dorsetshire, where, however, a larger red breed of similar type is preferred.

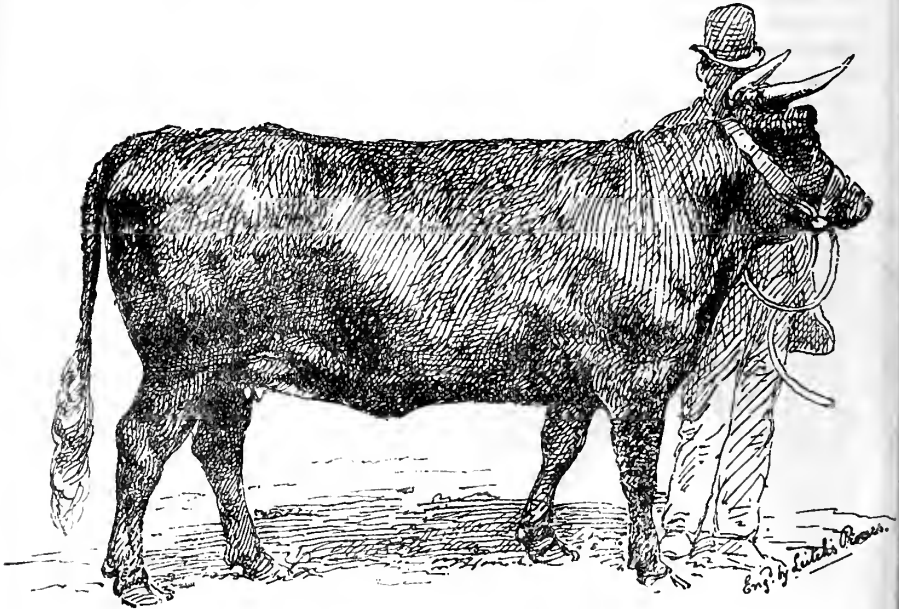

Fig. 6.—Mr. Webber's Devon Heifer, "Lydia."

The Sussex  
breed.

The *Sussex* breed must be merely named. It is even less a dairy breed than the Devon, which it much resembles, being of the same dark-red colour with middle-sized spreading horns, but rather thicker in its build and of a larger size. It is now well represented at all our annual cattle shows: and is becoming generally known as a good grazier's beast, capable of carrying a great weight of good beef at an early age.

The Norfolk  
Polled breed.

The *Norfolk Polled* breed is distinctly a dairy breed of cattle, largely cultivated in the two eastern counties—Norfolk and Suffolk. The portrait (Fig. 7) represents "Gloss," a cow of the breed belonging to R. E. Lofft, Esq., of Troston, Bury St. Edmunds; and it will be seen that in form it represents the very ideal of a heavy milker. With somewhat slender head and neck, and great development towards the hindquarter, and with a large full udder, she leaves nothing to be desired. The butter dairying of Suffolk is gradually disappearing; but the



breed is maintained in its purity by a considerable number of farmers; and it well deserves that it should not be lost. In records kept by Mr. Herman Biddell of Playford, near Ipswich, who has a large and admirable herd of these cattle, I have seen that the milk produced in particular instances has averaged 2.4 to 2.7 gallons daily per cow for  $8\frac{1}{2}$  months together—to which, in order to learn the full annual yield, must be added a certain quantity consumed by the calf till it was 4 or 5 weeks old, and some of the later milkings also which were not recorded. The total produce of the  $8\frac{1}{2}$  months amounted to from 620 to 700 gallons, quite equal to the produce of a good Shorthorn cow, which would be at least one half heavier and

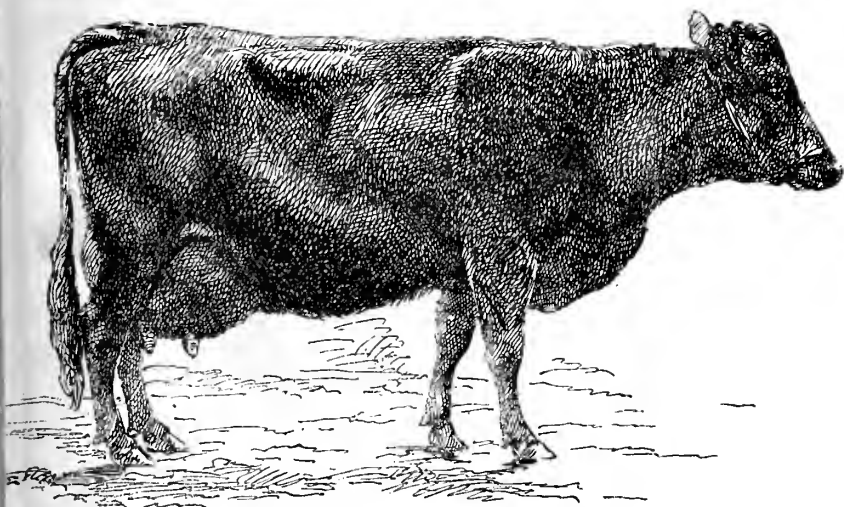

Fig. 7.—Mr. R. E. Loft's Norfolk Cow, "Gloss."

larger than the Norfolk. The cattle are grazed on the comparatively poor pastures of the county during summer, and receive straw and turnips during winter, with a little hay before and after calving, until they can be turned out to grass.

The two *Channel Island* breeds—the Guernsey, with its yellow and white larger frame, and the Jersey, fawn or dun, with black points and deer-like beauty—are noteworthy dairy breeds, of which the shortest mention must suffice, for they occupy but an insignificant place in the list of breeds furnishing the general dairy stock of our cheese and butter districts. They are found occasionally, one or two, in any large herd of dairy cattle, for the sake of the added richness thus imparted to the milk; but it

The Guernsey  
and Jersey  
breeds.

is chiefly as the family cow that they are known and prized. All round London, where a single cow or perhaps a couple suffices to provide the milk and, in part, the butter of the household, the Channel Island cow, generally the Jersey, is seen. Of course in England, as well as in the islands, there are also considerable herds from which the demand for these single cows is supplied; but they do not, except in the islands themselves, constitute the dairy stock of any considerable agricultural district.

The Kerry  
breed.

Some reference to the dairy farm management of Ireland may be made in the sequel. The dairy stock of Ireland has become of late increasingly of a Shorthorn character, and large numbers of capital stock are annually imported from it into England for fattening purposes. The only characteristic Irish bred is the diminutive Kerry, red or black, of which the subjoined portrait

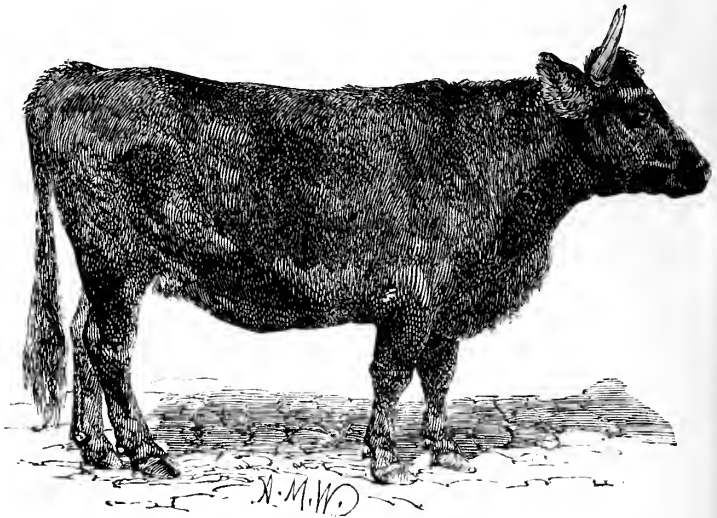

Fig. 8.—*Mr. J. Robertson's Kerry Heifer.*

represents a heifer bred by Mr. Robertson of Santry, near Dublin. They are a hardy diminutive race, yielding a rich milk in, for their size, remarkable quantity.

I now turn to the four uses of milk, to which reference has already been made, as covering the whole dairy industry of the island, with its 1,000,000,000 gallons of milk per annum.

## CHAPTER II.

## THE REARING OF CALVES.

THERE is, in the first place, the practice of letting the calf Calf-rearing. run with its dam at grass all through the summer, which one sees adopted in Herefordshire, for example. There are also farms where heifers are put to the bull at 18 months old, and allowed to suckle their calves for 8 to 10 weeks, thereafter being put dry and grazed and fattened; becoming at 3 years old, after a winter's feeding, nearly as heavy as if they had been fed right through, with the advantage of having reared a calf worth 4*l.* or 5*l.* into the bargain. There are also farms where 6 or 7, and even more, calves are reared each year upon a single cow; the calf being brought from its dam at 2 or 3 days old to suck its nurse, with which it keeps till gradually weaned off at 8 or 9 weeks, a second young one gradually taking its place—the cow, in fact, always having two calves with her—the one being gradually helped more than the other with gruel and other food, and getting less of the milk. Here, too, the labour of hand-milking is avoided, which is the growing difficulty everywhere, even in distinctly dairy districts. The practice in most dairy districts is to get rid of calves at a few days old, selling them as soon as possible, in order to devote the whole milk of the cow to cheese- or butter-making. In some parts, however, especially when it is the object of the farmer by the use of a good bull to improve his stock, a considerable proportion of the heifer calves are reared. On this I again quote Mr. W. T. Carrington, of Uttoxeter, who says:

“It is my practice to rear nearly 40 of my earliest heifer Calf-rearing on whole milk. calves (the herd includes over 100 cows). They are not allowed to suck their dams; they have from 4 quarts to 8 quarts of new milk *per diem*, according to age, for 3 or 4 weeks. They are then fed with skim-milk, thickened with boiled linseed or oatmeal, and are taught as soon as possible to eat hay and a small quantity of linseed-cake. They are allowed to run out on a grass-field in May and June, and are after then generally left out altogether, with a shed to run into in very wet weather, or to avoid the heat of the sun and the teasing of flies. The milk feeding is altogether discontinued when they are about 4 months old. They are supplied with about 1 lb. each per day of linseed-cake all through the year.”

Elsewhere in dairy districts, in order to have all the milk available for cheese-making, the calves, when taken from new milk, are fed with whey thickened with meal. Skim-milk is a much safer food; and now that butter sells at a good price, it

will answer to keep sufficient milk for the calves out of the cheese-tub.

Where cottagers and farm-labourers keep cows, as in some districts in both England and Scotland they do, it is a common practice for the master's bull to be used over all, free of charge, with the understanding that the calf becomes the property of the farmer, at a fair price. The effect of using a well-bred Shorthorn bull is seen in the greater precocity and aptitude of its produce to fatten; and a well-bred stock of calves are made to come out well fattened oxen or heifers, worth 25*l.* and upwards at two years old. The calf is in these cases taken from her dam at once, rubbed dry with wisps of straw, and thereafter fed with its own mother's milk, being, with patience, induced to suck at the fingers in the pail where the milk is placed, and ultimately to drink.\* Whole milk, warm from the cow, may be given three times a day for the first fortnight, and it is allowed to have as much as it will take. It may then be tempted to suck (and at length to eat) small bits of oilcake and sweet hay, and the midday meal of milk may be gradually reduced, and ultimately discontinued; and when the calf at length takes slices of turnips and mangolds freely the milk may be brought down to 5 or 6 quarts a day, water being added to make up the necessary quantity: and at 7 or 8 weeks this may be gradually reduced, and ultimately altogether discontinued. This is the plan described by Mr. J. Wilson, of Edington Mains, Berwickshire, and it is a common practice where whole milk is given. Mr. T. Bowick, in his paper on "Calf-rearing," † says that he has found 4 quarts of whole milk suffice, given at only two meals in this way for the first two weeks—5 or 6 quarts up till the calf is 4 or 5 weeks old—and 6 or 7 quarts daily afterwards; the quantity at length being rapidly diminished, as green hay, cake, and roots are gradually introduced, and at length taken freely.

Calf-rearing on  
skim-milk.

In dairy districts, however, calves are generally reared on skim-milk, and even on whey after the first few days. Mr. Ruck, of Cirencester, describes a plan in which, excepting during the first few days, none but skim-milk, and very little of that, was used. A six-gallon bucket receives first 7 lbs. of linseed-cake ground fine and 2 gallons of scalding water; then 2 gallons of "hay tea," made by pouring scalding water on good hay in a

---

\* We have various contrivances, not yet in common use however, for facilitating this work—buckets covered with a plate over the milk, from which there stands up an artificial india-rubber teat connected by tube with the milk below. Also long wooden vessels standing high enough for pigs, or lambs, or calves, with several such teats along the sides, by which the milk in the vessels may be sucked out.

† 'Journal of the Royal Agricultural Society,' vol. xxii. p. 136.

tub ; then again 7 lbs. of mixed flour of wheat, oats, barley, and beans ; the whole to be filled up with 2 gallons of cold water. This 6 gallons is enough for 12 or 15 calves a day, and it costs about 3*d.* a day apiece. Two quarts of this gruel are added to 2 quarts of cold water, and, with the addition of what sweet skim-milk can be had, this is the daily supply of a calf.

I have known a case in which 5 cows reared 50 calves, their milk having been also to some extent skimmed for butter for the household. The cows were brought to the pail, one after another, from February until May ; and the calves, bought as they could be got, received each a share of the partly-skimmed milk, more and better milk being given to the very youngest, until they began to suck at and nibble shred swedes and hay ; the sole addition to this food was oatmeal gruel, half-a-pint of finely ground best oatmeal for each calf being put morning and evening into about 2 quarts of scalding water, which was cool enough and cooked enough by staying there all day or night for use at the evening and morning meal respectively, after having thus stood twelve hours. This, with care always to give food which is perfectly sweet and not too cold, with attention also to the warmth and dryness of the accommodation that is given the calf, has reared them in health, without a single loss, during the season. It will be seen, however, in Mr. Carrington's practice, as already described—and it is more and more coming to be generally acknowledged—that for the production of the best and most profitable animals, whether for the dairy or the feeding-stall, the more liberal management of the calf is in the end the better way. To stint the young beast is to diminish its quality as a "good doer" from the very beginning. Whether for beef or for milk it is well that good calf-flesh should be established at the outset, and that by no stinginess or severity of after-treatment should it be lost.

When veal is the object, and the desire is to fatten the calf as quickly as possible, new milk must be given, as much as will be taken, and efforts must also be made to induce the consumption of oilcake and linseed-meal as early as possible.

In one or other of these ways, then, the calf is reared ; and considering the large districts over which the most liberal treatment yet prevails, I believe it is not too large an estimate which puts the utilisation of milk in this way at one-sixth of the whole milk produce of the country.

## CHAPTER III.

## THE SALE OF MILK.

Sale of Milk.

I NOW come to the disposal of milk for direct consumption as the second principal use of the dairy produce of the country. Some years ago I investigated the London milk supply (see 'Journal of the Royal Agricultural Society,' vol. iv., 2nd Series, p. 69), and that of some smaller English and Scottish towns. The quantity consumed in London at that time amounted to about 1-5th of a pint a-head. In Stirling, again, a Scottish town of 12,500 inhabitants, the consumption was 2-7ths of a pint daily. In the case of many thousands of people in work-houses, orphanages, and asylums, where the food is under medical direction, the milk consumption was ascertained to be 2-5ths of a pint for each individual daily—being nearly twice the actual ordinary consumption of the ordinary population in England. There were at that time 24,000 cows in London cow-houses; but the country supply was rapidly growing, and the cattle-plague had greatly diminished the number of milch-cows in town. Since then the country supply brought in by railway has enormously developed, and the estimate of Mr. G. M. Allender, manager of one of the largest of the London Dairy Companies, indicates an increased individual consumption. I believe, therefore, it may be assumed that the direct milk consumption in this country of over 30,000,000 people, is now not far short of 1,000,000 gallons daily throughout the year, or more than one-third of the whole milk produce of the country. The market for milk in London now affects farms 100 and 150 miles away; and the business of milk production and transmission is conducted on an enormous scale. When the farm is not more distant, whether by train or carriage, than two hours from the breakfast or tea table where its milk is to be consumed, the milking is done in early morning and afternoon accordingly, and the milk is put direct from the pail into the large vessels—about 3 feet high, in shape like the frustrum of a slender cone, and capable of holding 15 or 16 gallons—in which it is carried in spring-carts either to the station or to the dealer's premises in the neighbouring town. In this case the only precaution taken is to have these vessels absolutely clean. No cooling of the milk is considered necessary; it is poured into the can, which is filled to the lid, locked and despatched.

Country supply of milk.

When the farm is in a distant county, and the milk cannot be delivered in less than ten or twelve hours, great care is taken to cool and aerate it before placing it in the can for transmission. It is either placed in shallow tin vessels in cold water, and thus



at once exposed in a thin layer for the evaporation of its animal odour, and cooled to as low a temperature as the water at command permits, or it is passed over Lawrence's refrigerator, the milk trickling over vertical surfaces kept cold by cold water passing between them and carrying the heat away. The milk is thus aerated at the same time that it is cooled; and in both ways it is rendered less susceptible of change. When thus cooled, the milk may be despatched with safety, although the distance be some hours by railway, in fact, 100 or 150 miles away. In some cases additional precaution is taken by surrounding the cans with wet jackets, the evaporation from which tends to keep their contents cool.

Of the precautions taken by the leading London milk dairies, by means of sampling and analysis, to hinder fraudulent dilution before the milk comes to them or passes from them—also by means of occasional medical inspection of the farms whence it comes, to avoid the real danger of distributing milk which has been infected with the germ of scarlet or typhus, or other infectious fever—I need say nothing here. That there is a danger of this latter kind has been proved by many disastrous instances of late years, and the authorities are now quite alive to its existence.

Of the mode of feeding the cows which supply town milk something ought to be said. Mr. Carrington's method of cow-feeding for milk supply during winter, when milk is dearest, and risk of spoiling *en route* to town is least, has been already stated. The following are modes of feeding in town dairies. Brewers' or distillers' "grains" are the characteristic food. These are the spent malt which has yielded the saccharine extract from which beer or spirit is obtained. They cost from 5*d.* to 8*d.* per bushel; and a bushel or more, sometimes two bushels, are given daily to each cow, besides which she has mangolds, hay, and meal. In fact, the object is, having purchased a good Shorthorn cow, not only to stimulate her milk-produce to the utmost, which grains are especially supposed to do, but to feed her so well that she may begin to lay on flesh as soon as the season of greatest milk-produce begins to decline. A cow which will fatten as well as yield milk abundantly, is the agent by which the cowman realises his profit. She is milked at 4 A.M., receives perhaps 2 or 3 pecks of "grains" immediately after milking is over; then 4 or 5 lbs. of hay are given, and, after being cleaned out, she gets at 9 A.M. from 20 to 25 lbs. of chopped mangolds, and another 3 or 4 lbs. of hay. At 1 P.M. the cows are milked again, and again fed much as before, being well watered once in the course of the afternoon. Or, when they have meal and oilcake, this is given, 3 or 4 lbs. a day, either with the mangolds, or in a gruel over the grains.

On feeding cows for milk.

In the country, where grains cannot easily be had in quantity, dependence is placed on hay and mangolds, with meal of barley and bean or Indian corn, or decorticated cotton-cake; and in summer and autumn, of course, both in town and country, the dependence is largely on clover and vetches and cabbages, in addition to grains and meal. I had charge for two years of a farm near Barking, where upwards of 200 cows were fed; the main resource here, in addition to the grains, was Italian ryegrass in summer (grown by means of town sewage), and mangolds in winter. The average Shorthorn cow, fed thus, will probably yield 600 to 700 gallons of milk during its first 8 months after calving; and 10 stalls, the cows being sold at the end of 8 months, will thus, from year to year, give accommodation to 15 cows per annum, from which it may be expected that 1000 gallons of milk per stall, 10,000 gallons in all, per annum may be obtained for sale; the quantity of food consumed during that time being  $10 \times 365 \times (1\frac{1}{2}$  bushel of grains, 12 lbs. of hay, 40 to 50 lbs. of mangolds, and 3 lbs. of meal). This is the winter ration; but the hay and the mangolds are equivalent to 1 cwt. of green food, of probably equal value, given during summer. This daily ration, according to the prices of food delivered at the cow-house, corresponds to more than 2s. a day, or 365*l.* a year for 10 stalls, being fully 9*d.* a gallon of the milk produced. And besides this, there is risk of disease (a very considerable item) incurred, and the loss between the purchase and sale of the cow (also a considerable sum) and interest of money and cost of labour to be borne. It is thus not to be wondered at that town milk costs 4*d.* and 5*d.* a quart, delivered from house to house.

Suburban milk dairies.

At Colonel Talbot's farm, at Sudbury, Middlesex, 89,236 gallons were obtained from 80 stalls in the year, or more than 1100 gallons per stall; but 153 cows had been bought and sold to keep them full, so that their milking did not average much more than 6 months apiece. At Golders Green, Lord Granville's farm, in the same neighbourhood, 851, 869, and 891 gallons were obtained per stall in 3 successive years, when about 150 cows were bought and sold each year to keep 100 stalls full. The cows were kept on an average 8 months each, and a loss of 3*l.* to 4*l.* apiece was sustained between purchase and sale. At Barking, between October 5th, 1866, and December 29th, 1867, there were 57,354 days' milking of a cow; the average number kept having been 125 cows during that time—varying, however, between 20 and 220, for the cattle-plague swept away a large number during the time—and the milk sold amounted to 139,746 gallons, or 2.44 gallons per cow daily, equal to 890 gallons per annum. The food here was chiefly sewaged grass and mangolds, with hay and distillery grains.

On ordinary dairy farms in the country, when the sale of milk has been resolved upon, very little change is made from the common practice of the country dairy. The cows graze in the cow-pastures during summer, and, as a general rule, get nothing else, except, perhaps, a help with cabbages or clover or vetches, brought to them when the grass is short. In winter they get mangolds and hay, and perhaps some grains, as in the instance of Mr. Lea, of Stapleford Hall, Cheshire; or where they are treated better, they may receive decorticated cotton-cake and meal, in addition to hay and roots, according to the practice of Mr. W. T. Carrington, of Croxden Abbey, Staffordshire.

## CHAPTER IV.

### THE MANUFACTURE OF CHEESE.

To the consideration of this, which is generally understood to be the main industry of any so-called dairy district, I have at length to direct attention. I propose, however, to do little more here than epitomise a report, which has already appeared in the English Agricultural Society's 'Journal,'\* "On Cheese-making in Home Dairies and in Factories;" for the main facts remain very much as they were three years ago, when that report appeared. The several modes and styles of cheese manufacture in this country may be comprised in the following list: Cheddar, Gloucestershire, Cheshire, Derbyshire and Leicestershire, and Lancashire. The factory system of dealing with these several methods must also be referred to. The Stilton cheese, a speciality of which there is a considerable local manufacture, and the Bath and cream cheese—little more than household delicacies—may also be named.

The cheese manufacture.

(a.) The *Cheddar Cheese* shall be described as it was carried on upon the farm of the late Mr. Harding, of Marksbury, Somersetshire, who was one of the best makers in England, and who did good work for cheese-making in Ayrshire and other counties and districts which he and Mrs. Harding visited on the invitation of Agricultural Societies and others, for the purpose of giving instruction in the manufacture of this kind of cheese.

Cheddar cheese.

The morning's and evening's milk are together brought to a temperature of about 80° Fahr. If the night has been warm, a temperature of 78° will give as great effectiveness to a given

\* Vol. xi., Second Series, p. 261.

quantity of rennet as one of 82° or 84° would give if the milk had been at a lower temperature for some hours of a cold night. The evening's milk, having been placed in shallow vessels during the night to cool, and having been stirred at intervals during the evening, is skimmed in the morning, and the cream, with a portion of the milk, is heated up to 100° by floating it in tin vessels on the boiler. The whole of it is then poured through a proper sieve into the tub—into which the morning's milk is being also strained as it arrives—so as to raise the whole, as I have said, to from 78° to 82° Fahr. This tub may be a large tin vessel, capable of holding 150 gallons, and provided with a false bottom and sides, enabling hot or cold water to be passed under and around its contents. The rennet, made from two or three dozen vells, in as many quarts of salt water, and allowed to stand three weeks, is added—half a pint to 100 gallons—and the curd sets in about an hour. The small vells of Irish calves, which are killed at a week old, are preferred, and they should be 18 months old before use. The curd is slowly cut with a single long blade to and fro throughout its depth, in lines forming a 4-inch mesh upon the surface, and the whole mass is gently turned over from the bottom with a skimming-dish and the hand. The whole is then again worked throughout with a "shovel-breaker"—a four-fingered paddle, with wires across the fingers—great care being taken to do it gently, so that the whey shall not become too white. The curd is thus broken up into pieces not much larger than peas, and at least half an hour is taken in the process. Hot water is then let into the space around and below the cheese-tub, and the whole is raised to 100° Fahr.; and this, too, is done gradually, so as to raise the whole by degrees, not heating any portion to excess. This also takes half an hour. The hot water is then drawn off, and the curd is stirred by the hand and a skimming-dish for another half an hour in the midst of its hot whey, being at length reduced to a mass of separate bits the size of small peas. The whey, after settling for half an hour, is then removed—ladled, syphoned, or drawn—to its vat, where it stands about 6 inches deep, and is skimmed next day, yielding a butter, which should not exceed in quantity 6 to 8 ounces per cow per week. The curd stands half an hour after the whey is drawn off, and it is then cut in four or five pieces and turned over and left for half an hour, after which it is again cut and left for a quarter of an hour. After this, according to Mr. Harding, it should be in the slightest degree acid to the taste. If allowed to become too acid, it will not press into a solid, well-shaped cheese, but will be apt to sink abroad misshapen. It is now torn into pieces by hand, and left to cool; and thereafter it is packed in successive thin layers in the vat—a cylindrical or wooden vessel

Mr. Harding's  
practice.

12 inches or more wide and 12 inches deep,—whence, after being pressed for half an hour, it is taken out (it is then probably mid-day), and broken up by hand, and allowed again to cool. Then—when cool, and sour, and dry, and tough *enough* (all this of course being left to the judgment of the maker)—it is ground up in the curd-mill: 2 lbs. of salt are added to the cwt. of curd, and the whole is allowed to cool, and, as soon as cold, it is put in the vat and taken to the press. It is then probably 3 P.M. The pressure on the cheese may be 18 cwt. The cloth is changed next morning. A calico coating is laced on it the second day, and on the third day the cheese may be taken from the press, placed in the cheese-room, bandaged, and turned daily, and afterwards less frequently. The cheese-room should be kept at nearly 65° Fahr. The cheese will not be ready for sale for three months.

The process lasts nearly all the day, but it is believed to produce the best cheese in the world;\* and its use is everywhere extending. Taking its name from a single parish, it now prevails all over North Somersetshire, and is gradually extending into Wiltshire. Many dairies in Gloucestershire adopt the system; some of its characteristic details are followed in Cheshire; and it is well known in Lancashire, Ayrshire, and Galloway.

The Cheddar cheese is made of various sizes, generally 12 inches wide and a foot high, but sometimes larger in both dimensions, and from 70 to 120 lbs. in weight; the object being to make all the milk of one day on a farm of 30 or 40 cows into a single cheese.

(b.) *Cheshire Cheese*, like the Cheddar, is made only once a day. The evening's milk is placed, not more than 6 or 7 inches deep, in tin vessels, to cool during the night, on the floor of the dairy; it is skimmed in the morning, and a certain portion is kept for butter—in early summer only enough perhaps for the use of the house, but in autumn more, and in some dairies at length nearly all the morning's cream is thus taken for churning. The skimmed cream, with a portion of milk, is heated up to

---

\* The pleasantness of cheese as food is of course a matter of accustomedness and taste. On descending the Pic de Sancy above Mont d'Or, during a holiday in Central France, I turned aside to visit one of the hillside dairy farms on the unenclosed moorland. The manager very courteously welcomed me, and we chatted about cheese. He gave me some young cheese and bread and milk, and I offered him a portion of a very good double Gloucester cheese, some of which I had with me in my satchel. I asked him which he preferred, and he was perfectly confident of the superiority of his own, which to me, in its then stage, was young and tasteless stuff, shortly, however, to become the hot strong cheese of the country, of which I had had some experience; whereas mine was a well-matured Gloucester cheese of admirable quality. I laughed at him, and no doubt he laughed at me.—J. C. M.



130° of Fahr. by floating the tins which hold it on the boiler: sufficient quantity being taken to raise the whole of the evening's and morning's milk together to 90°, or thereabouts. The rennet is made the day before it is used; 12 or 14 square inches of vell, standing in a pint of salt water, kept in a warm place, making rennet enough for 100 gallons of milk. The Irish vell is used, as it is obtained from very young and wholly milk-fed calves.

The curd is set in about 50 minutes: it is then cut with the usual curd-breaker, a sieve-shaped cutter, very slowly. The whey is syphoned, pumped, or lifted out as soon as possible; but before it is all removed a portion is (on some farms where the Cheddar system is followed) heated and returned to the tub, and the curd is left in this hot whey for half an hour. The whey is then drained away and the curd is left to get firm. When firm enough to stand on the hand in cubes of about a pound weight—this is an intelligible indication—without breaking asunder, it is lifted out on the drainer (a false bottom of rods), in a long tub with a stop-cock to it, and there left covered up for 45 minutes, after which it is broken up and well mixed by hand with  $3\frac{1}{2}$  to  $4\frac{1}{2}$  lbs. of salt per cwt. It is then allowed to stand with a light weight upon it for about three-quarters of an hour longer, and is turned over once or twice during the time, being cut for the purpose into squares with a knife. It is then twice passed through the curd-mill, and at length put into the vat, a cloth being pressed first into the place by a tin hoop, and the salted curd being packed gently by hand within it. The vats will hold a cheese of 70 or 80, up to 100 lbs.; and tin hoops, placed within them, are used to eke them out and give capacity for a larger quantity of curd, if necessary. After standing in the vat, with a weight upon it, from one to two hours, according to the state of the weather, it is turned over and put, still in its vat, into an oven—a warm chamber in or near the brickwork of the dairy-chimney—where it remains at a temperature of 90° to 100° during the night. Both when in the press and here the cheese is skewered, skewers being thrust into it through holes in the vat, and every now and then withdrawn, so as to facilitate the drainage of the whey. The cheese is taken out of the vat next morning and turned upside down in a fresh cloth. It is in the press three days, and it is turned in the press twice a day, being dry-clothed each time. It is then taken out, bandaged, and removed to the cheese-room, where it is turned daily, or at length only occasionally, until it is ready for sale. In some dairies all skewering is dispensed with, and no pressure is used at the time of making, nor for two days afterwards; but the whey is allowed to run out of its own accord. Cheese manu-



factured in this way requires from 5 to 7 days in drying, but afterwards matures more quickly for market.

The cheese varies considerably in quality throughout the year, the earlier make of March and April being considerably less valuable than that of summer and early autumn. Some of this varying quality is owing to the quality of the milk, the cows being house-fed, but more of it is, in all probability, owing to the necessity of holding a portion of curd over from day to day, when the quantity is insufficient to make either one, or it may be two, full-sized cheeses daily. In such cases it is common to make one full-sized cheese and hold the remainder of the curd over till the next day, keeping it wrapped up on the drainer or pan, and grinding it up in the curd-mill along with the curd of the next morning.

The quantity of cheese made varies from  $3\frac{3}{4}$  to 4 cwt. per cow per annum on good farms. The quantity of butter made weekly in a good dairy is hardly half a pound per cow in the early summer from both whey and milk; in the autumn, the milk being richer, considerably more may be made without diminishing the quality of the cheese.

(c.) *Gloucestershire Cheese* is made generally only once a day. Gloucester  
cheese. The evening's milk is placed in the cheese-tub and in other vessels, standing not more than 3 inches deep during the night, so as to lose its natural heat as quickly and completely as possible. It is there stirred occasionally during the evening and the last thing at night to check the rising of the cream. Any cream that has risen in the morning is skimmed, and so much as it is desired to keep for butter is set apart. The remainder, with enough of the milk, is floated in tin vessels on a boiler until as hot as the hand can easily bear—probably about  $110^{\circ}$  Fahr.—and is poured with all the evening's milk, and the morning's as it arrives from the yard, into the cheese-tub; enough being heated to raise the whole to about  $84^{\circ}$  Fahr.

The cheese-tub may be a tin vessel capable of holding about 150 gallons, and provided with a stop-cock, by which its contents can be drawn off. When all the milk is collected the rennet is added, about a pint to 100 gallons. This rennet is made four or five times during the season, a dozen vells and half-a-dozen lemons being added to 5 or 6 gallons of brine for the purpose, and placed in a covered stone jar for use. The curd is set in an hour. The process of breaking is performed by a sieve-like set of wires, with about an inch mesh, which is fixed at right angles to its handle and pushed down through the mass very gently in successive places all over the surface of the curd. The curd is then gently lifted and moved from the bottom and corners of the tub with the hand and a skimming-dish, and the cutter is afterwards used

again. This process takes in all about half an hour, and the curd is then allowed to settle, and half the whey is baled out. A portion of this whey is then heated to 120° Fahr. and returned to the tub, again raising the temperature there to 84° Fahr.; and then it lies for a quarter of an hour, after which the whey is drawn off by opening the stop-cock. After settling into a firm mass, the curd is cut and turned in pieces over one another on the floor of the tub and allowed to drain. It is thereafter placed in cloths in vats of the size corresponding to about eight cheeses to the cwt., and there it is pressed for a quarter of an hour. It is then taken out and put through the curd-mill and immediately vatted again. It may be then about 9 o'clock or half-past 9 A.M. The cheese is taken out in one hour afterwards, the vat is wiped, and the cheese is replaced in a dry cloth. About three hours later it is again taken out, and this time rubbed with salt, which salting process is repeated at night.

In large dairies this work may be done twice a day. The labours of the dairy, beginning at 5 in the morning, are then not over till 8 or 9 at night. In some dairies cheeses of a double thickness are made, about a quarter of a cwt. each, and they are called "double Gloucesters."

On two or three successive days the cheeses are taken out of their vats, again rubbed with salt and returned to the press. In three days they are taken to the cheese-loft and there turned, at first daily, afterwards at longer intervals. They are ready for sale in six or eight weeks. In a dairy of 40 to 48 cows about 25 lbs. of milk-butter may be taken a week, and the whey yields 10 or 12 lbs. of butter in addition.

The annual make of cheese varies, of course, from year to year, rarely amounting to 4 cwt. per cow, while 3½ cwt. would be considered a fair yield.

(d.) *Derbyshire Cheese* making does not differ materially from the process adopted in Gloucestershire, where the thick (double Gloucester) cheese is made. It is usual to make but once a day, unless in very hot weather, when it may be doubtful if the milk can be got cool and kept sweet during the night, in which case cheese is made in the evening as well as the morning. In general, however, the evening's milk is put in thin layers in the cheese-tub and other vessels to cool during the night, tin vessels of cold water being put to stand in it in order to subject it to as large a cooling surface as possible. In the morning, if much cream has risen, it is partly skimmed, and, if necessary, warmed up with some milk and added to the morning's milk; so as to bring the whole to about 80°. In the summer time, however, the rennet has often to be added when the milk is naturally warmer than this. Enough fresh-made rennet is added to set the whole in

an hour or less. After the curd has been broken with the common sieve curd-breaker, used gently for a sufficient time, a presser is used—a sort of heavy metallic sieve follower—which sinks gradually through the whey and ultimately lies upon the curd, enabling the baling out of the whey. After this has been for the most part taken out, this follower is forced hard down on the curd, so as to squeeze and still further separate the whey from it. The curd may then be slightly salted, though this is not always done at that time. It is broken by hand into a vat and pressed; taken out and broken up again, re-vatted and again pressed; and this may be done more than once—as often, indeed, as seems to be required. It is at length vatted, in sizes of about 4 to the cwt.; its whole surface is made to take in as much salt as it will hold by rubbing and pressing. This gets liquefied by the exuding moisture and is partly absorbed. It is dry-clothed and changed in the press daily, and is in the press 4 or 5 days before it is finally removed to the cheese-room, where it is turned at gradually increasing intervals until ready for the market, at 10 or 12 weeks old.

(e.) *In Lancashire*, cheeses about four to the cwt. are made very much as those of Derbyshire, except that the salting is sometimes done neither by mixing salt with the ground curd, as must be done in Cheshire or Somersetshire, where large cheeses are made, nor by rubbing the surface with salt, as is done in Gloucestershire and partly in Derbyshire; but by floating the cheese in a vat of brine for three or four days after it has acquired form and substance. The curd, when once it has been fairly drained free of whey, is placed in a cloth under pressure for half an hour, and then opened up and rebroken, and again subjected to pressure. It is ultimately put through a curd-mill, and ground as fine as grains of corn. The ground curd is put in vats holding a quarter of a cwt. each, and placed under full pressure for some hours; after which it is taken out and replaced in a dry cloth, and subjected to a day's pressure. After this it is placed for a period of four to six days, either each in an earthenware vessel of proper shape and size, or several together in a long wooden trough, in a brine in which it floats, and from which it absorbs sufficient salt, and becomes hard and firm in the process. In a few days this process is completed, and the cheese is taken out, wiped dry, and placed on the floor of the cheese-room, and turned occasionally, until it is ready for sale.

Both in Gloucestershire and Cheshire, not universally however—also in other districts less generally—it is a not uncommon practice to use artificial means in order to give to cheese a yellow and sometimes even an orange colour. A small quantity—about half-a-gill per 100 gallons—of liquid annatto is for

Lancashire  
cheese.

this purpose mixed with the milk before the rennet is added : giving it a richer, more creamy colour than it naturally possesses—a colour which is almost wholly carried down by the curd, so that the tint becomes much stronger in the cheese. This is not now, however, so commonly done as it used to be. A cheese of natural colour is now generally preferred, and a nasty and to some extent expensive practice is dying out.

Mention should here be made of the great importance, which is everywhere acknowledged, of a good cheese-room—one which can be kept at a uniformly warm temperature, especially during the early months of the cheese manufacture. On this a great deal depends for the proper ripening and maturing of the cheese : a process which is materially shortened as well as brought to a more successful issue, where sufficient warmth can be maintained without any liability to changes of temperature.

Dairy factories.

All the processes of cheese-making are or may be copied in a factory, which, in most of the instances of it which have been established in England, is a co-operative institution—the tenants of 10, 15, or 20 neighbouring farms, including, perhaps, 400 to 600 cows, agreeing to despatch all their milk, morning and evening, to a central building, where the weight of milk sent by each is carefully recorded, as a guide to the subsequent division of the profits, and where all the processes are conducted on a large scale, with the best aids of machinery, under the most skilful direction that can be hired or secured. Made thus in large quantity from the beginning of the season, there ought not to be that variation of quality which prevails in small dairies, owing to the necessity, sometimes, of keeping the curd of two days together for one large cheese, or of keeping over portions of unused curd from one day to another. And there must be considerable economy of labour. The cost of a dairymaid for every 40 or 60 cows is avoided ; the very imperfect equipment of many home dairies is no longer a difficulty ; the conversion of milk, often through want of skill or care or apparatus, into inferior cheese is also avoided. The whole of the milk is dealt with by a skilful maker, with every help that command of hot and cold water, and machinery of the best kind can secure. Of course none of these reasons apply where a skilful mistress, proud of the reputation of her dairy, conducts everything on her own well-ordered premises. And it is not to be wondered at that many landowners, careful of the due equipment of their estates, and jealous also for the agricultural reputation of their tenants, strongly object to these factories. There is a certain saving of labour effected by them, no doubt, but on the other hand there is the additional cost of



carrying milk daily to the factory, and the cost of either carrying the whey back or of losing it altogether, and thus losing the extensive pig-feeding based upon it, from which, on all dairy farms, a certain profit and a considerable manufacture of manure are obtained.

Dairy factories were established in considerable numbers in Derbyshire and Staffordshire a few years ago. They have not increased in number of late. The sale of milk has, in some degree, hindered their extension; and perhaps diminished carefulness, followed by a less marked superiority in the quality of their cheese, has reduced their profits.

The following is the system of management at one of these Factory  
management. factories:—The evening's supply of milk is received into, and pretty equally divided amongst the large milk-vats, which are capable of holding 500 gallons each, being 14 feet long by 48 inches wide, and 20 inches deep. These vats are made of the best tin, and are supported by a stout framing of deal or pine, between which and the tin is a space under the bottom and along the sides. During the night a stream of cold water is kept constantly running under the vats, in at one end and out at the other, filling the space between the tin and the wood, and thus cooling the milk which the vats contain. This stream, as it issues from the lower end of the vats, is conducted by india-rubber-tubing to a small water-wheel sunk in the floor. Gradually filling the floats of this wheel, it at length causes half a revolution, which, by crank and lever overhead, actuates floating wooden rakes, sinking two or three inches in the milk, which are thus driven a foot or two to and fro upon the surface of the milk in the vat, at intervals of a few seconds, all night long—thus hindering the rising of the cream.

The evening's milk is in this way cooled before morning, even to 60° or 65°; and a supply of cool water for this purpose, either from a spring, or pumped from a tolerably deep well, is one of the most important requirements in order to ensure the success of a factory. The object in using the agitating contrivance is to prevent any cream rising on the milk during the night; but it also performs the further important office of doing something towards aërating and deodorising the milk—an office which might most beneficially, during the hot weather, be performed on the milk before it leaves the farmstead—thus enabling it in some measure to get rid of the animal heat and odour which tend to the too early and rapid decomposition of the milk in hot weather, and are distinctly inimical to the production of the finest-flavoured cheese. The morning's milk, on arriving at the dairy, is at once mixed with the evening's, which has been cooled and agitated all night in the milk-vats in the factory. When

sufficient fresh milk has run into that vat which is farthest away from the weighing-machine, the pipe conducting the milk from the tin on the weighing-machine, where it is received and weighed as it arrives morning and evening from the several contributors, is shortened, to adapt it to the next vat, and so on to the last. Steam is now turned under Vat No. 1, and the whole mass of milk in it is raised to a temperature of 80° Fahr., after which the rennet is mixed with it. In hot weather the temperature should not exceed 80°, but in cold it may be as high as 82°. The rennet is then mixed with the milk, half a pint to 100 gallons of milk, enough to perceptibly thicken the milk with which it is mixed in fifteen minutes, and to effect coagulation in an hour; the vats meanwhile being covered, to preserve uniformity of temperature.

When the curd will break cleanly over the finger, coagulation is perfected, and now the curd-knife—a many-bladed cutter, the edges being about half an inch apart—is passed slowly lengthwise through the mass, from one end of the vat to the other, and back again, until all is cut. The edges of this knife are sharp and fine, so as not to bruise the tender curd. The curd is allowed to rest a few minutes, until the whey begins to float over it, when the curd-knife is again passed through the mass, crossing the direction taken before, and leaving the curd in pillars of half an inch square. In this stage the whey rapidly escapes, while the curd gradually subsides towards the bottom of the vat. After remaining in this condition for a short time, the curd is very slowly and tenderly turned over by the hands, after which the curd-knife is freely though very carefully used, cutting the curd into pieces about the size of hazel-nuts. A little steam is then turned into the space between the tin and the woodwork, which was occupied by cold water during the night; and soon afterwards the curd will bear turning about a little faster. During this time the whey continues to rapidly exude, and the pieces of curd to shrink correspondingly in bulk. Up to this stage the curd, which is very tender, demands the most delicate handling, in order that it may not be bruised, and that none of its liquid fats may pass off into the whey. More steam is now turned on, and the curd is stirred much quicker, in order to prevent it being scorched at the bottom of the vat. As the whey has by this time almost completely left the curd, the latter has lost its tenderness, and becomes comparatively hard and tough. A curd-rake may now be vigorously used to keep the curd-particles continually in motion. When the temperature of the mass has reached 90° Fahr., the steam is turned off, and the curd is kept stirred for a time until the vat-bottom has cooled, so as not to injure the curd. It is now left at rest for about ten minutes.



At the end of this interval the steam may be again turned on at full pressure, and it is imperative that the curd now be kept in constant motion. The manager will now, as before, use his thermometer occasionally until it denotes  $100^{\circ}$ , when the steam is turned finally off, and the curd, as before, is kept stirred a few minutes beyond this, until the vat-bottom has cooled down. The entire mass is now allowed to rest for an indefinite time, during which the manager is careful to watch the development of the souring process. A sure plan is to take a piece of curd in the hand, squeeze the whey well out of it, and touch hot (not red-hot) iron with it. If sufficiently acid, the curd will stick to the hot iron, and draw out in fine threads an inch or more long. The whey is now all run off by a syphon, and the curd is gathered to either side of the vat, so that the whey can run down the middle. There is yet some little whey left in the curd, and this continues to drain slowly away as the curd lies packed at the bottom of the vat. Presently the curd, which now adheres together in a mass, is cut into pieces, and turned over time after time until little or no whey runs from it. It is then ground in a curd-mill, and when ground, has salt mixed with it at the rate of 2 lbs. of salt per 1000 lbs. of the milk from which it has been made; in autumn a little more salt is used, or  $2\frac{1}{2}$  lbs. of salt per 1000 lbs. of milk. The curd, being ground to about the size of raisins, and salted, is now vatted in sizes corresponding to about four to the cwt., and put under the lever-presses for an hour, during which time the little whey still in it is pressed out. It is then taken out of the press, dry-clothed, and put in again. Here it remains, with a good pressure upon it, until morning, when it is finally taken out of the press, conveyed to the lower curing-room and weighed, has some tissue-paper ironed on to the flat sides of it to prevent cracks, and is put on the cheese-shelves. Here it is turned daily for a few days until it goes to the upper curing-room, where it will be turned every other day. This cheese is ready for sale in six weeks or two months after it is made.

At this factory they dealt during the season of 1872 with the milk of 230 cows, the property of 17 contributors : 79,722 gallons of milk had been received, and 81,288 lbs. of green cheese made. The quantity sold (at an average price of 80s. 9d. per cwt.) indicated a shrinkage of 9 per cent. The cost of labour had been 121l. ; of fuel, 15l. 7s. 7d. ; of salt, rennet, annatto, and bandages, 28l. 9s. ; of rent and interest on plant, 18l. 16s. The balance for distribution, supposing there were no charge for marketing, would be close on  $6\frac{1}{2}d.$  per gallon for cheese alone, exclusive of whey and butter.

Factory  
statistics.

At another factory, where a considerable quantity of the milk

received had been sent to London, the cost of labour—manager, 75*l.*, assistant, 29*l.* 14*s.*, and extra-assistant, 11*l.* 13*s.*,—amounted to 116*l.* 7*s.*, or 2*s.* per cwt., for the 58 tons 17 cwt. 3 qrs. and 3 lbs. of green cheese which had been made. The cost of materials—coal, 15*l.* 16*s.* 4*d.*, coke, 2*l.* 19*s.* 2*d.*, bandages and cloths, 4*l.* 14*s.* 1*d.*, salt, 5*l.* 8*s.*, rennet, 22*l.* 17*s.* 8*d.*, and annatto 1*l.* 12*s.*—amounted to 53*l.* 7*s.* 3*d.*, or 11*d.* per cwt. of the cheese. The petty expenses, amounting to 7*l.* 9*s.* 5*d.*, reached 1½*d.* per cwt.; the account-keeping—10*l.*—came to about 2*d.*, and the rent of the building and plant—40*l.*—to 8*d.* per cwt. The cost upon the whole thus reached 3*s.* 10*d.* per cwt. of the green cheese manufactured, or, assuming a shrinkage of 10 per cent., to rather more than 4*s.* 3*d.* per cwt. over the quantity sold. Deducting the charges for rent and accountant, it would amount to 4*s.* exactly. And, let it be remembered, that at this rate, the cost of a dairy of 30, 40, 50, or 70 cows, yielding 4 cwt. of cheese apiece, would amount to only 24*l.*, 32*l.*, 40*l.*, or 48*l.* respectively for the sum of the items of labour, fuel, and materials employed in cheese-making. Of course the milk has to be carried under this system, and the milking of the cows and the scalding of the vessels have still to be done and paid for under any system; but it is not to be doubted that there is here an immense saving of labour and expenditure.

It is believed that when the best quality of cheese is made in home dairies, at least 8*d.* per gallon is made of the milk altogether—including the cheese, any butter that is sold, and the pork that is made by the conversion of the whey into meat. And few farmers will admit that they do not make more than 7*d.*: but of the actual facts exact knowledge hardly anywhere exists. The dairy factory has this advantage, that the exact accounts are teaching dairy farmers knowledge. The following are the returns from some of the factories in Derbyshire:—

At Mickleover 107,852 gallons of milk, received in 1873 from 250 cows in April and afterwards till November, produced 102,882 lbs. of green cheese. And assuming a shrinkage of 10 per cent., there must have been a sale of upwards of 38 tons. The cheese made at this factory had realised an average price of 85*s.* per cwt. of 120 lbs. The labour in this case cost 140*l.*, fuel 18*l.*, materials 12*l.*—170*l.* in all, or rather more than 4*s.* 4*d.* per cwt. The labour employed and paid for here could have dealt with double the quantity of milk; the materials employed were, of course, in proportion to the milk on which they were employed. At 85*l.* per ton, the cheese made at least 3230*l.*, or rather less than 7¼*d.* per gallon of the milk. At Longford 246,553 gallons of milk had been made into 250,133 lbs. of green cheese; 84½ tons had been sold, at an average

price of 82s. 3½d. per 120 lbs. ; or rather less than 7d. per gallon of the milk that had been used. In both of these cases of course the value of the whey has to be added.

It is one advantage of the factory system that it at once awakens all who contribute to it to the questions of quality and quantity. The weight of the milk received from each contributor is recorded daily, the quantity of green cheese made is every day ascertained, the shrinkage before sale is known ; and, under co-operative management, every one is on the look-out for deficient results of any kind. The "patrons" of a factory know perfectly how much milk it takes to make a pound of cheese ; but, though they had been making cheese for years and generations previously, not one in a hundred of them knew for certain anything about it before.

Adding the figures together of several of these factories, I find that from 9,682,245 lbs. of milk used in them, 958,945 lbs. of green cheese were made in 1873, being at the rate of 1 lb. of cheese from every 10 lbs. 1½ oz. of milk.

The value of the whey from the cheese-dairy, the utilisation of which is one of the difficulties of the factory system, is variously estimated at 30s. to 40s. per cow per annum. It is received from the cheese-tub into a tank, where it stands for twenty-four hours, and throws up a cream varying in quantity with the skill and gentleness with which the curd has been removed from it ; and this cream furnishes an inferior butter to the amount perhaps of half a lb. per cow weekly. The whey thus creamed is consumed by fattening-pigs, which are one of the most characteristic and important features of all English dairy-farms ; for upon their maintenance and feeding, on barley and maize or other meal along with this whey, the supply of manure for the farm is very considerably dependent. Where butter-dairies prevail, there is a corresponding use of the skim-milk. Young store-pigs are bought at perhaps four months old, or they are bred on the farm and put up to fatten, generally about one pig for every two cows, and three such lots perhaps are fed during the milking season. They are fed up to a value of 5l. to 7l. each, receiving meal with the whey, and making 3s. to 5s. a head per week.

*Stilton Cheese*—manufactured chiefly in Leicestershire—is Stilton cheese. made from milk enriched by the addition of cream, and the curd hardens into cheese without pressure. The cream of the night's milk is added to the new milk of the morning, and the rennet is mixed with it when the whole is at the temperature of 84° Fahr., enough being used to make it coagulate in an hour and a half. If it comes sooner it will be too tough. The curd is not drained of its whey in the ordinary manner, but is removed

in slices with a skimming-dish, and placed upon a canvas strainer; the ends of which, when it is full, are tied up and the whey gently pressed out. It is then allowed to drain until next morning, when it is removed and placed in a cool dish, whence, cut in thin slices, it is put in a hoop made of tin, about 10 inches high and 8 inches across, and pierced with holes. A clean cloth is placed within the hoop, and as the slices are laid in a small quantity of salt is sprinkled between the alternate layers. It remains in the hoop, covered up, but without pressure. Next day the cheese is taken out of the hoop and clean cloths are applied; after which it is inverted and replaced, and pricked with skewers through the holes of the tin hoop, to facilitate the extraction of the whey. In four or five days the curd becomes firm. During this consolidating process the cheeses are kept in a place where the temperature can be maintained at about 100°. When the cheese has become firm enough, it is pared smooth and firmly bound up in a strong fillet of canvas, wrapping it round several times. The binders and cloths are removed every morning; cracks are filled up with curd; and ultimately the coat becomes hardened, and the cheese is removed to the drying-room.

Bath cheese.

*Bath Cheese* may be named, although it is little else than a household delicacy. To one gallon of new milk two quarts of water are added, and two tablespoonfuls of rennet. When it is coagulated, the curd is taken gently out of the vessel with the skimming-dish, and laid in a small vat of suitable size—perhaps 9 inches across and 3 inches deep—a canvas cloth being previously placed in it. Dry cloths should be applied every twelve hours for two days, when the cheese should be turned out on a plate, with another over it, and being turned occasionally it will be fit for use in a fortnight.

Cream cheese.

*Cream Cheese* may be made from a quart of cream, to which, perhaps, a pint of new milk may be added. It is warmed in hot water to about 90° Fahr., and a tablespoonful of ordinary rennet is added. It is let stand till it thickens, then broken slightly with a spoon and placed in a frame 8 inches square and 4 inches deep, in which a fine canvas cloth has been placed; and then it should be pressed slightly with a weight. It stands for twelve hours, after which it may be lifted out and re-placed in a finer cloth over which a little salt has been powdered. It is fit for use in a day or two; but is a mere household delicacy.

I conclude this section of my Report by a reference to the cheese-trade of the metropolis, and to the kinds, sizes, and qualities of cheese which are most in demand in London. At my request, Mr. H. F. Moore, who is Hon. Sec. of the British



Dairy Farmers' Association, spent a day lately for this purpose among the cheese-warerooms of Tooley Street and the neighbourhood, and the following are some of his notes:—

“Generally speaking, it seems pretty certain that most of the local ‘makes’ of cheese are fast disappearing, so far as the London trade is concerned, and that the Cheddar system is gradually extending itself. Even for Cheshire cheese, excepting a few of the very finest dairies, the London demand, compared with what it was before the year 1868—the cattle-plague year—is very small. The bulk of the trade in Cheshire cheese is now done at Manchester and Liverpool. The American and Canadian cheese—especially the former—is very similar in character to Cheshire cheese, and the quality is so good that only the very finest makes of Cheshire can stand against them.

Size and forms  
of cheeses.

“But, more important than this competition between American and Cheshire cheese, the way in which the Cheddar shape and make have thrust other local makes out of the London market is worth noting. At none of the warehouses visited could a single Derbyshire, Leicester, Blue Dorset, Ayrshire, or Dunlop cheese be seen. ‘There is no demand for these sorts here—trade in them quite dead,’ was the invariable remark. The London cheese-eater has now acquired an almost exclusive taste for the Cheddar sort—the preference being given to one with a clean skin, of white colour, solid and firm in texture, mellow to the palate and with a slightly nutty flavour. At the warehouse of Messrs. John Corderoy and Son, in Mill Lane, Tooley Street, there were only Cheddars and Cheshires in stock of English make—the rest being Canadian and American. Three lots of Cheddars from different dairies were examined; the first consisting of a very even parcel of 20 cheeses. One of these measured across the top 1 foot  $2\frac{1}{2}$  inches, and was 10 inches in depth. It weighed 64 lbs. The weight of the 20 cheeses was  $11\frac{1}{4}$  cwt., or 1260 lbs.—the average of the whole being 63 lbs. The next dairy consisted of 76 cheeses; the one measured was 1 foot  $\frac{1}{2}$  inch across, and  $11\frac{1}{2}$  inches in depth, and weighed 79 lbs. The weight of the whole was 53 cwt., or 5936 lbs; the average being  $78\frac{1}{2}$  lbs. per cheese. The third dairy consisted of 23 cheeses, and weighed 17 cwt., or 1904 lbs., on an average  $82\frac{3}{4}$  lbs. per cheese. The one measured was 1 foot  $2\frac{1}{2}$  inches across the top, and 13 inches in depth. These cheeses were made at Langport in Somerset. They were selling at from 70s. to 90s. per cwt. of 112 lbs.

“Of the Cheshire cheese examined, the first lot was a dairy of 18 full-sized cheeses, weighing  $14\frac{1}{2}$  cwt., or 1624 lbs., or an average of  $90\frac{1}{4}$  lbs. per cheese. The one measured was 1 foot 3 inches across the top and 1 foot 1 inch in depth.

“Of the secondary or medium size, three dairies were inspected. The first consisted of 50 cheeses, weighing  $27\frac{1}{2}$  cwt., or 3080 lbs., or an average of  $61\frac{1}{2}$  lbs. per cheese. The one measured was 1 foot 2 inches across, and 11 inches in depth. The next dairy consisted of 18 cheeses, weighing  $8\frac{3}{4}$  cwt., or 980 lbs.; the average weight per cheese being  $54\frac{1}{2}$  lbs. The one measured was 13 inches across the top and 11 inches in depth.

“There is another size of which examples were examined—small or lump cheeses, as they are called. Thus, a dairy of 20 cheeses of this sort weighed 7 cwt., or  $38\frac{1}{4}$  lbs. apiece, measuring  $11\frac{1}{2}$  inches across the top and 10 inches in height. These Cheshire cheeses sell at from 60s. to 84s. per cwt.

“At the warehouse of Messrs. Whitehead and Mullens, double Gloucester cheese ranged from 16 lbs. to 32 lbs. each. Single Gloucesters, 8 or 9 to the cwt., are almost unknown in the London market.

“Wiltshire loaf-cheeses ranged from 5 lbs. to 10 lbs. each, and Cheddar loaves from 7 lbs. to 20 lbs., and sometimes 22 lbs. each.

“At the warehouse of Mr. W. J. Hutchinson, in Tooley Street, the trade is principally confined to the loaf-cheeses. North Wilts loaf-cheese, weighing 9 lbs., measured  $7\frac{1}{2}$  inches across the top and  $5\frac{3}{4}$  inches in depth; another, weighing 8 lbs., was  $6\frac{3}{4}$  inches across the top and  $5\frac{3}{4}$  inches in depth. A number of Double Gloucesters, ranging from 4 to 5 to the cwt., measured about 1 foot  $2\frac{1}{2}$  inches across the top and  $4\frac{1}{2}$  inches in depth.

“At the warehouses of Messrs. J. H. Crump & Sons, in Whitecross Street, Union Street, Borough, there was a greater variety of cheese than at any of the other places visited. Messrs. Crump appeared at the last Dairy Show in London as the agents for Mr. Nuttall's excellent display of Stiltons, in which variety of cheese this firm do an immense business. One expected, therefore, to have found here a large quantity of Stiltons, but it appears that there is little regular trade in this variety of cheese; nearly all the best selling sizes (about 12 lbs. from the dairy, or 11 lbs. shrunk from the warehouse) being sold off at Christmas time, when nearly the whole of the business in Stilton cheese is done. A good Stilton is of a soft creamy texture that will mature quickly and evenly, and it must be mild in flavour. When thoroughly ripe and shrunk it should weigh from 11 lbs. to 14 lbs. One of Mr. Nuttall's measured 7 inches across the top and 9 inches in depth, and weighed 13 lbs. It had matured remarkably well, the blue lines being very evenly distributed through the cheese. Another of Mr. Nuttall's measured  $7\frac{1}{2}$  inches across the top and was  $8\frac{1}{4}$  inches in height; it weighed 13 lbs.



“A dairy of Dorset cheese—not blue (skim-milk) Dorset—made at Barford was of excellent quality. Of a pure white colour, and mild flavour, and perfect shape, they measured 1 foot 3 inches in depth and 1 foot 1  $\frac{1}{2}$  inch across the top.” Some reference to the skim-milk cheese manufactured in Dorsetshire and other butter dairies will be found in the following chapter.

## CHAPTER V.

### THE MANUFACTURE OF BUTTER.

THE Butter Manufacture is, of course, more or less common all over the country. In households where a single cow is kept, and on farms where the milk of a large herd is devoted to the manufacture of cheese, as well as in the so-called butter-dairy districts, the churn is in weekly use; and butter-making, more or less skilful, results in butter of various quality. There are, however, some districts where butter is as much the exclusive produce of the dairy as cheese is elsewhere. From the port of Cork, in Ireland, as many as 500,000 firkins of Irish butter—weighing 70 lbs. apiece—are annually exported to England. And from Waterford, and other Irish ports also, large quantities are sent to the English market. The principal English butter districts occur in Dorsetshire and Buckinghamshire, and till lately in Suffolk, where farms, generally below the average size of the county, with herds of 20 to 30 cows apiece, are devoted to this industry. In Ireland the cattle are acquiring more and more of a Shorthorn character, and this is also true of the Buckinghamshire district, whence large-framed Shorthorn cows, used for two or three years for butter-dairying, are afterwards sold for milk-produce to the London cow-houses. In Dorsetshire the cattle are more mixed—red and white Herefords, large red Devons or Dorsets, and half-bred Shorthorns. In Suffolk the characteristic polled breed of the county is prevalent. I propose now to describe the Buckinghamshire, Dorsetshire, and Irish practice, with shorter reference to other districts; and this will sufficiently illustrate the butter manufacture of the country.

In Buckinghamshire a farm of perhaps 150 acres is probably almost wholly permanent grass-land. The cattle are grazed in summer, and fed on hay during winter, still in the field, provided perhaps with an open shelter-shed. When a small proportion of arable land belongs to the farm, the cows may receive a few turnips or mangold-wurzels, with straw for fodder, and thus economise

The butter manufactures.

A Buckinghamshire dairy farm.

the hay. On such a farm the cows are brought in some numbers to the pail during almost every month of the year, except July, August, and September. Although the early months of the year are the most common calving time, there are a few coming in to calve from the late autumn onwards, for a winter-butter produce is more profitable than any other. Large-framed Shorthorn heifers are bought—one-third or one-fourth of the whole number milked—to calve at 3 years or  $3\frac{1}{4}$  years old. They are kept two or it may be three years, and are then sold, just after calving their third or fourth calf, for the London milk market. During their stay on the farm their milk is thus at its richest, and afterwards, though poorer, it is more plentiful, and thus the buyer in each case gets what he wants. Bought at 22*l.* to 26*l.* each, they may sell for 30*l.* and upwards when parted with. They will yield when in full milk, after the first and second calf, about 1 lb. of butter daily apiece, on an average; indeed, as newly-calved cows are almost constantly coming to the pail, the herd should average through the year 5 or 6 lbs. a week apiece. The calves are sold either at once, for whatever they will fetch, or, if kept till ten days old, for 30*s.* to 50*s.* apiece for bull and heifer calves respectively. Of course there are many farms where the stock is home-reared, some of the heifer calves being brought up to take their place in the herd. Milked morning and evening, the pails are brought in from the yard or the field, and poured through a sieve into shallow leaden vessels, in which the milk stands 3 or 4 inches deep. It is there skimmed morning and evening, as long as it is sweet; sometimes only twice in summer-time, but in winter three or four times. The cream is kept in a deep leaden vessel, where it is stirred every now and then, and churned twice a week. The churn of the district is a large barrel-churn, capable of turning out from 40 to 60 lbs. of butter at a time; and it is driven by horse-power. It may revolve on friction-wheel bearings, but is simply a well-made oaken barrel, with a side opening which can be safely closed; and there are four or five flanges, extending inwards from the inner surface, rather more than one-third of the radius, which carry the contents round with them as the cask revolves, dashing and breaking the cream in the course of the revolution. Raised to some 60° Fahr. in winter, by heating a portion of the cream in a tin vessel floating on a boiler, and cooled to that temperature, if possible, during summer, the cream yields its butter in forty or fifty minutes. It is collected ultimately in lumps by the beaters, the churn revolving more slowly as it is felt to be coming. The butter-milk is let out and cold water is put in, and the revolution is continued until the water comes away almost clear. Taken out in lumps into a shallow tub, it is there kneaded with the hands,

first in successive waters and afterwards on a dry slab, until the whole of the butter-milk is removed; after which, beaten with so-called butter-boards, it is weighed in 2-lb. rolls and is ready for sale. A little salt is well kneaded in with the butter before the weighing, but not so much as to give it a salt taste.

The skim-milk is used for fattening pigs. It is sometimes given alone, but generally along with from 3 to 7 lbs. of meal (barley and Indian corn) daily, according to the size of the hog. The profits of the pigstye are said to pay for the labour. The difference between the buying and selling of the cow yields a profit which covers the risk of loss from abortion and drop after calving, as well as general disease; and the annual produce in butter and in calf together may amount to 18*l.* a cow. Of late it has become more generally the practice to give to milking cows 2 or 3 lbs. daily of linseed-cake apiece, especially to those which come to the pail in winter or before the grass is ready. The quality of the milk derived from young cows fed on hay and good grass is as good as it can be, and the quality of the butter of the district depends solely on good dairy management. Great care is taken—by industry in keeping all vessels clean, scouring the leaden vessels with sand and ashes, after their successive uses, and scrubbing and scalding all wooden vessels, also by laborious manipulation of the butter, adding the requisite proportion of salt—to insure the first quality; and Aylesbury butter commands the highest price in the market.

*Dorsetshire* practice differs from that of Aylesbury mainly in the somewhat different feeding of the cattle, but also in the manufacture of a skim-milk cheese. The farms are generally to some extent arable as well as pasture. The dairy is sometimes let, as in Ayrshire, to a dairyman or “bower,” who pays an annual rent of from 12*l.* to 13*l.* per cow, receiving certain allotted quantities of grass and other materials, together with the use of the dairy and its appliances. Sometimes, however, a farmer agrees with a dairyman to manage for him. This manager is paid 7*d.* per cow weekly, besides having dwelling accommodation, fuel, milk, and a certain allowance of butter free. The year is supposed to commence on February 14, when a certain quantity of land is apportioned to the dairy—about an acre of pasture and an acre of “hay grass,” *i. e.* feed after the hay has been grown and saved, to each cow. Calving is arranged to commence about Christmas; and, as they calve, the cows are tied up in stalls and are fed entirely upon hay, and when thus tied up the average weekly produce of butter has been as much as 5 lbs. from each cow. The bull-calves are generally sold fat to the butcher when from four to six weeks old. When three or four days old they go into a shed or barn, where they soon learn to drink

A Dorsetshire  
dairy farm.

from the pail the warm skim-milk, and after a short time they begin to eat a little hay and meal. They are kept well bedded with straw, though their house is not cleaned out; and in the early part of May they go forth either for sale, or to be put on green food and become a portion of the stock of the farm. When the dairies are let, a quarter's rent of a cow was formerly frequently allowed the dairyman for each calf brought up by him; so that, to state something like an average sum, if the cows are taken at 12 guineas each, the price of the calf would be 3 guineas; but now calves are worth more.

In April there should be some feed ready in the water-meadow to save the hay and to improve the quality and increase the quantity of the butter; and on or about May 12 the cows take possession of the cowlease, and are entirely on grass until the frosty mornings of November make the first and comparatively slight claims upon the haystacks. Some five or six weeks before due to calve, the cows are allowed to go dry, and are then removed to the yards to feed upon straw, with a small allowance of cake. Formerly it was the rule to give nothing but straw, which probably in the days of the flail may have been fresher and better, but dairy farmers now more generally recognise the utility of cake for the in-calf cow, as well as for the improvement of the land.

Heifers are seldom permitted to bring their first calves before they are three years old, and then not earlier than March or April. Those rising two years are wintered on straw only, or on inferior hay, with a run out if it is to be had. Calves are fed upon hay, roots, and some supplementary meal or cake.

The butter average of the year may be from 16 to 18 dozen of pounds. The importance of exact punctuality is fully recognised. Regularity, method, and cleanliness are the rule. The cream is taken after the milk has stood twenty-four or thirty-six hours in earthenware pans holding about  $2\frac{1}{2}$  gallons each, and it is churned three or four times a week in the old-fashioned barrel-churn. Care is taken to squeeze and knead, and beat and press, and wash the butter-milk out. The butter, duly salted, is either rolled into lumps or fashioned in fancy pats, or tubbed as desired; and despatched either to the country factor or to some large London firm or hotel.

As for the cheese made from the skim-milk, the skim-milk is treated very much as ordinary whole milk is treated in the manufacture of a cheese from it. And though more people now know that Dorset cheese is made from skim-milk, yet more people like it; and instead of being got rid of at 3*d.* per lb., it now readily fetches twice as much, and the supply is barely equal to the demand.

In the neighbouring county of Devon, butter is made, without churning, from clotted cream. The pans in which the milk has stood for twenty-four hours are placed upon a hot plate, until the milk is raised nearly to the boiling temperature, indicated by the formation of blisters under the coat of cream, which becomes thickened and tough, and may be lifted bodily off. The butter comes from it readily by stirring for a few minutes in a dish, either with the hand or with a wooden spoon.

Devonshire  
butter.

For the following notes on *Irish Dairy Husbandry* I am indebted to W. Bence Jones, Esq., of Lisselan, Clonakilty, county Cork. The soil and climate of Ireland are favourable for the growth of grass; there is a constant fresh spring of grass and very few hot days, than which nothing can be better for cows and butter. Probably nowhere can better butter, in all respects, be produced, and the reason why so much inferior butter is made in Ireland is wholly from the habits of the people. Carelessness and slovenliness are the root of the evil.

Irish dairy  
husbandry.

In some districts the whole milk is churned. In Munster only the cream is used; and on large farms, feeding 20 to 50 cows, excellent butter is often made, which brings the best price in the markets, to which it is sent in firkins of 65 lbs. to 70 lbs.

Facilities of communication and the high price of good and even bad butter in England have greatly affected the trade. Formerly the chief market for Cork butter was in foreign countries and the colonies. Now very little of the foreign trade remains, and none of the colonial. England is the market for nearly all the Irish butter. It was necessary that butter to be exported should be heavily salted, using 5 to 7 lbs. of salt to the cwt., else it would not keep. The trade in this heavily salted butter is a profitable one to the Cork dealer, but bad for the producer, because the heavy salting of butter makes it necessarily an inferior and lower-priced article.

The great body of Irish farmers, too, keeping six or eight or ten cows apiece, can never get the best price, even of Cork market, for their butter. They cannot usually fill a firkin of 65 lbs. at one churning; and if a firkin is filled at two churnings with equally good butter, that still reduces its quality. Another mode of business accordingly has sprung up in the past twenty-five years. Dealers in all the smaller towns buy butter every market-day, fresh in lumps from the farmers, &c. These men go by the name of "slashers," because they attend the market with a large square tub on a cart, into which they "slash" the lumps of butter bought. It is taken home, washed in cold water to remove butter-milk, &c., and at last washed in warm water, and mixed together into a mass of one texture and colour, and, in a semifluid state, after being salted, it is poured into firkins, and



hardens on cooling. It is said that clever rogues can manage to keep so much of the warm water in the butter as to add much to its weight. On the other hand, as the ingredients that cause rancidity in butter are undoubtedly volatile, washing in warm water removes these taints and sweetens inferior butter. The effect of the warm water is to "break the fibre," as it is called, *i.e.* to do away with the granular appearance which the best butter has. Such butter is very seldom better than third quality in Cork market. It is, however, good wholesome butter, fit for all kitchen purposes; and the breaking of the fibre makes it spread better and go further in making pastry, for which purpose it is bought by large confectioners in towns, who make pastry on a wholesale scale.

In spite, however, of defects—the bad influence of market defects, as well as those from neglect in butter-making—it is certain that in the South of Ireland dairying is much the most profitable way of dealing with land, and accordingly the number of cows kept constantly increases. There is no difficulty even with land in poor order, that is worth 20s. an acre to let to a tenant, in making a return of 40s. an acre from it by a dairy. Since the famine, the practice of letting cows to a dairyman has greatly increased. The owner provides cows, utensils and house, and land for potatoes, to be manured by the dung of the cows. The dairyman is allowed to keep two or three sheep, and a horse or donkey, according to the size of the dairy. About 4 acres of ordinary land are allowed for each cow. The rent is from 10*l.* to 11*l.* per cow.

Winter feeding is little thought of. The climate gives a constant spring of grass through winter, and there is a little straw from the oats grown after the previous year's potatoes, and perhaps a cock of hay; and if there is any rough land or waste on the farm, there is some winter picking from it. There is no doubt the cows thus let are more profitable; for few tenants make so much as 10*l.* a cow from those they do not let.

But great changes and many improvements are needed in the butter-arrangements of the South of Ireland. An open market, where all can buy and sell at free prices, is the first want; and much smaller packages should be the rule, like those in which Normandy butter comes over—packages of various sizes, so as to suit small farmers.

The practice of churning whole milk has been adverted to above. This plan exists also to some extent in Scottish dairy districts. The whole milk, after cooling in shallow vessels, is poured into larger vats, where it lies undisturbed for three or four days, during which it may sour and thicken. The churning is done by horse-power in large upright churns, with two or three



plunging boards on a common axis. The butter is longer in coming, and is said to be hardly of such good keeping quality, owing to the larger proportion of casein which it is believed to contain.

There are some points affecting butter-making generally, and not belonging to any particular district, to which reference should be made. Any offensive taste of butter, owing to faulty feeding of the cows—as when they are getting turnips, and in a less degree when they are getting cabbages, or mangold-wurzel—is tried to be corrected in the milk. A drachm of chloride of lime in the milk for every infected pound of butter—a dessert-spoonful of a strong solution of saltpetre to every two gallons of milk—are among the remedies employed. The heating of the milk before setting it for cream in order to dissipate the faulty aroma—or the steaming of the turnips, and giving them in a hot mash to the cows, so as in some measure to drive off the aroma before they are taken as food—is recommended as likely to have the same result. Anyhow, care should be taken to give the cow only perfectly fresh and wholesome food of these doubtful kinds—especially avoiding any decayed turnip or cabbage leaves.

Another point of first-rate importance, whether in butter- or cheese-dairies, is the need of setting the milk—whether for cream or curd—in a perfectly sweet atmosphere. The neighbourhood of foul smells, and even of a larder, is mischievous. Milk easily acquires a taint. This is universally known, but acted on with various degrees of intelligence. Dairies are almost universally in a washed and wet and often sloppy plight, and it is not at all generally acknowledged that the air should be not only sweet but as dry as possible, in order to diminish its power for mischief.

The apparatus of the butter dairy, besides the milk pail (a wooden one-handled vessel holding 4 gallons or thereabouts), includes the vessels in which the milk is set for cream, glazed earthenware or glass, or tinned or enamelled iron (the first the most common) holding 2 or 3 gallons each, or large shallow leaden vats of the kind already named; the skimming-dish—a shallow tin saucer perforated to allow the passage of milk; the churn, either a barrel-churn or an upright cylinder in which an axis carrying several plungers works up and down, or a fixed horizontal cylinder with revolving dashers inside. Sometimes this cylinder is of tinned iron, and provided with a duplicate coat, leaving an interval into which hot or cold water may be introduced, according to the season of the year. There are also fancy churns, in one of which two revolving dashers on upright axes are worked alongside, and partly inside one another. In another, a long wooden tub is divided by a longitudinal partition, open, however, at either end, and dashers

(a Dairy implements.

placed in one of these divisions, beat and, so to speak, grind the milk, as it continually passes along one side of the partition from one end to the other, and thence through a screen placed on the other side, which catches the butter as it forms. In yet another form of churn, beaters are provided of cellular structure, so that air is taken down and mingled with the cream. The common barrel-churn was proved to be the most efficient form of all by the latest official trials—those instituted by the Royal Agricultural Society at their annual Show at Oxford in 1870.

In addition to pails and vats and churns there are shallow tubs or slabs and butter-boards, by which the making up of the butter is accomplished, also scales to determine the weight of the roll or pat.

The implements of the cheese dairy include large vessels of tin or wood, in which the milk is set for curd; knives and curd-breakers for reducing the curd after it is formed; tank for receiving the whey; curd-mill—a single pair of toothed cylinders—for grinding the curd as soon as it is dry enough to mix with the salt; cheese vats of sizes corresponding to the kind and size of cheese that is being made; presses in which the vats are subjected to a sufficient weight for the consolidation of the cheese and the further removal of its whey; and shelves or floors on which, at a uniform temperature, the cheese is daily turned and gradually ripens for market. Iron presses are in common use now, in which by compound leverage a small weight is multiplied into the pressure that is required.\*

I have not spoken in this Report of anything but the ordinary dairy practice of this country. The admirable methods and

\* It may illustrate the attention which is now being paid to dairy implements and to their improvement if I here extract the instructions given to the Judges of dairy implements at the Bristol Show of the Royal Agricultural Society, with reference to the improvements of which they may be susceptible. Attention is to be directed to the following particulars in each Class.

“Class 1.—*Cans for carriage of Milk*: Facility of cleaning, facility of filling, ventilation, freedom from spilling, means of preventing motion in milk when travelling, and strength, are points which will be specially noted.

“Classes 2 and 3.—*Churns*: The relative merits of the churns will be decided with reference to the following considerations:—The condition in which the butter leaves the churn, its quality and quantity, the facility with which the churns can be cleaned, and the time which the churning occupies. The butter will be weighed and judged after the process has been completed by the exhibitors, and, if necessary, analysed by the Society’s Chemist.

“Classes 4 and 5.—*Butter-workers*: The points of merit will be:—completeness of extraction of moisture, absence of hand contact with the butter, freedom of machine from fouling, facility of cleaning, and power required.

“Class 6.—*Cheese Tub*: Facility of filling and cleaning, mode and cost of heating, method of drawing off whey, economy of labour generally in putting in milk and getting out the curd.

“Classes 7 and 8.—*Curd-knife and Mill*: Adaptability to their purpose, facility of cleaning.

contrivances which have been introduced from America and Denmark for the manipulation of butter are known:—tables revolving under corrugated cylinders, by means of which the due kneading of the butter for the extraction of milk is more perfectly accomplished than by a careless hand—accomplished too without the danger of losing the finer flavour which runs some risk of loss when large quantities of water are employed in making up the butter: the plan, also, of taking the cream from milk set in deep cans for the purpose. Neither of these plans, though known as being to some extent recommended by American practice, is as yet to any extent adopted on English dairy farms. To set milk for cream in deep vessels and to hasten the process by surrounding them with cold water in both ways diminishes the liability which the cream and therefore the butter from it incurs of acquiring the seeds of decay by exposure to the air. It diminishes both the area and the time of the exposure suffered by a given quantity of cream. Neither of these practices is, however, as yet known in English dairy management; and it has been my duty simply to report English practice as it at present exists. I will, however, so far depart from this rule before concluding this Report, as once more to bring under the notice of English as well as foreign readers the instructive method of recording the experience of a dairy which was adopted nearly twenty years ago by Mr. J. Thornhill Harrison, Mem. Inst. C. E., then of Frocester Court Farm, Gloucestershire—reproducing the diagrams employed for this purpose, which were published in the 'Agricultural Gazette' so long ago as 1862. The quantity of milk from each cow taken once a week is depicted in the upper diagram (page 432) whose lines thus represent the daily produce in quarts of three separate cows for each week from the twelfth to the forty-third week of 1862. It is evident that by a pictorial diagram of this kind not only is the behaviour, value—profit or loss indeed—of each cow kept constantly and strikingly under the notice of the farmer, but a comparison of it with other records, as those of weather and health, for example, is full of useful instruction for his future guidance. And even more is this true of the lower diagram, which represents the milk produce of the whole herd in gallons for each week of the year to which each curve belongs. This diagram has been cut off at either end to admit it into the page,

---

"Classes 9 and 10.—*Cheese Turning and Cleaning apparatus*: General adaptability to its purpose.

"Class 11.—*Automatic Machine for preventing the rising of Cream*: Adaptability to its purpose.

"Class 12.—*Milk Cooler*: Time occupied in reducing the temperature a given number of degrees, and the cost of doing it."

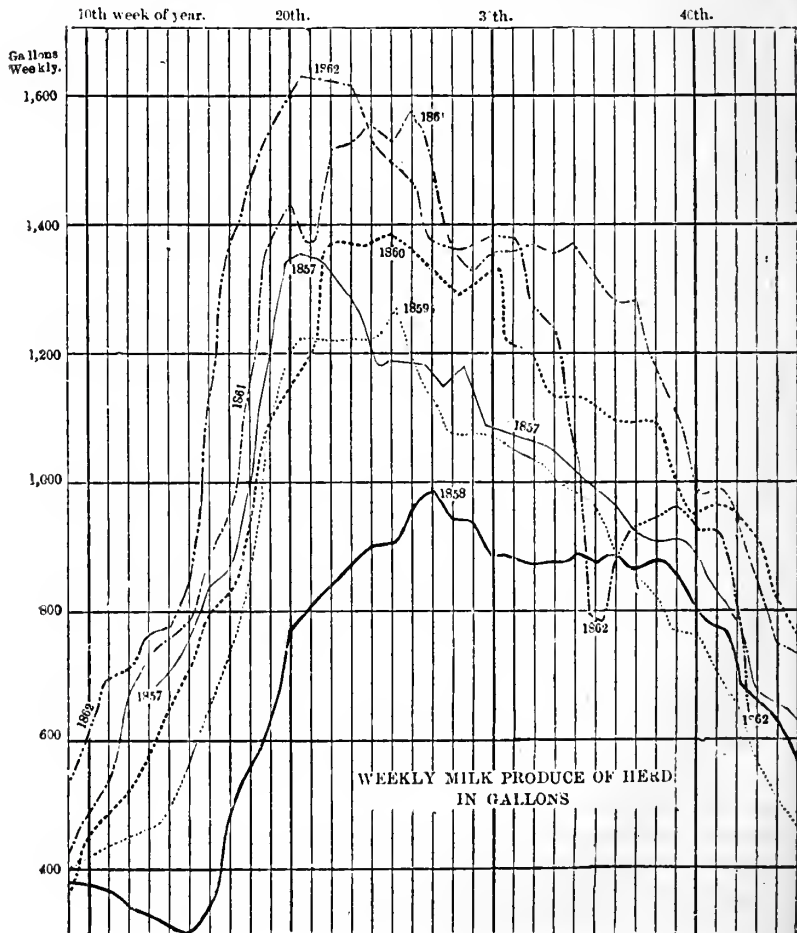
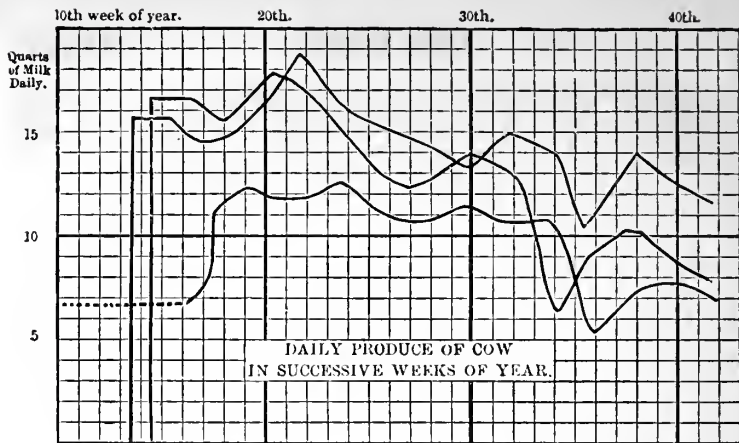

otherwise the curve would have been seen to be continuous from one year's end to the other; for some cows were at the pail throughout. The herd numbered 55 cows in 1857, 52 in 1858, 60 in 1859, 66 in 1860, and 71 in 1861 and 1862. It will be understood that the curves represent the varying quantity of milk for weekly disposal in the dairy. Where the herd is well managed on an ordinary dairy farm, unaccustomed to forcing by purchased foods, an annual curve of this kind ought to correspond pretty nearly to the natural produce of food upon the farm. If grass fail the curve will drop, and if it be particularly abundant in any month the curve in that month will rise; but there are also other circumstances on which it is contingent. Thus the remarkable drop in the curve for 1862 between the thirty-third and the thirty-fifth week of that year was not owing to any sudden failure of food; it was owing to a sudden failure of health. The foot-and-mouth disease attacked the herd at that time and produced the result thus strikingly represented.\* Again, the very late ascent of the curve in the case of the year 1858—not till the thirteenth week of the year—was not owing to lack of food; it was owing to the cows not coming to the pail early enough. And this points to a fault, whether unavoidable or the result of mismanagement, which was no doubt of very serious consequence. The cows ought to be in milk before the time when grass is plentiful. And curves which, like that of 1862, rise continuously and almost abruptly during the fifteenth and sixteenth weeks of the year, show that the cows were then in the condition in which they are able to make the full use of their opportunities. Even the details of this diagram are worth studying. Thus a sudden drop between the eighth and tenth weeks of 1862 tallied exactly with Mr. Glaisher's meteorological report: "From the 20th of February to the 13th of March there was a daily deficiency of temperature to the extent of  $5^{\circ} 2''$  Fahr."

These lines are obviously useful to any farmer who seeks guidance from experience; and I am sure that Mr. J. T. Harrison, now of Ealing, Middlesex, did a good thing by the method which he thus pointed out and practised, of pictorially representing the proceedings of a dairy; and I think that it well deserves mention in a Report of English Dairy Management.

I conclude with the following general summary of English dairy experience.

The profits of Dairy Husbandry in England, as elsewhere, depend, (1) upon the health of the cattle; (2) upon the selection and the maintenance of a suitable breed of cows; (3) upon the proper treatment and feeding of the live-stock; and (4) on the details of dairy management.

---

\* Each of the cows represented in the upper diagram suffered from this disease between the 33rd and the 37th weeks of 1862.

One more paragraph on each of these four points:—

1. Trusting to our insular position, and resolute in an instinctive personal independence which finds expression in the adage that "every Englishman's house is his castle," we have not, till lately, given our Government the power to deal with cattle disease as it is dealt with in Continental countries. The measure, however, which is now on the point of enactment will both protect us from the importation of foreign diseases, as cattle-plague, pleuro-pneumonia, and foot-and-mouth disease, which have been (the first occasionally, and the two last more constantly), since their first importation, the very bane of English dairy farming; and it will give the equally necessary power to restrict or altogether forbid that movement of cattle to and from an infected district, on which the spreading of disease depends. The cultivation of breeding cattle, and with it the extension of our dairy husbandry, which has been checked of late years by the risks of these diseases, may, it is hoped, now be more actively resumed.

2. Excepting only the Shorthorns which are spreading everywhere, the selection of the breeds of cattle to be cultivated has been already accomplished in the several counties to which they belong. The Ayrshire, Devon, Hereford, Norfolk, Polled Angus, Galloway, and other breeds are localised, and are fitted by adaptation during many generations to the circumstances of their several localities. I should have mentioned under this head that large numbers of the Dutch black-and-white cows are now seen in every dairy for the milk-supply around London. They are good milch-cows, but inferior to the Shorthorns in that aptitude to lay on flesh when milking is over, on which the profits of a London dairy very largely depend. Although, however, the breed of any locality is pretty generally fixed, there is a continual improvement of each breed in progress. Continual effort is made by the selection of bulls of known families within each breed to maintain the qualities that are most desired in the offspring. Especially is this true of Shorthorns, of which there are specific strains and families known respectively for their milking qualities and for their meat-producing aptitude. Our ordinary dairy farmers are more and more in the habit of attending the great spring sales of Shorthorn bulls at Dublin and at Birmingham, and elsewhere, to choose their purchases, often at high prices, with especial reference to the known history of the families to which they belong.

3. The ordinary management of the herd in our dairy districts—excepting for the milk supply, where quantity is the only consideration, and where much more liberal feeding is resorted to—consists in letting cows graze in the summer, and



feed either in fields or yards on hay or straw, with a little cake and turnips, during winter. It is now, however, becoming more the fashion to provide a certain proportion of arable land on the farm, and to grow cabbages and vetches with which to eke out the grass in the later summer months and mangold-wurzels for use in early spring; also to give cake in considerable quantities to young stock in the field and to cows in heavy milk. The kindly treatment of dairy cattle, and the provision of good food and clean water, are of course everywhere well understood to be essential to successful dairy farming.

4. The details of dairy management have been described. Given sufficient knowledge of the arts of butter-making and of cheese-making, it may be said that cleanliness, and earnestness in the known rules of ordinary practice are the true foundations of success. There is one point, however, not yet named, on which, more than on anything else whatever, the farmer knows his success to hinge—the one of all others which needs the attention of the master, and in which accordingly, in order to insure due superintendence, the master himself in many a large dairy district invariably takes a share of the work—and that condition is that the cows be always thoroughly milked out. This one particular will make all the difference between profit and loss upon a dairy farm, more certainly than any other that can be named. The operation of milking is indeed becoming more and more the difficulty in the way of dairy farming. And he who shall invent a good milking-machine will well deserve the wealth which it is certain to confer upon him.

---

## CHAPTER ON PASTORAL HUSBANDRY.

BY W. T. CARRINGTON.

PASTORAL husbandry varies very greatly in different parts of England, in consequence of the great variations of climate and soil which exist, and which have an influence upon the kind of stock kept, whether cattle or sheep, and upon the mode of management pursued. Thus we find cattle kept most largely in the north and west of England, and in those districts where there is the largest proportion of permanent grass, owing to a damp climate and heavy land.

Variations in  
climate and  
soil of England.

The eastern, southern, and south midland counties, where the rainfall is much less and where much of the land is light, are more especially devoted to sheep farming.

In describing the present practice of grazing cattle in the

various districts of England, some reference to the special characteristics of the most important breeds of English cattle is unavoidable. Each of them has its special merits, and its advocates maintain its superiority.

Much care and attention have been bestowed upon the breeding of cattle in the last fifty years, and the result has been a great improvement, not only in special breeding herds, but in the general character of the stock of the country.

The Shorthorn  
breed of cattle.

The Shorthorn breed of cattle stands before all others, both in point of numbers and general usefulness and profit. Cultivated with judgment, they possess large level frames well covered with flesh, great aptitude to fatten, early maturity, and excellent quality of beef, combined with great robustness of constitution, and, under proper care and management, excellent dairy properties. Even where dairy produce is not sold, the possession of dairy properties is of great value in enabling cows to rear satisfactorily their own offspring.

Shorthorns are also admirably adapted for crossing with animals of other breeds, or of no particular breed. Very fine beef-animals are every year produced by crossing the Scotch breeds with the pure Shorthorn; and a good well-bred Shorthorn, if put to common cows of no particular breed or special merit, will generally get stock far superior to their dams in size, form, and quality. Shorthorns are the prevailing breed in the north of England; but pure-bred herds exist in every county in England.

Management  
of a pedigree  
herd.

I will only cursorily describe the management of a pedigree herd, where the object is the production of a first-rate animal regardless of cost. Ample box and yard accommodation is provided. The cows are not often expected to do much more than rear their own offspring, even if they do this without help.

The calves, which are dropped at all times of the year, usually run with their dams, being allowed to go on the pastures, when fine, except in winter, and being brought into boxes at night. They are early taught to eat linseed-cake, and bean-meal with hay and cut roots.

The bull-calves, except those decidedly inferior, are deemed too valuable to be reared as bullocks, and are kept for stock purposes and sold at from 9 months to 18 months old, either at home or at one of the auction-sales now held every spring at Birmingham and other central places.

The Birmingham Show and Sale held in March every year, at which more than 250*l.* is given in prizes, has, with excellent management, proved a great success. From 200 to 300 young bulls of pure pedigree, and many of them of great merit, have been sold each year, at an average price of from 35*l.* to 40*l.*

This sale has already exerted a marked influence on the cattle-breeding of the midland counties, many bulls having been purchased there for the large dairy and breeding herds of common Shorthorns. There has also been a demand for exportation.

I will now describe a system of rearing cattle for sale at from 2 years to 2½ years old, recording, as an example of many others, the actual practice on a mixed arable and pasture farm. Fifteen very good non-pedigree Shorthorn cows are kept as a regular breeding herd, and about fifteen heifers calve each year, at the age of from 2 to 2½ years. A Shorthorn bull, of good frame and flesh, and of pure pedigree, is always kept, for which the owner does not scruple to pay from 40 to 80 guineas. The cows mostly calve about Christmas, or in the early months of the year; their calves are all reared, and a number of young calves of the best quality that can readily be obtained are also purchased. The cows are not milked by hand; but the calves, which are kept in pens near the cattle-shed, are suckled twice a day, two on each cow.

Rearing of  
cattle for sale  
as beef.

The calves are early taught to eat linseed-cake and bean-meal or rice-flour, with hay or grass and cut roots; if strong ones, when six weeks old, they are only allowed to suck once a day, and extra calves are purchased and put on the cows. At three months old they are weaned entirely from milk, and other calves take their places. The cows are well kept to increase and prolong the supply of milk. The owner, an active and intelligent man, with the help of one or two boys, makes a point of attending to the suckling himself, as it requires watchful attention. The calves from the two-year-old heifers are generally dropped in May, and these run with their dams in the pastures.

The more promising of the heifers, after suckling their calves four or five months, are kept on in-calf to supply the place in the regular breeding herd of cows drafted on account of age, imperfection, or barrenness. The remainder of the heifers, with the draft cows, are dried off and fattened.

From 60 to 70 calves are thus reared annually; they are kept in yards partially covered, and are supplied in the summer with fresh-mown grass or clover, and 2 lbs. daily of linseed-cake and bean-meal; in the winter the allowance of cake and meal is increased to 3 lbs. each, and hay and cut straw, with whole roots, supplied liberally, until the latter end of April, when they are turned out into a luxuriant pasture of second-year clover or old grass, the cake being discontinued.

Summer and  
winter feeding

In the autumn they are brought up into stalls or boxes, and fed with roots and straw; and 5 or 6 lbs. daily of a mixture of ground corn, equal parts of beans, maize, and oats.

In February or March from 4 to 6 lbs. daily is given of mixed

linseed- and undecorticated cotton-cake, in addition to the meal, making a total daily allowance of 10 to 12 lbs. each of cake and meal for the last two or three months' feeding. Some clover-hay is also given, and mangolds are substituted for swedes.

The beasts are all sold by auction on the farm in May or June, and for some years have realised an average of 29*l.* each, a sum which would have been exceeded if the purchased calves had been anything like equal to those bred at home. The system has been found profitable on this farm. The very liberal consumption of cake and corn has produced a very valuable manure-heap, and has resulted in first-rate crops of corn, roots, and clover, in the improvement of permanent grass, as well as in a very large production of meat.

On some farms, where a small herd of cows is kept to rear calves, a different plan is pursued.

Other systems  
of rearing  
calves.

The calves are not allowed to suck, but are fed with milk, at first pure, and after a week or so with an admixture of linseed or oatmeal gruel. By this means, three or four calves may be brought up in succession by one cow, and, though they will not grow as fast as a calf having the whole of its dam's milk, they may, if carefully managed, thrive very well and be reared with economy and profit.

Sweet skim-milk, with the addition of scalded or boiled linseed, is an excellent food for calves, nearly equal to new milk, the oil of the linseed supplying to some extent the place of cream.

On some farms, well-bred Shorthorns are reared for beef purposes, sucking their dams, and being supplied with extra food as soon as they will take it. They are kept in boxes, and the process of fattening is continued from birth. They are supplied with good hay or chopped straw and roots; or, in the summer, with green fodder; and the allowance of cake and meal is gradually increased. They are sold to the butcher at from 20 to 24 months old.

Diseases of  
calves.

Calves reared entirely under cover never suffer from the hoose, and rarely from the black-leg or quarter-ill, which two diseases frequently cause serious losses in the autumn and winter to those who rear many calves. The hoose is due to the presence in the windpipe or bronchial tubes of small thread-like worms, the germs of which are imbibed with the herbage. Lambs frequently suffer from the same cause. Great irritation is caused, and not infrequently death results from exhaustion.

Quarter-ill is a peculiar form of blood-disease, which attacks young cattle quite suddenly: the blood stagnates, and gangrene seizes upon some portion of the body, generally a limb, hence the name of the disease, which spreads until it reaches a vital

part, when death ensues. Regular good keep, avoiding any sudden changes, or exposure to cold winds, is a safeguard against this disease. The plan of putting a seton in the dewlap, keeping up a constant slight discharge during the first autumn and winter, is commonly adopted as a preventive measure.

Large numbers of heifer- and bullock-calves are reared in the cold hilly districts of Derbyshire and the north of England, where the climate being quite unsuited to the growth of any corn, except oats, the greater portion of the land is in permanent grass. Grazing of upland pastures.

The young cattle are grazed with a flock of hardy Longwooled sheep on the upland pastures, which in the summer and autumn are productive; but as the winters are long, and it is often late in May before there is a good bite of grass, the cost of maintaining the cattle in the winter is considerable.

A well-bred Shorthorn bull is turned out with the heifers when about  $2\frac{1}{4}$  years old, and the latter are sold in-calf the following November. The steers are also usually sold at the same age, and are taken into the midland and eastern counties.

The custom of using cake or other feeding-stuffs to supplement the home-grown fodder is increasing, and results in the cattle attaining better growth, instead of, as was previously often the case, losing in winter the condition gained during the previous summer.

On some grass-farms, where there is little winter provision, the young cattle are purchased each year in April or May, and sold again the following October, leaving, in a fairly good season, from 2*l.* to 4*l.* each for their grass-keep. Suitable young cattle are, however, often difficult to find in the spring; and when the prospect of winter-keep is bad, they are sometimes sold for little more than they cost.

Where a farmer breeds his own stock and brings them to maturity, he is able to watch their development, and is far more likely to bestow pains upon their breeding than when he sells them young. On grazing farms, where there is little arable land, and therefore little straw available for litter, and in the many cases where there is not adequate building to shelter all the cattle through the winter months, young cattle are kept out on the pastures with advantage wherever the land is sound and well sheltered, either from good ox-fences of thorn or holly, or from the natural undulation of the land; 3 lbs. daily of decorticated cotton-cake with a little fodder, in addition to the old grass to be picked off the land, will cause them to thrive much better than in a badly littered yard or shed. Method of keeping young cattle without housing in winter.

Well-bred young Shorthorns, thus fed, will do thoroughly well, and just as in the turnip-fold the land is manured, so the pastures are greatly improved by the consumption upon them of



cake. Grass-farms are known to me, where, from the larger number of cattle now required to consume the greatly increased summer production of grass, due to improvement of and increase in the acreage of permanent pasture, the present buildings will not shelter the whole of the cattle.

The young cattle are brought through their first two winters without being housed, and by the aid of a moderate allowance of cake are kept quite healthy and growing, and are wintered at a less cost than if they were housed, if the interest on the outlay required to erect buildings and the cost of straw for litter be estimated.

Some agricultural writers have pointed to this system as one of the blots on English agriculture ; but this is by no means, in all cases, the fact.

The plan of allowing store or feeding animals to lose condition for want of some extra food is indefensible on economical grounds. Practical owners of cattle appraise the value of their cattle from time to time ; and if, allowing for variations in market-prices, an increase of value in animals, not giving milk, is not apparent, they know that their keep has been utterly wasted.

There is in England much rich grass-land, especially in some of our river valleys, which has not been ploughed for generations, and is very well adapted for fattening cattle in the summer and autumn ; and on such land this is more profitable than rearing young cattle. If suitable cattle can be bought in the spring, and made fat and sold before the grass season is over, there is no necessity for providing a supply of dry fodder, and there is little labour involved in the system.

In the dairy districts a large number of cows no longer desirable for dairy purposes—from being bad milkers, or proving barren, or having aborted—are sold in the spring and autumn, and their place supplied by others. The greater number of them have a cross of the Shorthorns ; and when well selected, of good flesh and young, having had only one or two calves, they are very desirable animals to feed.

Of late years, some of the best managers have given cake to their cattle when feeding on the grass, and, if given with judgment to well-selected animals, it is never more profitably used.

A mixture of equal parts of linseed- and decorticated cotton-cake is found a most suitable food with grass, the cotton-cake checking the purgative nature of the grass. A daily allowance of this mixture, commencing with 4 lbs., increasing to 6 lbs., as the beasts approach ripeness, and costing from 2s. 6d. to 3s. 6d. per head per week, generally pays well. The beasts eat

Summer  
grazing of  
cattle.

Advantages of  
using cake.



less grass; they rest better, generally lying down for an hour or two after receiving their cake in the morning: they fatten more quickly, and, when slaughtered, prove better, being thus more prized by butchers.

Beef is always higher in price in the summer and early autumn than it is later; thus, beasts having cake whilst at grass command a better market. On farms where this plan has been in operation for a number of years, a marvellous change has occurred in the productiveness of the pastures.

According to the estimates of our leading agricultural chemists, Dr. Voelcker and Mr. Lawes, the theoretical value of the manurial residue of these cakes, after consumption by stock, amounts to nearly 5*l.* per acre in linseed-cake, and still more in decorticated cotton-cake. Although in practice these values are probably liable to considerable deduction, there is very evident proof of the high value of cake-manure. It produces grass, not only luxuriant but of good quality, much more relished by stock than grass forced by common dung. It is applied to the grass in summer, whilst vegetation is in full progress; in showery weather, it is at once assimilated by the plants, and there is little risk of its being washed off the surface or too deep into the subsoil before being taken up by the plants.

Well-selected cows, with this extra keep, will pay from 7*s.* to 10*s.* per week for their summer feeding, and in some cases much more than that. Old cows will sometimes fatten well; but in hot sultry weather they are liable to gargel, which sometimes quite spoils them, and their beef is always worth less per lb. than that of younger cows. They are also larger consumers of food.

Grazing farmers who have winter provision, generally buy in November or December lean young barren cows or heifers, and keep them through the winter on hay or chopped straw with roots, and a little cake or meal, so as to have them half-fat by the time the grass is ready for them in April or May; the cake is given at grass, and the beasts are sold fat in June or early in July, paying 10*l.* or 12*l.* each for their six or seven months' keep. Beasts not becoming fat by October are tied up in stalls and finished. There is an extra demand for fat beef of specially fine quality at Christmas, and many farmers keep their finest cattle for this market.

There is a very large import of store cattle from Ireland, principally heifers and bullocks two and three years old. We have no accurate statistics on the point; but the value of this store stock has been estimated at ten millions sterling.

Owing to the large introduction of Shorthorn bulls into Ireland, the quality of Irish cattle has much improved. There are still,

Profit of  
grazing.

Import of  
Irish store  
cattle.

however, many which, from want of breeding, from being half-starved in their youth, or from hardships incidental to travel by rail and steamboat, and transit from one market to another, are a long time after reaching the English feeder before they start to grow, and are unsatisfactory animals to feed.

In past years they have also been a fruitful vehicle of infectious disease, becoming contaminated on the journey; and the vessel, railway-truck, or cattle-pen, when once infected, will taint each successive consignment of cattle. The Irish cattle are reared at a small cost as compared with our home-bred cattle; the land is lower rented, and the winters are damp and mild, so that many of them are kept through the winter with little, if any, dry fodder. They are generally to be bought bigger for money than home-bred beasts; and without a great change in our system, and a much larger breeding stock, they could not well be dispensed with.

If a well-bred lot, not too low in condition, can be picked up they often do very well; but rough coarse bullocks are difficult to feed. Some of these beasts are bought in the autumn, and wintered on straw and roots, with a little cake, or in grass-land districts on the grass, with a little fodder, and are fattened in the early summer. Many more are brought over the Channel in the spring: being generally small beasts, a larger number of them may be kept on the land.

Shorthorn bullocks, many of them reared further north, are grazed largely on the feeding pastures of Leicestershire, Northamptonshire, and the adjoining counties. Bought at  $2\frac{1}{2}$  years old, they run in strawyards, having a few roots and a little cake during the winter; they are pastured on the grass, generally without cake, through the summer and autumn, and are then put in boxes under cover, receiving roots and chopped straw, and 10 lbs. to 15 lbs. daily of cake or meal.

The great object of this winter box-feeding is to convert the straw into good manure, and for the winter feeding not much more money is often realised than the cost of the cake and meal consumed. Bullocks, very well bred and well kept from birth, will fatten at an early age; but, generally speaking, bullocks require a deal of time, and bullock grazing cannot compare in point of profit with the grazing of good cows or heifers, drafts from the dairy. Black Longhorned Welsh cattle are brought in considerable numbers at three and four years old into England to fatten: reared on the Welsh hills, they are somewhat slow feeders; but, when fully ripe, the best of them are prime beef, much prized in the London and other markets.

The Herefords are a very fine breed of cattle for beef purposes, their meat being particularly tender, juicy, and fine

Bullock  
feeding.

The Hereford  
breed of cattle.

grained. They form the prevailing breed in their own county, and there are a number of herds kept in the neighbouring counties. There is also a brisk demand for all the best bullocks and draft cows for feeding in all parts of England, except, perhaps, the north.

Hereford October Fair has for the last 100 years been perhaps the best display of cattle for sale in England; the uniformity in colour, "the red line tipped with white," extending through the market and town, the general excellence of the cattle, and the great numbers exhibited for sale have combined to make this fair most interesting to the lover of good cattle. Of late years the numbers, which once reached as high as 8000, have diminished, a greater number of the most promising beasts being sought for and purchased at home.

The Herefords are very seldom kept for dairy purposes, and the calf is always allowed to run with its dam. The excellent start which the calves thus get accounts for the fact that one seldom sees pure-bred Herefords which are not well grown and fleshy.

There is, however, a breed called Welsh Herefords, which are probably hardly reared, and are much inferior.

I will now describe the mode of rearing, as practised on a farm where first-class Herefords are bred. The cows are, as much as possible, timed to calve in the autumn or early winter months. The calves suck their dams from four to six months.

The cows are kept in yards with shelter-sheds to go into, and the calves are kept in pens opening into these yards, being let out twice a day, and remaining with their dams quite an hour.

The calves, which are kept four or five together, are supplied in their box with a little hay, pulped roots and meal, as soon as they will eat it. Their dams are fed on roots and straw, or hay until they are turned out in the pastures in May. The older calves are then weaned and turned out to grass away from their dams. Any of the cows having much milk are milked for a time, and a little butter or cheese is made. The cows lie out on the grass, night and day, through the summer and autumn, no extra food being given them, as they are apt to get too fat for breeding purposes.

The young heifers calve about May, and their calves follow them in the pastures until November. The calves are all then housed for the winter, the younger ones being kept separate and receiving a little better food. Sliced or pulped roots, with hay or oat-straw, and a little cake and meal form their diet. In May they are all again sent to grass; the steers and the less shapely of the heifers being stall-fed the following winter, some

Management of  
a Hereford  
breeding herd.

of them often realising as much as 40*l.* each, thus showing very early maturity. The breeding heifers are put to the bull in July or August, at 20 to 26 months old, and are kept quite plainly, or they would become too fat.

A Hereford cow and calf are sometimes allowed to run together from 12 to 15 months, both being highly fed, and sold together for beef at as much as 30*l.* each.

Devon breed of cattle.

The Devon breed of cattle has been cultivated for a very long period in the county from which it takes its name, and upon the somewhat poor and hilly land of that county it thrives better, probably, than larger breeds would do.

Devons are kept to some extent for dairy purposes, but their special merit is for the production of somewhat small carcasses of very prime beef. They are always red in colour, though of varying shades; when fat, they handle particularly firm. An extraordinary ox of this breed, exhibited by Mr. Kidner at the great Christmas Fat Cattle Show in 1876, won the champion prize, as the best animal of any breed in the exhibition.

Influence of climate upon sheep.

Sheep are very much affected by the influence of climate.

The beautiful South Down, which thrives so well on the closely cropped herbage in the mild and dry climate of the south-east of England, if transferred to the north midland counties, becomes in the course of one or two generations, quite a different type of sheep. The same principle holds good to some extent with all the breeds of sheep, a change of locality somewhat altering their type. Generally speaking, the native sheep of a district have special qualities, the results of climatic influence, which render them, when improved by careful selection, or by crossing with some other breed, more profitable to keep than any totally different race.

The breeding and feeding of sheep have received great and special attention in England. The high price of wool which ruled in past years, partly in consequence of the scarcity of cotton resulting from the American Civil War, gave a great stimulus to the manufacture of fabrics wholly or partially of wool; and the increased demand for the best qualities of mutton, an article which is less influenced than beef by foreign importations, has combined with the greater consumption of wool to give a great stimulus to sheep-farming.

The production of wool and mutton.

The greatly increased importations of wool from Australia and New Zealand have, however, now considerably reduced the price of home-grown wool. It was formerly thought that we had a monopoly of the production of the best long wool, and that it could not be grown elsewhere; but a large number of rams of our best long-woolled breeds have been exported to the Antipodes, and the wool from their progeny is coming back equal,

if not superior, to any of our own growth. As wool, when pressed for exportation, is a very portable article in proportion to its value, the importation may be expected to increase as our colonies are further developed; it is therefore improbable that the price of wool will rule very high in the future.

The demand for mutton of the best quality is, on the contrary, likely to be at least as great in the future as in the past, and as the production of long wool and of fine quality of mutton are, in some degree, antagonistic, and rarely combined in the same animal, it appears likely that in the future the production of mutton will receive the larger amount of attention.

Some notice of the qualities of some of the principal breeds of sheep will here not be out of place. The Lincoln takes the first place amongst the long-woolled breeds, on account both of the weight of its carcass and of the quality of its fleece. Almost the whole of the sheep in its native county are of this breed, and many flocks are kept in adjoining counties. A great number of fine sheep in the wool, one year old, are annually sold in April at Lincoln Fair, and other fairs in the county. On the shallow soils of the large district, formerly uncultivated, commonly called Lincoln Heath, these sheep seem to thrive admirably upon the somewhat scanty fare yielded by the clovers and stubbles during the summer and autumn.

The Lincoln  
breed of sheep.

Great attention has been paid to the cultivation of the Lincoln breed, and whilst the weight and quality of the wool have been improved, size, weight of flesh, and aptitude to fatten have also been increased. Large prices are paid for rams at the auctions held yearly; thus, last year, Mr. Dudding's 70 rams averaged 21*l.* each, one making 100*l.*; Mr. Casswell's 50 rams averaged 25*l.* each.

The Cotswold sheep are common on their native soil, the Cotswold Hills and the neighbouring counties. They are also kept in Norfolk. They have large handsome frames, and a heavy fleece of coarse wool; they attain a great weight of mutton, somewhat coarse grained, with a large proportion of fat. They are well adapted for fattening at an early age, but handle soft and flabby. Mr. R. Garne's 50 rams last year made an average price of 20*l.* 5*s.*, and many other breeders made fair average prices.

The Cotswolds.

The Leicester breed of sheep is of ancient date, and was in very high repute nearly 100 years ago, great prices having then been given for the purchase and hire of rams. The Leicester sheep is of moderate size, with neat frame, a good fleece of wool, very firm mutton, and great aptitude to fatten.

The Leicesters

The mutton has, however, often too great a proportion of fat, and is therefore not so saleable as that of some other breeds.

The pure Leicester sheep is not so generally kept as formerly in the midland counties, but is largely kept in Yorkshire and in the lowlands of Scotland. A coarser, more hardy variety of this breed is also kept largely in the hilly districts of Derbyshire and the north of England, under the name of the Teeswater, the Border Leicester, or the Limestone Leicester.

The Down  
sheep.

The Southdown is a small gray-faced sheep, with very close fine wool, and mutton of very superior quality. It is specially adapted for warm situations and short dry pasturage. On ordinary farms it is not so profitable as larger-framed sheep.

The Hampshire Down is larger framed and coarser in bone, with a black face and short fine wool. It is only kept in the south of England. The wether sheep are generally fattened at an early age.

The Oxford Down is a handsome breed of sheep, originally due to a cross of Cotswold with Hampshire Down. It has long been a distinct breed, and has been cultivated to great perfection. With generally a dark-gray face, rather long wool and somewhat soft-handling mutton, it partakes most of the character of long-wool sheep. It is kept largely in Bedford, Bucks, and Oxfordshire. Mr. Treadwell's 69 Oxford Down rams at his sale averaged more than 20*l.* each.

The Shrop-  
shires.

The Shropshire breed of sheep is the one which probably, more than any other, is being kept in increasing numbers.

Originally, doubtless, a cross-bred sheep, it has been cultivated with great care, and has become a most valuable breed, thriving, like the Shorthorn cattle, almost anywhere. This breed occupies, to the exclusion of other breeds, a continually widening district in the midland counties. With a good fleece of close thick-set fine wool, and a carcass long, wide, and deep, it has plenty of lean flesh, aptitude to fatten and robustness of constitution. The ewes are more prolific than those of any other breed, and are good sucklers. The colour of the face is black or gray, and the head is well covered with wool. The mutton is of excellent quality, and in all the towns in the midlands, where it is easily to be obtained, the coarser white-faced mutton is only saleable at a reduced price.

A very large number of rams of this breed are kept for stock purposes. At the annual sale held last year, Mr. R. H. Masfen sold 58, at an average price of 22*l.* 8*s.*, and Mr. Evans sold 39, at an average of 23*l.* 4*s.*; whilst at the sale of the noted entire flock of Mrs. Beach, 34 rams made an average of 33*l.* 12*s.* each, and the whole flock of 452, nearly half of which were lambs under seven months old, made an average price of 13*l.* 4*s.* 6*d.* each.

The Dorset-horned sheep have a special faculty of producing



lambs in the autumn, and many are kept in the south of England to produce lambs to be fattened under cover, and sold about Christmas in London and other markets.

Having remarked upon the qualities of some of the principal breeds of sheep, I will proceed to describe the management of sheep on a light-land farm, consisting wholly or principally of arable land. Management of sheep on a light-land arable farm.

A large breeding flock is here usually kept, and, in addition to the keep furnished by the clover or sainfoin and artificial grasses in rotation, various fodder crops, such as winter and spring vetches, rye, rape, cabbages, mustard, as well as an abundant supply of roots for winter consumption, are provided for the maintenance of the flocks. The rotation adopted is either four, five, or six course, the former being the most common, thus: wheat, roots or green crop, barley, seeds. Where it is specially desired to increase the supply of green food, the seeds are kept down the second year until the beginning of June, and then broken up for rape, or some other green crop, to be eaten off by sheep folded on the land, in time to sow wheat. If more corn be desired, barley may succeed the wheat crop, making it a six-course rotation.

The ewe flock is kept young, all those ewes above three or four years old being drawn out every year, and either sold to produce another crop of lambs elsewhere, or fattened. In a ram-breeding flock, ewes of *special* excellence are kept as long as they will breed.

The time of putting the ram with the ewes varies with the locality and the prospect of early spring food. In the south of England, August and September are usual months. In the midlands, October; and in the north, November. On those farms where rams are bred for annual sale, they are usually dropped early, so as to give them a good start. It is better that ewes going to the ram should be, though not fat, in an improving condition, a supply of succulent food at this period having also a favourable influence on the number of lambs yeaned, therefore many farmers put their ewes on rape. Great care is taken to obtain rams of good form, substance, and wool, as one ram is serviceable for fifty or more ewes. A good price for a suitable one is not grudged, as the sale averages just quoted plainly show. In a regular breeding flock the practice of using a ram of another distinct breed is rarely adopted, as the progeny of such a ram, though valuable for fattening, would be undesirable for breeding purposes. In the autumn and early winter the ewes are run on the clover or stubbles, receiving an occasional fold of rape, or early turnips, or mangold tops with chaff and a little cotton-cake. They often follow the feeding sheep, clearing up all their

leavings on the fold. The practice formerly pursued of giving in-lamb ewes a full allowance of turnips is generally discontinued, it being found that they are much better without such watery food before lambing.

The lambing season.

When about lambing, the ewes are brought at nights into a covered shed or yard; or a movable lambing-shed is taken into the open field, and protection against wind and rain is provided by means of hurdles wattled with straw, or one or two old waggon-part loaded with straw, the shepherds giving them unremitting attention both by day and night.

The ewes, after lambing, are well fed, having straw, chaff, or hay, and  $\frac{1}{2}$  lb. to 1 lb. of cake or meal, with roots.

Whatever be the destination of the lamb, the ewe should at this time be liberally fed.

When the lambs are two or three weeks old they begin to eat food with their dams, and lamb-hurdles are often provided, allowing them to run before the fold, and eat a little dust linseed-cake or bruised oats. A change of food for the ewes is desirable as soon as it can be well given. Early rye, or Italian ryegrass, or the second year's clover, with a few mangolds and  $\frac{1}{2}$  lb. each daily of cotton-cake, proves an excellent diet. Castration of all male lambs not required for stock purposes is often done by drawing, at ten days to twenty days old, or is done by searing at three months old. Weaning takes place at from three to four months old; where the lambs are early taught to eat artificial food it is not desirable to delay it too long.

On those farms where fat lambs are sold to the butcher at an early age they remain with the ewes until sold.

Weaning and dipping.

The lambs, when weaned, are either taken a distance away out of the sound of their dams bleating, or a double row of hurdles at a little distance keeps them apart, when they before long become pacified. The lambs are provided with a succession of green food, much importance being attached to a frequent change of diet.

It is not well for them to graze on land which has been folded with older sheep, the rank luxuriant herbage of clover or grass produced by the sheep-manure being unhealthy food for lambs, and causing scour.

The lambs, after weaning, are all dipped in some preparation to destroy parasites, and to prevent for a time the attacks of the maggot-fly, which in some districts, especially where much timber exists, is very troublesome, blowing upon the wool, and, unless quickly eradicated, spoiling the wool, and even sometimes killing the lamb. The ewes are also commonly, after being shorn in May, dipped or smeared with some similar preparation. The ewes which, either on account of age or imperfection, are

not desired to be kept for the ensuing year are drawn out soon after weaning, and supplied with better keep than the store flock, which it is not desirable to force at this period. The seeds are heavily stocked with store sheep, the lambs and fattening sheep being folded on the vetches, rape, or cabbage, with a little cake.

Where rams are reared for sale, a special effort is made to force their growth, and cake or peas are given more freely.

There is some difference of opinion about the advantages of the close-folding of sheep over the open-field system. Most of the best managers of light-land arable farms, however, adopt the plan of small folds frequently changed. It involves more labour and attention, but there is less waste of food, and the land is more equally manured, and the sheep are more under the control of the shepherd when attention is required from any cause. It is not, however, commonly adopted for store sheep when on the clover, grass, or stubbles, or so generally in heavy land and grazing districts.

Advantages of the folding system.

Cabbages are much grown by some large sheep-farmers, some of an early ripening kind being planted in the autumn for consumption in the following May or June, and drumhead cabbages being planted in May for autumn consumption.

The hundredfold cabbage has been much lauded as suitable for sheep, but, with its long stalk and wide open-branching leaves, it is not equal in quality, nor can it produce as much weight per acre as a good crop of solid-hearted drumhead cabbage.

Consumption of roots by sheep.

The feeding hogs (unshorn sheep) are folded on cabbage, or white turnips, in the autumn, followed by swedes, either all or part of the roots being often cut into fingers or slices, and a little clover-hay or chopped straw, and  $\frac{1}{2}$  lb. to 1 lb. of cake or corn daily being given, the quantity being increased as the fattening process approaches completion.

The heavier woolled breeds of sheep are often shorn just before going to the butcher, having been tub-washed 10 or 14 days previously. The general weight of fat tegs of the larger improved breeds, from 12 to 14 months old, which have been well kept from birth, is from 8 to 12 stone of 8 lbs. dead weight. From 10*d.* to 1*s.* per lb. in the wool, or 8*d.* to 10*d.* bare shorn, have been common prices in the early spring for some years; including the value of the wool, such sheep therefore realise from 3*l.* to 4*l.* 10*s.* each.

On many of the best managed farms all roots not required for consumption early in the winter are pulled, thrown in heaps, and covered with soil in November and December, and are then given out daily in the folds as required. There is a special advantage in this system in frosty weather, when sheep cannot well eat frozen roots. Swedes, though capable of standing hard

frost without much apparent injury, do not gain in weight after December, and exhaust the land to some extent whilst growing; they also suffer less from the attacks of pigeons, crows, and ground game. Mangolds being very susceptible of frost, and keeping well if properly stored, for 12 months if desired, are always pitted, and kept for the last eating.

General  
management of  
the flock.

The increase in the number, the improvements of the quality, and the skilful and economical management of the flock, have been deemed the chief marks of good light-land arable farming. The system of sheep-folding just described results in the return to the land, without expense of cartage, of a large quantity of manure; and the consumption of cake and other purchased feeding stuffs leaves the land in high condition for the succeeding crops of corn and clover. The treading of the sheep is also found highly advantageous to all light sandy or gravelly soils, consolidating it and improving its staple.

The adoption of this system many years ago in Lincolnshire, Norfolk, and parts of many other counties, caused an immense improvement in the agriculture of those districts.

Sheep on  
strong-land  
arable farms.

On strong-land arable farms a different system is generally pursued. Except in specially dry districts, or in exceptional seasons, the roots cannot be consumed on the land where they are grown, without injury to the land by puddling, and to the sheep from their muddy and uncomfortable lair. The greater part of the roots is therefore generally carted off the land for consumption in the sheds or yards by cattle or sheep, or upon the clovers or grass-land.

Fatting sheep in covered sheds, standing on slots of wood, through which the manure falls into a pit below, or bedded with straw, thrive and fatten well for a time. In the absence of permanent grass the ewe flock are kept on the seeds, some of which are kept down two or more years. They are supplied with extra food sparingly before lambing, afterwards liberally.

There is not so much difficulty in summer folding green crops on strong arable land, which is then generally drier than in winter.

On low-lying  
grass.

On many of the low-lying grass-land farms, full-mouthed ewes are purchased every autumn from light-land farms. They are kept through the winter on the grass-land, often receiving nothing (except in snowy weather) until nearly lambing. They are then fed with corn and roots until the grass is abundant, when they are kept, not too thickly, upon the pastures where cattle are grazed. The lambs, which are often cross-bred, a ram of another breed having been used to give size and constitution, are sold fat in the summer and autumn.

In large towns and summer watering-places there is a brisk

demand for lamb, its small joints of tender meat being highly esteemed. Good fat lambs make from 30s. to 45s. each. The ewes are fattened after the lamb is sold, and go off at a few shillings over their cost price the previous autumn.

The plan of changing the ewes every year is most necessary on lands naturally wet or liable to flood, and where sheep are apt to contract the rot, due to the presence of flukes in the liver. Many farmers in the north of England get Cheviot ewes every year from Scotland, and cross them with a Leicester ram. They are excellent sucklers and produce capital fat lambs, fattening well themselves afterwards.

On the hills in the north of England and borders of Wales, On hill farms. hill-sheep are kept, one shepherd, with his dog, looking after 500 or 600, which graze on the heather and rough mountain grass, getting no extra food, except in severe weather. The Herdwicks are a very useful mountain race, and are sold, at mature age, to better districts, where they make good-sized sheep, and their mutton is excellent.

Wethers were formerly kept till four years old, and their mutton was specially esteemed on that account, but they are now fattened earlier.

The Welsh mountain breeds are very hardy, and the mutton, when well fed, is a delicacy, but they are small, and much less profitable than the north of England or Scotch mountain breeds. On large feeding pastures of permanent grass, principally grazed by feeding or dairy cattle, few sheep are kept, as with their narrow noses they pick out the finest of the clovers and grasses, and, where many are kept, cattle will neither feed nor milk so well. A few are, however, usefully kept, as they keep down some weeds which cattle will not eat if they can avoid them, such as the common buttercup, the hard-head, and other weeds. Having such choice of food, they also thrive very well. The great drawback to keeping sheep on rich moist land is their Liability to  
foot-rot. liability to foot-rot. The natural home of sheep is on dry uplands, and, kept there, this disease is unknown.

Frequent parings of the hoof, and caustic applications to the diseased feet, such as powdered burnt vitriol, alum, or carbolic acid, are the best remedies, but with every care on some land it is impossible to avoid this complaint, which greatly checks the growth of the sheep. On mixed grazing and arable farms, lambs are kept through the autumn and winter on the grass-land, being supplied with cake and corn, and a few roots being carted to them. When kept and thus well fed on sound mowing land, they do well, and the field is put in condition to grow a crop of excellent hay. The hoggets are sold fat to the butcher in April or May.

Sheep on cold uplands.

On the cold uplands of North Derbyshire, and other counties where no corn (except oats) can be grown, and the land is therefore nearly all grass, white-faced long-woolled sheep, of a coarse Leicester type, are kept, and suit the climate much better than other breeds.

They are wintered on the pastures, a little fodder being given them whenever required before lambing. They are afterwards fed with cotton-cake, and oats with chaff; and in some districts brewers' grains, obtained and pitted the previous autumn, are freely given until, in those late districts, there is sufficient pasturage.

The sheep, when shorn, yield from 7 to 10 lbs. weight of strong wool, rams often cutting a much greater weight. The lambs are weaned in July or August, and are either wintered at home or put out to ley for the winter on grass-farms, in a dairy district within 10 or 20 miles, where the climate is milder and no summer stock of sheep is kept. Ten shillings is paid for the keep of the lamb from the 6th of October to the 6th of April, hay being given only when the ground is covered with snow. The lambs generally do better than they would at home, where the cold winter is apt to stunt their growth; they go back to the farm for another summer's grazing, and are sold with the draft ewes in October, to be fattened in the turnip-feeding districts.

In past years the high price of strong wool has made this farming very profitable.

Great increase in the use of imported foods for stock, and in the demand for fresh meat.

Great changes have taken place in the last thirty years in the pastoral husbandry of this country. The population and the rate of wages have both increased rapidly. Our labouring population are much greater meat consumers than those of any other nation. More of the land of this country has been laid to grass; and, by the purchase of imported foods for stock, a larger amount of meat has been produced. But, in spite of this increased import and production, the price of meat has ruled higher. The greatest obstacle to successful cattle or sheep breeding and feeding has been the great losses sustained from infectious disease, although it has been proved by experience that these diseases may be suppressed and kept under control, if not altogether stamped out.

The recent improvements in the mode of conveying dead meat, in artificially cooled compartments of the steamboat or railway-truck, promise eventually to supersede the conveyance of live animals, being not only less costly and avoiding much cruelty and suffering to the animals, but preventing the transmission of those diseases which have been so disastrous to the stock farmers of this and other countries.



VII.  
THE CULTIVATION OF HOPS,  
FRUIT, AND VEGETABLES.

BY

CHARLES WHITEHEAD, F.L.S., F.G.S.,  
OF BARMING HOUSE, MAIDSTONE, MEMBER OF THE COUNCIL OF THE ROYAL  
AGRICULTURAL SOCIETY.

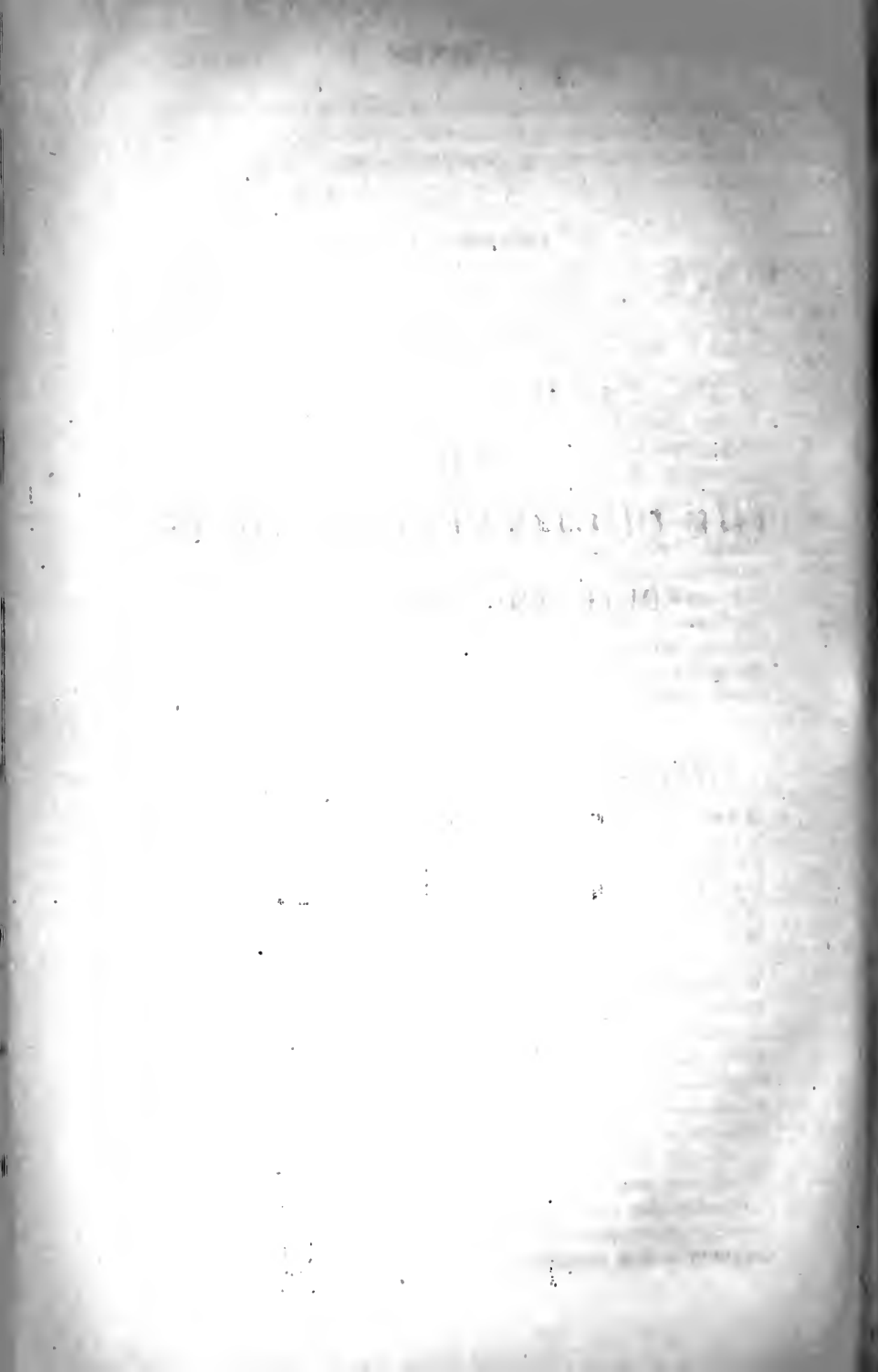

## CONTENTS.

CHAPTER I.—*Hops.*

The Hop first brought into England in 1524—Acreage of Hop-land since 1750: its fluctuation since that date—The Counties in which Hops are chiefly cultivated—Kent has the largest Acreage—The Geological Formation upon which the Hop-plant thrives in Kent—Great age of Hop-grounds in Kent—Hops grown upon the Gault and Greensand in Surrey and Hants—Extent of Hop-farms—Mode of Cultivation—Hop Digging-machine—Dressing and Poling—Woodlands in Kent and Sussex produce Hop-poles—Creosoting Hop-poles—Cost of Poles per acre—The Vinery method of poling—System of training upon wires—Tying Hop-bines performed by women—Ladder tying—Large quantities of Manure necessary—Kinds and Cost of Manure—Implement for working Hop-land—White frosts injurious to the tender Plants—Aphis-blight: remedy for it—Insect Foes—Mould or White Blight checked by Sulphur—Sulphuring Machines—Hop-harvest—Immigrants pick the Hops in Kent—Prices paid for Picking Hops—Sulphur used to bleach the Hops—Drying Process—Hops dried too quickly on account of insufficient Kiln accommodation—Modes of Sale—Price varies according to Sorts—No Home nor Foreign Duty now—Quantity used in Great Britain—Exportation small—Rental of Hop-land—Lucky Farms .. .. Pages 457–470

CHAPTER II.—*Fruit.*

Fruit extensively grown for over 300 Years—The Apple indigenous to Britain—Acreage of Fruit-land in Great Britain in 1877—Large increase in the Acreage during the last four Years—Two distinct Systems of Cultivation—First system, or growing Fruit upon Grass-land, and Acreage of Counties where adopted—Apple and Pear-orchards of Herefordshire—Sorts of Apples and Pears usually cultivated in Great Britain—Cost of Planting, Rents of Land, Returns—Cider and Perry—Apple-orchards form the chief part of the Fruit-land of Devonshire and Somersetshire—Fruit-land in Worcestershire and Gloucestershire—Not enough care bestowed upon the System of Fruit-growing—The Spring season frequently most destructive to Fruit-trees—Cost of raising Orchards—The Second System, or growing Fruit upon Cultivated Land—Fruit-bushes set under Standard Trees—Cherry-culture in Kent—Greengages—Gooseberries; Red, White, and Black Currants—Filberts and Cob-nuts grown in Kent—Their peculiar Cultivation—Fruit Culture in Cornwall—Cornish Raspberries—Plums largely grown near Evesham—Strawberry cultivation—Acreage of Fruit-land in Wales very small—Climate of Scotland unfavourable for Fruit-growing—Large Demand for Fruit—Immense Quantities of Fruit taken for Jam-making—Amount of Fruit grown impossible to be ascertained—Large Importation from France and other countries .. .. Pages 470–482

CHAPTER III.—*Vegetables.*

First Introduction of Market-gardening into England in the 17th Century—Extent of Acreage of Land devoted to the Growth of Vegetables in 1877—Area round Metropolis, or Inner Circle—Area beyond Metropolis, or Outer Circle—Vegetables Cultivated in Special Districts—Essex Area—Middlesex Area—Kent Area—Acreages of chief Counties producing Vegetables—No regular Rotation of Crops—Typical Rotation of Crops—Farm-yard Manure the Mainstay of Market-gardens—Salad and Sweet Herbs specially grown at Mitcham—Asparagus Culture—Sea-kale—Cabbages and Coleworts—Onions a profitable Crop—Large Demand for certain Vegetables for Pickle Manufacturers—Rent and Expenses connected with Vegetable Culture—Profits affected by Foreign Importation—Cornwall—Its mild Climate—Brocoli the chief Vegetables produced in Cornwall—Potato-sprouting process—Two crops of Potatoes taken in a Year—Potatoes grown in large Quantities upon Farms—Average—Decrease in Acreage planted with Potatoes on account of Potato Disease and large Importations—Acreage of chief Potato-growing Counties in England in 1877—Acreage in Wales—Acreage in Scotland—Importation of French Potatoes large—Rotation of Farm Crops where Potatoes are grown, and Systems of Cultivation—Sorts usually planted—Cost of Cultivation—Average Price of Potatoes for last ten Years—Potato Disease—Its life-history only recently traced by De Bary and Worthington Smith—Supposed Blight-proof Potatoes—Town-sewage as applied to Vegetable Cultivation—Wales and Scotland—Conclusion—General *résumé*.

Pages 483-494

# THE CULTIVATION OF HOPS, FRUIT, AND VEGETABLES.

## CHAPTER I.

### HOPS.

THE hop-plant was introduced into England from Artois in the early part of the sixteenth century. Its cultivation was not, however, very extensive until the commencement of the eighteenth century, at which period it appears that there were about 12,000 acres planted with hops.

The hop first brought into England in 1524.

The acreage was increased to about 25,000 acres between the years 1750 and 1780; and it is computed, from a calculation made from the returns of the hop duty, that there were about 32,000 acres planted with hops at the end of the last century. Since that time the extent of the acreage has been very much extended, and it is estimated that there are at this time over 70,000 acres of hop-land in England.\* The agricultural returns of Great Britain for 1877 show that there were 71,239 acres in that year as against 69,999 acres in 1876. Before the duty was taken off, in 1862, there were great fluctuations in the hop acreage. After successive heavy crops, when prices were low, and the payment of the duty pressed heavily upon the hop-growers, important reductions were made in the number of acres. After short crops, when prices were remunerative, many acres were planted. For example, between 1820 and 1823, nearly 10,000 acres of hop-land were grubbed, as there had been five heavy crops in succession. In 1837 there were 56,000 acres, and in 1840 only 44,000 acres of hop-land in England. In 1855 the acreage had been increased to 57,000 acres; but it was reduced again to 45,000 acres in 1859, in consequence of a series of very large crops. Since the duty has been repealed

Acreage of hop-land since 1750: its fluctuation since that date.

\* There are no hops cultivated in Wales nor in Scotland.

the acreage has been gradually added to year by year, with comparatively few exceptions.

The counties in which hops are chiefly cultivated.

Kent has the largest acreage.

The counties of England in which hops are principally grown are Kent, Sussex, Surrey, Hampshire, Worcestershire, and Herefordshire. There are a few acres in Nottinghamshire, Shropshire, Essex, Suffolk, and Gloucestershire; but the great part of the hop plantation is in the first-named six counties. Of these, Kent, in which county hops were first grown in England, has by far the largest acreage. According to the 'Agricultural Returns,' there were 45,984 acres of hop-land in Kent in 1877, as against 44,755 acres in the previous year. The county of Sussex ranks next to Kent, having 11,057 acres in 1877, showing a slight decrease of 118 acres from the returns of 1876. In Herefordshire, Hampshire, Worcestershire, and Surrey, there were, respectively, 5839, 3156, 2329, and 2536 acres in 1877. Kent hops—more especially Kent Goldings, whose strobiles are small, of a delicate colour, and abounding in lupulin—are considered the best, and command the highest prices, being most highly esteemed by the brewers for pale ales, as well as for ales for exportation; and Goldings grown in East Kent are preferred to those produced in the middle part of Kent, which, in their turn, rank higher than those grown in other districts; though Farnham Goldings are particularly choice, and have a reputation among the brewers in the western part of England somewhat similar to that of the famous hops grown within the limits of the Bavarian town of Späلت, or of those produced near Saatz in Bohemia.

The geological formation upon which the hop-plant thrives in Kent.

Great age of hop-grounds in Kent.

Hops are grown in Kent chiefly upon the loams and clay loams of the Hythe Beds and the Sandgate Beds of the Lower Greensand formation, which soils are especially suited to their growth; as well as upon the Thanet Beds and Woolwich Beds, and the deeper soils superimposed upon the chalk in the eastern part of the county. Upon the beds of the Lower Greensand formation, many of the hop-grounds are over 100 years old, and in a few instances much older than this. In these old grounds there is a certain percentage of dead plants, which are renewed each year. In the Weald of Kent, the various soils of the heavy Wealden Clay, of the Wadhurst Clay, and of the Tunbridge Wells Sand, are well suited to the growth of the coarser kinds of hops, and yield much larger crops than the other soils of this county, though the value of the produce is 20 per cent. under that of the East and Mid Kent hops. Grapes, Jones', and Colegates are the sorts of hops usually grown here. The two first named are coarse hardy sorts with large strobiles. Colegates are very prolific and hardy and less liable to blight and mould than other sorts, having strobiles smaller than Goldings, with a somewhat rank flavour not unlike that of some American hops.



The quantity of hops grown per acre in the plantations of Sussex is also very large in favourable seasons. The soil upon which they are grown is a tenacious clay on the Wadhurst Clay, Weald Clay, and Ashdown Sand strata, of the Lower Cretaceous formation, which prevails in the eastern part of the county, where the hops are chiefly cultivated. From 15 to 20 years is the average duration of hop-grounds in Sussex and the Weald of Kent; the plants do not last so long upon the heavy clays of these districts as on the "rock" of the Greensand formation.

In the counties of Worcestershire and Herefordshire hops are cultivated principally upon the deep rich alluvium in the valleys of the rivers Severn, Teme, Wye, Lugg, and Froome; and upon the marls, loams, and clays of the Old and New Red Sandstone formation. The sorts that are principally cultivated are White Mathons, Cooper's Whites, Goldings, and Mayfield Grapes, all of which, when well grown and well managed, are much approved by the brewers in the larger towns of the Midland Counties, who buy the greater part of the hops produced in this district.

Upon the eastern side of Surrey, and upon the western side of the bordering county of Hampshire, the hop-plantations are situated mainly upon the clay and loamy soils of the Gault and Upper Greensand which crop up there. There is a peculiar productive clay soil of the latter formation which is found in this district, and is locally termed "malm," upon which, as at Farnham, for instance, hops of rare quality are grown. The hop-plant lasts a long while in this locality, and there are hop-grounds near Farnham almost as old as the oldest in Kent. Williams' Whitebines, Goldings, Greenbines, and Golding Clusters, are the sorts usually cultivated in Surrey and Hampshire. Besides those enumerated above, there are various sorts of early hops which are ready for picking from a fortnight to a week before those that constitute the ordinary crop. Many of these have been obtained by a process of selection, from cuttings taken from certain plants that have been observed to differ from their congeners in certain characteristics. The Bramblings, and White's Early Goldings, are choice early hops, which have been much grown in Kent during the last ten years, and which are ready to pick about ten days before Goldings and Grapes. There are other kinds, as Prolifics, which are ready a few days earlier still.

In the chief hop-producing localities each farm has a certain proportion of hop-land upon it, which, in most cases, tenants are bound by covenants in their leases or agreements to maintain in "full plant." In a few instances farms consist entirely of hop-land; for example, near Maidstone, in Mid Kent, there

Hops grown upon the Gault and Greensand in Surrey and Hants.

Extent of hop-farms.

is a farm of over 300 acres almost "in a ring fence," the whole of which, with the exception of four or five acres of lucerne for the horses, is planted with hops. A few planters in Mid and East Kent, where the average number of acres of hop-land held by single individuals is greater than in any other part of England, hold from 180 to 350 acres of hop-land. Many hold from 80 to 120 acres, and many more from 40 to 80 acres, and the average extent of the holdings in these districts may be put at 50 acres per planter. These holdings are smaller in the Weald of Kent and in Sussex than in other places. Here and there leviathans may be found who have 80 or 90 acres, but the average can hardly be put higher than 20 acres. Hop-land in Hampshire, Surrey, Worcester, and Hereford, is also distributed among many individuals. In the former counties 100 acres, and in the latter 80 acres, form the maximum holdings of planters.

With regard to the cultivation and management of hops, the details are practically the same in principle throughout the kingdom, and it will be convenient to describe the usual methods, alluding only to important differences where these occur.

Mode of cultivation.

The land, before it is planted with hops, either is ploughed as deeply as possible, with a subsoiling machine following the plough to break up and disintegrate the hard bottom; or it is trenched—that is, it is dug by hand "two spits" deep, or to the depth of two spades, which is a more costly operation. The plants are generally set at a distance of 6 feet 6 inches between each "hill" or plant centre, which would give 1030 hills to the acre. In some cases there are 1200, and even as many as 1400 hills to an acre; but experience has shown that quite as many hops can be grown with a plant of 1030 hills to the acre as with a larger number of hills. With the lesser number of hills the expenses of poling, dressing, tying, and hand-hoeing are also less. More room is obtained to cultivate between the rows, and the air and heat of the sun permeate more thoroughly among the plants. The hop-plants are invariably raised from "sets"—cuttings taken from the hills when they are dressed or cut in the early spring-time.\* These are put into a nursery until the following autumn, by which time, if they have been carefully attended to, they have good roots and are fit for planting. Two † good sets are considered enough to form a hill or plant centre. Sets sell at from 3s. to 15s. per 100; the average price bring about 5s. A small stake is put to each hill the first year to pro-

\* Hop-plants raised from seed cannot be depended upon, on account of the strong tendency to reversion to the wild type. Being dioecious, fertilisation is probably effected frequently by the pollen from wild plants, which is prepotent over that of the cultivated varieties.

† One good well-rooted set, in good soil, will make as good a stock as two or more, but it is safer to put two in for fear of wireworms.

tect the young plants. Occasionally hops are produced in the first year if the plants are stimulated by large applications of manure, or if the land is in high condition; but it is better that they should not bear until the second year. Most of the hop-land in England is dug in the autumn and winter by men who use a "spud," which is a three-pronged fork with broad points, and is peculiar to the hop districts, at a cost of from 18s. to 24s. per acre.

Ploughing is adopted by some growers, and is done with a small plough drawn by horses in the alleys, between the rows of plants that are clear of the lines of poles stacked for the winter, which look

like wigwams; the spaces between these stacks, as well as between the hills at right angles with the plough-line, are dug by hand. This costs as much as digging, and is only resorted to when the work is behindhand, or when labourers are scarce. A machine expressly suited for digging hop-land has been recently invented by Mr. Knight, of Farnham. This machine consists of a frame upon four wheels; those in the front, which are smaller than the wheels behind, taking a portion of the weight, but being chiefly used for steerage purposes. The wheels behind carry the greater share of the weight and propel the machine, being driven by an upright shaft set in motion by a grooved, horizontal driving-wheel, connected with a 6-horse portable engine by a high-speed cord running on pulleys. The digging is performed by a series of forks like "spuds," fixed to vertical rods that are fastened upon a crank-shaft of three throws, in connection with the driving-shaft. By the action of these forks, the movement of the human arm using a spade is admirably imitated, and the soil is well moved and disintegrated by them. About 4 acres a day can be dug by this machine, at a cost of from 12s. to 15s. per acre, according to the estimate of the inventor. At their Show at Wolverhampton in 1871, the Council of the Royal Agricultural Society of England offered a prize for the best hop-digging machine to supersede manual labour on hop-land, but this prize was not awarded as there was no implement in the competition that possessed sufficient merit.

In the early spring season the hop-plants are dressed directly the soil is dry enough to work. All the old bines and fibrous growth\* of the previous year are cut away, and the hills are

Hop-digging machine.

Dressing and poling.

Fig. 1.—The Spud.

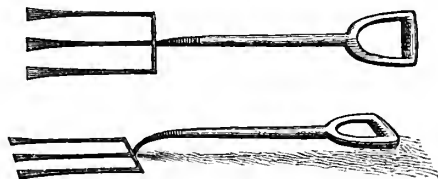

\* "Sets" from which plants are raised are taken from this fibrous growth, which is encouraged by those who wish to have good "cut" sets, by earthing the hills in the autumn, or covering them with earth.

covered over with a little fine earth. Poling is done directly after this, and is usually finished by the beginning of the last week in April. When the poles have been set up, the ground between the rows is cultivated deeply with harrows (drawn by one or two horses), called nidgetts, with one wheel and handles, and with broad duck-footed tines; and the space round the hills is dug by hand and hoed with plate and pronged hoes to destroy the weeds and to break the surface. Poling is performed by men who make the holes with a short iron pitcher, and thrust the well-sharpened poles firmly to the end of the holes by one strenuous, well-directed effort. Two, three, and even four poles are put to each hill, varying in size from 10 feet to 18 feet in length according to the sorts of hops and the quality of the soil. The poles are set up so that each one may overshadow the others as little as possible. In the best hop-grounds of Kent two or three poles, 16 feet long, are usually put to Goldings and Colegates. Grape hops are generally poled with three poles 12 feet in length; and Jones' have three or four poles from 10 to 12 feet in length. Hop-growers in Hants and Surrey use poles 16 feet long for Goldings, and even 18 feet long in the famous "malm" district. They use poles 14, 12, and 10 feet in length for Whitebines, Greenbines, and Jones'.

Woodlands in Kent and Sussex produce hop-poles.

Poles from 14 to 16 feet long are put to Goldings in Herefordshire and Worcestershire, and from 10 to 14 feet to the other sorts of hops grown there. Most of the hop-land upon the heavy clays of Sussex and the Weald of Kent is poled with short poles varying from 10 to 12 feet in length. A great proportion of the woodlands of Kent and Sussex is devoted to the growth of poles for hops, and great attention is paid to their management. In the best of the woodlands, which are called plantations, where the stocks or stubs—chiefly of oak and chestnut—are set in equidistant rows, the fall occurs every eighth or ninth year and is worth from 40*l.* to 65*l.* per acre.\* There are also some very good woodlands in Hampshire, whose fall occurs every ten or eleven years and is worth from 40*l.* to 50*l.* per acre. Fir poles are also largely grown upon land in Hampshire which was formerly waste and desolate heath. Herefordshire and Worcestershire hop-growers get poles from Wales and from the bordering counties. Very useful poles are grown in the large woods of Sussex. These are of slow growth and are therefore more durable than quickly grown poles. Extensive fir plantations have been made in Sussex upon reclaimed moor and wild forest land, which are ready to cut in about twelve or fourteen years, and bring from 50*l.* to 75*l.* per acre. Ash and chestnut are by

\* An acre of really good plantation yields about 1000 16-foot poles; 1500 14-foot poles; 1000 12-foot poles; 500 10 or 11-foot poles; and 200 poles too stout for hops.

far the most durable poles, and are chiefly grown in the plantations. Ash, chestnut, maple, hazel, beech, alder, birch, willow, and oak poles are yielded indiscriminately by the old woods. Many fir poles are imported from Belgium and Norway and make high prices. The practice of dipping about 2 feet of the ends of hop-poles in creosote is now almost universal. This makes them last very much longer, especially the common sorts, such as alder, beech, birch, willow, and hazel. They are put into iron tanks filled with creosote heated to about 170° Fahr. and allowed to remain for twenty-four hours.\* From 50*l.* to 80*l.* is the first cost of supplying an acre of land planted with Gold-  
 ing hops, and from 35*l.* to 65*l.* per acre in the case of other sorts of hops. About 6 per cent. of the large poles that have been duly creosoted require renewal each year, and 9 per cent. of the smaller poles, taking an average of the various sorts and seasons.† The system of putting upright poles to hop-plants commonly prevails in this country. Several other methods, however, are adopted to a small extent in various districts. Among these, the "Vinery" system is perhaps the best, which consists of placing two permanent, creosoted, upright poles to each hill, to which movable poles are fastened in the manner shown in the illustration appended, Fig. 2.

Creosoting hop-poles.

Cost of poles per acre.

The Vinery method of poling.

Fig. 2.—Mr. Coley's Vinery System of Poling Hops.

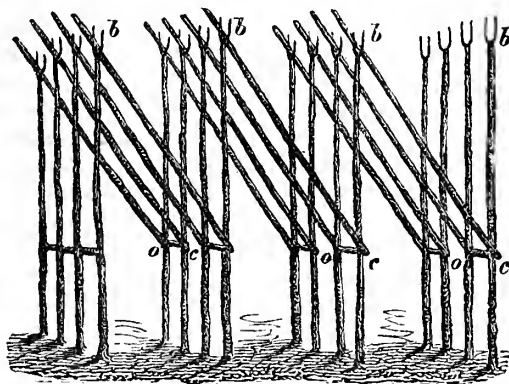

Mr. Farmar, of Tenbury, and Mr. Bomford, of Evesham, Worcester, have patented systems of training hop-plants upon vertical  
 System of training upon wires.

\* See account of process of creosoting hop-poles in the 'Journal of the Royal Agricultural Society,' vol. vi., 2nd series, p. 345, by which it is shown that the saving in poles effected by creosoting them is from 40 to 45 per cent.

† In very fruitful seasons when there is a great quantity of bine and leaves many poles break with the weight, and in windy seasons the loss is also great.



wires stretched horizontally between stout posts, like telegraph posts. There are other arrangements of vertical and horizontal wires like those that are so much used in all parts of Germany,\* but they have not as yet been largely adopted by the hop-planters of England. All these patent systems have great advantages in windy weather over the old-fashioned plan of using upright poles. Their first cost is greater, but the cost of yearly maintenance is not nearly so great. Mr. Coley's method costs from 70*l.* to 90*l.* per acre, and about 2*l.* per acre per annum for maintaining it.

Tying hop-bines performed by women.

Tying the hop-bines to the poles is almost invariably done by women, who fasten two or three of the best to each pole with rushes or strips of matting, taking care not to tie the knots too tightly. Many planters send men to pull out the coarser and ranker or "pipy" bines before the women begin to tie, as these are held to be less productive than the finer shoots. After the bines get too high for the women to reach, they are provided with light folding-ladders to enable them to fasten in their places recalcitrant leading shoots, which the wind has prevented from getting to the poles in their ordinary manner by means of their "normal axial twistings," and the independent revolutions of each internode.†

Ladder tying.

Large quantities of manure necessary.

Hop-plants require an immense amount of manure, as has been proved by practical experiments and demonstrated by the scientific investigations of Messrs. Payen, Voelcker, Nesbit, and Way. They are usually manured with from 15 to 20 tons of farm-yard-manure made with animals fed on oilcake and corn, at a cost of from 6*l.* 10*s.* to 9*l.* per acre. Waste from furriers' shops, shoddy from cloth manufactories, woollen rags, and other bulky manures, are applied in the winter season. Lighter manures of quicker action, such as rape-cake finely ground, guano, well-made highly concentrated farmyard-manure, nitrate of soda, and superphosphate of lime, are dug in with the spud, or chopped in with the pronged hoe round the hills in the spring and early summer, at a cost of from 3*l.* to 5*l.* per acre; and it frequently happens that the manure put upon an acre of hops, in one year, has cost 13*l.*

Kinds and cost of manure.

Implement for working hop-land.

The land is deeply cultivated with nidgetts (Fig. 3) until July, so that there is a depth of 7 or 8 inches of finely triturated earth throughout. Experienced planters think it unadvisable to move the land deeply when the innumerable fibres sent out from the roots are traversing the soil, just under the surface, in search of

\* In a pamphlet styled 'Der Hopfenbau,' written by F. Wirth, a large hop-planter at Kaltenberg, in Würtemberg, six different methods of using wire instead of poles are elaborately explained and illustrated.

† A description of this curious habit of the hop-plant is given in a work by Mr. Darwin, 'On the Movements and Habits of Climbing Plants,' who says, "The purpose of this spontaneous revolving movement, successively directed to all parts of the compass, is obviously to favour the shoot finding a support."



food, which they assimilate and convey to the plants.\* At this time the earth is lightly skimmed with the nidgetts to kill the seedling weeds, and the hills are hoed round with plate-hoes.

Fig. 3.—The new Iron Nidgett.

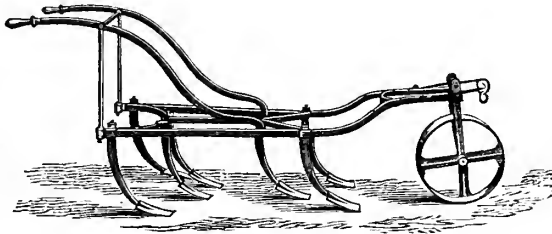

Late white frosts in the spring are frequently as injurious to the young hop-bines, as they are to the tender vine-shoots in the French vineyards. Early dressing or cutting is not, therefore, generally practised, as hop-shoots injured by frost are not only stunted in their growth, but are more liable to be attacked by aphides, which are nearly as much dreaded by English planters as the destructive phylloxera by the French and German wine-growers. Enormous losses have been caused by these aphides, which have in some years reduced in a few weeks a crop, estimated at 8 or 10 cwts. per acre, to a miserable return of 1 cwt. per acre. This occurred in 1854, in 1860, and in 1869, generally; in Herefordshire and Worcestershire in 1876, and in 1877 in parts of Kent. Syringing the leaves and branches carefully with soft-soap and water and a little tobacco-juice is the only remedy against these insects, dislodging the winged aphides, the first progenitors, destroying the lice that are reproduced by gemmation in countless generations, and cleansing the leaves of their excreta, known as "honey-dew." † This is a costly and troublesome process; but it has well repaid planters in some seasons, who have had it carried out thoroughly. ‡ Many other insects do much mischief to hop-plants, especially wireworms (*Elatér lineatus*), fleas (*Haltica*), jumpers (*Tettigonia*); and in hot seasons red spiders (*Acarus Telarius*) are infinitely destructive. Pieces of mangold or potato are put round the hills as traps for the wire-

White frosts injurious to the tender plants.

Aphis-blight: remedy for it.

Insect foes.

\* There are planters, however, who maintain that it is right to cultivate deeply when the fibres are running, and think it is beneficial to tear them up wholesale, so that bushels of these rootlets may be seen where the nidgetts are cleared.

† Syringing proved comparatively inefficacious in this last season, when aphis-blight ravaged the plantations of East and Mid Kent.

‡ This is done with garden engines with double hose, worked between the rows of hops by three men, two of whom direct the hose to the plants, while one pumps. 28 lbs. of soap and  $\frac{1}{2}$  lb. of tobacco are used with 100 gallons of water, and the expense of one washing is about 2l. 2s. per acre.

Mould or white  
blight checked  
by sulphur.

worms. Fleas and jumpers are caught by shaking the hop-poles violently, and holding boards covered with tar so that the insects jump into it. Nothing has as yet been devised to check the ravages of the red spider; but nature frequently does this by heavy showers of rain. Mould, occasioned by the fungus *Sporotheca Castagnei*, allied to the fungus that causes the vine-disease known commonly as oïdium, was formerly terribly injurious to hop-plants, but, like its ally, has been checked to a great extent by the application of sulphur put on usually before the hops are in "burr" or bloom, with a machine called a sulphurator, drawn by a horse between the rows of plants, an illustration of which is given below (Fig. 4). Two separate applications of sulphur are usually made; the first when the bine is just over the poles, the second just before the "burr" or bloom appears. About 50 lbs. per acre is put on at each application, at a cost of about 15s. per acre each time.

Sulphuring  
machines.

Fig. 4.—The Sulphurator.

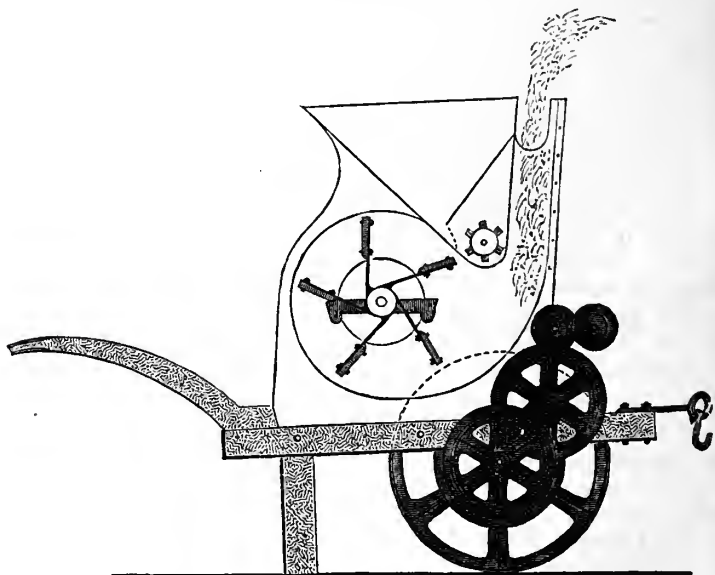

Hop-harvest.

The hop-harvest commences in the latter part of August and lasts about three weeks. Hops are ready for picking when the strobiles are quite closed up, and the seeds are firm and dark-coloured. Pickers come in great numbers from London to the hop-growing districts of Kent and Sussex.\* A Return made by the Chief

\* There are permanent sheds erected on nearly all hop-farms for the hop-pickers to sleep in. Some are extemporised with thatched hurdles. The sanitary

Constable of Kent shows that 99,670 immigrants were employed in picking hops in Kent alone, in 1876. In Herefordshire and Worcestershire, many pickers come from the neighbouring large towns, and from Manchester, Wolverhampton, and the mining districts. A planter in Kent having 50 acres of hop-land requires from 140 to 150 pickers, besides those living under him. One who has 100 acres requires 300 "strangers," and so on. In some instances, individual planters employ over 1000 immigrants, who require as much marshalling and management as a small army. The pickers are distributed in gangs or "companies" of ten. Each company is under a ganger or "binman," who pulls down the poles, helps to measure the hops picked, and takes them to the waggons. The various grounds or "gardens" are divided into small portions called "sets" at picking-time, and each company takes one of these sets. Hop-picking is very popular with the denizens of smoky towns, as the aroma of hops is supposed to be conducive to health, and good wages can be gained. From  $1\frac{1}{2}d.$  to  $2\frac{1}{2}d.$  per bushel, weighing about 7 lbs., is paid for picking hops. Good pickers will earn from 3s. 6d. to 4s. 6d. per day. Hops are picked into long wooden frames with sacking bottoms; and in some places, as in East Kent, into baskets. They are taken in "pokes," or long bags of thin sacking, holding 10 bushels, to the oast-houses, where they are dried in kilns, upon horsehair-cloth stretched upon a flooring of stout laths, about 13 feet from the ground. In the circular or square chambers below this floor there are either open or enclosed stoves, in which anthracite coal, coke, and charcoal are burned. When hops are drying it is usual to burn a little sulphur—the best yellow sulphur in rolls being used for this—upon the fire, so that its fumes may pass through them when evaporation is at its highest point. The sulphurous acid evolved by the sulphur bleaches the leaves of the reeking hops, and imparts to them a golden colour. About 10 lbs. of sulphur are burned for 300 bushels of green hops. If hops are much discoloured, sulphur fumes are passed through them twice while they are drying. Hops are dried in 11 or 12 hours, and are subjected to a heat of about  $130^{\circ}$  Fahr. An oast-house is built generally with several kilns, either square or circular, in a group; and upon the same level as that of the drying-room—the "hair-level"—as shown in the accompanying illustration of a kiln (Fig. 5); a cooling-room of suitable size is attached. The hops are left in these rooms for a short time, and are packed by a machine into pockets, or long bags of canvas of stout texture, holding from  $1\frac{1}{2}$  to  $1\frac{3}{4}$  cwts., or

Immigrants  
pick the hops  
in Kent.

Prices paid for  
picking hops.

Sulphur used  
to bleach the  
hops.

Drying pro-  
cess.

authorities are now insisting that the accommodation for these immigrants shall be decent, and proper in a sanitary point of view.

by men treading them in with their feet, though this laborious process is being fast superseded by the pressing-machine.\* In the Farnham district of Hampshire, and in some other localities, the dried hops are allowed to accumulate, and remain piled up several days before they are packed. This practice entails a large amount of cooling room, and could not for this reason be adopted by large growers, though it is far better for the hops, which do not crumble nor lose their farina. It would also be far better to dry hops more slowly at a considerably lower temperature, say 100° Fahr.; but this would entail a much larger amount of kiln accommodation, and a consequent increased outlay of capital, which but few landlords would consent to make, and which it would not pay ordinary tenants to take upon themselves. For 50 acres of hop-land the requisite and proper buildings for drying and packing, according to the present system, would cost at least 1500*l.*, putting at once an increased rental of 1*l.* 10*s.* per acre upon the tenant at a low computation of 5 per cent. per annum upon the landlord's outlay.

Fig. 5.—Section of a Kiln with an inner Chamber.

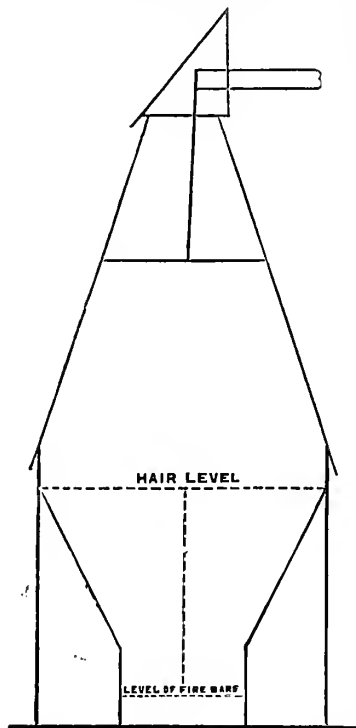

Hops dried too quickly on account of insufficient kiln accommodation.

Modes of sale.

After the hops are packed they are in most cases sent at once to the warehouses of the factors or commission agents in London, as but few planters have store-rooms fit to keep hops in, which require storing in dry well-ventilated places. A sample of about half a pound is taken from the centre of each pocket, and the factor sells the bulk by these samples to the hop-merchants, who forthwith move the hops to their own warehouses, and sell them to the brewers as they require them. It is quite excep-

\* Pressing-machines, which are worked easily by one man, cost about 27*l.* By these the hops are packed quickly, and in an unbroken state, and workmen are relieved from work that is most laborious and injurious to health. Hops are packed while hot by these machines. If they are to be trodden by men they must be cooled for twelve hours, or they would be trodden into powder.

tional for brewers to buy directly of the planters or of the factors. A time-honoured custom still prevails among the Hampshire and Surrey planters of sending many pockets of hops, piled up upon waggons, to a large fair at Weyhill, in Hampshire, to represent their growths. About 10 per cent. of a growth is sent in this way, and the pockets are pitched in barns upon the fair ground.

The price of hops fluctuates very much, and the values of various sorts differ considerably. East Kent, Farnham, and Mid Kent Goldings, as a rule, make from 10 to 20 per cent. more than any other kinds. Weald of Kent and Sussex hops, in most seasons, make the lowest figures.

Price varies according to sorts.

Until 1860 a duty of nearly 18s. per cwt. was levied upon all hops grown in the United Kingdom. The duty on foreign hops, which was 8l. 8s. per cwt. until 1842, then 4l. 5s., 2l. 5s., and finally 15s., was abolished in 1862; and since that date the im-

No home nor foreign duty now.

portations have largely increased, and have injuriously affected the value of British hops. Taking the seven years from 1855 to 1861 immediately preceding the abolition of the foreign duty, the average price of hops was 7l. per cwt., and the average annual yield was 470,000 cwts. In the septennial period immediately following, the average price of hops was only about 8l. per cwt., though the average annual production was under 400,000 cwts., and the consumption of beer had steadily increased. The highest price of hops upon record is 27l. in 1817. The lowest is 2l. 15s. in 1848, after a long series of large crops. It is calculated that the quantity of hops used for brewing in the United Kingdom is from 600,000 to 650,000 cwts., and that the average quantity grown in this country for the last 15 years has been about 450,000 cwts., while the imports of hops from all countries into the Kingdom have averaged about 170,000 cwts. per annum in the same period, of which amount only 2021 cwts. came from France in 1876, and 3862 cwts. in 1875. The quantity of hops exported from England is of comparatively trifling amount, having averaged only about 18,000 cwts. per annum during the last ten years. An average annual quantity of about 6000 cwts. of foreign hops has been re-exported from England in the last decade. It is computed that the annual average yield from each acre of hop-land in England, during the last 100 years, has been very nearly 6½ cwts. per acre, and that the price of English hops has averaged about 7l. per cwt., taking the past 30 years. For each acre of hop-land, 45l. of working capital is essential, taking the average of all the various districts. Actual expenses connected with hop-growing, inclusive of rent, tithes,\*

Quantity used in Great Britain.

Exportation small.

\* Hop-land, like fruit and market-garden land, is chargeable with an extraordinary tithe besides the ordinary charge.



Rental of hop-land.

taxes, interest on capital, cultivation, amount to at least 22*l.* per acre, exclusive of the cost of packing, drying, and other incidental expenses, which varies according to the amount of the crop grown, whose average may, however, be put at 13*l.* per acre per annum; making the total annual average cost of hop-land amount to 35*l.* per acre. Rents range from 2*l.* to 10*l.* per acre, and 4*l.* is about the average rental of English hop-land. For land in East Kent, Mid Kent, and Farnham, the highest rentals are paid, and the lowest in Sussex. Profits are occasionally very large, amounting to 100*l.* per acre per annum upon land that is especially suited for hop-growing.\* As has been shown, the risks are very great, and the expenses are enormous and are increasing year by year; and it will be seen, from an examination of the figures given above, that the average profit upon each acre of hop-land in England, in the last 30 years, has not amounted to much over 10*l.* per acre per annum. This profit has not by any means been equally distributed among the planters. In some instances very much more profit has been made; in others very much less. In some districts the hop-plants are more liable to be blighted than in others, and in most districts there are "lucky" farms, upon which the aphis-blight, or mould, rarely affects the plants. A hedge or a stream frequently forms a line of demarcation between hop-land that is liable to blight and that which escapes blight. It seems probable that the profits of hop-growing will be diminished in this country in the future, by reason of the large importations from America, Belgium and Holland, France and Germany, and the ever-increasing expenditure in connection with their cultivation.

Lucky farms.

---

## CHAPTER II.

### FRUIT.

Fruit extensively grown for over 300 years.

FRUIT has been extensively grown in Great Britain, at least in England and Wales, for more than 300 years. Although such fruit as apples, cherries, and pears had been cultivated long before the sixteenth century in many parts of the kingdom, a great stimulus was given to fruit-growing by one Richard Harris, the gardener of King Henry VIII., who encouraged the planting of rare kinds of fruit-trees and bushes, which he had

---

\* A north-west or north-east aspect is generally held to be the best situation for hop-growing, as the sun does not in that case shine directly upon the plants wet with hoar-frost or dew.



obtained from foreign countries. For example, he introduced several sorts of cherries into Kent from Flanders, and it is a popular notion that these were the first cherries grown in England; whereas this fruit was introduced many centuries before by the Romans. It is believed that the apple is indigenous to Britain, as mention is made of it in the very earliest records; and charters and grants of land in the twelfth century, in which orchards are specially mentioned, prove that apples were cultivated in many parts of the country at that date.

The apple indigenous to Britain.

The cultivation of fruit has made rapid strides during the last quarter of a century, both as regards extent of acreage and improvements in management. According to the Agricultural Returns of Great Britain for the year 1877, the total number of acres of fruit-land, including orchards with grass under the fruit-trees, and cultivated fruit-land, was 163,290, apportioned as follows:—

Acreage of fruit-land in Great Britain in 1877.

	Acres.
England .. .. .	159,095
Wales .. .. .	2,619
Scotland .. .. .	1,576

In 1876 there were 157,287 acres of fruit-land in Great Britain, apportioned as follows:—

	Acres.
England .. .. .	153,277
Wales .. .. .	2,600
Scotland .. .. .	1,410

These Returns show an increase of 6003 acres in one year, chiefly in England; and those of the four preceding years show a correspondingly large addition to the acreage in this country, which has been made principally in the counties near London, whose soil is suited to the growth of fruit, on account of the propinquity to the London markets; as well as in those counties where apples and pears are grown upon grass-land, in Devonshire, Somersetshire, Herefordshire, Worcestershire, and Gloucestershire.

Large increase in the acreage during the last four years.

On account of the increased cost of labour, horses, and all other items of expense connected with arable land, much of this has been lately laid down to grass, and fruit-trees have been planted where the soil and climate are suitable. The profits of corn-farming, pure and simple, are very small; at the same time the average value of land is gradually increasing, because its quantity is out of all proportion to the population of the country, and to the desire and ability to possess it. From this it has followed that already, to a certain extent, land has been laid down with grass, planted with fruit-trees or bushes, cultivated as market-garden land, and in other exceptional ways. British agriculture

is in a transitional state, passing from the production of necessaries, such as wheat, which other counties can supply more cheaply, to the production of meat, milk, fruit, vegetables, and luxuries which a dense, well-to-do population can afford to pay for. It is a natural consequence that the cultivation of fruit should have largely increased of late; and it is certain that there will be a still greater development of this industry in the immediate future.

Two distinct systems of cultivation.

Fruit is grown principally upon two systems:—First. Upon grass-land planted with standard fruit-trees, such as apples, pears, cherries, plums, and damsons. Second. Upon land that is regularly cultivated between the rows of various kinds of fruit-trees or fruit-bushes.

First system, or growing fruit upon grass-land, and acreage of counties where adopted.

The first method is chiefly adopted in the English counties of Herefordshire, Devonshire, Somersetshire, Worcestershire, and Gloucestershire; where apples and pears are very largely cultivated for the manufacture of cider and perry, as well as for culinary purposes, and for eating.

The acreage of fruit-land in each of these counties in 1877 was—

	Acres.
Herefordshire .. .. .	24,885
Devonshire .. .. .	24,776
Somersetshire .. .. .	20,921
Worcestershire .. .. .	14,621
Gloucestershire .. .. .	11,965

In the two last-named counties, a part of the acreage of fruit-land is cultivated upon the second system, to be noticed in due order.

Apple and pear orchards in Herefordshire.

In Herefordshire the apple and pear orchards are mainly situated upon the rich alluvial deposits in the valleys of the many rivers that run through the county, as the Severn, the Lugg, and the Froome, and upon the loam and clay soils of the Old Red Sandstone formation. A large part of this orchard-land has been planted for very many years, the trees having been renewed as they died away, in some cases with tolerable regularity, in many cases with much irregularity. Many of the orchards that have been planted lately have been formed by putting the trees in hop-gardens between the rows of hop-plants. When the trees get large and bear fruit, the hop-plants are taken away and the land is laid down with grass. Land that is suitable for hops is also suitable for apples in most cases,\* and a southern aspect is considered the best situation for orchards and hop-land in Herefordshire. Grass under fruit-trees is usually fed off by sheep and cattle in that county. In a few instances it is mown; but this practice is much to be

\* Chemically there is great similarity between the ashes of hops and apples, in the constituents of potash, silicic acid, and magnesia especially.

depreciated. Manure, either farm-yard or artificial, containing potash, soda, and phosphatic elements, is applied by the best managers every fourth or fifth year.

Apple-trees are usually raised in Herefordshire, as in all other parts of Great Britain, either from crab, or wild-apple, stocks, which are preferred generally, or from stocks raised from apple-pips. The stocks are put in a nursery and are grafted with the sort desired in about three years, and are ready for planting out when they are four or five years old, and 6 feet high.\* The plants are carefully planted at distances varying from 30 to 36 feet apart, giving from 48 to 33 trees per acre, and are well fenced round to protect them from cattle. They are, or should be, lightly pruned each autumn. Apple-trees which grow fruit for cider-making do not require so much pruning as those which grow table-fruit. It may be said here that not nearly enough attention is paid to the pruning of apple-trees generally throughout the country, and that they have been systematically neglected in this respect, as their appearance indicates. The chief sorts of apples grown for cider are the Foxwhelp, Red Cowarne, Hagloe Crab, Codlin, Brandy Apple, Cockagee, Styre, French Upright. For eating,—the Ribston, Golden, and King Pippins, Cox's Orange Pippin, Margel, Court-Pendû-Plat, Court of Wick, Blenheim Orange. For cooking,—Joanetting, Keswick Codlin, Wellington, Lord Suffield, Tower of Glamis, Alfreton, Collins.

Pears are raised upon grafted wild stocks or from grafted stocks raised from pips, and occasionally from grafted quince stocks; and are cultivated like apple-trees. Pear-trees do not require so much pruning as apple-trees. The principal pears grown for making perry are the Barland, Huffcap, Taynton Squash, and Oldfield; and for eating,—the Doyenné d'Été, Beurré de Capiaumont, Chaumontel, Cattilac, Williams' Bon Chrétien, Beurré Bosc, Beurré Diel, Bergamot, Duchess d'Angoulême, and Marie Louise.

From 9*l.* to 14*l.* is the cost of planting an acre of land with apple-trees and pear-trees, and the annual cost afterwards for maintenance, manure, and pruning amounts to from 2*l.* to 5*l.* per acre per annum. Rents of orchard-land in Herefordshire vary from 2*l.* to 6*l.* per acre, according to its quality; the average annual return from the fruit-trees, exclusive of the grass underneath, may be set at 10*l.* per acre. As much as 50*l.* per acre is occasionally made in exceptional seasons upon the very best land.

Before railway communication was opened up between Herefordshire and the large towns of the Northern and Midland

Sorts of apples and pears usually cultivated in Great Britain.

Cost of planting, rents of land, returns.

Cider and perry.

\* Raising sorts of apples directly from pips, or seeds, is a most haphazard process; the plants in most cases revert back to their wild type, wholly or in degree.

Counties, apples and pears were principally grown for cider and perry, for local consumption. Each farm had orchard-land enough to supply its own labourers with cider, which they drank, and still drink, in enormous quantities. Since then more attention has been paid to the management of the orchards, large additions have been made to the acreage, and more care has been taken in the selection of good sorts of apples and pears that are handsome, and well flavoured for eating and cooking, to supply the large demand for fruit in the manufacturing towns. Much improvement has also taken place in the manufacture of cider and perry, which has now an extensive sale in many parts of England.

Apples for cider are laid in heaps for some days to make them quite ripe or "mellow," and to cause chemical changes necessary to ensure good cider, especially the decrease of vegetable gluten, the presence of which causes undue fermentation. When mellow, the apples are crushed by stone rollers, the pulp is put into a press in horsehair bags, and the juice is squeezed out and put into casks, where it is fermented and racked off the lees into other casks in due time. For making sweet cider or cider for bottling, the pulp is not squeezed until several hours after it has been ground, fermentation is carefully watched, and racking frequently done. Coarse brown sugar is sometimes added, and the colour is heightened, according to fancy, by the addition of extract of logwood. The average price of cider is about 2*l.* 5*s.* per hogshead, and the average return of cider per acre may be put at 8 hogsheads. Perry is made in the same manner as cider, only that the fruit is pressed as soon as it comes from the trees.

Apple-orchards form the chief part of the fruit-land of Devonshire and Somersetshire.

Coming next to Devonshire and Somersetshire, with their large acreages of fruit-land, it will be found that apple-orchards form the chief part of it, and that the remarks that have been made with regard to Herefordshire apply generally to these counties. Cider is largely made, and is sent to all parts of the kingdom.\* Eating-apples are grown in the best orchards, and a great improvement has recently taken place in the management of the land. Orchards in Devonshire are situated for the most part in the southern division of the county, upon the Old Red Sandstone formation, in the South Hams district, and in the fertile valleys by the rivers Dart and Erme. In Somersetshire the principal fruit-area is in the northern part of the county, under the Mendip range of hills, and in the centre, in the rich vale of the Tone. The rent of land varies from 3*l.* 10*s.* to 9*l.* per acre, and 9 hogsheads of cider per acre represents the average

---

\* Devonshire cider is considered the best that is made in England. It is bottled to a large extent and sent to all parts of the country.

produce of orchards in full bearing. Cider is worth nearly 3*l.* per hogshead on an average.

A considerable part of the fruit-land in Worcestershire and Gloucestershire consists of apple-orchards and pear-orchards, laid down with grass. The produce is made into cider and perry; and the best sorts of fruit, which have lately been more cultivated both for dessert and culinary purposes, are sent to market.\* In the former county the fruit is grown for the most part on the New Red Sandstone in the neighbourhood of Worcester, Droitwich, Upton-upon-Severn, and Redditch. In Gloucestershire in the Vale of the Severn, from Tewkesbury to Newnham, and in the more southern part of the county. Three other counties have a comparatively small acreage of fruit-land of this description, viz. :—

	Acres.
Dorsetshire .. .. .	3,814
Shropshire .. .. .	2,944
Wiltshire .. .. .	2,393

Fruit-land in Worcestershire and Gloucestershire.

in which counties many of the farms have a small plot of apple-orchard land which supplies fruit for domestic purposes and yields somewhat second-rate cider for home-consumption.

With regard to the cultivation of fruit upon this system, as adopted upon more than two-thirds of the fruit-growing area of the country, it must be said that not nearly enough thought, care, nor capital has yet been bestowed upon it. The trees are thrust into the ground and left to take their chance in too many cases. Pruning is neglected, manuring is by no means general, and the selection of sorts is not much considered. The enormous demand for good table and cooking-fruit, and the competition of such fine fruit as Newtown Pippins, which come from America in first-rate condition to London and Liverpool in almost incredible quantities, will, it is hoped, soon bring about improvements much to be desired.

Not enough care bestowed upon the system of fruit-growing.

Owing to the uncertain nature of the English spring season and its frequent climatic vagaries during the blooming-time of apple-trees and pear-trees, the crop is somewhat precarious. Late white frosts are occasionally most destructive, and after these and other unfavourable influences the juices of the trees are changed and rendered grateful to caterpillars—the larvæ of a tiger-moth of the genus *Arctia*, which clear the branches of every vestige of foliage. Daubing the trunks of the trees with thick limewash

The spring season frequently most destructive to fruit-trees.

\* The annual average yield of apple-orchards laid down with grass is about 200 bushels per acre. The price of apples ranges from 7*s.* to 2*s.* per sieve in London. Taking the past ten years, the average return to the grower per sieve, from fruit sent to market, after all expenses of picking, packing, carriage, and commission have been deducted, is about 2*s.*

is adopted as a remedy against the caterpillars; and finely powdered caustic lime is thrown up into the trees, in the winter in damp weather, to clear away the lichenous growths that infest them in some situations.

Cost of raising  
Orchards.

The expense of raising orchards, which amounts to from 10*l.* to 14*l.* per acre, exclusive of annual interest upon the first outlay, and the fact that there is a general absence of any definitive right with regard to compensation to tenants, have much checked the increase of fruit-plantations. This applies not only to apple-trees and pear-trees, but also to all kinds of fruit; in a less degree, however, in the case of bush fruit-trees, in which the first cost is not so great, and a return is obtained in two or three years. When a tenant wishes to plant fruit-trees some landlords arrange to repay the whole cost with interest thereon, in the event of the tenants leaving the land before the fruit-trees are large enough to bear; and other landlords agree to find trees, leaving the planting and future charges to the tenants. In the majority of instances, however, the tenant plants fruit-trees without agreement, having confidence in his landlord.

Planting of orchards in the "Agricultural Holdings Act," passed by the British Parliament in 1875, is placed in the Schedule of Improvements of the first class, for which a tenant may receive proportionate compensation for his outlay up to a period of twenty years after the execution of such improvements. If this payment were in all cases obligatory, large additions would be made to the acreage of fruit-land in this country, and great improvements in the cultivation and management of the existing acreage would also result.

The second  
system, or  
growing fruit  
upon culti-  
vated land.

Coming now to a description of the second system, the chief centres of fruit-growing upon cultivated land are the counties whose names and respective acreages are given below, viz. :—

	Acres.
Kent .. .. .	13,097
Cornwall .. .. .	4,497
Surrey .. .. .	1,726
Lancashire .. .. .	1,974

Each of these counties has a proportion of orchard-land proper included in this acreage, but the greater part is planted with various kinds of fruit, and is cultivated by manual labour. Fruit-growers here prefer not to have all their eggs in one basket, and think it better to plant various kinds of fruit-bushes under the standard trees,\* that if one fail there may be a chance of another being fruitful, and that to some extent there may be

Fruit-bushes  
set under  
standard trees.

\* In some places "half-standard" apple-trees are planted. These are bush-shaped, upon stems of from 3 to 4 feet in height, and are very closely pruned to keep them from overshadowing the under trees.



a succession of fruits. Thus, for example, green gooseberries, for which there is a large demand for bottling and for cooking, would come first for picking; then raspberries, red and white currants, ripe gooseberries, black currants, plums, damsons, and apples would follow in regular order. A very large proportion of the fruit-land in Kent is planted in this way with different kinds of fruit-trees. It is regularly cultivated, being dug and hoed by hand every year. Apple-orchards with grass under the trees have for the most part been grubbed and planted with hops.

Cherries form a specialty of fruit-cultivation in Kent, being grown to a great extent in the eastern part of the county upon grass-land which is fed off by sheep eating corn or oilcake, and is well manured frequently with farmyard-manure. This cherry-orchard land is situated principally upon the clay and loamy clay soils of the Thanet beds, the plastic clays of the Woolwich and Reading beds, and of the Oldhaven beds, which crop up curiously in the district between Chatham and Canterbury. Large returns are sometimes made, but the fickle climate of the English spring season makes this a rather uncertain crop. As much as 12*l.* per acre is paid as rent for exceptionally good cherry-orchards. An average of the rents paid is about 8*l.* per acre. As much as 80*l.* per acre has been cleared by this kind of fruit-land; but the profit of land where the trees are in full vigour may be said to be about 20*l.* per acre per annum, upon an average of seasons. The annual expense of a cherry-orchard is from 11*l.* to 14*l.* per acre, exclusive of all charges connected with picking, packing, and marketing, which of course vary with the amount of the crop. All the cherries are sent direct to London,\* from whence they are sent to other large towns when the Metropolitan demand has been satisfied. Most of this fruit is used for eating. Red or Kentish, and Flemish cherries, which are late sorts having a subacid flavour, are bottled or preserved, and Morellos, grown chiefly on walls, are used for making cherry-brandy. In many cases the growers sell the fruit upon the trees by auction or private contract to middlemen, who take all further expense and risks upon themselves.

Cherry-trees are raised from grafting the wild cherry-stocks found in the woods, with scions of the sort required. When the grafted stocks have been two or three years in a nursery, they are planted at first upon cultivated ground at a distance of from 27 to 33 feet apart, giving from 40 to 60 trees per acre. These trees are carefully and tenderly pruned during the first two or three years; after that time but little cutting is required. Hops

\* The average price in London for Kent cherries for the last twenty-six years has been 8*s.* per sieve of 48 lbs. The net return to the grower would be 5*s.* 4*d.* per sieve.

and fruit-bushes, or plum-trees, are set between them. After a few years, when the cherry-trees have come into bearing, the bushes and plum-trees are taken away, and grass-seeds are sown. The chief sorts of cherries grown are the Adam's Crown Heart, the Black Heart, May Duke, Turkey Heart, Bigarreau, Purple Jean, Waterloo, Kentish, Flemish, and Frogmore.

Greengages.

Greengages are grown extensively in the eastern part of Kent, near Sittingbourne, where the soil is especially suited for their production. The gages grown here are finely flavoured and well coloured, and as much as 100*l.* in one year has been made from an acre planted with them. Plums and damsons, especially a species of the latter known as the "Crittenden," are largely grown in Kent, and are very profitable in most seasons. In the last season a sharp white frost, late in the spring, so cut up the bloom that the crop was an utter failure, and in some cases the trees themselves were killed.

Gooseberries ;  
red, white, and  
black currants.

Fruit-bushes, as gooseberries, red, white, and black currants, and raspberries, are planted under apple, plum, or damson-trees, or frequently by themselves. In the former case they are set 6 feet apart, or 1210 trees to the acre ; in the latter, 5½ feet, or 1420 trees to the acre. Land thus planted is well manured in the autumn with woollen rags, shoddy, or fish manures, and dug by hand with the three-tined spud, which is also used for digging the hop-plantations. The bush-trees are closely pruned in November, as in the accompanying Illustration (Fig. 6), and the land is kept carefully hoed during the summer. Immense quantities of gooseberries and red currants\* are grown in Kent, Worcestershire, and Gloucestershire, and are sold for eating, bottling, and jam-making. Black currants are grown upon the heavier soils in Kent, upon the Atherfield clay and the more retentive clays of the Greensand formation, and are a very profitable crop. There are also large plantations of black currants on the stiff land near Cambridge which are remarkably productive. As the fruit is grown upon young wood, the old wood is cut away closely in each autumn season. In the case of red currants, the fruit is mainly grown upon old spurs, and the young shoots therefore are cut away. All these fruit-

Fig. 6.—Pruned Gooseberry-tree.

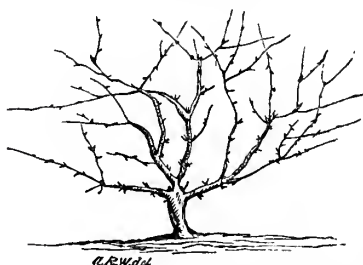

\* The average price of gooseberries in London is 2*d.* per lb. ; of red currants, 2½*d.* per lb. ; of black currants, 3*d.* per lb. ; raspberries, 2¾*d.* per lb. ; straw-berries, 5½*d.* per lb.

bushes are easily propagated by cuttings, which remain two years in a nursery, and bear fruit the year after they have been planted out. The cost of cultivating an acre of land planted with fruit-bushes is from 12*l.* to 14*l.* The average return per acre may be set at 36*l.*, from which must be deducted at least 21*l.* for expenses of all kinds, including cultivation. All fruits of this description, called "soft" fruits, are picked by women and children, and are packed in baskets,\* except raspberries, which are sent in tubs direct to London.

Before passing from Kent, the cultivation of filberts and cob-

Filberts and  
cob-nuts grown  
in Kent.

Fig. 7.—Pruned Filbert-tree.



nuts, peculiar to this county, must be noticed. This occurs mainly in the part of Kent near Maidstone, on the Greensand formation, and involves much skill, care, and capital. In most cases the trees are planted under standard fruit-trees at a distance of 13 feet apart, which gives 257 trees to an acre. The land is well manured every other year with rags, shoddy, fish, or fur waste, and is always cultivated by hand, and kept scrupulously clean. Filbert-trees are pruned most closely, and trained to grow in the shape illustrated by the woodcut, Fig. 7, having stems about 2 feet in height, from which the branches spread out laterally, forming a centre of a cup-like shape, with a diameter of 7 or 8 feet and a height of 6 or 7 feet.† An average yield from a filbert-tree in full bearing is 3 lbs., and the price of the nuts in Covent Garden Market may be averaged at 9*d.* per lb. Cob-nuts are larger than filberts, and are in a

Their peculiar  
cultivation.

\* Round baskets, or whole, half, and quarter-sieves, containing 48, 24, and 14 lbs. respectively.

† See a Paper on "Fruit-growing in Kent," in vol. xiii., second series, Royal Agricultural Society's 'Journal,' page 113, in which filbert-cultivation is described in detail.

degree superseding them. The trees are very similar, and are pruned and cultivated in the same way.

Fruit culture  
in Cornwall.

Cornwall has been famous for its fruit-production for centuries. Its apples are finely flavoured and abundant, owing to its mild climate and rich soil. A peculiar sort of apple known as the Gillflower is justly celebrated. Bush-fruits of all kinds are grown here in the same way as in Kent, and strawberries and raspberries, which are indigenous, are very largely and successfully cultivated. The latter fruit is grown upon canes, set 3 feet by 5 feet apart. These canes are arched, and tied loosely with strips of matting, so as not to fracture them. No stakes are required and the fruit grows all round the arched cane. Cornish raspberries are remarkably fine, and are sent to market in casks; the average price obtained for them is 28s. per cwt., and an average crop is about  $1\frac{3}{4}$  ton per acre. Fruit is sent from Cornwall to London by rail, and to Liverpool by sea. In Surrey and Lancashire, fruit is mainly grown upon bushes, and in connection with market gardens. Gooseberries and currants are grown in the same way as in Kent, and strawberries are extensively grown in the former county. Market gardeners in Middlesex also cultivate fruit-trees and plant vegetables between them in quick succession; but they do not grow fruit upon any system. Fruit-growers in Worcestershire and Gloucestershire, especially near Evesham in the former county, grow soft fruit of all kinds with great success. The trees and bushes are not planted all over the ground with mathematical regularity as in Kent, but are set in rows here and there, with large spaces left for the growth of vegetables. Plum-trees are cultivated to a great extent, and thrive exceedingly well, as do all other fruit-trees, upon the blue Lias clay. A small white egg-plum, known as the Pershore plum, is much grown and with great success. As much as 100*l.* per acre per annum has been made from these plums. About 18*l.* per acre per annum is the average profit from cultivated fruit-land in these counties. Rents range from 4*l.* to 12*l.* per acre, and the expenses average 13*l.*, exclusive of picking and selling the fruit. But little of the fruit grown here is sent to London. The bulk of it goes to Birmingham, Manchester, Dudley, Wolverhampton, Liverpool, Leeds, and other large Midland and Northern towns where there is a large and growing demand for the artisan population.

Cornish rasp-  
berries.

Plums largely  
grown near  
Evesham.

Strawberry  
cultivation.

The cultivation of strawberries has been largely extended of late. This fruit is grown in Cornwall; in the neighbourhoods of Devonport, Tavistock, and Plymouth in Devonshire; in the Vale of Evesham, in Worcestershire; and in the counties bordering upon London, notably in the western part of Kent on the clays of the Thanet beds. Clay-land suits strawberries

best, and under favourable circumstances they come into full bearing in three years and continue to bear for six years. The plants are propagated by the long runners, and are set in rows 2 feet 6 inches wide, and about 1 foot 6 inches from plant to plant in the rows, giving about 10,500 plants to an acre. The rows are put thus far apart to diminish labour expenses, by hoeing between the rows with horses; and some growers have lately put the plants 2 feet 6 inches apart each way, so that the horse-hoe may be worked in all directions. Just before the fruit begins to change colour, rough farmyard-manure is laid under the plants to keep the fruit from dirt. Strawberries are picked very early in the morning before the sun is up, and gangs of men and boys go forth at 3 A.M., and leave off picking at 7 A.M. Fruit thus picked realises as much as 1s. 6d. per lb. in the earlier part of the season. The best fruit is sold for eating, and the second-rate is sold for jam. It is not unusual for as much as 100l. to be made of an acre of strawberries, but an average profit is about 20l. per acre. The strawberries that are chiefly grown are, the British Queen, Keen's Seedling, Elton Pine, Princess Alice, Comte de Paris, Goliath, Alice Maud, and President.

The small acreage of fruit-land in Wales is distributed principally among the following counties, viz. :—

	Acres.
Brecon .. .. .	859
Radnor .. .. .	499
Montgomery .. .. .	337
Glamorgan .. .. .	258

Acreage of fruit-land in Wales very small.

which border upon England. This, for the most part, consists of apple-orchards planted in the valleys, whose produce is generally made into cider for the work-people.

In Scotland, the counties of Lanark and Perth alone have an acreage worth mention: there being in the former 493 acres, and in the latter county 378. Soft fruits only are grown, as the climate is too cold for apples and pears to ripen. Strawberries are very successfully cultivated in Perth and Edinburgh. In 1876, a grower in the former county was offered 100l. per acre for 28 acres planted with strawberries. Enormous quantities of currants and damsons are sent to Scotland from England to be made into jam.

Climate of Scotland unfavourable for fruit-growing.

Fruit is grown in the United Kingdom, as a rule, only upon the two systems that have been described above, at least upon a large scale and for market purposes. There are some few growers here and there, who grow fine apples, pears, and plums, upon pyramidal trees, and low bush-trees obtained by grafting upon Paradise stocks, which are easily pruned, and in some cases

are root-pruned. Fruit is also grown in private gardens upon pyramids and low bush-trees, as well as upon cordons and espaliers. Peaches, nectarines, and apricots are but seldom cultivated for market in the open air, on account of the variable character of the spring season. Even in the most sheltered situations, in the best managed gardens, upon the warmest walls facing south and south-east, these fruits do not come to perfection more than once in three years. They are grown under glass in "orchard houses" near London and other towns, and make long prices at Covent Garden and other markets.

Large demand for fruit.

There is a large and increasing demand for fruit of all kinds throughout the year in this country, especially for fine, handsome table-fruit, of which, in some seasons, there is a great scarcity. Fruit of second and third-rate quality is eagerly bought for retailing in the large towns, and to supply the preserve manufactories in London, Liverpool, Manchester, Birmingham, and Glasgow, which take astonishing quantities in the season. Some of these manufactories make 15 tons of preserve per day, and it is calculated that at least 400 tons are made daily throughout the fruit season in all parts of Great Britain.

Immense quantities of fruit taken for jam-making.

It is impossible to give any statistics as to the quantity of fruit grown in England, or to convey even an approximate idea of how much is taken into London. No octroi duties are levied upon produce as in France; and although tolls are charged upon fruit brought into the large London markets either by corporate bodies or by private proprietors, much of the fruit does not actually go into the market, but is sold in warehouses adjoining, so that tolls are not levied upon it. The preserve manufacturers make contracts with fruit-growers or with middlemen, who buy the growing crops; and the fruit in these instances does not go to any market, but is sent directly to the manufactories. Besides the large quantities of fruit grown in this country, the amount imported is truly enormous, and is increasing year by year. For example, in 1876, according to the Return of the Board of Trade, 2,372,779 bushels of raw fruit, valued at 1,218,625*l.*, were imported into this Kingdom, as against 2,220,412 bushels in 1875, valued at 986,248*l.* Of this, 440,760 bushels, valued at 266,276*l.*, came from France alone; in 1876, against 581,170 bushels, valued at 271,878*l.*, in 1875.

Amount of fruit grown impossible to be ascertained.

Large importation from France and other countries.



## CHAPTER III.

## VEGETABLES.

THE cultivation of vegetables for market was first adopted in this country about the middle of the seventeenth century. Gardening for profit, according to Fuller, the old historian, "crept out of Holland," from whence vegetables had been long imported into England, "to Sandwich in Kent," and it has gradually developed into a most important branch of national industry. Vegetables are grown to an enormous extent now in Great Britain, both by market gardeners, who cultivate from 5 to 50 acres of land, in the vicinity of London, and many other large towns; as well as by farmers who grow all kinds of this produce upon a large scale in localities where the soil is suitable and the facilities of transport are good. As the profits of ordinary farming are small in these days, farmers of land in convenient situations naturally turn their attention to the culture of vegetables, which pays fairly well, as a rule.

According to the Agricultural Returns for 1877, there were 37,859 acres in Great Britain used as market gardens or for the growth of vegetables in that year, viz:—

England .. .. .	34,464
Wales .. .. .	446
Scotland .. .. .	2939

First introduction of market-gardening into England in the 17th century.

Extent of acreage of land devoted to the growth of vegetables in 1877.

Fifty years or so ago, vegetables were produced chiefly in market gardens where spade-husbandry alone was practised, in the suburbs of London and in the bordering counties of Kent, Essex, Middlesex, Surrey, and Hertfordshire. There is still a certain area, within a radius of a few miles of the Metropolis, where the old system prevails; but as the land is being gradually absorbed for building purposes, this is decreasing year by year. Beyond this area of market gardening proper, which may be styled the inner circle, defined by small holdings, spade culture, and the easy distance from London markets, so that the produce may be sent in upon waggons and carts early and fresh; there is an outer circle extending far into Kent, Essex, and Surrey, where vegetable-growing is carried on upon a large scale, in a spirited manner, with the appliances of implements and machinery that are used in ordinary farming. In some cases the produce is sent by rail from this outer circle, but a large portion of it is conveyed by horses direct to the London markets, and manure is carted home. Great cart and waggon loads of vegetables, piled up in the most artistic manner, may be seen coming into all the

Area round Metropolis, or inner circle.

Area beyond Metropolis, or outer circle.

London markets from 4 to 5 o'clock A.M., being sent thus early in order that they may be fresh and crisp.

Within the charmed circle appropriated to spade husbandry the more delicate vegetables are grown, such as asparagus, sea-kale, brocoli, cauliflowers, French beans, celery, radishes, lettuces, mustard, and cress. Many of these require careful management, and to be forced in frames in the early part of the season.

Without the circle, cabbages, collards, or young cabbages cut before the heart is formed, peas, beans, onions, Brussels sprouts, cauliflowers, and purple sprouting brocoli—a most valuable vegetable either cut as greens, or later as brocoli heads,—and turnips, are principally grown.

Besides all this, the produce of what may be called the legitimate market-garden and vegetable-farm, peas, early potatoes, cabbages, turnips, carrots, and onions are grown in all parts of the country, by fits and starts, according to the probable demand; and in certain places special vegetables only are produced, as, for example, onions at Biggleswade and Sandy, in Bedfordshire; cauliflowers at Mount Sorrel, in Leicestershire; brocoli in Cornwall; carrots in parts of Surrey and Wiltshire. Many farmers also grow early potatoes, especially in Cheshire, Lancashire, Yorkshire, and Lincolnshire. Potatoes are also universally cultivated as a farm crop, being stored to supply the markets.

The business of market-gardening and vegetable-farming for the supply of London is carried on in Essex, on the north-easterly side of London, in the district from West Ham and Stratford, along the left bank of the Thames to Grays, on alluvial soil which, from its light texture and gravelly subsoil, is peculiarly suited for the growth of vegetables. Also in Essex, upon the better soils of the London clay, in the neighbourhood of Romford, and as far from London as Colchester. It is confined in Middlesex to the south-western quarter of the county, as at Brentford and Twickenham, where the soil is a sandy loam with a subsoil of gravel resting upon the London clay; and in Surrey to the London clay and the alluvial deposits upon the banks of the River Thames and Mole. The market-gardens in Kent are situated on the right bank of the Thames, and extend, *longis intervallis*, to Gravesend. The soil is alluvium, of the same kind as that on the left or Essex bank of the river, and the clays of the Old-haven beds and Thanet beds, which crop up here, are well adapted for vegetables as well as for fruit-growing.

Besides the market-gardens near the metropolis, whose modes of cropping and of general management are fully explained herein, many other counties have a small extent of land devoted to the production of vegetables for market, situated for the most part near their chief towns. As their systems are the same as those

Vegetables  
cultivated in  
special  
districts.

Essex area.

Middlesex area.

Kent area.

Acreages of  
chief counties  
producing  
vegetables.

described, it will not be necessary, except in a few instances of special culture, to do more than give the following Table of the largest acreages in 1877, viz:—

	Acres.
Middlesex .. .. .	5119
Essex .. .. .	4183
Kent .. .. .	3950
Surrey .. .. .	1682
Yorkshire, West Riding .. .. .	1745
Worcester .. .. .	1350
Hampshire .. .. .	905
Gloucester .. .. .	1002
Chester .. .. .	896
Cornwall .. .. .	977

There is no regular rotation of crops in the management of market-gardens and farms. The rotations depend upon the soil and its condition, and in a great degree upon the probable demand for particular vegetables, as well as upon the season, and the times by which certain crops are cleared off the land, to which no rest is given. Fallows are unknown. A continuous succession of crops is the great object, entailing the application of incredible quantities of manure, which is chiefly obtained from the stables and cowsheds in London.

No regular rotation of crops.

For this also a great amount of labour is necessary, which is supplied in the summer, at least in the fields beyond the inner circle, by a migratory population, who are for the most part housed in out-houses, barns, and temporary erections, and begin the season in March or April in the market-gardens, and finish it in September in the Kentish hop-gardens.

A typical instance of a rotation of crops that is extensively adopted may be cited. 1st. Cabbages are taken; these are planted in June and cleared by January, being followed by—2nd. Early potatoes, dug in June or the early part of July. 3rd. Winter greens or hardy greens are then planted, to be succeeded by—4th. Peas which are picked by June. 5th. Winter onions are got in at once, and another green crop immediately follows them. It will be readily understood that this quick succession requires most liberal supplies of manure, and that the difficulties of growing such moisture-loving vegetables as those of the *Brassica* genus in summers of drought are sometimes insuperable. Large supplies of water are given to plants of this kind, and irrigation is practised near the Thames where circumstances allow. From 40 to 50 tons of farmyard-manure are applied every year, and nitrate of soda, guano, and bone-dust are frequently used; but the mainstay of market-gardens is well-made farmyard-manure.

Typical rotation of crops.

Farmyard-manure the mainstay of market-gardens.

In some districts, cauliflowers cut in the spring are fol-

lowed by celery, with radishes thickly sown between the rows. This goes on for years; the position of the rows of celery being changed every other year. Nearly 100 tons of farm-yard-manure per acre are required for this exhaustive system of cropping.

Upon larger gardens, or market-farms, a usual course of cropping is: potatoes followed by greens; then parsnips, or carrots, or mangolds are put in, followed by winter onions, with cabbages taken after these. Brocoli, French beans, broad beans, and cabbages are taken instead of some of the crops of this rotation.

Salad and sweet herbs specially grown at Mitcham.

Lettuces, radishes, endive, and salad herbs of all kinds are chiefly grown in the market-gardens nearest London and other towns. At Mitcham, in Surrey, there is a large extent of garden-ground devoted to the growth of sweet herbs, as peppermint, thyme, basil, and lavender. Liquorice is also largely cultivated at this place, whose summer-air is fraught with "odours of Araby."

It is convenient to give in this place a short description of the details of cultivation of some of the vegetables most commonly grown: beginning with—

Asparagus culture.

Asparagus, which is extensively produced near Isleworth, Fulham, and Mortlake, in the valley of the Thames, and in other places near London, as well as at Colchester in Essex and near Gravesend in Kent. This vegetable is now grown for the most part in rows, from 5 to 6 feet apart; the system of planting in beds being relinquished by those who cultivate it upon a large scale. 30 or 40 loads of farmyard-manure are put on the land, which is deeply trenched. A crop of radishes is taken before the plants are put in. Beets, or onions, or lettuces are grown between the rows. Asparagus plants come to full bearing in the fourth year. When the plants are well established, they are earthed over in March: the heads are tied neatly in bundles containing 105, and make from 3*s.* 6*d.* to 7*s.* 6*d.* per bundle in the early part, and about 2*s.* 4*d.* in the latter part of the season.

Sea-kale.

Sea-kale is one of the most profitable vegetables, and is cultivated mainly by market-gardeners within the metropolitan area, particularly near Deptford in Kent, and in the Thames Valley in Surrey. It is generally propagated from short lengths of old roots, sometimes from seed, planted in rows about 14 inches apart. Every third row is taken up early in November, and the plants are put into pits heated to a temperature of 70° Fahr., being fit for cutting about 20 days after planting. The plants left in the garden are covered with earth, and come to cut in March.



Cabbages form a great source of profit, from 60*l.* to 70*l.* being frequently made per acre. They are planted out 15 inches apart each way, after potatoes or onions; or later, after celery and French beans. The smallest plants are thinned out and sent to market early in March, being called "collards," or coleworts. Cabbages thrive remarkably well upon sewage farms.

Cabbages and coleworts.

Onions are extensively grown near London and in Bedfordshire, and do well upon friable sandy loams. An average crop is about 14 tons per acre. As much as 180*l.* per acre has been made for onions, but 35*l.* is an average return. Cucumbers are produced in enormous quantities under glass, and in the open air. Many individual growers cut as many as 200 dozens a week. They are much grown in Huntingdonshire, at St. Neot's, and at Sandy in Bedfordshire, and are sent to market in flat baskets containing two bushels. 45*l.* represents an average return per acre.

Onions a profitable crop.

Lettuces, radishes, mustard, and cress\* also pay remarkably well, as do tomatoes, whose cultivation is increasing at a rapid rate, as this vegetable within the last five or six years has been much appreciated by the English people. Very large quantities of vegetables are used in the manufacture of pickles and sauces; and the demand for suitable onions, French beans, cauliflowers, and gherkins—young cucumbers—for these purposes occasionally far exceeds the supply. The best firms of pickle and sauce manufacturers, some of whom employ 300 or 400 hands in the busy season, take only first-class vegetables for pickling; but the smaller firms do not object to buy those of inferior quality, which they convert literally into "mixed" pickles, and impart to them a brilliant green colour with sulphate of copper. One large firm in London takes from 12,000 to 14,000 bushels of onions in one season, and other vegetables in proportion.

Large demand for certain vegetables for pickle manufacturers.

Rents of market-garden land, and of market-farms, within 20 miles of London, range from 4*l.* to 9*l.* per acre. Labour expenses come to from 6*l.* to 9*l.* per acre, and the whole annual average expenses per acre are at least 22*l.* In spite of this large outlay, fair profits are usually realised, and occasionally, in favourable seasons, or by lucky hits, they are very handsome.

Rent and expenses connected with vegetable culture.

The profits of market-gardening and of vegetable cultivation generally have been much interfered with lately, by the importation of foreign vegetable produce, which has steadily increased during the last few years, and the more so as many of the vegetables, especially asparagus, peas, and cauliflowers arrive in

Profits affected by foreign importation.

\* Some individual growers use as much as 600 bushels of mustard-seed per annum.

London before those vegetables are ready in England. The value of vegetables imported into this country in 1876, was 199,413*l.*, as against 132,124*l.* in 1875, of which those sent from France were valued at 92,627*l.*, as against 77,265*l.* in 1875.

Cornwall.

Next in importance to the above-described districts is that in Cornwall. Though the extent of this is only 977 acres of actual market-garden ground, vegetables of all kinds, and potatoes especially, are grown upon the farms in the western part of the county. Brocoli is the chief vegetable grown here, coming to cut very early in December in some seasons, and never later than January, on account of the mild climate of the winter. In some winter seasons, as, for example, in 1875, at the Land's End, the thermometer has been at 50° Fahr. in the shade at Christmas time. Asparagus has been cut in the open air, and primroses have bloomed in these months. In 1875, brocoli from Penzance were sent to London at the rate of 25,000 dozens per week, and sold in the streets at very low prices, and the Cornwall brocoli season was over by the end of January, 1876. Brocoli rarely fails in Cornwall; but in Surrey, Kent, and other places, it fails once in four or five years through the spring frosts. The soil in the west of Cornwall is well suited for the production of vegetables, being a rich easily-worked loam upon the greenstone and felstone series of Trappean rocks, composed of hornblende and felspar. Brocoli are grown in alternation with potatoes, the plants being dibbled in by women and children in June or July, and the land is thoroughly well manured. They are sent to London, Manchester, and Liverpool in wicker-work baskets, holding 100 heads. About 6500 heads are grown upon an acre upon an average. Though rents are high and expenses of all kinds are heavy, brocoli-growing pays the Cornish people well. They can send these vegetables to London a month earlier than the market-gardeners in the Channel Islands and those who send cauliflowers from Cherbourg, and they have the command of the best market in the world at a season when fresh vegetables are luxuries indeed.

Its mild climate.

Brocoli the chief vegetables produced in Cornwall.

Potato-sprouting process.

Early potatoes are grown in considerable quantities in the part of Cornwall lying between Penzance and Truro. Generally the potato sets are planted directly after the brocoli comes off, having been first sprouted\* about an inch before they are planted, which is held to give a month's start to the sets. These, usually of a sort called Lemon Kidneys, are dug in April, and are sent

---

\* Potato sets are put in shallow boxes or baskets in lofts, above stables or cowsheds, or any place where the temperature is high, to make them sprout prematurely. Care is taken not to break off or bruise the sprouts.



to the large northern and midland towns. Before the potato disease had become virulent, and the French and Channel Islands growers were in competition with the growers of Cornwall, two crops of potatoes were taken in a year from the same land. This is done now occasionally. One crop is planted in November and dug in April. Another is planted with sprouted sets directly the first comes off, whose produce is ready to dig in September. The mild character of the climate renders this possible in most years. Two crops of potatoes in one year are also obtained at Morecambe Bay, upon the west coast of Lancashire, where the sprouting system is also adopted, and on the "warp"\* land in Yorkshire, near Selby and Hull, and other places. In parts of Lancashire, as at Ormskirk, small farmers grow early potatoes for the Blackburn, Bolton, and Manchester markets. The potatoes are planted upon made soil which is very rich, light, and friable, late in January or early in February, and are protected by frames covered with straw, or reeds, or mats, during the night, which are taken away during the day. The young potatoes are packed in hampers, containing about 20 lbs., and realise 1s. per lb. in most seasons.

Two crops of potatoes taken in a year.

Besides the potatoes that are grown on market-farms, very large quantities are grown upon ordinary farms in all the counties of Great Britain, forming part of the ordinary rotation of farm crops in most districts.

Potatoes grown in large quantities upon farms.

The annual average number of acres planted with potatoes during the eight years ending 1877, was 544,345, or—

Average.

	Acres.
In England .. .. .	330,713
„ Wales .. .. .	46,151
„ Scotland .. .. .	167,481

In 1871 the acreage was 627,691 for Great Britain, while in 1877 it was only 512,471 acres, and the returns show that between these years there has been a gradual decrease in the acreage, owing to the fear of the potato disease, and to the importation of potatoes from foreign countries, which has increased in an astounding degree since 1871. For example, the quantity of potatoes imported into this country was only 847,835 cwts. in 1871, whose value was 225,068*l.*, as against 3,986,662 cwts. in 1874, 4,696,132 cwts. in 1875, and 6,023,936 cwts. in 1876, whose value respectively amounted to 1,034,835*l.*, 1,070,976*l.*, and 1,740,749*l.*

Decrease in acreage planted with potatoes on account of potato disease and large importation.

\* "Warp" is a peculiar soil of mud and fine sand, which is left by the tide at the mouths of rivers or estuaries, as in the great Wash in Lincolnshire. In some cases successive rows of faggots are laid down, which soon become solid from the absorption of mud, and gradually dam back the tide, making *terra firma*.

Acreage of chief potato-growing counties in England in 1877.

The following are the chief potato-growing counties in England, with their respective acreages in 1877 :—

	Acres.
Yorkshire .. .. .	43,246
Lincolnshire .. .. .	36,552
Lancashire .. .. .	33,783
Cheshire .. .. .	20,360
Devonshire .. .. .	15,002
Kent .. .. .	13,576
Cambridgeshire .. .. .	8,874
Somersetshire .. .. .	8,163
Staffordshire .. .. .	7,276

Acreage in Wales.

In Wales there were in 1877—

	Acres.
Cardigan .. .. .	7710
Carnarvon .. .. .	5465
Carmarthen .. .. .	4533
Denbigh .. .. .	4090

Acreage in Scotland.

In Scotland the largest acreages in 1877 in the counties were as follows :—

	Acres.
Fife .. .. .	17,488
Perth .. .. .	17,648
Forfar .. .. .	15,365
Haddington .. .. .	9,847
Ross .. .. .	9,195
Lanark .. .. .	7,996
Inverness .. .. .	8,091
Ayr .. .. .	7,775
Aberdeen .. .. .	7,644
Edinburgh .. .. .	7,063
Argyle .. .. .	6,566

Importation of French potatoes large.

Assuming that an average yield of 6 tons per acre was obtained on the acreage of potato land in Great Britain in 1877, viz., 512,471 acres, this would give the large amount of 3,074,826 tons of potatoes grown in that year. In addition to this, there is the quantity imported, which amounted to 301,187 tons in 1876, of which more than half came from France.

Rotation of farm crops where potatoes are grown, and systems of cultivation.

Upon the best soils, such as the "warp" land, and other rich soils in Yorkshire and Lincolnshire, potatoes are taken every third year in rotation, sometimes every second year, and not unfrequently in succession. An ordinary course is for potatoes to follow clover, seeds, or beans—after wheat. From 20 to 30 tons of farmyard-manure are ploughed in, in the late autumn, or in the winter. The land is ploughed across in the early spring, and the potatoes are planted on the ridge, from February to April, and 3 or 4 cwts. of guano are applied. From 10 to 14 cwts. of sets are put in per acre, being placed from 10 to 15 inches apart, in rows 27 to 30 inches wide. Some growers prefer to put in small potatoes as seed, others cut large potatoes into several pieces, or merely in halves, which appears

to be the best practice. In the counties of Essex, Cheshire, and Lancashire, potatoes generally follow clover leys, after barley or oats. Sometimes the ley is left for two years before potatoes are taken. Potatoes are usually planted after white-straw crops in the south and the east of England, as well as in the Lothians and other parts of Scotland.

York or Dunbar Regents, Rocks, Paterson's Victorias, Dal-  
mahoy's, Redskins, Flour Balls, and Lapstones are chiefly planted  
for the ordinary crop. Myatt's Early Kidneys, Ashleaf Kidneys,  
Lemon Kidneys, are the sorts usually grown for early digging.

Sorts usually  
planted.

The total cost of cultivating an acre of potatoes, including  
manure, seed, cultivation, digging and delivery, may be put at  
from 17*l.* to 25*l.* per acre. An average yield upon the best  
potato land is from 5½ to 10 tons per acre. Upon land of second  
quality, from 4½ to 8 tons are grown per acre. The average  
price made of potatoes in London during the last ten years  
is 5*l.* 10*s.* per ton, the highest prices during that time having  
been 10*l.* 12*s.* 6*d.* in June 1873, caused by the virulence of the  
potato disease in the preceding year; and the lowest 3*l.* 10*s.* in  
December 1870.

Cost of culti-  
vation.

Average price  
of potatoes for  
last 10 years.

Since 1845, when the potato disease, caused by the fungus,  
*Phytophthora infestans*, first appeared, it has periodically de-  
vastated the fields of Great Britain, and has much checked the  
cultivation of potatoes, and reduced the profits of the growers.  
There is at present no remedy known against the attack of this  
insidious fungus, nor any cure for plants when attacked by it.  
Its life-history has only recently been completed by the researches  
of Professor De Bary\* and Mr. Worthington Smith, the former  
of whom identified the sexual organs in the mycelium of the  
fungus, and described them as oogonia and antheridia. The  
latter witnessed the act of fertilisation by the antheridia, and  
traced the progress of the oogonium—called by Mr. Carruthers, an  
oospore †—through its various stages until its separation from  
the mycelium. This oospore, or rest spore, or, more plainly, the  
germ of the fungus, rests in the tubers, on the haulm, and on  
the leaves of the potato-plant. When all these have decayed the  
germ remains, able to withstand winter frosts or rains, and to  
develop the dreaded fungus when suitable conditions arrive.

Potato disease.

Its life-history  
only recently  
traced by De  
Bary and  
Worthington  
Smith.

The practical value of these discoveries is to point out to  
potato-growers the necessity of planting undiseased seed, and of

\* 'Researches into the Nature of the Potato Fungus,' by Professor A. De Bary, of the University of Strasbourg, 'Journal of the Royal Agricultural Society,' vol. xii., 2nd series, 1876.

† 'Note on Mr. W. J. Smith's discovery of the Rest Spores of the Potato Fungus,' by W. Carruthers, F.R.S., Consulting Botanist to the Royal Agricultural Society, 'Journal of the Royal Agricultural Society,' vol. xi., 2nd series.

carefully destroying the leaves, haulm, and tubers of diseased plants, and not to plant potatoes again for some time on ground where plants have been blighted.

Supposed  
blight-proof  
potatoes.

All sorts of potatoes are liable to be attacked, though early sorts frequently escape, because the disease rarely appears until late in July, and then after heavy rain in most cases. It was asserted that there were kinds of potatoes proof against disease; but the result of a competition for handsome prizes, offered in 1874 by the Council of the Royal Agricultural Society of England for any kind of potato that resisted the disease for three years, was that all the varieties of potato supposed to have been disease-proof were found to be diseased in the first year of the trials.

Town-sewage  
as applied to  
vegetable cul-  
tivation.

This account of vegetable culture would not be complete without an allusion to the application of town-sewage by irrigation to the growth of vegetables. The sewage of towns, which must be disposed of in some way, is, under certain circumstances and upon certain soils, profitably distributed upon land, either by flowing naturally in carriers or in drains by gravitation, or by being pumped up to levels from which there is a fall. Not only is the organic and offensive matter retained by the land thus treated, so that the effluent water is rendered practically inoffensive, but in some cases good profits are realised by the crops grown upon it. All the ordinary kinds of farm crops are grown, but these are not so profitable as vegetables, such as onions, cabbage, brocoli, celery, cauliflowers, and many others, which give enormous yields under this treatment. The sewage farms at Romford and Barking, in Essex, afford typical instances of successful market gardening. In some seasons an acre of cabbages treated with sewage, in quantities varying from 1500 to 2000 tons, whose value may be from 12*l.* to 16*l.*, has realised as much as 70*l.*; and greens have brought 73*l.* per acre. Quantities of liquid, as afforded by the system of sewage irrigation, are essential to the cultivation of vegetables which are taken in rapid succession, and most of which are transplanted. This is particularly the case in seasons of drought, when the sewage-farmer has great advantages and realises high profits. Vegetables are grown very largely upon the sewage farms above mentioned, as well as upon those of Croydon, Leamington, Aldershot, Wrexham, Cheltenham, Edinburgh, and others; not only are they abundant, but excellent in quality.

Wales and  
Scotland.

Upon the comparatively small acreage of Wales and Scotland devoted to market gardening, it is not necessary to comment at any length. The systems of cultivation adopted in both countries are practically the same as those followed in England. In Scotland the more delicate vegetables are not extensively grown,

on account of the climate ; and the cultivation of early vegetables is only attempted under glass.

It will be seen from this sketch of vegetable growing in Great Britain, that it is a most important industry, giving employment to numbers of persons, and providing small luxuries and wholesome food for a mighty population, and at the same time giving a fair profit to those engaged in it. The cultivation of special vegetables pays as a rule so much better than corn growing or meat producing, that it will without doubt be largely extended in the future. As the population increases and the wages of the labouring classes advance, the demand for luxuries of this kind will also increase. Conclusion.

A brief history of the production of hops, fruit, and vegetables has been given in the foregoing chapters, illustrating the rise and progress of each of these specialities of British agriculture ; from which it will be seen that their cultivation has been largely extended during the past 24 years. General  
résumé.

Not only has their cultivation been increased, but the systems of management have been much improved lately, especially with regard to fruit. The keen competition of fruit-producers in France, Belgium, Holland, Germany, Spain, Portugal, and the Channel Islands, from which countries no less than 1,806,346 bushels of raw fruit were sent to England in 1876, has caused the English growers to make improvements, and will necessitate their adoption of the best and most economical modes of cultivation in the future. The same may be said of vegetables, especially the early and more delicate sorts, in respect of which there is great competition from various countries. The demand for fruit and vegetables is, however, increasing, and will without doubt continue to increase while the trade of England flourishes and her large population of mechanics, artisans, and labourers of all kinds receive good wages ; and in spite of foreign competition, which, on account of the perishable nature of these commodities, is limited to countries within easy reach of the English markets, their cultivation will further increase and continue to be fairly remunerative. With regard to hops, the prospects of the growers are not so bright. Hops are now grown in all parts of the world, and can be sent in good condition from Tasmania, the extreme southern limit, and from the fertile valleys of California, the *Ultima Thule* of hop-production. Large quantities were sent to England from all parts of America in the past season, which depreciated the value of English hops in a ruinous degree. There is no duty payable upon hops imported into England, but a duty is levied upon English hops that are exported to America, the Australian colonies, and various other

countries ; so that, in point of fact, the English hop-grower has to compete with the whole world, and is heavily handicapped by the non-reciprocation of free trade.

It may be pointed out, in conclusion, that more than a quarter of a million acres of land in Great Britain are devoted to the growth of hops, fruit, and vegetables, the rent of which may be put at nearly a million and a half pounds sterling ; while the amount of capital employed can hardly be less than six millions sterling.



VIII.

THE AGRICULTURAL LABOURER.

BY

H. J. LITTLE,

OF COLDHAM HALL, WISBECH.

THE NATIONAL LABORERS' UNION  
OF THE UNITED STATES OF AMERICA  
INCORPORATED IN 1869

OFFICE OF THE NATIONAL SECRETARY  
100 N. BROAD ST. NEW YORK, N. Y.

THE NATIONAL LABORERS' UNION  
OF THE UNITED STATES OF AMERICA  
INCORPORATED IN 1869

THE NATIONAL LABORERS' UNION  
OF THE UNITED STATES OF AMERICA  
INCORPORATED IN 1869

THE NATIONAL LABORERS' UNION  
OF THE UNITED STATES OF AMERICA  
INCORPORATED IN 1869

THE NATIONAL LABORERS' UNION  
OF THE UNITED STATES OF AMERICA  
INCORPORATED IN 1869

## CONTENTS.

CHAPTER I.—*Historical.*

Labourers present different Characteristics in different Districts—Scotch Shepherds compared with Labourers in Southern Tillage Districts—Northern Labourer superior to Southern—Irish Peasant Farmers—Term “Labourer” applied more generally to the Cultivator in Tillage Districts—A Retrospect—Poor Law Allowances: Pauperised Labourers—Scotland exempt from such Customs—Process of absorption of surplus Labour gradual—Comparison of Wages in 1796 and in 1850; and 1850 and 1870—Reasons for slow Advance—Farmers had command of Labour-market up to a recent Date—Labour Unions had worked in other Trades—Agricultural Labourers’ Union of 1871—Its effect in transferring surplus Labour, and on the relations of Farmers and their Men .. .. . Pages 765–507

CHAPTER II.—*Wages and Expenses.*

Weekly Wages of Labourer—Condition as tested by consumption of Meat—Harvest Wages—Reduction of Number of Hands required rather than that of Wages brought about by use of Reaping Machines—Earnings of Labourers still very large in Harvest—Illustration of the large Wages often earned by able Men—Nominal weekly Wages misleading as to cost of Work per Acre—Allowances to Labourers virtually mean increased Wages—Weekly Expenditure of a “Hard-up” Family, and that of young unmarried Labourers .. .. . Pages 507–512

CHAPTER III.—*Domestic Life.*

Improvement of Cottages of the Poor—Benefit to Community of Union Chargeability Act—Tendency to scattering of the Agricultural Population—Prize Cottages—Modern Labourers’ Cottages generally provided with Gardens—Woman’s Labour much in request in the North—Cows kept by Master for Labourers in the North—Ancient Village Cottages not generally comparable in accommodation to modern ones—Early Career of Youths in Yorkshire and in Scotland .. .. . Pages 512–524

CHAPTER IV.—*Provident and other Societies.*

Benefit Societies frequently failures—Weakness of Poor-Law administration—  
 Scale of Fees of good Benefit Clubs—Old Public-house Clubs the favourites  
 of the Labourers—Other means of saving compared with Benefit Clubs—  
 Useful Country Clubs—County Shows and Ploughing Matches beneficial

Pages 524–528

CHAPTER V.—*Education.*

Education until recently optional—Now virtually compulsory—Subjects of  
 Education—School Fees—Vastness of the change .. Pages 528–530

CHAPTER VI.—*Early Life, Daily Work and Recreation, &c.*

Daily Life of the Labourer—Evening Rest—Sundays and other Holidays—  
 Gradual diminution of Household—Celibacy very uncommon in the Class—  
 Thrift little understood or practised, as a rule—Advantages enjoyed by the  
 Labourer in the present Day compared with the past .. Pages 530–536

# THE AGRICULTURAL LABOURER.

---

---

## INTRODUCTION.

IT would be impossible to present a faithful picture of British Agriculture without some detailed notice of the labourer; and it must be my endeavour to delineate briefly the general conditions under which the actual tiller of the soil exists in Great Britain, and to give some idea of his home, his education, and his general worldly circumstances.

It is almost impossible, and perhaps unnecessary, to compare his lot with the peasant of the Continent (accepting that term in the ordinary sense as representing the small proprietor and cultivator combined), neither do I think he can justly be compared with the labourer of European countries. He is in fact a part and parcel of the system of English agriculture—a system, be it remembered, which has exalted this country to the very highest rank among the nations of the world in productive capacity.

The English laws, by encouraging the hereditary transmission of large estates, are mainly responsible for this system, whatever may be its virtues or its defects. Under the threefold character of our agriculture, the landlord finding the land, the tenant-farmer the capital and the scientific and practical knowledge, and the labourer the thews and sinews for the actual manual work, the latter is a necessity; and I will endeavour in this sketch to describe the circumstances of this very important section of our body politic.

---

## CHAPTER I.

### HISTORICAL.

I AM met at the outset of my task by the difficulty that, owing to sundry causes—and not least to the variety of races in these islands—the characteristics of the farm-labourer in different parts of the kingdom are often distinct and dissimilar. It would, for instance, be unjust to the educated and thoughtful

Labourers present different characteristics in different districts.

shepherd of northern England or of the Highlands of Scotland to compare him, mentally or physically, with the illiterate and less capable labourer of the southern English counties. The distinction between these two, which is very plain to well-informed Englishmen, may be less obvious at first sight to a foreigner, since they both undoubtedly live to some extent under similar agricultural conditions. The training of the two men is, however, of such a different character, that a much higher degree of intelligence is engendered in the one case than the other; a fact which compels me to allude in a very few words to the physical features of Great Britain.

Scotch  
shepherds  
compared with  
labourers in  
southern till-  
age districts.

A considerable portion of northern England and the greater part of Scotland is, as is well known, occupied by a rugged and mountainous district, which, from its hilly nature and its large rainfall, is more adapted to grazing and stock-rearing than to cultivation. In such regions the "labourer" is almost entirely represented by the shepherd class—men engaged almost entirely in the charge of flocks and herds. The isolation of the lives of these men and the difficulties of their calling have so contributed to thoughtfulness and reflection upon the matters which concern their everyday life and the welfare of their charges, that it would perhaps be difficult in any country to find a class possessed of greater natural intelligence and sagacity. Trained from the cradle to the intelligent use of every bodily faculty, and enjoying the advantages of education which have long been highly prized by their fathers, the hill shepherds of the north form a somewhat remarkable race, but one which, I fear, can hardly be said to typify in general characteristics the class I am about to describe.

In the more southern districts of our island, tillage, favoured by a more genial climate and a more level surface, reigns supreme. Here the land is laid out in large holdings occupied by tenant-farmers, each one employing a considerable staff of labourers, engaged without cessation in the regular cultivation of the soil; ploughing, sowing, reaping, stacking, threshing, from day to day and year to year. Receiving from the farmer or his steward the most minute directions concerning every detail of their work, it is perhaps no wonder that habits of mental forecast should in some cases have been unformed or neglected, and that therefore these men should compare somewhat unfavourably with those whose training has been of a more instructive character.

Northern  
labourer  
superior to  
southern.

The superiority of the northern shepherd over the southern farm servant extends also in a great degree to the northern labourer, engaged in almost identical pursuits with the other. The Northumbrian "hind" is markedly different to the Hampshire



or Dorsetshire ploughman. In the wages which he receives, in his mode of life, in his diet (which consists to a large extent of oatmeal and milk), in his education, and even in his physical powers, there are differences which are entirely to his advantage. In a word, the general superiority of the man is manifest at once to those who come in contact with him.

Again, in Ireland another class predominates. A very large proportion of that country is occupied by very small peasant-holders, many of whom are accustomed to leave their homes for a season in the summer months and to seek work in England or Scotland. These can scarcely be correctly ranked with the labourers of Great Britain, although they are scarcely ever superior to the general run of the latter in their circumstances or surroundings, and, indeed, often submit to greater hardships in housing and greater privations in living than the very poorest English workman. Inasmuch, however, as they are themselves the occupiers of the land they cultivate, they cannot be included in the class of which I am writing, and I shall content myself with this very brief allusion to them. Irish peasant farmers.

It is necessary, therefore, at the outset to draw a line of demarcation between these different sections of the labouring community. It would be impossible, indeed, by a hard-and-fast rule, to indicate exact limits between the labourer of the tillage districts of England and the herdsman or shepherd of the pastoral tracts. Nor is this needed; but in speaking in general terms of the agricultural labourer, I must be understood ordinarily to refer to that large class habitually engaged, in tillage districts under supervision, in the actual cultivation of the soil. In the south this is by no means an unimportant section of the population, and it is one on which, from the nature of our system, the welfare of British agriculture largely rests. Term  
"labourer"  
applied more  
generally to  
the cultivator  
in tillage  
districts.

The real prosperity of a country may to some extent be judged by the condition of its lower classes. In endeavouring to describe the circumstances of our labouring population, I cannot be insensible to the uneasiness and concern which their non-progress in the past has sometimes occasioned to statesmen and philanthropists. I shall show that their present state is of a far more satisfactory character, and that their immediate outlook is most encouraging and promising. But whatever shortcomings there may be—and some of these I shall point out—are so much due to evil legislation in the past, and to its results on the present generation, that I do not think I should be out of place to glance back at some of the causes which have contributed to retard the progress of the agricultural population in the greater part of England.

Something of the superiority of the northern over the southern

labourer, as already indicated, may be due to *race*, but far more is attributable, I believe, to the operation of certain laws and the existence of certain circumstances which I now proceed very briefly to allude to.

A retrospect.

At about the end of the last and the beginning of the present centuries, stimulated by the high price of corn and of provisions generally, consequent upon the wars in which our country was engaged, British agriculture made some very important strides. In some counties large tracts of land had, by the skilful application of capital, been reclaimed from their native state of desert heath, and been rendered fertile and productive. Every inducement would seem to have been afforded by the high prices of agricultural produce for a continuation of such improvements, and for the larger employment of the agricultural population. The materials for wealth and prosperity were thus apparently available to all engaged in such works. Yet seldom had the condition of the farm-labourer of England been less satisfactory than at the period of which I speak. The supply of agricultural labour was far in excess of the demand. Wages were consequently very low, and, with the high price of provisions, quite inadequate to afford a reasonable supply of the necessaries of life to the labouring population. The fact was that, as is usual in such circumstances, the general industry of the country was entirely paralysed, and almost its entire population thrown upon the agricultural interest.

Poor Law allowances—  
pauperised  
labourers.

In this time of distress a custom therefore sprang up of making every labourer in the rural districts an allowance from the poor-rate, in proportion to the number of his family and without reference to his employment or non-employment. Direct encouragement was therefore afforded to the multiplication of an already superabundant population. It would be difficult to overrate the injurious consequences of this system. Under it every labouring man became in effect a pauper, deriving a portion of his subsistence, not from the wage-fund earned by his exertions, but from the rate assessed upon the owners and occupiers of property. His spirit of independence was thus sapped at its foundations. Such an evil once permitted to take root was extremely difficult to eradicate. As a matter of fact it became so gigantic a curse, that whole parishes in England were abandoned to the relief of their poor, the owners of property deriving no income from their possessions. It was not until long after the close of our Continental struggles, and until this serious danger threatened to engulf the whole rural community, that Parliament took steps to abolish this pernicious arrangement, and to establish the relief of the poor upon a sounder footing.

During this dark period the virtues of prudence and of thrift seem almost to have died out among the labouring classes. The noxious weed of pauperism had indeed supplanted the natural growth of self-reliance and self-respect. Accustomed in every trifling emergency to depend upon the rate, farm-labourers naturally found it more and more irksome to assert their manhood, and more difficult to establish their claim to a sufficient standard of wages, whilst they still clung to their hold upon the parish allowances. I have felt compelled to allude to this period of their history, because I believe it affords a clue to whatever has been defective in the condition of the English labourers from that time until the present. But I wish to point out, with reference to what has been before said, that in Scotland no such custom as this ever established itself. There, collections at the church doors were, as a rule, found adequate for the relief of the sick and indigent; but in seasons of special difficulty the farmers met and voluntarily assessed themselves for this purpose. In the Lothians—then, as now, one of the most highly cultivated districts of the kingdom—the most needy were unwilling to accept the necessary alms to ward off starvation. This remarkable independence of character made itself felt not only over Scotland, but extended over her southern border, and gave to the labourers of the most northern English counties a distinctive freedom which is still noticeable, and which widely separates them from those of the south.

Scotland  
exempt from  
such customs.

But other causes have also been at work which have extended the advantages of the northern over the southern labourer. The vast development of manufacturing and of mining industry which has distinguished the last fifty years has been almost confined to the north of the kingdom. Before the days of railways it was no easy matter for the low-paid southerner to transfer his labour to districts where he could command increased wages. Moreover, with every inducement to early marriage, the tendency was continually to overstock the labour market. The result has been a scale of wages in southern England which compares but badly with that ruling in the north, and which has no doubt given a lower tone to the work and the character of those who received it.

These preliminary observations will, I hope, make it plain that the farm-labourers of Great Britain differ to a considerable extent, even at the present day, in their general characteristics and in the amount of wages which they receive. The southern labourer is not yet equal to the northerner in wage-earning capacity. Nevertheless, the process of assimilation between these two distinct types is every day proceeding. Railways are constantly transferring unproductive labour from one district

Process of  
absorption of  
surplus labour  
gradual.

to another; education spreads and tends to equalise the rate of wages; and although I cannot paint a general picture, and say "*Ex uno disce omnes*," I can at least point to some general features of identity, whilst I ask that the differences which I have thus endeavoured to indicate may be borne in mind.

Owing, then, to these causes—to the rapid increase of population, to the lack of education in the rural districts, and to the subordinate position forced upon the labourer by the unwise administration of the Poor Laws—the growth of the labourer in the south, in intelligence, in industry, and in working capacity, has hitherto been painfully slow. By consequence, the growth of his wages has been slow also. In 1796 the common weekly wages of a Dorsetshire labourer were quoted by an eminent authority\* at 8*s.* Fifty years later, Mr. Caird, in an inquiry undertaken by him for the 'Times' newspaper, in consequence of the distress in agricultural districts, found exactly the same rate prevailing. So also in Devonshire, where 7*s.* were paid in 1796, only 8*s.* were paid in 1850. In Wiltshire the wages paid in 1796 had even declined, and the rate of 8*s.* paid in the former year was reduced to 6*s.* in 1850. In the north, on the other hand, in the same period, wages had advanced about 60 per cent.; and even with this increase the northern farmer was holding his own against his competitor in the south.

Comparison of  
wages in 1796  
and 1850.

and in 1850  
and 1870.

To advance a step farther:—The twenty years which followed Mr. Caird's inquiry, in 1850, were distinguished beyond any similar period in the history of the country by the growth of wealth and of manufactures. The railway system, which now covers the whole kingdom as with a network, was, at the end of that period, all but complete. The principles of Free-trade had been asserted and established. It will therefore be interesting to see how far the labourer had benefited in actual wages by this vast extension of commerce. In Dorsetshire he had now got 10*s.* a week; in Devonshire about the same. What, however, had been the effect in Scotland? Here he was in receipt of about double this amount, 18*s.* being a common rate, and 20*s.* being paid in very many districts!

Reasons for  
slow advance.

It is impossible to account for the slowness of the increase in the south, except on the ground of superabundance and inferiority of labour. It is certain that in the same time agriculture had not stood still. On the contrary, it was a period of great growth and development. The slow advance in the wages of

\* Sir Francis Merton Eden, in his 'State of the Poor,' 3 vols. 4to., London 1797. I may observe that Dorsetshire may be taken as a typical county for the low-waged southern districts of the kingdom.

agricultural labour was, therefore, anomalous; but it was easily accounted for. A superabundance of an inferior article always makes it unnaturally cheap. In this case, the labourer had not yet learned to *move*; he had not yet learned to work; he had scarcely yet learned to think. Emigration had indeed removed a few of the most spirited of his companions, but even this had scarcely been felt as a means of thinning the redundant ranks of the rural population.

Until this time, the farmer, in all but the most northern counties, had virtually been master of the labour-market. Any augmentation of wages which had so far accrued had been granted by him more from a sense of justice and from a knowledge of the increasing requirements of the labourer than exacted from him by the necessities of the situation. In certain districts it was not uncommon for him to fix on the price of a peck of wheat or a stone of flour (as the case might be) as the ordinary price of a man's daily labour, and without much reference to the rate of the other necessaries of life. But the price of wheat had been lowered by the operation of Free-trade, and it is obvious that such a principle or expedient could, under the circumstances of the case, be no longer possible or desirable.

Farmers had command of labour-market up to a recent date.

The relations of the two classes had often been denounced up to this period as of an unsatisfactory character, and from an economical point of view such was undoubtedly the case. Nevertheless an almost paternal authority was wielded by employers, and a sympathetic trust was engendered in the men, which, however little they might suit the rigid rules and cut-and-dried axioms of political economists, were not, perhaps, wholly disadvantageous to either party. The simplicity of country life in secluded districts often demands somewhat more than the ordinary rules dictated by purely economic considerations. The farmers and labourers were therefore drawn together more by the mutual ties of humanity and esteem for each other, than actuated by the more selfish motives of mercenary contracts.

Such was the state of things until a recent period. The great increase in the wealth of the country had not, in the meantime, been unaccompanied in the manufacturing districts by those disturbances between labour and capital which seem inseparable from such conditions; but hitherto the harmonious but one-sided relations of farmers and labourers had been interrupted by no such disputes. A great change in this respect was, however, impending; and British agriculture, at the close of the period I have been describing (1870), was on the eve of an important movement which entirely altered the current of affairs, and gave a sudden impetus to the upward movement of agricultural wages.

Labour Unions had worked in other trades.

Agricultural  
Labourers'  
Union of 1871.

In 1871 an Agricultural Labourers' Union was formed for the avowed purpose of increasing wages. In a short time it had extended its organisation over the whole of the country. Founded on the principle of trades'-unionism, the object was fair in itself, but a very aggressive and dictatorial tone was unfortunately adopted by the leaders of the movement, which naturally had the effect of incensing the farmers, who (whatever the rate of wages) had hitherto lived on the best of terms with their men, and in many cases had done them a thousand kindnesses which could scarcely be replaced by an extra shilling or two a week. By degrees it became clear that the old relations between these two classes were no longer practicable. The labourers were exhorted to strike, and to take the opportunity of the most critical seasons—hay-time or harvest—for so doing. Seldom had the rural population of southern England been more agitated than in 1872 and 1873, when meetings were continually held, and the principles of the new Union were propagated.

Its effect in  
transferring  
surplus labour

Advantage was taken of the movement by the agents of British and other colonies; and the legitimate plan of emigration to other countries, or to the manufacturing districts of England, was so successfully urged upon the men, that in a short time the scarcity created by these withdrawals had sent the price of labour up by 30 per cent. The immediate effect of this was the extensive substitution of machinery for inferior hand-labour. The farmer was thus enabled to recoup himself in some degree for his increased outlay; but it may easily be conceived that to a class accustomed hitherto, without much difficulty, to make their own bargains the new state of affairs was somewhat distasteful.

and on the  
relations of  
farmers and  
their men.

The relations of master and man, which up to this time had certainly been of a far more cordial and sympathetic character than those engendered by the manufacturing system, have thus, lately, received a rude shock, and one from which it may be doubted whether they will ever recover. The effect in the long run will, probably, be advantageous to both classes; but in the meantime a certain soreness has manifested itself on the part of the farmer, and a certain dogged intractability and surly independence of control on the part of the labourer, which do not augur well for the return of the old friendliness in their future relations. It is not, however, unlikely that these difficulties may initiate a new career of independence on the part of the labourer, in which case they need not be regretted.

Thus stands the question of British agricultural labour at the moment at which I write. The determined resistance of the East Anglian farmers in the spring and summer of 1874 to the demands of the Union led to a protracted lock-out, which told



heavily upon the funds of that institution, and displayed such unexpected resources upon the part of the masters that it arrested for the time the progress of the movement, and had the effect of showing the real strength of the combatants. Once tried, however, it can scarcely be expected that the principle of Unionism will be relinquished by the labourer; and though he may find it powerless to accomplish all the objects of his ambition, it is a weapon in his hands of which he may any day make fresh use, and of which it would be foolish on the part of the farmer to ignore the force.

---

## CHAPTER II.

### WAGES AND EXPENSES.

THE present ordinary wages in England for a common day-labourer vary from about 13s. a week in the south to 18s. in the north-east, and up to 20s. or 21s. in the extreme north.\* These sums, however, in the case of the lower-paid districts, do not represent the real earnings of an able-bodied and willing worker. In hay-time and harvest much higher wages are given; and piecework being at other seasons of the year very generally adopted for such work as hedging, ditching, and draining, a good midland or southern labourer is enabled to supplement these nominal wages to a large extent. In addition to these wages a house and garden are almost always given rent free to the shepherd, the herdsman, the waggoner, and, indeed, to any man to whom the charge of the live-stock of the farm causes Sunday—or any extra—work beyond the regular hours of labour.

Weekly wages  
of labourer.

It is significant of the real value of the labourer at present that, notwithstanding the discrepancy I have pointed out in the rate of wages, about the same sum is paid for the various piecework operations of the farm in districts where the lower wage prevails as in the higher-priced localities.

Perhaps no better test of the prosperity of the working classes of the greater part of this country can be found than in the consumption of butchers' meat. In this matter a wonderful increase has taken place of late years; and although the consumption of farm-labourers does not yet equal that of the higher-paid artisans, it is much greater with that class than formerly. The best proof

Condition as  
tested by  
consumption of  
meat.

---

\* The price of ordinary day-labour fluctuates, of course, to some extent with the supply and demand, the price of provisions, &c. Not so with yearly men. They are hired for a term, and for that period their wages are invariable. Nevertheless the day-labourer gets greater advantages in shorter hours of work, piecework, &c.

of this is the largely increased number of butchers' shops in the rural districts. Quantities of beef and mutton are now sold weekly in many small country villages, where formerly (and within the memory of men below the middle age) the butchers' stock was represented by a very meagre supply of pork alone.

Harvest wages.

In harvest the full energies of the labourer are directed towards making up arrears of rent, and getting together a little money for the bills of the past year. In the eastern counties, where high harvest wages are paid, the labourer is accustomed to depend entirely upon this season for all his extra payments; at other times living up to the full amount of his wages, whatever they may be, and taking no thought for the morrow.

Reduction of number of hands required rather than that of wages brought about by use of reaping-machines.

It is true that the reaping-machine is now an almost invariable accompaniment upon all farms in Great Britain, but its use has rather had the effect of reducing the number of hands required by the farmer for the gathering in of his corn than of curtailing the earnings of those employed. Indeed, at no time have higher wages been earned by the regular labourers of the farm than since the introduction of this implement. In the great corn-growing districts of Great Britain the period of harvest is always one of considerable anxiety, owing to the uncertainties of our climate; and the exigencies of the farmer often lead to immense wages being paid at this time of the year. In the Fen districts of Cambridgeshire and Lincolnshire a strong man will consider himself very ill-paid in harvest if he cannot earn 9s. or 10s. a day in following the reaper, and 7s. or 8s. when housing the corn.

Earnings of labourers still very large in harvest.

Lest, however, I should be accused of exaggeration on this point, I give the actual harvest earnings of a labourer in that locality in the autumn of the present year (1877), merely premising that the family consisted of a man; his wife; a girl, aged 16; a boy, aged 14; another, aged 11; and a small child about 9. I suppress the real name, but I guarantee the accuracy of the figures, which are taken from my own books:—

	£	s.	d.
John Jones' reaping and tying bill .. .. .	15	16	2
Do. carting account .. .. .	1	18	11½
Thatching do. .. .. .	4	16	1
Paid boys driving carts .. .. .	2	6	8

£24 17 10½

To this must be added 16 bushels of gleaning corn, picked up by the wife and two girls, and reckoned at 5s. a bushel, and we have a sum approaching 30*l.* earned by this family in the five weeks over which the harvest extended. In this case the man's wages could not be put at a less sum than 10s. per diem for the

whole period of harvest. I think some statement of this kind is necessary, in order to show that any argument derived from the current weekly wages common in the district, and which are 15s., would give a very false idea of this man's real position. The man in question, if asked, would probably assert that his wages were 15s. a week; and inasmuch as that is the standard of wages for ordinary work upon the farm in question, he would be so far justified in his statement. An examination of the books of the master, however, would show that they frequently amounted, even in winter, to as much as 21s. a week, and that (independent of harvest) the average earnings of himself and family during the summer months were about 1*l.* 10s. per week. There are doubtless plenty of cases where, owing to circumstances, to inability on the one hand or indolence on the other, the standard of weekly pay is seldom exceeded at the ordinary seasons of the year, but the case I have quoted is probably by no means a rare one, and I think it is valuable as throwing some light upon the question of the real wages of a working man in a medium-paid district. Here are the actual sums paid by the farmer to this man and his family in the past year:—

Illustration of the large wages often earned by able men.

*Earnings of John Jones and Family from Michaelmas, 1876-7.*

	£	s.	d.
Man, 47 weeks (average earnings 17s.) .. .. .	39	17	0
Wife, occasional earnings .. .. .	4	16	10
Girl, occasional summer work .. .. .	5	9	5
Elder boy, constant work .. .. .	12	8	4
Younger boy, summer and occasional .. .. .	5	11	4
Harvest account .. .. .	24	17	10½
Gleanings .. .. .	4	0	0
	£97 0 9½		

The average earnings of this family were, therefore, 1*l.* 17s. 3½*d.* per week. It is somewhat difficult, of course, to separate from this account the actual earnings of the man himself, since in harvest he laboured with his family; but putting his average earnings during that period at the sum I named above, viz. 10s. a day, we have about 21s. per week as the nett produce of his own bodily labour. I think these figures render it no longer doubtful that a good working man at the present day, even in the lower-wage districts, takes his fair share of the produce of the soil; and I can scarcely imagine that, without capital, he could in any other capacity turn his labour to more profitable account in the tillage of the land. I should, perhaps, add that this man pays a rent of 5*l.* a year for an excellent cottage and a rood of garden land adjoining, and that in addition he generally sets a few sacks of potatoes upon the farm, the land being

ploughed and manured for him, and the master and himself sharing the crop equally.

Nominal weekly wages misleading as to cost of work per acre.

Without, then, entering into a more minute account of the wage-question, which, unless very carefully examined, is apt to mislead the inquirer, I shall content myself with the assertion that, as a rule, the average amount of weekly wages paid in different parts of the country may be taken as no very unfair index of the actual amount of work performed by the average labourer of such districts. Whether the nominal weekly wages are 13s. or 18s., the amount of actual labour performed bears something like a relative proportion to these sums.

A remarkable fact may be cited in proof of such an assertion. The cultivation of arable land in Northumberland and in the south costs at the present time about the same sum per acre, cropped in the same manner; yet the nominal wages in Northumberland exceed those in the south by 50 per cent. The inference seems to be plain. The higher-priced workman performs a much larger amount of work. But it would be a fallacy to suggest, therefore, that it would be good policy on the part of the southern farmer at once to raise his wages to the northern rate. The habits of a race cannot thus suddenly be changed; a high-priced wage will, it is true, be probably followed by a higher standard of work in the long run, because no farmer could afford for long to pay high wages for inferior labour; but in the meantime the ordinary laws of supply and demand must take their course, and until these conditions are more equalised, it would be impossible, without injury to both parties, to endeavour to force the rate of increase.

Allowances to labourers virtually mean increased wages.

Before leaving the question of wages, I ought to point out that in many parts of the country considerable perquisites or "privileges," as they are called, are allowed the labourer which supplement his weekly wages to a large extent. For instance, in Dorsetshire, he generally gets his cottage rent free or pays a mere nominal sum of 1s. a week, or so, for it. Besides this he not unfrequently gets firewood free; a large piece of potato ground upon the farm, ploughed and manured ready for planting, and nearly always an allowance of cider (the southern beverage) every day during the year. In nearly every county in England some allowances of this kind are made, which renders it extremely difficult, without diligent inquiry, to get at the actual earnings of an average labourer; but it is to the advantage of all concerned that the custom, once universal, of giving part of the wages (at any rate during hay and harvest times) in beer or cider is gradually declining, and that money wages, which enable a man to spend what he likes on such indulgences, are taking their place. But in cases where the labourer is unable

from any cause to earn more than the ordinary weekly rate of wages, it may be interesting to ascertain how he spends them. I will take the case of a married man at the period of the worst pinch in his career, when two or three young children are entirely dependent on him, being themselves unable, from their tender age, to become bread-winners. A larger family than this generally enjoys a larger income (as I have shown by the instance given above), from the labour of some of the children, and I have not thought it necessary to consider the case of the man without family, since he is manifestly in a better position.

I will suppose my specimen to be in regular receipt of 14s. a week; then the following is, I believe, a fair example of his weekly expenditure.

Weekly expenditure of a "hard-up" family,

	s.	d.
2 stone bread, at 2s. 4d. .. .. .	4	8
½ stone flour, at 2s. 6d. .. .. .	1	3
4 lbs. meat, at 8d. .. .. .	2	8
½ lb. butter, at 1s. 6d. .. .. .	0	9
1 lb. lard .. .. .	0	10½
2½ lbs. sugar, at 3½d. .. .. .	0	8¾
¼ lb. tea, at 2s. 6d. .. .. .	0	7¼
1 lb. soap .. .. .	0	4
1 lb. soda .. .. .	0	1
1½ cwt. coals .. .. .	1	6
Paraffin oil for lights .. .. .	0	4
	<hr/>	
	13	9¾

I have selected a very unfavourable case for exemplification, but inasmuch as such instances are not unknown, I have taken some pains to ascertain the mode in which under such circumstances the money is usually spent. With the help of gleanings of corn and garden produce (and it is very rarely indeed that the labourer has not this advantage) the figures for flour and bread would be considerably decreased. And again, if able to kill a pig of his own feeding the cost of meat might be deducted, though in that case something must be added for the expense of fattening the animal. It will be observed that it takes the whole income of this man (under these most unfavourable circumstances) to maintain him, and that he is compelled to depend for all his extra payments upon his greater earnings during harvest, &c. The thriftless character of English cottage house-keeping will be deduced from this table. The English labourer's wife has seldom an idea of the preparation of those savoury pottages and messes which form so prominent a feature in the cookery of Continental households, and which are of such economical value.

I will now give another weekly budget, viz., the average and that of young

unmarried  
labourers.

disbursements of the young single men upon a large farm in Eastern England. The young men in question lodge with the steward of the farm and pay to him the sum of 2s. per week for the necessary accommodation, and for flour for puddings, pepper, salt, mustard, and the cooking of their food. They are hired by the year and draw weekly wages of about 12s. each, a considerable sum being retained until the end of their term.

	s.	d.
Lodging, cooking, salt, &c. .. .. .	2	0
2½ 4-lb. loaves, at 7d. .. .. .	1	5½
2 lbs. sugar, at 3½d. .. .. .	0	7
2 ozs. tea, at 2d. .. .. .	0	4
½ lb. butter, at 1s. 6d. .. .. .	0	9
6 lbs. meat, at 8d. .. .. .	4	0
Herrings, &c. .. .. .	0	6
2 ozs. tobacco .. .. .	0	6
	<hr/>	
	10	1½

It will be seen at once that these men live not only well but even somewhat extravagantly, allowing themselves nearly 1 lb. of butcher's meat a day, and also the extra indulgence of a considerable allowance of tobacco.

### CHAPTER III.

#### DOMESTIC LIFE.

I MUST now turn to the domestic life of the labourer, and first to the important subject of cottage accommodation. Many reproaches have been levelled at English farmers on the subject of the dwellings of the poor; and, indeed, there was until recently too much to grieve the mind of a philanthropist in the condition of many of our cottages. But in nothing has a greater improvement been evident than in this within the past thirty years. It is perfectly true that on some estates may still be seen squalid, dirty, and dilapidated dwellings, sometimes even unfit for the decent accommodation of human beings, or affording a poor protection against a fickle climate. But happily these have now become most rare exceptions. A great awaking has recently taken place as to the duties and responsibilities of the ownership of property. Moreover, the transfer of many large and encumbered estates to the wealthy members of the mercantile community has greatly assisted the movement. Land in England is held by the wealthy classes for the power and influence and importance which it confers, rather than for the revenue which it

Improvement  
of cottages  
of the poor.



yields, which is in almost all cases a very poor return upon the capital invested. But no people have been more ready than the *nouveaux riches*, when purchasers of land, to accept the responsibility connected with its possession, and to improve the condition of the cottages of the poor. On such estates, and on many of those held by the older members of the aristocracy, vast sums have lately been spent in this manner. The low mud-and-stud thatched tenement, with its two rooms on the ground-floor, has almost entirely disappeared. Such dwellings have been replaced by commodious and comfortable buildings of brick and slate, which contain every needful accommodation; and in some cases by really ornamental buildings, which add much to the pleasant aspect of the country.

But even in those cases where the landlord was unwilling to give the requisite accommodation for the labourers required upon his estate, but trusted rather to his tenants supplying themselves from the villages outside his property, and evaded the responsibility of erecting cottages, which, as far as the rent they pay, are always a very unremunerative investment—the question has been forced upon him within the last few years in a very practical manner. An Act of Parliament, passed some fifteen years ago, threw upon the Union, instead of the parish individually, the maintenance of the poor; the necessary funds for which are now, owing to this arrangement, collected from a vastly larger area. The consequence of the parochial plan had been that the owner of large estates had in some cases, as a matter of selfish policy, allowed his tenants to draw their supplies of labour from parishes outside his domain, which parishes thus became responsible for the relief of the poor whose daily work lay upon his property but outside their limits. It is easy to see how great an evil was encouraged by this plan. The villages outside the estate became burdened with the support of these men in sickness and in old age. The landlord had, in fact, often been obtaining a portion of his rental at the expense of his neighbours. The abolition of this injustice at last forced upon him the necessity of cottage building, since, now that he was made to bear his fair share of the relief of the poor, it was his interest to adopt the best means for the amelioration of their condition.

The present state, then, of the cottage accommodation for labourers is daily becoming a subject of greater satisfaction. The lover of the picturesque finds rapidly swept away those frail abodes which, however they might gratify his artistic taste, were yet sometimes a scandal to the country in which they abounded; and their places are supplied with buildings more

Benefit to  
community  
of Union  
Chargeability  
Act.

Tendency to  
scattering  
of the  
agricultural  
population.

substantial, more commodious, and more fitted in every way for modern ideas.

That aggregation of dwellings which we call a village has thus, under these circumstances, a tendency (so far as the agricultural labourer is concerned) to give way to the cluster of cottages placed in some suitable position for the needs of the farm. In central and southern England, where the holdings are of a moderate size, cottages are more frequently erected in pairs than otherwise; but in the north, where the farms are very extensive, long rows of cottages are the concomitant of each isolated farm.

Prize cottages. I attach an elevation and plans of a pair of cottages which were designed by Mr. James Martin of Wainfleet (Figs. 1, 2, 3), and which gained a prize of the Royal Agricultural Society at Manchester in 1869, for general utility of design combined with economy. This will give an idea of the kind of accommodation which is now considered almost indispensable in the cottages of the labouring poor.

Fig. 1.—*Front Elevation.*

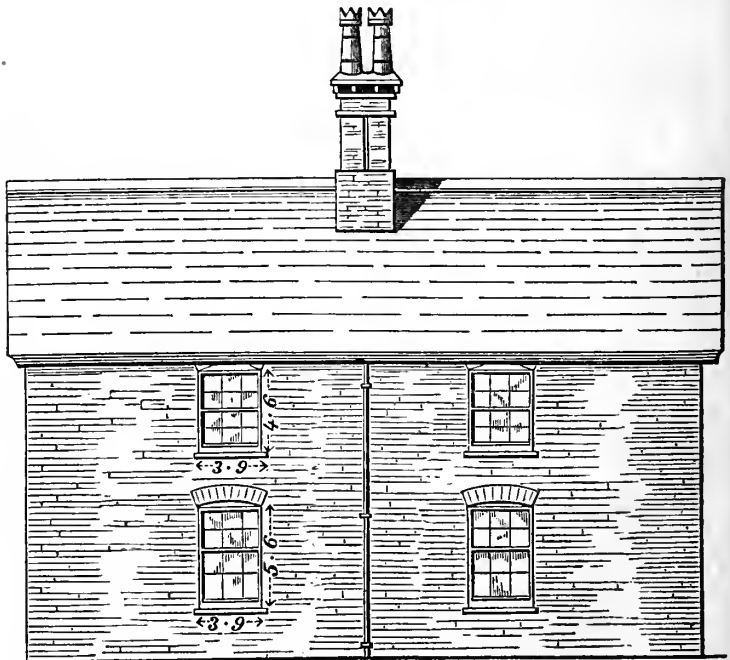

Fig. 2.—Ground Plan.

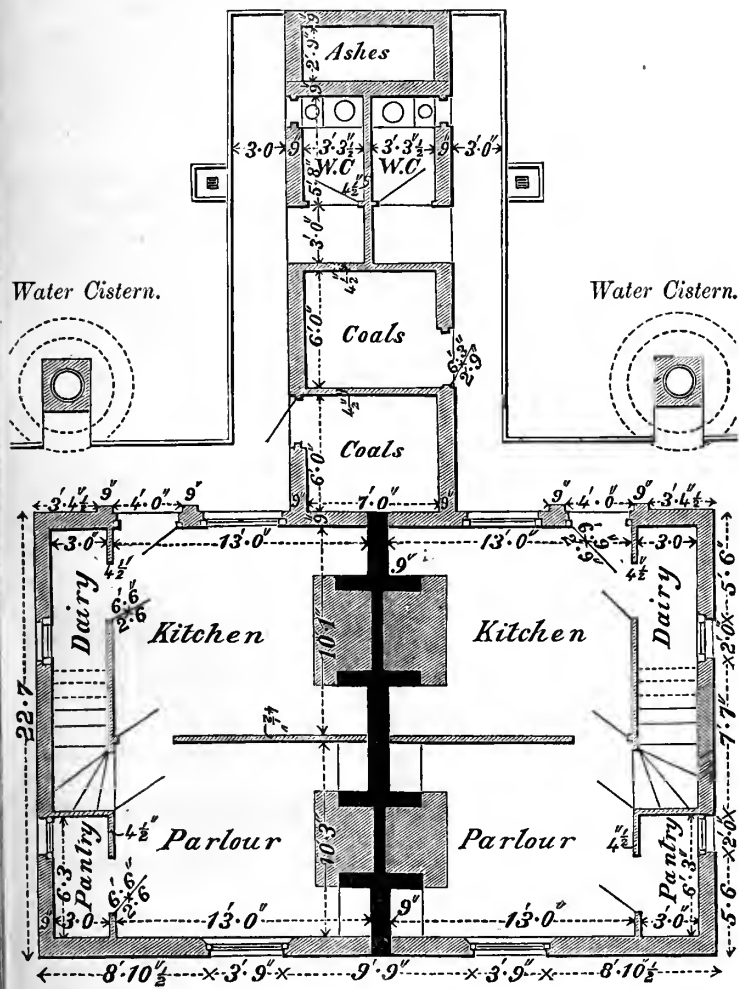
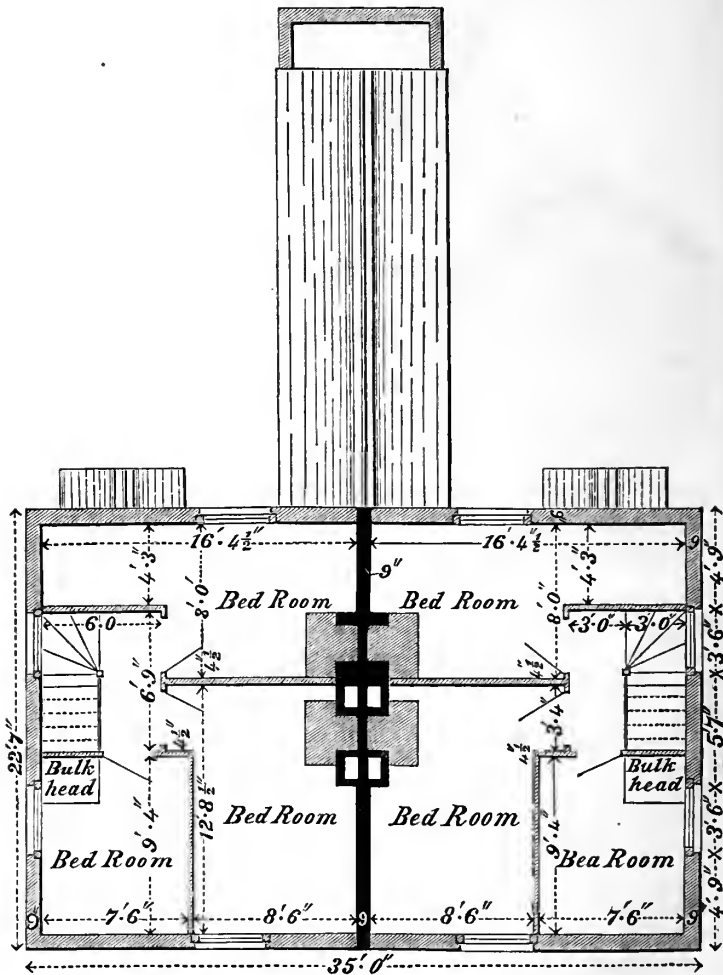
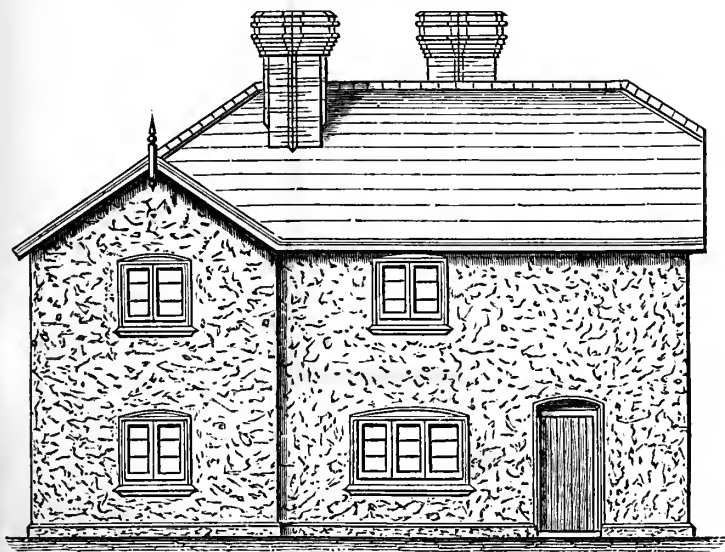

Fig. 3.—Chamber Plan.



I also annex some plans by Mr. Hine, which were commended and improved upon by the Judges at the Cardiff Meeting of the Society in 1872 (Figs. 4, 5, 6).

Fig. 4.—*Front Elevation.*



Mr. Hine's Cottages.

Both these designs merit attention. It will be observed that in each there are three bedrooms and two sitting-rooms, and that they contain all needful and proper accommodation for the decencies of life, as well as the comfort of their inmates.

In Mr. Hine's plan the cottages are ingeniously dovetailed together, and are thus in the form of an oblong, roofed by a single span. Thousands of such cottages as these may now be found scattered over every part of England; but it must be confessed that Scotland has not yet followed suit in this respect. From a dislike on the part of the labourer to live on more than one floor, most of the cottages are in that country built on that plan, and they are too often devoid not only of structural beauty but of decent accommodation. In many parts they present the appearance of long rows of barracks, and are entirely wanting in that neatness and trimness which is generally the accompaniment of English homes, however poor the inmates.

The plan and elevation (Fig. 7, p. 519) of a pair of the better class of Scotch agricultural cottages, taken from the 'Journal of the Royal Agricultural Society' for 1871, will give a good idea

Fig. 5.—Ground Plan.

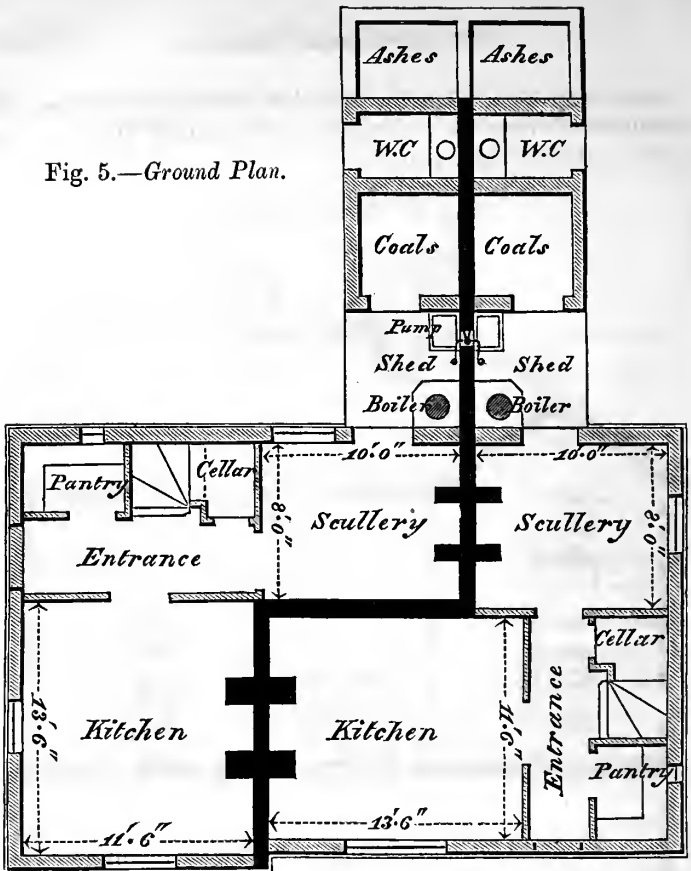
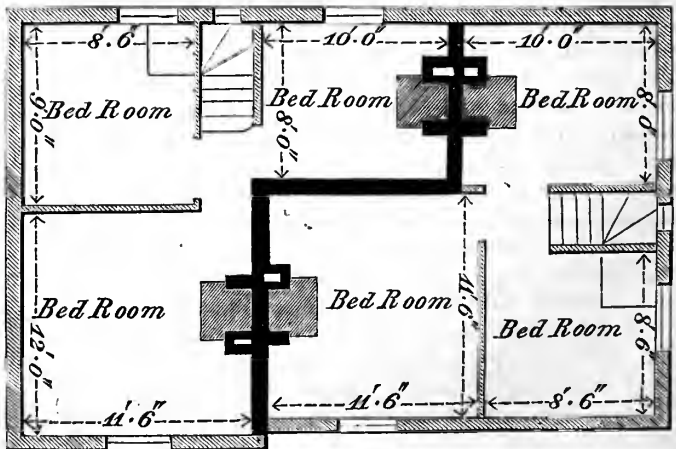

Fig. 6.—Chamber Plan.





of the prevailing features of these dwellings in that part of the United Kingdom.

Fig. 7.—Plan and Elevation of a pair of Cottages built by Alexander M'Neel Caird, Esq., at Genoch, Wigtonshire.

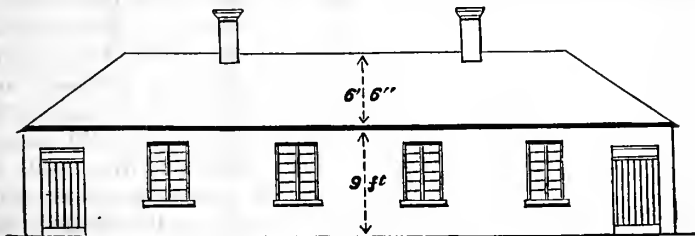

ELEVATION.

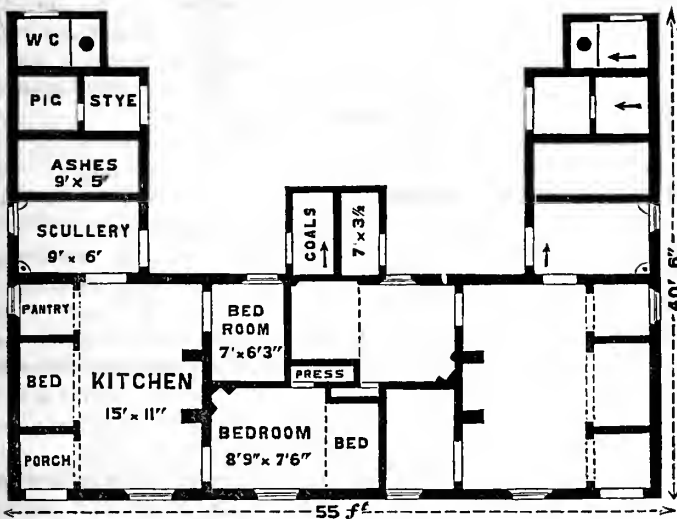

PLAN.

The arrows show the slope of the roofs of the outhouses.

Besides the comfort afforded by the English modern cottages, the labouring men who are their occupants are, in almost every case, provided with a piece of garden-ground adjoining, or with an allotment in close proximity to their dwellings. By this means they are not only enabled to grow a sufficiency of garden-stuff for the use of their families, but also to sell some portion of the produce. This garden, moreover, affords them the means of keeping a pig (the almost invariable accompaniment of a well-to-do labourer's occupation), and there are few cottagers at the present day who have not the satisfaction of

Modern labourers' cottages generally provided with gardens.

occasionally killing a porker of their own feeding for the use of their household. The necessary straw for this purpose is generally given by the master, and it afterwards provides a useful supply of manure for the garden. The quantity of land so occupied varies considerably; but it is seldom less than about a fourth of an acre, and is sometimes (though rarely) as much as half an acre in extent. The rent paid for a cottage of this kind varies very much. It is sometimes not more than 1s. a week, and occasionally as much, when occupied with a rood of land, as 5*l.* per annum. Now, as it would be impossible to build such a pair of cottages at the present day for less than from 280*l.* to 300*l.*, it is obvious that so small a rental leaves the owner with a loss; and that he has to recoup himself for his outlay from the rent paid by the farmer. This positive advantage to the labourer must not be lost sight of in considering his position. It is indeed equivalent to the addition of extra wages, and must so be considered. It is an anomalous state of things; but the farmer finds a certain advantage in having his men upon the farm, and handy for their work.

In Northumberland and some adjoining counties it is the custom to provide the "hind," or hired ploughman, in every case with a cottage, rent free. He has also a rood of land provided him on the farm for the growth of potatoes, for which the master finds the necessary horse-labour. He has, moreover, a good garden; his coals are carted free for him, and at the present time he is in receipt of 1*l.* a week in cash, wet weather or dry, and, even in cases of sickness, up to the end of his term, which is always for a year.\* There are very few districts where such large wages as these are prevalent, but I have before pointed out that a free cottage and garden are the ordinary privileges of carters and stockmen in very many parts of the country.

In Northumberland, again, a man who can stack or sow gets the same wages and privileges as I have mentioned, and an addition of either 6 bushels of wheat, or 2*l.* in cash. In that county a sufficient number of cottages is invariably included with the farm, and charged for in the rent thereof; and the tenant finds it to his interest to bind his men to the land by giving them their homes rent free. In return for such accommodation, the labourer is required to provide an unmarried woman worker whenever needed. These young women, who belong to a particularly fine and strong race, are used to all

Woman's  
labour much  
in request in  
the north.

---

\* I am informed by a friend, who is engaged largely in agriculture in Northumberland, that the rise in labour there has been 2*l.* per annum in the case of "hinds," and 50 per cent. in the case of women-workers, within the past ten years. Almost the whole of this remarkable increase has taken place in the last six years.

the work of the farm, and frequently perform tasks which it would severely tax a weakly southern man to execute. They get 1s. 6d. per diem when employed in ordinary work, and 3s. per diem for twenty days in harvest.\*

The fact that oatmeal is largely consumed by the farm-labourer in the north has been already alluded to, and I wish now to supplement that remark by the observation that he almost always keep a cow. About 8l. a year is the present rate paid to the master for this accommodation and for a supply of proper and sufficient food for the animal the whole year round. As far as the children of his household are concerned, he is therefore almost independent of supplies of animal food; and I cannot but attribute some of the fine physical powers of the northern race to the use of this nourishing and strengthening diet. Nothing would probably tend more to improve the breed of men in southern England than a general adoption of this practice; but at present it has been very little tried, and it is rarely that the peasant of those districts can procure a supply of milk for his children.

Cows kept by master for labourers in the north.

My observations with regard to cottages have principally related to those situated upon the farm, and under the direct charge and control of the landlord or his tenant. These, it will be gathered, are generally now sufficient for all ordinary requirements, and on many large properties they are models of neatness

---

\* For the purpose of comparison, I here give an actual agreement for the current year between a Dorsetshire farmer and his carters or horsemen, taken from the 'Agricultural Gazette' of October 22, 1877;—"This agreement between A. B. on the one part and C. D. on the other part, that the said C. D. is to serve the said A. B. as carter at the — Farm from April 6, 1877, to April 6, 1878, and is to receive for said service, house, garden, and 20 poles potato land, manured free; 400 faggots of furze and half a ton of coals, free, and 12s. per week; also 15s. extra in lieu of beer at hay-time, 2l. extra in lieu of beer for harvest time; 1s. extra for each 'journey;' 6d. extra per day at threshing with steam machine; 9d. extra per day when employed sowing corn or manure broadcast, and 6d. per day extra when sowing or drilling turnips. That the journeys be taken in turns by each carter. That carters will in all cases be required to be at their horses by 4 o'clock in the morning, so as to have them fed, groomed, and harnessed, and ready for work by 6 o'clock. The ordinary working hours will be from 6 o'clock in the morning till 2 o'clock in the afternoon, with half an hour for lunch at 10. The bailiff may at his discretion add to the ordinary working hours in seed time, for which the carters will receive 3d. per hour extra. Carters will be required to groom their horses, and keep the harness in a workmanlike manner. No carter will be allowed to work in his garden before 6 o'clock in the afternoon. That if it be known or proven to the bailiff that any carter has been guilty of neglecting his horses by not feeding them at the proper time, or by abusing them in any way, or by making himself incapable of managing them in a proper manner, such offence shall be considered a sufficient reason for the immediate discharge of such carter, and will forfeit his right to all cottage and garden privileges, and the amount of wages that may be due to him at the time of such discharge. No regular hours will be kept in hay or harvest time. Absence from work will in all cases be considered a sufficient reason for stopping the day's or days' wages."

Ancient village cottages not generally comparable in accommodation to modern ones.

and of comfort. It cannot be expected, in villages where every kind of property exists—from the hut of the squatter, filched in days gone by from the road-side common, to the cheaply run-up tenements of the speculator—that such a satisfactory state of things should exist; but powers have been lately conferred upon the local authorities by certain Sanitary Acts of Parliament, which give them considerable control even over such dwellings as these; and in cases where cottages become, from decay or any similar cause, unfit for habitation, they can be closed. It is also the duty of such authorities to provide safeguards against contagion and disease, and against the nuisances by which such disorders are propagated. Not only, therefore, has the sanitary state of such villages become improved, but habits of cleanliness have been enforced; and if the condition of their inhabitants will not compare with those I have above described, it is at least improving and hopeful.

Early career of youths in Yorkshire,

But, in order to make thoroughly plain the social condition of the labourer, it is necessary to turn to him at a somewhat earlier period than that when he becomes the occupier of a cottage, and assumes the responsibility of a householder. In England, the young farm-servant usually begins his career as a horseman, and for this purpose he generally leaves home and lodges upon the farm where he is employed. In some northern counties it is the custom for the farm foreman, or bailiff, and his wife to take charge of a number of these young men, and to cook and otherwise provide for them, for which charge they are paid a certain sum per head. At a typical Yorkshire farm described by Mr. Jenkins, in the 'Journal of the Royal Agricultural Society' for 1869, page 414, some particulars are given of the boarding, &c., of these lads, which may be interesting. It is there stated that "these lads, of whom there are seven at each farmstead, are hired at Martinmas (Nov. 12), and are paid from 9*l.* to 18*l.* each per annum, according to their ability, length of service, &c., the average payment being about 13*l.* They live with the hind, who is paid by the occupier of the farm 8*s.* 6*d.* per week each for their board. The hinds' cottages are designed specially with a view to prevent the hind and his family suffering inconvenience by so many young men living in the house; and the annexed plans"—which are reproduced in this report (Fig. 8)—"will show how admirably this has been arranged, the portion devoted to the hind and his family being almost entirely isolated from the living and sleeping rooms appropriated to the lads. The 'men's kitchen,' it will be seen, contains a staircase leading to the men's bedroom, which is not accessible from the main staircase; it also contains a copper, and is in direct connection with the washhouse and pantry." In some

Fig. 8.—Plans of a Hind's Cottage at Eastburn, illustrating the arrangement for Boarding Lads.

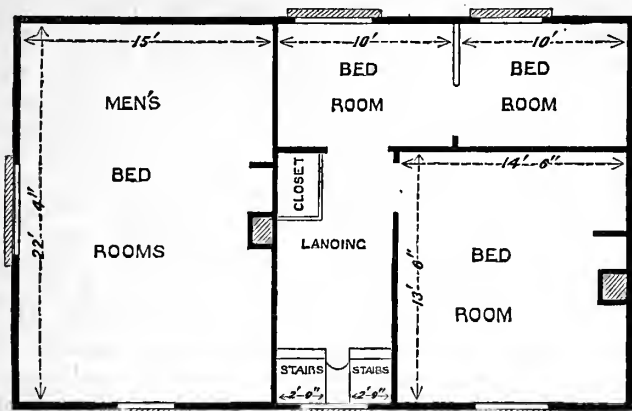

Bedroom Floor.

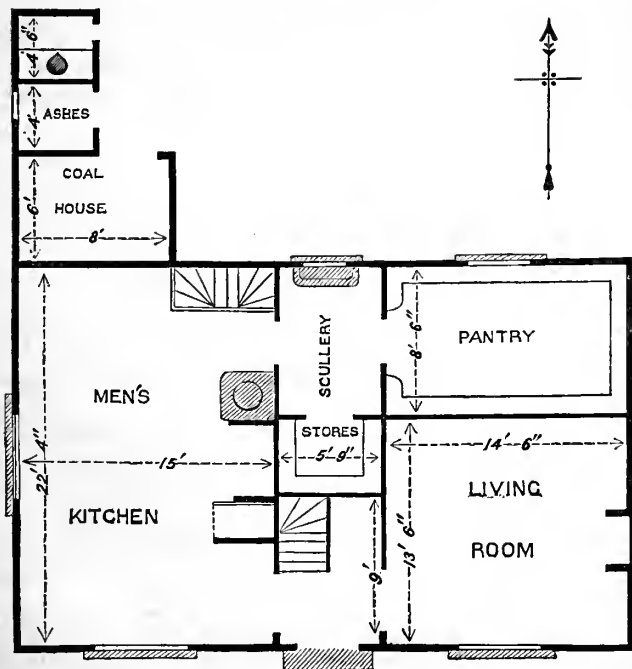

Ground Floor.

and in Scot-  
land.

parts of the same county it is not uncommon for these lads to become inmates of the farmer's own house, where they are generally properly cared for. In other parts of the country, where the villages are thickly scattered, they procure lodgings wherever they are able. But in Scotland, a custom has for some time been prevalent of providing separate accommodation for all the unmarried workers upon the farm. This plan is known as the "Bothy system," and has been a distinguishing characteristic of Scotch agriculture. A kind of kitchen is provided in a convenient position for the work, and an old woman is placed in charge, upon whom devolves the cookery, &c. The beds are over the stables and cattle-sheds, and the accommodation is altogether of a far inferior kind to that usual in England. Mr. Jenkins has pointed out (in vol. vii., new series, of the Royal Agricultural Society's 'Journal,' "Report on some Features of Scottish Agriculture") that needless blame has been attached to this institution, which is really in itself only a humble form of club; but it is certain that the ill-repute in which the system is held has induced many Scotch farmers to change its name whilst retaining its general character. The quarters, accordingly, where the young people congregate now-a-days are generally designated as "barracks" and "kitchens," a distinction, it must be confessed, without a great difference. It is, however, not necessary to dwell upon these features of the young ploughman's life, and I pass on to other considerations affecting his after-career.

---

#### CHAPTER IV.

##### PROVIDENT AND OTHER SOCIETIES.

FROM my remarks at the beginning of this Paper, I think it will be understood that the English labourer has not yet learned to save; and, on the contrary, that the Scotch labourer is usually a thrifty and frugal man.

I have entered somewhat fully into the causes which have worked against the Englishman. A lax administration of the Poor Law, and a habit on the part of the authorities of giving out-door relief in cases where there was no justification for such indulgence, have tended to weaken his self-reliance and his self-respect. But other causes have also been at work to the same effect, to some of which I must briefly allude.

Among the various efforts which have at different times been made to improve the condition of the poor, a foremost place must be assigned to "Benefit Societies," intended to afford relief



in sickness and a pittance sufficient to keep the subscriber from the parish in old age. These societies were established in great numbers a generation or two ago; but unfortunately, in too many cases, they were based upon a false foundation. A short period of fictitious prosperity has been too often followed by a sharp strain upon their resources (as the older members became simultaneously entitled to some relief from their funds), which has proved too much for their stability. It is little wonder if the numerous examples which have occurred of the failure of these Benefit Clubs should have damped the new-born desire of the peasant to render himself independent.

Benefit Societies frequently fail.

It would far exceed the limits imposed on me to notice the various difficulties which have arisen in the working of many of these Benefit Societies. These are matters which the wisest heads in English country affairs have long occupied themselves upon, and with some success; but it may be very briefly stated that the administration of the Poor Law, which to a great extent devolves upon the guardians of each Union separately, has been unfavourable to the development of such societies.

It is extremely difficult to teach a man provident habits when he sees the careless and thriftless equally considered with himself by the authorities deputed to administer the public funds. In too many cases the small sum which the scraped-together savings of youth or middle life have provided, by contributions to the Benefit Club, for the support of old age, are equalled or exceeded in amount by the sum which the guardians unreflectingly allot for the out-door relief of some imprudent fellow who has never made the effort to save, though his means and circumstances may have been identical with those of his more careful neighbour.

Weakness of Poor-law administration.

But notwithstanding the fate of too many of these societies and the difficulties against which they have struggled, it is pleasing to know that many of them have been instrumental of much good in rural districts. In one case the temptation of a garden allotment of half an acre at a very moderate rent, made by the owner of the parish, has attached the entire labouring population of the village to the Club, which gives in addition all the ordinary advantages of such institutions. But the Parochial Clubs have rarely been so successful as this. The larger County Societies, managed upon a sufficient scale by competent directors, and with an influential list of patrons and subscribers, have been found upon the whole far superior to the smaller clubs. I do not think it necessary to instance any societies in particular, because most of them are to a great extent supported by classes other than the farm-labourers, but I give about the usual rate of contribution which is sufficient in some of the best

Scale of fees of  
good Benefit  
Clubs.

of these larger clubs to secure a decent sum in sickness and in old age. A payment of about 1s. 8d. a month, in the case of a man joining at twenty-five years of age, will generally secure a sum of 10s. a week in case of sickness or bodily injury, and 8l. paid at death for burial expenses. For the additional sum of 10d. a month (making 2s. 6d. in all) he could, in addition to this, obtain old-age pay of 5s. a week, commencing at seventy.

Old Public-  
house Clubs  
the favourites  
of the la-  
bourers.

It is, however, useless to deny that the great benefits, afforded by such societies as these, are, as a rule, neglected by farm-labourers, who too frequently prefer (in view of the monthly meetings and carousals connected with such places) either to join the badly-organised Public-house Clubs, which have brought such discredit on these institutions, or have refused to attach themselves to any Benefit Society or to make any similar effort to free themselves in sickness and old age from the refuge of the poor-rate; and I am afraid I must add that much of the blame for this state of things rests upon the local mismanagement of the public funds which makes possible such anomalies as I have described. The rising generation, then, is for the most part growing up without much attempt to provide for its future; but the large support accorded by agricultural labourers, in days when their earnings were very much less than at present, to hundreds of the more worthless of these societies, proves that this is due more to want of will and lack of encouragement to provide for their own future, than to absolute deficiency of resources; and it has now become necessary to devise some more secure means whereby habits of economy and independence may be encouraged.

Savings-banks seem to afford some hope of success in this direction, and this means of providing against a rainy day is fast growing in favour with the working classes at large, as is proved by the vast increase in the amount invested at the present time compared with that of a few years since;\* but practically it is found that with the majority of farm-workers, unless a thing of this kind is brought home to their doors and its benefits thrust upon them by some zealous friend, it remains, so far as they are concerned, a dead letter. It is true that the clergy of various parishes and other friendly workers among the poor have, in some cases, succeeded in inculcating in early childhood habits of providence and forethought; but these are rare exceptions. Some excuse may have been afforded by the past low rates of wages; but if (as is the

\* In 1863 the Post-Office Savings-bank had 3,131,535l. invested. In 1875 this sum had risen to 23,740,389l.; and the other English Savings-banks had at the latter date 42,400,000l.

case) the unmarried ploughman of eastern or central England can now take at the end of his yearly term as much as 16*l.*, having drawn weekly wages sufficient for his maintenance during the whole year, surely such a man can and ought to save something out of these ample earnings.

Other means of saving compared with Benefit Clubs.

The advantage of the Savings-bank over the Benefit Society is obvious. Not only can the labourer choose with the former his own time for the investment of his spare funds, but also, under the Post-office system, he can draw his balance, when required, in any part of the United Kingdom. On the other hand, the Benefit Society, by the regularity of its levies, offers a greater incentive to continued carefulness.

But here, again, the hateful Poor Law steps between the man and his duty. With money in the Savings-bank he cannot, of course, claim relief from the rate. Therefore so long as, owing to an unwise and unjust administration of that law, he sees others around him who, notwithstanding their improvidence, are allowed to obtain out-door relief at their own homes on easy terms, I am afraid it is hopeless to endeavour to inculcate the doctrines of economy and providence.

I will just allude very briefly to some of the other attempts which have successfully been made to improve the labourers' condition. Clothing Clubs, Allotment Clubs, Village Clubs, with reading-rooms and other means of social entertainment, and Burial Clubs have all been more or less tried, and have all been found in some degree useful. The object of Clothing Clubs is, by the collection of small sums of money from the labourer's wife, and the addition thereto of subscriptions from charitable neighbours, to form a small fund for the supply of warm clothing on the approach of winter. This is generally provided at wholesale prices from the tradesman who furnishes it. An odd shilling or two, scraped together here and there, and sent by the children to the Sunday-school, or collected by some good Samaritan of the district in her rounds among the poor, secures the advantages of this useful but unpretending institution.

Useful Country Clubs.

The Village Club is generally promoted partly with a social and partly an educational object. It is intended to wean the labourer from the temptations of the public-house, and also to afford him rational amusement and opportunities of reading. A night-school, for those whose education has been neglected, is often held in connection with this institution during the long winter evenings.

The Burial Club affords the labourer the opportunity of securing for himself and the other members of his family the performance of the last ceremonies with decency and decorum.

County Shows  
and Ploughing  
Matches bene-  
ficial.

Moreover, I must not omit to notice that, in the actual daily work of the labourer, he is not left without some incentives to excel. Ploughing-matches are common in most counties, and are generally held under the direction of the local Agricultural Societies, which abound. For draining, for hedging, for ditching, for stacking and thatching ricks of corn, appropriate prizes are also commonly offered; and these trials of skill are looked forward to with anxious interest by the competitors. It is no uncommon thing on these occasions for one man to take prizes in two or three different classes of work, and the same individual is sometimes declared the winner of the ploughing, the stacking, the thatching, and the hedging prizes. Shows of cottage-garden produce are also frequently held at the same time, and the emulation and interest which they excite are the surest signs of the attraction and pleasure which a good garden offers to its possessor. Perhaps, also, I should not neglect to remark that prizes are frequently offered by these Agricultural Societies for length of service under one master.

---

## CHAPTER V.

### EDUCATION.

IF I now turn from these considerations, which all affect more or less the material welfare of the labourer, to the subject of his education, which is equally important, I am glad that in this matter also there is a progress to report which bids fair, at the present time, to keep pace with his worldly prosperity. It is true that hitherto the latter has been outgrowing his mental culture; but the education movement in England has lately been so rapid, that there is every hope of his children growing up with a satisfactory amount of elementary teaching. The better paid northern labourer has long recognised the value of education for his children; but the poorer southerner, who could ill afford to spare the addition which their labour brought to his own scanty earnings, was content, perhaps, to let them "shift for themselves" as he had done, and take their chance of picking up a little learning at the Sunday or the night-school, instead of undergoing a regular course of instruction. If the national system of education in England has hitherto been voluntary, so also has it been optional with the poor man whether his children should be taught or not.

All this, however, is altered now. Among domestic subjects,

Education  
until recently  
optional.

few of recent years have engaged the attention of our statesmen more than that of Education; and the recent Acts of Parliament having provided school accommodation in every part of the country, an indirect system of compulsion has been set on foot, which virtually compels every labouring man's child to become for the greater part of the year a regular attendant at the Board or National School. By obliging children under a certain age to exhibit a certificate showing either a definite standard of efficiency or a certain number of attendances before they can obtain employment, direct compulsion is avoided, but a pressure is put upon parents, which they can scarcely resist, of obtaining for their children a sufficient degree of education to enable them, at an early age, to contribute their mite to "keep the pot boiling." The necessary subjects taught in Board Schools at the present day comprise reading from standard lesson books, writing, including dictation, and arithmetic; but a large number of extra subjects are also included usually in the course of instruction. History, geography, English grammar, vocal music, drill, and drawing, are all subjects which are more or less taught, according to the efficiency of the teachers and the aptness of the pupils. It is scarcely necessary to observe, however, that few farm-labourers' children (whose labour is generally absolutely necessary for as much of the year as possible for their own bodily well-being) attain to any great efficiency in these higher branches of instruction; but the day has gone by when the stigma of ignorance in the fundamental principles of elementary instruction need rest on any labouring man's child.

Now virtually compulsory.

Subjects of education.

The school fees payable at Board or National schools for the full course of instruction are generally about 2*d.* a week in the case of the elder children, and 1*d.* each for the younger ones; and even these can be remitted, in cases of absolute necessity, by the School Board or the Guardians of the Poor. The usual hours of schooling are from 9 A.M. to 12 noon, and from 2 to 4.30 P.M. on every day of the week except Saturday and Sunday. There are holidays of a fortnight at Christmas, and of a month or more at harvest. The number of attendances necessary to qualify a child for agricultural employment is 250, which are generally filled up in the autumn or winter months, so as to enable him to assist his parents by his labour in the spring and summer. As two attendances can be made in each day, about half the year must necessarily be occupied with school work, except in the somewhat rare event of the child becoming entitled by previous examination to a dispensation of this rule. After the present year (1877) no child can go to

School fees.

work under ten years of age under any circumstances, and somewhat stricter rules as to proficiency and attendance will be enforced.

Vastness of  
the change.

Fenced in by such regulations as these, it is certain that a new era has commenced in the education of the farm-labourers' children. The step has been a prodigious one, and the suddenness of its operation has entailed considerable hardship on parent and employer; but there can be no question of the ultimate benefit to all classes from the movement, nor of the importance of its issues to the nation at large.

The system of working children in "gangs," or large parties superintended by an overlooker, was some time ago put under close and stringent regulations, and (as far as children employed in agriculture are concerned) the Education Acts just mentioned seem to complete the legislation necessary for their protection and instruction.

---

## CHAPTER VI.

### EARLY LIFE, DAILY WORK AND RECREATION, ETC.

Daily life of  
the labourer.

LET us now see what the daily life of a midland or southern labourer is like in England, and I will begin with him at a very early age. My "type" was born before the date of universal schooling. At eight or nine years old he was presented to his master by his father, as an eligible candidate for office of "bird tender," or scarer, and in this interesting pursuit he passed a considerable portion of his time, until he became old enough and big enough to drive, and subsequently to hold a plough. Not altogether unprofitable were these lonely periods to our young acquaintance. The schoolmaster, indeed, in vain asked after his recent charge; but Tom, who was not deficient in natural wit, was learning lessons out of a larger volume than the spelling-book—the book of nature. He examined the seed in the land, to see if it had properly germinated. He found his way frequently and surreptitiously to "Bill" on the next farm, and compared notes (and knuckle-bones) with that young gentleman. He learned the name of every horse upon the farm, and their ages and capabilities for work were matters of mysterious knowledge and criticism to him. The other animals also claimed a share in his attentions, and the wild creatures of the air and field had their habits noted in his memory. He knew where the great carrion-crow built her nest, and where the haunts of the owl and jackdaw were. The hare did not make



her form without his remark, and his cunning eye could detect her as she lay therein at a distance which would baffle far more practised persons. In these early years his sole chance of book-lore lay in the influence of the night and Sunday schools; but he was not much pressed on this matter, and he became decidedly more qualified for the post of ploughman than of clerk.

Promotion came in time, and the first great object of his ambition was gratified when he held the plough and obtained command over the much-enduring horses. At twenty years of age, being a decent ploughman and a strong lad, he got a situation as horse-keeper or carter, and was now in receipt of ample wages, and with a fair prospect before him. But one fine day he found himself wending his way to church, dressed in his best, and with a somewhat smart-looking damsel, a little younger than himself, by his side. A home has been promptly taken; a table, a bed, and a couple of chairs thrust therein; and now behold him in his new capacity as a married man! From this time his daily life is somewhat as follows:—He rises early, makes the fire, and prepares his simple breakfast, consisting of a cup or two of hot tea, and some hot toast or bread with butter or dripping. Shortly after 6 A.M. he sallies forth, being generally expected to be at his work at 6.30. The basket which he carries with him, and which contains his provision for the day, includes a loaf of white bread; a piece of bacon or beef, more or less substantial, according to his means; a bit of cheese or butter; and a bottle containing cold tea or coffee. (I have previously remarked that in the cider counties of England an allowance of about two quarts a day of that beverage is generally made to each man the year through. The custom, however, is gradually diminishing, and a money payment taking the place of the allowance.) The garden, also, always furnishes him with some relish. In winter two or three onions and some potatoes, in summer a lettuce or two, or some broad beans or peas, are placed beside his other provisions, and the whole is neatly covered with a white cloth. The bread in question is, of course, the staple food with him, and a word or two must be said about it. It is always wheaten bread, and of the whitest colour and the finest quality which it is possible to procure from the baker. In nothing is an English labourer's wife more particular than the colour and quality of the bread which she buys. No admixture of meal is tolerated, and it is generally eaten when one or two days old. "The better the bread" (*i. e.* in whiteness and fineness) "the further it goes," is with her a maxim of daily life. An experience so extensive as that which

she possesses on this point might command some attention, were it not stamped as fallacious by the example of many other nations, and by the researches of the medical profession. As he marches to his work, let us look at him personally and see what he is like. He is of middle size; perhaps between 5 feet 6 inches and 5 feet 10 inches in height; somewhat spare in figure, but compact in build, and bearing the healthy appearance common in the country. He walks with a slow gait, as if it were against his principles and contrary to his life-long practice to hurry. In person he is clean, and at the beginning of the week presents a smooth-shaven chin and upper lip, which towards the end of the week gives way to a somewhat rough and grizzly aspect. His trousers are of corduroy or fustian, and his coat of the same material, or he wears knee-breeches and gaiters of stout leather; a loose cotton handkerchief tied lightly round his neck; a slouch hat protecting his head and face from the sun and air, and a pair of very thick boots, the soles studded with nails, complete his attire.

Having received the necessary orders for his work from the farmer or bailiff, he soon makes his way to the scene of action. His first stoppage is at 9 o'clock, when he begins the attack upon the contents of his basket. At noon he has no difficulty in finishing these; and an hour's rest now allows him time for the extra indulgence of a pipe of strong tobacco. If no smoker, in summer a short nap under a shady tree, or on some soft straw, fills up his mid-day rest, and at 5.30, with many a preliminary glance at his watch, he leaves his work for the day.

The necessary attention to the pig, and a short period of more congenial labour in his own garden, for which he has naturally reserved some of his forces, fill up the interval till supper is ready, when he is called in by his wife to partake of the one real family meal of the day. His children are now gathered round the board after their day's schooling or work, and supper consists of an ample supply of pudding for these younger members of the family, a piece of bacon, or a savoury pudding of chopped meat flavoured with sage and onions, a large dish of potatoes, and such other vegetables as the garden affords. The children get some sugar, or treacle, or dripping with their pudding, but not a very large supply of meat can be afforded them.

The fare is simple, but the healthy exercise and pure air enjoyed during the day enable him to bring to it an appetite which the rich man, with his dainty cates, might often envy. After supper he takes, if it be summer, another spell of work in his garden, or has a gossip with a neighbour. In winter he perhaps

gets one of his children to spell out for him some portion of the well-thumbed local newspaper, which now enters almost every cottage; and then retires to such slumbers as only one with few cares and a healthily exercised frame is able to enjoy.

But occasionally (and no wonder) the monotony of this simple existence palls upon him, and he joins a neighbour and walks down to the public-house. In winter the bright fire there, the more ample space and the presence of company, are especially apt to attract him, and the extra indulgence of a glass or two of somewhat "heady" beer is not unlikely to produce an excitement followed by absolute intoxication. But this is a rare event. The Licensing Acts close the doors of his resort upon him at an early hour, and the evening saturnalia, of which the village public-houses were formerly the scene, have given way to more moderate expressions of good fellowship and more sober enjoyment.

So the year runs its course. In winter his hours of work are shortened, but his wages remain the same. In hay-time he is later at night, rarely reaching home before 8 o'clock; and in harvest he husbands all his powers for the important task of making up his arrears of rent and paying his tradesmen's bills. His hours of work are of course now considerably lengthened; the quality and kind of his food are improved, and he allows himself, or is allowed by the farmer, from 6 to 8 pints of tolerably strong beer a day. Shortly after harvest he pays his landlord, his baker, his shoemaker, and any other tradesmen who may happen to be his creditors, and starts afresh upon another year with a clean pocket, but a light heart, if his earnings have but enabled him to settle these accounts and to get a few necessary articles of clothing besides.

His holidays are not numerous. The village feast or fair, or the Harvest-home entertainment, are the occasions of almost the sole break in the routine of work. In comparing his lot, however, with the Continental peasant, it must not be forgotten that every seventh day in the year is with him a day of entire rest, and that only the absolutely necessary work in connection with the live-stock of the farm is ever performed on that day, and that by men specially hired and paid for the purpose. On Sundays he appears at church or chapel dressed in broadcloth, and with a very gorgeous waistcoat faced with crimson plush and ornamented with countless buttons; or he makes his holiday the opportunity of a visit to a child in service or a far-distant relative or friend; or, more often still, he "takes it out" in thorough rest, in summer lounging or lying under a shady tree, and in winter stirring a very short distance beyond his cottage

Sundays and  
other holidays.

door, and either reading his Bible, or gathering from the newspapers, as well as his education will allow him, the news of the neighbourhood.

Gradual dimi-  
nution of  
household.

At the age of thirteen or fourteen (or even younger) his girls procure situations as domestic servants, for which the demand in England far exceeds the supply. He is thus early relieved of all charges as regards them. His boys remain with him somewhat longer, but at about seventeen or eighteen they also leave the parent nest and seek their own livelihood. When once his family has flown, being still in the prime of middle life, a period of comparative comfort ensues, and, beyond the ordinary aches and pains of humanity, he has few cares to trouble him. His health (unless for a touch of rheumatism) is generally excellent. The guardians are somewhat indulgent to him as a steady fellow who has brought up a family and, so far, done his duty to his country; and when old age creeps upon him it finds him still a hale and hearty man, and able, even at seventy summers, to earn a living equal to his few and simple wants. Frequent visits are now paid him by the clergyman of his parish, and the squire and his lady are not unmindful of the dispensation of those creature comforts which mitigate the ills of old age. If he can possibly manage it, he now contrives to put a trifle by for the decent performance of the last offices connected with his earthly career; but if this is impracticable, it does not give him much concern that the parish will be called upon to pay a portion of these expenses. His wages have not been excessive, and if his old employers have once more to put their hands in their pockets on his account, it is only a just fulfilment of his final dues, so, not without a touch of sardonic philosophy, he passes away.

Celibacy very  
uncommon in  
the class.

If this is not an entirely enviable lot, it is at least wholesome in its simplicity, and free from the many temptations of the large town. The opportunity for saving to any extent, however, offered by the larger wages of the artisan of the town does not occur to him. The time for that passed with him when he committed himself to the matrimonial state. The English labourer nearly always lacks the self-restraint of celibacy. At a very precocious age his thoughts begin to hover upon the subject of marriage, and he seldom allows more than three- or four-and-twenty summers to pass over his head before he takes the step of matrimony. Such improvidence is often dearly paid for in after-life, but the idea that, come what may, "the land has got to support him" is so deeply engrained in his nature, that prudential considerations such as influence other classes scarcely raise even a flutter in his breast.

I have selected a very ordinary type for my specimen. I have only sketched the daily life of a fairly industrious, honest, sober, and steady fellow. I could instead have depicted the careful and saving man, who did not marry until he and his partner had a good round sum in the savings-bank, and who by middle age had succeeded in making himself the farmer and master instead of the servant; or, on the other hand, I could have drawn the idle, obstinate, disobedient, and drunken scamp, whose certain end, when not the gaol, is the workhouse, where he becomes by his frequent visits the *bête noire* of the guardians and a constant burden on the funds of the ratepayer. However, it is not worth while to trace the downward career of such a one, which may be easily imagined.

I have attempted in these pages to give a fair and unbiassed account of the English labourer, a class with whom I have been largely engaged, and of whom I can therefore lay claim to some knowledge. I have not concealed the defects in his character, nor the causes which have conduced to foster those defects. The lax administration of the Poor Law is, I believe, at the root of half the ills suffered by the poor man; and until the labourers of England, now in receipt of ample wages, learn the virtues of prudence and economy, of self-restraint and self-reliance—until, in a word, they copy (in these matters) the example of other nations than our own, and until they feel that it is a shameful thing that people, in many cases more needy than themselves, should be taxed for their improvidence and recklessness—it is, I fear, hopeless to look for their further advance.

Thrift little understood or practised, as a rule.

Among social problems of the present day, few are of greater importance perhaps to Englishmen than those which concern the well-being of the working classes of their country. Much may be done to open their eyes to the advantage of prudence and forethought, and to help them to exercise these too much neglected qualities; but the day has now come when the labourer, if he is to rise in the social scale, must look mainly to himself. If in the dark days of the past the laws seemed against him, it is no longer so. He is a free man, free from conscription, or compulsory service in the army, and the equal of those about him. Legislation has done its best for him and his children. He is at liberty to move wherever he can get the best return for his labour. He is practically the only untaxed man in the community, since (except in the article of tea, on which a small duty is still paid) he can if he chooses, by abstinence from those articles, avoid the imposts on beer, spirits, and tobacco. An admirable and, practically, free education is granted to his

Advantages enjoyed by the labourer in the present day compared with the past.

children. It only needs the inculcation and exercise of those ordinary virtues which seem the attributes of other races more than of the English people, and which I have insisted upon, I fear with some iteration, to insure his continued growth in weight and influence, and to procure him in the future a position not inferior in all the material accompaniments of civilisation to that of the tillers of the ground in any country upon the face of the earth.



IX.

THE INFLUENCE OF

CHEMICAL DISCOVERIES

ON THE

PROGRESS OF ENGLISH AGRICULTURE.

BY

DR. AUGUSTUS VOELCKER, F.R.S.,

CONSULTING CHEMIST TO THE SOCIETY.

THE UNIVERSITY OF CHICAGO

PHILOSOPHY DEPARTMENT

PHILOSOPHY 101

## CONTENTS.

---

### INTRODUCTION.

Influence of Scientific Researches—Discrimination between Theoretical Speculations and Scientific Facts—Value of Rothamsted Field Experiments  
Pages 541-542

### CHAPTER I.—*The Soil.*

Use of a knowledge of the Chemical Composition of the Soil—Analyses do not always show its Agricultural capabilities—Absorbent Power of Soils—Variableness of their retentive Powers—Absorption of Ammonia—Effect of Rain on Top-dressings of Ammoniacal Manures—Best time to apply Artificials—Use of Lime and Marl—Value of Lime in poor sandy Soils—Influence of Lime upon Manures containing Soluble Phosphates—Beneficial results of Bone-dust to Root Crops on Light Land—Closer approach of Practice and Science, in consequence of wider diffusion of Chemical Knowledge—Questions often answered by the Analyses of Soils—Influence of Experiments on Modern Cultivation—Permanent fertility raised by constant Manurings .. .. . Pages 542-550

### CHAPTER II.—*Continuous Cropping.*

Experiments on Continuous Cropping—Tabular Statement of Results—Effect of different Manures—Modifications in Cropping by using Artificials—Continuous Corn-growing by Mr. Prout—Composition of the Soils of his Farm—Cost of his Farm—Steam Cultivation—Annual Expenditure—How Artificial Manures are applied—Results of sales of Crops—Corn Crops grown—Return per Acre—Land improved in Value .. .. . Pages 550-556

### CHAPTER III.—*Manures.*

Improvements in Land Cultivation—Powers of Nitrogen—Sources of Nitrogen in Vegetation from the Atmosphere—Non-ability of Plants to assimilate free Nitrogen from the Air—Proportion of Nitrogen unrecoverable—Carried away by Drainage—Results of investigation into composition of Waters of Land-drainage—Farmyard Manure when best applied—Artificials—Nitrate of Soda only retained in Land one Season—Increase in the use of Artificials—Magnitude of the English Manufacture—Raw Materials used—Phosphatic Materials—Nitrogenous Manures—Saline Alkaline Materials—Uses of Manures for Corn—For Roots—Disposal of Town Sewage—Effect of Soil

and Air—Soluble Manuring constituents of dilute Sewage not concentrated in the Land by Irrigation—Proved by Analysis—Failure to purify by Chemical Agents—Means of purifying Sewage—Clay Soils unfit for Irrigation—Crude Sulphate of Alumina best precipitating agent—Disposal of Town Sewage .. .. . Pages 556-568

#### CHAPTER IV.—*Improvement of Permanent Pastures.*

Recent attention to the subject—Experiments at Rothamsted—Effects on the Herbage—Results of the Experiments—Farmyard Dung best  
Pages 568-570

#### CHAPTER V.—*Feeding and Rearing of Stock.*

Early Maturity—Value of Chemistry—Linsced-cake—Earth-nut-cake—Cotton-cake—Cocoonut-cake—Locust-beans—Rice Meal—Durra Grain—Cereals—Rearing and Fattening Stock—Experiments—Proportion of Nitrogen in the Food recovered in Manure—Estimated Manure-value of Foods—Money-value—Mr. Lawes's Table—Probable losses in Practice  
Pages 570-577

#### CHAPTER VI.—*Industries Attached to the Farm.*

English Farmers strictly Agricultural—Beet-root Sugar—Distillation of Spirits—Influence of Manure—Climate favourable to growth of Beet-root—Selling Beet-roots unprofitable to English Farmers—Cheese Factories—Cheddar Plan—Aylesbury Dairy Company—Condensed Milk Manufacture  
Pages 577-580

#### CHAPTER VII.—*Experimental Stations.*

English Experimental Stations—Scotch—Mr. Lawes's, Experimental Station—Experiments on Vegetation—Rainfall—Drain-gauges—Experiments on Animals—Application of Town Sewage—Woburn Experiments—Particulars of Experimental Lands—Plan of the Field Experiments—Subdivision of Plots—Rotation Experiments—Feeding-experiments—Rotation adopted  
Pages 581-588

## THE INFLUENCE OF CHEMICAL DISCOVERIES

ON THE

## PROGRESS OF ENGLISH AGRICULTURE.

## INTRODUCTION.

IN reviewing the progress of English Agriculture since 1860, one must be struck with the powerful influence which the dissemination of sound scientific principles, the results of numerous chemico-agricultural researches, has exerted upon the various branches of practical agriculture. Influence of scientific researches.

The improvements connected with cultivation and farm management are both numerous and important, but they chiefly spring from one source, which in itself is the most characteristic feature of the last thirty or thirty-five years, and which, in the language of the late Sir Harry Stephen Thompson, may be described as the substitution of sound reasoning and arithmetical calculation for the empirical knowledge relied upon by our ancestors.

Englishmen enjoy the reputation of possessing a keen appreciation of those discoveries in science and art, the application of which is likely to be useful in practice. It is not surprising, therefore, that Chemistry, a branch of science which has rendered many valuable services to almost all industrial pursuits, should in England have exerted a more direct and powerful influence on the cultivation of the soil, the rearing and fattening of stock, and upon farm management generally, than in most other countries. It cannot be said that British agriculturists, as a class, are more highly educated; or more intimately acquainted with the results and teachings of those scientific investigations which have a more or less direct connection with agricultural practice, than Continental agriculturists occupying an analogous position in social life. The reverse, probably, is the case; and this is generally felt to be so by English farmers themselves, who, if at all inclined to take credit to themselves, boast of their practical skill and experience, and certainly not of their scientific knowledge. Nevertheless, British agriculturists, as a rule, are keen Discrimination between theoretical speculations and scientific facts.

to discriminate between purely theoretical speculations and carefully ascertained scientific facts; quick to appreciate the value of scientific inquiries, the results of which are likely to find application in agriculture; and ready at once to carry into practice those suggestions of the man of science which promise to lead to practically useful results.

The applications of chemistry to the cultivation of the soil, cropping, rearing and fattening of stock, and general farm practice, are so numerous, that, without exceeding the limits of a necessarily concise report, it is impossible to give anything like a full account, even in outline only, of the labours of English agricultural chemists in connection with the progress of agriculture since 1860.

The reader has only to refer to the volumes of the Royal Agricultural Society's 'Journal' published since 1860, in order to perceive how utterly impossible it is to condense with utility into a brief report the most prominent results embodied in the contributions to its pages by agricultural chemists. Messrs. Lawes and Gilbert's papers in the Society's 'Journal' from 1860 to 1876, giving accounts of their laborious scientific labours, and long-continued highly important field experiments, alone occupy the space of several goodly volumes, and there is not one of Messrs. Lawes and Gilbert's invaluable contributions to scientific agriculture which has not had a more or less direct influence upon the progress of British agriculture. For the information of French agriculturists who may not have seen M. Ronna's work, it may be stated, in passing, that this gentleman has lately published in French, in one large volume, an admirable account of the Rothamsted chemico-agricultural researches.

Instead of a dry and systematic account of the progress of chemistry in its application to agricultural practice since 1860, I will endeavour to illustrate by some examples in what way the application of chemical knowledge to the cultivation of the land, systems of cropping, the fattening of stock, and the industries connected with some farms, has borne good fruits in England since 1860.

---

## CHAPTER I.

### THE SOIL.

BEGINNING with the soil, it may be observed that although our knowledge of the inherent agricultural capabilities of different classes of soils is still very far from being perfect, the researches of chemists since 1860 have brought to light important facts, which have led to improvements in the cultivation of the land.

Value of Rothamsted field experiments.



A knowledge of the chemical composition of the soil upon which it is desired to raise certain crops, and of those soil-constituents which are essential to their very existence and perfect development, is obviously useful to the farmer, for it will show him, for instance, in a direct and ready manner, whether the land is deficient in lime, and would be improved by marling or liming.

Use of a knowledge of the chemical composition of the soil.

At one time both farmers and chemists thought analyses would solve all the difficulties which practical men meet in cultivating soils of low fertility, the occupier of which experiences much disappointment by his frequent failure to raise remunerative crops upon them.

Further experience, however, has proved that in many cases mere numerical analytical results are not calculated to assist the farmer in improving his land, or to inform him of the cause of non-success in growing certain crops—why, for instance, he cannot grow clover on some soils. There are many apparently similar soils—that is to say, soils in which analysis shows like quantities of the same constituents—such as potash, soda, lime, magnesia, phosphoric, sulphuric, and silicic acids—and in which, notwithstanding, the same kind of manure produces a good result in one case and an unfavourable one in another. This plainly shows that the analysis of soils, as usually performed by chemists, does not afford in all cases a sufficient guide to an estimate of their agricultural capabilities, nor to point out the kind of manure which is particularly well adapted for the special crops intended to be grown. Even the detailed analysis of a soil usually gives only the proportions of its different constituents, and generally without reference to the states of combination in which they exist in the soil; and it is altogether silent on the property possessed by all soils in a higher or lower degree, of effecting striking and important changes in the manures which are incorporated with the land. Analyses of soils, therefore, it must be confessed, are often disappointing in their practical bearings. However, the obvious insufficiency of bare analytical figures to afford satisfactory answers to the questions which agriculturists put to agricultural chemists have had the effect of stimulating further scientific inquiries into the mysteries of soils, and these inquiries have not been without success. Just in proportion as our scientific knowledge of the properties of soils has been increased, the practical utility of these investigations has been enlarged.

Analyses do not always show its agricultural capabilities.

The discovery by the late Sir H. S. Thompson of the absorbent power of soils (or the power possessed by a soil to decompose and retain for the sustenance of plants the ammoniacal and other salts which form the most valuable con-

Absorbent power of soils.

stituents of manure), and the highly important investigations of Professor Way on this subject, have had a direct and beneficial influence on practical agriculture, more especially in relation to the rational treatment and the application of farm-yard manure, and the economical application of artificial manures.

Professor Way's painstaking and highly valuable investigations have shown that manuring matters in contact with soils undergo remarkable changes, and fully justify the statement that plants do not take up mineral food in the simple state of solution in which we add it to the soil in the shape of manure, but in totally different states of combination. The publication of Professor Way's researches on the absorbing properties of soils has given a new direction to the chemical investigations of soils, and this field of inquiry has been successfully cultivated on the Continent, especially in Germany, by Liebig, Knop, Henneberg, Stohman, Brustlein, Peters, and other chemists. In England, investigations on the same subject have been made by Mr. Warington and by myself. The results of my investigations are recorded in the pages of the 'Journal of the Royal Agricultural Society' in a series of papers "On the Chemical Properties of Soils;" "On the Absorption of Potash and its Salts by soils of known composition;" "On the functions of Soda-salts in Agriculture;" and "On the absorption of Soluble Phosphate of Lime; and Phosphatic Manures for Root Crops."

Variableness of  
their retentive  
powers.

These several investigations have shown that the property of absorbing, retaining, and modifying the composition of manures belongs to every soil, and that some soils possess this power in a much higher degree than others. They have much increased our knowledge of the inherent capacity of soils to work up, so to speak, the crude fertilising matters into new combinations; to allow the free percolation of other—it may be less needful—substances; and to provide for a constant supply of food which is neither so soluble as to injure the growing plant, nor so insoluble as to remain inactive. It is therefore reasonable to connect in a great measure the agricultural capabilities of soils with their power of retaining certain fertilising matters with avidity, and of modifying others in a most interesting and, until recently, unexpected manner.

Absorption of  
ammonia.

Respecting the absorption of ammonia and its salts by various soils, the following points taken from the summary appended to my paper "On the Chemical Properties of Soils," published in June 1860, in the 'Journal of the Royal Agricultural Society,' well show the bearing of these researches on the application of manures.

1. All soils experimented upon had the power of absorbing ammonia from its solution in water.

2. Ammonia is never completely removed from its solution, however weak it may be. On passing a solution of ammonia, whether weak or strong, through any kind of soil, a certain quantity of ammonia invariably passes through. No soil has the power of fixing completely the ammonia with which it is brought into contact.

3. The absolute quantity of ammonia which is absorbed by a soil is larger when a stronger solution of ammonia is passed through it, but, relatively, weaker solutions are more thoroughly exhausted than stronger ones.

4. A soil which has absorbed as much ammonia as it will from a weak solution, takes up a fresh quantity of ammonia when it is brought into contact with a stronger solution.

5. In passing solutions of salts of ammonia through soils, the ammonia alone is absorbed, and the acids pass through, generally in combination with lime, or, when lime is deficient in the soil, in combination with magnesia or other mineral bases.

6. Soils absorb more ammonia from stronger than from weaker solutions of sulphate of ammonia, as of other ammonia-salts.

7. In no instance is the ammonia absorbed by soils from solutions of free ammonia, or from salts of ammonia, so completely or permanently fixed as to prevent water from washing out appreciable quantities of ammonia.

8. The proportion of ammonia which is removed in the several washings is small in proportion to that retained by the soil.

9. The power of soils to absorb ammonia from solutions of free or combined ammonia is thus greater than the power of water to redissolve it.

It follows, from these observations, that in ordinary seasons no fear need be entertained that heavy showers of rain will remove much ammonia from ammoniacal top-dressings, such as sulphate of ammonia, soot, Peruvian guano, and similar manures, which are much used in England for top-dressing wheat, barley, and oats; but in very rainy seasons, in districts which have a large rainfall, considerable quantities of ammonia may be removed from land top-dressed with ammoniacal manures, even in the case of stiff clay soils. Similar investigations have shown that nitrate of soda is not absorbed by soils, but readily passes in solution into the subsoil, and when it is applied in autumn or winter will be lost to a great extent by passing into land drainage.

Effect of rain on top-dressings of ammoniacal manures.

The usual practice in England is to apply guano, or sulphate of ammonia, or compound artificial manures containing salts of ammonia, as top-dressings for wheat, in autumn or during the winter months; whilst nitrate of soda, when used for top-dressing wheat or other cereal crops or pasture land, is almost invariably

Best time to apply artificial.

applied in spring, in accordance with sound scientific principles, which teach that nitrate of soda in solution is not retained by soils.

Use of lime and  
marl.

The investigations on the absorption of potash by various soils have also thrown a new light on the special use of lime and marl on poor sandy soils. Every farmer knows how essential lime is for the healthy growth of every kind of agricultural produce. On soils destitute of lime, most crops, especially green crops, are subject to disease, and consequently roots fail altogether on such land, even if it has been liberally manured with good farmyard manure or guano. Up to a certain stage, corn and roots grown under such conditions appear to thrive well, but as the season advances they sustain a check, and at harvest-time yield a miserable return. The remedy for such failures, which are not at all uncommon in localities where poor sandy soils prevail, is a good dose of lime or marl, and then, and only then, farmyard manure or guano may be applied to the greatest advantage. Marl or lime alone does not suffice for meeting all the requirements of our cultivated crops on such poor soils; and though calcareous minerals supply a most necessary element of plant food, and, by acting on the latent stores of food in the soil, produce at first a most strikingly favourable effect upon vegetation, they soon fail to do this if repeated too often, to the exclusion of other fertilising matters. On the other hand, the most liberal application of farmyard manure of the best quality never produces so beneficial and lasting an effect on poor sandy soils as when they have been previously well marled or limed. There are some soils which swallow up manure with, so to speak, an insatiable appetite, without ever feeling the better for the manure—they are appropriately called very hungry. On all such soils much manure is wasted, or the most is not made of it, if previously to the application of farmyard manure, guano, &c., the land has not received a good dose of lime.

My filtration experiments point out the reason why marl or lime is peculiarly valuable on poor sands.

Value of lime  
in poor sandy  
soils.

In passing a solution of sulphate of potash through a poor sandy soil, I found a weighable quantity of sulphate of ammonia in the filtrate, which was not the case when the same solution was passed through a marly soil.

The power of soils to retain ammonia is generally assumed to be greater than their power of retaining potash. Here, however, an instance is presented to us in which a salt of potash, by acting on the ammoniacal combination in a soil, overcomes the supposed superior affinity of ammonia. Contrary to all expectation, ammonia, in combination with sulphuric acid evidently



supplied by the sulphate of potash, passed into the solution, whilst potash took its place and was retained in the soil.

The sterile sand used in this experiment hardly contained any lime, whilst the marly soil, it need hardly be said, contained it in a large proportion. Lime not merely acts beneficially on sandy soils in a direct manner, by supplying a deficient element of nutrition, but also because it preserves in the soil the more valuable fertilising matters, which, like salts of potash or ammonia, rapidly filter through sandy soils, unless a sufficient quantity of marl or lime has been previously applied to the land. By these means the bases of the more valuable saline constituents of rotten dung or of guano are retained in the land, whilst the acids filter through it in combination with lime—a constituent which is, comparatively speaking, inexpensive.

The presence of much or little lime in a soil has also a powerful influence on the changes which soluble phosphates, or manures containing soluble phosphates, undergo in contact with the soil. It is a curious, and apparently anomalous, circumstance, that on sandy soils, and on all soils deficient in lime, concentrated superphosphates, rich in soluble phosphate, do not produce nearly so beneficial an effect upon root-crops as upon calcareous soils, or upon soils containing even a moderate proportion of lime.

Influence of lime upon manures containing soluble phosphates.

When applied to root-crops upon sandy soils greatly deficient in lime, a concentrated superphosphate produces a smaller crop than a manure containing only one-fourth the percentage of soluble phosphate. When this fact was first brought under my notice I ascribed it to prejudice, or accidental and unobserved circumstances, but direct experiments and an extended personal experience have shown me that there is no mistake about this matter. The true explanation no doubt is, that the excess of acid soluble phosphate in a concentrated superphosphate is not precipitated as efficiently in a soil deficient in lime, as it is in land containing a good deal of lime.

Acid compounds are extremely injurious to vegetation, even in dilute solutions; and hence concentrated superphosphates used in large quantities, say at the rate of 5 to 6 cwts. per acre, do positive injury to root-crops, and more moderate applications of 2 or 3 cwts. per acre produce a less favourable result on sandy soils, and on all land poor in lime, than the same amount of superphosphate poor in soluble phosphate. Indeed, the experience of light-land farmers in districts in England where the land is deficient in lime, goes to prove that on land of that description it is better to apply bone-dust or precipitated phosphate, or phosphatic manures containing no soluble phosphate, to root-crops than to use superphosphate, or similar artificial manures

Beneficial results of bone-dust to root-crops on light land.

containing a large proportion of acid soluble phosphate of lime.

Closer approach of practice and science,

A characteristic feature of the last ten or fifteen years in relation to scientific agriculture is the closer approach of the practical agriculturist and the man of science. Both appear to understand each other better. The mutual interchange of ideas, and the better acquaintance of the former with the leading principles of chemistry, and that of the latter with the rudiments of practical agriculture, have materially promoted agricultural progress, and given a more decided and more widely extended direction to a rational plan of farming, success in which so much depends upon the economical and correct use of a great variety of artificial manures and purchased feeding-stuffs.

in consequence of wider diffusion of chemical knowledge.

In consequence of the wider diffusion of the elements of chemistry amongst the rising English farmer, and the closer contact of the agricultural chemist with the work and wants of the practical agriculturist, the investigations of the chemist have taken a more decidedly practical direction than in former years, and there is, perhaps, no country in which, at the present time, the assistance of the chemist is so frequently called in requisition by farmers as it is in England. My Annual Reports, in my capacity of Consulting Chemist to the Royal Agricultural Society, show that, previous to 1860, but few soils were sent to me for examination, and that of late years the chemical inquiries respecting the rational cultivation of various soils have become very numerous; no doubt because practical men are becoming more and more conscious that, rightly interpreted, the results of soil-analyses supply reliable and useful information on many points of interest. Thus they give frequently decided and satisfactory answers to the following questions:—

Questions often answered by the analyses of soils.

1. Whether or not barrenness is caused by the presence of an injurious substance, such as sulphate of iron or sulphide of iron, occasionally occurring in peaty and clayey soils?

2. Whether soils contain common salt (land flooded by seawater), nitrates, or other soluble salts, that are useful to vegetation in a highly diluted state, but injurious when they occur in land too abundantly?

3. Whether barrenness is caused by the absence or deficiency of lime, phosphoric acid, or other important elements of plant-food?

4. Whether clays are absolutely barren, and not likely to be materially improved by cultivation, or whether they contain the necessary elements of fertility in an unavailable state, and are capable of being rendered fertile by subsoiling, deep cultivation, steam-ploughing, and similar mechanical means?



5. Whether or not clays are usefully burnt, and used in that state as manure?

6. Whether or not land will be improved by liming?

7. Whether it is better to apply lime, or marl, or clay, on a particular soil?

8. Whether special manures, such as superphosphate or ammoniacal salts, can be used (of course discreetly) without permanently injuring the land; or whether the farmer should rather depend upon the liberal application of farmyard manure, that he may restore to the land all the elements of fertility removed in the crops?

9. What kinds of artificial manures are best suited to soils of various composition?

The investigations of Messrs. Lawes and Gilbert in relation to the exhaustion of land by continuously grown corn-crops, their inquiries into the distribution of nitrogen in the land, and the examination of land-drainage by these gentlemen, by myself, and by Dr. Frankland, as well as other investigations on the unexhausted elements of manure left in the land by the consumption of purchased food, or the use of various artificial manures, have all had a powerful influence on improved systems of modern cultivation.

Influence of experiments on modern cultivation.

Leaving out of consideration all questions of tidy or slovenly management—such as those connected with draining, fencing, weeding, &c.—whereby the standard of productiveness may be lowered, and making allowance for variations in the average produce of the land, due to the character of the seasons, Mr. Lawes was the first man to point out that all land, left unmanured for a longer or shorter number of years, has a certain standard of natural produce, practically speaking, varying within certain limits according to the character of the season, and bad or good management, which standard of natural produce on a large scale could practically be neither permanently increased, nor materially reduced by cultivation.

Permanent fertility

He further explained what is the real meaning of land “out of condition” and land “in good condition,” by showing that the latter is an acquired fertility, due to the application of manure; and that the former is the result of exhaustion of the manures, which temporarily raised the fertility of the land, in the production of two or more crops, or in loss by drainage and other causes, and the return of the land to its natural standard of productiveness. It is well, however, to bear in mind that Mr. Lawes’ observations respecting permanent and temporary fertility apply to actual English farm-practice, and that the term permanent fertility must not be pushed to an extreme signification.

raised by constant manurings.

There are soils which, like pure sands, may be called permanently barren; that is to say, they naturally contain barely any mineral or organic elements of plant-food to produce in their natural or normal conditions a paying crop. Such soils, by dint of manures of the proper kind, may be made to acquire a certain amount of fertility, which, however, is rapidly expended on the crops grown; and they require constant manuring in order to yield any kind of agricultural produce in paying quantities.

But the term permanent fertility is hardly applicable in its full sense to any kind of land; for however rich land may be naturally, its productive power or standard of natural produce will be impaired, it may be very slowly in some cases, but surely in all, if such land is cropped from year to year, and no provision is made to restore to it the elements of fertility which have been removed by a long succession of crops. Whilst fully admitting this, it is nevertheless a fact that, in the case of the majority of soils under cultivation in England, nothing short of the most wilful and long-continued cropping, without any return whatever, can materially injure the staple of the land; and, on the other hand, however much the acquired fertility of naturally poor soils may have been raised by the liberal application of dung and artificial manures, or the consumption of cake upon the land, such soils will soon return to their natural state of sterility, or fall to the level of their standard natural produce, if they be left unmanured for a few years.

## CHAPTER II.

### CONTINUOUS CROPPING.

Experiments on continuous cropping.

MESSRS. LAWES and GILBERT's experiments on the continuous growth of corn-crops show, that on moderately stiff soils of considerable depth, containing naturally an abundance of all the mineral elements of fertility, corn-crops may be grown without manure of any kind for more than twenty-five years in succession, without material injury to the natural or standard fertility of the land.

Mineral manures alone have given very little increase of produce when they have been applied to wheat, but rather better results when applied to barley in an adjoining field similar in character to the experimental wheat-field. On the other hand, nitrogenous manures alone in the form of ammoniacs, or nitrate of soda, have given considerably more produce than mineral manures alone; and a mixture of mineral and nitrogenous manures has yielded much more still, and more, of

Tabular statement of results.

TABLE I.—MESSRS. LAWES and GILBERT'S EXPERIMENTS on the Growth of WHEAT and BARLEY, year after year on the same land; without MANURE, and with different kinds of MANURE.

WHEAT.

Previous cropping—1839, turnips, with farmyard manure; 1840, barley; 1841, peas; 1842, wheat; 1843, oats; the last four crops unmanured. First experimental wheat-crop in 1844. Wheat every year since; and, with some exceptions, nearly the same description of manure on the same plots each year—especially during the last twenty-six years (1852 and since). Unless otherwise stated, the manures are sown in the autumn before the seed.

(AREA under EXPERIMENT, about 13 Acres.)

Plots.	Manures, per acre, per annum.	PRODUCE PER ACRE. (Average per Annum.)																							
		Dressed Corn.						Total Straw.																	
		Quantity.		Weight per Bushel.		Quantity.		Weight per Bushel.		Quantity.		Weight per Bushel.													
1	Unmanured continuously	12 1/2	1852-53	12 1/2	1852-53	12 1/2	1852-53	12 1/2	1852-53	12 1/2	1852-53	12 1/2	1852-53	12 1/2	1852-53	12 1/2	1852-53	12 1/2	1852-53	12 1/2	1852-53	12 1/2	1852-53		
2	Mineral manures alone, 200 lbs. sulphate of potash, 100 lbs. sulphate of soda, 100 lbs. sulphate of magnesia, and 34 cwts. of superphosphate (made from 200 lbs. bone-ash, 150 lbs. sulphuric acid of 1.7 spec. gravity, and water)	15 1/2	1864-75	12 1/2	1864-75	12 1/2	1864-75	12 1/2	1864-75	12 1/2	1864-75	12 1/2	1864-75	12 1/2	1864-75	12 1/2	1864-75	12 1/2	1864-75	12 1/2	1864-75	12 1/2	1864-75	12 1/2	1864-75
3	Ammonia-salts alone for 1845, and each year since; mineral manure in 1844. (Equal parts of sulphate and muriate of ammonia of commerce)	22 1/2	1845-54	21 1/2	1845-54	21 1/2	1845-54	21 1/2	1845-54	21 1/2	1845-54	21 1/2	1845-54	21 1/2	1845-54	21 1/2	1845-54	21 1/2	1845-54	21 1/2	1845-54	21 1/2	1845-54	21 1/2	1845-54
4	Ammonia-salts and minerals. (The same minerals as in No. 2, and 600 lbs. ammonia salts)	38	1845-54	37 1/2	1845-54	37 1/2	1845-54	37 1/2	1845-54	37 1/2	1845-54	37 1/2	1845-54	37 1/2	1845-54	37 1/2	1845-54	37 1/2	1845-54	37 1/2	1845-54	37 1/2	1845-54	37 1/2	1845-54
5	Farmyard-manure (14 tons every year)	35 1/2	1845-54	35	1845-54	35 1/2	1845-54	35 1/2	1845-54	35 1/2	1845-54	35 1/2	1845-54	35 1/2	1845-54	35 1/2	1845-54	35 1/2	1845-54	35 1/2	1845-54	35 1/2	1845-54	35 1/2	1845-54
6	Unmanured continuously	21 1/2	1852-53	21 1/2	1852-53	21 1/2	1852-53	21 1/2	1852-53	21 1/2	1852-53	21 1/2	1852-53	21 1/2	1852-53	21 1/2	1852-53	21 1/2	1852-53	21 1/2	1852-53	21 1/2	1852-53	21 1/2	1852-53
7	Mineral manure alone (200 lbs. sulphate of potash, 100 lbs. sulphate of soda, 100 lbs. sulphate of magnesia, and 34 cwts. of superphosphate)	30 1/2	1864-75	29 1/2	1864-75	29 1/2	1864-75	29 1/2	1864-75	29 1/2	1864-75	29 1/2	1864-75	29 1/2	1864-75	29 1/2	1864-75	29 1/2	1864-75	29 1/2	1864-75	29 1/2	1864-75	29 1/2	1864-75
8	Superphosphate alone, 34 cwts.	27 1/2	1864-75	27 1/2	1864-75	27 1/2	1864-75	27 1/2	1864-75	27 1/2	1864-75	27 1/2	1864-75	27 1/2	1864-75	27 1/2	1864-75	27 1/2	1864-75	27 1/2	1864-75	27 1/2	1864-75	27 1/2	1864-75
9	Ammonia-salts alone, 200 lbs.	34 1/2	1864-75	34 1/2	1864-75	34 1/2	1864-75	34 1/2	1864-75	34 1/2	1864-75	34 1/2	1864-75	34 1/2	1864-75	34 1/2	1864-75	34 1/2	1864-75	34 1/2	1864-75	34 1/2	1864-75	34 1/2	1864-75
10	Nitrate of soda, 275 lbs.	39 1/2	1864-75	39 1/2	1864-75	39 1/2	1864-75	39 1/2	1864-75	39 1/2	1864-75	39 1/2	1864-75	39 1/2	1864-75	39 1/2	1864-75	39 1/2	1864-75	39 1/2	1864-75	39 1/2	1864-75	39 1/2	1864-75
11	Ammonia-salts and minerals. (The same minerals as in No. 2, and 200 lbs. ammonia-salts)	47 1/2	1864-75	47 1/2	1864-75	47 1/2	1864-75	47 1/2	1864-75	47 1/2	1864-75	47 1/2	1864-75	47 1/2	1864-75	47 1/2	1864-75	47 1/2	1864-75	47 1/2	1864-75	47 1/2	1864-75	47 1/2	1864-75
12	Nitrate of soda and minerals. (The same minerals as in No. 2, and 275 lbs. of nitrate of soda)	50 1/2	1864-75	50 1/2	1864-75	50 1/2	1864-75	50 1/2	1864-75	50 1/2	1864-75	50 1/2	1864-75	50 1/2	1864-75	50 1/2	1864-75	50 1/2	1864-75	50 1/2	1864-75	50 1/2	1864-75	50 1/2	1864-75
13	Farmyard-manure, 14 tons every year	46 1/2	1864-75	46 1/2	1864-75	46 1/2	1864-75	46 1/2	1864-75	46 1/2	1864-75	46 1/2	1864-75	46 1/2	1864-75	46 1/2	1864-75	46 1/2	1864-75	46 1/2	1864-75	46 1/2	1864-75	46 1/2	1864-75

BARLEY.

Previous cropping—1847, Swedish turnips, with dung and superphosphate of lime, the roots carted off; 1849, barley; 1849, clover; 1850, wheat; 1851, barley manured with ammonia-salts. First experimental crop in 1852. Barley every year since.

Plots.	Manures, per acre, per annum.	PRODUCE PER ACRE. (Average per Annum.)																							
		Dressed Corn.						Total Straw.																	
		Quantity.		Weight per Bushel.		Quantity.		Weight per Bushel.		Quantity.		Weight per Bushel.													
1	Unmanured continuously	15 1/2	1852-53	15 1/2	1852-53	15 1/2	1852-53	15 1/2	1852-53	15 1/2	1852-53	15 1/2	1852-53	15 1/2	1852-53	15 1/2	1852-53	15 1/2	1852-53	15 1/2	1852-53	15 1/2	1852-53	15 1/2	1852-53
2	Mineral manure alone (200 lbs. sulphate of potash, 100 lbs. sulphate of soda, 100 lbs. sulphate of magnesia, and 34 cwts. of superphosphate)	21 1/2	1864-75	21 1/2	1864-75	21 1/2	1864-75	21 1/2	1864-75	21 1/2	1864-75	21 1/2	1864-75	21 1/2	1864-75	21 1/2	1864-75	21 1/2	1864-75	21 1/2	1864-75	21 1/2	1864-75	21 1/2	1864-75
3	Superphosphate alone, 34 cwts.	27 1/2	1864-75	27 1/2	1864-75	27 1/2	1864-75	27 1/2	1864-75	27 1/2	1864-75	27 1/2	1864-75	27 1/2	1864-75	27 1/2	1864-75	27 1/2	1864-75	27 1/2	1864-75	27 1/2	1864-75	27 1/2	1864-75
4	Ammonia-salts alone, 200 lbs.	34 1/2	1864-75	34 1/2	1864-75	34 1/2	1864-75	34 1/2	1864-75	34 1/2	1864-75	34 1/2	1864-75	34 1/2	1864-75	34 1/2	1864-75	34 1/2	1864-75	34 1/2	1864-75	34 1/2	1864-75	34 1/2	1864-75
5	Nitrate of soda, 275 lbs.	39 1/2	1864-75	39 1/2	1864-75	39 1/2	1864-75	39 1/2	1864-75	39 1/2	1864-75	39 1/2	1864-75	39 1/2	1864-75	39 1/2	1864-75	39 1/2	1864-75	39 1/2	1864-75	39 1/2	1864-75	39 1/2	1864-75
6	Ammonia-salts and minerals. (The same minerals as in No. 2, and 200 lbs. ammonia-salts)	47 1/2	1864-75	47 1/2	1864-75	47 1/2	1864-75	47 1/2	1864-75	47 1/2	1864-75	47 1/2	1864-75	47 1/2	1864-75	47 1/2	1864-75	47 1/2	1864-75	47 1/2	1864-75	47 1/2	1864-75	47 1/2	1864-75
7	Nitrate of soda and minerals. (The same minerals as in No. 2, and 275 lbs. of nitrate of soda)	50 1/2	1864-75	50 1/2	1864-75	50 1/2	1864-75	50 1/2	1864-75	50 1/2	1864-75	50 1/2	1864-75	50 1/2	1864-75	50 1/2	1864-75	50 1/2	1864-75	50 1/2	1864-75	50 1/2	1864-75	50 1/2	1864-75
8	Farmyard-manure, 14 tons every year	46 1/2	1864-75	46 1/2	1864-75	46 1/2	1864-75	46 1/2	1864-75	46 1/2	1864-75	46 1/2	1864-75	46 1/2	1864-75	46 1/2	1864-75	46 1/2	1864-75	46 1/2	1864-75	46 1/2	1864-75	46 1/2	1864-75

both corn and straw, than the annual application of 14 tons of farmyard-manure per acre.

The Table on page 551 embraces some of the most instructive results of experiments on the continuous growth of wheat and barley.

Effect of different manures.

It will be seen from the preceding Table that mineral manures, and notably superphosphate, had a better effect upon barley than upon wheat; further, that in combination with minerals nitrate of soda produced a larger increase, both in corn and straw, than minerals combined with salts of ammonia. This agrees well with the general experience of the British farmer, who derives much advantage from the use of a mixture of nitrate of soda and superphosphate as a manure for barley; whilst for wheat, grown on good clay-soils, a top-dressing of nitrate of soda alone produces as large an increase as a mixture of nitrate with superphosphate. On light soils, comparatively poor in available potash and phosphoric acid, it would not be safe to rely upon the exclusive use of nitrate of soda or of salts of ammonia for producing a succession of remunerative corn-crops. Even on heavy land it is desirable to add phosphates to the nitrogenous manures, for although the phosphoric acid in most soils is not nearly so rapidly removed in the growing crops or by drainage as available nitrogen is, yet as a rule, phosphoric acid is too sparingly distributed in the soil to withstand without injury the continuous removal of these important fertilising elements in a succession of corn-crops, top-dressed solely with nitrate of soda and salts of ammonia.

Messrs. Lawes and Gilbert's experiments clearly prove the advantage of combining mineral with nitrogenous manures; and they show that by the use of such mixed manures the fertility of the land may be preserved, and better crops often be grown than with farmyard-manure.

Modifications in cropping by using artificial.

One of the most important advantages of such a system of manuring consists in the freedom of action which it gives to the occupier of land, enabling him to dispense with any recognised system of rotation of crops, and under favourable circumstances to grow a succession of corn-crops with greater advantage than by slavishly following the ordinary course of cropping of the district.

These experiments have also had a marked influence upon the extended use of nitrate of soda as a top-dressing for corn-crops. They further have induced farmers to grow barley more frequently than formerly on heavy land, and in some instances they have led to the adoption of the system of selling, year by year, the whole or nearly the whole of the growing crops, and of restoring an equivalent of plant-food in the form of portable fertilisers.

Like every other plan of farming, the system of continuous corn-growing and selling off the whole of the produce depends for success upon practical tact and experience. It requires the judicious spending of money on steam-cultivation, drainage, and other permanent improvements, and a full appreciation of the advantages or disadvantages which such a system may present in a particular locality. As an instance of marked success, the experience of Mr. Prout, of Sawbridgeworth, Hertfordshire, may be mentioned.

Continuous corn-growing by Mr. Prout.

Mr. Prout purchased Blount's and Sweetdew's farms in 1861, comprising 450 acres, and situated in the parish of Sawbridgeworth, about 4 miles from Harlow. The soil, a clay and strong loam, readily poaching and running together if worked wet—lies upon a subsoil of drift-clay and cretaceous gravel, bordering on the chalk and chalk-marl.

The following are the results of my analyses of three samples of soil taken from three separate fields.

COMPOSITION OF SOILS AT BLOUNT'S FARM.

Composition of the soils of his farm.

		Broad Field.	Black Acre.	White Moor.
Soluble in Acid.	Organic matter .. .. .	4.75	4.46	5.49
	Oxide of iron .. .. .	4.80	4.29	7.91
	Alumina .. .. .	5.39	4.90	2.06
	Carbonate of lime .. .. .	2.45	4.74	1.80
	Magnesia .. .. .	1.84	1.59	.80
	Potash .. .. .	.54	.72	.51
	Soda .. .. .	.08	traces.	.16
	Sulphuric acid .. .. .	.08	.01	.09
	Phosphoric acid .. .. .	.16	.12	.27
	Insoluble silicates and sand ..	79.91	79.17	80.91
		100.00	100.00	100.00

These analyses show that the three soils are fairly good, but by no means particularly rich in phosphoric acid or in potash.

Mr. Prout bought the estate for 33*l.* per acre—a very moderate cost for a compact estate in a metropolitan county and only 20 miles from London. By bad management the farm had been brought into so low an agricultural condition, that the former owner had difficulty in getting a tenant to offer 20*s.* rent per acre.

Cost of his farm.

As might be anticipated, a heavy outlay was required before a good return could be expected from such a property. About 16*l.* per acre was expended in draining, cutting outfall ditches, grubbing up and levelling old fences, making roads, adding to and repairing buildings, and fallowing foul land. Mr. Prout





the produce of from 15 to 18 acres (part of 25 acres lying near the homestead), devoted to the growth of hay and roots for eight horses and one cow, the whole of the live-stock kept at present on Blount's farm.

The labour and seed bills are included in the general payments, and the annual return of these 15 to 18 acres may be estimated at 200*l.* This brings the total annual receipts of Blount's farm to 4809*l.*

For the last two years Mr. Prout has grown less wheat and more barley than in previous years.

Thus, in 1874—310 acres were in Wheat, 60 in Oats, and none in Barley.      Corn crops grown.  
 In 1875—190        "        "        40        "        126        "  
 In 1876—193        "        "        50        "        124        "

The following Table presents the return per acre obtained from each of the nine sales:—

- 1st. For the whole of the crops sold.
- 2nd. For the wheat crop alone.
- 3rd. The average value of wheat per quarter for the week in July in which the sale was held.

Years.	Total Averages.			Wheat Averages.			Price of Wheat in Week of Sale.			Return per acre.
	£	s.	d.	£	s.	d.	£	s.	d.	
1868	12	0	2	14	14	2	3	2	9	
1869	10	12	6	14	6	8	2	11	9	
1870	12	6	6	15	3	10	2	12	10	
1871	10	19	3	14	3	2	2	18	0	
1872	10	16	0	11	0	5	2	19	1	
1873	10	0	0	10	8	11	3	0	0	
1874	10	13	3	10	17	7	2	18	0	
1875	10	17	10	10	13	1	2	12	4	
1876	10	4	3	11	5	5	2	6	4	

The whole of the crops in the present year (1877) are looking remarkably well, and there are no indications whatever that the nine consecutive corn-crops, sold off year after year, have deteriorated the land. Indeed, the enhanced value of the estate, purchased at less than 16,000*l.*, and valued in 1875 by a competent surveyor at 31,000*l.*, represents a handsome return for permanent improvements, and affords the best possible proof that the productive powers of the land are now greater than they were when Mr. Prout commenced the plan of continuous corn-growing and selling off the whole of the produce, a plan by which he has derived from 450 acres a clear profit of 900*l.* per annum in round numbers.

Land improved in value.

Hitherto Mr. Prout has not found it necessary to apply special potash-manures to his fields, some direct experiments with

potash-salts having given unsatisfactory results, but no doubt there are other farms where it would be necessary to add potash in some form or other to the manuring agents employed if the whole produce were sold off land which naturally contains potash in more limited quantities than Mr. Prout's.

### CHAPTER III.

#### MANURES.

ALTOGETHER, then, our knowledge of the agricultural capabilities of the various classes of soils found in England has been greatly extended during the last fifteen years, and, in consequence, a general improvement has taken place in the cultivation of the land. Furthermore, the recent achievements by agricultural chemists, who have studied experimentally questions relating to the exhaustion of soils, and the means of increasing their productiveness, have had the effect of breaking down, in a great measure, the rigid adherence to farm covenants prescribing a strict observance of certain rotations of crops, regulations as to the sale of produce, &c., and have rendered the cultivator of the land more independent in pursuing the course of cropping, system of manuring, and general farm-management, which local considerations and actual experience have pointed out to yield to him the best economical return without permanently injuring the land.

Improvements  
in land culti-  
vation.

Of all the constituents of soils, none affects so much their productive powers as nitrogen, in a condition in which it is available for the use of plants, and none is so rapidly removed from the land than available nitrogen, by the production of corn and other crops, by drainage, and by other yet unexplained causes.

Powers of  
nitrogen.

In a certain sense, it is the available nitrogen which mainly imparts condition to the land, or imparts to it an acquired fertility, which may be described as "good condition," and which it rapidly loses again if the supply of suitable nitrogenous manure is withheld for a few years. Speaking with reservation, it may be said, on the other hand, that the standard of natural produce, or the permanent fertility of different soils, mainly depends upon the larger or smaller quantities of available phosphoric acid, potash, lime, and other of the more important ash-constituents of plants, which exist in an available form in a given area and depth of land. Unquestionably, nitrogen in the shape of ammonia-salts, or as nitrates or nitrogenous organic matters readily entering into decomposition and furnishing nitrates as ultimate

products, is, in a purely practical sense, the most important element with which the farmer has to deal. Hence the great value of the laborious and long-continued field-experiments by Messrs. Lawes and Gilbert, and their extremely interesting laboratory researches relating to the sources and assimilation of nitrogen by plants, and to the exhaustion or accumulation of the same elements in the land.

What, then, are the sources of the nitrogen of vegetation? Are they the same for all descriptions of plants? Are they to be sought entirely in the soil, or entirely in the atmosphere, or partly in the one, and partly in the other? These are some of the questions which Messrs. Lawes and Gilbert have endeavoured to solve by a series of investigations extending over a period of above thirty years, and in which these gentlemen are still engaged; for although their researches have thrown a good deal of light on these questions, they involve great difficulties, and a vast field of scientific inquiry is still left open; and no doubt much laborious work has yet to be accomplished before they can be satisfactorily answered in all their bearings.

Sources of nitrogen in vegetation

The combined nitrogen coming down from the atmosphere in rain, snow, mists, or dew, undoubtedly contributes to the annual yield of nitrogen in our crops, but it requires no lengthened argument to prove that this source of nitrogen is altogether inadequate to meet the requirements of our cultivated crops.

According to the average results obtained by Messrs. Lawes and Gilbert, and by Professor Way, the combined nitrogen, in rain and minor aqueous deposits, which fall annually at Rothamsted upon one acre of land, amounts to 6.46 lb. as ammonia, and .75 as nitric acid, or a total of 7.21 lb. of combined nitrogen per acre.

from the atmosphere.

Professor Frankland's more recent determinations are substantially confirmatory of these results. How much of this nitrogen is available to the vegetation of a given area we have not the means of estimating with any certainty. Numerous independent determinations, both by Dr. Frankland and myself, of the nitric acid in the drainage-water collected from land at Rothamsted, which had been left unmanured for many years, show that a considerable amount of nitric acid passes into land-drainage, and render it all but certain that this loss of nitrogen much exceeds the quantity brought down upon the land in the rain and other aqueous deposits.

With regard to the free nitrogen in the atmosphere, it may be stated that an elaborate investigation into this subject, by Messrs. Lawes, Gilbert, and Pugh, fully confirmed the previous experiments made by M. Boussingault, which showed that plants, by their leaves, do not appear to have the power to take up and assimilate the free nitrogen of the air.

Non-ability of plants to assimilate free nitrogen from the air.

The following Table, by Messrs. Lawes and Gilbert, shows the amount of nitrogen recovered, and the amount not recovered, in the increase of the crop for 100 supplied in manure, to wheat and to barley respectively; the result being in each case the average over a period of 20 years.

TABLE II.—NITROGEN RECOVERED, and NOT RECOVERED, in the INCREASE of PRODUCE, for 100 supplied in MANURE.

Manuring, quantities per Acre per Annum.	For 100 Nitrogen in Manure.	
	Recovered in Increase.	Not recovered in Increase.
WHEAT, 20 years, 1852-1871.		
Complex Mineral Manure, and 41 lbs. Nitrogen, as Ammonia	32·4	67·6
"    "    82 lbs.    "    "	32·9	67·1
"    "    82 lbs.    "    as Nitrate	45·3	54·7
BARLEY, 20 years, 1852-1871.		
Complex Mineral Manure, and 41 lbs. Nitrogen, as Ammonia	48·1	51·9

Proportion of nitrogen unrecoverable.

Notwithstanding the great effect produced by the nitrogenous manures, two-thirds of the nitrogen supplied was unrecovered in the increase of crops when the ammonia-salts were applied to wheat; the application having been made in the autumn. When, however, nitrate of soda was used, which is always applied in the spring, the quantity left unrecovered was not much more than half that supplied. With barley, also, the manuring for which takes place in the spring, there is again nearly half the nitrogen supplied in the manure recovered in the increase, and therefore little more than half left unrecovered.

The question will naturally be raised, what becomes of the one-half or two-thirds of the nitrogen which is not recovered in the increase of the crops? The examination of some 70 samples by myself, and a number of independent determinations by Dr. Frankland, of the drainage-water from the experimental wheat plots which yielded the preceding results, throw much light on this loss.

The following Table contains a summary of some of the more important results obtained by Dr. Frankland and myself.

TABLE III.—NITROGEN as NITRATES and NITRITES, per 100,000 parts of DRAINAGE WATER from plots differently Manured, in the Experimental Wheat-Field at Rothamsted, Wheat every year, commencing 1844.

	Nitrogen as Nitrates and Nitrites, per 100,000 parts of Drainage Water.					
	Dr. Frankland's results.		Dr. Voelcker's results.		Mean.	
	Experiments.		Experiments.		Experiments.	
Farmyard Manure .. .. .	4	0·922	2	1·606	6	1·264
Without Manure .. .. .	6	0·316	5	0·390	11	0·353
Complex Mineral Manure .. .. .	6	0·349	5	0·506	11	0·428
Complex Mineral Manure, and 41 lbs. Nitrogen, as Ammonia	6	0·793	5	0·853	11	0·823
Complex Mineral Manure, and 82 lbs. Nitrogen, as Ammonia	6	1·477	5	1·400	11	1·439
Complex Mineral Manure, and 123 lbs. Nitrogen, as Ammonia	6	1·951	5	1·679	11	1·815
Complex Mineral Manure, and 82 lbs. Nitrogen, as Nitrate ..	5	1·039	5	1·835	10	1·437

The quantity of water which passes through the drains in the course of the year, as may be readily conceived, varies a great deal in different soils, according to the distribution of the rain in the year, and the quantity which falls at one period. In the absence of satisfactory evidence from which might be calculated the probable amount of water which passed annually through the drains of the different plots of the experimental wheat-field at Rothamsted, it is impossible to determine precisely the actual loss of nitrogen which the several plots sustained by drainage. The figures in the preceding Table, however, conclusively show that the quantity of nitrogen which passed into the drainage-water in the form of nitrates increased in proportion to the amounts of ammonia or nitrate put on the manured plots. They show how serious may be the loss of nitrogen by drainage when ammonia-salts or nitrates are liberally applied to the land in autumn, if there should be much wet weather during the winter; or even when they are applied in the spring, if heavy falls of rain should set in. Other experiments at Rothamsted lead to the conclusion that, according to season, from one-quarter to nearly one-half of the annual rainfall may descend more than 40 inches below the surface. For every inch of rain which passes through the drains and carries with it one part of nitrogen per 100,000 of water, there will be a loss of 2½ lbs. of nitrogen per acre from the manure applied to the land.

In the drainage-water from the experimental wheat-field at Rothamsted, manured in the autumn by an amount of ammonia-

Carried away by drainage.

salts supplying 82 lbs. of nitrogen per acre, I found on analysis, in the middle of January 1868, as much as  $3\frac{3}{4}$  parts of nitrogen, in the form of nitrates and nitrites, per 100,000 of water. For every inch of rain passing through the drains of that plot in January, there was consequently a loss of about  $8\frac{1}{2}$  lbs. of nitrogen, supplied in manure at a cost of about 1s. per lb. Assuming that during continued wet weather in winter several inches of rain pass through the drains, and that, in the course of the autumn, winter, and spring, from 7 to 10 inches will pass beyond the reach of the roots, the loss in nitrogen must be very great. Future analyses of drainage-waters, collected under conditions which allow the exact quantity of water passing through the land to be measured, will probably show that by far the larger proportion of the nitrogen of manure not recovered in the crop is lost by drainage.

Results of investigation into composition of waters of land-drainage.

My investigations into the composition of waters of land-drainage, embracing full analyses of 70 samples, in addition to the light which they threw on the loss of nitrogen experienced during the growth of corn-crops, disclosed chemical facts which may be turned to good account by all who desire to apply farm-yard manure, or artificial fertilisers, in a rational way to the land, so as to derive the greatest benefit from them. These analyses of the drainage-waters from the different plots of the same field, variously treated as regards the supply of manure, afford striking illustrations of the power of soils to modify the composition of the manure used, and to prepare plant-food, which is neither so soluble as to injure the crop, nor so insoluble as to remain inactive.

It is remarkable that although large quantities of ammonia-salts were applied to some of the plots of the experimental wheat-field, the drainage-water from these plots contained only faint traces of ammonia; but at all times of the year they contained nitrates in appreciable quantities, which appears to render it very probable that it is chiefly, if not solely, from nitrates that our crops build up their nitrogenous organic constituents. Although the drainage-waters were found to contain appreciable quantities of phosphoric acid and potash, nevertheless these, the more valuable, mineral fertilising constituents supplied in the manures were retained in the land almost entirely, whilst the less important, because more abundant and widely distributed mineral matters, such as lime, magnesia, soda, chlorine, sulphuric acid, and soluble silica, pass into the waters of land-drainage in considerable quantities.

As may be naturally expected, the loss of fertilising matters by drainage is greater from highly manured fields than from land left unmanured, and greater during the autumn and winter



months than during the periods of the active growth of plants. The fertility of land, it may further be observed, is more readily impaired by the loss of nitrogen by drainage than by the removal in that manner of those mineral matters which are food to plants.

It follows from this, as a natural consequence, that much more nitrogenous food must be applied to the land, and in good practice is always used, than would be necessary to produce a given increase in the crop, if all the nitrogen could be recovered therein.

Again: this investigation clearly shows that when nitrogenous organic matters are applied to the land in the shape of farmyard-manure, or of organic refuse matters, they suffer decomposition, and are gradually resolved into ammonia compounds, which are retained by the soil for a limited period, and are finally oxidised into nitrates. Farmyard-manure thus yields a more constant and gradual supply of nitrogenous food than nitrate of soda, which, unless consumed by the crop to which it is applied, is wasted to a large extent by drainage.

In accordance with the teachings of modern chemistry, the most advanced farmers in England apply to the land farmyard-manure, fresh from the stables or cattle-sheds, if possible, in autumn or winter. The manure then has ample time to become rotten, and by degrees the nitrogenous constituents of the manure are transformed into nitrates, of which there will be a ready supply in spring when vegetation makes a fresh start.

Peruvian guano and similar ammoniacal manures, when used for winter-wheat, as a rule are applied in England in autumn either before the wheat is sown, or after it is fairly above ground. If the land is rather light, the best farmers prefer to top-dress their wheat with guano, soot, or other ammoniacal manures early in spring. Probably the end of February, or beginning of March, is the best time for the application of ammoniacal top-dressings.

Since the price of nitrate of soda has been so moderate as it has been of late years, its consumption in England has greatly increased, and most English farmers are quite alive to the fact that nitrate of soda is not retained in the land for more than one growing season, and that it is liable to be washed out of it by rain. Speaking generally, nitrate of soda is applied in most parts of England towards the end of March as a top-dressing for wheat or barley, either by itself, or in conjunction with common salt for wheat, or in conjunction with superphosphate for barley and oats.

With the remarkable increase of our knowledge, which has taken place since 1860, of the physiological and chemical effects

Farmyard-manure when best applied.

Artificial.

Nitrate of soda only retained in land one season.

which the different organic and mineral constituents of the soil and the various manuring agents are capable of producing on different natural orders of plants, the British agriculturists have learned to make good use of artificial manures. The annual consumption of guano, nitrate of soda, bone-dust, dissolved bones, superphosphate of lime, and compound artificial manures specially prepared for particular crops, is unquestionably greater in Great Britain than in any other country.

The manufacture of artificial manures, more especially that of superphosphate of lime, is carried out in England at present on a very large scale, millions of pounds sterling having been embarked in this recent branch of applied manufacturing chemistry. There are in England at present probably a dozen or more manufacturers of artificial manures, each of whom produces annually from 45,000 to 50,000 tons and upwards of artificial manures, and many more makers turn out from 1000 to 20,000 tons each per annum. An idea of the magnitude of the manufacture of, and trade in, artificial manures in England can be formed from the fact that the importations into England of phosphatic minerals, bone-ash, and phosphatic guano from all parts of the world, for use as raw materials for the manufacture of artificial manures, probably exceeds 500,000 tons per annum:

In a brief report it is not possible to give a lengthy description of the various raw materials used by manufacturers of artificial manures, and imported into England during the last few years, nor is it a matter of general interest to refer to the composition and uses of the numerous manufactured portable manures which are so largely employed at present by British agriculturists, either alone or in conjunction with farmyard manure. The following is a list of the raw manure materials which are employed in the manufacture of artificial manures:—

### 1. *Phosphatic materials*:—

*a.* Phosphatic minerals, used chiefly in the manufacture of superphosphate of lime, forming the basis of compound manures for every description of agricultural produce.

Cambridge, Suffolk, and Bedfordshire coprolites; Boulogne coprolites; South Carolina Land and River phosphate; German or Lahn-phosphate; Spanish and Portuguese phosphorite; Bordeaux or French phosphate. Canadian apatite; Norwegian apatite; Welsh or Silurian phosphate; Sombrero phosphate; Navassa phosphate; St. Martin's phosphate; Curaçao Rock phosphate; Redonda phosphate; Alta Vela phosphate.

### *b.* Bones and bone materials:

Raw bones; refuse bones of gluc-makers; spent animal charcoal; South American bone-ash.

Increase in the use of artificials.]

Magnitude of the English manufacture.

Raw materials used.

Phosphatic materials.

*c. Phosphatic guanos :*

Mejillones guano ; Patagonian and Falkland Island guano ; Patos Island guano ; Raza Island, or Gulf of California guano ; Curaçao guano ; Quito Serrano guano ; Petrel Island guano ; Coral Island guano ; Booby Island guano ; McKeen's Island guano ; Baker's Island guano ; Howland Island guano ; Jarvis Island guano ; Bird's Island guano ; Malden Island guano ; Shaw's Island guano ; Flint Island guano ; Enderbury guano ; Starbuck Island guano and Lacedpede Island guano.

Full descriptions of these guanos and phosphatic minerals, with their analyses, will be found in the 'Journal of the Royal Agricultural Society' for 1875 and 1876.

*2. Nitrogenous manures :—*

Peruvian guano ; nitrate of soda ; sulphate of ammonia ; gas-refuse ammonia (crude and patent ammonia). Dried blood ; wool-refuse (shoddy). Dried-flesh refuse and similar animal matter (refuse from the manufacture of meat-extract in South America and Australia). Horn-shavings.

Nitrogenous manures.

*3. Saline alkaline materials :—*

Kainite and Stassfurth crude potash-salts of various strengths. Common lead salt, fishery salt, and nitre-refuse salt.

Saline alkaline materials.

Both raw and dissolved Peruvian guano are largely used by the farmers of Great Britain. Of late years the consumption of nitrate of soda has been very much increased, and many farmers now use it largely as a top-dressing for wheat and barley. For the latter crop it is usually employed in conjunction with superphosphate of lime, 2 to 3 cwts. of superphosphate, or 1½ to 2 cwts. of nitrate of soda being considered a good dressing per acre.

Uses of manures for corn.

Nitrate of soda has also been used of late years in England with considerable advantage, in addition to dissolved bones, or a mixture of superphosphate and guano, and some salt, as a manure for mangolds. A dressing of 1½ cwt. of nitrate of soda, 3 cwts. of Peruvian guano, 2 cwts. of superphosphate, and 2 cwts. of salt per acre, is considered a somewhat heavy but well-paying manure for mangold-wurzel.

Potash-salts are not much used in England for manuring purposes. Experience has shown that, on the great majority of soils in a fairly good agricultural condition, the addition of potash-salts to other artificial manures produces no decidedly beneficial effect upon the crops to which it is applied. On poor sandy land, and on worn-out pastures and peaty soils, however, potash-salts, in conjunction with dissolved bones, or superphosphate, or mixture of superphosphate and guano, have been used in England, as in other countries, with marked beneficial

effects. In artificial manures for potatoes, the admixture of potash-salts to phosphatic and nitrogenous fertilising matters, has also been found useful.

Common salt is used in England principally as an addition to manures for mangolds, and, mixed in equal proportions with nitrate of soda, as a top-dressing for spring-wheat and barley. It is also useful on light land in dry seasons.

For roots.

By far the largest quantity of all manufactured manures is used in England for root-crops. There are many parts of England where turnips and Swedes are grown with no other manure than mineral superphosphate, containing on an average 21 to 25 per cent. of soluble phosphate of lime, at the rate of 3 to 4 cwts. per acre. On cold clay soils, in a fair agricultural condition, it has been found that 3 cwts. of such a mineral superphosphate will produce at least as heavy a crop of swedes and turnips as a manure containing, in addition to soluble phosphate of lime, ammonia or nitrogenous organic matter.

On light land, however, the use of a purely phosphatic manure cannot be relied upon for producing a good crop of roots. On such land artificial manures are seldom used alone, but usually in conjunction with half a dressing of common dung. Dissolved bones, dissolved Peruvian guano, or compound artificial manures containing from 2 to 3 per cent. of ammonia, are greatly preferable to mineral superphosphate as manure for root-crops on light land and on loamy soils out of condition.

Disposal of town sewage.

*Sewage and Sewage Manures.*—The disposal of town-sewage and night-soil is surrounded with many difficulties, and generally entails, more or less, considerable expense upon the inhabitants of towns. The sewage question has not made much progress in England since 1860, so far as discovery and invention are concerned; nor does there seem to be much prospect of any new or startling light being thrown upon it in the future. It appears from the most recent official reports and investigations of this question, that town-sewage can be disposed of and purified best and cheapest by the process of land irrigation for agricultural purposes, where local conditions are favourable to its application. With rare exceptions, however, sewage irrigation entails a more or less considerable loss, for which adequate compensation should be made to the sewage farmer by the town authorities who desire to get rid of sewage, and to have it cleansed and rendered innocuous in the most efficient way.

Effect of soil and air.

Experience has shown conclusively, that when foul liquids, such as town-sewage, are passed through a depth of 5 or 6 feet of porous and thoroughly drained land, they entirely lose their offensive character; and that by bringing into practice the principles of downward intermittent filtration, a comparatively small

area suffices to purify effectually large volumes of sewage. The powerful oxidising properties of the air condensed within the pores of the soil, and the renewal of the air in the soil, effect an almost perfect destruction of the organic constituents of sewage, and their conversion into harmless inorganic compounds. Land properly prepared, and managed so as to admit of downward intermittent filtration being practised successfully, may be compared to a furnace charged with burning fuel. Like the fire in a good-drawing furnace, a well-drained and fully aerated soil burns up, or, in chemical language, oxidises, most perfectly the putrescible nitrogenous organic matters in sewage, and transforms them into nitrates and other final products of decomposition of animal matters, products having no smell, colour, or injurious properties. The soil, it may be observed, has not the power of absorbing and retaining chemically the nitrates thus produced, and in consequence the effluent drainage and the liquid mechanically retained in the land are alike poor in nitrogen and other fertilising matters, when liquids as dilute as town-sewage are poured upon the land. It naturally follows that an accumulation of nitrates or organic refuse-matters can as little take place in a thoroughly drained and porous soil, so managed as to give full scope to downward intermittent filtration as there can occur an accumulation of half-burned foul products of combustion in the chimney of a lighted furnace with a good draught, in which fœtid gases and organic refuse matters are effectively destroyed by fire and air.

Land, deeply drained, and thoroughly impregnated with air, exerts the same beneficial influence upon the soluble organic constituents of sewage for any number of years, provided its oxidising powers are not overtaxed in a given time, and a sufficient interval is allowed between the successive operations of concentrated irrigation for the admission of a plentiful supply of air, whereby the purifying oxidising powers of the soil are constantly renewed. With good management, land suitable for concentrated irrigation can never become overcharged with the fertilising matters of sewage so as to become sewage-sick. Indeed, no amount of sewage passed through a soil is capable of materially raising its permanent fertility, for no soil has the power of abstracting from dilute sewage the most valuable fertilising matters, of concentrating them in the land, and allowing the effluent to pass away deprived to a large extent of its fertilising constituents. In other words, the soluble manuring constituents of dilute sewage cannot be concentrated in the land by irrigation. The land is not rendered more fertile if the clear sewage of 10,000 persons is filtered through an acre, than it is when the sewage from only 1000 persons is passed through the

Soluble manuring constituents of dilute sewage not concentrated in the land by irrigation.



same area. Growing crops derive advantage mainly from the sewage held in the land mechanically, in the same manner in which a sponge holds water; and hence crops like Italian ryegrass, which consume a large quantity of liquid, and admit of being repeatedly irrigated with sewage, are precisely the kind of crops that are peculiarly well adapted to sewage irrigation.

Proved by  
analysis.

In proof of the fact that in light, porous, sandy soils, through which enormous quantities of sewage had been passed, no material accumulation of fertilising matters took place by long continued irrigations with large volumes of sewage, attention may be directed to an analysis which I made of the soil from the noted irrigated Craigentenny meadows, near Edinburgh.

The soil was found to contain in 100 parts:—

*Organic matter .. .. .	1·60
Oxide of iron and alumina .. .. .	1·04
Phosphoric acid .. .. .	·06
Sulphuric acid .. .. .	traces
Lime .. .. .	·08
Magnesia .. .. .	·25
Potash .. .. .	·08
Soda .. .. .	·13
Chloride of sodium .. .. .	·02
Silica (white fine sand) .. .. .	96·80
	100·06
* Containing nitrogen .. .. .	·039
Equal to ammonia .. .. .	·047

It appears from this analysis, that notwithstanding the enormous volumes of sewage which, in the course of many years, had been poured upon this land, it contained only a little above  $1\frac{1}{2}$  per cent. of organic matter, and practically merely traces of accumulated nitrogen. What little organic matter there was in the land, the examination showed not to be due to sewage, but to consist of visible fibres of roots and similar organic remains of the grass-crops grown upon the land. After irrigation with large quantities of sewage for many years, the land, it will be seen, is still a poor sandy soil, containing nearly 97 per cent. of pure silica.

Failure to  
purify by  
chemical  
agents.

Many attempts have been made of late years to purify sewage by various chemical precipitating agents, and to extract from it at the same time fertilising matters, which in a dried and pulverised condition, are sold in England at prices varying from 1*l.* to 3*l.* per ton. The manufacture of night-soil and town-refuse into portable manure is carried on at Rochdale, Halifax, Manchester, Oldham, and other towns; but as neither the manufacture of night-soil manures, nor the conversion of sewage-deposits into portable manures, pays the contingent costs of the



treatment, and as both have failed to be successful in an economical point of view, no further reference need be made to these processes.

The experience of the best sewage farmers in England appears to prove that concentrated, or downward intermittent, filtration, when it can be practised, is the most perfect means of purifying and getting rid of sewage. It, however, can only be successfully carried out with sewage deprived, by subsidence in settling-tanks, of the greater part of its suspended matters; for unless those matters are previously removed, they accumulate on the surface of the land, choke up its pores, and render it impossible to filter rapidly large volumes of sewage through the soil. The slimy character of these suspended matters causes many difficulties in the application of sewage to land, especially if the soil is not sufficiently porous to allow the passage of large volumes through it in a given time. There are many heavy clay-soils in England which, in my opinion, are alike unfit for concentrated and ordinary sewage-irrigation, and the attempts to render them fit for the reception of sewage can only result in ruinous expenses either to the ratepayers or to the occupier of such land. Downward intermittent filtration, no doubt, is an excellent means of disposing of sewage, if suitable land can be found; but what is to be done, it may be asked, with the sewage in localities where clay-soils abound, or the land is so situated as to render irrigation impracticable? In such a case, the best plan would appear to be to purify raw sewage, by means of chemical precipitating agents, sufficiently to admit of the clarified and partially purified effluent being poured into a water-course without creating a nuisance. Numerous experiments with all kinds of precipitating agents, and the experience of others on a large scale, have led me to the conclusion that by far the most efficacious and, on the whole, the most economical precipitating agent is crude sulphate of alumina, assisted by the addition of just enough lime to render the effluent slightly alkaline and to effect the complete precipitation of the alumina from the crude sulphate. In most cases sewage thus purified may be allowed to run into a stream of adequate dimensions, and in places where running-water is not at hand, special filtering-beds must be prepared to effect the final purification of the clarified sewage.

Means of purifying sewage.

Clay soils unfit for irrigation.

Crude sulphate of alumina best precipitating agent.

Summing up briefly these remarks on the disposal of sewage in England, I would observe:—

1. In my judgment, the most economical plan to dispose of town-sewage is to carry it, if possible, bodily far enough into the open sea to destroy any chance of its being brought back again by the tide.

Disposal of town sewage.

2. When sewage cannot be taken out into the sea, and land

fit for downward intermittent filtration can be acquired, the sewage, partially clarified by subsidence, may be dealt with partly in the way of ordinary irrigation, with a view of realising a profit in growing Italian rye-grass and other crops, and partly by way of concentrated or downward intermittent filtration, with a view of getting rid of the excess of sewage for which the sewage farmers cannot find a profitable use.

3. When such land cannot be procured, recourse should be had to the purification of sewage by chemical precipitating agents.

4. Town sewage, in my opinion, far from being a valuable agricultural commodity, is a nuisance, which can only in exceptional circumstances be turned to profitable account. It cannot therefore be reasonably expected that the agriculturist should have to pay the costs which the disposal of sewage entails, and which ought to be defrayed by the ratepayers, who enjoy the luxury and comfort of a system of water-closets and thorough town drainage.

---

## CHAPTER IV.

### IMPROVEMENT OF PERMANENT PASTURES.

Recent attention to the subject.

PERMANENT pastures in England were much neglected previous to 1860, little or nothing in the way of improvements having been done until then to most grass lands. During the last six or eight years, however, owing partly to the good prices of dairy produce and of store stock and butcher's meat, more attention has been paid to the improvement of permanent pastures. In a report on the application of chemistry to agriculture, it would be out of place to enter into details as to the means whereby worn-out old pastures, and grass land in general, have of late years been so much improved. The subject is introduced into this report mainly for the purpose of pointing out that the improvements which have recently taken place in England are due in a great measure to the laborious and long-continued experiments of Messrs. Lawes and Gilbert. The experiments to which I specially refer were carried out in Mr. Lawes's Park at Rothamsted, with a view of studying the influence of different manuring agents on the mixed herbage of permanent grass-land. They were commenced in 1856, and have now been continued over a period of twenty years. At the commencement of this long experimental period, the herbage was pretty uniform over the whole area selected, and included a number of plants, of which about fifty species vary so prominently as to be readily recognised in a fair average sample of hay grown without manure. About

Experiments at Rothamsted.

twenty plots, from one-quarter to one-half an acre each, were marked out, of which two have been left continuously without manure, and each of the others has received its own special manure, and, as a rule, the same description year after year.

Some plots were manured exclusively with salts of ammonia or nitrate of soda; others with purely mineral manures of various kinds, some being of a more mixed character, including phosphates and salts of potash; others being composed chiefly of phosphates without potash. Again, on other plots, the effect of mixed minerals and nitrogenous and animal manures in various proportions on the mixed herbage was tried. Effects on the herbage.

Under this varied treatment, a remarkable change in the flora became apparent, even in the first years of the experiments, and in later years these changes have been more fully developed; so much so that the herbage of most of the variously manured plots now presents a striking contrast to that of the unmanured plots.

On the plots manured with large quantities of ammonia, the finer grasses, as well as the clovers and other leguminous plants, in a few years disappeared all but completely, as if by magic; and on the other hand, on those plots to which potash and superphosphate were applied clovers and other Leguminosæ made their appearance in increased numbers and vigour.

Dr. Gilbert summarises the general results of the experiments briefly as follows:— Results of the experiments.

The mean produce of hay per acre per annum has ranged on the different plots from 23 cwt. without manure to about 64 cwt. on the plot the most heavily manured.

The number of species found has generally been about 50 on the unmanured plots, and has been less on the most poorly manured plots.

Species belonging to the order Gramineæ have, on the average, contributed about 68 per cent. of the weight of the mixed herbage grown without manure; about 65 per cent. of that grown by purely mineral manures (that is, without nitrogen); and about 94 per cent. of that grown by the same mineral manures, with a large quantity of ammonia-salts in addition.

Species of the order Leguminosæ have, on the average, contributed about 9 per cent. of the produce without manure, about 20 per cent. of that by purely mineral manures (containing potash), and less than 0.01 per cent. of that by the mixture of the same mineral manures and a large quantity of ammoniacal salts.

Species belonging to various other orders have, on the average, contributed about 23 per cent. of the produce grown without manure, about 15 per cent. of that grown by purely mineral

manures, and only about 6 per cent. of that grown by the mixture of the mineral manures and a large amount of ammonia-salts.

The preceding brief account obviously can only very inadequately indicate the interest of these curious illustrations of the domination of one plant over another in the mixed herbage of permanent grass-land, but it is sufficient to illustrate the power which the farmer has in his hand to modify, by means of properly selected manures, the herbage of his pasture land, and to increase its produce.

Speaking generally, nitrogenous manures increased the quantity, phosphatic and potash manures raised the quality of the pasture.

Unfortunately, the application of artificial manures to permanent pastures is often disappointing in an economical point of view. As a rule, no artificial manuring mixture gives so favourable a return as good farmyard manure, or the manure produced by the consumption of cake, more particularly decorticated cotton-cake, on the pasture. In many cases the most profitable way to improve permanent pasture is to feed off the grass, giving from 3 to 4 cwt. of decorticated cotton-cake per head of cattle; and, on the whole, those farmers who apply farmyard manure liberally to pasture land, and grow their roots and cereal crops with artificial manures, derive more advantage from this practice than others who apply artificial manures to pasture land, and common dung to cereal and root crops.

Farmyard  
dung best.

## CHAPTER V.

### FEEDING AND REARING OF STOCK.

Early  
maturity.

THE great change which has taken place in the practice of feeding stock in modern times has consisted in bringing the animals much earlier to maturity, by means of careful breeding and more liberal feeding.

In England great attention is paid to supplying the young animals liberally with such foods as linseed-cake, pease, and bean-meal, which are rich in nitrogenous constituents. It is well known that animals stunted in their youth in food of the proper kind do not fatten well in after years.

Value of che-  
mistry.

Chemistry has done already, and is still doing, good service to the breeder and fatterer of stock by determining the composition of nearly every description of feeding material, and investigating the physiological functions of the various constituents of food in the animal economy, with the ultimate object of

making the best economical use of the various kinds of feeding-stuffs at the disposal of the breeder and feeder of stock.

The English market is well supplied with numerous articles of food, some of which are scarcely ever used by continental farmers, though largely employed by British farmers for feeding and fattening purposes.

It may not be amiss, therefore, to give a list of the various articles of food used in England, and to add a few remarks in some instances.

Linseed and rape-cake, especially the former, are largely used for feeding and fattening purposes, and, if pure and in good condition, no food is considered to equal linseed-cake for rapidly fattening sheep and oxen. Linseed-cake.

Earthnut-cake is occasionally sold in England to the farmer, but more frequently it is bought up by cake-makers, and used for adulterating linseed-cake. Earthnut-cake.

There are two varieties of cotton-cake. One is made in England from Egyptian cotton-seed, shell and kernel crushed together, and the other is principally imported from New Orleans, and made in America from the decorticated seed. Cotton-cake. Decorticated cotton-cake has also been manufactured in Liverpool to a small extent the last year or two, from the kernels of cotton-seed imported from America. Both descriptions of cotton-cake are largely used by English stock-feeders. Whole-seed cotton-cake has been found very useful to store sheep and oxen out on grass, at periods of the year when they are apt to become affected by scour; and it is also given with much advantage to stock fed upon abundance of succulent food, which has a tendency to keep the bowels in too loose a state. In these cases the astringent principle contained in the husk of cotton-seed acts medicinally as a never-failing corrective. Decorticated cotton-cake, being made from the kernel in which all the nutriment resides, is a much more concentrated food than cake made from the whole seed. On an average it yields about 40 per cent. of nitrogenous matters, and possesses high manuring qualities, but it is too rich in nitrogenous compounds to suit by itself the health of herbivorous animals. It is rather indigestible, and requires to be broken up finer than linseed-cake ordinarily is; it should be given to fattening stock more sparingly, and mixed with about twice its weight of Indian corn or barley-meal, or meal rich in starch and comparatively poor in nitrogenous compounds.

Experience further has shown that, when sheep are put on rough poor pasture, on which they are obliged to ramble over much ground in order to pick up sufficient food, the very best means of making the most of the wiry herbage, and to keep the sheep in good condition, and at the same time to materially



improve the grass land, is to allow them from one-half to three-quarters of a pound of decorticated cotton-cake per head per day. In that case it is essential, for maintaining them in good health, to give the sheep free access to water.

**Cocoanut-cake.** Cocoanut-cake and palmtree-kernel cake and meal are produced at Liverpool and other places in England, and are much appreciated for their fattening properties. These cakes contain from 14 to 15 per cent. of albuminous compounds, and variable proportions of oil, and are better adapted for fattening stock than for young growing animals or store stock.

**Locust-beans.** Locust-beans in the shape of meal, containing on an average from 50 to 54 per cent. of sugar, are much relished by horses, oxen, and sheep, and are used in England to a considerable extent, and with advantage, as an addition to other and less palatable food. Locust-bean meal is also a favourite addition to almost all compound cattle-foods, compound feeding-cakes, and cattle-spices sold in England.

**Rice-meal.** Rice-meal, obtained in preparing rice for consumption, is rich in starch, the better qualities generally containing from 7 to 8 per cent. of oil, and about the same proportion of albuminous substances. It is largely employed in England for fattening pigs.

**Durra grain.** Another good fattening grain which is seldom seen on the Continent, *dari* or *durra* grain, the seed of the *Andropogon Sorghum*, is occasionally imported into England, and sold at a cheap rate.

**Cereals.** Indian corn, foreign beans, oats, and barley complete the list of the concentrated foods most frequently employed in England for feeding or fattening purposes.

**Rearing and fattening stock.** The art of rearing and fattening stock has made considerable progress in England during the last twenty years. Perhaps in no country is it carried into practice so successfully as in England. Although its present high state of development and the success obtained in fattening stock in the most economical manner are mainly the results of actual practical experience, it cannot be doubted that the important investigations and numerous feeding experiments carried on at Rothamsted by Messrs. Lawes and Gilbert have contributed to this success, and much increased our knowledge of the rationale of the feeding and fattening processes.

**Experiments.** These experiments, commenced in 1847, and continued at intervals up to the present time, have established numerous important factors in relation to the proportions of the constituents in foods, which are the most favourable for fattening; the amount of food consumed in relation to a given live weight; the amount of food consumed to yield a given amount of in-



crease ; the composition of the animals themselves and of their increase ; the relation of the constituents stored in the increase to those consumed ; and, by difference, the proportion of the food constituents expired, perspired, or voided in the dung.

Numerous analyses of the excrements of oxen, sheep, and pigs, fed on foods of known composition, have also been made by Messrs. Lawes and Gilbert ; and from all the results of these important inquiries, it has been estimated that in the valuation of animal manure, founded on a knowledge of the composition of the food, 90 per cent. of the nitrogen of the food may be reckoned to be recovered in the manure in the case of cakes, pulse, and other highly nitrogenous feeding-stuffs ; and 85 per cent. in the case of foods comparatively poor in nitrogen, such as the cereal grains and roots ; and less than 65 per cent. in the case of bulky feeding-stuffs, such as hay and straw.

Proportion of nitrogen in the food recovered in manure.

The investigations have proved that our farm stock, even in the store condition, contain less nitrogenous substances and more fat than was previously supposed, and that the so-called fattening process, in fact, consists in the deposition of fat in the animal body in a much greater degree, and that of lean muscle in a much less degree, than was formerly supposed.

Another important general result of Messrs. Lawes and Gilbert's feeding experiments is that the amount of increase in live weight and in fat is, as our fattening foods go, much more dependent upon the amount of non-nitrogenous than upon that of the nitrogenous constituents which the food supplies.

In other words, the comparative values of our fattening foods, *as a source of saleable animal increase*, depend more on their amount of digestible and assimilable non-nitrogenous constituents than on that of the nitrogenous ; but, *as a source of manure*, their value is the greater the higher their proportion of nitrogenous compounds.

In the case of young stock or milking-cows not over well supplied with concentrated purchased foods, the dung will not be quite so valuable as that of fattening-stock, inasmuch as a small proportion of the nitrogenous and phosphatic food constituents will be stored up during the increase in the live weight of the young animal, or will be expended in the production of milk ; still, even in the case of growing store cattle or milking-cows, by far the larger proportion of the nitrogen and the phosphates of the food will be rejected in the solid and liquid excrements.

It is well to bear in mind that the estimated manure value of purchased foods has nothing to do with mere speculation, but rests upon well-ascertained facts, brought to light by numerous feeding experiments in this and other countries. The rate of

Estimated manure value of foods.

valuation that may be adopted by different persons may vary; but the statement that the food of fattening-stock, in passing through the animal, loses little (if any) of its nitrogen by exhalation, and none of its mineral constituents, and that, practically speaking, the whole of the mineral matter and about nine-tenths of the nitrogen of the food are recovered in the dung and urine of the animal, are based on carefully ascertained facts. In this country, a long series of most carefully conducted and intelligently conceived feeding experiments have been made by Mr. Lawes of Rothamsted. These experiments extended over several years, and they were carried out at great expense, with a variety of feeding-stuffs which were given to oxen, sheep, and pigs, care being taken to put up a sufficient number of fattening animals to counteract the irregularities arising from the different feeding capabilities of individual animals. The food consumed was carefully analysed, the gain in the live weight noted, and the loss in food by respiration ascertained; and the amount and quality of the manure produced by the consumption of various foods were determined by laborious weighings and analyses.

The greater portion of the nitrogenous and mineral matters of the food is recovered in the manure, and the greater part of the non-nitrogenous substances is lost by respiration and other exhalations, whilst a comparatively small proportion of the nitrogenous substance and of the mineral matter of food is retained in the increase.

For a given amount of increase produced, oxen void more as manure, and expend more in respiration, &c., than sheep; and sheep very much more than pigs. And lastly, for a given weight of dry substance consumed, oxen void more as manure than sheep, and sheep much more than pigs; but oxen respire rather less than sheep, and sheep rather less than pigs.

The proportions of certain constituents in a ton of various articles of food which are stored up in the animal, and the proportions which pass into the manure by the consumption of a ton of different kinds of food, have thus been ascertained with tolerable precision by actual experiments. If, therefore, the composition of the various kinds of food that are given to fattening-animals is known, we can determine beforehand, without actually analysing the manure produced from the consumption of a ton of each kind, how much nitrogen, potash, and phosphoric acid existing in the food will be recovered in the manure produced. And as nitrogen (or its equivalent expressed as ammonia), potash, and phosphoric acid (or its equivalent expressed as phosphate of lime) have a certain market value as manuring constituents, we can likewise ascertain the money value of the manure produced from the consumption of a ton

of any of the ordinary stock foods, the average composition of which has been ascertained.

By allowing 8*d.* per lb. for ammonia, 2*d.* per lb. for potash, and 1*d.* per lb. for phosphat of lime, rates which fairly represent the present market value of these fertilising constituents, the value of the manure obtained by the consumption of different articles of food may thus be estimated with sufficient accuracy to be of considerable service from a practical point of view. Proceeding on this basis, Mr. Lawes constructed the following table in which the estimated money value of manure from one ton of most ordinary articles of food is given:—

TABLE IV.—ESTIMATED VALUE of the MANURE obtained by the CONSUMPTION of different ARTICLES of FOOD, each supposed to be good quality of its kind. Mr. Lawes's table.

No.	DESCRIPTION OF FOOD.	Money Value of the Manure from one Ton of each Food.
1	Cottonseed-cake, decorticated .. ..	£ 6 10 0
2	Rape-cake .. ..	4 18 6
3	Linseed-cake .. ..	4 12 6
4	Cottonseed-cake, undecorticated .. ..	3 18 6
5	Lentils .. ..	3 17 0
6	Beans .. ..	3 14 0
7	Tares .. ..	3 13 6
8	Linseed .. ..	3 13 0
9	Pease .. ..	3 2 6
10	Indian meal .. ..	1 11 0
11	Locust-beans .. ..	1 2 6
12	Malt-dust .. ..	4 5 6
13	Bran .. ..	2 18 0
14	Coarse pollard .. ..	2 18 0
15	Fine pollard .. ..	2 17 0
16	Oats .. ..	1 15 0
17	Wheat .. ..	1 13 0
18	Malt .. ..	1 11 6
19	Barley .. ..	1 10 0
20	Clover hay .. ..	2 5 6
21	Meadow hay .. ..	1 10 6
22	Bean-straw .. ..	1 0 6
23	Pea-straw .. ..	0 18 9
24	Oat-straw .. ..	0 13 6
25	Wheat-straw .. ..	0 12 6
26	Barley-straw .. ..	0 10 9
27	Potatoes .. ..	0 7 0
28	Parsnips .. ..	0 5 6
29	Mangoldwurzel .. ..	0 5 3
30	Swedish turnips .. ..	0 4 3
31	Common turnips .. ..	0 4 0
32	Carrots .. ..	0 4 0

This table, published in a paper by Mr. Lawes in the 'Journal of the Royal Agricultural Society,' second series, vol. x., Part I., p. 11, showing the calculated value of the manure resulting from the consumption of purchased food, gives a correct chemical estimate of the comparative manurial value which the various kinds of feeding-stuffs, after they have passed through the body of the animal, would possess if the whole of their fertilising constituents could be incorporated with the soil *without loss*.

Probable losses  
in practice.

In most cases, however, in the ordinary course of farming, a certain loss, differing in amount according to a great variety of circumstances, will occur.

Thus, when the food is consumed upon the land by sheep, in favourable seasons, the loss will be comparatively small. On the other hand, if cake or corn is consumed in open yards, in a district where the annual rainfall is excessive, and where, on account of scarcity of straw or other available litter, the manure produced is made under very unfavourable conditions, a large proportion of the soluble and most valuable constituents of the dung will run to waste.

The loss due to the removal of the most valuable soluble manure constituents of food by heavy rainfall is much more considerable than the loss by evaporation; and hence the manure produced under cover will be more valuable than that made in open unspouted yards, where much of the soluble fertilising material is washed out. In other localities, where the rainfall is small, and in some cases barely sufficient to make the straw and cattle excrements into manure, little or no appreciable loss in fertilising elements is experienced, although it may be made in open yards. On farms where plenty of litter is used, it would be incorrect to make the same deductions from the calculated manure value of food as on those where the provision for retaining the soluble fertilising matters of farmyard manure is more or less defective.

Again, when the manure is produced in boxes in which fattening stock are copiously littered with cut straw, the loss in manuring matters is less than when it is made in yards with long straw.

Cake and other concentrated food given to young growing stock or to dairy cows supplies more or less of the substance of the bone and lean muscle of the growing stock, or of the milk constituents sold off the farm; and in consequence the additional value of the manure resulting from the consumption of purchased food is less in these cases than in that of full-grown fattening stock fed upon the same description and same amount of cake.

Assuming that, under the most favourable circumstances, the manure value given in the above table be adopted, we have to

consider under what circumstances and to what extent deductions are to be made. A valuer may take into consideration the various circumstances under which the manure was made. For instance, whether in boxes or yards, whether the rainfall was large or small, or whether the amount of litter was sufficient to absorb all the liquid without loss; in fact, he might value each circumstance just as he would value each separate crop in separate fields, or he may take a general average of loss.

## CHAPTER VI.

### INDUSTRIES ATTACHED TO THE FARM.

BOTH in France and in Germany the manufacture of starch, beetroot sugar, and vinegar, the distillation of spirits, and other industries, are frequently carried on in connection with ordinary farm practice. In England these industries are seldom attached to the farm, but generally pursued in separate establishments by persons not engaged in agricultural operations. Of the industries having an intimate connection with agriculture, the manufacture of beetroot sugar, the factory system of cheese-making, and the production of condensed milk, may be briefly noticed in this Report.

English farmers strictly agricultural.

*Manufacture of Beetroot Sugar.*—The first attempt to produce, on a manufacturing scale, sugar from beetroots grown in England was made in 1868 by Mr. James Duncan, who in that year established a factory for the manufacture of beetroot sugar at Lavenham, in the county of Suffolk. The sugar-beets grown by the farmers in the neighbourhood of the works, on an average, yielded fully 10 per cent. of sugar, and the produce of the roots of that quality amounted to from 15 to 18 tons per acre. When the experiment was set on foot to grow sugar-beets in the neighbourhood of Lavenham, grave doubts were expressed in many quarters whether the climate of England would prove suitable for beetroot culture. Numerous analyses, by myself and other chemists, of sugar-beets grown in different English counties, as well as in Ireland and even in some districts in Scotland, set these doubts at rest, and proved that with care and attention, and special regard to the kind and quality of manure used, sugar-beets as rich in sugar as those produced in France and Germany could be grown in Great Britain without difficulty. Nevertheless, the manufacture of beetroot sugar, after having been carried on for a limited number of years in a spirited manner by Mr. Duncan, and with success, so far as the yield of sugar was concerned, was abandoned on account of unforeseen

Beetroot sugar.



practical difficulties. For some years past sugar has not been produced from English-grown beets.

Distillation of spirits.

At about the time when the works at Lavenham were opened, Mr. Robert Campbell, of Buscott Park, in Berkshire, put up on his estate appliances of the most approved description for the distillation of spirits from home-grown sugar-beets, but after a few years these works also were closed.

Influence of manure.

Little consideration will show at once that, if the sugar-beet industry is to succeed in England, the manufacturers will have to take large areas of land, farm it specially with a view to the produce they want, and become entirely independent of the farmers in the neighbourhood. It is well known that large, heavily manured crops not only yield less sugar per cent. in the juice than smaller unmanured or sparingly manured crops, but that the juice of the former, moreover, contains much more saline and nitrogenous constituents than that of the latter, and that a proportionately larger amount of sugar can be obtained from juice less impregnated with saline and nitrogenous matters than from juice richer in these constituents. The interest of the farmer, who sells his roots to the manufacturer at a given price, manifestly is to grow large roots, and with them a heavy crop per acre; but this interest is directly opposed to that of the manufacturer, whose policy naturally must be to restrict the farmer in the use of manures which, like dung or guano, or nitrogenous manures in general, are known to produce large roots. Any such restrictions are impracticable in a country like England, and hence the difficulty which manufacturers of beetroot sugar will always find in England, viz. in being supplied by farmers with a sufficient quantity of roots of a quality to make the beetroot sugar industry successful. Generally speaking, and within certain limits, it may be said that the poorer and the smaller the crop per acre, the richer in sugar will be found the juice of the roots.

The influence of different manures on the quality of the juice of beet roots is not less marked than that on the yield per acre. Thus in the interesting experiments which were commenced in 1871 at Rothamsted, the average produce of roots during three years was:—

With dung alone, about .. .. .	16
„ and nitrate of soda, about .. .. .	24
„ and ammonia-salts .. .. .	22½
„ rape cake, and ammonia-salts .. .. .	25
„ and rape cake, about .. .. .	25
With mineral manure alone, about .. .. .	6
„ and nitrate .. .. .	19
„ and ammonia-salts .. .. .	14½
„ rape-cake, and ammonia, about .. .. .	20½
„ and rape-cake, about .. .. .	17½



The experience of Messrs. Lawes and Gilbert, myself, and others, has thus clearly proved that the climate and soils of England are by no means unfavourable to sugar-beet culture, and that roots as rich in sugar as in France and Germany can be grown in this country. If, however, the manufacturer depends for the supply of his roots upon the farmers in the neighbourhood of the factory, the latter, probably, will not find it answer his purpose to grow small crops, rich in sugar, if he can get no more than 1*l.* per ton at the factory. 1*l.* a ton may appear a good price, and to yield a good profit to a farmer who grows from 18 to 20 tons of roots per acre. Probably, however, he will have to pay 5*s.* per ton on an average for cartage to the factory, leaving 15*s.* per ton clear.

Climate favourable to growth of beetroot.

If, like many a continental beet-grower, a farmer has not sufficient capital to fatten a good number of beasts, or no good market to dispose profitably of his fat stock, it would no doubt answer his purpose very well to sell sugar-beets at 15*s.* per ton net. In many parts of the Continent where no ready and profitable sale for fat stock exists, and capital is not so abundant as in England, the manufacturers of beetroot sugar and the distillers find little difficulty in inducing farmers to grow the necessary quantity of sugar-beets to keep the factory at full work ; but in most parts of England farmers find it profitable not only to consume the food raised on the farm, but to buy additional food for the fattening-stock, and they can always obtain a much better price for well-fattened meat than can be realised on the Continent.

The fact is, a ton of sugar-beets, of average quality, is worth more to the farmer for fattening purposes than 15*s.* a ton. On farms, therefore, on which not sufficient food can be raised to meet the requirements of the fattening-stock, and where considerable sums of money are spent in the purchase of oilcake, meal, and other dry food, farmers cannot be expected to sell beets at 1*l.* a ton, and cart the roots at their own expense to the factory.

Selling beet-roots unprofitable to English farmers.

*Cheese Factories.*—Since the establishment of the first cheese factory at Derby in 1870, some twenty factories have sprung up in five different counties in England, capable of dealing with the milk of about 6000 cows. The time has therefore come when the factory movement may be acknowledged as a success. Experience has fully satisfied the expectations of those who first introduced the American factory system into England, and no doubt that system of making cheese will extend from year to year in the dairy districts. In most places where cheese factories have been erected, the kind of cheese produced is Cheddar.

Cheese factories.

The factory system is peculiarly well adapted to the making of Cheddar cheese, for direct investigations into the chemistry

Cheddar plan.

of cheese-making made by me, as early as 1861, proved that, according to the Cheddar plan, cheese-making can be reduced to something like definite scientific rules, the strict observance of which is followed by a successful result. In consequence of the more uniform and systematic separation of the curd by rennet of uniform strength, which is possible where larger quantities are dealt with than in private dairies; of its subsequent treatment by exposing it to a definite elevated temperature not exceeding  $95^{\circ}$  to  $98^{\circ}$  Fahr.; and especially in consequence of the attention which can be given to the heating of the ripening and store room in cheese factories by hot-water pipes, Cheddar cheese made in factories is generally of a superior character to that made in private dairies. Another advantage of the factory system is the diminished cost at which cheese of a superior quality is obtained with certainty if only certain plain and definite rules are strictly followed by the maker. Moreover, the factory system saves much drudgery to the farmer's wife and daughters, and offers the opportunity to dairy farmers, who generally sell their milk, to dispose of their surplus production at certain seasons of the year in the readiest and most profitable manner.

Aylesbury Dairy Company.

A large London dairy company (the Aylesbury Dairy Company), within a recent date, have established a cheese factory and piggery at Swindon, in Wiltshire, where the surplus supply of milk is turned into cheese and the whey given to pigs; and it is not improbable that the combination of cheese-making and pig-feeding with the milk supply of London will be found the most profitable plan of turning milk into money.

Condensed milk manufacture.

*Condensed Milk Manufacture.*—It may be stated of this industry that there are three establishments in the United Kingdom—one at Aylesbury, another at Marlow in Ireland, and a third at Swindon in Wiltshire, all of which produce excellent condensed milk.

In the two first-named factories the milk is evaporated in vacuum pans to the consistency of a thin syrup, which is further thickened by the addition of sugar. In the latter the milk is evaporated in open, shallow pans, at a low temperature, care being taken to keep the surface constantly agitated by wooden racks, kept in motion by machinery, so that no skin of casein is formed. When the milk has reached a certain degree of concentration, fine white sugar, previously boiled up for some time with a sufficient quantity of milk to make it into syrup, is added, and the whole evaporated to a thick syrup, in which condition the milk is transferred, whilst still warm, to tins, the lids of which are at once soldered up air-tight. In this state condensed milk generally contains from 25 to 28 per cent. of water.

## CHAPTER VII.

### EXPERIMENTAL STATIONS.

THERE are two agricultural experimental stations in England, the oldest of which is the celebrated establishment of world-wide reputation, belonging to Mr. Lawes, of Rothamsted Park, near St. Albans, in Hertfordshire. The other, called into existence quite recently, is at Woburn, Bedfordshire, on land allotted by his Grace the Duke of Bedford, for the purpose of carrying out certain field and feeding experiments, undertaken on behalf of the Royal Agricultural Society of England, under the direction of Mr. Lawes and myself.

English experimental stations.

In Scotland, the Aberdeenshire Agricultural Association, since 1875, has employed a chemist, Mr. Thomas Jamieson, for the purpose of conducting experiments in agricultural science on five sites, or "Experimental Stations," of small dimensions, viz. the stations at Aboyne, Durris, Hairis, Turriff, and Cluny.

Scotch.

Within the current year the Highland and Agricultural Society of Scotland has made arrangements to establish several Experimental Stations in several parts of Scotland.

### ROTHAMSTED EXPERIMENTAL STATION.

The foundation of the Rothamsted Experimental Station by Mr. Lawes may be said to date from 1843.

Mr. Lawes' experimental station.

This establishment has, up to the present time, been entirely unconnected with any external organisation, and has been maintained entirely by Mr. Lawes. He has further set apart a sum of 100,000*l.* and certain areas of land, for the continuance of the investigations after his death. In 1854-5 a new laboratory was built by the public subscriptions of agriculturists, and presented to Mr. Lawes in July 1855, when the old barn-laboratory was abandoned, and the new one opened.

From June 1843, up to the present time, Dr. J. H. Gilbert has been associated with Mr. Lawes, and has had the direction of the laboratory.

The number of assistants and other helps has increased from time to time. During the last twenty-five years the staff has consisted of one or two and sometimes three chemists, and two or three general assistants. The chief occupation of the general assistants is to superintend the field experiments—that is, the compounding of the manures, the measurement of the plots, the application of the manures, and the harvesting of the crops; also the taking of samples, their preparation for analysis, &c. A botanical assistant is also occasionally employed, with from three to six boys under him, and with him is generally associated one

of the permanent general assistants, who at other times undertakes the botanical work.

Two or three computers and record-keepers have been occupied in calculating and tabulating field, feeding, and laboratory results, &c.

The field experiments, and occasionally feeding experiments, also employ a considerable but a very variable number of agricultural labourers.

The investigations may be classed under two heads :—

Experiments  
on vegetation.

I. *Field Experiments.*—*Experiments on Vegetation, &c.*—The general scope and plan of the field experiments has been :—

To grow some of the most important crops of rotation, each separately, year after year, for many years in succession, on the same land, without manure, with farmyard manure, and with a great variety of chemical manures; the same description of manure being, as a rule, applied year after year on the same plots. Experiments on an actual course of rotation, with different manures, have also been made.

In this way field experiments have been conducted as follows :

On wheat, 34 years in succession, 13 acres, 35 plots, many of which are duplicates of others.

On barley, 26 years in succession,  $4\frac{1}{2}$  acres, 23 (or 29) plots.

On oats, 9 years in succession,  $\frac{3}{4}$  acre, 6 plots.

On wheat, alternated with fallow, 26 years, 1 acre, 2 plots.

On different descriptions of wheat, 9 years, 7 acres (each year on a different field), about 20 plots.

On beans, 31 years (including 1 year wheat and 5 years fallow),  $1\frac{1}{4}$  acre, 10 plots.

On beans, alternated with wheat, 28 years, 1 acre, 10 plots.

On clover, with fallow or a corn crop intervening, 28 years, 3 acres, 18 plots.

On turnips, 25 years, about 8 acres, 40 plots.

On sugar-beets, 5 years, about 8 acres, 40 plots.

On mangoldwurzel, 1 year (in progress), about 8 acres, 40 plots.

On potatoes, 1 year (in progress), 2 acres, 10 plots.

On rotation, 30 years, about  $2\frac{1}{2}$  acres, 12 plots.

On permanent grass-land, 22 years, about 7 acres, 20 plots.

Rainfall.

Almost from the commencement of the experiments the rainfall has been measured; for 24 years, in a gauge of one-thousandth of an acre area, as well as in the ordinary small funnel-gauge of 5 inches diameter. From time to time the nitrogen—as ammonia and as nitric acid—has been determined in the rain-water.

Drain-gauges.

Three “drain-gauges,” also of one-thousandth of an acre each, for the determination of the quantity and composition of the

water percolating, respectively, through 20 inches', 40 inches', and 60 inches' depth of soil, with its subsoil or natural state of consolidation, have also been constructed. A more numerous series of smaller drain-gauges, arranged for the investigation of the influence of different crops, and of different manures, are in course of construction. Each of the differently manured plots of the permanent experimental wheat-field having a separate pipe-drain, the drainage waters have frequently been collected and analysed.

Experiments were made for several years in succession to determine whether plants assimilate free or uncombined nitrogen, and also various collateral points. Plants of the graminaceous, leguminous, and other families, were operated upon. The late Dr. Pugh took a prominent part in this inquiry.

II. *Experiments on Animals, &c.* — Experiments upon the animals of the farm were commenced early in 1847, and have been continued, at intervals, up to the present time. Experiments on animals.

The following points have been investigated :—

1. The amount of food, and of its several constituents, consumed in relation to a given live weight of animal within a given time.
2. The amount of food, and of its several constituents, consumed to produce a given amount of increase in live weight.
3. The proportion, and relative development, of the different organs or parts of different animals.
4. The proximate and ultimate composition of the animals in different conditions as to age and fatness; and the probable composition of their increase in live weight during the fattening process.

5. The composition of the solid and liquid excreta in relation to that of the food consumed.

6. The loss or expenditure of constituents, by respiration and cutaneous exhalation—that is, for the mere sustenance of the living meat-making and manure-making machine.

*Supplementary Investigations.*—In conjunction with Professor Way, an extensive investigation was undertaken on the application of town sewage to different crops; but especially to grass. The amount and the composition of both the sewage and the produce grown were determined, and in selected cases the composition of the land-drainage water was also determined. Application of town sewage.

Comparative experiments were also made on the feeding qualities of the differently grown produce; the amount of increase yielded by oxen, and the amount and composition of the milk yielded by cows, being determined. In this inquiry part of the analytical work was performed at Rothamsted, but most of it by Professor Way in London.

The chemistry of the malting process, the loss of food constituents during its progress, and the comparative feeding-value of barley and malt have also been investigated.

#### EXPERIMENTAL STATION AT WOBURN, BEDFORDSHIRE.

Woburn  
experiments.

*Origin, Objects, and Plan of the Woburn Experiments.*—In the autumn of 1875, Mr. C. Randell proposed to the Council of the Royal Agricultural Society that it be referred to the Chemical Committee to consider the propriety, and the manner, of instituting a series of experiments, to test the accuracy of the estimated value of manure obtained by the consumption of different articles of food, as given in Mr. Lawes' Paper in the 'Journal' of the Society for that spring (*vide supra*, p. 575). The subject had become especially important since, in accordance with the provisions of the Agricultural Holdings Act, compensation to outgoing tenants for the unexhausted value of purchased food would become subject to arbitration. Mr. Randell proposed that such experiments should be conducted by practical farmers, in different districts, so as to secure a great variety of soil and climate, and that the Society should grant funds for the purpose. In the course of the inquiry and discussion which arose in connection with Mr. Randell's motion, it seemed to be generally considered that further experimental evidence on the subject might be of much value; but it was at the same time decided that the probability of obtaining sufficiently accurate and applicable results in that way was not such as to justify the Council of the Society in making a grant for the purpose.

Particulars of  
experimental  
lands.

Under these circumstances, his Grace the Duke of Bedford expressed his desire to afford facilities for making new experiments at his own cost; and Mr. Lawes and myself were requested to draw up a scheme for carrying on, at Woburn, such experiments as they, in communication with the Chemical Committee, might determine on. His Grace offered to give up for the purpose Crawley Mill Farm, comprising about 90 acres, with the house and buildings. But, on examination, it was found that there was no sufficient area on that farm so even in character and in condition of soil as to render it available for a considerable series of comparative field experiments. Eventually, after inspection of many others, a large field of much more suitable land was selected, on Birchmoor Farm; and his Grace made arrangements with the tenant to give it up for the purpose. Crawley Mill Farm is, however, also retained, as a means of providing a residence for the superintendent of the experiments, the requisite buildings, and the opportunity of having at command the necessary horse and hand labour for the experiments.



As experiments to determine the value of the manure obtained by the consumption of purchased foods obviously involved the necessity of feeding animals under conditions in which the manure could be collected with as little loss as possible, the Duke of Bedford erected eight very complete feeding-boxes, in which the manure for the experimental barley and root crops, as will be explained further on, is made.

The following is a description of the various experiments:—

“*Stack-yard Field*,” which is devoted to the field experiments, has an area of nearly 27 acres. The soil consists of a very light loam, to the depth of about 9 inches; and the subsoil is almost pure sand. Samples of the soil and of the subsoil have been taken in fifteen different places. In each case six samples, each of the depth of 9 inches, or to a total depth of 54 inches, were taken.

*Plan of the Field Experiments.*—It was considered important, especially with reference to valuations under the Agricultural Holdings Act, to add, if possible, to our knowledge of the manure value of both artificial manures and consumed feeding-stuffs; and it was decided, therefore, both to compare the effects of the manure obtained by the consumption of selected purchased foods with those obtained by artificial manures estimated to supply the same constituents, and also to determine the effects of dung, and artificial manuring substances, applied year after year, on the Woburn soil, and to compare these with the results obtained for so many years, with the same manures, on the very different soil at Rothamsted. Accordingly,  $2\frac{3}{4}$  of the 6 acres where wheat had been grown in 1876, after tares and turnips, each fed with cake, are devoted to the continuous growth of wheat, and  $2\frac{3}{4}$  acres to the continuous growth of barley. In each case the area is divided into eleven plots, of a quarter of an acre each; and the description and quantities of the manures applied per acre per annum, to both the wheat and the barley, are as follows:—

Plan of the field experiments.

Plot 1.—Unmanured.

„ 2.—200 lbs. ammonia-salts; containing 50 lbs. ammonia.

„ 3.—275 lbs. nitrate soda; containing nitrogen = 50 lbs. ammonia.

„ 4.—200 lbs. sulphate potass, 100 lbs. sulphate soda, 100 lbs. sulphate magnesia,  $3\frac{1}{2}$  cwt. superphosphate of lime.

„ 5.—200 lbs. sulphate potass, 100 lbs. sulphate soda, 100 lbs. sulphate magnesia,  $3\frac{1}{2}$  cwt. superphosphate; and 200 lbs. ammonia-salts, containing 50 lbs. ammonia.

„ 6.—200 lbs. sulphate potass, 100 lbs. sulphate soda, 100 lbs. sulphate magnesia,  $3\frac{1}{2}$  cwt. superphosphate; and 275 lbs. nitrate soda, containing nitrogen = 50 lbs. ammonia.

„ 7.—Unmanured.

„ 8.—200 lbs. sulphate potass, 100 lbs. sulphate soda, 100 lbs. sulphate magnesia,  $3\frac{1}{2}$  cwt. superphosphate; and 400 lbs. ammonia-salts, containing 100 lbs. ammonia.

Subdivision of plots.

Plot 9.—200 lbs. sulphate potass, 100 lbs. sulphate soda, 100 lbs. sulphate magnesia,  $3\frac{1}{2}$  cwt. superphosphate; and 550 lbs. nitrate soda, containing nitrogen = 100 lbs. ammonia.

„ 10.—Farmyard manure, estimated to contain nitrogen = 100 lbs. ammonia.

„ 11.—Farmyard manure, estimated to contain nitrogen = 200 lbs. ammonia.

Rotation  
experiments.

*The Rotation Experiments.*—Mr. Randell's original proposition was to compare, experimentally, the manure value of four different descriptions of cake, namely—

Decorticated cotton-cake,  
Common cotton-cake,  
Linseed-cake,  
Rape-cake.

Calculation showed, however, that taking into consideration the comparatively small proportion in the total dung of the constituents yielded by the purchased food consumed, there would not be sufficient difference in the manure value of dung made by the use of equal quantities in each case of these four feeding-stuffs to lead to the expectation that separate feeding experiments with them, followed by separate field experiments made with the dungs produced, would give results sufficiently distinctive to form any reliable basis of estimates of their actual and comparative manure value.

It was decided, therefore, to limit the inquiry to comparative experiments between decorticated cotton-cake, which, among purchased feeding-stuffs, has a very high manure value, and maize-meal, which has a very low manure value; and to compare the effects of the manures obtained by the consumption of these foods with those of artificial manures supplying, in one case, the same amount of nitrogen, potass, phosphoric acid, &c., as is estimated to be contained in the manure from the cotton-cake consumed, and in another the same as in that from the maize-meal consumed.

Feeding ex-  
periments.

Accordingly, four feeding experiments have been conducted, in each of which the same amount of litter has been used, and the same amount of roots and the same amount of wheat-straw chaff consumed. In Experiment 1, 1000 lbs. decorticated cotton-cake were given in addition; and in Experiment 2, 1000 lbs. maize-meal. In Experiments 3 and 4, no purchased food was given; but in Experiment 3 artificial manures estimated to contain the same amount of the chief constituents as the manure from 1000 lbs. of cotton-cake, and in Experiment 4 the same as from 1000 lbs. maize-meal, will be applied to the land, in addition to the root and chaff manure.

It may be explained that the amount of nitrogen, &c., in the manure from the purchased foods is calculated according to the same rule as that adopted in the construction of Mr. Lawes' table of the estimated value of the manure obtained by the con-

sumption of different articles of food.\* That is to say, in the case of foods of high percentage of nitrogen, such as cakes and pulse, 10 per cent. of the total nitrogen of the food is deducted for increase in live weight and for some loss, and 90 per cent. is reckoned to be recovered in the manure; and in the case of foods of comparatively low percentage of nitrogen, such as the cereal grains, 15 per cent. is deducted for increase and loss, and 85 per cent. is estimated to go into the manure. Of the mineral constituents, phosphoric acid, potass, &c., generally a considerably less proportion of the amount of them in the food than of the nitrogen is deducted; but the deduction of a little more or a little less of these very immaterially affects the valuation of the manure.

The rotation adopted is the ordinary four-course—of roots, <sup>Rotation 2</sup>barley, seeds, and wheat. <sup>adopted.</sup> There are four kinds of manure to be applied for the roots, as above described, to each of which 1 acre has been allotted. When the land is in seeds, Plot 1 will be fed by sheep with a given amount of cotton-cake; Plot 2 with the same amount of maize-meal; Plot 3 without purchased food; but artificial manure, supplying the chief constituents estimated to be contained in the manure from the cotton-cake consumed on Plot 1, will be applied to the succeeding wheat; Plot 4 also will be fed without purchased food, but artificial manure, estimated to be equal to that from the maize-meal consumed, will be applied to the succeeding wheat.

Accordingly, 4 acres of barley grown in 1876, after spring tares fed once with cake, were sown with seeds; and 4 acres were sown with mangolds. The remaining portion of the field was again sown with barley, but manured with 7 cwt. of rape-cake per acre; 4 acres of it were sown with seeds to come under experiment next year; and 4 more will be sown with roots, and also come under experiment next year. Thus 8 acres came into exact experiment this year (1877), and the remaining 8 will come in 1878.

The following plan shows at one view the course of cropping of the 16 acres under rotation experiments:—

	Rotation, No. 1. 4 Acres.	Rotation, No. 2. 4 Acres.	Rotation, No. 3. 4 Acres.	Rotation, No. 4. 4 Acres.
1877	Seeds.	Roots.	{Barley, with 7 cwt. Rape- cake per acre.}	
1878	Wheat.	Barley.	Seeds.	Roots.
1879	Roots.	Seeds.	Wheat.	Barley.
1880	Barley.	Wheat.	Roots.	Seeds.
1881	..	..	Barley.	Wheat.

\* 'Journal of the Royal Agricultural Society of England,' vol. xi., s.s., Part I.

In the introduction to this sketch of the influence of chemical discoveries on the progress of English agriculture I briefly alluded to the value of the Rothamsted field experiments; in the concluding pages I again referred to them somewhat more in detail, and at the same time spoke of the recent extension of field experiments in England and Scotland. This short account of the experimental stations in Great Britain may appropriately wind up my report, for it appears to me suggestive of the direction which chemico-agricultural investigations have to take, in a more decided manner and on a more extended scale than in years past, in order to be followed by practically useful results.

Agricultural not less than scientific progress, in a great measure, is based on well-conceived and carefully executed experiments; and in no department of inquiry so much remains to be accomplished as in the difficult and intricate field of agricultural experiments. During the past twenty-five or thirty years the chemical ground, so to say, has been well cleared by numerous analytical researches into the composition, physiological effects, and practical value of many kinds of feeding-materials, the composition and chemical properties of soils, and the chemical character and value of manures; and the time has now arrived when the labours of the chemist can only be expected to bear still more useful fruits than hitherto if his investigations are largely put to the test of practice in the fields and feeding-stalls of the farmer.

Let us therefore hope that the example set by Mr. Lawes, at so much expenditure of time and money, and with so much benefit to the agricultural community at large, will stimulate others, as it has done of late the Council of the Royal Agricultural Society of England, to promote the establishment and maintenance of agricultural stations, which, if well directed, are calculated to exert the most beneficial influence on the future progress of British agriculture.

X.

THE  
ROYAL AGRICULTURAL SOCIETY  
OF ENGLAND.

BY

H. M. JENKINS, F.G.S.,

SECRETARY OF THE SOCIETY AND EDITOR OF ITS 'JOURNAL.'

Faint, illegible text at the top of the page, possibly a header or introductory paragraph.

*THE HISTORY OF THE*  
*ROYAL SOCIETY OF LONDON*

Faint, illegible text in the middle section of the page, likely the beginning of the main body.

Faint, illegible text at the bottom of the page, possibly a concluding paragraph or footer.



## CONTENTS.

---

### CHAPTER I.—*Objects, Constitution, and Management.*

When founded and incorporated by Royal Charter—Exclusion of Politics—Necessity of this Provision—Objects of the Society—Practice with Science—Constitution—Election and Powers of President and Council—Present Number of Governors and Members—Finance—Staff—Standing Committees—President—Functions of Committees .. .. Pages 593-600

### CHAPTER II.—*Practice.*

Annual Exhibition—Honorary Officers—Development of Show—Results from 1839-1877—Exhibition of Implements—Subordinate Position in 1839—Competition for Prizes—Its Advantages—Classification of Implements for Trial—Existing System—Steam Cultivation—Its Origin in 1854—Its Position in 1866—Resumé—Exhibitions of Live Stock—Confined to Breeding Stock—Increase in the Number of Breeds—Shropshire Sheep—Present Policy commenced at the Battersea Meeting in 1862—Horses—Farm Prizes—Originated at Oxford in 1870—Subdivision of Classes in 1877—Competition not always keen—Conditions of Competition—Instructions to Judges—Reports of Judges—General Results .. .. Pages 600-616

### CHAPTER III.—*Science.*

Chemistry—Members' Privileges of Analysis—Reports on Sales of inferior and adulterated Manures and Feeding-stuffs—Advice to Members—Experiments and Investigations—Natural History—Members' Botanical and Zoological Privileges—Veterinary Department—Members' Privileges—Importance of the Veterinary Department—Investigations into Diseases of Animals of the Farm .. .. Pages 617-622

### CHAPTER IV.—*The Propaganda of Agriculture.*

The 'Journal'—Its History—Its Usefulness—Agricultural Education—Senior Examination—Junior Examination—Examination of Veterinary Surgeons—Education of the Landowner—and of the Labourer—Retrospect  
Pages 623-627

THE HISTORY OF THE

REVOLUTION

CHAPTER I - THE BEGINNING

The first part of the history of the revolution is the story of the struggle for independence. It begins with the signing of the Declaration of Independence in 1776, and continues through the years of the Continental Congress and the early years of the new nation.

CHAPTER II - THE BATTLE OF BOSTON

The second part of the history of the revolution is the story of the Battle of Boston. It begins with the British evacuation of Boston in 1773, and continues through the years of the Siege of Fort Mifflin and the Battle of the Clouds.

CHAPTER III - THE BATTLE OF BUNTON

The third part of the history of the revolution is the story of the Battle of Bunton. It begins with the British evacuation of Bunton in 1773, and continues through the years of the Siege of Fort Mifflin and the Battle of the Clouds.

CHAPTER IV - THE BATTLE OF BUNTON

The fourth part of the history of the revolution is the story of the Battle of Bunton. It begins with the British evacuation of Bunton in 1773, and continues through the years of the Siege of Fort Mifflin and the Battle of the Clouds.

# THE ROYAL AGRICULTURAL SOCIETY OF ENGLAND.

---

## INTRODUCTION.

IT has been thought desirable to add to the foregoing series of Memoirs on English Agriculture, a brief account of the Royal Agricultural Society of England,—the institution under whose direction this book has been written, and upon whose model the Société des Agriculteurs de France was framed. Mr. Caird has already mentioned the absence of a Ministry of Agriculture from our executive government, and the distribution of certain statistical, sanitary, and judicial functions between the Board of Trade, the Privy Council, and the Inclosure Commission. The other duties which usually devolve upon Ministries of Agriculture, such as stimulating improvement in the various breeds of live stock, in the cultivation of the land, in the education of the agricultural classes, and generally in what has been termed “the propaganda of agriculture” are in England ignored by the Government, and therefore left to the “private initiative” of individuals or Societies. The Royal Agricultural Society of England is the largest and the most influential of the Societies which have been established in the three kingdoms for the advancement of agriculture. Owing to its national character and the extent of its operations it has obtained the support of a large number of leading landowners and tenant-farmers in England and Wales, besides not a few in Scotland and Ireland, which portions of the United Kingdom also possess their own national Societies. Nearly every county and even many smaller districts in England can also boast of their Agricultural Society, each one having its independent management and its own annual Exhibition, except when the “Royal” comes their way, at which time the county Society generally suspends its Show for the year, and makes a contribution from its funds towards the expenses of the national Exhibition, most frequently in the form of special prizes having a local interest. It need scarcely be added that the Society receives no subsidy from the Government in aid of any of its operations.

## CHAPTER I.

## OBJECTS, CONSTITUTION, AND MANAGEMENT.

When founded and incorporated by Royal Charter.

THE Royal Agricultural Society of England commenced its career in 1838 under the name of "The English Agricultural Society."\* On March 26th, 1840, it obtained a Royal Charter of Incorporation, which enumerated the chief founders of the Society, and recited that they had "formed themselves into a Society for the general advancement of English Agriculture," and that an "essential principle" of its constitution was, "the strictest exclusion from their councils of every question of discussion having a political tendency, or which shall refer to any matter to be brought forward, or at any time pending, in either of our Houses of Parliament." Accordingly, the Royal Charter was granted "under the condition that a principle of its constitution shall be the total exclusion of all questions at its meetings, or in its proceedings, of a political tendency, or having reference to measures pending, or to be brought forward, in either of our Houses of Parliament, which no resolution, bye-law, or other enactment of the said body politic and corporate, shall on any account or pretence whatever be at any time allowed to infringe." Political subjects were further defined to be "those questions of debate on which the people of every individual country entertain sentiments so much at variance with each other."

Exclusion of Politics.

Necessity of this provision.

The exclusion of questions of a political nature from the Objects of the Society was no doubt essential to its success at the time when the Royal Charter was granted; and if the Charter has conferred on the Society no other benefit, it had the very beneficial effect of producing cohesion in the newly formed association by giving the force of law to what was previously a voluntary resolution which might have been rescinded by the majority of members present and voting at any Meeting of the Council. Of late years it has often been questioned whether the Society should not be at liberty to

---

\* It may be desirable to mention that in the United Kingdom there is no obstacle to the voluntary association of individuals for the promotion of any lawful object. The embodying of such an association into a corporate body, which has power to hold property in its own name, and to be itself responsible for its debts—thus relieving the individual members from personal pecuniary liabilities arising out of its action—can be accomplished either by means of a Royal Charter, or (of late years) by registration under the "Limited Liability Companies Acts." In the former case, the objects and rules of the association must be approved by the Privy Council, and their essence is embodied in the Royal Charter of Incorporation, the limits of which must not be exceeded. In the latter case, the Board of Trade is the examining body, and its function has a more or less commercial character. Royal Charters are not now granted except for well-defined objects of recognised public utility.

discuss practical questions which are to come before Parliament; and the Government itself has from time to time sought information on such subjects from the Council and officers of the Society. These cases, however, have not actually been, at the time they were under discussion, pending in either House, but were preliminary to that state of things which the Charter seems to contemplate. No objection, therefore, has been raised to the Society petitioning the Government to take measures, for instance, to defend agriculturists against a common enemy, such as the Cattle Plague or the Colorado Beetle; but there would be an insuperable objection to the discussion by the Society or the Council of the provisions of any Bill which might be laid before Parliament for such purposes.

The Charter not only informs the Society what it may not do, but states its function to be "the general advancement of English Agriculture" and the prosecution of the following national objects, namely:—

Objects of the Society.

"First, to embody such information contained in agricultural publications, and in other scientific works as has been proved by practical experience to be useful to the cultivators of the soil.

"Second, to correspond with Agricultural, Horticultural, and other Scientific Societies, both at home and abroad, and to select from such correspondence all information which, according to the opinion of the Society, may be likely to lead to practical benefit in the cultivation of the soil.

"Third, to pay to any occupier of land, or other person who shall undertake, at the request of the Society, to ascertain by any experiment how far such information leads to useful results in practice, a remuneration for any loss that he may incur by so doing.

"Fourth, to encourage men of science in their attention to the improvements of agricultural implements, the construction of farm-buildings and cottages, the application of chemistry to the general purposes of agriculture, the destruction of insects injurious to vegetable life, and the eradication of weeds.

"Fifth, to promote the discovery of new varieties of grain and other vegetables useful to man, or for the food of domestic animals.

"Sixth, to collect information with regard to the management of woods, plantations, and fences, and on every other subject connected with rural improvement.

"Seventh, to take measures for the improvement of the education of those who depend upon the cultivation of the soil for their support.

"Eighth, to take measures for improving the veterinary art, as applied to cattle, sheep, and pigs.

"Ninth, at the Meetings of the Society in the country, by the distribution of prizes, and by other means, to encourage the best mode of farm cultivation and the breed of live stock.

"Tenth, to promote the comfort and welfare of labourers, and to encourage the improved management of their cottages and gardens."

These Objects have been well embodied in the Society's motto, "Practice with Science," and to describe the manner in which they have been carried out will be the chief aim of this paper.

Practice with Science.

It is necessary, however, to give a brief sketch of the "Constitution.

Constitution.



tution and Management” of the Society, to enable the mode in which its operations are conducted to be properly understood. The Charter enacts that the Society shall consist of an indefinite number of Subscribers classed according to their rate of payment into Governors and Members (with such individual privileges as shall appertain to them respectively), as well as such Honorary, Corresponding, and Foreign Members as may be found desirable. It also stipulates that there shall be an Annual General Meeting held in London on the 22nd of May; a General Meeting held in December, also in London; and a third “in such other part of England or Wales as shall be deemed most advantageous in time and place for the advancement of the objects of the Society.” At the Annual Meeting in May the Governors and Members “have the full power and privilege of electing the President, Trustees, Vice-Presidents, and other members of the Council from the Governors and Members;” but beyond this point they have no voice in the management of the Society, for the Charter further enacts “that the President and Council shall have the sole management of the income and funds of the said body politic and corporate, and also the entire management and superintendence of all the other affairs and concerns thereof.” This condition is not usually found in the Charter of Incorporation of a learned Society, and its insertion in this Society’s Charter is probably due to the political circumstances of the time. Harshness has been wisely softened as much as possible by the Bye-laws which have been enacted by the Council. These permit Governors to be present at the meetings of the Council, and to speak, though they may not vote. It is also the practice to ask the Members at the General Meetings whether they have any suggestions to offer for the consideration of the Council; and the suggestions made on those occasions receive careful attention at the next meeting of the Council. Thus, although the Council have the entire management and control of the affairs of the Society, the Members have the opportunity of expressing their views on the action of the Council at the General Meetings three times in the year, and the Governors can do the same at each Monthly Council. Further, all the Trustees and Vice-Presidents, of whom there are twelve of each title, are elected annually at the General Meeting in May, when 25 out of the 50 other Members of the Council are also elected by the Governors and Members then assembled. Therefore two-thirds of the Council might be replaced at any Annual Meeting.

Governors pay an Annual Subscription of 5*l.*, or a Life Composition of 50*l.*; and Members pay an Annual Subscription of 1*l.*, or a Life Composition of 10*l.* At the last General Meeting

Election and powers of President and Council.



held in December, 1877, the numbers of the Society were as follows:—

81 Life Governors,
74 Annual Governors,
2280 Life Members,
4182 Annual Members,
17 Honorary Members.

Number of  
Governors and  
Members.

Total . . .	6634
-------------	------

The income from Annual Subscriptions for the year is thus theoretically 4552*l.*; and in the year ending December 31st, 1877, it was actually 4413*l.* 18*s.* In that year, however, the Life Compositions received amounted to 1201*l.*, and the question therefore arises, in what manner are such payments treated? In the infancy of a Society the recognised principle is that all Life Compositions should be invested either in dividend-paying stocks or in some property of a permanent and remunerative character. When, however, a Society acquires stability, and may be regarded as established on a permanent footing, it is generally held to be sufficient if the acquired property represents a sum equal to that of the Life Compositions of existing Members. Thus, if 100 new Members pay Life Compositions amounting to 1000*l.* in any year, and if during the same year 100 old Life Members die, it would be safe to treat the sum of 1000*l.* as part of the income of the year, for the interests created are balanced by the interests extinguished. At the end of 1876, the value of the Society's property was 30,126*l.*, of which 25,511*l.* was invested in Government securities, while the compositions of Life Governors and Life Members on the list at the General Meeting in December amounted to 26,850*l.* This is as close an approximation to theoretical requirements as can fairly be expected in the accounts of a Society whose finances must fluctuate with the result of its annual Exhibition, and whose expenditure includes large annual grants to defray the cost of important scientific investigations.

Finance.

It may be of interest to mention the proportionate cost of the several departments of the Society's work to each of the 6634 members, supposing all to pay an Annual Subscription of 1*l.* That sum would roughly be apportioned as follows: management, including rent, taxes, &c., printing, postage, &c., and salaries would absorb 6*s.* 6*d.*; 'Journal,' including postage, but deducting sales, 4*s.* 6*d.*; Chemical, Botanical, Veterinary, Education and other grants, 5*s.*; thus leaving a margin of 4*s.* in the £, or 20 per cent. towards the cost of the annual Exhibition.

TABLE I.—Showing the NUMBER of MEMBERS, the RECEIPTS and the EXPENDITURE of the ROYAL AGRICULTURAL SOCIETY of ENGLAND from 1841 to 1877 inclusive.

Year.	No. of Members.	Subscriptions, including Compositions of Life Members.	Dividends on Stock.	Total Receipts.	Total Expenditure.
		£	£	£	£
1841	4595	5818	200	6018	3493
1842	5834	5884	214	6098	3630
1843	7000	6628	245	6873	3984
1844	6927	7117	320	7437	3921
1845	6933	6342	251	6503	3402
1846	6971	7040	221	7261	5063
1847	6391	6365	221	6636	4112
1848	6335	5211	312	5523	3830
1849	5512	6372	280	6652	4131
1850	5261	6083	321	6404	3994
1851	5121	5953	321	6274	3664
1852	4981	5244	334	5578	3892
1853	4923	4801	327	5128	4022
1854	5177	5053	335	5388	3362
1855	4882	3449	261	3710	3678
1856	4979	5156	259	5415	3538
1857	5068	3728	265	3993	4051
1858	5146	5339	282	5621	3734
1859	5161	3027	289	3316	3466
1860	5165	6398	319	6717	3877
1861	4633	4789	425	5214	4181
1862	4823	5463	505	5968	5041
1863	5183	5050	478	5528	3960
1864	5496	5144	546	5690	4282
1865	5752	4796	672	5468	5140
1866	5622	4238	561	4799	5501
1867	5465	4835	518	5353	4869
1868	5461	4732	487	5219	4950
1869	5446	5043	649	5692	5021
1870	5438	5138	786	5954	4459
1871	5648	4958	748	5706	4859
1872	5766	5998	754	6352	4934
1873	5916	5085	765	5850	5391
1874	5846	5269	733	6002	5256
1875	6145	6264	607	6871	5614
1876	6349	5752	565	6317	5604
1877	6634	5614	752	6366	5867

Staff.

The operations of the Society are so extensive that an efficient organisation is an absolute necessity. The Charter gives power to the President and Council "both to appoint, and, as they may think fit, to remove, one general Secretary to the Society," whose duties must be defined by Bye-laws or special resolutions, but no other executive officer is mentioned. Under the general clause giving them the sole management of the Society's affairs, the Council have power to appoint such other

officers as they may deem necessary, but those officers cannot contract or discharge in the name and on the behalf of the Society. Practically, the only paid officers of the Society, other than the Secretary and his staff, are its scientific advisers, as will be explained presently, for even the editorship of the 'Journal' has for the last ten years been merged in the secretaryship.

The direction of the Society's affairs must therefore be the work of the Council in reality as well as in name; and for this purpose each department of affairs is placed under the charge of a Standing Committee. These Committees report to the Council at large, and in the event of their recommendations being adopted, it becomes the duty of the Secretary to carry them out, and in cases of difficulty to confer with the Chairman of the Committee having charge of the department affected. This system is common in England, where all classes of society are thoroughly imbued with the principles and practice of "self-government." The most able members of the community give their time and thoughts to the affairs of the country and of its several institutions in the interests of the public at large. Thus a large, an instructed, and an influential governing body, who work for the honour and the pleasure that such labour brings with it, is generally found, as in this case, controlling the affairs of an institution established for the public benefit.

The President of the Society is elected for one year only, and according to the Charter is not eligible for re-election until after an interval of three years. The list of Past-Presidents contains the names of some of the most influential landowners and most prominent agriculturists in the country, including the late Prince Consort, the Prince of Wales, the late and the present Dukes of Richmond, the late Earl Spencer (first President), the late Lord Walsingham, the present Earl Cathcart, Viscount Bridport, and Lord Vernon, the late Mr. Pusey, M.P., Sir H. S. Meysey Thompson, and Mr. E. Holland (the founder of the Royal Agricultural College), and many others whose names are household words in the annals of English Agriculture.

The President of the Society for the current year (1877-78) is Colonel Kingscote, C.B., M.P., of Kingscote, Gloucestershire; and the following is a list of the principal Standing Committees, with the names of their Chairmen:—

COMMITTEES.	CHAIRMEN.
<i>Finance</i> .. ..	Mr. C. Randell, of Chadbury, Worcestershire.
<i>Selection</i> .. ..	Earl Cathcart, of Thornton-le-Street, Yorkshire.
<i>Stock Prizes</i> .. ..	Mr. R. Milward, of Thurgarton, Nottinghamshire.
<i>Implement</i> .. ..	Mr. J. Hemsley, of Shelton, Nottinghamshire.
<i>Country-meeting</i> ..	Lord Skelmersdale, of Lathom Hall, Lancashire (Ex-President).

COMMITTEES.	CHAIRMEN.
<i>Showyard Contracts</i>	} Mr. Jacob Wilson, of Woodhorn Manor, Northumberland.
<i>Chemical</i> .. ..	
<i>Botanical</i> .. ..	Mr. W. Wells, of Holme Wood, Northamptonshire.
<i>Veterinary</i> .. ..	Mr. C. Whitehead, of Maidstone, Kent.
<i>Journal</i> .. ..	} Hon. W. Egerton, M.P., of Rostherne Manor, Cheshire.
<i>Education</i> .. ..	
	Mr. J. D. Dent, of Ribston Hall, Yorkshire.
	Duke of Bedford, of Woburn Abbey, Bedfordshire.

The foregoing brief sketch of the Objects, Constitution, and Management of the Royal Agricultural Society will, I trust, be sufficient to enable readers of the following pages to understand how the Society's operations are carried out under the supervision of the Standing Committees just enumerated. It has already been mentioned that the Society's motto is "Practice with Science," and I shall now endeavour to show how its functions are performed in accordance with that epigrammatic synopsis of its objects. The Finance Committee, of course, have charge of the accounts. The Selection Committee recommend the election of successors to vacancies in the Council and in the various Honorary offices. The Stock Prizes, Implement, Country-meeting, and Showyard Contracts Committees divide amongst them those objects which come under the head of "Practice;" the Chemical, Botanical, and Veterinary Committees include the "Science," while the 'Journal' and 'Education' Committees deal with those subjects which form the connecting link suggested by the central word in the Society's motto, and which I have placed under the heading of "The Propaganda of Agriculture."

## CHAPTER II.

### PRACTICE.

Annual  
Exhibition.

*Annual Exhibition.*—Improvements in Agricultural Practice are stimulated, and successful attempts are rewarded by the Society at or in connection with an Annual Exhibition, which is held under the clause of the Society's Charter which stipulates that in addition to the two General Meetings held annually in London, there shall be held a third "in such other part of England or Wales as shall be deemed most advantageous in time and place for the advancement of the objects of the Society." This meeting is afterwards mentioned as the "Country Meeting," and by that name it is generally known to the Members and referred to in official documents. Before the incorporation of the Society, the principle of a peripatetic Country Meeting had been adopted, and it took the form, which it has since

maintained on an ever-increasing scale, of an annual Exhibition of Live Stock, Agricultural Implements, Farm Produce, and Miscellaneous Articles of domestic utility. For more than thirty years the Country Meetings of the Society were under the honorary direction of Mr. B. T. Brandreth Gibbs, to whose fostering care and unremitting exertion much of the success of the Exhibitions must be ascribed. Mr. Gibbs retired upon his well-won laurels in 1874; and his office was divided between an Honorary Steward of General Arrangements and the paid officers of the Society. The following is a list of the Honorary Officers for the Liverpool Meeting last year:—

STEWARD OF GENERAL ARRANGEMENTS.

Mr. JACOB WILSON, Woodhorn Manor, Morpeth, Northumberland.

Honorary officers.

STEWARDS OF LIVE STOCK.

HOB. W. EGERTON, M.P., Rostherne Manor, Knutsford, Cheshire.  
 Mr. JOSEPH SHUTTLEWORTH, Hartsholme Hall, Lincoln.  
 Mr. WILLIAM WELLS, Holmewood, Peterborough, Northamptonshire.  
 Sir R. C. MUSGRAVE, Bart., Edenhall, Penrith, Cumberland.  
 Mr. WILLIAM H. WAKEFIELD, Sedgwick, Kendal, Westmoreland.

STEWARDS OF IMPLEMENTS.

Mr. J. BOWEN JONES, Ensdon House, Montford Bridge, Shropshire.  
 Mr. JOHN HEMSLEY, Shelton, Newark, Nottinghamshire.  
 Mr. G. H. SANDAY, Wensley House, Bedale, Yorkshire.

STEWARD OF FORAGE.

Mr. THOMAS RIGBY, Darnhall Mill Farm, Winsford, Cheshire.

It would be tedious, and of merely antiquarian interest, to describe in detail the earlier Shows of the Royal Agricultural Society for the purpose of showing the enormous development which has steadily gone on during the thirty-eight years which have elapsed since the first Show was held at Oxford in 1839. It may be mentioned, however, that at Oxford, in that year, there were twenty exhibitors of Implements, and at Cambridge, the following year, there were thirty-two. The report of this meeting stated that "*beyond controversy such a selection of implements was never before collected in one Showyard.*" Contrast these facts with these relating to the second Show of the Society at Oxford in 1870, when 359 exhibitors showed 7851 articles described in the Implement Catalogue. The exhibits of Live Stock, which were about 100 in 1839, attained their maximum of nearly 2000 at Battersea in 1862, and generally range between 1200 and 1500 entries of Horses, Cattle, Sheep, and Pigs. Such an increase in the number of exhibits has entailed an enormous increase in the size of the Showyard and in the expenses of every department of the Exhibition. Thus the area of the Show held at Liverpool in 1841 was 7 acres, and that of last year's Exhibition held at the same town was no less than 70 acres,—an area

Development of Show.



which left little or no superfluous land unoccupied. But if the extent and the cost of the annual Exhibitions have so largely increased of late years, it may safely be added that their popularity and utility have at least advanced in an equal ratio. The following Table, though incomplete for the twelve years preceding the Gloucester Meeting in 1853, will doubtless be found interesting:—

Results from  
1839-1877.

TABLE II.—Showing the RESULTS and EXTENT of the various COUNTRY MEETINGS of the ROYAL AGRICULTURAL SOCIETY since its ESTABLISHMENT.

Year.	Place of Meeting.	Number of Implements exhibited.	Stock exhibited.	Number of Persons admitted.	Receipts in excess of Expenditure.	Expenditure in excess of Receipts.
					£	£
1839	Oxford .. ..	..	..	..	..	1161
1840	Cambridge .. ..	..	..	..	..	939
1841	Liverpool .. ..	312	324	..	..	2166
1842	Bristol .. ..	455	510	..	..	1806
1843	Derby .. ..	508	730	..	..	3164
1844	Southampton ..	948	575	..	..	2142
1845	Shrewsbury .. ..	942	437	..	..	2995
1846	Newcastle .. ..	735	637	..	..	2138
1847	Northampton ..	1321	459	..	..	1636
1848	York .. ..	1508	718	..	..	2826
1849	Norwich .. ..	1882	624	..	..	1958
1850	Exeter .. ..	1223	619	..	..	1629
1851	Windsor .. ..	..	988	..	..	1294
1852	Lewes .. ..	1722	655	..	..	3218
1853	Gloucester .. ..	1803	737	36,245	..	2083
1854	Lincoln .. ..	1897	735	37,635	..	1002
1855	Carlisle .. ..	1314	808	37,533	..	860
1856	Chelmsford .. ..	2702	752	32,982	..	1982
1857	Salisbury .. ..	2496	1027	37,342	..	346
1858	Chester .. ..	3648	1026	62,539	1181	..
1859	Warwick .. ..	4618	1159	55,577	1434	..
1860	Canterbury .. ..	3947	891	42,304	..	2006
1861	Leeds .. ..	5488	1027	145,738	4471	..
1862	Battersea .. ..	5064	1986	124,328	..	3634
1863	Worcester .. ..	5839	1219	75,087	..	1279
1864	Newcastle .. ..	4024	1099	114,683	1342	..
1865	Plymouth .. ..	4023	934	88,036	..	743
1866	No Show.	..	..	..	..	..
1867	Bury St. Edmunds	4804	719	61,837	..	2040
1868	Leicester .. ..	6369	994	97,138	448	..
1869	Manchester .. ..	7724	1315	189,102	9153	..
1870	Oxford .. ..	7851	1377	75,749	..	2504
1871	Wolverhampton* ..	7650	1267	108,213	..	2175
1872	Cardiff .. ..	5843	1293	87,047	..	603
1873	Hull .. ..	5634	1145	104,722	..	413
1874	Bedford .. ..	5931	1527	71,989	..	3717
1875	Taunton .. ..	4214	1096	47,768	..	4576
1876	Birmingham .. ..	6414	1499	163,413	3425	..
1877	Liverpool .. ..	6930	1292	138,354	4283	..

\* Exhibition of Duplicate Implements prohibited after this date.



*Implement Department.*—The subordinate position of this department in the earlier Shows of the Society has been briefly mentioned, and contrasted with its present importance, which demands that two-thirds of the total area of the Showyard should be allotted to it. There is no department of the Society's operations which in past years gave rise to so much discussion as the action of the Council in their endeavour to encourage the invention and manufacture of improved agricultural machinery; and it may be useful to give a brief outline of the history of the subject.

Exhibition of Implements.

At the present day it is almost impossible to realise the primitive condition of this now enormous industry at the time of the earlier meetings of the Royal Agricultural Society, before it had been systematically stimulated by the trials which were made in connection with the annual Country Meetings; but the following extract from the late Sir H. S. Meysey Thompson's paper "On the Royal Agricultural Society and the Progress of Agriculture" will carry more weight than the same facts expressed in any other words:—\*

"The subordinate position occupied by agricultural machinery at the time of these [the two first] Meetings is sufficiently evident; but a striking corroboration of the fact is to be gained in the first Essay read before the Society (March 13th, 1839), by that accomplished writer, the late Mr. Pusey. The title of the paper was 'On the present State of the Science of Agriculture in England,' and no one was more capable than Mr. Pusey of justly estimating the relative importance (according to the ideas of the day) of the numerous subjects discussed in that valuable and exhaustive article.† It is curious to find that the only implements there alluded to were the plough and the harrow, the turnip-slicer and the threshing-machine, with the exception of the following paragraph on the drill, which sounds so strange in the ears of a farmer of the present day that it seems barely credible that it should have been penned by one so thoroughly conversant with his subject at so late a date as 1839. 'The use of another instrument, the drill-machine, a more complicated one, by which the seed is laid in regular rows, has lately become frequent in Southern as well as in Northern England; though it has established itself so slowly, that for a long time travelling machines of this kind have made yearly journeys from Suffolk as far as Oxfordshire, for the use of those distant farmers by whom their services are required.' Volumes of proof of the complete revolution which has taken place in farming implements since 1839 would not be more convincing than the simple announcement that Mr. Pusey, in his inaugural address to the Members of the Royal Agricultural Society, thought it necessary to inform them that the drill was a machine by which the seed was laid in regular rows; or than the surprising fact which he records, that Suffolk drills have actually perambulated the half of England since the accession, not of good Queen Bess, but of her gracious Majesty, Queen Victoria!"

Subordinate position in 1839.

At the first meeting of the Society, in 1839, prizes for agricultural implements in the form of money and medals were

Competition for Prizes.

\* 'Journal of the Royal Agricultural Society of England,' vol. xxv., pp. 9, 10.

† Ibid. vol. i., p. 1.

offered for competition, and the plan has been pursued ever since under various regulations. For some years, with few exceptions, no particular classes of implements were indicated as those which were specially designed for trial. As the stamp of the Society's approval, by the award of a prize or a medal, became appreciated by the public, and therefore more desired by the manufacturers, more new implements were exhibited year after year, and a continually increasing number had to be tried in the comparatively short time available for the purpose, in the week preceding the Show. The effect of the system pursued was, however, very marked; and, after an experience of ten years, was thus described in the Reports of the Stewards of Implements for 1848 and 1849:—

Its advantages. "The principal advantages to be derived from Shows of Implements may be classed under three heads, of which the first and most important is, that the awards of prizes should point out to every farmer who enters the Showyard the best implements in their respective classes which the kingdom produces. Farmers, as a body, have neither the means nor the leisure required for travelling about to visit the manufactories of the various implement-makers; nor, if this were practicable, could they safely decide on the comparative efficiency of their respective productions by merely seeing them in the makers' yards. It is, therefore, a great advantage to the farmers of any district to have a large show of implements brought into their neighbourhood, especially when the best of each class are pointed out to them by competent judges after a fair trial.\*

"The attention of some of the leading members of the Society (especially of the late lamented Mr. Handley) was earnestly directed to the improvement of this department, and they soon perceived that little was gained by collecting implements in a Showyard for people to gaze at, unless an adequate trial could be made of their respective merits. To attain this end great exertions were made, and every improvement in the mode of trial was followed by so marked an increase in the number and merit of implements brought forward at subsequent Shows, as to prove the strongest incentive to further effort. . . . The additional amount offered in prizes at the later meetings has undoubtedly assisted in creating this great increase of competition, but it cannot be considered the principal cause, since the implement-makers are unanimous in declaring that, even when successful, the prizes they receive do not reimburse them for their expenses and loss of time. How, then, are the increased exertions of the machine-makers to be accounted for? Simply by the fact that the trials of implements have gradually won the confidence of the farmer, so that, when selecting implements for purchase, he gives the preference to those which have received the Society's mark of approval. . . .

"It thus appears that, concurrently with the extension and improvement of the trials, a corresponding increase and improvement has taken place in the exhibitions of implements; and though it is difficult to *prove* that the one has been the cause of the other, still the probability that such is the case almost amounts to certainty, when it is found that classes of implements which are so faulty in construction as to be strongly animadverted on by the Judges at one Meeting, are at the next nearly free from those defects which had been previously pointed out. . . . If the foregoing reasoning be correct (and the facts on which it is founded will not admit of question), the Society may fairly

---

\* 'Journal of the Royal Agricultural Society of England,' vol. ix., p. 378.

claim to have been, in great measure, the authors of the very rapid improvement made of late in almost every kind of agricultural implement."\*

It will thus be seen that an experience of ten years was sufficient to demonstrate the utility of the Trials of Implements. The anxiety of manufacturers to obtain the Society's medals and prizes kept pace with the increasing importance which was attached to them by the agricultural community. It therefore became necessary to spread over a series of years the labour and cost of submitting to trial the ever increasing variety of farm implements. Accordingly a triennial scheme was arranged in 1855, as the result of an interview between the Council of the Society and a deputation of the Agricultural Implement manufacturers. This first division was as follows:—

Classification  
of implements  
for trial.

1. Implements for tillage and drainage.
2. Machines for the cultivation and harvesting of crops.
3. Machines for preparing crops for market and food for cattle.

This scheme was expanded to a quadrennial one in 1859, but again reduced to a triennial in 1864, and afterwards enlarged to a quinquennial in 1869. This last classification, in spite of its extension, was found too condensed for practical use, and was further expanded on account of the time required to try, thoroughly and scientifically, the increasing number of implements in each class. The following statement of the amended classification, arranged in its natural order and not as actually tried, will give the best idea of the trial-system in its final development:—

1. Horse-power machines and implements used in tillage.
2. Steam-power machinery used in tillage.
3. Machines and implements used in the cultivation and carrying of crops.
4. Machines and implements used in the harvesting of grass crops.
5. Machines and implements used in the harvesting of grain and root crops.
6. Machines and implements used in the preparation of crops for market.
7. Machines and implements used in the preparation of food and in the feeding of stock.

At the present time a rotation or classification of implements for trial in successive years is not included in the Society's programme. For some years the cost of the trials of agricultural implements to the Society alone has exceeded an average of

Existing  
system.

\* 'Journal of the Royal Agricultural Society of England,' vol. x., p. 528.

2000*l.* per annum, while the cost to the numerous competitors must have been enormous. In itself, the cost of a public benefit is regarded by the Society as of secondary importance; but it is essential that, as trustees for the public, the Council see that the benefit obtained is commensurate with the outlay which it has entailed. Of late years, it has become increasingly evident that the quality of certain classes of agricultural implements had become so uniform that no public advantage could be derived by submitting them to further competitive trials, until, at least, the expiration of several years; therefore in 1875 it was decided that the trials should, for the present, be confined to the following classes of Implements:—Machinery for cultivating the land by Steam-power, Double Ploughs, Root-thinners, Manure-distributors, Mowing Machines, Horse-rakes, Haymakers, Reaping Machines, Sheaf-binders, Stacking Machines, Thatch-making Machines, Agricultural Locomotives and Waggons suitable to be drawn by them. This list is not classified, but, according to circumstances, the Council selects certain classes of the implements contained in it for special encouragement in each year, and this has recently been done three years consecutively in the case of sheaf-binders. The agricultural wants of the locality in which the Exhibition is to be held also receive attention;\*

\* For instance, at Bristol, which is in the centre of a large dairy district, the following prizes are this year (1878) offered for dairy appliances:—

## PRIZES.

## CLASS

- |  |    |
|--|----|
| 1. For the best Milk-can, suitable for conveying milk long distances by road or rail without injury .. .. .  | 10 |
| 2. For the best Churn for churning a sufficient quantity of milk to produce not more than 20 lbs. of butter .. .. .  | 10 |
| 3. For the best Churn for churning a sufficient quantity of cream to produce not more than 20 lbs. of butter .. .. .   | 10 |
| 4. For the best mechanical or automatic Butter-worker, suitable for large dairies and for factories .. .. .  | 10 |
| 5. For the best mechanical or automatic Butter-worker, suitable for small dairies; price to be specially considered .. .. .  | 10 |
| 6. For the best Cheese-tub; economy of labour to be specially considered   | 10 |
| 7. For the best Curd-knife .. .. .   | 5  |
| 8. For the best Curd-mill .. .. .  | 5  |
| 9. For the best Cheese-turning apparatus .. .. .   | 10 |
| 10. For the best mechanical means of cleansing churms and other dairy utensils .. .. .   | 10 |
| 11. For the best automatic means of preventing the rising of cream ..  | 10 |
| 12. For the best Milk-cooler .. .. .   | 10 |
| 13. For the best method of keeping a large quantity of milk at a temperature under 40° Fahr., for a period of not less than twelve hours, sufficiently economical for practical purposes .. .. . | 20 |
| 14. For the best Milking-machine, to be tested during six consecutive months of the spring and summer of 1879 .. .. .  | 50 |

and any new implement or important improvement exhibited at any Show may be put to trial and receive an appropriate award if found worthy of the approval of the Society's Judges.\*

The detailed results of the Society's efforts to encourage the improvement of agricultural machinery would require a volume for their description, and cannot be even glanced at in this brief Memoir. It may, however, be claimed for the Society that, without pursuing any chimerical views of over-sanguine inventors, it has appreciated and steadily fostered the germ of any real improvement in the mechanical appliances of the farm. The encouragement of steam-cultivation may be cited as an illustration of the manner in which such questions have been dealt with by the Society. At the Lincoln Meeting in 1854 Mr. Fowler received a Silver Medal for a "Steam Draining Apparatus," and at the close of their report on its work when under trial, the Judges remarked, "Surely this power can be applied to more general purposes. We earnestly commend this idea to our engineers and mechanists." In the following year the Society, acting upon this hint, offered a prize of 200*l.*, without effect; but in 1856 two competitors appeared at the Chelmsford Meeting to contest the prize, then increased to 500*l.*, "for the Steam-cultivator that shall in the most efficient manner turn over the soil,† and be an economical substitute for the plough or the spade." Neither of the competitors fulfilled the conditions included in the terms of the prize; the offer of which was renewed the next year at the Salisbury Meeting, and again the year after at Chester. At the latter meeting the prize of 500*l.* was awarded to Mr. Fowler, and a Gold Medal to Messrs. J. and F. Howard. At Warwick in 1859, Worcester in 1863, Leicester in 1868, and lastly at Wolverhampton in 1871, the relative merits of different systems of steam-cultivating machinery were put to the test, and on each successive occasion in a more exhaustive manner. In 1866 the Society appointed three Committees

Steam-cultivation.

Its origin in 1854.

---

\* There are ten Silver Medals, the award of which the Judges appointed by the Council have the power of recommending in cases of sufficient merit in New Implements.

† Mr. Smith, of Woolston, has always argued against this condition of the Society's prize for a steam-cultivator, and has maintained that for effective cultivation by steam it was not necessary that the soil should be inverted. In this respect he was very much in advance of his time, and at present a great number of practical agriculturists are of opinion that the best use of steam power, especially as a preparation for the root-crop, is to thoroughly break up and pulverise the subsoil without bringing it to the surface. At the same time, it must be observed that much less power is required to break up the soil than to turn it over with a plough, and that Mr. Smith's steam-tackle, which competed at Chelmsford, was not designed to comply with the condition which was embodied in the Society's offer of their Prize, and by which their Judges were bound.



of Inspection to inquire into and report upon the results of steam-cultivation in the various counties of England and Wales up to that date, with special reference to different classes of soils, and to different descriptions of ownership of this kind of farming machinery, including partnership arrangements and systems of hire. One of the three reporters (Mr. J. A. Clarke) thus tersely sums up the work of these Committees and the objects with which it was undertaken:—

“The experience of some 140 practical farmers upon an area of 66,000 acres arable,—consisting of holdings of all sizes, from less than 200 up to 2500 acres, and averaging 536 acres each; embracing a great diversity of soils, and situated in the most varying climates, from the draughty east to the rainy west, from the chilly north to the sunny south; an experience derived from four up to ten years’ employment of all the different forms of apparatus now in use, under every system of working, and with every style of management; an experience also, for the most part, investigated upon the spot by ten business men, whose names and reputation are staked upon the truthfulness and impartiality of their Reports,—ought to establish the success or demonstrate the failure of steam-tillage in this kingdom. And the Society’s munificent outlay upon the Inquiry will be sanctioned by results, if only a small percentage of its members and of the proprietors and tenants of land still under horse culture shall be led by the mass of evidence concentrated in the three Reports to treat their fields as well as their produce by the power of the steam-engine.”

These reports will always rank with the classics of agricultural literature; and the evidence which they contain in favour of the application of steam power to the cultivation of the soil has since been strengthened by the more recent improvements in steam-cultivating machinery, the rise in the wages of the agricultural labourer, and the increased price of horses. Since these reports were written the Society has twice submitted steam-cultivating machinery to trial; and on the last occasion, at the time of the Wolverhampton Meeting, the investigations were more searching than at any other trial of any class of agricultural machinery. Again, from time to time, medals have been awarded for essential improvements in engines, anchors, and other separate parts of a steam-cultivating apparatus, while the ‘Journal’ of the Society has contained reports upon special matters connected with steam-cultivation, such as the influence of a very wet autumn, and the management of companies formed to extend the hiring system.

I have given this brief sketch of the Society’s efforts to stimulate the application of steam to the cultivation of the soil as an example of the manner in which its influence has been used to promote the improvement of agricultural machinery. Its trials are open to the public, and those who prefer to rely upon their own judgment have every opportunity of forming it for themselves; while for the benefit of others, the work of adjudication is intrusted to practical farmers, assisted by emi-

Its position  
in 1866.



ment engineers, who have at their command the most refined means of testing every qualification which may be deemed an essential element in the competition; and every important detail in the construction of the competing implements, and in the nature of the work performed by them, is described in the reports published in the Society's 'Journal,' which are drawn up by qualified men, specially appointed for the purpose.

It will have been seen that the Society's efforts to improve agricultural machinery were in the first instance successful beyond the calculation of the most sanguine of its supporters. Thirty or forty years ago it was a difficult and expensive matter to travel long distances, and therefore such journeys were rarely undertaken for the purpose of investigating the merits of a farm-*Resumé.* implement. The Society's Country Meetings soon became recognised as a centre where the best implements could be examined, and their efficiency at work could be proved; and thus it is easy to account for the rapid and extensive diffusion of improved machinery in those early days through their agency. With the extension of the railway system and the coincident multiplication of country and district Agricultural Shows, the Country Meetings of the Royal Agricultural Society lost something of their general interest, while they acquired a new and special importance owing to the classification of implements for trial, and the uniform offer of medals and other rewards for new inventions. The trials made by the Society's officers have always been more exhaustive than those made elsewhere, and of recent years have acquired the character of elaborate scientific investigations. One result has been that the quality and efficiency of the standard implements of the farm have approached more and more to a uniform level, which has thus, for a time, rendered the Society's further tests of them practically unnecessary. There remains, however, for the future a very large field in the encouragement of the invention of labour-saving machinery generally, and particularly in the development of a system of steam-cultivation which shall be within the purchase-power of an occupier of 200 or 300 acres.

*Live Stock.*—The improvements which have been made in Exhibitions of Live Stock. the breeds of live stock since 1839 have been frequently described as the extension of excellence to a larger number of animals, rather than the further improvement of a few choice individuals. This is doubtless a fair statement of the case with reference to Shorthorns, and possibly one or two other standard breeds of cattle, and also with regard to Leicester and South-down sheep and horses, both agricultural and thoroughbred. Prizes were won in 1839 with animals which would probably win prizes if they could be shown in the same condition at the

Paris Exhibition in 1878. But, on the other hand, it may be confidently asserted that the prizes offered by the Royal Agricultural Society during the last fifteen years for some of the less widely known breeds of animals of the farm, coupled with the regulations attached to the competitions, have given fixity of type and increased excellence to Sussex, Jersey, and other breeds of cattle; as well as to Hampshire Downs, Oxfordshire Downs, Shropshire, and other breeds of sheep. Further than this, the historians of our several breeds of farm-animals concur in maintaining that the average representatives of all breeds now possess that quality which is known as "early maturity" to a greater extent than their progenitors. Premising that the efforts of the Society are confined almost entirely to the improvement of breeding animals, and that the Judges are prohibited from taking into account the value of the animals to the butcher, it seems not unreasonable to ascribe much of this early maturity to the application of experience gained in the endeavour to "make up" animals for show purposes.\* On the other hand, these efforts not unfrequently have a prejudicial effect upon the breeding qualities of the animals, and therefore some breeders no longer run the risk of permanently injuring their most valuable animals by preparing them for show. This consideration, however, does not affect the value of steers or wethers forced for the butcher, and although the overfeeding of breeding stock is an admitted evil, and frequently a serious loss to those who practise it, some compensation may have been obtained by the knowledge of the principles of the fattening process thus gained, and by their application to ordinary farm practice.

For many years the prizes for live stock offered by the Royal Agricultural Society were confined to the breeds of Shorthorn, Herford, and Devon cattle; Leicester and Southdown sheep; Pigs, without distinction as to size or colour, and two or three classes of Horses, together with an open class for "other breeds of cattle," and another for "other breeds of sheep." The practice of encouraging the exhibition of local breeds commenced, however, as early as 1844, when the Society's Show was held at Southampton, and special prizes were offered for Channel Island cattle. The plan was followed at Shrewsbury, in 1845, and Newcastle, in 1846, by the offer of prizes for "Sheep best adapted to a Mountain district;" and at the latter meeting the classes

---

\* It should be mentioned that the Shows of the Smithfield Club, which are held annually, about a fortnight before Christmas, have of late had a direct bearing upon the attainment of the quality of "early maturity" in the standard breeds of sheep and cattle. With this view, classes for young steers and for fat lambs have been introduced, a limit has been placed upon the ages of old steers eligible for competition, and the classes for old sheep have been abolished altogether.

Confined to  
breeding  
stock.

Increase in,  
the number  
of breeds.

of Pigs were for the first time divided into two sections, designated "Large" and "Small" breeds. At Lewes, in 1852, Kentish sheep; at Gloucester, in 1853, Shropshire sheep; at Lincoln, in 1854, Lincoln sheep; and at Carlisle, in 1855, Cheviot and Herdwick sheep were similarly recognised by the Society as local breeds deserving of encouragement. In 1853, also, the open class for sheep was divided into two, one for "Long-woolled sheep not qualified to compete as Leicesters," and the other for "Short-woolled sheep not qualified to compete as Southdowns."

It is not necessary to follow in detail the prize-sheets of each successive year, but it will probably surprise many to learn that it was not until the Warwick Meeting in 1859 that Shropshire sheep were deemed of sufficient national importance to entitle them to rank as a separate breed in the Society's Showyard; and it may not be out of place to mention that, although twenty years have since then nearly elapsed, the true characteristics of a Shropshire sheep have been a "bone of contention" until the last two or three years. This matter would not require notice in a sketch of the Royal Agricultural Society if it did not forcibly illustrate the results of the Annual Exhibitions as an educational institution, in addition to their influence as a stimulant to breeders of pure stock. Some years ago the Shropshire breeders petitioned the Council of the Society to appoint certain well-known connoisseurs of the breed as Judges for a term of years, for the avowed purpose of fixing, by means of their awards, the true type and character of a Shropshire sheep. The Council, in reality, gave effect to the desire of the memorialists; and thus the animals decorated by the Society's Judges became annually very special objects of study to those interested in the breed. Each one saw for himself what to acquire as well as what to avoid, and with the knowledge of his own flock could estimate in what direction his efforts should be turned. In this indirect manner the Society's Shows have enormously increased the number of good animals of all descriptions throughout the country, while the experience of every winner of Show-honours testifies to the direct value of a Royal Prize and even of a Comendation.

The Battersea Show of 1862 was the turning-point in the history and the policy of the Society's Exhibitions of Live Stock. Held in the year of the International Exhibition, when the means of locomotion in and about London were already overtaxed, and in a suburb of the metropolis which was almost inaccessible to the multitude, it was not visited by so large a number of people as might have been expected, and the Society consequently suffered a large pecuniary loss. But the benefit

Shropshire  
sheep.

Present policy  
commenced at  
the Battersea  
Meeting in  
1862.

which has been conferred on the breeders of those kinds of sheep and cattle which had not before been recognised by the Society, in consequence of the continuation of the policy then commenced, must many times exceed in value the drain which the Exhibition entailed upon the Society's funds. At that Meeting the Stock Prize-sheet was expanded to include classes for the following recognised English and Scotch breeds of Horses, Cattle, and Sheep, in addition to others for certain foreign races of cattle:—

#### HORSES.

Thoroughbred—Hunters—Carriage—Roadsters—Suffolk Agricultural—Agricultural (not qualified to compete as Suffolks)—Clydesdale—Dray—Ponies.

#### CATTLE.

Shorthorns—Herefords—Devons—Sussex—Longhorned—Norfolk and Suffolk Polled—Welsh—Irish—Channel Islands (Jerseys and Guernseys)—Polled Aberdeen and Angus—Polled Galloway—Highland—Ayrshire.

#### SHEEP.

Leicester—Lincoln—Cotswold—Kentish, or Romney Marsh—Long-woolled—Irish pure native Long-woolled—Southdowns—Shropshire—Hampshire and West Country Down—Oxfordshire Downs—Dorset—Mountain—Blackfaced—Cheviot.

The majority of the newly recognised English breeds contained in the foregoing list have since retained their place in the Annual Prize-sheet of the Society, especially the Channel Island and Sussex cattle, and the Cotswold, Lincoln, Oxfordshire Down and Hampshire Down sheep; while the Norfolk and Suffolk, the Longhorn and the Scotch breeds of cattle, the Kentish, the Dorset, and the different Moor and Mountain breeds of sheep receive due recognition whenever the Society's Meeting is held within a reasonable distance of the limited districts in which they severally prevail.

Horses.

In its efforts to encourage the breeds of horses the action of the Society has been similar to that which has just been sketched in reference to cattle and sheep. Commencing at Oxford and continuing at Cambridge with but three classes, namely cart stallions, cart mares, and thoroughbred stallions, the two former were at the first Liverpool Show subdivided into two-year-olds and older horses; and this classification appears to have satisfied the requirements of the times until 1855, with the exception that, during the most of that interval, the class for thoroughbred stallions was supplanted by one for "roadster" sires. At Carlisle, in 1855, the Clydesdale was recognised as a distinct breed, and in 1857, the thoroughbred came once more to the front,

a distinction being at the same time drawn between the sires and dams suitable for breeding Hunters and Hackneys respectively. At Battersea, as already stated, there was a great advance, including the recognition of the Suffolk as a distinct breed of horse, and ever since that Show a similar prize-sheet has been issued, varying chiefly in details rendered desirable by the geographical position or other circumstances of the locality in which the Show was to be held.

*Farm Prizes.*—The efforts of the Society to improve the agriculture of the district in which the Country Meeting is held in any year, were extended, in 1870, by the offer of prizes for the best managed farms in the district or county. Public attention is by this means drawn to those farms which may be entered for competition. Farmers living in their neighbourhood follow the course of cultivation on them through the year of trial with great interest, and discuss with one another the respective chances of the competitors. Those who have not the advantage of neighbourhood content themselves with a personal visit to the winning farms at the time of the Show, or with reading the generally exhaustive reports of the Judges, which are published in the Society's 'Journal.'

The definition of the class or classes of farms which are entitled to compete varies from year to year in accordance with the variations in the methods and styles of farming which are characteristic of the several counties of England. In 1870, the first year of these competitions, the farms entered were required to be not less than 200 acres in extent, as the Country Meeting was held at Oxford, in the midst of a district of large arable farms. The prizes consisted of a handsome silver cup, value 100*l.*, given by Mr. Mason, the High Sheriff of Oxfordshire (who may really claim to be the originator of the competition for farm prizes in connection with this Society), and prizes of 50*l.* and 25*l.*, given by the Society, by whom also the expenses of judging are always borne. Next year the Country Meeting was held at Wolverhampton, and the prizes were offered in two classes, one for arable and the other for dairy farms; the prizes in each were—1st, 100*l.*; 2nd, 50*l.*; with two special prizes of 25*l.* each. It is not necessary to give these details for each succeeding year; but before passing on to the current year (1877) it will be sufficient to mention that in 1870 there were 21 competitors, and in 1871 there were 23 in the arable and 4 in the dairy class.

In connection with the Liverpool Meeting a more minute subdivision of the farms into classes was made by the Local Committee, who offered the prizes; and the following is the list, with the number of entries in each class:—



## SECTION I.—FARMS in Lancashire, Cheshire, Denbighshire, Flintshire.

## A.—ARABLE FARMS with at least two-thirds of their area under rotation of cropping :—

	No. of Entries.
CLASS 1. FARMS of one hundred and fifty acres and upwards in extent, 50 <i>l.</i> .. .. .	10
CLASS 2.—FARMS above eighty acres in extent, and under one hundred and fifty acres, First Prize, 40 <i>l.</i> ; second, 20 <i>l.</i> .. .. .	4
CLASS 3.—FARMS above forty acres in extent, and under eighty acres, 20 <i>l.</i> .. .. .	4

## B.—DAIRY or STOCK FARMS where the course of cultivation is chiefly directed to the production of cheese or butter, or of animal food :—

CLASS 4.—FARMS of not less than two hundred acres in extent, 50 <i>l.</i> .. .. .	8
CLASS 5.—FARMS of not less than one hundred acres and under two hundred acres, First Prize, 40 <i>l.</i> ; second, 20 <i>l.</i> .. .. .	13
CLASS 6.—FARMS of not less than fifty, but under one hundred acres, 20 <i>l.</i> .. .. .	4

## SECTION II.—FARMS in the Isle of Man.

CLASS 7.—FARMS of seventy acres or upwards in extent, 25 <i>l.</i> .. .. .	2
CLASS 8.—FARMS under seventy acres in extent, but not less than twenty-five acres, 15 <i>l.</i> .. .. .	1

---

Total .. 46

Competition  
not always  
keen.

It must not be inferred, however, that the Farm-prizes offered have always been so keenly competed for, or that the offers of the Society and its Local Committees may not again be received with indifference in some districts. For instance, the Council offered two prizes of 100*l.* each, in connection with the Hull Meeting in 1873, for the best-managed farms above 200 acres in extent in the Holderness and Wold districts respectively. Only four Holderness farms were entered, and in the Wold class there was no competition, although the areas defined were of considerable extent, and are both characterised by large and highly cultivated farms. The cause of this supineness was openly stated at the time to be that the prize-winners would probably have their rents raised in consequence of their success; and this apparently extraordinary reasoning was supported by reference to a prize-winner at a local competition whose rent was afterwards raised, and therefore the relation of cause and effect was ascribed to the two events.

*Post hoc* is often very different from *propter hoc*; but if such a feeling as that I have just mentioned were to become general, the system of Farm-prizes would certainly die of strangulation. Fortunately, however, I have never heard it suggested that a



Royal Farm-prize has been a cause of pecuniary loss to any of the winners. On the contrary, many landlords have supplemented, not only the prizes, but even the commendations of the Society's Judges, by silver cups or other marks of their satisfaction; and in nearly all cases a share of the credit obtained by the tenant is necessarily reflected upon his landlord. The landlord, or his agent, also knows that a bad farmer is a very expensive appanage to an estate; and the practice of estimating the value of a tenant by the success of his farming is becoming more and more general. If a farmer can produce good average or over average crops, with clean land, his landlord is satisfied; but if, on the other hand, the land is badly farmed, it becomes foul, yields poor crops, and the landlord will lose almost as much as the tenant, if the landlord does not soon change his tenant, or the tenant change his farming.

It has been found necessary to attach certain conditions to the offer of these prizes, with a view to exclude so-called "Model Farms," which are held as an amusement at a great expense by wealthy men. The object of the prizes is to encourage good and profitable farming as a business, and the competitions are therefore limited to tenant-farmers paying a *bonâ fide* rent for at least three-fourths of the land which they cultivate. All the land in their occupation must be entered for competition, although some of it may not be in the area defined for the purpose. This is a necessary stipulation, to enable the Judges to come to a correct conclusion as to the quantity of stock maintained on a given acreage, that being one criterion of the quality of the farming.

Conditions of competition.

The Judges are instructed especially to consider:—

Instructions to Judges.

- (1.) General Management with a view to Profit.
- (2.) Productiveness of Crops.
- (3.) Goodness and Suitability of Live Stock.
- (4.) Management of Grass Land.
- (5.) State of Gates, Fences, Roads, and General Neatness.
- (6.) Book-keeping.

In the case of Dairy Farms there is an additional instruction on the "Management of the Dairy and Dairy Produce."

Three Judges, one of whom acts as Reporter, are appointed by the Council of the Society, and the awards made are founded on the results of their inspections, usually three in number:— One in winter (preferably before Christmas), when the winter-management of stock is the chief subject of investigation; one in spring (generally in May), when the state of the land, both as regards cultivation and cleanliness, the appearance of the growing corn, the preparations for turnip-sowing, and the management

of the flock, can be thoroughly examined; and the last in July, immediately before the Show, when the prospects of the harvest can be tolerably well estimated.

Reports of  
Judges.

The reports of the Judges, which are published in the 'Journal,' and the unofficial descriptions published in the agricultural newspapers, are read with keen interest, especially by the competitors and their neighbours. It is to be hoped that a material effect is thus being produced, analogous to that already described as the result of the encouragement given during so many years to breeders of different classes of stock, namely, an increase in the number of really good farmers, for it is probable that the few who are now the best could not farm any better with profit to themselves. The time during which the system of Farm Prizes has been in operation is still too short, however, to permit of any inference on this question being yet drawn.

General  
results.

Still, it may be asked whether the eight competitions which have already taken place have not pointed to any general conclusions which may be safely accepted as guides to good farming. Opinions will doubtless differ as to the legitimate inferences to be drawn from the awards and reports of the Judges; but, to my mind, there is one salient feature characteristic of all the competitions, and that is the value of green crops in the rotation. In each case the prizes have fallen to farmers who pursue the old-fashioned four or five-course shifts, to the defeat of those who take successive corn-crops with the aid of stimulating artificial manures. Even at the Liverpool competition, of which the Judges reported very highly, stating that the competitors possessed complete freedom of action, grew what they liked, and sold what they chose, this freedom was used to grow more grass, green crops, and early potatoes, and not successive crops of grain. It does not follow, however, that this will always be the case, as our knowledge of the practical and systematic use of artificial manures for double-cropping is as yet confined to the experience of a comparatively small number of farmers. The increasing value of straw, as a crop to be sold off the farm, is also rapidly enhancing the importance of corn-crops, especially in the neighbourhood of large towns. Moreover, much weight must be allowed to the climate, not only of the locality, but of the year; and a dry year in a dry district will necessarily furnish one extreme combination, and tell a different tale from that which would be observed in a wet district in a rainy season.

CHAPTER III.

SCIENCE.

*Chemistry.*—The Chemical department of the Society has for many years been one of the most important, especially since the Council resolved to publish the names of those persons who supplied to its members artificial manures and feeding-stuffs which on analysis proved to be inferior or adulterated. The Chemical Committee has the immediate supervision of this department; and the post of executive officer, officially known as the “Consulting Chemist,” has for many years been held by Dr. Voelcker, in whose skill and knowledge the Society and the public repose complete confidence. The duties of the Consulting Chemist are (1) to make analyses at a stipulated charge for those Members of the Society who are not engaged in the manufacture or sale of the substances sent to be analysed; (2) to report to the Chemical Committee any cases of inferior or adulterated substances thus sent for analysis; (3) to conduct or superintend experiments in the field and researches in the laboratory; (4) to write such reports and memoirs as may from time to time be deemed desirable for publication in the Society’s ‘Journal’ or otherwise.

The following Table will show the reduced scale of fees charged for analyses made for the Members, and the extent to which the privilege was used last year; and it may be added that the average number of analyses made in a year is, in round numbers, about 700 :—

No.		No. of Analyses.
1.	An opinion of the genuineness of Peruvian Guano, bone-dust or oil-cake .. .. . (each sample)	5s.
2.	An analysis of guano; showing the proportion of moisture, organic matter, sand, phosphate of lime, alkaline salts and ammonia .. .. .	10s.
3.	An estimate of the value (relatively to the average samples in the market) of sulphate and muriate of ammonia and of the nitrates of potash and soda .. .. .	10s.
4.	An analysis of superphosphate of lime for soluble phosphates only .. .. .	10s.
5.	An analysis of superphosphate of lime, showing the proportions of moisture, organic matter, sand, soluble and insoluble phosphates, sulphate of lime and ammonia .. .. .	£1
6.	An analysis (sufficient for the determination of its agricultural value) of an ordinary artificial manure .. .. .	£1
7.	Limestone: the proportion of lime, 7s. 6d.; the proportion of magnesia, 10s.; the proportion of lime and magnesia	15s.
8.	Limestone or marls, including carbonate, phosphate and sulphate of lime and magnesia with sand and clay .. .. .	£1

Chemistry.

Members’ Privileges of Analysis.

No.		No. of Analyses.
9.	Partial analysis of a soil, including determinations of clay, sand, organic matter, and carbonate of lime .. .. .	£1} 21
10.	Complete analysis of a soil .. .. .	£3}
11.	An analysis of oil-cake or other substance used for feeding purposes, showing the proportion of moisture, oil, mineral matter, albuminous matter, and woody fibre, as well as of starch, gum, and sugar in the aggregate .. .. .	£1 206
12.	Analysis of any vegetable product .. .. .	£1 21
13.	Analysis of animal products, refuse substances used for manure, &c. .. .. . from 10s. to 30s.	7
14.	Determination of the "hardness" of a sample of water before and after boiling .. .. .	10s.
15.	Analysis of water of land drainage, and of water used for irrigation .. .. .	£2}
16.	Determination of nitric acid in a sample of water .. .. .	£1} 63

Reports on sales of inferior and adulterated manures and feeding-stuffs.

In the year 1870, at the suggestion of the Earl of Lichfield, the Council passed the following resolution:—"The Consulting Chemist is required to submit, in March, June, and December, a Report on the various samples of manures and feeding-stuffs forwarded to him by Members of the Society; and such Report, together with the names of the dealers who supplied the substances analysed, shall, if the Council think fit, be published in the *Agricultural Journals*." Thus was imposed the second of Dr. Voelcker's quartette of duties. Considering the nature of the English law of libel, and the absence from our system of any officer having such functions as the public prosecutor of foreign countries, it is obvious that the Council assumed a very grave responsibility when they passed this resolution. The *Agricultural Journals* soon asked for an indemnity against any consequences which might follow from their complying with the request to publish the Society's Reports; and the requisite assurance was given to a certain number, on condition that the reports were published *verbatim et literatim* as issued by the Secretary. More than once the Council have been under the necessity of redeeming its pledge, and has paid the costs of expensive actions at law; but the Members of the Society and the *Agricultural Associations* throughout the country have un-animously and heartily approved of the course pursued by the Council, notwithstanding its cost. And if the publication of these Reports has been thus appreciated by purchasers, it can scarcely be doubted that its effect upon a certain class of manufacturers and dealers has made them beneficial to the farmer by restricting, at least for a time, the growing practice of selling inferior, "mixed," and adulterated manures and feeding-stuffs under misleading names.

Advice to members.

In addition to these Reports, the Council have on several occasions issued advice to its Members, drawing their atten-



tion to the precautions which they should take and the guarantees of quality which they should obtain when they purchase various kinds of artificial manures and feeding-stuffs. Thousands of these circulars have also been issued by other Societies; but still the Consulting Chemist finds ample material for his Quarterly Reports, although for a time the actions at law just referred to cleared the air of much floating mischief, and temporarily denuded those Reports of their most striking character.

To defray the cost of the third and fourth heads of the Consulting Chemist's duties, the Council make an annual grant of 200*l.*; and every volume of the 'Journal' contains one or two records of the results of those investigations made either in the field or in the laboratory. Last year, as has been already described, the efforts of the Society in this direction received a great impetus from the passing of the Agricultural Holdings Act, and were much facilitated by the liberality and public spirit of the Duke of Bedford, to whom the Society is entirely indebted for the Experimental Station at Woburn.

Experiments  
and investi-  
gations.

It will thus be seen that the Chemical Committee have the charge of a most important section of the Society's functions, and that their activity is commensurate with their mission. But however great may be the work which they have done in the past, there can be no doubt that they have a still larger field for their operations in the future. The increasing use of artificial manures and feeding-stuffs for the mutual benefit of landlord and tenant will lead to a considerable extension of the use which has hitherto been made of the facilities for analysis which are afforded to the members of the Society; while the establishment of the Experimental Farm at Woburn seems to open out the prospect that the questions upon which practical and scientific men are not yet agreed, will be submitted to careful and crucial tests under the supervision of a joint committee combining "practice with science."

*Natural History.*—A separate department to take cognisance of the application of these sciences to agriculture was not formed until the year 1871, when Mr. Carruthers, F.R.S., the Keeper of the Botanical department of the British Museum, was appointed "Consulting Botanist" to the Society. More recently the same gentleman has undertaken to supply the Members with advice on Zoological matters. Thus the Members of the Society can now, at the cost of a few shillings, have their seeds tested and obtain advice on any animal or vegetable pest that may damage their crops. The following is a list of the Natural History Privileges of Members of the Society:—

Natural  
History.

Members' Botanical and Zoological Privileges.

No.	I. BOTANICAL.	s.
1.	A report on the purity, amount and nature of foreign materials, perfectness and germinating power of a sample of seeds .. ..	5
2.	Detailed report on the weight, purity, perfectness, and germinating power of a sample of seeds, with a special description of the weeds and other foreign materials contained in it .. ..	10
3.	Determination of the species of any weed or other plant, or of any epiphyte or vegetable parasite, with a report on its habits, and the means of its extermination or prevention .. ..	5
4.	Report on any disease affecting the farm crop .. ..	5
5.	Determination of the species of a collection of natural grasses found in any district on one kind of soil, with a report on their habits and pasture value .. ..	10

## II. ZOOLOGICAL.

6.	Determination of the species of any insect, worm, or other animal which, in any stage of its life, injuriously affects the farm crops, with a report on its habits and suggestions as to its extermination	5
----	--	---

In other respects, Mr. Carruthers's duties are similar to Dr. Voelcker's ; but the Council have only recently decided to publish the names of those dealers who supply the Members with bad or mixed seed. For this delay there are two reasons, viz., (1) there is a special statute, known as the "Adulteration of Seeds Act," which imposes penalties on persons convicted of killing or dyeing, or causing to be killed or dyed, any kind of seed ; and (2) this department of the Society has not been in operation long enough to bring the Members into the habit of systematically submitting their seeds for examination. There can be little doubt, however, that in a few years the facilities offered for the detection of bad, killed, or dyed seed, and of the presence of seeds of injurious weeds or parasites, will be more highly appreciated by the Members of the Society.

Veterinary Department.

*Veterinary.*—This department is organised upon analogous though not exactly similar principles to those just described. For many years the Society was intimately connected with the Royal Veterinary College, and the Principal of that Establishment (Professor Simonds, whose services to the Society in past years it would be difficult to exaggerate) is still the Consulting Veterinary Surgeon of the Society. The practical work of the department, however, is now done by the officers of the "Brown Institution," which was established for the investigation of the diseases of animals useful to man. Members of the Society have privileges with respect to the diseases of cattle, sheep, and pigs, as follows :—

## I.—SERIOUS OR EXTENSIVE DISEASES.

No. 1. Any Member of the Society who may desire professional attendance and special advice in cases of serious or extensive disease among his cattle,



sheep, or pigs, and will address a letter to the Secretary, will, by return of Members' post, receive a supply stating whether it be considered necessary that the Society's Veterinary Inspector should visit the place where the disease prevails. Privileges.

No. 2. The remuneration of the Inspector will be 2*l.* 2*s.* each day as a professional fee, and 1*l.* 1*s.* each day for personal expenses; and he will also be allowed to charge the cost of travelling to and from the locality where his services may have been required. The fees will be paid by the Society, but the travelling expenses will be a charge against the applicant. This charge may, however, be reduced or remitted altogether at the discretion of the Council, on such step being recommended to them by the Veterinary Committee.

No. 3. The Inspector, on his return from visiting the diseased stock, will report to the Committee, in writing, the results of his observations and proceedings, which report will be laid before the Council.

No. 4. When contingencies arise to prevent a personal discharge of the duties confided to the Inspector, he may, subject to the approval of the Committee, name some competent professional person to act in his stead, who shall receive the same rates of remuneration.

## II.—ORDINARY OR OTHER CASES OF DISEASE.

Members may obtain the assistance of the Veterinary Inspector on any case of disease by paying the cost of his visit, which will be at the following rate, viz., 2*l.* 2*s.* per diem, and travelling expenses. Applications should be addressed to the Superintendent of the Brown Institution, care of the Secretary of the Royal Agricultural Society, 12, Hanover Square, London, W.

## III.—CONSULTATIONS WITHOUT VISIT.

Personal consultation with Veterinary Inspector .. .. .	5 <i>s.</i>
Consultation by letter .. .. .	5 <i>s.</i>
Consultation necessitating the writing of three or more letters	10 <i>s.</i>
Post-mortem examination, and report thereon .. .. .	10 <i>s.</i>

A return of the number of applications from Members of the Society during each half-year is required from the Veterinary Inspector.

## IV.—ADMISSION OF DISEASED ANIMALS TO THE BROWN INSTITUTION, WANDSWORTH ROAD, S.W. : INVESTIGATIONS ; LECTURES AND REPORTS.

No. 1. All Members of the Society have the privilege of sending cattle, sheep, and pigs to the Infirmary of the Brown Institution on the following terms; viz., by paying for the keep and treatment of cattle 10*s.* 6*d.* per week each animal, and for sheep and pigs "a small proportionate charge to be fixed by the Professor-Superintendent according to circumstances."

No. 2. The Professor-Superintendent of the Institution has also undertaken to carry out such investigations relating to the nature, treatment, and prevention of diseases of cattle, sheep, and pigs, as may be deemed expedient by the Council.

No. 3. A detailed Report of the cases of cattle, sheep, and pigs treated in the Infirmary of the Institution or on Farms in the occupation of Members of the Society will be furnished to the Council quarterly; and also special reports from time to time on any matter of unusual interest which may come under the notice of the Institution.

Occasionally it is somewhat difficult to discriminate between cases in which the whole expense of the visit of the Veterinary Inspector should be borne by the Member, and those in which

a part should be borne by the Society; but the Council have always endeavoured to deal with these matters in a liberal spirit, and the clauses have been most liberally interpreted in times of public danger—such, for instance, as an outbreak of cattle-plague.

Importance of  
the Veterinary  
Department.

In some respects this is the most necessary of the scientific departments of the Society. The loss to farmers in consequence of their buying bad seed, adulterated manure, or “mixed” cakes is often very great, but the action is their own; and irrespective of the Society, though probably with greater cost and less security, the remedy is in their own hands. In the case, however, of the outbreak of a contagious or infectious disease among his flock or herd, the farmer is practically powerless. He can rarely fasten the blame upon any one, and if he should be able to prove the carelessness of a drover or a shepherd it brings him no pecuniary compensation. His best course is to obtain without delay the most reliable advice, with a view to stay the progress of the destroyer; and this the Society has placed within his reach at a very moderate cost under any circumstances, and at none at all in matters of public importance.

Investigations  
into diseases  
of animals of  
the farm.

This department of the Society's organisation is not confined to the application of the known truths of veterinary science to the diseases of animals of the farm, but it is largely occupied with endeavours to increase the technical knowledge of these subjects by stimulating research in reference to both preventive and curative measures. The volumes of the Society's ‘Journal’ contain numerous papers embodying the results of experiments made at the Royal Veterinary College, the Brown Institution, and elsewhere; and of a large number of local investigations at special farms into nearly every important disease which commonly affects farm-stock. I may specially mention researches into cattle-plague and inoculation for pleuro-pneumonia, made over a large area upon the continent of Europe by Professor Simonds; experiments upon almost every known contagious or infectious disease of cattle, sheep, and pigs made at the Royal Veterinary College; and, more recently, very careful scientific experiments upon foot-and-mouth disease, pleuro-pneumonia, and anthrax, made at the Brown Institution; while at the present moment arrangements are being made to test, on an extensive scale and in different parts of the kingdom, the protective effect against pleuro-pneumonia, of the new method of inoculation devised by Dr. Burdon Sanderson.

## CHAPTER IV.

### THE PROPAGANDA OF AGRICULTURE.

UNDER this heading I shall attempt to describe briefly the manner in which the Society endeavours to promulgate the facts and principles of modern improved agriculture to its Members through its 'Journal,' and to the farmers, land-agents, and veterinary surgeons of the future by stimulating their technical education through the offer of rewards for special success at school and at College.

*The Journal.*—From the date of its establishment in 1838, The 'Journal.' the publication of a periodical 'Journal' has been one of the distinctive features of the Society's efforts. For the first three years three "parts" were published in each year, but since then only two, namely, one in spring before seed-time, and one in autumn after harvest.

To a student of agricultural history, a comparison of the contents of the earliest with the successive and the latest volumes of the 'Journal' cannot fail to suggest many interesting questions. Forty years ago, when railways were comparatively few and far between, residents in remote country districts seldom had the opportunity of meeting to discuss practical questions which were then beginning to acquire importance. In those days, too, class newspapers devoted to technical subjects were comparatively unknown. Therefore the earlier volumes of the 'Journal of the Royal Agricultural Society' teemed with short practical articles written by enthusiastic landowners and farmers who had been among the founders of the Society, and who were encouraged and stimulated by the example and the exhortations of the first editor of the 'Journal'—Mr. Pusey, M.P.—to whom English agricultural literature, from a practical point of view, is indebted to an extent that is probably exceeded only by the services of Arthur Young.

In the course of time, greater intercourse between farmers, the Its history. enormous development of the newspaper press, and other circumstances, induced the writers of short practical essays to seek immediate publication, instead of waiting for the six-monthly interval between the publication of the numbers of the Society's 'Journal.' The Council, therefore, found it necessary to offer prizes for well-considered essays on selected subjects; and for a series of years the contents of the 'Journal' very largely consisted of the "crowned" memoirs, many of which were well worthy of their success, and to this day hold their ground as text-books upon their several subjects.

These two periods in the history of the 'Journal' were, ten years ago, succeeded by a third. The Prize-system had become inadequate to supply sufficiently meritorious essays upon the subjects which then began to demand attention. Our agriculture had become more scientific, and our food-supplies more dependent upon the wants and crops of other nations. Therefore the information required by the Society's Members was in most cases of such a nature as to require a special investigation by a trained mind, or a special journey to a foreign country. Realising this alteration in the circumstances of agriculture, the Journal Committee gradually modified their practice in the conduct of the 'Journal,' until, as at the present time, and for some years past, each half-yearly number may be regarded as a collection of exhaustive essays upon their several subjects, not the least useful and interesting being the Official Reports on scientific investigations—Veterinary, Chemical, Botanical—and on practical competitions for prizes offered for Farms, Live-Stock, and Implements.

Its usefulness.

Notwithstanding these alterations in the system of conducting the 'Journal,' in conformity with the spirit of the times when they were made, it may be safely asserted that no other publication bearing upon agriculture contains such an amount of useful matter connected with so little that is irrelevant. The Chairmen of the Journal Committee (who, until the last twenty years, were also the editors of the 'Journal') are singularly few in number, namely, Mr. Pusey, Sir H. S. Meysey Thompson, and Mr. Dent; and the result of their successive labours is a most valuable magazine of facts, figures, and principles, elucidating the Science and Practice, as well as the History, of European Agriculture.

Agricultural education.

*Education.*—The Society has made many efforts to carry out the seventh "Object" enumerated in the Charter, namely, "to take measures for the improvement of the education of those who depend upon the cultivation of the soil for their support." Many schemes have been tried, and all have more or less failed. At the present moment the only measures taken with a view to stimulate purely agricultural education are the encouragement of young men at College and boys at school to apply themselves to the study of agriculture, and the sciences which are most necessary to its successful practice.

Senior Examination.

The Senior Examination, chiefly applicable to young men leaving College, is held every April; prizes and certificates are offered to the successful candidates, and every First-class Certificate carries with it the Life-Membership of the Society. Very few candidates present themselves for examination; and

although this scheme has been in operation more than ten years, the value of the Society's Certificate as a proof of knowledge and ability does not yet seem widely enough recognised to induce many Students to go through the somewhat thorough course of study necessary to obtain it.

The Junior Examination has not been in operation more than four years. Ten scholarships of 20*l.* each, tenable for one year, are annually offered for competition to pupils of certain Middle-Class Public Schools. The examinations are held at the schools in November, and the scholarships are not paid until the following November, and then only upon receipt of a certificate that the scholar has passed the year either at school, or at an Agricultural College, or with a practical farmer approved by the Council. This scheme was designed as an inducement to tenant-farmers to keep their sons at school longer than they usually do; and also as an encouragement to the schools to introduce the Science and Practice of Agriculture into their curriculum. In both of these objects the scheme has already been fairly successful; and it promises very well for the future, as the number of schools on the list, and the number of those which enter candidates for examination, are both gradually increasing. In the course of time it may be hoped that this scheme may act and re-act upon the Senior Examination, first by inducing the junior scholars to enter upon the more thorough course of study for its own sake and for its practical value; and secondly, by creating a demand for teachers at the Middle-Class Schools—the head-masters of which would attach due importance to the Society's First-class Certificate.

A third educational examination has been established only two years, and has already achieved a fair measure of success. Prizes and Medals are annually offered to Graduates of the Royal College of Veterinary Surgeons who have been educated at an English Veterinary College, and who have obtained their degree not less than three, and not more than fifteen months. The examination is both practical and theoretical, and is confined to the diseases, treatment, and pathology of cattle, sheep, and pigs, with a view to induce young Veterinary Surgeons to extend their observation and knowledge of the animals of the farm generally, instead of confining them, as has hitherto been too generally the case, exclusively to the horse and his ailments.

In all the existing schemes, the education of the Middle-class is alone sought to be stimulated. The Senior Examination aims at the large tenant-farmer and the land-agent; the Junior Scholarships are offered to the smaller tenant-farmer of the



future; and the Veterinary Medals and Prizes to the rising cattle-doctor; but the landowner and the labourer are alike unprovided for. With regard to the landowner, it may be said that if self-interest does not induce him to acquire some technical knowledge of agriculture, no system of examination, and no offer of prizes or certificates would be likely to tempt him. At the same time it must be admitted that the English Universities have, one and all, failed to give proper facilities for such a course of study to the young landlord during his College career.

and of the  
labourer.

The technical education of the young labourer is a more difficult and a more pressing consideration. The Education Acts have not yet been long enough in force to make much impression upon the rural youth; but that his intelligence will be much increased by their operation in the course of a few years cannot be doubted. Here, then, is the opportunity to remedy the growing evil of "worse work for more pay," which is heard whenever the agricultural labourer is mentioned. It would be foreign to the scope of this Memoir to enter into a discussion of the means which might be adopted for this purpose, and it is alluded to here in the same manner as other topics which are still in the future, to show that the scope of the Society's operations, which has been very largely widened during the last ten years, has not yet attained its ultimate extension.

Retrospect.

A retrospective glance at the last ten years will show that in so short a period of time the Society has increased in number 20 per cent.; its 'Journal' has become more popular with its Members; Farm-prizes have been established; the systematic testing of competing agricultural implements has been much improved; scientific investigations into diseases of animals of the farm have been placed on a sound basis; the technical education of Veterinary Surgeons and of tenant-farmers and land-agents has been stimulated and encouraged; a Consulting Botanist and Entomologist to advise the Members has been appointed; an Experimental Farm has been established; and a system of exposure of persons connected with the sale of inferior or adulterated feeding-stuffs, manures, and agricultural seeds has been organised and fearlessly carried out, to the great benefit of the agricultural community. It has been said that a man should be strong at thirty, wise at forty, and rich at fifty. Ten years ago the Royal Agricultural Society had completed the first of those periods, and with 5500 Members might be considered strong in numbers and in influence. Its action



during the past ten years entitle it, in my judgment, to claim that at forty years of age it is deserving of the epithet which belongs to that stage of existence; and I have no doubt that at the end of another ten years it will, without any diminution of strength or wisdom, be rich in everything which will add to its power to carry out the great object for which it was established—the general advancement of English Agriculture.

INDEX TO THE MEMOIR  
ON THE  
AGRICULTURE OF ENGLAND AND WALES,  
FORMING  
PART II., VOL. XIV.—SECOND SERIES,  
OF THE  
JOURNAL OF THE ROYAL AGRICULTURAL SOCIETY  
OF ENGLAND.

---

ABERDEENSHIRE.

- ABERDEENSHIRE cattle (J. A. Clarke), 285.  
 ABORTION, preventing (J. A. Clarke), 251.  
 ABSORBENT power of soils (Dr. Voelcker), 543.  
 ACRE, average yield of wheat per (J. A. Clarke), 196.  
 ACREAGE devoted to growth of vegetables (C. Whitehead), 483; potatoes, 490.  
 — of England and Wales (J. A. Clarke), 194.  
 — of fruit-land in Great Britain (C. Whitehead), 471.  
 — of hop-lands (C. Whitehead), 457.  
 — of the United Kingdom (J. Caird), 24.  
 ADULTERATED manures and feeding stuffs (H. M. Jenkins), 618.  
 AGE of hop grounds in Kent (C. Whitehead), 458.  
 — when cattle begin to breed (J. A. Clarke), 225; ewes, 250; sows, 264.  
 AGREEMENT, forms of (Clifford and Foote), 90.  
 —, form of, between farmers and their carters (H. J. Little), 521.  
 AGRICULTURAL education (H. M. Jenkins), 624.  
 — Holdings Act (J. Caird), 39.  
 — Holdings Act (Clifford and Foote), 99; review of the act, 100–115; results, 116.  
 — Holdings Act (E. P. Squarey), 171.  
 — Interest, Taxation as affecting the (Captain Craigie), 123.  
 — Labourer, see also "Labourer."

AMMONIA.

- AGRICULTURAL Labourer (H. J. Little), 499.  
 — population, decrease in proportion to other classes (J. Caird), 31.  
 — products, prices of (J. A. Clarke), 202.  
 — returns (J. A. Clarke), 198.  
 — statistics (J. A. Clarke), 193.  
 — statistics of the United Kingdom (J. Caird), 14.  
 — tenants (Clifford and Foote), 83.  
 AGRICULTURE (British), General View of (J. Caird), 11.  
 — (Practical) (J. A. Clarke), 185.  
 — principal occupation of the people of Ireland (J. Caird), 29.  
 — results of the Agricultural Holdings Act on (Clifford and Foote), 116.  
 AGRICULTURISTS, number of, with independent incomes (Captain Craigie), 124; dependent classes, *ib.*  
 AILMENTS of calves (J. A. Clarke), 231.  
 AIR, effect on foul liquids (Dr. Voelcker), 564.  
 ALDERNEYS (J. A. Clarke), 277.  
 ALIENATION of land, right of (Clifford and Foote), 72.  
 ALLOWANCES to labourers (H. J. Little), 510.  
 — to tenants for improvements (E. P. Squarey), 177.  
 AMERICA, importation of meat from (J. Caird), 13.  
 AMERICANS, great meat consumers (J. Caird), 13.  
 AMMONIA, absorption of, by soils (Dr. Voelcker), 544.

## ANALYSES.

- ANALYSES do not always show agricultural capabilities of the soil (Dr. Voelcker), 543; questions answered by analysis, 548.
- for members (H. M. Jenkins), 615.
- ANALYSIS of stored chaff (J. A. Clarke), 247.
- of taxation (Captain Craigie), 128.
- ANGLESEA cattle (J. A. Clarke), 284.
- ANGUS cattle (J. A. Clarke), 285.
- ANIMAL food, value of, imported (J. Caird), 12.
- ANIMALS, experiments on (Dr. Voelcker), 583.
- of the farm, investigation into the diseases of (H. M. Jenkins), 622.
- APHIS blight on hops (C. Whitehead), 465.
- APPLE orchards in Herefordshire (C. Whitehead), 472.
- ARABLE farm, proportion of landlord's and tenant's capital on an (E. P. Squarey), 165.
- land improved by drainage (J. Caird), 45.
- land, management of sheep on (W. T. Carrington), 447-450.
- ARBITRATION (Clifford and Foote), 98.
- ARTIFICIAL manures (J. A. Clarke), 354.
- , best time to apply (Dr. Voelcker), 545.
- , value in times of war (J. Caird), 19.
- , imports of (J. A. Clarke), 202.
- ARTIFICIALS when best applied (Dr. Voelcker), 561; manufacture, 562.
- ASH-POLES for hops (C. Whitehead), 462.
- ASPARAGUS culture (C. Whitehead), 486.
- ASSES (J. A. Clarke), 365.
- ASSESSMENT of improvements under the Agricultural Holdings Act (Clifford and Foote), 108.
- of tenant farmer to income tax (Captain Craigie), 142.
- ATMOSPHERE, sources of nitrogen from the (Dr. Voelcker), 557.
- ATMOSPHERIC moisture (J. A. Clarke), 187.
- AUTHORS, list of, Caird, 1; Clifford and Foote, 73; Craigie, 124; Squarey, 163; Clarke, 185; Morton, 381; Carrington, 435; Whitehead, 457; Little, 499; Voelcker, 541; Jenkins, 593.
- AUTUMN calving (J. A. Clarke), 227.
- AWARDS for compensation under the Agricultural Holdings Act (Clifford and Foote), 112.
- AYLESBURY Dairy Company (Dr. Voelcker), 580.
- AYRSHIRE cattle (J. A. Clarke), 286.
- (J. C. Morton), 396.

## BREEDS.

## B.

- BAKEWELL's improved Longhorns (J. A. Clarke), 276.
- BANKS (E. P. Squarey), 173.
- BARGE navigation (J. Caird), 56.
- BARLEY, continuous growth of (Dr. Voelcker), 551.
- , experiments in the growth of (J. Caird), 21.
- , more likely to succeed after barley than wheat (J. Caird), 20.
- , yield of, compared with foreign countries (J. A. Clarke), 198; home production, 207; imports and prices, 208.
- BATEMAN, Lord, machinery on his farm (J. A. Clarke), 368.
- BATH cheese (J. C. Morton), 420.
- BATTERSEA Meeting (H. M. Jenkins), 612.
- BEANS (J. A. Clarke), 340.
- , imports for feeding (J. A. Clarke), 202.
- BEE-ROOT sugar, manufacture of (Dr. Voelcker), 577.
- BENEFIT societies (H. J. Little), 525.
- BERKSHIRE pigs (J. A. Clarke), 307.
- BIRD scarers (H. J. Little), 530.
- BLACK-FACED mountain sheep (J. A. Clarke), 304.
- BLIGHT-PROOF potatoes (C. Whitehead), 492.
- BOARD Schools (H. J. Little), 529.
- BOARDS of Guardians (Capt. Craigie), 146.
- BONE-DUST, beneficial results to root-crops (Dr. Voelcker), 547.
- BONES as a manure (J. A. Clarke), 358.
- and bone materials (Dr. Voelcker), 562.
- BORDER Leicester sheep (J. A. Clarke), 288.
- BOTANICAL department of the Royal Agricultural Society (H. M. Jenkins), 619.
- "BOTHY system" in Scotland (H. J. Little), 524.
- BOXES for feeding cattle (J. A. Clarke), 234.
- BREAKING straw (J. A. Clarke), 247.
- BREAKING-IN colts (J. A. Clarke), 364.
- BREEDERS of Shorthorns (J. A. Clarke), 268; Herefords, 271; Devons, 274.
- BREEDING, age at which cattle commence (J. A. Clarke), 225; ewes, 250; sows, 264.
- farm-horses (J. A. Clarke), 364.
- season for ewes (J. A. Clarke), 249.
- BREEDS of cattle for milk supply (J. C. Morton), 382.

## BRITISH.

- BRITISH Agriculture, General View of (J. Caird), 11.  
 —, influence of Chemical Discoveries in (Dr. Voelcker), 541.  
 BROCOLI culture in Cornwall (C. Whitehead), 488.  
 BUCKINGHAMSHIRE dairy farm (J. C. Morton), 423.  
 BUILDINGS, improvement of, by state loans in Ireland (J. Caird), 42.  
 BULLOCK breeding (W. T. Carrington), 442.  
 BURIAL Clubs (H. J. Little), 527.  
 BUTTER (J. A. Clarke), 220.  
 —, manufacture of (J. C. Morton), 423.

## C.

- CABBAGE (J. A. Clarke), 341.  
 CABBAGES (C. Whitehead), 487.  
 CAIRD, A. McNeil, plan of cottages built by (H. J. Little), 519.  
 —, James, C.B. F.R.S., General View of British Agriculture, 11.  
 CALVES, diseases of (W. T. Carrington), 438.  
 —, number dropped per year (J. A. Clarke), 214; treatment of, 228.  
 —, the rearing of (J. C. Morton), 401.  
 CALVING, season chosen for (J. A. Clarke), 225.  
 CANARY seed (J. A. Clarke), 316.  
 CAPITAL more profitably employed than in improving our poorer class of soils (J. Caird), 14.  
 — of landlords and tenants, 163.  
 — of the agricultural classes (Capt. Craigie), 125.  
 CARRINGTON, W. T., his farm management (J. C. Morton), 386.  
 — on Pastoral Husbandry, 435.  
 CASTLEMARTIN cattle (J. A. Clarke), 283.  
 CATERPILLARS on fruit trees (C. Whitehead), 475.  
 CATHCART, Earl, on wool (J. A. Clarke), 221.  
 CATTLE (J. A. Clarke), 199; number, compared with foreign countries, 201.  
 —, dairy and grazing breeds of (J. C. Morton), 382.  
 —, estimated dead-weight of (J. A. Clarke), 212; management of, 225.  
 —, rearing of (W. T. Carrington), 437.  
 CATTLE-FOOD, cooked (J. A. Clarke), 238.  
 CAUSTIC lime as a dressing for fruit trees (C. Whitehead), 476.  
 CELIBACY uncommon among labourers (H. J. Little), 534.  
 CEREAL food, value of imported (J. Caird), 12.

## CLIMATE.

- CHALK, rotation on the (J. A. Clarke), 317; in Hampshire, 323.  
 CHALKING (J. A. Clarke), 359.  
 CHANCERY, Court of, and settled estates (Clifford and Foote), 80.  
 CHANNEL Island cattle (J. A. Clarke), 277.  
 "CHARGES on estates," the creation of, by landowners (Clifford and Foote), 113.  
 CHARITY estates (J. Caird), 65; value, *ib.*  
 CHARTER of the Royal Agricultural Society (H. M. Jenkins), 595.  
 CHEDDAR cheese (J. C. Morton), 407.  
 CHEDDAR plan of cheese-making (Dr. Voelcker), 580.  
 CHEESE (J. A. Clarke), 220.  
 —, the manufacture of (J. C. Morton), 407.  
 — factories (Dr. Voelcker), 579.  
 CHEMICAL department of the Royal Agricultural Society (H. M. Jenkins), 617.  
 — Discoveries, influence on English Agriculture (Dr. Voelcker), 541.  
 CHERRIES, cultivated in Kent (C. Whitehead), 477.  
 CHESHIRE cheese (J. C. Morton), 409.  
 — dairy farm (J. C. Morton), 388.  
 —, soils and crops of (J. A. Clarke), 351.  
 CHESTNUT for hop-poles (C. Whitehead), 462.  
 CHEVIOTS (J. A. Clarke), 302.  
 CHILTERN district, crops in the (J. A. Clarke), 336.  
 CHURCH estates (J. Caird), 62.  
 CIDER (C. Whitehead), 473.  
 CIVIL list (J. Caird), 64.  
 CLARKE, John Algeron, on Practical Agriculture, 185.  
 CLERGY, number of (J. Caird), 63.  
 CLAIMS under the Agricultural Holdings Act, procedure in establishing (Clifford and Foote), 111.  
 CLAY soils unfit for irrigation (Dr. Voelcker), 567.  
 CLAYING (J. A. Clarke), 359.  
 CLIFFORD, Frederick, on English Land Law, 71.  
 CLIMATE (J. A. Clarke), 186.  
 — influence on sheep (W. T. Carrington), 444.  
 — of England, variation in the (W. T. Carrington), 435.  
 — of Scotland unfavourable for fruit-growing (C. Whitehead), 481.  
 — of the United Kingdom (J. Caird), 24.  
 — unfavourable to growth of beet-root (Dr. Voelcker), 579.

## CLOVER.

- CLOVER, impossible to secure a continuous crop of (J. Caird), 21.  
 — alternating with seeds (J. A. Clarke), 339.  
 CLYDESDALES (J. A. Clarke), 313.  
 COB-NUTS (C. Whitehead), 479.  
 COCONUT-CAKE (Dr. Voelcker), 573.  
 COLEMAN, J., on Berkshire pigs (J. A. Clarke), 307.  
 COLONIES enable England to dispense with checks on increase of population 29.  
 COLTS (J. A. Clarke), 364.  
 COMMONS and waste lands (J. Caird), 57; extent, 58.  
 COMPANIES for improvement of land (J. Caird), 42.  
 — (E. P. Squarey), 175.  
 COMPENSATION, conditions of, under the Agricultural Holdings Act (Clifford and Foote), 110.  
 — to out-going tenants (E. P. Squarey), 169.  
 COMPOSTS (J. A. Clarke), 358.  
 CONDENSED milk manufacture (Dr. Voelcker), 580.  
 CONSTITUTION of the Royal Agricultural Society (H. M. Jenkins), 594.  
 CONTENTS sheets, 7, 69, 121, 161, 183, 379, 455, 497, 539, 591.  
 CONTINUOUS cropping (Dr. Voelcker), 550.  
 CONTRACT, freedom of (Clifford and Foote), 92.  
 COOKED cattle food (J. A. Clarke), 238.  
 COPYHOLDS (J. Caird), 57; enfranchisement, 60.  
 CORN, imports for feeding (J. A. Clarke), 202.  
 — returns (J. A. Clarke), 202.  
 CORN-CROPS, diminution of, in Ireland (J. Caird), 16.  
 —, distribution of (J. A. Clarke), 195.  
 —, experiments in the growth of (J. Caird), 21.  
 —, successive (J. Caird), 19.  
 CORNWALL, market-gardening in (C. Whitehead), 488.  
 —, soils and crops of (J. A. Clarke), 329.  
 —, temperature of (J. A. Clarke), 186.  
 CORVE Dale, rotations in the (J. A. Clarke), 338.  
 COTSWOLD Hills (J. A. Clarke), 332.  
 COTSWOLDS (J. A. Clarke), 293.  
 — (W. T. Carrington), 445.  
 COTTAGES for labourers (J. Caird), 46.  
 — (E. P. Squarey), 168.  
 —, improvement in, for the poor (H. J. Little), 512.  
 COTTON-CAKE (Dr. Voelcker), 571.

## DAIRY.

- COUNTIES in which hops are principally grown (C. Whitehead), 458.  
 —, distribution of poor rates in different (Capt. Craigie), 146.  
 COUNTRY Meetings of the Royal Agricultural Society (H. M. Jenkins), 600.  
 — supply of milk (J. C. Morton), 404.  
 COUNTY Courts, jurisdiction of (Clifford and Foote), 113.  
 —, customs of the (Clifford and Foote), 87; effect, 88; exclusion, 93.  
 — rates (Capt. Craigie), 149.  
 COVENANTS in leases (Clifford and Foote), 95.  
 COVERED yards (J. A. Clarke), 361.  
 — for cattle feeding (J. A. Clarke), 235.  
 Cows kept by masters for the labourers (H. J. Little), 521.  
 —, management of (J. C. Morton), 381.  
 —, number in the United Kingdom (J. A. Clarke), 213.  
 —, on feeding, for milk (J. C. Morton), 405.  
 CRAIGIE, Captain, on Taxation as affecting the Agricultural Interest, 123.  
 CREAM cheese (J. C. Morton), 420.  
 CREOSOTING hop-poles (C. Whitehead), 463.  
 CROPPING land, freedom of (E. P. Squarey), 173.  
 CROPS, extent of land under various, in 1877 (J. Caird), 16.  
 —, sale of, on continuous corn growing land (Dr. Voelcker), 554.  
 CROWN estates (J. Caird), 64; conditions on which they are let, 65.  
 CUCUMBERS (C. Whitehead), 487.  
 CULTIVATION of Hops, Fruits and Vegetables (C. Whitehead), 457.  
 CULTIVATORS (J. A. Clarke), 370.  
 CURRANTS (C. Whitehead), 478.  
 CUSTOM of emblements (Clifford & Foote), 84.  
 CUSTOMS, local (Clifford and Foote), 87; effect, 88; exclusion, 93.
- D.
- DAIRY appliances, prizes for (H. M. Jenkins), 606.  
 — cows (J. C. Morton), 381.  
 — factories (J. C. Morton), 414.  
 — farm in Staffordshire (J. C. Morton), 386; Cheshire, 388; Herefordshire, 395.  
 — farm, proportion of landlord's and tenant's capital on a (E. P. Squarey), 164.  
 — farming (J. C. Morton), 381.  
 — implements (J. C. Morton), 429.  
 — products (J. A. Clarke), 220.



## DAVY.

- DAVY, J. T., description of a Devon (J. A. Clarke), 272.
- DEAD meat, importation of (W. T. Carrington), 452.
- , plan adopted in importation of (J. Caird), 13.
- De Donis*, the statute, when passed and result (Clifford and Foote), 75.
- "DEATH duties" (Capt. Craigie), 138.
- DE BARY, Professor, on the potato disease (C. Whitehead), 491.
- DEEDS, stamps on (Capt. Craigie), 138.
- DENTON, J. Bailey, on English climate (J. A. Clarke), 187.
- DERBYSHIRE cheese (J. C. Morton), 412.
- DEVON Longwools (J. A. Clarke), 292.
- DEVONS (J. A. Clarke), 272.
- (J. C. Morton), 397.
- (W. T. Carrington), 444.
- DEVONSHIRE butter (J. C. Morton), 427.
- , fruit-land of (C. Whitehead), 474.
- , soil and crops of (J. A. Clarke), 328.
- DIAGRAM statistical map (J. A. Clarke), 194.
- DIET for a weaning calf (J. A. Clarke), 229.
- DIPPING lambs (J. A. Clarke), 256.
- (W. T. Carrington), 445.
- DIPS for sheep (J. A. Clarke), 258.
- DISEASE-PROOF potatoes (C. Whitehead), 492.
- DISEASES of animals, investigations into (H. M. Jenkins), 622.
- of calves (W. T. Carrington), 453.
- DISTRIBUTION of taxation (Capt. Craigie), 128.
- DOMESDAY Book, division of landowners in the (J. Caird), 28.
- DOMESTIC life of the labourer (H. J. Little), 512.
- servants (H. J. Little), 533.
- DORSET pigs (J. A. Clarke), 308.
- horned sheep (J. A. Clarke), 300.
- (W. T. Carrington), 446.
- DORSETSHIRE dairy farm (J. C. Morton), 425.
- , soils and crops of (J. A. Clarke), 328.
- DOUBLE-FURROW plough (J. Caird), 19.
- DRAIN gauges (Dr. Voelker), 582.
- DRAINAGE (E. P. Squarey), 167.
- Commissions, formations of (J. Caird), 55.
- improvements by State loans (J. Caird), 42; a remunerative improvement, 45 and 50.
- , loss of nitrogen by (Dr. Voelker), 559.
- , outfalls for, in England and Wales (J. A. Clarke), 190.
- DRESS of the labourer (H. J. Little), 532.

## ENTAIL.

- DRESSING for hop plants (C. Whitehead), 461.
- for sheep (J. A. Clarke), 261.
- DRY food for sheep (J. A. Clarke), 261.
- DUCKHAM, T., description of a Hereford (J. A. Clarke), 270.
- , on spring calving (J. A. Clarke), 226.
- , on the five-course rotation in Herefordshire (J. A. Clarke), 334.
- DUNG-HEAPS and pits (J. A. Clarke), 361.
- DUTIES of the landowners (J. Caird), 33.
- on legacies, probate, &c. (Capt. Craigie), 138.
- DUTY on hops (C. Whitehead), 469.
- E.
- EARNINGS of the labourer (Capt. Craigie), 126.
- (H. J. Little), 508.
- EARTH-NUT cake (Dr. Voelker), 571.
- EAST Riding of Yorkshire, soils and crops of (J. A. Clarke), 348.
- EASTERN counties, mean monthly temperature and rainfall of the (J. A. Clarke), 188.
- EDMONDS, W. J., his practice of preparing cattle food (J. A. Clarke), 243.
- EDUCATION, agricultural (H. M. Jenkins), 624.
- of the labourer (J. Caird), 35.
- (H. J. Little), 528.
- EDUCATIONAL rates (Capt. Craigie), 150.
- EMBLEMS, custom as to (Clifford and Foote), 84; legal doctrine, 100.
- EMIGRATION, extent of yearly (J. Caird), 30; benefits, 37.
- ENCLOSURE Commissioners, action of (E. P. Squarey), 176.
- ENFRANCHISEMENT of copyhold lands (J. Caird), 60.
- ENGINES, fixed and portable (J. A. Clarke), 367.
- ENGLAND dependent on foreign supply for increase of meat and dairy produce (J. Caird), 14; cost of carriage, *ib.*
- , Royal Agricultural Society of (H. M. Jenkins), 593.
- , system of "tenancy at will" is general in (J. Caird), 38.
- ENGLISH Agriculture, influence of Chemical Discoveries on (Dr. Voelker), 541.
- Land Law (Clifford and Foote), 71.
- landowners receive no special training (J. Caird), 51.
- settlement, examples of (Clifford and Foote), 78.
- ENTAIL, power of (Clifford and Foote), 76; limited by law, 78.



ESSEX.

- ESSEX pigs (J. A. Clarke), 309.  
 —, soils and crops of (J. A. Clarke), 342.  
 "ESTATES tail," why created (Clifford and Foote), 75.  
 EUROPE, the importation of fresh meat from America into (J. Caird), 13.  
 EVERSHED, Hy., his practice of steaming chaff (J. A. Clarke), 245.  
 EWES lambing twice in the year (J. A. Clarke), 249; selection and age for breeding, 250.  
 EXAMINATIONS in connection with the Royal Agricultural Society (H. M. Jenkins), 624.  
 EXAMPLES of the law of family settlement in England (Clifford and Foote), 78.  
 EXCHANGE of lands, inexpensive and simple (J. Caird), 56; extent, 57.  
 EXHIBITIONS in connection with the Royal Agricultural Society (H. M. Jenkins), 600.  
 EXMOOR sheep (J. A. Clarke), 301.  
 EXPENDITURE and receipts of the Society, 1841-77 (H. M. Jenkins), 598.  
 EXPENSES of the labourer (H. J. Little), 507.  
 EXPERIMENTAL lands at Woburn (Dr. Voelcker), 584.  
 — stations (Dr. Voelcker), 581.  
 EXPERIMENTS at Rothamsted (Dr. Voelcker), 568, 572; Woburn, 584.  
 —, influence of (Dr. Voelcker), 549.  
 — on vegetation (Dr. Voelcker), 582; animals, 583.  
 EXPORTATION of hops (C. Whitehead), 469.

F.

- FACTORIES for cheese making (J. C. Morton), 415; statistics, 417.  
 FAIRS in Lincolnshire (J. A. Clarke), 290; Hants and Wilts, 298.  
 FAMILY settlements, establishment of the system of (Clifford and Foote), 76.  
 FARM buildings, caution required in expenditure (J. Caird), 45.  
 —, erection of, under the Agricultural Holdings Act (Clifford and Foote), 114.  
 — horses (J. A. Clarke), 363.  
 — prizes (H. M. Jenkins), 613.  
 FARM capital (E. P. Squarey), 163.  
 —, increase of (J. Caird), 24.  
 FARMERS, their early position (Clifford and Foote), 100.  
 — and the labour market (H. J. Little), 505.  
 FARMERS' taxation (Capt. Craigie), 154.  
 FARMING without manure (J. A. Clarke), 360.

FOLDING.

- FARMING, circumstances which attract or repel capital from (E. P. Squarey), 171.  
 —, Dairy (J. C. Morton), 381.  
 FARMSTADS, noted (J. A. Clarke), 367.  
 FARMYARD-MANURE (J. A. Clarke), 360.  
 —, when best applied (Dr. Voelcker), 561.  
 — for vegetables (C. Whitehead), 485.  
 FARROWING (J. A. Clarke), 204.  
 FATTENING cattle, roots for (J. A. Clarke), 237.  
 — house lambs (J. A. Clarke), 253; sheep in sheds, 263; pigs, 265.  
 FEEDING cattle for the dairy (J. C. Morton), 391.  
 — experiments at Woburn (Dr. Voelcker), 586.  
 — and rearing live stock (Dr. Voelcker), 570.  
 — and winter housing of cattle (J. A. Clarke), 232; fittings and arrangements, 235.  
 — horses (J. A. Clarke), 364.  
 — stuffs, inferior (H. M. Jenkins), 618.  
 FEES of good benefit clubs (H. J. Little), 526.  
 FERTILE land, tenant's capital less in (E. P. Squarey), 166.  
 FERTILITY of soils, examples of the (J. Caird), 26.  
 FEUDAL tenure (Clifford and Foote), 71.  
 FIELD experiments at Woburn (Dr. Voelcker), 585.  
 FILBERTS (C. Whitehead), 479.  
 FINANCE department of the Royal Agricultural Society (H. M. Jenkins), 597.  
 FINES and recoveries on land, how instituted (Clifford and Foote), 76.  
 FIR plantations for hop-poles (C. Whitehead), 462.  
 FISH as a manure (J. A. Clarke), 358.  
 FIVE-COURSE rotation in Herefordshire (J. A. Clarke), 334.  
 FIXTURES, claim to composition for, under the Agricultural Holdings Act (Clifford and Foote), 114; conditions of removal, 115.  
 FLEECES, weight of (J. A. Clarke), 223.  
 —, weight of Lincoln (J. A. Clarke), 290.  
 FLOCK, management of the (J. A. Clarke), 249; summer treatment, 255.  
 —, general management of the (W. T. Carrington), 450.  
 FLOODS (J. Caird), 56.  
 FLUCTUATIONS in the supply and price of wheat (J. A. Clarke), 206.  
 FOLDING sheep, advantages of (W. T. Carrington), 449.  
 — in winter (J. A. Clarke), 259.

## FOOD.

- FOOD of fattening cattle (J. A. Clarke), 237.  
 —, home and foreign supply of (J. Caird), 12; proportion in the United Kingdom, 13.  
 —, nitrogen in the, recovered in manure (Dr. Voelcker), 573.  
 — preparing machinery (J. A. Clarke), 370.  
 FOODS, estimated manure-value of (Dr. Voelcker), 573.  
 FOOTE, J. Anderson, on English Land Law, 71.  
 FOOT-ROT (W. T. Carrington), 451.  
 FOREIGN and home food supply (J. Caird), 12; proportion in the United Kingdom, 13.  
 — yields of wheat and barley compared with English (J. A. Clarke), 198; total imports, 205.  
 FORESTS, Her Majesty's revenue from (J. Caird), 64.  
 FORFEITURE of leases (Clifford and Foote), 99.  
 FORMS of agreement (Clifford and Foote), 90.  
 FOUR-COURSE system of cultivation, its advantages (J. Caird), 19.  
 FRANCE, importations of fruit from (C. Whitehead), 482.  
 FREEDOM of contract (Clifford and Foote), 92.  
 — of cropping land (E. P. Squarey), 173.  
 FREE-TRADE, advantages of (J. Caird), 27.  
 FROSTS injurious to hops (C. Whitehead), 465.  
 FRUIT, cultivation of (C. Whitehead), 470.  
 — and hops (J. A. Clarke), 318.  
 FRUIT-BUSHES under standard trees (C. Whitehead), 476.  
 FULCHER, T., on Norfolk and Suffolk polled cattle (J. A. Clarke), 282.  
 FUNCTIONS of Government in our supply of food (J. Caird), 12.

## G.

- GALLOWAY cattle (J. A. Clarke), 285.  
 GARDENS for cottages (H. J. Little), 519.  
 GARTH, J. C., machinery on his farm (J. A. Clarke), 369.  
 GAVELKIND, ancient common law of inheritance (Clifford and Foote), 73.  
 GEOLOGY (J. A. Clarke), 192.  
 GEOLOGICAL formation suitable for hops (C. Whitehead), 458.  
 GILBERT, Dr., experiments on continuous cropping (Dr. Voelcker), 550.

## HEAVY.

- GLOUCESTER cheese (J. C. Morton), 411.  
 GLOUCESTERSHIRE, fruit-land in (C. Whitehead), 475.  
 —, soils and crops of (J. A. Clarke), 331.  
 GOOSEBERRIES (C. Whitehead), 478.  
 GOVERNMENT, its functions in regard to supply of food (J. Caird), 12.  
 — inquiry into the loans made by the State and Land Improvement Companies, 43; results, *ib.*  
 GRAIN, average prices of (J. A. Clarke), 203.  
 GRASS-LAND improved by drainage (J. Caird), 45; by floods, 56.  
 —, increased acreage in Ireland (J. Caird), 16.  
 GRAZING, profit of (W. T. Carrington), 441.  
 — breeds of cattle (J. C. Morton), 382.  
 — calves (J. A. Clarke), 231; ewes and lambs, 255.  
 — cattle in the hilly districts (W. T. Carrington), 439.  
 — farm, proportion of landlord's and tenant's capital in a (E. P. Squarey), 166.  
 — land in Scotland, increase in value and cause (J. Caird), 49.  
 GREENGAGES cultivated in Kent (C. Whitehead), 478.  
 GUANOS (J. A. Clarke), 357.  
 —, imports of (J. A. Clarke), 202.  
 GUERNSEYS (J. A. Clarke), 277.  
 — (J. C. Morton), 399.

## H.

- HAMMELS (J. A. Clarke), 234.  
 HAMPSHIRE, soils and crops of (J. A. Clarke), 322.  
 HAMPSHIRE Downs (W. T. Carrington), 446.  
 — lambs, management of (J. A. Clarke), 255.  
 — sheep (J. A. Clarke), 296.  
 HARDING, Mr., his process of cheese-making (J. C. Morton), 407.  
 HARRISON, J. T., milk produce of a dairy (J. C. Morton), 431.  
 HARVEST wages (H. J. Little), 508.  
 HARVEST-HOME entertainment (H. J. Little), 533.  
 HAY-TEA (J. A. Clarke), 230.  
 HEALTH of dairy cattle, 434.  
 HEASMAN, A., description of Sussex cattle (J. A. Clarke), 274.  
 HEAVY land, management of sheep on (W. T. Carrington), 450.

HEAVY.

HEAVY land rotation in Somersetshire (J. A. Clarke), 331; Warwickshire, 339.  
 HEGAN, J. machinery on his farm (J. A. Clarke), 368.  
 HEIFERS, number in the United Kingdom (J. A. Clarke), 213.  
 HER MAJESTY'S Woods, Forests, and Land Revenue (J. Caird), 64.  
 HERDWICKS (J. A. Clarke), 305.  
 HEREFORDS (J. A. Clarke), 269.  
 — (J. C. Morton), 395.  
 — (W. T. Carrington), 442.  
 HEREFORDSHIRE, apple and pear orchards in (C. Whitehead), 472.  
 — farm (J. C. Morton), 395.  
 — hop plantations (C. Whitehead), 459.  
 —, soils and crops of (J. A. Clarke), 334.  
 HIGHWAY rates (Capt. Craigie), 148.  
 HILL farms, management of sheep on (W. T. Carrington), 451.  
 HINE, Mr., design for cottages (H. J. Little), 517.  
 HOME production of wheat (J. A. Clarke), 203; of meat, 210; of wool, 221.  
 — and foreign supply of food (J. Caird), 12.  
 HOMESTEADS, noted (J. A. Clarke), 367.  
 HOP-DIGGING machine (C. Whitehead), 461.  
 HOPS (J. A. Clarke), 318.  
 —, cultivation of (C. Whitehead), 457.  
 HORSE-BREEDING (J. A. Clarke), 311.  
 HORSES (J. A. Clarke), 200; number compared with foreign countries, 201.  
 — (J. A. Clarke), 311.  
 — (H. M. Jenkins), 612.  
 — for farm work (J. A. Clarke), 363; cost, 365.  
 HORSFALL, Mr., his practice of preparing cattle food (J. A. Clarke), 241.  
 HOUSE lambs, raising and fattening (J. A. Clarke), 253.  
 HOUSING and feeding cattle during winter (J. A. Clarke), 232.  
 — young cattle (W. T. Carrington), 439.  
 HOWARD, James, on the advance in the price of meat (J. A. Clarke), 210.  
 HOWMAN, Henry, on covered yards (J. A. Clarke), 235.  
 — on fattening yearlings (J. A. Clarke), 247.  
 HURDLES (J. A. Clarke), 260.  
 HUSBANDRY, covenants in leases, as to (Clifford and Foote), 96.  
 HYDROGRAPHY (J. A. Clarke), 190.

IRISH.

I.

ILLUSTRATIONS, 385, 393, 394, 397, 398, 399, 400, 461, 463, 465, 466, 478, 479, 517.  
 IMMIGRANTS as hop-pickers (C. Whitehead), 467.  
 IMPERIAL direct taxes (Capt. Craigie), 138.  
 IMPLEMENTS of agriculture (E. P. Squarey), 169.  
 —, exhibition of (H. M. Jenkins), 603.  
 — for working hop-lands (C. Whitehead), 464.  
 — used in the dairy (J. C. Morton), 429.  
 IMPORT of Irish store cattle (W. T. Carrington), 441.  
 IMPORTATION of fruit (C. Whitehead), 482; potatoes, 489.  
 — of meat from America (J. Caird), 13.  
 IMPROVEMENT of land, Companies for the (E. P. Squarey), 175.  
 IMPROVEMENTS under the Agricultural Holdings Act (Clifford and Foote) 104; second-class, 107; third-class, 108.  
 INCLOSURE Commission, the only State department (J. Caird), 55; its functions, *ib.*  
 INCOME and capital of landowners (Capt. Craigie), 125; tenants, *ib.*  
 — tax (Capt. Craigie), 141.  
 INCUMBRANCES hinder free action of many landowners in the management of their property (J. Caird), 42; expedients adopted to overcome this, *ib.*  
 INDIA, a source of our future corn supply (J. Caird), 14.  
 INDIAN corn, amount imported in 1876 (J. Caird), 18.  
 INFLUENCE of the landowners (J. Caird), 33.  
 — of Chemical Discoveries on English Agriculture (Dr. Voelcker), 541.  
 INSECTS destructive to hop-plants (C. Whitehead), 465.  
 IRELAND, diminution of corn and increase of grass in (J. Caird), 16; its agricultural prosperity, *ib.*  
 —, result of the potato famine in the population of (J. Caird), 30; decrease of small holdings on the return of prosperity, 31; the peasant proprietors, 32.  
 — tenancy in (J. Caird), 39.  
 IRISH dairy husbandry (J. C. Morton), 427.  
 — Land Act, provisions of the (J. Caird), 32; agitation which led to its being passed, 41.

## IRISH.

- IRISH peasant-farmers (H. J. Little), 501.  
 — rates (Capt. Craigie), 150.  
 — store cattle, import of (W. T. Carrington), 441.  
 IRRIGATION (E. P. Squarey), 166.  
 — by town sewage (C. Whitehead), 492.  
 — unfit for clay soils (Dr. Voelcker), 567.

## J.

- JAM making, fruit used for (C. Whitehead), 482.  
 JENKINS, H. M., F.G.S., on the Royal Agricultural Society of England, 593.  
 JERSEYS (J. A. Clarke), 277.  
 — (J. C. Morton), 399.  
 JONAS, S., his practice of preparing cattle food (J. A. Clarke), 246.  
 JONES, W. Bence, on Irish dairy husbandry (J. C. Morton), 427.  
 JOURNAL of the Royal Agricultural Society (H. M. Jenkins), 623.  
 JUDGING by points (J. A. Clarke), 279.  
 JURISDICTION of county courts under the Agricultural Holdings Act (Clifford and Foote), 113.  
 JUSTICES in quarter sessions administer county rates (Capt. Craigie), 149.

## K.

- KENNEDY, Mr., his practice of cooking cattle food (J. A. Clarke), 239.  
 KENT, acreage of hops in (C. Whitehead), 458.  
 —, law of gavelkind still lingers in (Clifford and Foote), 74.  
 —, soils and crops of (J. A. Clarke), 316.  
 KERRY cattle (J. C. Morton), 400.  
 KILNS for drying hops (C. Whitehead), 467.  
 KNIFING (J. A. Clarke), 374.

## L.

- LABOUR, cost of (E. P. Squarey), 170.  
 — on good soil less costly than on poor clay (J. Caird), 25.  
 — in market gardens (C. Whitehead), 487.  
 — unions (H. J. Little), 505.  
 LABOURER, the Agricultural (H. J. Little), 499.  
 —, earnings of the (Capt. Craigie), 126; proportion of taxation, 133.

## LANDOWNERS.

- LABOURER, education of the (H. M. Jenkins), 626.  
 LABOURERS, experience and education (J. Caird), 35; position improving, *ib.*; emigration, 36; wages, *ib.*; general condition, *ib.*  
 LABOURERS' cottages (E. P. Squarey), 168.  
 — when judiciously placed are remunerative (J. Caird), 46.  
 LAMBING-EWES, treatment of (J. A. Clarke), 251.  
 LAMBING season (W. T. Carrington), 448.  
 — twice in the year (J. A. Clarke), 249.  
 LANCASHIRE cheese (J. C. Morton), 413.  
 —, soils and crops of (J. A. Clarke), 352.  
 LAND Act in Ireland, provisions of the (J. Caird), 32.  
 — agents (J. Caird), 34.  
 — drainage, *see* "Drainage."  
 —, examples of improvements in (J. Caird), 47; very remunerative, 48.  
 —, exchange of, inexpensive and simple (J. Caird), 57; extent, *ib.*  
 — Improvement Companies (E. P. Squarey), 175.  
 — (J. Caird), 42; amount of money advanced, 43.  
 —, increase in the value of (J. Caird), 24.  
 — in the United Kingdom principally cultivated by tenant-occupiers (J. Caird), 29.  
 — Law (Clifford and Foote), 71.  
 —, percentage of cultivated, in foreign countries (J. A. Clarke), 201.  
 —, systems of tenancy in England, Scotland, and Ireland (J. Caird), 38.  
 — tax (Capt. Craigie), 139.  
 —, uncultivated, distribution of (J. A. Clarke), 194.  
 LANDED property, distribution of (J. Caird), 27.  
 LANDLORD'S capital (E. P. Squarey), 163.  
 — covenants in leases (Clifford and Foote), 98.  
 — taxation (Capt. Craigie), 154.  
 LANDOWNER, education of (H. M. Jenkins), 625.  
 LANDOWNERS, advantages and disadvantages of yearly tenancies to the (Clifford and Foote), 85; effect upon tenants, 86.  
 —, capital and income of (Capt. Craigie), 125.  
 —, proportion of, to the whole population (J. Caird), 28; do not generally cultivate their land, 29; their position, duties, and influence, 33.

LANDOWNERS.

- LANDOWNERS in Scotland specially trained (J. Caird), 50.
- LANE, Mr., his system of extra cropping (J. A. Clarke), 340.
- LARGE-BREED white pigs (J. A. Clarke), 309.
- LAWES, J. B., experiments on continuous cropping (Dr. Voelcker), 550.
- , experimental station at Rothamsted (Dr. Voelcker), 581.
- , table of money-value of articles of food (Dr. Voelcker), 575.
- , value of his experiments to British agriculture (J. Caird), 20.
- LAWRENCE, C., his practice of preparing cattle food (J. A. Clarke), 240.
- LEA, John, his farm management (J. C. Morton), 388.
- LEASEHOLD interests considered as personality (Clifford and Foote), 79.
- LEASES (Clifford and Foote), 94; powers of life tenants, *ib.*; legal effect, 95.
- in Scotland (J. Caird), 40.
- LEGACY duty (Capt. Craigie), 138.
- LEGAL effect of leases (Clifford and Foote), 93.
- LEICESTER, Earl of, improvements in Norfolk (J. A. Clarke), 344.
- sheep (J. A. Clarke), 286.
- LEICESTERS (W. T. Carrington), 445.
- LICENSING Acts (H. J. Little), 533.
- LIFE of the agricultural labourer (H. J. Little), 530.
- , tenancy for (Clifford and Foote), 79.
- LIGHT land, management of sheep on (W. T. Carrington), 447.
- lands of Shropshire (J. A. Clarke), 338.
- LIME, use of (Dr. Voelcker), 546.
- LIMING (J. A. Clarke), 359.
- LINCOLN sheep (J. A. Clarke), 289.
- (W. T. Carrington), 445.
- LINCOLNSHIRE, effect of local customs in (Clifford and Foote), 101.
- , soils and crops of (J. A. Clarke), 345.
- LINSEED-CAKE (Dr. Voelcker), 571.
- LIQUORICE (J. A. Clarke), 351.
- (C. Whitehead), 486.
- LITTLE, H. J., on the farm labourer, 499.
- LIVE animals, difficulties of importing (J. Caird), 13.
- LIVERPOOL prize farms (J. A. Clarke), 352.
- LIVE-STOCK (E. P. Squarey), 170.
- , census of (J. A. Clarke), 198; density of summer stocking in proportion to cultivated area, 199; comparison with foreign countries, 201.
- of the country (J. C. Morton), 382.
- , exhibition of (H. M. Jenkins), 609.

MEAT.

- LIVE-STOCK, number of, in the United Kingdom in 1877 (J. Caird), 16; buildings for, 45.
- LOANS for improvement of land, repayment of (E. P. Squarey), 176.
- from State and Land Improvement Companies and reclamation of land (J. Caird), 42.
- LOCAL customs (Clifford and Foote), 87.
- rates (Capt. Craigie), 143.
- LOCUST-BEANS (Dr. Voelcker), 572.
- LONDON market, advance in the price of meat in the (J. A. Clarke), 209.
- LONGHORNS (J. A. Clarke), 275.
- (J. C. Morton), 392.
- LONG breed of sheep (J. A. Clarke), 305.
- LOW-LYING grass, management of sheep on (W. T. Carrington), 450.
- M.**
- MACHINERY, treatment of, under the Agricultural Holdings Act (Clifford and Foote), 115.
- MAIN Drainage Commissions (J. Caird), 55.
- MAIZE, imports for feeding (J. A. Clarke), 202.
- MALT tax (Capt. Craigie), 135.
- MANAGEMENT of the Royal Agricultural Society (H. M. Jenkins), 594.
- MANGOLD crop, increase in the cultivation of (J. Caird), 15.
- MANORS (Clifford and Foote), 72.
- MANUFACTURE of cheese (J. C. Morton), 407; butter, 423.
- MANURE, farming without (J. A. Clarke), 360.
- , nitrogen in the food recovered in (Dr. Voelcker), 573.
- for hop plantations (C. Whitehead), 464.
- MANURE-VALUE of foods (Dr. Voelcker), 573.
- MANURES (E. P. Squarey), 170.
- (J. A. Clarke), 354.
- (Dr. Voelcker), 556.
- effect of, in continuous corn crops (Dr. Voelcker), 552.
- value of, in the fertility of soils (J. Caird), 26.
- MAP, statistical (J. A. Clarke), 194.
- MARKET-GARDENING, introduction into England (C. Whitehead), 483.
- MARKET gardens (J. A. Clarke), 317, 320.
- MARL, use of (Dr. Voelcker), 546.
- MARLING (J. A. Clarke), 358.
- MARTIN, James, design for cottages (H. J. Little), 514.
- MEAT, rise in the value of (J. Caird), 12;



## MEAT.

- importation from America will check the rise of price in Europe, 13.
- MEAT, advances in the price of (J. A. Clarke), 209; home supply, 212; foreign animals imported, *ib.*; importation of dead meat, 218.
- , consumption of, by labourer (H. J. Little), 507.
- MECHI, J. J., his practice of preparing food (J. A. Clarke), 245.
- MEDICINE and dressing for sheep (J. A. Clarke), 261.
- MEMBERS, number of, 1841-77 (H. M. Jenkins), 598.
- MERTON Southdowns (J. A. Clarke), 296.
- METROPOLIS, cultivation of vegetables round the (C. Whitehead), 483.
- METROPOLITAN milk supply (J. C. Morton), 404; cheese trade, 420.
- MIDDLE classes, taxation of the (Capt. Craigie), 135.
- MIDDLE-BREED white pigs (J. A. Clarke), 311.
- MIDDLE-MEN in Ireland, and consequent evils (J. Caird), 41.
- MIDDLESEX, temperature of (J. A. Clarke), 186.
- , soils and crops of (J. A. Clarke), 319.
- MILITARY tenures abolished (Clifford and Foote), 73.
- MILK, calf-rearing on (J. C. Morton), 401.
- produce (J. C. Morton), 381.
- , the sale of (J. C. Morton), 404.
- substitutes for calves (J. A. Clarke), 230.
- supplied to labourers (H. J. Little), 521.
- MILKERS, the Longhorns as (J. A. Clarke), 277.
- MINING industry (H. J. Little), 503.
- MIXED farm, proportion of landlord's and tenant's capital on a (E. P. Squarcy), 165.
- MONEY payment in lieu of tithes (J. Caird), 62.
- value of foods (Dr. Voelcker), 575.
- MONTGOMERY Act, its origin (J. Caird), 50.
- MOORE, H. F., metropolitan cheese trade (J. C. Morton), 420.
- MORTMAIN, law of (Clifford and Foote), 82.
- MORTON, J. Chalmers, on Dairy Farming, 381.
- , on dairy products (J. A. Clarke), 220; money value of roots, 238.
- MOUNTAIN shelter for sheep (J. A. Clarke), 261

## ONIONS.

- MOWING-MACHINES (J. Caird), 18.
- (J. A. Clarke), 376.
- MULES (J. A. Clarke), 365.
- N.
- NATIONAL income (Capt. Craigie), 127.
- schools (H. J. Little), 529.
- NATURAL History department of the Royal Agricultural Society (H. M. Jenkins), 619.
- NETS for folding sheep (J. A. Clarke), 260.
- NEW Red sandstone, rotations on the (J. A. Clarke), 330.
- NIDGETT for working hop-lands (C. Whitehead), 464.
- NIGHT schools (H. J. Little), 527.
- NITRATE of soda (Dr. Voelcker), 561, 563.
- , its importance in time of war (J. Caird), 19; value to corn crops, 20.
- , imports of (J. A. Clarke), 202.
- NITROGEN, powers of (Dr. Voelcker), 556; sources of, in vegetation, 557; from the atmosphere, *ib.*
- in food recovered in manure (Dr. Voelcker), 573.
- NITROGENOUS manures (Dr. Voelcker), 563.
- NORFOLK, Mr. C. S. Read, M.P., on summer and winter stock of (J. A. Clarke), 199.
- , soils and crops of (J. A. Clarke), 343.
- NORFOLK polled cattle (J. A. Clarke), 281.
- (J. C. Morton), 398.
- NORTH Riding of Yorkshire, soils and crops of (J. A. Clarke), 350.
- NORTHUMBERLAND, wages in (H. J. Little), 520.
- NOTICE to quit under the Agricultural Holdings Act (Clifford and Foote), 113.
- NOTTINGHAM, temperature of (J. A. Clarke), 186.
- O.
- OAST-HOUSES for hops (C. Whitehead), 467.
- OATS, average prices, 1861-76 (J. A. Clarke), 203.
- OBJECTS of the Royal Agricultural Society (H. M. Jenkins), 594.
- OILCAKE, advantages of (W. T. Carrington), 440.
- , consumption of (J. A. Clarke), 202.
- OLD English horses (J. A. Clarke), 314.
- ONIONS (C. Whitehead), 457



OOLITE.

- OOLITE district of Wiltshire (J. A. Clarke), 327.  
 OPEN yards for cattle (J. A. Clarke), 232.  
 ORCHARDS, cost of raising (C. Whitehead), 476.  
 OUTGOING tenants, payments to (Clifford and Foote), 98.  
 OWNERSHIP of land (Clifford and Foote), 71.  
 OXFORDSHIRE, soils and crops of (J. A. Clarke), 336.  
 — Downs (J. A. Clarke), 298.  
 — (W. T. Carrington), 446.  
 OX-TEAMS (J. A. Clarke), 362.

P.

- PARISH clergy, number of (J. Caird), 63.  
 PARLIAMENTARY recognition of tenant's rights (Clifford and Foote), 102.  
 PAROCHIAL clubs (H. J. Little), 525.  
 PASTORAL Husbandry (W. T. Carrington), 435.  
 PASTURE land, distribution of (J. A. Clarke), 195.  
 —, increase in the acreage of (J. Caird), 15.  
 PASTURES, improvement of (Dr. Voelcker), 568.  
 PEAR orchards in Herefordshire (C. Whitehead), 472.  
 PEAS (J. A. Clarke), 341.  
 —, imports for feeding (J. A. Clarke), 202.  
 PEASANT farmers in Ireland (H. J. Little), 501.  
 — proprietors in Ireland (J. Caird), 32.  
 PEDIGREE herd, management of (W. T. Carrington), 436.  
 PEERAGE, land held by the (J. Caird), 29.  
 PEMBROKESHIRE cattle (J. A. Clarke), 283.  
 PERMANENT fertility (Dr. Voelcker), 549.  
 — improvements, costs of, charged on lands (Clifford and Foote), 81; compensation awarded for, under the Agricultural Holdings Act, 104; presumed duration, *ib.*  
 — pastures, improvement of (Dr. Voelcker), 568.  
 PERQUISITES to labourers (H. J. Little), 510.  
 PERRY (C. Whitehead), 473.  
 PERSONAL property, leaseholds considered (Clifford and Foote), 79.  
 PERSONS, numbers admitted to the country meetings of the Society, 1853-77 (H. M. Jenkins), 602.

PRIZES.

- PERUVIAN guano, *see* "Guano."  
 PHOSPHATIC materials (Dr. Voelcker), 562.  
 PHYSICAL features of England (J. A. Clarke), 185.  
 — of Great Britain (H. J. Little), 500.  
 PICKING hops (C. Whitehead), 467.  
 PICKLE manufacturers (C. Whitehead), 487.  
 PIECEWORK (H. J. Little), 507.  
 PIGS (J. A. Clarke), 306.  
 —, management of (J. A. Clarke), 263.  
 PLANS, 389, 514, 515, 516, 518, 519, 523.  
 PLANTS predominating in uncultivated land (J. Caird), 27.  
 PLOUGH (double-furrow) (J. Caird), 19.  
 PLOUGHING matches (H. J. Little), 528.  
 PLOUGHS and cultivators (J. A. Clarke), 370.  
 POINTS, judging by (J. A. Clarke), 279.  
 — of a Hereford (J. A. Clarke), 269; Devon, 272; Sussex, 275; Longhorns, 276.  
 POLICE rates (Capt. Craigie), 149.  
 POLING hops (C. Whitehead), 461.  
 POLITICS, exclusion of, from Society (H. M. Jenkins), 594.  
 POOR, improvement of cottages for the (H. J. Little), 512.  
 POOR-LAW allowances (H. J. Little), 502; Scotland exempt, 503.  
 POOR-RATE (Capt. Craigie), 144; origin, 145; fluctuations, *ib.*; purposes, 145; local distribution, 146.  
 POPULATION, checks on increase of (J. Caird), 29.  
 —, the proportion of landowners to the (J. Caird), 28.  
 POST Office savings-banks (H. J. Little), 527.  
 POTASH salts (Dr. Voelcker), 563.  
 POTATO culture (C. Whitehead), 488.  
 — in Cornwall (J. A. Clarke), 329; Cheshire, 351.  
 — disease (C. Whitehead), 491.  
 — famine in Ireland, results on the population (J. Caird), 30.  
 POULTRY (J. A. Clarke), 224.  
 PRACTICAL Agriculture (J. A. Clarke), 185.  
 PRESSING machine for hops (C. Whitehead), 468.  
 PRICES of Shorthorns (J. A. Clarke), 266.  
 PRIMROGENTURE law, limited operation of (Clifford and Foote), 74.  
 PRIZE cottages (H. J. Little), 514.  
 — farms round Liverpool (J. A. Clarke), 352.  
 PRIZES for best cultivated farms (H. M. Jenkins), 613.

## PROBATE.

- PROBATE duty (Capt. Craigie), 138.  
 PROCEDURE in establishing claims under the Agricultural Holdings Act (Clifford and Foote), 111.  
 PROPERTY, agricultural share of taxes on (Capt. Craigie), 136.  
 — tax (Capt. Craigie), 141.  
 PROUT, Mr., continuous corn growing (Dr. Voelcker), 553.  
 PROVIDENT Societies (H. J. Little), 524.  
 PRUNING gooseberry trees (C. Whitehead), 478; filbert trees, 479.  
 PUBLIC roads (J. Caird), 59.  
 PUBLIC-HOUSE clubs (H. J. Little), 526.  
 PULPING roots (J. A. Clarke), 242.

## R.

- RADNOR sheep (J. A. Clarke), 302.  
 RAFTERING (J. A. Clarke), 332.  
 RAIN, effect of, on top-dressings of ammoniacal manures (Dr. Voelcker), 545.  
 RAINFALL (J. A. Clarke), 186.  
 — (Dr. Voelcker), 582.  
 — of the United Kingdom (J. Caird), 25.  
 RAM, age for breeding (J. A. Clarke), 250.  
 RANDELL, C., his practice of preparing cattle food (J. A. Clarke), 243.  
 —, his practice of wintering sheep (J. A. Clarke), 262.  
 RATES, share of, levied on land (Capt. Craigie), 143.  
 RAWLENCE, Mr., management of sheep (J. A. Clarke), 256.  
 READ, C. S., M.P., on summer and winter stock of Norfolk (J. A. Clarke), 199.  
 —, on store pigs (J. A. Clarke), 265.  
 —, on extra crops in the Chiltern district (J. A. Clarke), 336.  
 REAPING-MACHINES (J. Caird), 18.  
 — (H. J. Little), 508.  
 REARING live stock (Dr. Voelcker), 570.  
 RECEIPTS and expenditure of the Society, 1841-77 (H. M. Jenkins), 598.  
 RECLAMATION of lands by State loans (J. Caird), 42.  
 RECREATION of the labourer (H. J. Little), 530.  
 REFEREES, powers of, under the Agricultural Holdings Act (Clifford and Foote), 111.  
 REFORM Bill, its benefit to tenant farmers (J. Caird), 39.  
 RELIGION in England supported by tithes (J. Caird), 62.  
 RENT of land (E. P. Squarey), 174.  
 —, pressure of income tax on (Capt. Craigie) 141.

## SCHOOLS.

- RENTS of market gardens (C. Whitehead), 487.  
 REVENUE of Her Majesty from woods, forests, and land (J. Caird), 64.  
 RICE-MEAL (Dr. Voelcker), 572.  
 ROADS connected with enclosures (J. Caird), 59.  
 ROMNEY Marsh (J. A. Clarke), 318; sheep management, *ib.*  
 — sheep (J. A. Clarke), 291.  
 ROOTS for fattening cattle (J. A. Clarke), 237; value of roots, 238.  
 —, pulping of (J. A. Clarke), 242.  
 —, storing, cleaning, and cutting (J. A. Clarke), 260.  
 —, consumption by sheep (W. T. Carrington), 449.  
 ROOT-CROPS, beneficial results of bone-dust (Dr. Voelcker), 547, 564.  
 ROTATION on heavy lands in the North (J. A. Clarke), 316.  
 — where potatoes are grown (C. Whitehead), 490.  
 — experiments at Woburn (Dr. Voelcker), 586.  
 ROTHAMSTED field experiments (Dr. Voelcker), 542, 568.  
 — experimental station (Dr. Voelcker), 581.  
 ROYAL Agricultural Society of England (H. M. Jenkins), 593.  
 RUCK, E., his system of farming (J. A. Clarke), 374.  
 —, Henry, his method of rearing calves (J. A. Clarke), 230.  
 RUSSELL, Mr., his practice of preparing cattle food (J. A. Clarke), 239.  
 RUSTON, A. S., his practice of wintering sheep (J. A. Clarke), 262.  
 RYE (J. A. Clarke), 337.  
 RYLAND sheep (J. A. Clarke), 294.
- S.
- SAINFOIN (J. A. Clarke), 325.  
 SAINFOIN-ROOTS, allowance for (E. P. Squarey), 177.  
 SALINE alkaline materials (Dr. Voelcker), 563.  
 SALT as a manure (Dr. Voelcker), 564.  
 SANDY soils, value of lime on (Dr. Voelcker), 546.  
 SANITARY rates (Capt. Craigie), 149.  
 SAVINGS-BANKS (H. J. Little), 526.  
 SCHOOL Board-rate (Capt. Craigie), 150.  
 SCHOOL fees for labourers' children (H. J. Little), 529.  
 SCHOOLS for labourers' children (J. Caird), 35

SCIENTIFIC.

SCIENTIFIC researches, influence of (Dr. Voelcker), 541.  
 SCOTCH breeds of cattle (J. A. Clarke), 284.  
 — experimental stations (Dr. Voelcker), 581.  
 — landowner, his advantages (J. Caird), 50.  
 — mountain sheep (J. A. Clarke), 304.  
 — shepherds (H. J. Little), 500.  
 SCOTLAND, assessment of property to Poor-rate in (Capt. Cragie), 150.  
 — climate unfavourable for fruit-growing (C. Whitehead), 481.  
 — exempt from Poor-law allowances (H. J. Little), 503.  
 — mode of tenancy in (J. Caird), 38; leases, 40.  
 — rise in value of land in (J. Caird), 49; cause, *ib.*  
 SEA-KALE (C. Whitehead), 486.  
 SEASON, effect of, on the wheat crop (J. A. Clarke), 196.  
 SEASONS chosen for calving (J. A. Clarke), 225.  
 SEAWEED as a manure (J. A. Clarke), 358.  
 SETTLEMENTS of estates, origin of (Clifford and Foote), 76; not prescribed by law, 77.  
 — often hinder the free action of landowners in the management of their property, 42; expedients adopted to overcome this, *ib.*; should be limited, 53.  
 SEWAGE and sewage manures (Dr. Voelcker), 564, 583.  
 SHEARING (J. A. Clarke), 256; time, 258.  
 SHED-FEEDING sheep (J. A. Clarke), 263.  
 SHEEP (J. A. Clarke), 200; number compared with foreign countries, 201.  
 — dipping (J. A. Clarke), 258.  
 — folding in Wiltshire (J. A. Clarke), 327.  
 — influence of climate on (W. T. Carrington), 444.  
 — shearing (J. A. Clarke), 258.  
 — washing (J. A. Clarke), 258.  
 SHEPHERD'S hut (J. A. Clarke), 261.  
 — in Scotland (H. J. Little), 500.  
 SHEPPEY, Isle of, crops in (J. A. Clarke), 316.  
 SHIRE-BRED horses (J. A. Clarke), 314.  
 SHORTHORNS (W. T. Carrington), 436.  
 — (J. A. Clarke), 266.  
 — (J. C. Morton), 384.  
 SHROPSHIRE, soils and crops of (J. A. Clarke), 338.  
 — sheep (H. M. Jenkins), 611.  
 SHROPSHIRE (W. T. Carrington), 446.  
 — (J. A. Clarke), 299.  
 SKIM-MILK, calf-rearing on (J. C. Morton), 402.

STEAM-ENGINES.

SMALL-BREED white pigs (J. A. Clarke), 310.  
 SMITH, William, his clay-land husbandry (J. A. Clarke), 374.  
 —, Worthington, on the potato disease (C. Whitehead), 491.  
 SOIL, effect on foul liquids (Dr. Voelcker), 564.  
 — of England, variation in the (W. T. Carrington), 435.  
 — of the United Kingdom (J. Caird), 25  
 SOILS, distribution of (J. A. Clarke), 193.  
 —, chemical composition of (Dr. Voelcker), 543; absorbent power, *ib.*  
 —, examples in the fertility of (J. Caird), 26.  
 SOMERSETSHIRE, fertility of land in (J. Caird), 26.  
 —, fruit land of (C. Whitehead), 474.  
 —, soils and crops of (J. A. Clarke), 330.  
 SOUTHDOWNS (W. T. Carrington), 446.  
 — (J. A. Clarke), 295.  
 SOUTH HAMS cattle (J. A. Clarke), 274.  
 SOVEREIGN'S power over the land (Clifford and Foote), 71.  
 SPIRITS, distillation of, from beet-roots (Dr. Voelcker), 578.  
 SPRING season destructive to fruit trees (C. Whitehead), 475.  
 SPRING-CALVING (J. A. Clarke), 226.  
 SPUDS for hop digging (C. Whitehead), 461.  
 SQUAREY, Elias P., on Farm Capital, 163.  
 —, on Hampshire Down sheep (J. A. Clarke), 297.  
 STAFFORDSHIRE dairy farm (J. C. Morton), 386.  
 STALL-FEEDING (J. A. Clarke), 233.  
 STAMPS on deeds (Capt. Craigie), 138.  
 STATE loans for drainage and reclamation of estates (J. Caird), 42; rate of repayment, *ib.*  
 — schools or flocks, none in England (J. Caird), 54.  
 STATISTICAL agriculture (J. A. Clarke), 185.  
 — diagram map (J. A. Clarke), 194.  
 STATISTICS of dairy factories (J. C. Morton), 417.  
 — of the United Kingdom (J. Caird), 14; accuracy sufficient for practical use, 15; main features, *ib.*  
 STATUTE *De Donis*, when passed, and result (Clifford and Foote), 75.  
 STEAM cultivation (H. M. Jenkins), 607.  
 — (Dr. Voelcker), 554.  
 STEAM-ENGINES, erection of, under the Agricultural Holdings Act (Clifford and Foote), 115.

## STEAMING.

- STEAMING chaff (J. A. Clarke), 245.  
 STEAM-PLOUGH, use of the (J. Caird), 18.  
 STEAM-PLOUGHS, and cultivators (J. A. Clarke), 370.  
 STEAM-POWER (J. A. Clarke), 366.  
 — and manipulation of crops (J. Caird), 19.  
 STIES, arrangements and fittings (J. A. Clarke), 264.  
 STILTON cheese (J. C. Morton), 419.  
 STOCK, feeding and rearing (Dr. Voelcker), 570.  
 —, number exhibited at the Society's country meetings, 1841-77 (H. M. Jenkins), 602.  
 — of the farm, *see* "Live Stock."  
 STORE pigs, management of (J. A. Clarke), 265.  
 STORING roots (J. A. Clarke), 260.  
 — straw-chaff (J. A. Clarke), 245.  
 STRAFFORD, H., description of a Short-horn (J. A. Clarke), 268.  
 STRAW for feeding (J. A. Clarke), 244.  
 STRAW-CHAFF, storing (J. A. Clarke), 245.  
 SUBSCRIPTIONS, amount of, received from members, 1841-77 (H. M. Jenkins), 598.  
 SUBURBAN milk dairies (J. C. Morton), 406.  
 SUCCESSION duty (Capt. Craigie), 138.  
 — and ownership of land (Clifford and Foote), 71.  
 SUCCESSIVE corn crops (J. Caird), 19; use in time of war, *ib.*  
 SUCKLING of calves (J. A. Clarke), 228.  
 SUFFOLK cart-horses (J. A. Clarke), 312.  
 — pigs (J. A. Clarke), 309.  
 — polled cattle (J. A. Clarke), 281.  
 — soils, and crops of (J. A. Clarke), 342.  
 —, temperature of (J. A. Clarke), 186.  
 SUGAR, manufacture of, from beet-roots (Dr. Voelcker), 577.  
 SULPHATE of copper used in pickles (C. Whitehead), 487.  
 SULPHURING machine for hops (C. Whitehead), 466.  
 SUMMER prices of meat for twenty-six years (J. A. Clarke), 209.  
 SUPERPHOSPHATE of lime (J. A. Clarke), 357.  
 SURREY hop plantations (C. Whitehead), 459.  
 —, soils and crops of (J. A. Clarke), 320.  
 SUSSEX cattle (J. A. Clarke), 274.  
 — cattle (J. C. Morton), 398.  
 — hop plantations (C. Whitehead), 459.  
 —, soils and crops of (J. A. Clarke), 320.

## TRANSFER.

## T.

- TABLE showing comparative quantity and value of home and foreign agricultural produce consumed annually (J. Caird), 17.  
 TAMWORTH pigs (J. A. Clarke), 308.  
 TAXATION as affecting the Agricultural Interest (Capt. Craigie), 123.  
 TEESWATER Longwools (J. A. Clarke), 291.  
 TEMPERATURE (J. A. Clarke), 186.  
 — of the United Kingdom (J. Caird), 25.  
 TENANCIES, yearly (Clifford and Foote) 83; advantages and disadvantages to landowners, 85.  
 TENANCY at will, system in England (J. Caird), 38; its origin, 39.  
 — for life (Clifford and Foote), 79; at will, 84.  
 TENANT-FARMERS, extent of their holdings and emulation amongst them (J. Caird), 34; number and capital, *ib.*; best examples of farming found among them, 38.  
 —, numbers and vested interests (J. Caird), 28; cultivate the great bulk of the land, 29.  
 —, assessment of, to income tax (Capt. Craigie), 142.  
 TENANT'S capital and income (Capt. Craigie), 126.  
 — (E. P. Squarey), 169.  
 — covenants in leases (Clifford and Foote), 95; as to husbandry, 96; end of tenancy, 97.  
 — title to compensation under the Agricultural Holdings Act (Clifford and Foote), 103.  
 TENURE of land (Clifford and Foote), 71.  
 THANET, Isle of, crops in the (J. A. Clarke), 317.  
 THRIFT among labourers (H. J. Little), 535.  
 TILLAGES, allowance for (E. P. Squarey), 177.  
 TITHES for supporting religion (J. Caird), 62; commuted to a money payment, *ib.*  
 TOLLS for maintaining roads (Capt. Craigie), 148.  
 TOMATOES (C. Whitehead), 487.  
 TOWN sewage, application of, to the growth of vegetables (C. Whitehead), 492.  
 —, disposal of (Dr. Voelcker), 564, 583.  
 TRADE and colonies dispense with checks on increase of population (J. Caird), 29.  
 TRANSFER of land, right of (Clifford and Foote), 72.

TREFOIL.

- TREFOIL (J. A. Clarke), 337.  
 TRIAL, implements for, at the Society's Shows (H. M. Jenkins), 605.  
 TRIFOLIUM (J. A. Clarke), 337.  
 TURNIPS (J. A. Clarke), 340.  
 —, two successive crops (J. A. Clarke), 325.  
 TURNPIKE Trusts (Capt. Craigie), 148.  
 TYING hop-bines (C. Whitehead), 464.

U.

- UMPIRE, election of, under the Agricultural Holdings Act (Clifford and Foote), 111.  
 UNCULTIVATED lands, distribution of (J. A. Clarke), 194.  
 UNEXHAUSTED improvements, under the Agricultural Holdings Act (Clifford and Foote), 103.  
 UNION Chargeability Act (H. J. Little), 513.  
 — of labourers (H. J. Little), 506; its effects, *ib.*  
 UNITED Kingdom, estimated production and consumption of wheat in the (J. A. Clarke), 205.  
 —, proportion of home and foreign supply of food in the (J. Caird), 13.  
 —, variations in the systems of local rateage in the (Capt. Craigie), 149.  
 UNMARRIED labourers (H. J. Little), 512.  
 UPLAND pastures, sheep on (W. T. Carrington), 452.  
 UPPER classes, taxation of the (Capt. Craigie), 134.

V.

- VALUE of land as an investment (E. P. Squarey), 173.  
 VEAL, number of calves killed for (J. A. Clarke), 214.  
 VEGETABLES, cultivation of (C. Whitehead), 483.  
 VEGETATION, experiments on (Dr. Voelcker), 582.  
 —, sources of nitrogen in (Dr. Voelcker), 557.  
 VETCHES (J. A. Clarke), 337.  
 VETERINARY department of the Royal Agricultural Society (H. M. Jenkins), 620; examinations, 625.  
 VILLAGE clubs (H. J. Little), 527.  
 VINERY system of poling hops (C. Whitehead), 463.  
 VOELCKER, Dr. Augustus, on the influence of Chemical Discoveries on the progress of English Agriculture, 541.

WHEAT-LAND.

W.

- WAGES of the agricultural labourer (J. Caird), 36.  
 — in 1796 compared with 1850 and 1870 (H. J. Little), 504; present time, 507.  
 — of the labourer (Capt. Craigie), 126.  
 WALES, fruit-land in (C. Whitehead), 481.  
 WAR, importance of artificial manures in time of (J. Caird), 19.  
 WARNES, Mr., his practice of cooking cattle food (J. A. Clarke), 238.  
 WARF land in Yorkshire (C. Whitehead), 489.  
 WARWICKSHIRE, soils and crops of (J. A. Clarke), 339.  
 WASHING sheep (J. A. Clarke), 258.  
 WASTE lands and commons (J. Caird), 57; extent, 57.  
 WATER-POWER (J. Caird), 56.  
 — (J. A. Clarke), 365.  
 WATERSHEDS, description of, in England and Wales (J. A. Clarke), 190.  
 WEANING calves (J. A. Clarke), 231; lambs, 256.  
 — lambs (W. T. Carrington), 448.  
 WEIGHT and relative value of corn crops (J. Caird), 25.  
 WEIGHTS of Shorthorns (J. A. Clarke), 269.  
 WELSH breeds of cattle (J. A. Clarke), 283.  
 — mountain sheep (J. A. Clarke), 301.  
 WEST Country sheep (J. A. Clarke), 296.  
 — Highland cattle (J. A. Clarke), 284.  
 — Riding of Yorkshire, crops and soils of (J. A. Clarke), 350.  
 WESTERN counties, mean monthly temperature and rainfall (J. A. Clarke), 188.  
 WHEAT areas, distribution of (J. A. Clarke), 195.  
 —, average yield per acre (J. A. Clarke), 196; effect of seasons, *ib.*; principal wheat-producing counties, 197; comparison with foreign countries, 198; average prices, 1861-76, 203; home production, 204; consumption, 205; imports, *ib.*; fluctuations in supplies and prices, 206.  
 —, continuous growth of (Dr. Voelcker), 551.  
 —, experiments made in the growth of (J. Caird), 21 and 26.  
 —, cost of carriage from distances equal to rent of land in England (J. Caird), 14.  
 WHEAT-LAND district of Shropshire (J. A. Clarke), 338.

## WHITEHEAD.

- WHITEHEAD, Charles, on the Cultivation of Hops, Fruit and Vegetables, 457.
- WILKINSON, Mr., on barley after wheat (J. A. Clarke), 324.
- WILTSHIRE Down lambs, management of (J. A. Clarke), 255.
- , soils and crops of (J. A. Clarke), 326.
- WIND-POWER (J. A. Clarke), 366.
- WINDS, prevailing in England (J. A. Clarke), 187.
- WINTER folding of sheep (J. A. Clarke), 259.
- housing and feeding cattle (J. A. Clarke), 232.
- WINTERING calves (J. A. Clarke), 232.
- WIRES for training hops (C. Whitehead), 463.
- WOBURN experiments (J. Caird), 22.
- (Dr. Voelcker), 584.
- WOLDS of Yorkshire (J. A. Clarke), 349.
- WOMAN'S labour in request in the North (H. J. Little), 520.
- WOODLANDS district of Hampshire, course of cropping (J. A. Clarke), 322.
- producing hop-poles (C. Whitehead), 462.
- WOODS, Henry, on preventing abortion in ewes (J. A. Clarke), 252.
- , Her Majesty's revenue from (J. Caird), 64.
- WOOL (J. A. Clarke), 221; home produc-

## ZOOLOGICAL.

- tion, *ib.*; imports and exports, 223; value of different wools, *ib.*
- WOOL, production of (W. T. Carrington), 444.
- WORCESTERSHIRE, fruit-land in (C. Whitehead), 475.
- hop plantations (C. Whitehead), 459.

## Y.

- YARDS for wintering sheep (J. A. Clarke), 262.
- YEARLINGS, fattening of (J. A. Clarke), 247.
- YEARLY tenancies (Clifford and Foote), 83; and advantage to owners, 85; effect upon tenants, 86.
- YEOMEN farming their own land, very small proportion to that of tenant farmers (J. Caird), 32.
- YORKSHIRE, soils and crops of (J. A. Clarke), 348.
- YOUTHS in Yorkshire, early career of (H. J. Little), 522.

## Z.

- Zoological privileges of the Royal Agricultural Society (H. M. Jenkins), 620.



# Royal Agricultural Society of England.

1878.

## President.

COLONEL KINGSCOTE, C.B., M.P.

## Trustees.

Year  
when  
Elected.

- 1855 ACLAND, SIR THOMAS DYKE, Bart., M.P., *Sprydoncote, Exeter, Devonshire.*  
1857 BRIDPORT, Viscount, *Crieket St. Thomas, Chard, Somersetshire.*  
1850 CHESHAM, Lord, *Latimer, Chesham, Bucks.*  
1861 DENT, J. D., *Ribston Hall, Wetherby, Yorkshire.*  
1863 KINGSCOTE, Colonel, M.P., *Kingscote, Wotton-under-Edge, Gloucestershire.*  
1868 LICHFIELD, Earl of, *Shugborough, Staffordshire.*  
1854 MACDONALD, SIR ARCHIBALD KEPPEL, Bt., *Woolmer Lodge, Liphook, Hunts.*  
1860 MARLBOROUGH, Duke of, K.G., *Blenheim Park, Oxford.*  
1846 MILWARD, RICHARD, *Thurgarton Priory, Southwell, Notts.*  
1839 PORTMAN, Viscount, *Bryanston, Blandford, Dorset.*  
1856 POWIS, Earl of, *Powis Castle, Welshpool, Montgomeryshire.*  
1858 RUTLAND, Duke of, K.G., *Belvoir Castle, Grantham, Leicestershire.*

## Vice-Presidents.

- 1873 BEDFORD, Duke of, *Woburn Abbey, Bedfordshire.*  
1861 CATHCART, Earl, *Thornton-le-Street, Thirsk, Yorkshire.*  
1839 CHICHESTER, Earl of, *Stanmer Park, Lewes, Sussex.*  
1867 DEVONSHIRE, Duke of, K.G., *Holker Hall, Lancashire.*  
1847 EVERSLEY, Viscount, *Heckfield Place, Winchfield, Hants.*  
1848 GIBBS, B. T. BRANDRETH, *Halfmoon Street, Piccadilly, London, W.*  
1858 KERRISON, SIR EDWARD C., Bart., *Brome Hall, Scole, Suffolk.*  
1839 MILES, SIR WILLIAM, Bart., *Leigh Court, Bristol, Somersetshire.*  
1852 RICHMOND AND GORDON, Duke of, K.G., *Goodwood, Chichester, Sussex.*  
1859 VERNON, Lord, *Sudbury Hall, Derby.*  
1861 WELLS, WILLIAM, *Holmewood, Peterborough, Northamptonshire.*  
1855 WYNN, SIR WATKIN WILLIAMS, Bart., M.P., *Wynnstay, Raabon, Denbighshire.*

## Other Members of Council.

- 1858 \*AMOS, CHARLES EDWARDS, 5, *Cedars Road, Clapham Common, Surrey.*  
1877 \*ARKWRIGHT, J. H., *Hampton Court, Leominster, Herefordshire.*  
1875 AVELING, THOMAS, *Rochester, Kent.*  
1875 AYLMER, HUGH, *West Dereham, Stoke Ferry, Norfolk.*  
1868 \*BOOTH, THOMAS CHRISTOPHER, *Warlaby, Northallerton, Yorkshire.*  
1863 \*BOWLY, EDWARD, *Siddington House, Cirencester, Gloucestershire.*  
1861 CANTRELL, CHARLES S., *Riding Court, Datchet (Bucks), Windsor.*  
1866 \*DAVIES, DAVID REYNOLDS, *Agden Hall, Lymn, Cheshire.*  
1860 \*DRUCE, JOSEPH, *Eynsham, Oxford.*  
1868 \*EDMONDS, WILLIAM JOHN, *Southrop, Lechlade, Gloucestershire.*  
1871 \*EGERTON, HON. WILBRAHAM, M.P., *Rostherne Manor, Knutsford, Cheshire.*  
1873 EVANS, JOHN, *Uffington, Shrewsbury, Salop.*  
1876 FEVERSHAM, Earl of, *Duncombe Park, Helmsley, Yorkshire.*  
1875 \*FRANKISH, WILLIAM, *Limber Magna, Ulceby, Lincolnshire.*  
1874 \*HEMSLEY, JOHN, *Shelton, Newark, Notts.*

\* Those Members of Council whose names are prefixed by an asterisk retire in July, but are eligible for re-election in May next.

Year  
when  
Elected.

- 1876 HOWARD, CHARLES, *Biddenham, Bedford.*  
 1871 JONES, J. BOWEN, *Ensdon House, Montford Bridge, R.S.O., Salop.*  
 1848 \*LAWES, JOHN BENNET, *Rothamsted, St. Albans, Herts.*  
 1869 LEEDS, ROBERT, *Keswick Old Hall, Norwich.*  
 1872 \*LEICESTER, Earl of, K.G., *Holkham Hall, Wells, Norfolk.*  
 1874 \*LINDSAY, Colonel LOYD, M.P., *Lockinge Park, Wantage, Berkshire.*  
 1865 LOPES, Sir MASSEY, Bart., M.P., *Maristow, Roborough, Devon.*  
 1871 MCINTOSH, DAVID, *Havering Park, Romford, Essex.*  
 1874 MARTIN, JOSEPH, *Highfield House, Littleport, Isle of Ely, Cambridgeshire.*  
 1871 \*MASFEN, R. HANBURY, *Pendeford, Wolverhampton, Staffordshire.*  
 1875 \*MUSGRAVE, Sir R. C., Bart., *Edenhall, Penrith, Cumberland.*  
 1878 \*ODAMS, JAMES, *The Grange, Bishop Stortford, Herts.*  
 1857 PAIN, THOMAS, *The Grove, Basingstoke, Hants.*  
 1874 POLE-GELL, H. CHANDOS, *Hopton Hall, Wirksworth, Derbyshire.*  
 1861 \*RANDELL, CHARLES, *Chadbury, Evesham, Worcestershire.*  
 1875 RANSOME, ROBERT CHARLES, *Ipswich, Suffolk.*  
 1867 RAVENSWORTH, Earl of, *Ravensworth Castle, Durham.*  
 1871 \*RAWLENCE, JAMES, *Bulbridge, Wilton, Salisbury, Wilts.*  
 1869 RIDLEY, Sir M. WHITE, Bart., M.P., *Blaydon, Cramlington, Northumberland.*  
 1861 RIGDEN, WILLIAM, *Asheroft, Kingston-by-Sea, Shoreham, Sussex.*  
 1875 RUSSELL, ROBERT, *Farningham, Dartford.*  
 1874 \*SANDAY, GEORGE HENRY, *Wensley House, Bedale, Yorkshire.*  
 1856 \*SHUTTLEWORTH, JOSEPH, *Hartsholme Hall, Lincoln.*  
 1872 SKELMERSDALE, Lord, *Lathom Hall, Ormskirk, Lancashire.*  
 1874 SPENCER, Earl, K.G., *Althorpe, Northampton.*  
 1875 \*STRATTON, RICHARD, *The Duffryn, Newport, Monmouthshire.*  
 1873 TOBR, JOHN, M.P., *Carlett Park, Eastham, Cheshire.*  
 1874 \*TURBERVILL, Lieut.-Col. PICTON, *Ewenny Priory, Bridgend, South Wales.*  
 1845 TURNER, GEORGE, *Great Bowley, Tiverton, Devonshire.*  
 1871 TURNER, JABEZ, *Norman Cross, Yaxley, Huntingdonshire.*  
 1871 WAKEFIELD, WILLIAM H., *Sedgwick, Kendal, Westmoreland.*  
 1870 \*WELBY-GREGORY, Sir WILLIAM EARLE, Bart., M.P., *Denton Hall, Grantham, Lincolnshire.*  
 1870 \*WHITEHEAD, CHARLES, *Barming House, Maidstone, Kent.*  
 1865 WILSON, JACOB, *Woodhorn Manor, Morpeth, Northumberland.*  
 1878 \*WISE, GEORGE, *Woodcote, Warwick.*

### Secretary and Editor.

H. M. JENKINS, 12, *Hanover Square, London, W.*

- Consulting Chemist*—Dr. AUGUSTUS VOELCKER, F.R.S., 11, *Salisbury Square, E.C.*  
*Consulting Botanist*—W. CARRUTHERS, F.R.S., F.L.S., *British Museum, W.C.*  
*Consulting Veterinary Surgeon*—JAMES BEART SIMONDS, *Royal Veterinary College, Camden Town, N.W.*  
*Officers of the Brown Institution, Wandsworth Road, S.W.*—Dr. J. BURDON SANDERSON, F.R.S., *Professor Superintendent*; W. DUGUID, *Veterinary Inspector.*  
*Consulting Engineers*—EASTONS & ANDERSON, 3, *Whitehall Place, S.W.*  
*Surveyor*—GEORGE HUNT, *Evesham, Worcestershire.*  
*Seedsmen*—THOMAS GIBBS and Co., *Corner of Halfmoon Street, Piccadilly, W.*  
*Publisher*—JOHN MURRAY, 50, *Albemarle Street, W.*  
*Bankers*—THE LONDON AND WESTMINSTER BANK, *St. James's Square Branch, S.W.*

\* Those Members of Council whose names are prefixed by an asterisk retire in July, but are eligible for re-election in May next.

**STANDING COMMITTEES FOR 1878.****Finance Committee.**

RANDELL, CHARLES (Chairman).	BOOTH, T. C.
BRIDPORT, Viscount.	KINGSCOTE, Colonel.
RIDLEY, Sir M. WHITE, Bt.	SHUTTLEWORTH, J.

**House Committee.**

THE PRESIDENT.	CANTRELL, C. S.
CHAIRMAN of Finance Committee.	GIBBS, B. T. BRANDRETH.
BRIDPORT, Viscount.	

**Journal Committee.**

DENT, J. D. (Chairman).	KINGSCOTE, Colonel.
CATHCART, Earl.	MILWARD, RICHARD.
VERNON, Lord.	POLE-GELL, H. CHANDOS.
WELBY-GREGORY, Sir W. E., Bt.	RANSOME, R. C.
RIDLEY, Sir M. WHITE, Bt.	TURBERVILL, Lieut.-Col.
FRANKISH, W.	WELLS, W.
HEMSLEY, J.	WHITEHEAD, CHARLES.
JONES, J. BOWEN.	

**Chemical Committee.**

WELLS, WILLIAM (Chairman).	HOWARD, C.
BEDFORD, Duke of.	HEMSLEY, J.
LICHFIELD, Earl of.	JONES, J. BOWEN.
VERNON, Lord.	LAWES, J. B.
MACDONALD, Sir A. K., Bart.	TURBERVILL, Lieut.-Col.
WELBY-GREGORY, Sir W. E., Bt.	VOELCKER, Dr. A.
ARKWRIGHT, J. H.	WAKEFIELD, W. H.
AVELING, T.	WARREN, R. A.
CARRUTHERS, W.	WHITEHEAD, CHARLES.
DENT, J. D.	WILSON, JACOB.
EDMONDS, W. J.	

**Seeds and Plant-Diseases Committee.**

VERNON, Lord.	GIBBS, B. T. BRANDRETH.
RIDLEY, Sir M. WHITE, Bt.	JONES, J. BOWEN.
WELBY-GREGORY, Sir W. E., Bt.	TURBERVILL, Lieut.-Col.
CARRUTHERS, W.	VOELCKER, Dr.
FRANKISH, W.	WHITEHEAD, CHARLES.

**Veterinary Committee.**

EGERTON, Hon. WILBRAHAM (Chairman).	KINGSCOTE, Colonel.
CATHCART, Earl.	LINDSAY, Colonel LOYD.
BRIDPORT, Viscount.	MILWARD, R.
RIDLEY, Sir M. WHITE, Bt.	POLE-GELL, H. CHANDOS.
BOOTH, T. C.	QUAIN, Dr.
BROWN, Professor.	SANDAY, G. H.
CARPENTER, Dr.	SANDERSON, Dr. J. BURDON.
DUGUID, W.	SIMONDS, Professor.
GIBBS, B. T. BRANDRETH.	WAKEFIELD, W. H.
HARPLEY, M. J.	WELLS, WILLIAM.
	WILSON, JACOB.

**Stock-Prizes Committee.**

MILWARD, RICHARD (Chairman).	EVANS, JOHN.	RIGDEN, WILLIAM.
BRIDPORT, Viscount.	FRANKISH, W.	SANDAY, G. H.
RIDLEY, Sir M. WHITE, Bt.	GIBBS, B. T. BRANDRETH.	STRATTON, R.
ARKWRIGHT, J. H.	HEMSLEY, J.	TORR, J.
AYLMER, H.	HOWARD, C.	WAKEFIELD, W. H.
BOOTH, T. C.	MCINTOSH, D.	WILSON, JACOB.
BOWLY, EDWARD.	MASFEN, R. H.	The Stewards of Live Stock.
	PAIN, T.	
	POLE-GELL, H. CHANDOS.	

### Implement Committee.

HEMSLEY, J. (Chairman).	CANTRELL, CHAS. S.	SANDAY, G. H.
BRIDPORT, Viscount.	EDMONDS, W. J.	SHUTTLEWORTH, JOSEPH.
VERNON, Lord.	FRANKISH, W.	TURBERVILL, Licut.-Col.
MACDONALD, Sir A. K., Bt.	GIBBS, B. T. BRANDRETH.	TURNER, JABEZ.
AMOS, C. E.	JONES, J. BOWEN.	WHITEHEAD, CHARLES.
ANDERSON, W.	MARTIN, J.	WILSON, JACOB.
AVELING, T.	MILWARD, R.	Tho Stewards of Imple-
BOOTH, T. C.	RANSOME, R. C.	ments.

### General Bristol Committee.

SKELMERSDALE, Lord (Chairman).	DYKE, T.	SANDAY, G. H.
BRIDPORT, Viscount.	FRANKISH, W.	SHUTTLEWORTH, J.
CHESHAM, Lord	GIBBS, B. T. BRANDRETH.	SMITH, W.
LOPES, Sir MASSEY, Bt.	HEMSLEY, J.	STRATTON, R.
MUSGRAVE, Sir R., Bt.	JONES, J. A.	THOMAS, CHRISTOPHER J.
EGERTON, Hon. W.	JONES, J. BOWEN.	THOMPSON, W.
AVELING, T.	MARTIN, J.	TURBERVILL, Licut.-Col.
AYLMER, H.	MASFEN, R. H.	TURNER, GEORGE.
BOOTH, T. C.	MILWARD, RICHARD.	TURNER, JABEZ.
BOWLY, EDWARD.	NICHOLS, GEORGE.	WAKEFIELD, W. H.
BRISTOL, High Sheriff of.	POLE-GELL, H. CHANDOS.	WELLS, W.
BRISTOL, Mayor of.	RANDELL, CHARLES.	WHITEHEAD, CHARLES.
CANTRELL, CHARLES S.	RANSOME, R. C.	WILSON, JACOB.
	RAWLENCE, J.	

### Show-Dard Contracts Committee.

WILSON, JACOB (Chairman).	GIBBS, B. T. BRANDRETH.
BRIDPORT, Viscount.	MILWARD, RICHARD.
AMOS, C. E.	POLE-GELL, H. CHANDOS.
AVELING, T.	RANDELL, CHARLES.
BOOTH, T. C.	SHUTTLEWORTH, JOSEPH.
FRANKISH, W.	STRATTON, R.

### Committee of Selection.

CATHCART, Earl (Chairman).	MILWARD, R.
BRIDPORT, Viscount.	POLE-GELL, H. CHANDOS.
EGERTON, Hon. W.	WILSON, JACOB.
BOOTH, T. C.	

And the Chairmen of the Standing Committees.

### Education Committee.

BEDFORD, Duke of (Chairman).	KINGSCOTE, Colonel.
AVELING, T.	TURBERVILL, Licut.-Col.
CARRUTHERS, W.	VOELCKER, Dr.
DENT, J. D.	WELLS, WILLIAM.
JONES, J. BOWEN.	WHITEHEAD, CHARLES.

### Cattle Plague Committee.

THE WHOLE COUNCIL.

\* \* \* Tho PRESIDENT, TRUSTEES, and VICE-PRESIDENTS are Members *ex officio* of all Committees.

## Royal Agricultural Society of England.

---

---

### GENERAL MEETING,

12, HANOVER SQUARE, THURSDAY, DECEMBER 13TH, 1877.

---

#### REPORT OF THE COUNCIL.

THE Council have to report that during the year 1877 the number of Governors and Members has been increased by the election of 1 Governor and 412 Members, and diminished by the death of 4 Governors and 107 Members, the resignation of 127 Members, and the removal of 50 Members by order of the Council.

The Society now consists of:—

81 Life Governors,  
74 Annual Governors,  
2280 Life Members,  
4182 Annual Members,  
17 Honorary Members,

making a total of 6634, and showing an increase of 124 Members during the current year.

The half-yearly statement of accounts to the 30th June last has been examined and approved by the Society's auditors and accountants, and has been published for the information of the Members, in the last number of the 'Journal.' Since then the funded capital has been increased by the investment of 4000*l.* in the New Three per Cents.—chiefly the surplus receipts of the Liverpool Meeting. The funded property is now 26,511*l.* 11*s.* 5*d.* New Three per Cents., and the balance in the hands of the Bankers on the 1st inst. was 1610*l.* 19*s.* 6*d.*

The Liverpool Meeting was one of the largest and most successful which the Society has ever held, and the attendance on the first three days even equalled that at the Manchester Meeting. Unfortunately the wet weather on the two closing days prevented many thousands of people from visiting the

Show, but, notwithstanding this drawback, the total number registered by the turnstiles has been exceeded only three times in the history of the Society, namely at Leeds in 1861, at Manchester in 1869, and at Birmingham in 1876, while the money receipts were second only to those at Manchester. The Local Committee and the authorities of Liverpool made every exertion to render the Meeting successful. Besides their remarkably handsome additions to the Society's prize-list, the Local Committee organised a parade of more than 300 cart-horses in the Show-yard on the Saturday afternoon, and it was generally admitted that this was a most instructive and attractive as well as a novel exhibition. The Mayor and Corporation and the merchants and manufacturers of Liverpool invited the Members of the Society to inspect the buildings and processes over which they had control, and many Members of the Society availed themselves of this opportunity to acquaint themselves with the extensive docks, public buildings, factories, and warehouses for which Liverpool is famous. In every respect the country-meeting will long be remembered as one of the largest and most useful of those which the Society has held.

The competition for the Society's Gold Medal offered for an efficient sheaf-binder, took place at harvest-time on Mr. Scotson's farm at Aigburth, near Liverpool. Only three machines, all of American make, were brought to trial; and although the Judges were of opinion that these labour-saving appliances had not yet been made sufficiently perfect to justify them in awarding the Gold Medal, they were of opinion that great credit was due to the three inventions, and they recommended that a silver medal, in recognition of progress, should be given to Mr. W. A. Wood, and a high commendation bestowed on the binding mechanism employed by D. M. Osborne and Co. The Judges also suggested a renewal of the offer of the Gold Medal next year, and the Stewards having reported favourably of this course, the Council have acted in accordance with their recommendation.

The competition for the numerous prizes offered by the Local Committee for the best managed Dairy (or Stock) and Arable Farms in the counties of Lancaster, Cheshire, Denbigh, and Flint, and in the Isle of Man, was very keen; and the striking Reports on the two sections of the competition, written by Mr. J. C. Morton and Mr. S. D. Shirriff respectively, and



published in the last number of the 'Journal,' are well worthy of careful study.

The Country-meeting for the ensuing year will be held at Bristol; and the Council are glad to announce that the Local Committee have obtained the use of a most eligible site for the Show-yard on Durdham Down.

The Bristol Local Committee have offered the following Prizes for best-managed farms in the county of Gloucester, the eastern division of Somerset, and the northern division of Wilts:—

SECTION I.—Arable Farms with at least two-thirds of their area under rotation of cropping:—

Class 1. Farms of 200 acres and upwards. First Prize, £50; second, £25.

Class 2. Farms above 80 and less than 200 acres. First Prize, £30; second, £15.

SECTION II. Dairy or Stock Farms, where the course of cultivation is chiefly directed to the production of Cheese, Butter, or of Animal Food:—

Class 1. Farm of not less than 200 acres. First Prize, £50; second, £25.

Class 2. Farms of not less than 80 and under 200 acres. First Prize, £30; second, £15.

In addition to the renewed offers of the Society's Gold Medal for an efficient Sheaf-binder, the Council have decided to offer for competition at the Bristol Meeting prizes for improved Dairy appliances; and the Local Committee will offer prizes for several classes of Dairy Produce. It is hoped that by these means the most improved methods and the best results of cheese and butter making may be illustrated in the Bristol Show-yard.

Following the precedent of the last two years, the Council have decided that the Bristol Meeting shall commence on Wednesday, July 10th, and that the Implement-yard shall be open to the public on the preceding day.

The Council have added the following new rules to the Implement Prize-sheet:—

1. In the Catalogue there shall be no statement of any prize awarded to an implement except such as may have been awarded by the Royal Agricultural Society.

2. No placard or other statement shall be attached to any machine, implement, or other article in the Society's Show-yard, referring to any prize, except such as may have been awarded to it by the Royal Agricultural Society.

3. In the Show-yard exhibitors must use smokeless coal, which, for their convenience, will be provided and sold at a fixed price by the Society, or by an agent duly appointed by it.

4. Shafting, belts, gearing, high-speed machinery, and any other exhibits likely to prove dangerous to the public, shall be securely fenced and protected to the satisfaction of the Society's Stewards or Engineers; but such approval by the Stewards or Engineers shall not relieve the exhibitor from his liability under other Clauses.

5. Emery wheels and similar grinding machinery driven at high speeds will not be allowed to be exhibited in motion; and the decision of the Society's Stewards or Engineers in reference to such machinery shall in all cases be final and of immediate effect.

6. Engine-drivers in charge of boilers under steam, and of steam-engines when running, shall not absent themselves from their posts without leaving their machinery in charge of competent persons.

The Committee appointed by the Council to ascertain what sites within the Metropolitan area may be available and suitable for the Society's Show in 1879 are continuing their investigations, and it is hoped that they may be eventually successful; but up to the present time no definite conclusion has been arrived at.

The health of the Live Stock of the Farm has been the most prominent subject which the Council have had to consider during the past year. At the Annual Meeting in May, when it was still uncertain whether the Liverpool Meeting could be held, they reported that they had watched with the greatest anxiety and alarm the progress of the outbreaks of cattle-plague in London and Hull; that, in addition to suggesting certain measures for the purpose of dealing with the immediate emergency, they had represented to the Lord President of the Council the necessity of protecting English herds from this and other foreign contagious diseases, by prohibiting for the future the importation of Live Stock from European ports, and by enforcing uniform and compulsory measures for the suppression of contagious diseases amongst farm stock throughout the kingdom.

The result of these representations was the appointment of a Select Committee of the House of Commons to enquire into the whole subject of Cattle Plague and the Importation of Live Stock. The Council secured the examination of practical and scientific witnesses, both agricultural and otherwise; and they believe that the evidence given was felt to be of a most useful and representative character. Although the recommendations made by the Select Committee did not go so far as the resolu-

tions of the Council which had led to its appointment, either with regard to foreign or to home stock, the Council felt it necessary to urge upon the Government the desirability of taking, as soon as possible, the necessary steps to carry those recommendations into effect. At their request the Prime Minister received a deputation on the 23rd of last month, when they had the satisfaction of learning that it is the intention of the Government to legislate upon the subject as early as possible next session. A report of what took place at this interview has been sent to every Member of the Society, and the Council venture to express the hope that the Members generally will use their influence in their several districts to obtain that general effort to stamp out the contagious diseases of farm stock to which the Prime Minister so pointedly referred.

The recent large importations of American meat into Great Britain have proved that the prohibition of importations of live stock need not enhance the price of meat to the consumer, as similar appliances to those used by American exporters could be adapted to the requirements of the Continental trade. The Council have, therefore, thought it desirable to place the Members of the Society in possession of the fullest information on this subject, and with this view have published two exhaustive articles, by Professor Sheldon, of Cirencester, and Professor Alvord, of Massachusetts, U.S., in the last number of the 'Journal.'

The experiments upon Pleuro-pneumonia and Foot-and-mouth disease have been continued during the year at the Brown Institution, under the superintendence of Dr. Burdon Sanderson. Valuable indications have been obtained and described in the Reports already published in the 'Journal,' and in the agricultural newspapers; but before these can be accepted as final, they will require careful confirmation. The Council have renewed the grant for these investigations, the scope of which will next year be extended to Quarter-evil and diseases of a similar nature.

The last Quarterly Report of the Chemical Committee shows that the need of caution in purchasing artificial manures and feeding-stuffs still continues. The Council, therefore, take this opportunity of once more repeating their advice that these substances should be bought by guaranteed analysis, and that their quality should be checked by sending a sample from the bulk to a qualified chemist for examination.

The Chemical Committee have lately visited the experimental farm at Woburn, and have reported that, as regards the experimental field of 25 acres, the various plots sown for the second year's experiments are in a satisfactory state of progress. Owing to the original condition of the Crawley Farm of 90 acres, which is not experimental but only auxiliary, some time must elapse before the land is thoroughly clean and the farm generally has been brought into a condition which will accord with good farming. Mr. Lawes and Dr. Voelcker have submitted to the Chemical Committee the results of the first year's experiments, and this Report is at present under their consideration. A Sub-Committee has been appointed to confer with Mr. Lawes and Dr. Voelcker with the view of relieving them, if possible, of the responsibility of farming operations, in order that their undivided attention may be given to the various experiments in progress.

The Council have had under their careful consideration the threatened importation of the Colorado Beetle, and have made certain suggestions to the Government with a view of reducing the danger to a minimum. They have also issued to each Member of the Society figures of the beetle in all its stages, and a statement of the means for its destruction, which have been found most efficacious in America.

This new danger has again drawn the attention of the Council to the desirability of placing within the reach of Members of the Society competent advice on injuries caused by insects to farm-crops; and they have arranged with Mr. Carruthers, the Consulting Botanist, to obtain such information and advice for the Members at a small rate. A copy of these additional privileges has been sent to each Member of the Society, together with instructions as to the methods of conveying information in regard to any injuries which their crops may suffer from insects or other causes.

In consequence of the revelations made at the recent trials at the Mansion House, as to the adulteration, colouring, and killing of seeds, and of information laid before the Botanical Committee showing the great extent of this practice, the Council have authorised the Botanical Committee to publish the names of the persons who have sold to the Members of the Society seeds which have been determined by the Consulting Botanist to have been killed, coloured, or adulterated. The Council

hope that such publication may tend to suppress the traffic in worthless seeds, and that the Members of the Society will avail themselves largely of the services of the Consulting Botanist in the determination of the quality and germinating power of seeds.

Thirty-two candidates were entered for examination for the Society's Junior Scholarships from the following Schools:— Bedford County School (2), Devon County School (1), Dorset County School (2), Glasnevin College (5), Sandbach Grammar School (3), Surrey County School (19). The following candidates, arranged in order of merit, have gained Scholarships:—

- |       |   |                         |
|-------|---|-------------------------|
|       | 1st. F. Wyles,                                  | } Surrey County School. |
|       | 2nd. A. Budd,                                   |                         |
| Equal | 3rd. C. Caldecott,                              |                         |
|       | 3rd. Charles Walker, Bedford County School.     |                         |
|       | 5th. Richard Pearse Chope, Devon County School. |                         |
|       | 6th. John Golding, Glasnevin College.           |                         |
|       | 7th. A. J. Waghorn, Surrey County School.       |                         |

Twelve candidates were eligible to compete for the Society's medals and prizes offered to Veterinary Surgeons of not more than fifteen months' standing for proficiency in Cattle Pathology. Of these six have entered, and the examination will be held at the Royal College of Veterinary Surgeons in the course of the current month.

By order of the Council,

H. M. JENKINS,

*Secretary.*

# Royal Agricultural Society of England.

1878.

## DISTRIBUTION OF MEMBERS OF THE SOCIETY AND OF MEMBERS OF COUNCIL.

DISTRICTS.	COUNTIES.	NUMBER OF MEMBERS.	NUMBER IN COUNCIL.	MEMBERS OF COUNCIL.
A.	BEDFORDSHIRE ..	69 ..	2	{ Duke of Bedford, v.p.; C. Howard. Lord Chesham, t.; C. S. Cantrell. J. Martin. D. McIntosh. J. B. Lawes; J. Odams. Jabez Turner; W. Wells, v.p. B. T. Brandreth Gibbs, v.p. Earl of Leicester; Robert Leeds; Hugh Aylmer. Duke of Marlborough, t.; J. Druce. Sir E. C. Kerrison, v.p.; R. C. Ransome.
	BUCKINGHAMSHIRE ..	70 ..	2	
	CAMBRIDGESHIRE ..	90 ..	1	
	ESSEX .. ..	124 ..	1	
	HERTFORDSHIRE ..	111 ..	2	
	HUNTINGDONSHIRE ..	47 ..	2	
	MIDDLESEX .. ..	290 ..	1	
	NORFOLK .. ..	222 ..	3	
	OXFORDSHIRE .. ..	142 ..	2	
SUFFOLK .. ..	141 ..	2		
		—1306	— 18	
B.	CUMBERLAND .. ..	105 ..	1	Sir R. C. Musgrave. Earl of Ravensworth. Sir M. White Ridley; Jacob Wilson. W. H. Wakefield.
	DURHAM .. ..	107 ..	1	
	NORTHUMBERLAND ..	136 ..	2	
	WESTMORELAND ..	70 ..	1	
		— 418	— 5	
C.	DERBYSHIRE .. ..	119 ..	2	{ Lord Vernon, v.p.; H. Chandos Pole-Gell. Duke of Rutland, t. W. Frankish; Sir W. Earle Welby-Gregory; J. Shuttle- worth. Earl Spencer. R. Milward, t.; J. Hemsley.
	LEICESTERSHIRE ..	103 ..	1	
	LINCOLNSHIRE .. ..	210 ..	3	
	NORTHAMPTONSHIRE	120 ..	1	
	NOTTINGHAMSHIRE ..	149 ..	2	
RUTLAND .. ..	17 ..	..	..	
		— 718	— 9	



DISTRIBUTION OF MEMBERS OF THE SOCIETY—continued.

DISTRICTS.	COUNTIES.	NUMBER OF MEMBERS.	NUMBER IN COUNCIL.	MEMBERS OF COUNCIL.
D.	BERKSHIRE .. ..	118 ..	1	Colonel Loyd Lindsay,
	CORNWALL .. ..	51 ..		
	DEVONSHIRE .. ..	112 ..	3	{ Sir T. D. Acland, t.; Sir M. Lopes; G. Turner.
	DORSETSHIRE .. ..	63 ..	1	Lord Portman, t.
	HAMPSHIRE .. ..	136 ..	3	{ Viscount Eversley, v.p.; Sir A. K. Macdonald, t.; T. Pain.
	KENT .. ..	288 ..	3	{ T. Aveling; C. Whitehead; R. Russell.
	SOMERSETSHIRE ..	143 ..	2	{ Viscount Bridport, t.; Sir W. Miles, v.p.
	SURREY .. ..	123 ..	1	C. E. Amos.
	SUSSEX .. ..	138 ..	3	{ Earl of Chichester, v.p.; Duke of Richmond and Gordon, v.p.; W. Rigden.
WILTSHIRE .. ..	112 ..	1	J. Rawlence.	
		—1284	— 18	
E.	YORKSHIRE .. ..	348 ..	5	{ Earl Cathcart, v.p.; Earl of Feversham; T. C. Booth; J. D. Dent, t.; G. H. Sanday.
F.	CHESHIRE .. ..	170 ..	3	{ D. R. Davies; Hon. W. Egerton; John Torr.
	LANCASHIRE .. ..	282 ..	2	{ Duke of Devonshire, v.p.; Lord Skelmersdale.
	NORTH WALES ..	194 ..	2	{ Earl of Powis, t.; Sir W. W. Wynn, v.p.
		— 646	— 7	
G.	GLOUCESTERSHIRE ..	194 ..	3	{ E. Bowly; W. J. Edmonds; Col. Kingscote, t.
	HEREFORDSHIRE ..	87 ..	1	J. H. Arkwright.
	MONMOUTHSHIRE ..	53 ..	1	R. Stratton.
	SHROPSHIRE .. ..	375 ..	2	John Evans; J. Bowen Jones.
	STAFFORDSHIRE ..	305 ..	2	{ Earl of Lichfield, t.; R. H. Masfen.
	WARWICKSHIRE ..	217 ..	1	George Wise.
	WORCESTERSHIRE ..	141 ..	1	C. Randell.
	SOUTH WALES ..	139 ..	1	Lt.-Col. Picton Turbervill.
		—1511	— 12	
SCOTLAND .. ..	74			
IRELAND .. ..	90			
CHANNEL ISLANDS ..	9			
FOREIGN COUNTRIES ..	90			
MEMBERS WITHOUT ADDRESSES ..	84			
		— 347		

## ROYAL AGRICULTURAL

DR.

## HALF-YEARLY CASH ACCOUNT

	£	s.	d.	£	s.	d.
To Balance in hand, 1st July, 1877:—						
Bankers .. .. .	3,295	17	2			
Secretary .. .. .		5	16			
	3,301	13	8			
At Deposit, London and Westminster Bank .. .. .	2,000	0	0			
				5,301	13	8
To Income:—						
Subscriptions:—						
Governors' Annual .. .. .	15	0	0			
Members' Life-Compositions .. .. .	467	0	0			
Members' Annual .. .. .	901	0	0			
	1,383	0	0			
Dividends on Stock .. .. .	392	14	0			
Interest on Deposit Account .. .. .	29	2	5			
Establishment:—						
Rent .. .. .	100	0	0			
Journal:—						
Sales .. .. .	147	18	11			
Advertisements .. .. .	63	1	0			
	210	19	11			
Farm Inspection:—						
Prizes given by the Liverpool Local Committee	300	0	0			
Entry Fees for 1878 .. .. .	18	0	0			
	318	0	0			
Birmingham Meeting .. .. .	39	10	0			
Total Income .. .. .				2,473	6	4
To Liverpool Meeting .. .. .				17,243	11	3
				£25,018	11	3

## BALANCE-SHEET,

	£	s.	d.	£	s.	d.
To Capital:—						
Surplus, 30th June, 1877 .. .. .	27,109	9	0			
Less Surplus of Expenditure over Income during the Half-year, viz.:—						
Expenditure .. .. .	3,572	1	10			
Income .. .. .	2,473	6	4			
	1,098	15	6			
Less half-year's interest and depreciation on } Country Meeting Plant .. .. . }	167	8	6			
	1,266	4	0			
To Liverpool Meeting:—				25,843	5	0
Excess of Receipts over Expenditure .. .. .				4,283	1	11
				£30,126	6	11

# SOCIETY OF ENGLAND.

FROM 1ST JULY TO 31ST DECEMBER, 1877.

CR.

	£	s.	d.	£	s.	d.	£	s.	d.
<b>By Expenditure:—</b>									
<b>Establishment:—</b>									
Salaries, Wages, &c. . . . .	592	10	0						
House:—Rent, Taxes, &c. . . . .	394	10	4						
Office:—Printing, Postage, Stationery, &c. . . . .	275	0	9						
				1,262	1	1			
<b>Journal:—</b>									
Printing and Stitching . . . . .	427	14	3						
Postage and Delivery . . . . .	142	2	0						
Literary Contributions . . . . .	153	15	0						
Woodcuts . . . . .	21	11	0						
Advertising . . . . .	6	14	0						
				751	16	3			
<b>Chemical:—</b>									
Consulting Chemist's Salary . . . . .	150	0	0						
<b>Veterinary:—</b>									
The Brown Institution (one year) . . . . .	250	0	0						
Expenses in procuring Evidence for Cattle Plague } Committee . . . . . }	8	10	3						
				258	10	3			
<b>Botanical:—</b>									
Consulting Botanist's Salary . . . . .	50	0	0						
<b>Education:—</b>									
Scholarships . . . . .	80	0	0						
<b>Farm Inspection:—</b>									
Judges . . . . .	495	19	10						
Prizes . . . . .	350	0	0						
				845	19	10			
<b>Sundries:—</b>									
Preparing Dynamometer, &c., for Exhibition at } South Kensington . . . . . }	39	14	5						
On account of Memoir for International Agricul- } tural Congress at Paris . . . . . }	50	0	0						
				89	14	5			
Birmingham Meeting . . . . .	84	0	0						
<b>Total Expenditure . . . . .</b>									
							3,572	1	10
<b>By Stock:—</b>									
Purchase of £4177 11s. New 3 per Cents. . . . .	4,000	0	0						
<b>By Capital Account:—</b>									
Country Meeting Plant . . . . .	107	13	9						
<b>By Liverpool Meeting . . . . .</b>				16,067	18	0			
							20,175	11	9
<b>By Balance in hand, 31st December:—</b>									
Bankers . . . . .	250	8	2						
Secretary . . . . .	20	9	6						
				270	17	8			
At Deposit, London and Westminster Bank . . . . .				1,000	0	0			
							1,270	17	8
							£25,018	11	3

31ST DECEMBER, 1877.

ASSETS.		£	s.	d.	£	s.	d.
By Cash in hand . . . . .		270	17	8			
By New 3 per Cent. Stock 26,511l. 11s. 5d.* . . . .		25,340	7	1			
By Books and Furniture in Society's House . . . . .		1,451	17	6			
By Country Meeting Plant . . . . .		2,063	4	8			
By Deposit Account . . . . .		1,000	0	0			
					30,126	6	11
* Value at 94½ = £25,058 8s. 8d.							
<i>Mem.</i> —The above Assets are exclusive of the amount recoverable in respect of arrears of Subscription to 31st December, 1877, which at that date amounted to 706l.							
					£30,126	6	11

Examined, audited, and found correct, this 26th day of February, 1878.

FRANCIS SHERBORN,  
A. H. JOHNSON,  
HENRY CANTRELL.

Auditors on behalf of the Society.



## SOCIETY OF ENGLAND.

FROM 1ST JANUARY TO 31ST DECEMBER, 1877.

CR.

	£. s. d.	£. s. d.	£. s. d.
<b>By Expenditure:—</b>			
<b>Establishment:—</b>			
Salaries, Wages, &c. . . . .	1,185 0 0		
House: Rent, Taxes, Repairs, &c. . . . .	754 12 0		
Office: Printing, Postage, &c. . . . .	527 15 7	2,467 7 7	
<b>Journal:—</b>			
Printing and Stitching . . . . .	908 12 0		
Postage and Delivery . . . . .	307 12 0		
Literary Contributions . . . . .	330 11 0		
Wood Engravings . . . . .	99 12 6		
Advertising . . . . .	13 13 0	1,660 0 6	
<b>Chemical:—</b>			
Consulting Chemist's Salary . . . . .	300 0 0		
Grant for Investigations . . . . .	200 0 0	500 0 0	
<b>Veterinary:—</b>			
The Brown Institution for Investigations two } years, to Christmas, 1877 . . . . . }	500 0 0		
Prizes and Medals . . . . .	47 12 0		
Fees to Examiners . . . . .	34 13 0		
Professional Fee . . . . .	2 2 0		
Expenses in procuring Evidence for Cattle } Plague Committee . . . . . }	8 10 3	592 17 3	
<b>Botanical:—</b>			
Consulting Botanist's Salary . . . . .	. . .	100 0 0	
<b>Education:—</b>			
Scholarships . . . . .	80 0 0		
Prizes . . . . .	40 0 0		
Fees to Examiners . . . . .	56 16 6		
Advertising and Printing . . . . .	36 2 6	212 19 0	
Subscriptions (paid in error) returned . . . . .	. . .	4 0 0	
<b>Sundries:—</b>			
Expenses of Inspection Committee . . . . .	23 6 6		
Secretary's Journey to Hamburg Dairy Show . . . . .	23 0 0		
Preparing Dynamometer for exhibition at South } Kensington . . . . . }	39 14 5		
On account of Memoir for International Agricul- } tural Congress at Paris . . . . . }	50 0 0	136 0 11	
<b>Farm Inspection:—</b>			
Prizes . . . . .	350 0 0		
Judges . . . . .	495 19 10		
Advertising . . . . .	47 14 6	893 14 4	
<b>Total Expenditure . . . . .</b>	. . .	. . .	6,566 19 7
<b>By Capital Account:—</b>			
Country Meeting Plant . . . . .	. . .	107 13 9	
<b>By Country Meetings:—</b>			
Birmingham . . . . .	149 5 6		
Liverpool . . . . .	19,477 3 8	19,626 9 2	
<b>By Stock:—</b>			
Purchase of 4177l. 11s. 0d. New 3 per Cents. . . . .	. . .	4,000 0 0	
<b>By Balance in hand, 31st Dec.:—</b>			
Bankers . . . . .	250 8 2		
Secretary . . . . .	20 9 6	270 17 8	23,734 2 11
At Deposit, London and Westminster Bank . . . . .	. . .	1,000 0 0	
			1,270 17 8
			£31,572 0 2

## RECEIPTS.

	£.	s.	d.
Subscription from Liverpool . . . . .	2,000	0	0
Admissions to Show-Yard by Payment . . . . .	11,736	1	5
Admissions by Tickets: Season, 1111 <i>l.</i> 16 <i>s.</i> 0 <i>d.</i> ; other Tickets, 120 <i>l.</i> 1 <i>s.</i> 6 <i>d.</i> . . . . .	1,231	17	6
Admissions to Grand Stand . . . . .	429	11	0
Sale of Catalogues . . . . .	1,135	13	4
Entries in Implement Catalogue . . . . .	470	0	0
Implement Exhibitors' Payments for Shedding . . . . .	3,160	5	8
Non-Members' Fees for entry of Implements . . . . .	255	0	0
Fees for entry of Live Stock . . . . .	587	0	0
Fees for Horse Boxes and Stalls . . . . .	291	10	0
Premiums for Supply of Refreshments . . . . .	605	0	0
Premium for Manure . . . . .	36	0	0
Premium for Cloak Rooms and Lavatories . . . . .	60	0	0
Fines for Non-Exhibition of Live Stock . . . . .	58	0	0
Reference Number Fines . . . . .	19	0	0

---

£22,074 18 11



## ACCOUNT, LIVERPOOL, 1877.

## EXPENDITURE.

	£.	s.	d.	£.	s.	d.
Show-Yard Works:—viz. Carriage, Storage, Erecting, Repairing, Painting, taking to pieces, Packing and Insurance of Permanent Buildings, and other Plant . . . . .	634	2	4			
Implement Sheds, 1495 <i>l.</i> ; Seed and Model Sheds, 160 <i>l.</i> 1 <i>s.</i> 6 <i>d.</i> . . . . .	1655	1	6			
Stock Sheds, 703 <i>l.</i> 12 <i>s.</i> ; Horse Boxes, 1150 <i>l.</i> 12 <i>s.</i> 3 <i>d.</i> . . . . .	1854	4	3			
Cheese and Provision Sheds, 159 <i>l.</i> 18 <i>s.</i> ; Fodder Sheds, 88 <i>l.</i> 1 <i>s.</i> . . . . .	247	19	0			
Horse and Cattle Rings, 55 <i>l.</i> 13 <i>s.</i> 7 <i>d.</i> ; Grand Stand, 530 <i>l.</i> 6 <i>s.</i> 6 <i>d.</i> . . . . .	586	0	1			
Fencing, Gates, &c., 456 <i>l.</i> 15 <i>s.</i> ; Hurdles, 174 <i>l.</i> 11 <i>s.</i> 6 <i>d.</i> . . . . .	631	6	6			
Members' Club, 236 <i>l.</i> 14 <i>s.</i> 2 <i>d.</i> ; Lavatories, 46 <i>l.</i> 9 <i>s.</i> 3 <i>d.</i> . . . . .	283	3	5			
Platforms and Extra Entrances, 156 <i>l.</i> 15 <i>s.</i> ; other Offices, 92 <i>l.</i> 11 <i>s.</i> 8 <i>d.</i> . . . . .	249	6	8			
Signs and Notice Boards, 76 <i>l.</i> 14 <i>s.</i> 8 <i>d.</i> ; Awnings, 69 <i>l.</i> 17 <i>s.</i> . . . . .	146	11	8			
Other Works, 192 <i>l.</i> 6 <i>s.</i> 11 <i>d.</i> ; Chairs, 66 <i>l.</i> 3 <i>s.</i> 3 <i>d.</i> ; Rope, 26 <i>l.</i> 14 <i>s.</i> 10 <i>d.</i> . . . . .	285	5	0			
Surveyor, 449 <i>l.</i> 7 <i>s.</i> 9 <i>d.</i> ; Working Drawings, 13 <i>l.</i> 10 <i>s.</i> . . . . .	462	17	9			
Depreciation of Plant . . . . .	339	11	2			
				7,375	9	4
Judges: Implements, 102 <i>l.</i> ; Stock, 367 <i>l.</i> 2 <i>s.</i> 5 <i>d.</i> ; Cheese, Provisions, &c., 44 <i>l.</i> 4 <i>s.</i> . . . . .	513	6	5			
Consulting Engineers and Assistants . . . . .	133	8	5			
Inspectors: Veterinary, 84 <i>l.</i> ; Shearing, 22 <i>l.</i> 12 <i>s.</i> 2 <i>d.</i> . . . . .	106	12	2			
Police: Metropolitan, 468 <i>l.</i> 19 <i>s.</i> 8 <i>d.</i> ; County, 132 <i>l.</i> 5 <i>s.</i> 3 <i>d.</i> ; Borough (including cost of Timepiece, presented to Superintendent Hancox), 66 <i>l.</i> 15 <i>s.</i> 8 <i>d.</i> . . . . .	668	0	7			
Clerks and Assistants: Bankers, 39 <i>l.</i> 18 <i>s.</i> ; Post Office, 36 <i>l.</i> ; Secretary and Stewards, 79 <i>l.</i> 6 <i>s.</i> 6 <i>d.</i> . . . . .	155	4	6			
Journeys previous to Show, 36 <i>l.</i> 1 <i>s.</i> ; Expenses of Secretary and Official Staff, 29 <i>l.</i> 12 <i>s.</i> 9 <i>d.</i> . . . . .	65	13	9			
Assistant Stewards: Implements, 40 <i>l.</i> 19 <i>s.</i> ; Stock, 25 <i>l.</i> 8 <i>s.</i> . . . . .	66	7	0			
Foremen, 21 <i>l.</i> 12 <i>s.</i> 2 <i>d.</i> ; Horses, 7 <i>l.</i> 16 <i>s.</i> ; Cattle, 12 <i>l.</i> ; Sheep, 14 <i>l.</i> 11 <i>s.</i> 6 <i>d.</i> ; Pigs, 7 <i>l.</i> 4 <i>s.</i> ; Fodder, 30 <i>l.</i> 8 <i>s.</i> . . . . .	93	11	8			
Yardmen, Foddermen, Labourers, &c., 98 <i>l.</i> 3 <i>s.</i> 8 <i>d.</i> ; Grooms, &c., 32 <i>l.</i> 0 <i>s.</i> 6 <i>d.</i> ; Messengers, 7 <i>l.</i> 10 <i>s.</i> . . . . .	137	14	2			
Index Clerk and Money Takers, 89 <i>l.</i> 9 <i>s.</i> 6 <i>d.</i> ; Money-changers, Doorkeepers, &c., 113 <i>l.</i> 12 <i>s.</i> 6 <i>d.</i> . . . . .	203	2	0			
Lodgings for Judges, and other Officials . . . . .	122	6	6			
Stewards' Expenses, 304 <i>l.</i> 19 <i>s.</i> 7 <i>d.</i> ; Stables, &c., 34 <i>l.</i> 0 <i>s.</i> 1 <i>d.</i> . . . . .	338	19	8			
Refreshments for Stewards, Judges, and other Officials . . . . .	183	16	0			
Catalogues: Implements, 401 <i>l.</i> 2 <i>s.</i> 6 <i>d.</i> ; Stock, 227 <i>l.</i> 2 <i>s.</i> 2 <i>d.</i> ; Awards, 45 <i>l.</i> 10 <i>s.</i> 3 <i>d.</i> ; Plan of Yard, 25 <i>l.</i> ; Sellers, 78 <i>l.</i> 12 <i>s.</i> ; Carriage and Packing, 43 <i>l.</i> 14 <i>s.</i> 6 <i>d.</i> . . . . .	821	1	5			
Printing, 829 <i>l.</i> 9 <i>s.</i> 9 <i>d.</i> ; Advertising and Bill Posting, 1082 <i>l.</i> 14 <i>s.</i> . . . . .	1912	3	9			
Hay, 218 <i>l.</i> 16 <i>s.</i> 3 <i>d.</i> ; Straw, 384 <i>l.</i> 2 <i>s.</i> 7 <i>d.</i> ; Green Food, 539 <i>l.</i> 1 <i>s.</i> 1 <i>d.</i> ; Insurance, Surveyor, &c., 12 <i>l.</i> 1 <i>s.</i> . . . . .	1154	0	11			
Postage, Telegrams, Carriage, Stationery, Badges, &c. . . . .	153	9	7			
Repairs, Insurance, and Carriage of Testing Machinery . . . . .	33	6	11			
Horse Hire, 74 <i>l.</i> 3 <i>s.</i> 6 <i>d.</i> ; Carriages, &c., 75 <i>l.</i> 15 <i>s.</i> 7 <i>d.</i> . . . . .	149	19	1			
Trials: Surveyor, 2 <i>l.</i> 2 <i>s.</i> ; Damage to Crops, 30 <i>l.</i> . . . . .	32	2	0			
Hire of Furniture and Harmonium, 7 <i>l.</i> ; Hire of Clock, 16 <i>l.</i> 16 <i>s.</i> . . . . .	23	16	0			
Caps and Jackets for men, 18 <i>l.</i> 6 <i>s.</i> 8 <i>d.</i> ; Veterinary Medicines, 2 <i>l.</i> 6 <i>s.</i> 3 <i>d.</i> ; Whips, 6 <i>l.</i> ; Rakes, Buckets, Brooms, Baskets, &c., 7 <i>l.</i> 5 <i>s.</i> 6 <i>d.</i> . . . . .	33	18	5			
Solicitor's Fees at Inquest, 5 <i>l.</i> 10 <i>s.</i> ; Tan and Ashes, 42 <i>l.</i> 1 <i>s.</i> 6 <i>d.</i> ; Sundries, 8 <i>l.</i> 0 <i>s.</i> 3 <i>d.</i> . . . . .	55	11	9			
Rosettes, 17 <i>l.</i> 12 <i>s.</i> ; Medals, 7 <i>l.</i> 4 <i>s.</i> . . . . .	24	16	0			
Prizes: Stock* . . . . .	3570	0	0			
				£18,127	18	0
By Balance . . . . .				3,947	0	11
				£22,074	18	11

\* Exclusive of Local Prizes, 1810*l.*

## Bristol Meeting, 1878.

ON WEDNESDAY, THE 10<sup>TH</sup> OF JULY, AND FOUR FOLLOWING DAYS  
(SUNDAY EXCEPTED).

### SCHEDULE OF PRIZES.

#### LIVE-STOCK PRIZES.

Reference Number in Certificates.	HORSES.	First Prize.	Second Prize.	Thrd Prize.
Class	STALLIONS.	£.	£.	£.
1	Agricultural Stallion, foaled in the year 1876, <i>not qualified to compete as Clydesdale or Suffolk</i>	25	15	5
2	Agricultural Stallion, foaled before 1st January, 1876, <i>not qualified to compete as Clydesdale or Suffolk</i> .. .. .	50	20	10
3	Clydesdale Stallion, foaled in the year 1876 .. .. .	20	10	5
4	Clydesdale Stallion, foaled before the 1st of January, 1876 .. .. .	25	15	5
5	Suffolk Stallion, foaled in the year 1876 .. .. .	20	10	5
6	Suffolk Stallion, foaled before the 1st of January, 1876 .. .. .	25	15	5
7	Thorough-bred Stallion, suitable for getting Hunters .. .. .	50	20	10
8	Stallion, suitable for getting Hackneys .. .. .	20	10	5
9	Pony Stallion, above 13 hands 2 inches, and not exceeding 14 hands 2 inches .. .. .	20	10	5
10	Pony Stallion, not exceeding 13 hands 2 inches ..	15	10	5
	BROOD MARES.			
11	Agricultural Mare, in foal, or with foal at foot, <i>not qualified to compete as Clydesdale or Suffolk</i>	30	15	5
12	Clydesdale Mare, in foal, or with foal at foot ..	20	10	5
13	Suffolk Mare, in foal, or with foal at foot .. ..	20	10	5
14	Mare, in foal, or with foal at foot, suitable for breeding Hunters .. .. .	25	15	5
15	Mare, in foal, or with foal at foot, suitable for breeding Hackneys .. .. .	20	10	5
16	Pony Mare, in foal, or with foal at foot, above 13 hands 2 inches, and not exceeding 14 hands 2 inches .. .. .	15	10	5
17	Pony Mare, in foal, or with foal at foot, not ex- ceeding 13 hands 2 inches .. .. .	15	10	5

Reference Number in Certificates.		First Prize.	Second Prize.	Third Prize.	Fourth Prize.
	<b>HORSES—continued.</b>				
	<b>DRAUGHT GELDINGS AND FILLIES.</b>				
Class		£.	£.	£.	£.
18	Agricultural Filly (including Clydesdale and Suffolk), two years old .. .. .	20	10	5	
19	Agricultural Filly (including Clydesdale and Suffolk), three years old .. .. .	20	10	5	
	<b>HUNTERS.</b>				
20	Hunter Filly or Gelding, two years old .. ..	20	10	5	
21	Hunter Mare or Gelding, three years old .. ..	20	10	5	
22	Hunter Mare or Gelding, four years old .. ..	25	15	10	
23	Hunter Mare or Gelding, five years old and upwards, up to not less than 12 stone .. ..	30	20	10	
24	Hunter Mare or Gelding, five years old and upwards, up to not less than 15 stone .. ..	30	20	10	
	<b>HACKNEYS.</b>				
25	Hackney Mare or Gelding, up to not less than 12 stone .. .. .	20	10	5	
26	Hackney Mare or Gelding, up to not less than 15 stone .. .. .	20	10	5	
	<b>PONIES.</b>				
27	Pony Mare or Gelding, above 13 hands 2 inches, and not exceeding 14 hands 2 inches .. ..	15	10	5	
28	Pony Mare or Gelding, not exceeding 13 hands 2 inches .. .. .	15	10	5	
	<b>CATTLE.</b>				
	(ALL AGES CALCULATED TO JULY 1ST, 1878.)				
	<b>SHORTHORN.</b>				
29	Bull, above three years old .. .. .	30	20	15	10
30	Bull, above two and not exceeding three years old	25	15	10	5
31	Yearling Bull, above one and not exceeding two years old .. .. .	25	15	10	5
32	Bull-Calf, above six and not exceeding twelve months old .. .. .	20	15	10	5
33	Cow, above three years old .. .. .	20	15	10	5
34	Heifer, in-milk or in-calf, not exceeding three years old .. .. .	20	15	10	5
35	Yearling Heifer, above one and not exceeding two years old .. .. .	20	15	10	5
36	Heifer-Calf, above six and not exceeding twelve months old .. .. .	20	15	10	5
37	Cow, and not less than two of her offspring .. ..	30*	20*	10*	

\* Offered by the Gloucestershire Agricultural Society.

Reference Number in Certificates.	CATTLE— <i>continued.</i>	First Prize.	Second Prize.	Third Prize.
Class		£.	£.	£.
HEREFORD.				
38	Bull, above three years old .. .. .	25	15	5
39	Bull, above two and not exceeding three years old	25	15	5
40	Yearling Bull, above one and not exceeding two years old .. .. .	25	15	5
41	Bull-Calf, above six and not exceeding twelve months old .. .. .	15	10	5
42	Cow, above three years old .. .. .	20	10	5
43	Heifer, in-milk or in-calf, not exceeding three years old .. .. .	15	10	5
44	Yearling Heifer, above one and not exceeding two years old .. .. .	15	10	5
45	Heifer-Calf, above six and under twelve months old .. .. .	15	10	5
46	Cow, and not less than two of her offspring ..	30*	15*	10*
DEVON.				
47	Bull, above three years old .. .. .	25	15	5
48	Bull, above two and not exceeding three years old	25	15	5
49	Yearling Bull, above one and not exceeding two years old .. .. .	25	15	5
50	Bull-Calf, above six and not exceeding twelve months old .. .. .	15	10	5
51	Cow, above three years old .. .. .	20	10	5
52	Heifer, in-milk or in-calf not exceeding three years old .. .. .	15	10	5
53	Yearling Heifer, above one and not exceeding two years old .. .. .	15	10	5
54	Heifer-Calf, above six and under twelve months old	15	10	5
SUSSEX.				
55	Bull, above three years old .. .. .	15	10	..
56	Bull, above two and not exceeding three years old	15	10	..
57	Yearling Bull, above one and not exceeding two years old .. .. .	10	5	..
58	Bull-Calf, above six and not exceeding twelve months old .. .. .	10	5	..
59	Cow, above three years old .. .. .	15	10	..
60	Heifer, in-milk or in-calf, above two and not exceeding three years old .. .. .	15	10	..
61	Yearling Heifer, above one and not exceeding two years old .. .. .	10	5	..
62	Heifer-Calf, above six and not exceeding twelve months old .. .. .	10	5	..

\* Offered by the Gloucestershire Agricultural Society.

Reference Number in Certificates.		First Prize.	Second Prize.	Third Prize.
Class		£.	£.	£.
<b>CATTLE—continued.</b>				
<b>LONG-HORN.</b>				
63	Bull, above two years old .. .. .	15	10	..
64	Bull, above one and not exceeding two years old	15	10	..
65	Cow, in-calf or in-milk, above three years old ..	15	10	..
66	Heifer, in-calf or in-milk, not exceeding three years old .. .. .	15	10	..
<b>JERSEY.</b>				
67	Bull, above two years old .. .. .	15	10	5
68	Bull, above one and not exceeding two years old	15	10	5
69	Cow, above three years old .. .. .	15	10	5
70	Heifer, in-milk or in-calf, not exceeding three years old .. .. .	15	10	5
<b>GUERNSEY.</b>				
71	Bull, above one year old .. .. .	15	10	..
72	Cow, above three years old .. .. .	15	10	..
73	Heifer, in-milk or in-calf, not exceeding three years old .. .. .	15	10	..
<b>DAIRY CATTLE.</b>				
74	Pair of Dairy Cows, in-milk, over four years old, milking properties to be specially considered ..	20†	10†	5†
75	Pair of Dairy Cows, not exceeding four years old, same conditions .. .. .	20†	10†	5†
76	Pair of Heifers, in-calf, under three years old ..	15†	10†	5†
<b>WELSH BLACK.</b>				
77	Bulls, two years old and upwards .. .. .	20†	15†	10†
78	Bulls, not exceeding two years old .. .. .	20†	15†	10†
79	Cows, above three years old, in-calf or in-milk ..	15†	10†	5†
80	Heifer, above two and not exceeding three years old .. .. .	15†	10†	5†
81	Heifer, above one year and not exceeding two years old .. .. .	15†	10†	5†
<p><i>No Third Prize will be given unless at least Six entries be exhibited, and no Second Prize will be given unless at least Three entries be exhibited, except on the special recommendation of the Judges to the Stewards of Stock.</i></p>				

† Offered by the Bristol Local Committee.

‡ Offered by Noblemen and Gentlemen resident in Wales.

Reference Number in Certificates.		First Prize.	Second Prize.	Third Prize.
	<b>SHEEP.</b>			
Class	—	£.	£.	£.
	<b>LEICESTER.</b>			
82	Shearling Ram .. .. .	20	10	5
83	Ram of any other age .. .. .	20	10	5
84	Pen of Five Shearling Ewes, of the same flock ..	15	10	5
	<b>COTSWOLD.</b>			
85	Shearling Ram .. .. .	20	10	5
86	Ram of any other age .. .. .	20	10	5
	<b>A CHAMPION PRIZE of £25 for the Best Ram in either of the Classes Nos. 85 and 86, is offered by the Gloucestershire Agricultural Society.</b>			
87	Pen of Five Shearling Ewes, of the same flock ..	30§	10	5
	<b>LINCOLN.</b>			
88	Shearling Ram .. .. .	20	10	5
89	Ram of any other age .. .. .	20	10	5
90	Pen of Five Shearling Ewes, of the same flock ..	15	10	5
	<b>OXFORDSHIRE DOWN.</b>			
91	Shearling Ram .. .. .	20	10	5
92	Ram of any other age .. .. .	20	10	5
93	Pen of Five Shearling Ewes, of the same flock ..	15	10	5
	<b>SOUTHDOWN.</b>			
94	Shearling Ram .. .. .	20	10	5
95	Ram of any other age .. .. .	20	10	5
96	Pen of Five Shearling Ewes, of the same flock ..	15	10	5
	<b>SHROPSHIRE.</b>			
97	Shearling Ram .. .. .	20	10	5
98	Ram of any other age .. .. .	20	10	5
99	Pen of Five Shearling Ewes, of the same flock ..	15	10	5
	<b>HAMPSHIRE AND OTHER SHORT-WOOLLED BREEDS.</b>			
	<i>Not qualified to compete as Southdown or Shropshire.</i>			
100	Shearling Ram .. .. .	20	10	5
101	Ram of any other age .. .. .	20	10	5
102	Pen of Five Shearling Ewes, of the same flock ..	15	10	5

§ Of this sum, £15 is offered by the Gloucestershire Agricultural Society.



Prizes for Live Stock.

XXV

Reference Number in Certificates.		First Prize.	Second Prize.	Third Prize.
Class		£.	£.	£.
<b>SHEEP—continued.</b>				
<b>DEVON LONG WOOL.</b>				
103	Shearling Ram .. .. .	10	5	..
104	Ram, of any other age .. .. .	10	5	..
105	Pen of Five Shearling Ewes, of the same flock ..	10	5	..
<b>SOMERSET AND DORSET HORNED.</b>				
106	Shearling Ram .. .. .	10	5	..
107	Ram, of any other age .. .. .	10	5	..
108	Pen of Five Shearling Ewes, of the same flock ..	10	5	..
<b>DARTMOOR.</b>				
109	Shearling Ram .. .. .	10	5	..
110	Ram, of any other age .. .. .	10	5	..
111	Pen of Five Shearling Ewes, of the same flock ..	10	5	..
<b>EXMOOR.</b>				
112	Shearling Ram .. .. .	10	5	..
113	Ram, of any other age .. .. .	10	5	..
114	Pen of Five Shearling Ewes, of the same flock ..	10	5	..
<i>No Third Prize will be given unless at least Six animals be exhibited, and no Second Prize will be given unless at least Three animals be exhibited, except on the special recommendation of the Judges to the Stewards of Stock.</i>				
<b>PIGS.</b>				
<b>LARGE WHITE BREED.</b>				
115	Boar, above six months and not exceeding twelve months old .. .. .	10	5	..
116	Boar, above twelve months old .. .. .	10	5	..
117	Pen of Three Breeding Sow-Pigs of the same litter, above three and not exceeding six months old .. .. .	10	5	..
118	Breeding Sow .. .. .	10	5	..

Reference Number in Certificates.		First Prize.	Second Prize.	Third Prize.
	<b>PIGS—continued.</b>			
<b>Class</b>		<b>£.</b>	<b>£.</b>	<b>£.</b>
	<b>SMALL WHITE BREED.</b>			
119	Boar, above six months and not exceeding twelve months old .. .. .	10	5	..
120	Boar, above twelve months old .. .. .	10	5	..
121	Pen of Three Breeding Sow-Pigs of the same litter, above three and not exceeding six months old .. .. .	10	5	..
122	Breeding Sow .. .. .	10	5	..
	<b>SMALL BLACK BREED.</b>			
123	Boar, above six months and not exceeding twelve months old .. .. .	10	5	..
124	Boar, above twelve months old .. .. .	10	5	..
125	Pen of Three Breeding Sow-Pigs of the same litter, above three and not exceeding six months old .. .. .	10	5	..
126	Breeding Sow .. .. .	10	5	..
	<b>BERKSHIRE BREED.</b>			
127	Boar, above six months and not exceeding twelve months old .. .. .	10	5	..
128	Boar, above twelve months old .. .. .	10	5	..
129	Pen of Three Breeding Sow-Pigs of the same litter, above three and not exceeding six months old .. .. .	10	5	..
130	Breeding Sow .. .. .	10	5	..
	<b>OTHER BREEDS.</b>			
	<i>Not eligible to compete in any of the preceding Classes.</i>			
131	Boar, above six months and not exceeding twelve months old .. .. .	10	5	..
132	Boar, above twelve months old .. .. .	10	5	..
133	Pen of three Breeding Sow-Pigs of the same litter, above three and not exceeding six months old ..	10	5	..
134	Breeding Sow .. .. .	10	5	..
	<i>No Second Prize will be given unless at least Three entries be exhibited, except on the special recommendation of the Judges to the Stewards of Stock.</i>			

Reference Number in Certificates.		First Prize.	Second Prize.	Third Prize.	Fourth Prize.
	<b>CHEESE PRIZES.</b>				
	<i>Open to Makers only.</i>				
Class		£	£	£	£
135	Four Cheeses over 84 lbs. each, any make or colour, made in 1877 .. .. .	20†	15†	10†	
136	Four Cheeses under 84 lbs. each, made in 1877 ..	15†	10†	5†	
137	Four Cheeses over 70 lbs. each, made in 1878 ..	20†	15†	10†	
138	Four Cheeses under 70 lbs. each, made in 1878 ..	15†	10†	5†	
139	One cwt. of thin Cheese, under 20 lbs. each, made in 1878 .. .. .	20†	15†	10†	
140	One cwt. of thin Truckle Cheese, under 20 lbs. each, made in 1878 .. .. .	20†	15†	10†	
	<i>One Cheese from each First-Prize Lot to be the property of the Society for public tasting.</i>				
	<b>BUTTER PRIZES.</b>				
	<i>Open to Makers only.</i>				
141	Six Pounds of Fresh Butter, in 1-lb. or ½-lb. prints, or rolls .. .. .	10†	8†	5†	3†
142	Twenty Pounds of Salted Butter, to be delivered at Bristol twenty-eight days before the Show ..	7†	5†	4†	2†

† Offered by the Bristol Local Committee.

**IMPLEMENT PRIZES.**

Class	£
1. For the best Milk-can, suitable for conveying milk long distances by road or rail without injury .. .. .	10
2. For the best Churn for churning a sufficient quantity of milk to produce not more than 20 lbs. of Butter .. .. .	10
3. For the best Churn for churning a sufficient quantity of cream to produce not more than 20 lbs. of Butter .. .. .	10
4. For the best mechanical or automatic Butter-worker, suitable for large dairies and for factories .. .. .	10
5. For the best mechanical or automatic Butter-worker, suitable for small dairies; price to be specially considered .. .. .	10
6. For the best Cheese-tub; economy of labour to be specially considered .. .. .	10
7. For the best Curd-knife .. .. .	5
8. For the best Curd-mill .. .. .	5
9. For the best Cheese-turning apparatus .. .. .	10
10. For the best mechanical means of cleaning Churns and other Dairy utensils .. .. .	10
11. For the best automatic means of preventing the Rising of Cream ..	10
12. For the best Milk-cooler .. .. .	10
13. For the best method of keeping a large quantity of Milk at a temperature under 40° Fahr., for a period of not less than twelve hours, sufficiently economical for practical purposes .. .. .	20
14. For the best Milking-machine, to be tested during six consecutive months of the spring and summer of 1879 .. .. .	50

**GOLD MEDAL.**

The Gold Medal of the Society will be awarded at Bristol or any future Meeting of the Society, for an efficient Sheaf-binding Machine, either attached to a reaper or otherwise.

**SILVER MEDALS.**

There are Ten Silver Medals, the award of which the Judges appointed by the Council have the power of recommending in cases of sufficient merit in New Implements exhibited at the Bristol Meeting.

## CONDITIONS APPLYING TO CERTAIN CLASSES OF LIVE STOCK ONLY.

---

### HORSES.

1. All foals must be the offspring of the mare along with which they are exhibited; and the sire of the foal must be given on the certificate of entry.

2. No mare, entered in the classes for breeding animals, will be eligible for a prize unless certified either at the date of entry, or between the date of entry and that of the Show, to have had a living foal—or that the foal, *if dead*, was born at its proper time, in the year of the Show;—or in the event of a mare being exhibited *without* a foal at foot, a certificate shall be produced at the time of entry of her having been served, and the prize shall be withheld till a certificate be produced of her having produced a foal.

3. No veterinary inspection of horses will be required except when considered necessary by the Judges, who will be accompanied by the Veterinary Inspectors.

4. Hunters and Hackneys entered to compete in the light-weight classes will be disqualified if, in the opinion of the Judges, they are eligible to compete in the heavy-weight classes.

5. Horses entered as Clydesdales must be certified to have a recognised Clydesdale sire and sire of dam.

6. A charge of 1*l.* for the accommodation of a horse-box, in addition to the entry-fee, will be made for each entry for stallions and mares with foals at foot.

7. A charge of 10*s.* will be made, in addition to the entry-fee, for the accommodation of a stall for each animal in the other Horse Classes.

8. Any exhibitor wishing to remove his horse for the night will be allowed to do so on depositing 10*l.* at the Secretary's office, and receiving an official pass—the time of leaving, and that of returning next morning, to be inserted thereon; and if the animal be not duly brought back, the sum of 10*l.* will be forfeited to the Society for each Show day the animal is absent; and the exhibitor will also forfeit any prize awarded to him in any class at the Bristol Show, and will not be allowed to exhibit again at the Society's Show until the forfeits are paid.

### CATTLE.

9. No bull above two years old will be eligible for a prize unless certified to have served not less than three different cows (or heifers) within the three months preceding the 1st of June in the year of the Show.

10. All bulls above one year old shall have rings or "bull-dogs" in their noses, and be provided with leading sticks.

11. No cow will be eligible for a prize unless certified either at the date of entry or between the date of entry and that of the Show, to have had a living calf, or that the calf, if dead, was born at its proper time, within the twelve months preceding the date of the Show. Every Cow of the Channel Island breeds entered as in-milk, and every cow entered in the Dairy Classes, shall be milked dry on the evening preceding the Show, in the presence of an officer of the Society, specially appointed for the purpose.

*Conditions relating to Live Stock.*

12. No heifer, entered as in-calf, will be eligible for a prize unless she is certified to have been bulled before the 31st of March in the year of the Show, nor will her owner afterwards receive the prize until he shall have furnished the Secretary with a further certificate before the 31st of January in the subsequent year, that she produced a living calf; or that the calf, if dead, was born at its proper time.

13. Shorthorns.—Each animal entered in the Shorthorn Classes must be certified by the Exhibitor to be entered, or eligible to be entered, in Coates's Herd-Book.

## SHEEP.

14. All rams, except shearlings, must have been used in the preceding year.

15. Sheep exhibited for any of the prizes must have been *really and fairly shorn bare* after the 1st of April in the year of the Exhibition; and the date of such shearing must form part of the Certificate of Entry. Inspectors will be appointed by the Council to examine the sheep on their admission to the Show-Yard, with instructions to report to the Stewards any cases in which the sheep have not been *really and fairly shorn bare*.

## PIGS.

16. The three sow-pigs in each pen must be of the same litter.

17. The breeding sows in Classes 118, 122, 126, 130, and 134, shall be certified to have had a litter of live pigs within the six months preceding the Show, or to be in-pig at the time of entry, so as to produce a litter before the 1st of September following. In the case of in-pig sows, the prize will be withheld until the exhibitor shall have furnished the Secretary with a certificate of farrowing, as above.

18. No sow, if above eighteen months old, that has not produced a litter of live pigs, shall be eligible to compete in any of the classes.

19. The Judges of pigs will be instructed, with the sanction of the Stewards, to withhold prizes from any animals which shall appear to them to have been entered in a wrong class.

20. All pigs exhibited at the Country Meetings of the Society shall be subjected to an examination of their mouths by the Veterinary Inspector of the Society; and should the state of dentition in any pig indicate that the age of the animal has not been correctly returned in the Certificate of Entry, the Stewards shall have power to disqualify such pig, and shall report the circumstance to the Council at its ensuing Monthly Meeting. Every pig which shall be found on examination by the Inspector to be oiled or coloured will be disqualified for competition and removed from the Show-Yard; as well as any pig which shall be oiled or coloured while in the Show-Yard.

21. If a litter of pigs be sent with a breeding sow, the young pigs must be the produce of the sow, and must not exceed two months old.



## RULES OF ADJUDICATION.

1. As the object of the Society in giving prizes for cattle, sheep, and pigs, is to promote improvement in *breeding* stock, the Judges, in making their awards, will be instructed not to take into their consideration the present value to the butcher of animals exhibited, but to decide according to their relative merits for the purpose of *breeding*.

2. If, in the opinion of the Judges, there should be equality of merit, they will be instructed to make a special report to the Council, who will decide on the award.

3. The Judges will be instructed to withhold any prize if they are of opinion that there is not sufficient merit in any of the stock exhibited for such prize to justify an award.

4. The Judges will be instructed to give in a *Reserved Number* in each class of live stock; viz., which animal would, in their opinion, possess sufficient merit for the prize, in case the animal to which the prize is awarded should subsequently become disqualified.

5. In the classes for stallions, mares, and fillies, the Judges in awarding the prizes will be instructed, in addition to symmetry, to take activity and strength into their consideration.

6. The attention of the Stewards and Judges is particularly called to the conditions applying to pigs. The Senior Steward of Live Stock is requested to report any malpractices on the part of Exhibitors, and any person found guilty will not be allowed to exhibit at future Meetings of the Society.

The Judges will be instructed to deliver to the Stewards their awards signed, and stating the numbers to which the prizes are adjudged, before they leave the Yard, noting any disqualifications. They are to transmit, under cover to the Secretary, immediately after the Show, their Reports on the several classes in which they have adjudicated, in order that each Report may be included in the General Report of the Exhibition of Live Stock at Bristol, to be published in the 'Journal' of the Society.

---

## DATES OF ENTRY FOR LIVE STOCK AND IMPLEMENTS.

CERTIFICATES for the entry of Implements for the Bristol Meeting must be forwarded to the Secretary of the Society, No. 12, Hanover Square, London, W., by the 1st of May, and Certificates for the entry of Live Stock, Cheese, and Butter, by the 1st of June. Certificates received after those respective dates will not be accepted, but returned to the persons by whom they have been sent.

The Prizes of the Royal Agricultural Society of England, and all Prizes offered by the Bristol Local Committee, are open to general competition.

---

\* \* Forms of Certificate for entry, as well as Prize-Sheets for the Bristol Meeting, containing the whole of the conditions and regulations, may be obtained at the Office of the Society, No. 12, Hanover Square, London, W.

## MEMORANDA.

**ADDRESS OF LETTERS.**—The Society's office being situated in the postal district designated by the letter *W*, Members, in their correspondence with the Secretary, are requested to subjoin that letter to the usual address.

**GENERAL MEETING** in London, May 22, 1878, at 12 o'clock.

**MEETING** at Bristol, July 1878.

**GENERAL MEETING** in London, December, 1878.

**MONTHLY COUNCIL** (for transaction of business), at 12 o'clock on the first Wednesday in every month, excepting January, September, and October: open only to Members of Council and Governors of the Society.

**ADJOURNMENTS.**—The Council adjourn over Passion and Easter weeks, when those weeks do not include the first Wednesday of the month; from the first Wednesday in August to the first Wednesday in November; and from the first Wednesday in December to the first Wednesday in February.

**OFFICE HOURS.**—10 to 4. On Saturdays, 10 to 2.

**DISEASES OF CATTLE, SHEEP, and PIGS.**—Members have the privilege of applying to the Veterinary Committee of the Society, and of sending animals to the Brown Institution, Wandsworth Road, S.W.—(A statement of these privileges will be found on page xxxiii.)

**CHEMICAL ANALYSIS.**—The privileges of Chemical Analysis enjoyed by Members of the Society will be found stated in this Appendix (page xxxiv.).

**BOTANICAL PRIVILEGES.**—The Botanical and Entomological Privileges enjoyed by Members of the Society will be found stated in this Appendix (page xxxvi.).

**SUBSCRIPTIONS.**—1. **Annual.**—The subscription of a Governor is £5, and that of a Member £1, due in advance on the 1st of January of each year, and becoming in arrear if unpaid by the 1st of June. 2. **For Life.**—Governors may compound for their subscription for future years by paying at once the sum of £50, and Members by paying £10. Governors and Members who have paid their annual subscription for 20 years or upwards, and whose subscriptions are not in arrear, may compound for future annual subscriptions, that of the current year inclusive, by a single payment of £25 for a Governor, and £5 for a Member.

**PAYMENTS.**—Subscriptions may be paid to the Secretary, in the most direct and satisfactory manner, either at the Office of the Society, No. 12, Hanover Square, London, W., or by means of post-office orders, to be obtained at any of the principal post-offices throughout the kingdom, and made payable to him at the Vere Street Office, London, W.; but any cheque on a banker's or any other house of business in London will be equally available, if made payable on demand. In obtaining post-office orders care should be taken to give the postmaster the correct initials and surname of the Secretary of the Society (H. M. Jenkins), otherwise the payment will be refused to him at the post-office on which such order has been obtained; and when remitting the money-orders it should be stated by whom, and on whose account, they are sent. Cheques should be made payable as drafts on demand (not as bills only payable after sight or a certain number of days after date), and should be drawn on a London (not on a local country) banker. When payment is made to the London and Westminster Bank, St. James's Square Branch, as the bankers of the Society, it will be desirable that the Secretary should be advised by letter of such payment, in order that the entry in the banker's book may be at once identified, and the amount posted to the credit of the proper party. No coin can be remitted by post, unless the letter be registered.

**NEW MEMBERS.**—Every candidate for admission into the Society must be proposed by a Member; the proposer to specify in writing the full name, usual place of residence, and post-town, of the candidate, either at a Council meeting, or by letter addressed to the Secretary. Forms of Proposal may be obtained on application to the Secretary.

---

\* \* Members may obtain on application to the Secretary copies of an Abstract of the Charter and Bye-laws, of a Statement of the General Objects, &c., of the Society, of Chemical, Botanical, and Veterinary Privileges, and of other printed papers connected with special departments of the Society's business.

## Members' Veterinary Privileges.

### I.—SERIOUS OR EXTENSIVE DISEASES.

No. 1. Any Member of the Society who may desire professional attendance and special advice in cases of serious or extensive disease among his cattle, sheep, or pigs, and will address a letter to the Secretary, will, by return of post, receive a reply stating whether it be considered necessary that the Society's Veterinary Inspector should visit the place where the disease prevails.

No. 2. The remuneration of the Inspector will be 2*l.* 2*s.* each day as a professional fee, and 1*l.* 1*s.* each day for personal expenses; and he will also be allowed to charge the cost of travelling to and from the locality where his services may have been required. The fees will be paid by the Society, but the travelling expenses will be a charge against the applicant. This charge may, however, be reduced or remitted altogether at the discretion of the Council, on such step being recommended to them by the Veterinary Committee.

No. 3. The Inspector, on his return from visiting the diseased stock, will report to the Committee, in writing, the results of his observations and proceedings, which Report will be laid before the Council.

No. 4. When contingencies arise to prevent a personal discharge of the duties confided to the Inspector, he may, subject to the approval of the Committee, name some competent professional person to act in his stead, who shall receive the same rates of remuneration.

### II.—ORDINARY OR OTHER CASES OF DISEASE.

Members may obtain the attendance of the Veterinary Inspector on any case of disease by paying the cost of his visit, which will be at the following rate, viz., 2*l.* 2*s.* per diem, and travelling expenses. Applications should be addressed to the Superintendent of the Brown Institution, care of the Secretary of the Royal Agricultural Society, 12, Hanover Square, London, W.

### III.—CONSULTATIONS WITHOUT VISIT.

Personal consultation with Veterinary Inspector .. ..	5 <i>s.</i>
Consultation by letter .. ..	5 <i>s.</i>
Consultation necessitating the writing of three or more letters	10 <i>s.</i>
Post-mortem examination, and report thereon .. ..	10 <i>s.</i>

A return of the number of applications from Members of the Society during each half-year is required from the Veterinary Inspector.

### IV.—ADMISSION OF DISEASED ANIMALS TO THE BROWN INSTITUTION, WANDSWORTH ROAD, LONDON, S.W.; INVESTIGATIONS, LECTURES, AND REPORTS.

No. 1. All Members of the Society have the privilege of sending cattle, sheep, and pigs to the Infirmary of the Brown Institution, on the following terms; viz., by paying for the keep and treatment of cattle 10*s.* 6*d.* per week each animal, and for sheep and pigs "a small proportionate charge to be fixed by the Professor-Superintendent according to circumstances."

No. 2. The Professor-Superintendent of the Institution has also undertaken to carry out such investigations relating to the nature, treatment, and prevention of diseases of cattle, sheep, and pigs, as may be deemed expedient by the Council.

No. 3. A detailed Report of the cases of cattle, sheep, and pigs treated in the Infirmary of the Institution, or on Farms in the occupation of Members of the Society, will be furnished to the Council quarterly; and also special reports from time to time on any matter of unusual interest which may come under the notice of the Institution.

By Order of the Council,  
H. M. JENKINS, *Secretary.*

## Members' Privileges of Chemical Analysis.

THE Council have fixed the following rates of Charges for Analyses to be made by the Consulting Chemist for the *bonâ fide* use of Members of the Society; who, to avoid all unnecessary correspondence, are particularly requested, when applying to him, to mention the kind of analysis they require, and to quote its number in the subjoined schedule. The charge for analysis, together with the carriage of the specimens, must be paid to him by Members at the time of their application.

No. 1.—An opinion of the genuineness of Peruvian guano, bone-dust, or oil-cake (each sample) .. .. .	5s.
„ 2.—An analysis of guano; showing the proportion of moisture, organic matter, sand, phosphate of lime, alkaline salts and ammonia .. .. .	10s.
„ 3.—An estimate of the value (relatively to the average samples in the market) of sulphate and muriate of ammonia, and of the nitrates of potash and soda .. .. .	10s.
„ 4.—An analysis of superphosphate of lime for soluble phosphates only .. .. .	10s.
„ 5.—An analysis of superphosphate of lime, showing the proportions of moisture, organic matter, sand, soluble and insoluble phosphates, sulphate of lime, and ammonia ..	£1.
„ 6.—An analysis (sufficient for the determination of its agricultural value) of an ordinary artificial manure .. .. .	£1.
„ 7.—Limestone:—the proportion of lime, 7s. 6d.; the proportion of magnesia, 10s.; the proportion of lime and magnesia .. .. .	15s.
„ 8.—Limestone or marls, including carbonate, phosphate, and sulphate of lime and magnesia, with sand and clay ..	£1.
„ 9.—Partial analysis of a soil, including determinations of clay, sand, organic matter, and carbonate of lime .. .. .	£1.
„ 10.—Complete analysis of a soil .. .. .	£3.
„ 11.—An analysis of oil-cake or other substance used for feeding purposes; showing the proportion of moisture, oil, mineral matter, albuminous matter, and woody fibre; as well as of starch, gum, and sugar, in the aggregate ..	£1.
„ 12.—Analysis of any vegetable product .. .. .	£1.
„ 13.—Analysis of animal products, refuse substances used for manure, &c. .. .. . from 10s. to 30s.	
„ 14.—Determination of the “hardness” of a sample of water before and after boiling .. .. .	10s.
„ 15.—Analysis of water of land drainage, and of water used for irrigation .. .. .	£2.
„ 16.—Determination of nitric acid in a sample of water .. ..	£1.

N.B.—*The above Scale of Charges is not applicable to the case of persons commercially engaged in the Manufacture or Sale of any Substance sent for Analysis.*

The Address of the Consulting Chemist of the Society is, Dr. AUGUSTUS VOELCKER, F.R.S., 11, Salisbury Square, Fleet Street, London, E.C., to which he requests that all letters and parcels (Postage and Carriage paid) should be directed.

By Order of the Council,

H. M. JENKINS, *Secretary.*

## INSTRUCTIONS FOR SELECTING AND SENDING SAMPLES FOR ANALYSIS.

**ARTIFICIAL MANURES.**—Take a large handful of the manure from three or four bags, mix the whole on a large sheet of paper, breaking down with the hand any lumps present, and fold up in tinfoil, or in oil silk, about 3 oz. of the well-mixed sample, and send it to 11, SALISBURY SQUARE, FLEET STREET, E.C., by post: or place the mixed manure in a small wooden or tin box, which may be tied by string, but must not be sealed, and send it by post. If the manure be very wet and lumpy, a larger boxful, weighing from 10 to 12 oz., should be sent either by post or railway.

Samples not exceeding 4 oz. in weight may be sent by post, by attaching two penny postage stamps to the parcel.

Samples not exceeding 8 oz., for three postage stamps.

Samples not exceeding 12 oz., for four postage stamps.

The parcels should be addressed: DR. AUGUSTUS VOELCKER, 11, SALISBURY SQUARE, FLEET STREET, LONDON, E.C., and the address of the sender or the number or mark of the article be stated on parcels.

The samples may be sent in covers, or in boxes, bags of linen or other materials. No parcel sent by post must exceed 12 oz. in weight, 1 foot 6 inches in length, 9 inches in width, and 6 inches in depth.

**SOILS.**—Have a wooden box made 6 inches long and wide, and from 9 to 12 inches deep, according to the depth of soil and subsoil of the field. Mark out in the field a space of about 12 inches square; dig round in a slanting direction a trench, so as to leave undisturbed a block of soil with its subsoil from 9 to 12 inches deep; trim this block or plan of the field to make it fit into the wooden box, invert the open box over it, press down firmly, then pass a spade under the box and lift it up, gently turn over the box, nail on the lid and send it by goods or parcel to the laboratory. The soil will then be received in the exact position in which it is found in the field.

In the case of very light, sandy, and porous soils, the wooden box may be at once inverted over the soil and forced down by pressure, and then dug out.

**WATERS.**—Two gallons of water are required for analysis. The water, if possible, should be sent in glass-stoppered Winchester half-gallon bottles, which are readily obtained in any chemist and druggist's shop. If Winchester bottles cannot be procured, the water may be sent in perfectly clean new stoneware spirit-jars surrounded by wickerwork. For the determination of the degree of hardness before and after boiling, only one quart wine-bottle full of water is required.

**LIMESTONES, MARLS, IRONSTONES, AND OTHER MINERALS.**—Whole pieces, weighing from 3 to 4 oz., should be sent enclosed in small linen bags, or wrapped in paper. Postage 2*d.*, if under 4 oz.

**OILCAKES.**—Take a sample from the middle of the cake. To this end break a whole cake into two. Then break off a piece from the end where the two halves were joined together, and wrap it in paper, leaving the ends open, and send parcel by post. The piece should weigh from 10 to 12 oz. Postage, 4*d.* If sent by railway, one quarter or half a cake should be forwarded.

**FEEDING MEALS.**—About 3 oz. will be sufficient for analysis. Enclose the meal in a small linen bag. Send it by post.

On forwarding samples, separate letters should be sent to the laboratory, specifying the nature of the information required, and, if possible, the object in view.

H. M. JENKINS, *Secretary.*



## Members' Botanical and Entomological Privileges.

The Council have fixed the following Rates of Charge for the examination of Plants, Seeds, and Insects for the *bonâ fide* use of Members of the Society, who are particularly requested, when applying to the Consulting Botanist, to mention the kind of examination they require, and to quote its number in the subjoined Schedule. The charge for examination must be paid to the Consulting Botanist at the time of application, and the carriage of all parcels must be prepaid.

### I. BOTANICAL.

- |   |      |
|---|------|
| No. 1.—A report on the purity, amount and nature of foreign materials, perfectness, and germinating power of a sample of seeds .. .. .  | 5s.  |
| ,, 2.—Detailed report on the weight, purity, perfectness, and germinating power of a sample of seeds, with a special description of the weeds and other foreign materials contained in it .. .. . | 10s. |
| ,, 3.—Determination of the species of any weed or other plant, or of any epiphyte or vegetable parasite, with a report on its habits, and the means of its extermination or prevention .. .. .    | 5s.  |
| ,, 4.—Report on any disease affecting the farm crop .. .. .   | 5s.  |
| ,, 5.—Determination of the species of a collection of natural grasses found in any district on one kind of soil, with a report on their habits and pasture value .. .. .                          | 10s. |

### II. ENTOMOLOGICAL.

- |  |     |
|--|-----|
| ,, 6.—Determination of the species of any insect, worm, or other animal which, in any stage of its life, injuriously affects the farm crops, with a report on its habits and suggestions as to its extermination .. .. . | 5s. |
|--|-----|

### INSTRUCTIONS FOR SELECTING AND SENDING SAMPLES.

In sending seed or corn for examination the utmost care must be taken to secure a fair and honest sample. If anything supposed to be injurious or useless exists in the corn or seed, selected samples should also be sent.

In collecting specimens of plants, the whole plant should be taken up, and the earth shaken from the roots. If possible, the plant must be in flower or fruit. They should be packed in a light box, or in a firm paper parcel.

Specimens of diseased plants or of parasites should be forwarded as fresh as possible. Place them in a bottle, or pack them in tin-foil or oil-silk.

All specimens should be accompanied with a letter specifying the nature of the information required, and stating any local circumstances (soil, situation, &c.) which, in the opinion of the sender, would be likely to throw light on the inquiry.

N.B.—*The above Scale of Charges is not applicable in the case of Seedsmen requiring the services of the Consulting Botanist.*

Parcels or letters (Carriage or Postage prepaid) to be addressed to Mr. W. CARRUTHERS, F.R.S., 4, Woodside Villas, Gipsy Hill, London, S.E.

H. M. JENKINS, *Secretary.*



# Royal Agricultural Society of England.

1878-9.

## President.

H.R.H. THE PRINCE OF WALES, K.G.

## Trustees.

Year when Elec'ed.	
1855	ACLAND, Sir THOMAS DYKE, Bart., M.P., <i>Sprydoncote, Exeter, Devonshire.</i>
1857	BRIDPORT, General Viscount, <i>Cricknet St. Thomas, Chard, Somersetshire.</i>
1850	CHESHAM, Lord, <i>Latimer, Chesham, Bucks.</i>
1861	DENT, J. D., <i>Ribston Hall, Wetherby, Yorkshire.</i>
1863	KINGSCOTE, Colonel, M.P., <i>Kingscote, Wotton-under-Edge, Gloucestershire.</i>
1868	LICHFIELD, Earl of, <i>Slugborough, Staffordshire.</i>
1854	MACDONALD, Sir ARCHIBALD KEPPEL, Bt., <i>Woolmer Lodge, Liphook, Hants.</i>
1860	MARLBOROUGH, Duke of, K.G., <i>Blenheim Park, Oxford.</i>
1846	MILWARD, RICHARD, <i>Thurgarton Priory, Southwell, Notts.</i>
1839	PORTMAN, Viscount, <i>Bryanston, Blandford, Dorset.</i>
1856	POWIS, Earl of, <i>Powis Castle, Welshpool, Montgomeryshire.</i>
1858	RUTLAND, Duke of, K.G., <i>Belvoir Castle, Grantham, Leicestershire.</i>

## Vice-Presidents.

1873	BEDFORD, Duke of, <i>Woburn Abbey, Bedfordshire.</i>
1861	CATHCART, Earl, <i>Thornton-le-Street, Thirsk, Yorkshire.</i>
1839	CHICHESTER, Earl of, <i>Stanmer Park, Leves, Sussex.</i>
1867	DEVONSHIRE, Duke of, K.G., <i>Holker Hall, Lancashire.</i>
1847	EVERSLEY, Viscount, <i>Heckfield Place, Winchfield, Hants.</i>
1848	GIBBS, B. T. BRANDRETH, <i>Halfmoon Street, Piccadilly, London, W.</i>
1858	KERRISON, Sir EDWARD C., Bart., <i>Brome Hall, Scole, Suffolk.</i>
1852	RICHMOND AND GORDON, Duke of, K.G., <i>Goodwood, Chichester, Sussex.</i>
1859	VERNON, Lord, <i>Sudbury Hall, Derby.</i>
1861	WELLS, WILLIAM, <i>Holmewood, Peterborough, Northamptonshire.</i>
1855	WYNN, Sir WATKIN WILLIAMS, Bart., M.P., <i>Wynnstay, Ruabon, Denbighshire.</i>

## Other Members of Council.

1858	AMOS, CHARLES EDWARDS, 5, <i>Cedars Road, Clapham Common, Surrey.</i>
1877	ARKWRIGHT, J. H., <i>Hampton Court, Leominster, Herefordshire.</i>
1875	AVELING, THOMAS, <i>Rochester, Kent.</i>
1875	AYLMER, HUGH, <i>West Dereham, Stoke Ferry, Norfolk.</i>
1868	BOOTH, THOMAS CHRISTOPHER, <i>Wartaby, Northallerton, Yorkshire.</i>
1863	BOWLY, EDWARD, <i>Siddington House, Cirencester, Gloucestershire.</i>
1861	CANTRELL, CHARLES S., <i>Riding Court, Datchet (Bucks), Windsor.</i>
1874	CHANDOS-POLE-GELL, H., <i>Hopton Hall, Wirksworth, Derbyshire.</i>
1860	DRUCE, JOSEPH, <i>Eynsham, Oxford.</i>
1868	EDMONDS, WILLIAM JOHN, <i>Southrop, Lechlade, Gloucestershire.</i>
1871	EGERTON, Hon. WILBRAHAM, M.P., <i>Rostherne Manor, Knutsford, Cheshire.</i>
1873	EVANS, JOHN, <i>Uffington, Shrewsbury, Salop.</i>
1876	FEVERSHAM, Earl of, <i>Duncombe Park, Helmsley, Yorkshire.</i>
1875	FRANKISH, WILLIAM, <i>Limber Magna, Uleby, Lincolnshire.</i>
1874	HEMSLEY, JOHN, <i>Shelton, Newark, Notts.</i>

Year when Elected.	
1876	HOWARD, CHARLES, <i>Biddenham, Bedford.</i>
1878	HOWARD, JAMES, <i>Clapham Park, Bedfordshire.</i>
1871	JONES, J. BOWEN, <i>Ensdon House, Montford Bridge, R.S.O., Salop.</i>
1848	LAWES, JOHN BENNET, <i>Rothamsted, St. Albans, Herts.</i>
1869	LEEDS, ROBERT, <i>Keswick Old Hall, Norwich.</i>
1872	LEICESTER, EARL OF, K.G., <i>Holkham Hall, Wells, Norfolk.</i>
1874	LINDSAY, COLONEL LOYD, M.P., <i>Lockinge Park, Wantage, Berkshire.</i>
1865	LOPES, SIR MASSEY, BART., M.P., <i>Maristow, Roborough, Devon.</i>
1871	McINTOSH, DAVID, <i>Havering Park, Romford, Essex.</i>
1874	MARTIN, JOSEPH, <i>Highfield House, Littleport, Isle of Ely, Cambridgeshire.</i>
1871	MASFEN, R. HANBURY, <i>Pendeford, Wolverhampton, Staffordshire.</i>
1878	ODAMS, JAMES, <i>The Grange, Bishop Stortford, Herts.</i>
1857	PAIN, THOMAS, <i>The Grove, Basingstoke, Hants.</i>
1861	RANDELL, CHARLES, <i>Chadbury, Evesham, Worcestershire.</i>
1875	RANSOME, ROBERT CHARLES, <i>Ipswich, Suffolk.</i>
1867	RAVENSWORTH, EARL OF, <i>Ravensworth Castle, Durham.</i>
1871	RAWLENCE, JAMES, <i>Bulbridge, Wilton, Salisbury, Wilts.</i>
1869	RIDLEY, SIR M. WHITE, BART., M.P., <i>Blaydon, Cramlington, Northumberland.</i>
1861	RIGDEN, WILLIAM, <i>Ashcroft, Kingston-by-Sea, Shoreham, Sussex.</i>
1875	RUSSELL, ROBERT, <i>Farningham, Dartford.</i>
1874	SANDAY, GEORGE HENRY, <i>Wensley House, Bedale, Yorkshire.</i>
1878	SHERATON, WILLIAM, <i>Broom House, Ellesmere, Salop.</i>
1856	SHUTTLEWORTH, JOSEPH, <i>Hartsholme Hall, Lincoln.</i>
1872	SKELMERSDALE, LORD, <i>Lathom Hall, Ormskirk, Lancashire.</i>
1874	SPENCER, EARL, K.G., <i>Althorpe, Northampton.</i>
1875	STRATTON, RICHARD, <i>The Duffryn, Newport, Monmouthshire.</i>
1873	TOBB, JOHN, M.P., <i>Carlett Park, Eastham, Cheshire.</i>
1874	TURBERVILL, LIEUT.-COL. PICTON, <i>Evenny Priory, Bridgend, South Wales.</i>
1845	TURNER, GEORGE, <i>Great Bowley, Tiverton, Devonshire.</i>
1871	TURNER, JABEZ, <i>Norman Cross, Yaxley, Huntingdonshire.</i>
1871	WAKEFIELD, WILLIAM H., <i>Sedgwick, Kendal, Westmoreland.</i>
1870	WELBY-GREGORY, SIR WILLIAM EARLE, BART., M.P., <i>Denton Hall, Grantham, Lincolnshire.</i>
1870	WHITEHEAD, CHARLES, <i>Barming House, Maidstone, Kent.</i>
1865	WILSON, JACOB, <i>Woodhorn Manor, Morpeth, Northumberland.</i>
1878	WISE, GEORGE, <i>Woodcote, Warwick.</i>

### Secretary and Editor.

H. M. JENKINS, 12, Hanover Square, London, W.

- Consulting Chemist*—DR. AUGUSTUS VOELCKER, F.R.S., 11, *Salisbury Square*, E.C.  
*Consulting Botanist*—W. CARRUTHERS, F.R.S., F.L.S., *British Museum*, W.C.  
*Consulting Veterinary Surgeon*—JAMES BEART SIMONDS, *Royal Veterinary College, Camden Town*, N.W.  
*Veterinary Inspector*—W. DUGUID, *Brown Institution, Wandsworth Road*, S.W.  
*Consulting Engineers*—EASTONS & ANDERSON, 3, *Whitehall Place*, S.W.  
*Surveyor*—GEORGE HUNT, *Evesham, Worcestershire.*  
*Seedsmen*—THOMAS GIBBS and Co., *Corner of Halfmoon Street, Piccadilly*, W.  
*Publisher*—JOHN MURRAY, 50, *Albemarle Street*, W.  
*Bankers*—THE LONDON AND WESTMINSTER BANK, *St. James's Square Branch*, S.W.

**STANDING COMMITTEES FOR 1878-9.****Finance Committee.**

RANDELL, CHARLES (Chairman).	BOOTH, T. C.
BRIDPORT, General Viscount.	KINGSCOTE, Colonel.
RIDLEY, Sir M. WHITE, Bt.	SHUTTLEWORTH, J.

**House Committee.**

THE PRESIDENT.	CANTRELL, C. S.
CHAIRMAN of Finance Committee.	GIBBS, B. T. BRANDRETH.
BRIDPORT, General Viscount.	

**Journal Committee.**

DENT, J. D. (Chairman).	JONES, J. BOWEN.
CATHCART, Earl.	KINGSCOTE, Colonel.
VERNON, Lord.	MILWARD, RICHARD.
WELBY-GREGORY, Sir W. E., Bt.	RANSOME, R. C.
RIDLEY, Sir M. WHITE, Bt.	TURBERVILL, Lieut.-Col.
CHANDOS-POLE-GELL, H.	WELLS, W.
FRANKISH, W.	WHITEHEAD, CHARLES.
HEMSLEY, J.	

**Chemical Committee.**

WELLS, WILLIAM (Chairman).	HOWARD, C.
BEDFORD, Duke of.	HEMSLEY, J.
LICHFIELD, Earl of.	JONES, J. BOWEN.
VERNON, Lord.	LAWES, J. B.
MACDONALD, Sir A. K., Bart.	TUBERVILL, Lieut.-Col.
WELBY-GREGORY, Sir W. E., Bt.	VOELCKER, Dr. A.
ARKWRIGHT, J. H.	WAKEFIELD, W. H.
AVELING, T.	WARREN, R. A.
CARRUTHERS, W.	WHITEHEAD, CHARLES.
DENT, J. D.	WILSON, JACOB.
EDMONDS, W. J.	

**Seeds and Plant-Diseases Committee.**

WHITEHEAD, CHARLES (Chairman).	FRANKISH, W.
VERNON, Lord.	GIBBS, B. T. BRANDRETH.
RIDLEY, Sir M. WHITE, Bt.	JONES, J. BOWEN.
WELBY-GREGORY, Sir W. E., Bt.	TURBERVILL, Lieut.-Col.
CARRUTHERS, W.	VOELCKER, Dr.

**Veterinary Committee.**

EGERTON, Hon. WILBRAHAM (Chairman).	HARPLEY, M. J.
CATHCART, Earl.	KINGSCOTE, Colonel.
BRIDPORT, General Viscount.	LINDSAY, Colonel LOYD.
RIDLEY, Sir M. WHITE, Bt.	MILWARD, R.
BOOTH, T. C.	QUAIN, Dr.
BROWN, Professor.	SANDAY, G. H.
CARPENTER, Dr.	SANDERSON, Dr. J. BURDON.
CHANDOS-POLE-GELL, H.	SIMONDS, Professor.
DUGUID, W.	WAKEFIELD, W. H.
GIBBS, B. T. BRANDRETH.	WELLS, WILLIAM.
	WILSON, JACOB.

**Stock-Prizes Committee.**

MILWARD, RICHARD (Chairman).	BOWLY, EDWARD.	PAIN, T.
BRIDPORT, General Viscount.	CHANDOS-POLE-GELL, H.	RIGDEN, WILLIAM.
RIDLEY, Sir M. WHITE, Bt.	EVANS, JOHN.	SANDAY, G. H.
ARKWRIGHT, J. H.	FRANKISH, W.	STRATTON, R.
AYLMER, H.	GIBBS, B. T. BRANDRETH.	TORR, J.
BOOTH, T. C.	HEMSLEY, J.	WAKEFIELD, W. H.
	HOWARD, C.	WILSON, JACOB.
	McINTOSH, D.	The Stewards of Live Stock.
	MASFEN, R. H.	

**Implement Committee.**

HEMSLEY, J. (Chairman).	CANTRELL, CHAS. S.	SANDAY, G. H.
BRIDPORT, Gen. Viscount.	EDMONDS, W. J.	SHUTTLEWORTH, JOSEPH.
VERNON, Lord.	FRANKISH, W.	TURBERVILL, Lieut.-Col.
MACDONALD, Sir A. K., Bt.	GIBBS, B. T. BRANDRETH.	TURNER, JABEZ.
AMOS, C. E.	JONES, J. BOWEN.	WHITEHEAD, CHARLES.
ANDERSON, W.	MARTIN, J.	WILSON, JACOB.
AVELING, T.	MILWARD, R.	The Stewards of Imple-
BOOTH, T. C.	RANSOME, R. C.	ments.

**General London Exhibition Committee.**

KINGSCOTE, Col. (Chairman).	GILBEY, WALTER.	SHUTTLEWORTH, J.
BRIDPORT, Gen. Viscount.	HADLEY, Alderman.	SIMONDS, Professor.
CHESHAM, Lord.	HAMBRO, CHARLES.	SOULSBY, W. J.
GROSVENOR, Lord R.	HOWARD, C.	STAPLES, Alderman and
SKELMERSDALE, Lord.	HEMSLEY, J.	Sheriff.
EGERTON, Hon. W.	JONES, J. BOWEN.	STRATTON, R.
ALLENDER, G. M.	MCINTOSH, D.	TURBERVILL, Lieut.-Col.
AVELING, T.	MARTIN, J.	TURNER, JABEZ.
AYLMER, H.	MASFEN, R. H.	WAKEFIELD, W. H.
BOOTH, T. C.	RANDELL, CHARLES.	WELLS, W.
CANTRELL, CHARLES S.	RANSOME, R. C.	WHETHAM, Alderman Sir
CHANDOS-POLE-GELL, H.	RAWLENCE, J.	CHARLES.
FRANKISH, W.	RUSSELL, R.	WHITEHEAD, CHARLES.
GIBBS, B. T. BRANDRETH.	SANDAY, G. H.	WILSON, JACOB.

**Show-Yard Contracts Committee.**

WILSON, JACOB (Chairman).	FRANKISH, W.
BRIDPORT, General Viscount.	GIBBS, B. T. BRANDRETH.
AMOS, C. E.	MILWARD, RICHARD.
AVELING, T.	RANDELL, CHARLES.
BOOTH, T. C.	SHUTTLEWORTH, JOSEPH.
CHANDOS-POLE-GELL, H.	STRATTON, R.

**Committee of Selection.**

CATHCART, Earl (Chairman).	CHANDOS-POLE-GELL, H.
BRIDPORT, General Viscount.	MILWARD, R.
EGERTON, Hon. W.	WILSON, JACOB.
BOOTH, T. C.	

And the Chairmen of the Standing Committees.

**Education Committee.**

BEDFORD, Duke of (Chairman).	KINGSCOTE, Colonel.
AVELING, T.	TURBERVILL, Lieut.-Col.
CARRUTHERS, W.	VOELCKER, Dr.
DENT, J. D.	WELLS, WILLIAM.
JONES, J. BOWEN.	WHITEHEAD, CHARLES.

**Cattle Plague Committee.**

THE WHOLE COUNCIL.

\*.\* The PRESIDENT, TRUSTEES, and VICE-PRESIDENTS are Members *ex officio* of all Committees.

## Royal Agricultural Society of England.

---

---

### GENERAL MEETING,

12, HANOVER SQUARE, WEDNESDAY, MAY 22ND, 1878.

---

#### REPORT OF THE COUNCIL.

THE Council of the Royal Agricultural Society have to report that, since the last General Meeting in December, the following changes have taken place in the list of Members—2 Governors and 42 Members have died, 114 Members resigned in the course of 1877, and the names of 37 others have been struck off the list by order of the Council. On the other hand, 189 Members and 3 Honorary Members have been elected, so that the Society now consists of:—

81 Life Governors,  
72 Annual Governors,  
2328 Life Members,  
4130 Annual Members,  
26 Honorary Members,

---

Total- - 6637

The Council announce with great regret the death of two valued colleagues, namely, Mr. T. Horley, Jun., of The Fosse, near Leamington, and Mr. Richard Hornsby, of Spittlegate, Grantham. These vacancies in the Council have been filled by the election of Mr. George Wise, of Woodcote, Warwick, and Mr. James Odams, of the Grange, Bishop Stortford.

The Council have to report that they have elected Mr. George Fleming, Veterinary Surgeon, 2nd Life Guards, Pro-

essor G. T. Brown, of the Veterinary Department of the Privy Council, and Dr. Burdon Sanderson, F.R.S., Professor-Superintendent of the Brown Institution, Honorary Members of the Society in recognition of their eminent services to Veterinary Science.

The accounts for the year 1877 have been examined and certified by the Auditors and Accountants of the Society, and have been published in the last number of the 'Journal,' together with the statement of receipts and expenditure connected with the Liverpool Meeting. The funded property of the Society remains the same as at the last General Meeting, namely, 26,511*l.* 11*s.* 5*d.* New Three per Cents. The balance of the current account in the hands of the bankers, on the 1st instant, was 3,668*l.* 12*s.* 8*d.*, and 3000*l.* remained on deposit; these sums will eventually be required to meet the expenses of the Bristol Meeting.

The increased and still increasing operations of the Society have led the Council to consider whether the Secretary and Editor is adequately remunerated for the additional labour and responsibility involved in the performance of his duties; and, as an acknowledgment of the high sense entertained by the Council of the ability and energy shown by Mr. Jenkins in the performance of those duties, they have resolved that an addition of 200*l.* per annum be made to his salary.

The Bristol Meeting will be held on Durdham Down, on July 10th, and four following days, and will be distinguished by an exhaustive trial of Dairy appliances, the improvement of which is annually becoming of more importance to the English dairy-farmer, both on account of the great scarcity and increasing cost of skilled labour, and in consequence of the improved quality of Foreign Dairy products. The encouragement of Dairy farming will also be promoted by the competition for the Prizes offered by the Local Committee, not only for Cheese and Butter, but also for the best managed Dairy Farms in Gloucestershire, East Somerset, and North Wilts, for which there are 15 entries. For the Prizes offered for Arable Farms in the same district only 3 entries have been made.

The district assigned for the Country-meeting of 1879 comprises the counties of Norfolk, Suffolk, Cambridge, Huntingdon,



Bedford, Buckingham, Oxford, Hertford, Essex, and Middlesex. At a public meeting held at the Mansion House under the presidency of the Lord Mayor, it was unanimously resolved that it was desirable to promote the holding of a great Agricultural Exhibition in London next year, under the auspices of the Society; and an influential Committee was appointed to carry out that object and to co-operate with the Council. The Council have therefore decided that the Meeting of 1879 shall be held in the county of Middlesex as near London as possible, and that it shall be planned on an extended basis and assume an international character.

Under such distinctive and favourable circumstances, His Royal Highness the Prince of Wales has intimated his willingness to accept the Presidency of the Society for the ensuing year.

During the past half-year, the Chemical Committee have had under consideration two special subjects of the greatest importance to the Members of the Society. With regard to the first of these—the Experiments at Woburn are being carried on satisfactorily, and a Report of their progress has been lately published in the ‘Journal.’ The Council regret that Mr. Lawes has retired from active participation with Dr. Voelcker in the management of the experiments, but they are happy to say that they will not be deprived of the great advantage of his advice and assistance. An expression of the Council’s regret at Mr. Lawes’ resignation, and a vote of thanks to him for the labour and time he had bestowed on the initiation and superintendence of the experiments was unanimously passed at the April meeting. The Chemical Committee, with the sanction of the Council, have drawn up some rules for the future management of Crawley Farm, and of the Experimental Field, the former being under the management of a Sub-Committee, the latter under that of Dr. Voelcker, and both under the control of the Chemical Committee.

The second subject refers to the Members’ privileges of chemical analysis. The Quarterly Reports of the Chemical Committee have demonstrated the necessity of purchasing artificial manures and feeding stuffs by guaranteed analysis, and of checking the quality of the bulk as delivered, by sending in a

sample of it to a qualified chemist for analysis. This practice, however, must entail an additional cost, which to the small purchaser would be an appreciable addition to the price of his manures and feeding stuffs. The Council, therefore, referred it to the Chemical Committee to consider at what cheaper rate than at present analyses of manures, feeding stuffs, and other substances used in agriculture could be made by the Consulting Chemist for the *bonâ fide* and sole use of Members of the Society, if the Society provided the Chemist with a laboratory and staff entirely devoted to that purpose, and what additional cost such a plan would be to the Society.

The Chemical Committee thereupon drew up a comprehensive plan, which has been adopted by the Council subject to its practicability being ascertained, whereby a laboratory and all its adjuncts will be provided for the Consulting Chemist in the Society's house, and the fees for analysis to be then charged to Members of the Society will be reduced to about one-half of their present amounts.

The experiments with reference to pleuro-pneumonia have been continued at the Brown Institution; and an exhaustive paper on the pathological anatomy of the disease, by Dr. Yeo, was published in the last number of the 'Journal.'

The improved method of inoculation for pleuro-pneumonia, with reference to its preventive efficacy, is about to be tried on a larger scale than has hitherto been possible, and in districts in which disease actually prevails. With this view, the Council trust that owners of stock will co-operate with them by allowing their uninfected animals to be inoculated by the Society's officers, it being understood that compensation will be made by the Society for any losses arising directly from the inoculation.

The Council have to report that four candidates competed for the Society's Medals and Prizes offered to Members of the Royal College of Veterinary Surgeons for proficiency in the pathology, causes, symptoms, and treatment (preventive and curative) of cattle, sheep, and pigs. The successful candidates were:—

Mr. M. HEDLEY, 14, Kiry Street, Stranraer, N. B.,

Mr. T. CHAMBERS, Nuneaton, Warwickshire,

Mr. ROBERT E. HOILE, Lympne, Hythe, Kent.

They have also to report that six candidates presented themselves last month for examination for the Society's Senior Prizes and Certificates, including the Life Membership of the Society. Of these, Mr. James Mollison, of the Agricultural College, Cirencester, was the only one who passed; and he obtained a First-class Certificate, the Life Membership of the Society, and a Prize of 25*l*.

By order of the Council,

H. M. JENKINS, *Secretary.*

# ROYAL AGRICULTURAL

DR.

## HALF-YEARLY CASH ACCOUNT

	£	s.	d.		£	s.	d.
To Balance in hand, 1st July, 1878:—							
Bankers .. .. .	250	8	2				
Secretary .. .. .	20	9	6				
	270	17	8				
At Deposit, London and Westminster Bank .. .. .	1,000	0	0		1,270	17	8
To Income:—							
Dividends on Stock .. .. .	392	14	0				
Subscriptions:—							
Governors' Annual .. .. .	£	s.	d.	340	0	0	
Members' Life-Compositions .. .. .	706	0	0				
Members' Annual .. .. .	3292	19	0	4,338	19	0	
Establishment:—							
Rent .. .. .	100	0	0				
Farm Prizes:—							
Entry Fees .. .. .	9	0	0				
Veterinary:—							
Donation from Yorkshire Agricultural Society.. .. .	100	0	0				
Liverpool Meeting .. .. .	118	10	0				
Total Income .. .. .	5,059	3	0		5,059	3	0
To Bristol Meeting .. .. .					6,409	12	9
					£12,739	13	5

### BALANCE-SHEET,

	£	s.	d.		£	s.	d.
To Capital:—							
Surplus, 31st December, 1877 .. .. .	30,126	6	11				
Surplus of Income over Expenditure during the Half-year, viz.:—							
Income .. .. .	£	s.	d.	5,059	3	0	
Expenditure .. .. .	3,287	1	4	1,772	1	8	
Less: half-year's interest and depreciation on } Country Meeting Plant .. .. . }							
					31,898	8	7
					154	19	9
					£31,743	8	10

# SOCIETY OF ENGLAND.

FROM 1ST JANUARY TO 30TH JUNE, 1878.

CR.

	£ s. d.	£ s. d.	£ s. d.
<b>By Expenditure:—</b>			
<b>Establishment:—</b>			
Salaries, Wages, &c. . . . .	642 10 0		
House:—Rent, Taxes, Repairs, &c. . . . .	344 13 5		
Office:—Printing, Postage, Stationery, &c. . . . .	345 13 0		
		1,332 16 5	
<b>Journal:—</b>			
Printing and Stitching . . . . .	410 19 5		
Postage and Delivery . . . . .	155 0 0		
Literary Contributions . . . . .	253 14 6		
Lithography . . . . .	14 0 0		
Advertising . . . . .	8 7 0		
		842 0 11	
Literary Contributions to Memoir prepared for) International Congress at Paris . . . . .		192 17 0	
<b>Chemical:—</b>			
Consulting Chemist's Salary . . . . .	150 0 0		
Grant for Investigations . . . . .	200 0 0		
		350 0 0	
<b>Veterinary:—</b>			
The Brown Institution for Investigations to } June 30, 1878. . . . .	125 0 0		
Prizes and Medals . . . . .	47 12 0		
Fees to Examiners . . . . .	21 0 0		
Professional Fee . . . . .	14 18 6		
		208 10 6	
<b>Botanical:—</b>			
Consulting Botanist's Salary . . . . .		50 0 0	
<b>Education:—</b>			
Fees to Examiners . . . . .	52 10 0		
Printing . . . . .	14 9 0		
Prize . . . . .	25 0 0		
		91 19 0	
Subscriptions (paid in error) returned . . . . .		3 2 0	
<b>Farm Prizes:—</b>			
Advertising and Printing . . . . .		65 19 6	
Liverpool Meeting . . . . .		149 16 0	
<b>Total Expenditure . . . . .</b>			3,287 1 4
<b>By Bristol Meeting . . . . .</b>			2,957 2 0
<b>By Balance in hand, 30th June:—</b>			
Bankers . . . . .	3467 5 8		
Secretary . . . . .	24 4 5		
		3,495 10 1	
At Deposit, London and Westminster Bank . . . . .		3,000 0 0	
			6,495 10 1
			<b>£12,739 13 5</b>

30TH JUNE, 1878.

ASSETS.		£ s. d.	£ s. d.
By Cash in hand . . . . .		3,495 10 1	
By New 3 per Cent. Stock 26,511 <i>l.</i> 11 <i>s.</i> 5 <i>d.</i> cost* . . . . .		25,340 7 1	
By Books and Furniture in Society's House . . . . .		1,451 17 6	
By Country Meeting Plant . . . . .		1,903 4 11	
By Deposit Account . . . . .		3,000 0 0	
			35,195 19 7
Less at credit of Bristol Meeting . . . . .			3,452 10 9
* Value at 96½ = £25,517 <i>Ts.</i> 8 <i>d.</i>			
<i>Mem.</i> —The above Assets are exclusive of the amount recoverable in respect of arrears of Subscription to 30th June, 1878, which at that date amounted to 154 <i>l.</i>			
			<b>£31,743 8 10</b>

Examined, audited, and found correct, this 12th day of August, 1878.

FRANCIS SHERBORN,  
A. H. JOHNSON,  
HENRY CANTRELL.

Auditors on behalf of the Society.

SHOW AT BRISTOL,  
JULY, 1878.

---

---

STEWARDS OF THE YARD.

**Stock.**

JOSEPH SHUTTLEWORTH,  
WILLIAM WELLS,  
LT.-COL. PICTON-TURBERVILL.  
CHARLES WHITEHEAD.

**Implements.**

JOHN HEMSLEY,  
G. H. SANDAY.  
WILLIAM FRANKISH.

**Forage.**

THOMAS DYKE.

**General Arrangements.**

JACOB WILSON.

---

JUDGES OF STOCK.

**HORSES.**

**Agricultural Horses.**

A. W. CRISP,  
ANDREW MONTGOMERY,  
THOS. PLOWRIGHT, JUN.

**Thoroughbred and Riding Horses.**

DIGBY COLLINS,  
THOMAS PAIN,  
THOMAS PARRINGTON.

**CATTLE.**

**Shorthorns.**

CHARLES HOWARD,  
JOHN LYNN,  
GEORGE MANN.

**Herefords.**

G. W. BAKER,  
J. CRANE,  
JOHN WALKER.

**Devons and Sussex.**

HENRY OVERMAN,  
JOSIAH PITCHER,  
THOMAS POPE.

**Longhorns and Dairy Cattle.**

WILLIAM T. CARRINGTON,  
R. H. CHAPMAN,  
JOHN DENCHFIELD.

**Jerseys and Guernseys.**

WALTER GILBEY,  
C. STEPHENSON.

**Welsh Cattle.**

JOHN EVANS,  
JOHN WILLIAMS.

**SHEEP.**

**Leicesters.**

JOHN S. JORDAN,  
WILLIAM SANDAY.

**Cotswolds.**

W. T. GARNE,  
THOMAS PORTER.

**Lincolns.**

W. COLLINGWOOD,  
CHARLES WILLIAMS.

**Oxfordshire Downs.**

G. HITCHMAN,  
R. J. NEWTON.

**Southdowns and Hampshires.**

F. BUDD,  
HENRY FOKES,  
F. M. JONAS.



**Shropshires.**

JOHN COXON,  
R. H. MASFEN,  
CHARLES RANDELL.

**Somerset and Dorset Horned,  
Dartmoors, and Exmoors.**

WILLIAM BENJ. HEBDITCH,  
WILLIAM POOLE.

**Devon Long Wools.**

JAMES TREMAINE,  
THOMAS WILLIS, JUN.

**PIGS.**

JOHN FISHER,  
EDWARD LITTLE,  
MATTHEW WALKER.

---

**JUDGES OF CHEESE.**

R. P. EDWARDS,

| JAMES HUGHES.

---

**JUDGES OF BUTTER.**

JOSEPH MATTHEWS,

| WILLIAM TITLEY.

---

**JUDGES OF IMPLEMENTS.**

**Sheaf Binders and Miscellaneous.**

HENRY CANTRELL,

| JOHN COLEMAN,

| J. W. KIMBER.

**Dairy Implements.**

G. M. ALLENDER,

| GILBERT MURRAY,

| THOMAS RIGBY.

---

**FARM JUDGES.**

FREDERIC BEARD,

| T. F. JACKSON,

| THOMAS WILLIS.

---

## AWARD OF PRIZES.

NOTE.—The Judges were instructed, in addition to awarding the Prizes, to designate as the *Reserve Number* one animal in each Class, next in order of merit, if it possessed sufficient for a Prize; in case an animal to which a Prize was awarded should subsequently become disqualified.

### HORSES.

#### *Agricultural Stallions—Two Years old.*

- THE EARL OF ELLESMERE, Worsley Hall, Manchester : FIRST PRIZE, 25*l.*, for “Young Prince of the Isle,” bay; bred by Mr. Fryer, Somersham, St. Ives; sire, “Prince of the Isle;” dam by “Honest Tom.”
- FREDERICK STREET, Somersham Park, St. Ives, Hunts : SECOND PRIZE, 15*l.*, for “Grand Duke,” iron grey; bred by Mr. Parsons, Somersham; sire, Mr. Wark’s “Grey Horse;” dam by Mr. Nix’s “Captain.”
- THE EARL OF ELLESMERE, Worsley Hall : THIRD PRIZE, 5*l.*, for “Young Drayman,” bay; bred by Mr. J. Oxley, Bold Field, Gainsborough; sire, “Daysman;” dam by “Lincolnshire Lad.”

#### *Agricultural Stallions, foaled before the 1st of January, 1876.*

- STEPHEN DAVIS, Woolashill, Pershore, Worcestershire : FIRST PRIZE, 50*l.*, for “General,” roan, 5 years-old; bred by himself; sire, “The Captain;” dam, “Pleasant.”
- G. HERBERT MORRELL, Headington Hill Hall, Oxford : SECOND PRIZE, 20*l.*, for “King of the Vale,” blue roan, 4 years-old; bred by Mr. E. Clift, Weeden Hall, Aylesbury, Bucks; sire, “King of the Valley;” dam, “Flower.”
- THE EARL OF ELLESMERE, Worsley Hall, Manchester : THIRD PRIZE, 10*l.*, for “Pride of the Shires,” bay, 6 years-old; bred by Mr. Lyon, Chatteris; sire, “Young England’s Glory;” dam by Owen’s “Honest Tom.”
- JAMES HIBBARD, Sen., Stanton Manor Farm, Chippenham, Wilts : the *Reserve Number* to “The Sultan,” bright bay, 4 years-old; bred by himself; sire, “The Quail;” dam, “Diamond,” by “King of the Valleys.”

#### *Clydesdale Stallions—Two Years old.*

- ROBERT LODER, Whittlebury, Towcester, Northamptonshire : FIRST PRIZE, 20*l.*, for “Scotland Yet,” bay; bred by Mr. Adam Gray, Ingleston, Borge, Kirkcudbright; sire, “Young Sir Walter;” dam, “Kate,” by “Galloway Tom.”

THE DUKE OF BEAUFORT, K.G., Badminton, Chippenham, Wilts: SECOND PRIZE, 10*l.*, for "Prince Charlie," brown; bred by himself; sire, "Paragon Tom;" dam, "Guess," by "Young Clyde."

VINCENT P. CALMADY, Tetcott, Holsworthy, Devonshire: the *Reserve Number* to "Waverley," bay; bred by Mr. William Shanks, Dalnattar, Old Kilpatrick, Dumbartonshire; sire, "Lochburnie Crown Prince;" dam, "Jess," by "Logan's Turin."

*Clydesdale Stallions foaled before the 1st of January, 1876.*

JAMES FIRTH CROWTHER, Knowle Grove, Mirfield, Yorkshire: FIRST PRIZE, 25*l.*, for "Topsman," dark chestnut, 9 years-old; bred by Mr. George Wilson, Whiteside, Alford, Aberdeenshire; sire, "Wonderful;" dam by "Samson."

THE DUKE OF BEAUFORT, K.G., Badminton, Chippenham, Wilts: SECOND PRIZE, 15*l.*, for "Paragon Tom," brown, 11 years-old; bred by Mr. George Wilson, Whiteside, Alford, Aberdeen; sire, "Tom of Lincoln;" dam, "Jean," by "Sampson."

EDWARD and ALFRED STANFORD, Eatons, Ashurst, Steyning, Sussex: THIRD PRIZE, 5*l.*, for "The Baronet," bay, 3 years-old; bred by Mr. William Stanford, Charlton Court, Steyning; sire, "The Duke;" dam, "Venture," by "Sampson."

LORD FITZHARDINGE, Berkeley Castle, Gloucestershire: the *Reserve Number* to "Prince of Clydesdale," bay, 7 years-old; bred by Mr. N. Fleming, Knockdown, Ayrshire; sire, "Prince Christian;" dam, "Darling," by "Samson."

*Suffolk Stallions—Two Years old.*

WILLIAM BYFORD, The Court, Glemsford, Suffolk: FIRST PRIZE, 20*l.*, for "Reliance," chestnut; bred by Mr. Sturgeon, Ousden, Newmarket, Suffolk; sire, "Volunteer;" dam, "Violet," by "The Hero."

WILLIAM WILSON, Baylhamall, Ipswich, Suffolk: the *Reserve Number* to "Farmer's Glory," bright chestnut, bred by Mr. Waspe, Ufford, Woodbridge, Suffolk; sire, "Barne's Horse of Kettleborough;" dam, "Smart."

*Suffolk Stallions foaled before the 1st of January, 1876.*

HORACE WOLTON, Newbourn Hall, Woodbridge, Suffolk: FIRST PRIZE, 25*l.*, for "Royalty," bright chestnut, 7 years-old; bred by himself; sire, "Magnum Bonum;" dam, "Duchess of Newbourn," by "Warrior."

GEORGE EDWIN ELLIOTT, Monkaton Manor, Pinhoe, Exeter: SECOND PRIZE, 15*l.*, for "Iron Duke," dark chestnut, 3 years-old; bred by Mr. Horace Wolton, The Grange, Woodbridge, Suffolk; sire, "Royalist;" dam, "Bragg," by Bobby's "Royal Prince."

WILLIAM BYFORD, The Court, Glemsford, Suffolk: the *Reserve Number* to "Enterprise," chestnut, 4 years-old; bred by himself; sire, "Volunteer;" dam, "Depper," by "The Emperor."

*Thoroughbred Stallions suitable for getting Hunters.*

THE DUKE OF HAMILTON AND BRANDON, Easton Park, Wickham Market, Suffolk: FIRST PRIZE, 50*l.*, for "Preakness," bay, 11 years-old; bred by

Mr. R. A. Alexander, State of Kentucky, America; sire, "Lexington;" dam, "Bay Leaf," by "Yorkshire."

THOMAS GEE, Dewhurst Lodge, Wadhurst, Hawkhurst, Kent: SECOND PRIZE, 20*l.*, for "Citadel," chestnut, 19 years-old; bred by the Earl of Derby, Knowsley, Prescott; sire, "Stockwell;" dam, "Sortie," by "Melbourne."

HENRY WILLIAM FREEMAN, Newbridge Hill Stud Farm, Bath: THIRD PRIZE, 10*l.*, for "Claudius," bay, 11 years-old; bred by Mr. C. Snewing, Holywell Stud Farm, Rugby; sire, "Caractacus;" dam, "Lady Peel," by "Orlando."

THE DUKE OF HAMILTON AND BRANDON, Easton Park, Wickham Market: the *Reserve Number* to "Barbillion," brown, 9 years-old; bred by M. Chemellier, Anger, France; sire, "Pretty Boy;" dam, "Scozzone," by "Ionian."

*Stallions suitable for getting Hackneys.*

JAMES FIRTH CROWTHER, Knowl Grove, Mirfield, Yorkshire: FIRST PRIZE, 20*l.*, for "Charley Merrylegs," dark chestnut, 5 year-old; bred by Mr. James Collings, Aughton Grange, Wheldrake, Yorkshire; sire, "Royal Charley;" dam, "Polly," by "Young Phenomenon."

THE STAND STUD COMPANY, Whitefield, Manchester: SECOND PRIZE, 10*l.*, for "Star of the East," chestnut, 6 years-old; bred by Mr. Cook, Thixendale, Yorkshire; sire, "Charley Merrylegs;" dam by "North Star."

HENRY ROUNDELL, Black Horse Hotel, Otley, Yorkshire: THIRD PRIZE, 5*l.*, for "Sir George Wombwell," brown, 6 years-old; bred by Mr. Joshua Yeadon, Fewston, Otley; sire, "Sir George;" dam by "Matchless Merrylegs" or "Grey Atlas."

T. K. BICKELL, St. John's, Lamerton, Tavistock, Devonshire: the *Reserve Number* to "Star of the West," chestnut, 6 years-old; bred by Mr. W. Medland, Gatherly, Lifton, Devonshire; sire, "Paul Clifford;" dam, "Gatherly," by "Jack in the Green."

*Pony Stallions, above 13 hands 2 inches and not exceeding 14 hands 2 inches.*

CHRISTOPHER W. WILSON, High Park, Kendal, Westmoreland: FIRST PRIZE, 20*l.*, for "Sir George," brown, 11 years-old; bred by Mr. W. Walker, Shadwell, Yorkshire; sire, "Sportsman:" SECOND PRIZE, 10*l.*, for "Lord Derby," brown, 4 years-old; bred by Mr. James Coker, Houghton-in-the-Dale, Walsingham, Norfolk; sire, "Perfection;" dam by Mr. Tycer's "Prickwillow:" and THIRD PRIZE, 5*l.*, for "Sir Douglas," brown, 3 years-old; bred by Mr. Ewan Christian, Milntown, Ramsay, Isle of Man; sire, "Sir George."

JOHN WILLIAMS, Llansannor Court, Cowbridge, Glamorganshire: the *Reserve Number* to "Young Comet," bay, 2 years-old; bred by himself; sire, "Cardigan Comet;" dam, "Butterfly," by "Ancient Briton."

*Pony Stallions not exceeding 13 hands 2 inches.*

CHRISTOPHER W. WILSON, High Park, Kendal, Westmoreland: FIRST PRIZE, 15*l.*, for "George 2nd," bay, 4 years-old; bred by himself; sire, "Sir, George;" dam, "Lady Mary:" SECOND PRIZE, 10*l.*, for "Sir Dudley," black, 3 years-old; bred by Mr. T. Westwood, Crown Hotel, Grange,

Lancashire; sire, "Sir George;" and THIRD PRIZE, 5*l.*, for "Sir Garnet Wolseley," brown, 1 year-old; bred by Mr. Henry Hunt, Preston, Lancashire; sire, "Sir George;" dam by "Kettledrum."

LLEWELLYN JONES, Penygarn, Pentyrch, Cardiff, Glamorganshire: the *Reserve Number* to "Young Trotting Lion," mottled dun, 6 years-old; bred by Mr. C. Francis, Cefn-elos-y-Bedd, Crumlin, Monmouth; sire, "Old Trotting Lion;" dam, "Daisy," by "Merrylegs."

*Agricultural Mares, in Foal, or with Foal at foot.*

LAWRENCE DREW, Merryton, Hamilton, Lanarkshire, N.B.: FIRST PRIZE, 30*l.*, for "Countess," brown, 5 years-old, in foal to "Prince of Wales;" bred by Mr. Hawksworth, near Derby; sire, "Lofty."

THE EARL OF ELLESMERE, Worsley Hall, Manchester: SECOND PRIZE, 15*l.*, for "Dainty," bay, 10 years-old, in foal to "Samson;" bred by Mr. W. Beart, Chatteris, Cambridgeshire; sire, "Fison's England's Glory;" dam by "Seward's Major."

WILLIAM WYNN, Ryon Hill Farm, Stratford-on-Avon, Warwickshire: THIRD PRIZE, 5*l.*, for "Queen of Trumps," dapple grey, 6 years-old (foal by "Nonpareil"); bred by Mr. Owen Gibbs, formerly of Mickleton, Broadway, Gloucestershire; sire, "A 1;" dam, "Beauty."

JAMES HIBBARD, Jun., Stanton St. Quentin, Chippenham, Wilts: the *Reserve Number* to "Diamond," chestnut, 7 years-old (foal by "The Quail"); bred by Mr. James Hibbard, Stanton Manor; sire, "The King of the Valleys."

*Clydesdale Mares in Foal, or with Foal at foot.*

ROBERT LODER, Whittlebury, Towcester, Northamptonshire: FIRST PRIZE, 20*l.*, for "Jean," brown, 11 years-old, in foal to "Scotland Yet;" bred by Mr. Maxwell Clark, Culmain, Dalbeattie, Kirkcudbright; sire, "Loch Fergus Champion;" dam, "Nancy," by "London Tom."

CHRISTOPHER W. WILSON, High Park, Kendal, Westmoreland: SECOND PRIZE, 10*l.*, for "Mrs. Muir," bay, 12 years-old, in foal to "Black Prince;" bred by Mr. Muir, Loch Fergus, Kirkcudbright; sire, "Champion."

ROBERT LODER, Whittlebury, Towcester: THIRD PRIZE, 5*l.*, for "Dandy," bay, 5 years-old, in foal to "Scotland Yet;" bred by Mr. Gibson, Glenstocking, Dalbeattie, Kirkcudbright; sire, "Prince;" dam, "Bell" by "Clyde;" and the *Reserve Number* to "Jess," brown, 7 years-old (foal by "Luck's All"); bred by Mr. William Gray, Muncraig, Borgue, Kirkcudbright; sire, "Merry Tom;" dam, "Jess," by "Victor."

*Suffolk Mares in Foal, or with Foal at foot.*

THE DUKE OF HAMILTON AND BRANDON, Easton Park, Wickham Market, Suffolk: FIRST PRIZE, 20*l.*, for "Belle of the Ball," chestnut, 4 years-old, in foal to "Statesman;" bred by Mr. C. Frost, Wherstead, Suffolk; sire, a son of "May Duke;" dam by "Hero."

HORACE WOLTON, Newbourn Hall, Woodbridge, Suffolk: SECOND PRIZE, 10*l.*, for "Duchess of Newbourn," bright chestnut, 11 years-old (foal by "Champion"); bred by the late Mr. S. Wolton, Newbourn Hall; sire, "Warrior;" dam, "Victoria," by "Barthropp's Hero."

WILLIAM BYFORD, The Court, Glemsford, Suffolk: the *Reserve Number* to



"Doughty," chestnut, 6 years-old, in foal to "Reliance;" bred by himself; sire, "Volunteer;" dam, "Violet," by Mr. Woodgate's "Boxer."

*Mares in Foal, or with Foal at foot, suitable for breeding Hunters.*

GEORGE LEIGHTON, Osgodby, Scarborough, Yorkshire: FIRST PRIZE, 25*l.*, for "Snowflake," bay, aged (foal by "The Mallard"); bred by Mr. Marris, Lincolnshire; sire, "Magnum;" dam by "Professor Buck."

GEORGE FREDERICK STATTER, Park House, Whitefield, Manchester: SECOND PRIZE, 15*l.*, for "Lady Lyne," brown, 19 years-old (foal by "Laughing-stock"); bred by the late Sir George Cholmley, Boynton, Bridlington, Yorkshire; sire, "Codrington;" dam, "Tipsy," by "Yaxley."

LIEUTENANT-COLONEL J. S. BALLARD, the Verlands, Cowbridge, Glamorganshire: THIRD PRIZE, 5*l.*, for "Hoyden," bay, 14 years-old, in foal to "Master Fenton;" bred by Mr. George Coleman, Landaff Mills, Cardiff; sire, "Clumsy;" dam, "Maid of the Mill," by "Mountaineer."

THE DUKE OF HAMILTON AND BRANDON, Easton Park, Wickham Market, Suffolk: the *Reserve Number* to "Flirt," chestnut, 12 years-old, in foal to "Barbillon;" bred by the late Sir George Cholmley, Boynton; sire, "Angelus;" dam, "Miss Taylor," by "King Caradoc."

*Mares in Foal, or with Foal at foot, suitable for breeding Hackneys.*

THE DUKE OF HAMILTON AND BRANDON, Easton Lodge, Wickham Market, Suffolk: FIRST PRIZE, 20*l.*, for "Spotted Mare," roan (foal by "Falerio"), age and breeder unknown.

TIMOTHY DAVID, St. Athan, Cowbridge, Glamorganshire: SECOND PRIZE, 10*l.*, for "Lady Mayoress," dark bay, 8 years-old (foal by "Weatherstar"); bred by Mr. Thomas Anthony, Mudliseomb, Kidwelly, Carmarthenshire; sire, "Cardigan Comet;" dam, "Fanny," by "Sportsman."

JAMES HOWARD, Clapham Park, Bedford: THIRD PRIZE, 5*l.*, for "Countess," dark brown, 4 years-old (foal by "Norfolk Hero"); bred by himself; sire, "Restitution;" dam, "Duchess."

JOHN HUTSON, East Brent, Highbridge, Somersetshire; the *Reserve Number* to "Alice," brown, 11 years-old (foal by "Flyer"); breeder unknown.

*Pony Mares in Foal, or with Foal at foot, above 13 hands 2 inches, and not exceeding 14 hands 2 inches.*

WILLIAM TYLER, 28, Frederiek Street, Birmingham: FIRST PRIZE, 15*l.*, for "Surprise," grey, aged (foal by "Jolly Friar"); bred by Mr. H. Ward, Castle Bromwich, Birmingham; sire, "Alvediston;" dam, "Duplicity," by the "Flying Dutchman."

THE DUKE OF HAMILTON AND BRANDON, Easton Park, Wickham Market, Suffolk: SECOND PRIZE, 10*l.*, for "Sewell," bay (foal by "Priekwillow"), age and breeder unknown.

JOHN HUTSON, East Brent, Highbridge, Somersetshire: the *Reserve Number* to "Judy," bay, about 12 years-old (foal by "The Flyer"); bred by himself; sire, "Railway."

*Pony Mares in Foal, or with Foal at foot, not exceeding 13 hands 2 inches.*

CHRISTOPHER W. WILSON, of High Park, Kendal, Westmoreland: FIRST PRIZE, 15*l.*, for "Lady Polo," bay, 6 years-old (foal by "Sir George"),



breeder unknown; and SECOND PRIZE, 10*l.*, for "The Pet," chestnut, 9 years-old (foal by "Sir George"); bred by Mr. D. Miller, Chawn Hill Farm, Stourbridge.

CHARLES EDWARDS, The Grove, Wrington, Somerset: THIRD PRIZE, 5*l.*, for "Black Down," chestnut, 4 years-old (foal at foot); bred by himself; sire, "Rowberrow."

ROBERT PORCH, Jun., Hart's Farm, Bedminster, Somerset: the *Reserve Number* to "Polly," bay, 9 years-old, in foal to "Young Active;" breeder unknown.

*Agricultural Fillies (including Clydesdales and Suffolks)—Two Years old.*

LAWRENCE DREW, Merryton, Hamilton, N.B.: FIRST PRIZE, 20*l.*, for his brown: sire, "Topsman;" breeder unknown.

THOMAS HORROCKS MILLER, Singleton Park, Poulton-le-Fylde, Lancashire: SECOND PRIZE, 10*l.*, for "Princess Dagmar," bay; bred by himself; sire, "Honest Tom;" dam, "Princess of Wales," by "King Alfred."

THE EARL OF ELLESMERE, Worsley Hall, Manchester: THIRD PRIZE, 5*l.*, for "Empress," chestnut; bred by Mr. Warth, Chatteris, Cambs; sire, "Samson;" dam by "Volunteer."

WILLIAM BYFORD, The Court, Glemsford, Suffolk: the *Reserve Number* to his chestnut; bred by himself; sire, "Hereules."

*Agricultural Fillies (including Clydesdales and Suffolks)—Three Years old.*

THE EARL OF ELLESMERE, Worsley Hall, Manchester: FIRST PRIZE, 20*l.*, for "Miss Linton," bay; bred by Mr. John Linton, Westwick Hall, Cambridge; sire, "Honest John."

JOSEPH HENNESSY, 35, Richmond Terrace, Clifton, Bristol: SECOND PRIZE, 10*l.*, for "Countess;" brown bay; bred by himself.

LAWRENCE DREW, Merryton, Hamilton, N.B.: THIRD PRIZE, 5*l.*, for his brown; breeder unknown.

MRS. MARY PEARCE, Dyer's Farm, New Passage, Bristol: the *Reserve Number* to her "Diamond," chestnut; bred by herself; sire, "Sampson;" dam, "Darling."

*Hunter Fillies or Geldings—Two Years old.*

ROBERT EXLEY, the Grange, Horseforth, Leeds: FIRST PRIZE, 20*l.*, for "Colonel," bay gelding; bred by the late Mr. J. Blackett, Beverley, Yorkshire; sire, "Lord Derby;" dam, by "Theobald."

RUSSELL SWANWICK, Royal Agricultural College Farm, Cirencester, Gloucestershire: SECOND PRIZE, 10*l.*, for his bay gelding; bred by himself; sire, "Umpire;" dam, "Electra," by "Redbourne."

THOMAS TRINDER, Chadley, Great Malvern: THIRD PRIZE, 5*l.*, for "Idler," bay gelding, bred by himself; sire, "Truant;" dam, "Polly Perfect," by "Defiance."

THOMAS MORTIMER, Brown's Farm, Kenn, Devon: the *Reserve Number* to "Matchless," roan gelding; bred by himself; sire, "Rapid Rhone;" dam, "Polly," by "Gemma de Verge."

*Hunter Mares or Geldings—Three Years old.*

- GEORGE BLAND BATTAMS, Kilworthy, Tavistock, Devon: FIRST PRIZE, 20*l.*, for "Lady Jane," bay filly; bred by Mr. Hermon Taylor, Standcombe, Totness, Devon; sire, "Make Haste."
- THE DUKE OF HAMILTON AND BRANDON, Easton Park, Wickham Market, Suffolk: SECOND PRIZE, 10*l.*, for "Bird's Eye," brown gelding; bred by Mr. G. Lancaster, Morton Grange, Northallerton, Yorkshire; sire, "Baron Cavendish;" dam by "Tottenham."
- CHARLES ALBERT TANNER, Yatesbury, Calne, Wiltshire: THIRD PRIZE, 5*l.*, for "Andover," bay gelding; breeder unknown; sire, "Daybreak."
- THE DUKE OF BEAUFORT, K.G., Badminton, Chippenham: the *Reserve Number* to his chestnut gelding; bred by himself: sire, "Birdhill;" dam, "Miss Spencer," by "Vengeance."

*Hunter Mares or Geldings—Four Years old.*

- JOHN GOODWIN, Priory Court, Cheltenham, Gloucestershire: FIRST PRIZE, 25*l.*, for "Gentleman," dark bay gelding; bred by Mr. Kerr, Eastnor Castle Farm, Ledbury, Herefordshire; sire, "The Mallard;" dam, "Duchess," by "Viovode."
- G. B. BANTAMS, Kilworthy, Tavistock, Devon: SECOND PRIZE, 15*l.* for "Look Sharp," gelding; bred by Mr. Symons, near Newton Abbott, Devon; sire, "Make Haste."
- THE DUKE OF HAMILTON AND BRANDON, Easton Park, Wickham Market, Suffolk: THIRD PRIZE, 10*l.*, for "Boynton," bay gelding; bred by the late Sir George Cholmley, Bart, Boynton, Bridlington, Yorkshire; sire, "The Baron;" dam, "Pully Haully," by "King Caradoc."
- COLONEL FREDERICK BARLOW, Hasketon, Woodbridge, Suffolk: the *Reserve Number* to "Lambkin," chestnut gelding; bred by Mrs. Clement Hill, Wrenbury, Salop; sire, "Lambkith;" dam, "Desdemona," by "The Moor."

*Hunter Mares or Geldings, Five Years old and upwards, up to not less than 12 stone.*

- THE STAND STUD COMPANY, Whitefield, Manchester: FIRST PRIZE, 30*l.*, for "Rosalind," brown mare, 5 years-old; bred by Mr. James Moffat, Crosby-on-Eden, Carlisle, Cumberland; sire, "Laughing-stock;" dam, "Lady Lyne," by "Codrington."
- JOHN GOODWIN, Priory Court, Cheltenham, Gloucestershire: SECOND PRIZE, 20*l.*, for "Goldsmith," dark brown gelding, 7 years-old; breeder unknown.
- CAPTAIN WILLIAM HAMMOND BETTS, Frenze Hall, Diss, Norfolk: THIRD PRIZE, 10*l.*, for "Primrose," dark chestnut mare, 7 years-old; breeder unknown.
- JAMES KEEVIL, Shaw Farm, Melksham, Wiltshire: the *Reserve Number* to "Councillor," chestnut gelding; 5 years-old; bred by Mr. Taff, Roscommon, Ireland; sire, "The Lawyer," dam by "Chit Chat."

*Hunter Mares or Geldings, Five Years old and upwards, up to not less than 15 stone.*

- THE DUKE OF HAMILTON AND BRANDON, Easton Park, Wickham Market, Suffolk: FIRST PRIZE, 30*l.*, for "Winder," black gelding, 10 years-old; breeder unknown.

GEORGE BLAND BATTAMS, Kilworthy, Tavistock, Devon : SECOND PRIZE, 20*l.*, for "Brown Stout," dark brown gelding, 8 years-old; bred by Mr. Edwards, Totnes, Devon; sire, "Loyola."

COLONEL FREDERICK BARLOW, Hasketon, Woodbridge, Suffolk : THIRD PRIZE, 10*l.*, for "Doneraile," brown gelding, 5 years-old; bred by Mr. Murphy, near Cork, Ireland; sire, "St. Leger," dam by "Lottery."

MISS CAROLINE C. IRELAND, 2, Sandford Place, Cheltenham, Gloucestershire : the *Reserve Number* to "Cash-box," brown gelding, 8 years-old; sire, "Birdhill."

*Hackney Mares or Geldings, up to not less than 12 stone.*

HARRY VILLAR, Charlton Kings, Cheltenham, Gloucestershire : FIRST PRIZE, 20*l.*, for "Yorkshire Lass," brown mare, 4 years-old; bred by Mr. Henry Clay, Northallerton, Yorkshire; sire, "Van Galen;" dam by "Augur."

THOMAS ETTWELL SIMPKINS, Ablington House, Amesbury, Wiltshire : SECOND PRIZE, 10*l.*, for "Comet," iron-grey mare, 4 years-old; bred by himself; sire, "Tympanum;" dam, "Kitty Tyrell."

JOHN and THOMAS IRISH, Poulston and Dorsley, Harbertonford, Totnes, Devon : THIRD PRIZE, 5*l.*, for "Actress," roan filly, 4 years-old; bred by themselves; sire, "Preceptor;" dam, "Charlotte," by "Harkaway."

ALBERT EDWARD GOULD, Bampfylde Lodge, Poltimore, Exeter : the *Reserve Number* to "Little Lady," chestnut filly, 5 years-old; bred by Mr. John Joyce, Washford, Taunton, Somerset; sire, "Young Varmint;" dam, "Foxy."

*Hackney Mares or Geldings, up to not less than 15 stone.*

SIR PRYSE PRYSE, Bart., Gogerddan, Bowstreet, Shrewsbury, R. S. O. : FIRST PRIZE, 20*l.*, for "The Dean," bay gelding, 6 years-old; bred by Mr. John Rees, Cilgell Carrol, Lampeter; sire, "Sailor Bach."

THE STAND STUD COMPANY, Whitefield, Manchester : SECOND PRIZE, 10*l.*, for "Expectation," brown mare, 6 years-old; bred by Mr. William Can, Wymondham, Norfolk; sire, "Confidence."

JAMES DAVIS, Manor House, Clapton, Bristol : the *Reserve Number* to "Tommy Dodd," brown gelding, 5 years-old; bred by himself; sire, "Perfection;" dam, "Jennie," by Read's "Jack."

*Pony Mares or Geldings, above 13 hands 2 inches and not exceeding 14 hands 2 inches.*

THE DUKE OF HAMILTON AND BRANDON, Easton Park, Wickham Market, Suffolk : FIRST PRIZE, 15*l.*, for "Bosco," black gelding, 8 years-old; breeder unknown.

JAMES FIRTH CROWTHER, Knowl Grove, Mirfield, Yorkshire : SECOND PRIZE, 10*l.*, for "Lady Clarissa," brown mare, 4 years-old; bred by Mr. John Wreghitt, Londesborough, Market Weighton, Yorkshire; sire, "King Charley;" dam, "Polly Horsley," by Triffett's "Fireaway."

MISS MABEL THOMAS, Drayton Lodge, Redland, Bristol : THIRD PRIZE, 5*l.*, for "Ruby," brown mare, 6 years-old; bred by Mr. William Northey, Tavistock, Devon; sire, "Perfection."

GEORGE DAVEY, Jun., Lion House, Barnstaple, Devon : the *Reserve Number* to "North Devon," brown gelding, 4 years-old; bred by Mr. Stephens, Ashmansworthy Farm, Woolfardisworthy, Devon; sire, "Vengeance;" dam, "Devoniensis."

*Pony Mares or Geldings, not exceeding 13 hands 2 inches.*

- THOMAS YELVERTON, Venn Ottery, Ottery St. Mary, Devon: FIRST PRIZE, 15*l.*, for "Aaron," brown gelding, 5 years-old; bred by Mr. Knight, Simonsbath, Somerset.
- FRANCIS FINCH BLADON, Polsloe Road, Exeter: SECOND PRIZE, 10*l.*, for "Taffy," grey gelding, 9 years-old; breeder unknown.
- WILLIAM ALEXANDER PILLERS, Horsington Farm, Wincanton, Somerset: THIRD PRIZE, 5*l.*, for "General Joe," dark brown gelding, 6 years-old; bred by Tredegar Iron and Coal Company, Tredegar, Monmouthshire.
- NATHANIEL LEIGH, Cheriton House, Westbury-on-Trym, Gloucestershire: the *Reserve Number* to "Dartmoor," brown gelding, 5 years-old; breeder unknown.

## CATTLE.

*Shorthorn Bulls above Three Years old.*

- THE EARL OF ELLESMERE, Worsley Hill, Manchester: FIRST PRIZE, 30*l.*, for "Attractive Lord," red and white, 4 years, 1 month, 1 day-old; bred by Mr. T. Pears, Hackthorne, Lincoln; sire, "Knight of Killerby" (28,999); dam, "Attraction," by "Robin" (24,968); g. d., "Alice Buckingham," by "Royal Buckingham" (20,718); gr. g. d., "Anna Maria," by "Sir Roger" (16,991); gr. g. d., "Adelaide," by "The Squire" (12,217).
- WILLIAM LINTON, Sheriff Hutton, York: SECOND PRIZE, 20*l.*, for "Sir Arthur Ingram" (32,490), roan, 6 years, 5 months, 6 days-old; bred by himself; sire, "Sergeant-Major" (29,957); dam, "Fragrance," by "Mountain Chief" (20,383); g. d., "Miss Topsy," by "Blood Royal" (17,423); gr. g. d., "Yorkshire Lass," by "Magnus Troil" (14,880); gr. g. g. d., "Beauty," by "Bates" (12,450).
- THOMAS HARDWICK BLAND, Dingley Grange, Market Harborough: THIRD PRIZE, 15*l.*, for "General Fusee" (36,681), roan, 3 years, 11 months, 5 days-old, bred by himself; sire, "Earl of Waterloo 2nd" (33,819); dam, "Fairy," by "African" (36,104); g. d. "Beauty," by "Harry" (36,743); gr. g. d., "Miss Pittam 2nd," by "Castle Ashby" (36,327); gr. g. g. d., "Miss Pittam 1st," by "Carminta" (7877).
- JABEZ CRUSE, Cleave farm, *via* Bulkworthy, Brandiscorner, North Devon: FOURTH PRIZE, 10*l.*, for "Oxford Duke 10th," red and white, 3 years, 7 months, 3 weeks, 2 days-old; bred by Mr. W. Horswell, Weck Barton, Milton Abbott, Tavistock, Devon; sire, "Baron Oxford 2nd" (23,376); dam, "Cometilla 2nd," by "Duke of Bedford" (21,566); g. d., "Ceres 3rd," by "Duke" (15,908); gr. g. d., "Ceres," by "Mistor" (13,343); gr. g. g. d., "Cometilla 6th," by "Duke of Devonshire."
- WILLIAM HANDLEY, Green Head, Milnthorpe, Westmoreland: the *Reserve Number* to "Royal Irwin" (35,383), white, 4 years, 7 months, 1 week-old; bred by Mr. W. Linton, Sheriff Hutton, York; sire, "Lord Irwin" (29,122); dam, "Gratitude," by "Mountain Chief" (20,383); g. d., "Carnation," by "Earl of Windsor" (17,788); gr. g. d., "Yorkshire Lass," by "Magnus Troil" (14,880); gr. g. g. d., "Beauty," by "Bates" (12,451).

*Shorthorn Bulls above Two and not exceeding Three Years old.*

WILLIAM TENNANT, White House, Barlow, Selby, Yorkshire: FIRST PRIZE, 25*l.*, for "Kalamazoo," red and white, 2 years, 6 months, 4 weeks-old; bred by himself; sire, "Sir Arthur Ingram" (32,490); dam, "Parting Rose," by "Cambridge Duke 4th" (25,706); g. d., "Prima Donna," by "Waverley 4th" (21,084); gr. g. d., "Pomp," by "Sir John" (12,084); gr. g. g. d., "Priscilla," by "The Bonus" (10,922).

RICHARD STRATTON, The Duffryn, Newport, Monmouthshire: SECOND PRIZE, 15*l.* for "Pearl Diver" (37,182); red, 2 years, 6 months, 2 weeks, 4 days-old; bred by himself; sire, "Rob Roy," (29,806); dam, "Ruby," by "James 1st" (24,202); g. d. "Refulgence," by "Lamp of Lothian" (16,356); gr. g. d., "Maid of Honour," by "Young Windsor" (17,241); gr. g. g. d., "Sixth Duchess of Glo'ster," by "King John" (14,763).

JOHN ELWELL, Timberley, Castle Bromwich, Warwickshire: THIRD PRIZE, 10*l.*, for "Baines Windsor" (36,150); red and little white, 2 years, 9 months, 2 weeks, 2 days-old; bred by himself; sire, "Royal Windsor," (29,890); dam, "Clara Bell," by "Chilton" (25,774); g. d. "Certainty," by "Prince Ambo" (24,786); gr. g. d., "Chance," by "Prince George of Waterloo" (18,607); gr. g. g. d., "Cygnet," by "Captain" (14,229).

THE STAND STUD COMPANY, Whitefield, Manchester: FOURTH PRIZE, 5*l.*, for "Favourite," red, 2 years, 2 months, 1 week, 4 days-old; bred by Mr. W. Faulkner, Rothersthorpe, Northampton; sire, "Prince Rufus" (35,177); dame, "Fragrance," by "Athelstane" (23,331); g. d., "Faucy" by "Knight of Branches" (20,076); gr. g. d., "Fame," by "Rufus" (15,216); gr. g. g. d., "Wild Bine," by "Admiral" (9861).

GEORGE GIBBONS, Tunley Farm, Bath: the *Reserve Number* to "Huntley," roan, 2 years, 5 months, 3 weeks, 6 days-old; bred by Mr. Hugh Aylmer, West Dereham Abbey, Stoke Ferry, Norfolk; sire, "High Sheriff" (26,392); dam, "Phillis 11th," by "Royal Broughton" (27,352); g. d., "Phillis 7th," by "Norfolk Thorndale Duke" (24,666); gr. g. d., "Phillis 2nd," by "Red Knight" (16,809); gr. g. g. d., "Phillis," by "Homer" (14,714).

*Shorthorn Yearling Bulls above One and not exceeding Two Years old.*

THOMAS WILLIS, Jun., Manor House, Carperby, Bedale, Yorkshire: FIRST PRIZE, 25*l.*, for "Vice-Admiral" (39,257); roan, 1 year, 10 months, 1 week, 5 days-old; bred by himself; sire, "Admiral Windsor" (32,912); dam, "Windsor's Hyacinth," by "Windsor's Prince" (32,164); g. d., "Camelia Windsor," by "Windsor Fitz-Windsor" (25,458); gr. g. d., "Camelia," by "Royal Alfred" (18,748); gr. g. g. d., "Mayflower," by "Knight of the Garter" (13,124).

COLONEL R. LOYD LINDSAY, V.C., M.P., Lockinge Park, Wantage, Berks: SECOND PRIZE, 15*l.*, for "Churchill," roan, 1 year, 7 months, 2 weeks, 1 day-old; bred by himself; sire, "Lord Rockville" (34,658); dam, "Princess Rose," by "Duke of Jamaica" (23,758); g. d., "Roan Duchess," by "Gloster's Grand Duke" (12,949); gr. g. d., "Charmer," by "Fourth Duke of York" (10,167); gr. g. g. d., "Chaplet," by "Usurer" (9763).

COLONEL R. NIGEL F. KINGSCOTE, C.B., M.P., Kingscote, Wotton-under-Edge, Gloucestershire: THIRD PRIZE, 10*l.*, for "Cowslip Boy," roan, 1 year, 7 months, 1 week, 4 days-old; bred by himself; sire, "Duke



of Hillhurst" (28,401); dam, "Cowslip 5th," by "Oxford Beau" (29,485); g. d., "Cowslip 3rd," by "Grand Duke 11th" (21,849); gr. g. d., "Cherry Cheeks," by "Mac Turk" (14,872); gr. g. d., "Cherry Lips," by "Cherry Duke 2nd" (14,265).

THE DUKE OF NORTHUMBERLAND, Alnwick Castle, Northumberland: **FOURTH PRIZE, 5*l.***, for "Lord Mayor," roan, 1 year, 9 months, 2 weeks, 1 day-old; bred by himself; sire, "Fitz-Roland" (33,936); dam, "Lucretia 3rd," by "Mayor of Windsor" (31,897); g. d., "Lucretia 2nd," by "Royal Butterfly 23rd" (27,355); gr. g. d., "Lucretia," by "Knight of the Grand Cross 2nd" (26551), gr. g. d., "Bianca," by "Majestic" (16,492).

WILLIAM HANDLEY, Green Head, Milnthorpe, Westmoreland: the *Reserve Number* to "Lord St. Vincent," white, 1 year, 3 months, 3 days-old; bred by himself; sire, "Sir Arthur Windsor" (35,541); dam, "Louisa," by "Sir Walter Trevelyan" (25,179); g. d., "Old Lavender," by "General Garibaldi" (21,813); gr. g. d., "Lady," by "Tenant Farmer" (13,828); gr. g. d., by "Young Meteor" (13,336).

*Shorthorn Bull Calves above Six and not exceeding Twelve Months old.*

SAMUEL THOMAS TREGASKIS, Blabell, St. Issey, Cornwall: **FIRST PRIZE, 20*l.***, for "Masterman," red and white, 9 months, 3 weeks, 5 days-old; bred by himself; sire, "Model" (34,861); dam, "Prairie Bird 5th," by "Cherry of Sarsden" (21,408); g. d., "Prairie Bird," by "War Eagle" (15,483); gr. g. d., "Bonny Lass," by "George" (12,938); gr. g. d., "Dido," by "General Gilbert" (12,932).

THE REV. ROBERT BRUCE KENNARD, Marnhull, Blandford, Dorset: **SECOND PRIZE, 15*l.***, for "Prince Victor," white, 8 months, 3 days-old; bred by himself; sire, "Marquis of Blandford 4th" (38,712); dam, "Queen Mary," by "Grand Duke of Oxford" (28,763); g. d., "Queen Anne," by "Lord Stanley 2nd" (26,745); gr. g. d., "Queen Bertha," by "Macaroni" (24,498); gr. g. d., "Mildred," by "Duke of Norfolk" (17,735).

ARTHUR GARFIT, Scothern, Lincoln: **THIRD PRIZE, 10*l.***, for "Scothern Butterfly 2nd," red, 10 months, 2 weeks-old; bred by himself; sire, "Lord of Scothern" (34,626); dam, "Scothern Duchess," by "Second Wharfedale Oxford" (30,298); g. d., "Red and White Duchess," by "Prince Imperial" (27,150); gr. g. d., "Red Roan Duchess," by "Duke of Wharfedale" (19,648); gr. g. d., "Another Roan Duchess," by "Master Frederick" (11,489).

THOMAS WILSON, Shotley Hall, Northumberland: **FOURTH PRIZE, 5*l.***, for "Wild Oxonian," roan, 11 months, 3 weeks, 3 days-old; bred by himself; sire, "Duke of Oxford 31st" (33,713); dam, "Wild Eye-bright," by "Sixth Duke of Geneva" (30,959); g. d., "Wild Eyes Duchess," by "Grand Duke 9th" (19,879); gr. g. d., "Wild Eyes 19th," by "Lablache" (16,353); gr. g. d., "Wild Eyes 18th," by "Solon" (13,766).

RICHARD STRATTON, The Duffryn, Newport, Monmouthshire: the *Reserve Number* to "Autumnus," red and white, 8 months, 5 days-old; bred by himself; sire, "Lowlander" (37,022); dam, "November Rose," by "James 1st" (24,202); g. d., "April Rose," by "Warwick" (19,120); gr. g. d., "March Rose," by "Young Windsor" (17,241); gr. g. d., "Christmas Rose," by "His Highness" (14,708).



*Shorthorn Cows above Three Years old.*

**LORD FITZHARDINGE**, Berkeley Castle, Gloucestershire: **FIRST PRIZE**, 20*l.*, for "Rugia Niblett," red, 5 years, 8 months, 1 week, 1 day-old; in-calf; bred by Mr. George Garne, Churchill Heath, Chipping Norton, Oxon; sire, "Royal Butterfly 20th" (25,007); dam, "Ruth Niblett," by "Second Duke of Jamaica" (25,977); g. d., "Rebecca Niblett," by "Cynric" (19,542); gr. g. d., "Rachel Niblett," by "Nauplius" (16,607); gr. g. d., "Rugia," by "British Boy" (11,206).

**THOMAS ATKINSON**, Higher House, Unsworth, Manchester: **SECOND PRIZE**, 15*l.*, for "Moonshine," roan, 5 years, 2 months, 1 week, 6 days-old, in-milk, calved December 23, 1877; bred by Mr. J. T. Robinson, Leckby Palace, Assenby, Thirsk; sire, "Star of Brightness" (32,604); dam, "Sunshine," by "Lord Wetherby" (24,477); g. d., "Dairymaid," by "Lord Abbot" (20,140); gr. g. d., "Milkmaid," by "Marc Antony" (14,895); gr. g. d., "Prolific," by "Duke of Richmond" (7996).

**WILLIAM HOSKEN AND SON**, Loggan's Mill, Hayle, Cornwall: **THIRD PRIZE**, 10*l.*, for "Carnation 4th," roan, 3 years, 3 months, 2 days-old, in-milk and in-calf, calved November 3, 1877; bred by themselves; sire, "Second Baron Wild Eyes" (30,497); dam, "Carnation," by "Prince Frederick" (16,734); g. d. "Miss Fisher," by "Lord of the South" (13,216); gr. g. d. "Miss Lucy," by "Red Roan Kirtling" (10,691); gr. g. d., "Lady Godolphin," by "Paris" (7314).

**TEASDALE HILTON HUTCHINSON**, Manor House, Catterick, Yorkshire: **FOURTH PRIZE**, 5*l.*, for "Grateful," roan, 3 years, 6 months, 5 days-old, in-milk and in-calf, calved October 22nd, 1877; bred by himself; sire, "M. C." (31,898); dam, "Gerty 3rd," by "Knight of the Shire" (26,552); g. d., "Gerty," by "Vain Hope" (23,102); gr. g. d., "Garland," by "Grand Master," (24,078); gr. g. d., "Bridget," by "Highborn" (13,028).

**BENJAMIN ST. JOHN ACKERS**, Prinknash Park, Painswick, Gloucestershire: the *Reserve Number* to "Princess Georgie," rich roan, 3 years, 11 months-old, in milk, calved May 3, 1878; bred by himself; sire, "County Member" (28,268); dam, "Georgie's Queen," by "Brigade Major" (21,312); g. d., "Georgie," by "Prince George" (13,510); gr. g. d., "Hopeful," by "Hopewell" (10,332); gr. g. d., by "Warrior" (12,287).

*Shorthorn Heifers in-milk or in-calf, not exceeding Three Years old.*

**RICHARD MARSH**, Little Offley, Hitchin, Hertfordshire: **FIRST PRIZE**, 20*l.*, for "Diana," roan, 2 years, 10 months-old, in-calf; bred by himself; sire, "Mantalini Prince" (29,273); dam, "Dahlia," by "Pan" (18,516); g. d., "Daisy," by "Noble" (14,997); gr. g. d., "Daisy," by "Earl of Chester" (9057); gr. g. d., "Daisy," by "Earl of Chester" (9057).

**THE EARL OF ELLESMERE**, Worsley Hall, Manchester: **SECOND PRIZE**, 15*l.*, for "The Lady," roan, 2 years, 9 months, 4 weeks-old, in-calf; bred by Colonel Towneley, Towneley Park, Barnley; sire, "Second Hubback" (28,880); dam, "Lunette," by "Royal Scotforth" (25,042); g. d., "Moonbeam," by "Prince James" (20,555); gr. g. d., "Sunshine," by "Duke of Buckingham" (14,428); gr. g. d., "Sunbeam," by "Dandy Dinmont" (11,329).

**JAMES SLEE BULT**, Dodhill House, Kingston, Taunton: **THIRD PRIZE**, 10*l.*, for "Bertha 3rd," red roan, 2 years, 7 months, 1 week, 6 days-old,

in-calf; bred by himself; sire, "Cardinal" (28,144); dam, "Bertha," by "Conqueror" (21,466); g. d., "Anemone 2nd," by "Duke of Cambridge" (12,742); gr. g. d., "Anemone," by "Allan-a-Dale" (7778); gr. g. g. d., "Ultima," by "Little John" (4232).

THE STAND STUD COMPANY, Whitefield, Manchester: **FOURTH PRIZE, 5*l.***, for "Blooming Bridesmaid," roan, 2 years, 5 months, 2 weeks, 2 days-old, in-calf; bred by Mr. W. H. Dudding, Panton House, Wragby, Lincolnshire; sire, "Sir Robert Stephenson" (32,313); dam, "Blooming Bride," by Robin (24,968); g. d., "Bloomer," by "Lord Panton" (22,204); gr. g. d., "Birthright," by "Royal Favourite" (15,200); gr. g. g. d., "Daisy," by "Sylvan" (10,907).

GEORGE ASHBY ASHBY, Naseby Woolleys, Rugby: the *Reserve Number* to "Innocence," roan, 2 years, 1 month, 2 weeks, 5 days-old, in-calf; bred by himself; sire, "Telemachus 3rd" (32,650); dam, "Inquiry," by "Third Duke of Geneva" (21,592); g. d., "Invoice," by "Pan" (18,516); gr. g. d., "Inquest," by "Field Marshal" (14,545); gr. g. g. d., "Sultana," by "Modbury Premium" (11,820).

*Shorthorn Yearling Heifers, above One and not exceeding Two Years old.*

ALBERT BRASSEY, Heythrop Park, Chipping Norton, Oxon: **FIRST PRIZE, 20*l.***, for "Jemima 4th," red and white, 1 year, 11 months, 4 weeks-old; bred by himself; sire, "Parallax," dam, "Jemima," by "Duke of Towneley" (21,615); g. d., "Jennet," by "Havelock" (14,676); gr. g. d., "Jenny Royal," by "Royal" (13,636); gr. g. g. d., "Jenny Lind," by "Fitzhardinge" (8073).

COLONEL R. NIGEL F. KINGSCOTE, C.B., M.P., Kingscote, Wootton-under-Edge, Gloucestershire: **SECOND PRIZE, 15*l.***, for "Honey 60th," red and little white, 1 year, 11 months, 1 week, 3 days-old; bred by himself; sire, "Duke of Rosedale 2nd" (33,722); dam, "Honey 43rd," by "Duke of Hillhurst" (28,401); g. d., "Honeyless," by "Caleb" (15,718); gr. g. d., "Helen," by "Oregon" (8371); gr. g. g. d., "Honeysuckle," by "Premier" (7344).

THE DUKE OF NORTHUMBERLAND, Alnwick Castle: **THIRD PRIZE, 10*l.***, for "Lady Jane," roan, 1 year, 9 months, 2 weeks-old; bred by himself; sire, "Fitz-Roland" (33,936); dam, "Janet," by "Mayor of Windsor" (31,897); g. d., "Young Dairymaid," by "Foxton" (23,979); gr. g. d., "Dairymaid," by "Melsonby" (18,380); gr. g. g. d., "Young Jessy," by "George 3rd" (16,147).

MRS. SARAH JANE PERY, Coolcronan House, Foxford, Co. Mayo: **FOURTH PRIZE, 5*l.***, for "Lady Violet," roan, 1 year, 6 months, 1 week, 5 days-old, bred by herself; sire, "Don Diego" (33,539); dam, "Lady Love," by "The Earl" (27,623); g. d., "Lady Sarah," by "Best Hope" (23,413); gr. g. d., "Marion," by "Duke of Leinster" (17,724); gr. g. g. d., "Violet," by "Baron Warlaby" (7813).

THE REV. ROBERT BRUCE KENNARD, Marnhull, Blandford, Dorset: the *Reserve Number* to "Lady Marnhull 4th," roan, 1 year, 11 months, 4 days-old; bred by himself; sire, "Marquis of Blandford 2nd" (34,779); dam, "Lady Marnhull," by "Grand Duke of Oxford" (28,763); g. d., "Ada," by "Duke of Montrose" 23,771; gr. g. d., "Juliet," by "Wonder" (21,126); gr. g. g. d., "Ethlinda," by "Marmaduke" (14,897).

*Shorthorn Heifer Calves, above Six and not exceeding Twelve Months old.*

LORD FITZHARDINGE, Berkeley Castle, Gloucestershire: **FIRST PRIZE, 20*l.***, for "Kirklevington Empress 3rd," roan, 10 months, 1 week, 6 days-old; bred

by himself; sire, "Duke of Connaught" (33,604); dam, Kirklevington Empress," by "Second Duke of Tregunter" (26,022); g. d., "Siddington 7th," by "Seventh Duke of York (17,754); gr. g. d., "Siddington 3rd," by "Seventh Duke of York" (17,754); gr. g. g. d., "Kirklevington 7th," by "Earl of Derby" (10,177).

**WILLIAM HOSKEN AND SON**, Loggan's Mill, Hayle, Cornwall : **SECOND PRIZE**, 15*l.*, for "Rose of Oxford 3rd," roan, 11 months, 3 weeks-old; bred by themselves; sire, "Second Baron Wild Eyes" (30,497); dam, "Rose of Oxford," by "Fifth Earl of Oxford" (28,515); g. d., "White Rose," by "Thorndale Mason" (23,067); gr. g. d., "Moss Rose," by "Prince Frederick" (16,734); gr. g. g. d., "Fancy 2nd," by "Sir John Barley-corn" (12,085).

**THE EARL OF ELLESMERE**, Worsley Hall, Manchester : **THIRD PRIZE**, 10*l.*, for "Melody," roan, 9 months, 1 day-old; bred by himself; sire, "Attractive Lord" (32,968); dam, "Harmony," by "Nicholas" (31,974); g. d., "Sympathy," by "Photograph" (20,492); gr. g. d., "Soprano," by "Vice Chancellor" (17,180); gr. g. g. d., "Symphony," by "Jock o' Hazledean" (13,085).

**ARTHUR GARFIT**, Scothern, Lincolnshire : **FOURTH PRIZE**, 5*l.*, for "Blanche Rosette 4th," red, 10 months, 3 days-old; bred by himself; sire, "Lord of Scothern" (34,626); dam, "Brilliant Rose 3rd," by "Second Wharfedale Oxford" (30,298); g. d., "Brilliant Rose," by "General Napier" (24,023); gr. g. d., "Brilliant," by "May Duke" (13,320); gr. g. g. d., "Blanche 3rd," by "Antinous" (12,401).

**THE EARL OF SUFFOLK AND BERKSHIRE**, Charlton Park, Malmesbury, Wilts : the *Reserve Number* to "Lady Agnes," roan, 11 months-old; bred by himself; sire, "Lord Lind 2nd" (36,969); dam, "Mary 3rd," by "Honeysuckle Marquis" (21,953); g. d., "Mary 2nd," by "Heir of Walton" (24,125); gr. g. d., "Mary 1st," by "Viscount Walton" (23,154); gr. g. g. d., by "Longfellow" (18,206).

*Shorthorn Cows, and each with not less than Two of her Offspring.\**

**COLONEL R. LOYD-LINDSAY**, V.C., M.P., Lockinge Park, Wantage, Berks : **FIRST PRIZE**, 30*l.*, for "Burlesque," red, 9 years, 6 months, 3 weeks, 4 days-old; bred by himself; sire, "Fawsley Baronet" (23,920); dam, "Britannia," by "Master Coleshill" (18,344); g. d., "Blossom," by "Sultan" (15,358); gr. g. d., "Bloom," by "Neptune" (11,847); gr. g. g. d., "Roeket," by "Fanatic" (8054). And *Offspring*, bred by himself: "Blueberry," red cow, 7 years, 3 months, 3 weeks, 3 days-old; sire, "Rob Roy" (29,806); "Bella Donna," red cow, 6 years, 5 months, 1 week-old; sire, "Lord Napier" (26,691); "Bridesmaid," red cow, 5 years, 5 months, 3 weeks, 6 days-old; sire, "Lord Napier" (26,691); "Cherry Blossom," red cow, 2 years, 6 months, 3 weeks, 3 days-old; sire, "Duke of Cerisia" (30,937).

**JOSEPH STRATTON**, Alton Priors, Marlborough, Wilts : **SECOND PRIZE**, 20*l.*, for "May Rose 2nd," roan, 11 years, 3 months, 3 weeks, 4 days-old; bred by the late Mr. R. Stratton, Burderop; sire, "Bude Light" (21,342); dam, "May Rose," by "Young Windsor" (17,241); g. d., "Essence of Roses," by "His Highness" (14,708); gr. g. d., "Duchess of Glo'ster 5th," by "Waterloo" (11,025); gr. g. g. d., "Elegance," by "Lottery" (4280). And *Offspring*: "Rosette," roan cow, 7 years, 8

\* Prizes given by the Gloucestershire Agricultural Society.

months, 1 week, 3 days-old; bred by the late Mr. R. Stratton, Burderop; sire, "James 1st" (24,202): "Royal James," roan bull, 4 years, 3 weeks, 4 days-old; bred by himself; sire, "James 1st" (24,202): "Rosebud," roan cow, 2 years, 10 months, 2 weeks, 6 days-old; bred by himself; sire, "Royal" (35,331): roan calf, 2 months, 1 week, 4 days-old; bred by himself; sire, "Ethelred" (36,621).

THOMAS HORROCKS MILLER, Singleton Park, Poulton-le-Fylde, Lancashire: THIRD PRIZE, 10*l.*, for "Ringlet 2nd," roan, 13 years, 3 months, 1 week, 3 days-old; bred by Messrs. Atkinson, Bywell Hall Farm, Stocksfield-on-Tyne; sire, "Bywell Victor" (21,353); dam, "Ringlet," by "Lord of the Valley" (14,837); g. d., "Rose Duchess," by "Red Duke" (13,571); gr. g. d., "Red Rose," by "Vanguard" (10,994); gr. g. g. d., "Dinah," by "Diamond" (5918). And *Offspring*, bred by himself: "Ringlet 4th," roan cow, 5 years, 10 months, 3 weeks, 6 days-old; sire, "White Duke" (32,849): "Ringlet 5th," roan cow, 4 years, 8 months, 4 days-old; sire, "Flag of Ireland" (28,613): "Benedictine," red and white bull, 2 years, 5 months, 3 weeks, 3 days-old; sire, "Royal Benedict" (27,348): "Ringlet 7th," red and white heifer, 1 year, 6 months, 2 weeks, 3 days-old; sire, "Braithwaite Booth" (33,192): "Ringlet 8th," red and white heifer-calf, 3 months, 3 days-old; sire, "Water Wizard" (37,657).

JOSEPH STRATTON, Alton Priors, Marlborough, Wilts: the *Reserve Number* to "Persephone," red and white, 5 years, 3 months, 4 days-old; bred by himself; sire, "Eighth Duke of York" (23,808); dam, "Penelope," by "Bude Light" (21,342); g. d., "Michaelmas," by "Hermit" (14,697); gr. g. d., "Young Moss Rose," by "Lottery" (4280); gr. g. g. d., "Moss Rose," by "Phoenix" (6290). And *Offspring*, bred by himself: "Perdita," red cow, 2 years, 10 months, 1 week, 4 days-old; sire, "Royal" (35,331): red steer, 1 year, 10 months, 2 days-old; sire, "Royal James" (35,387): "Proteus," roan bull-calf, 11 months, 3 weeks-old; sire, "Royal James" (35,387): calf; sire, "Ethelred" (36,621).

#### *Hereford Bulls above Three Years old.*

WILLIAM TAYLOR, Showle Court, Ledbury, Herefordshire: FIRST PRIZE, 25*l.*, for "Thoughtful" (5063), 3 years, 9 months, 6 days-old; bred by himself; sire, "Mercury" (3967); dam, "Young Beauty," by "Sir Francis" (3438); g. d., "Beauty," by "Holmer" (2043); gr. g. d., "Hazel," by "Tomboy," (1097); gr. g. g. d., "Hazel."

THOMAS THOMAS, St. Hilary, Cowbridge, Glamorganshire: SECOND PRIZE, 15*l.*, for "Horace 2nd" (4655), 4 years, 1 month, 3 weeks, 3 days-old; bred by Mr. John Price, Court House, Pembridge, Herefordshire; sire, "Horace" (3877); dam, "Damsel 2nd," by "Wanderer" (5132); g. d., "Damsel," by "Treasurer" (1105); gr. g. d., "Duchess," by "Welling-ton" (1112).

#### *Hereford Bulls above Two and not exceeding Three Years old.*

JOHN LEWIS AND EDWIN POWELL, Lower Hill Farm, St. Nicholas, and Wareham, Breinton, Herefordshire: FIRST PRIZE, 25*l.*, for "Telescope," 2 years, 11 months, 1 week-old; bred by Mr. William Taylor, Showle Court, Ledbury; sire, "Tredegar" (5077); dam, "Tulip," by "Triumph" (2836); g. d., "Fairmaid," by "Telltale" (1757); gr. g. d., "Fairmaid," by "Holmer" (2043); gr. g. g. d., "Fairmaid," by "Tomboy" (1097).



HENRY NICHOLAS EDWARDS, Broadward, Leominster, Herefordshire: SECOND PRIZE, 15*l.*, for "Durable," 2 years, 11 months, 5 days-old; bred by himself; sire, "Arkwright 2nd" (4315); dam, "Dahlia 4th," by "Philip" (3314); g. d., "Dahlia," by "Hatfield" (2300); gr. g. d., "Trumpet 2nd," by "Plunder" (1038); gr. g. d., "Trumpet," by "Northampton" (600).

PHILIP TURNER, The Leen, Pembridge, Herefordshire: THIRD PRIZE, 5*l.*, for "Corsair," 2 years, 6 months, 2 days-old; bred by himself; sire, "Dictator" (4511); dam, "Rhoda," by "Subaltern" (2794); g. d., "Norma," by "Bolingbroke" (1883); gr. g. d., "Carissima," by "Felix" (953); gr. g. d., "Rosabelle," by "Duke of St. Albans" (945).

*Hereford Yearling Bulls above One and not exceeding Two Years old.*

JOHN PRICE, Court House, Pembridge, Herefordshire: FIRST PRIZE, 15*l.*, for "Arthur," 1 year, 11 months, 3 weeks, 4 days-old; bred by himself; sire, "Horace 2nd" (4655); dam, "Lady," by "Paragon" (2665); g. d., "Lady," by "Wanderer" (5132); gr. g. d., "Lady," by "Treasurer" (1105); gr. g. d., "Lady," by "Wellington" (1112).

THOMAS JAMES CARWARDINE, Stockton Bury, Leominster, Herefordshire: SECOND PRIZE, 10*l.*, for "Anxiety," 1 year, 9 months-old; bred by himself; sire, "Longhorns" (4711); dam, "Helena," by "De Cote" (3060); g. d., "Regina," by "Heart of Oak" (2035).

HENRY NICHOLAS EDWARDS, Broadward, Leominster, Herefordshire: THIRD PRIZE, 5*l.*, for "Compact," 1 year, 10 months, 4 days-old; bred by himself; sire, "Aldebaran" (4300); dam, "Cherry 2nd," by "Lord Raglan" (3225); g. d., "Cherry," by "Plunder" (4847); gr. g. d., "Columbine 4th," by "Philip" (3314); gr. g. d., "Columbine," by "Chadnor" (1531).

THOMAS THOMAS, St. Hilary, Cowbridge, Glamorganshire: the *Reserve Number* to "Horace," 1 year, 10 months, 5 days-old; bred by himself; sire, "Horace 2nd" (4655); dam, "Sunflower," by "Sir John 3rd" (3456); g. d., "Curly 2nd," by "Goldfinder 2nd" (959); gr. g. d., "Curly," by "Young Royal" (1469).

*Hereford Bull Calves above Six and not exceeding Twelve Months old.*

JOHN HUNGERFORD ARKWRIGHT, Hampton Court, Leominster, Herefordshire: FIRST PRIZE, 15*l.*, for "Conjuror," 10 months, 3 weeks, 5 days-old; bred by himself; sire, "Concord" (4458); dam, "Ivington Lass 3rd," by "Bayleaf" (3675); g. d., "Ivington Lass," by "Dan. O'Connell" (1952).

THOMAS JAMES CARWARDINE, Stockton, Bury, Leominster, Herefordshire: SECOND PRIZE, 10*l.*, for "Lord Oxford," 11 months, 3 weeks, 6 days-old; bred by himself; sire, "Longhorns" (4711); dam, "Rosebud," by "De Cote" (3060); g. d., "Stately," by "Heart of Oak" (2035).

SARAH EDWARDS, Wintercott, Leominster, Herefordshire: THIRD PRIZE, 5*l.*, for "Master Butterfly," 10 months, 3 weeks, 4 days-old; bred by herself; sire, "Royalist" (4921); dam, "Young Mermaid 4th," by "Winter de Cote" (4253); g. d., "Young Mermaid 2nd," by "Tomboy" (3546); gr. g. d., "Young Mermaid," by Adforton" (1839); gr. g. d., "Mermaid," by Sir Newton" (1731).

WILLIAM TUDGE, Leinthall, Ludlow: the *Reserve Number* to "King of the Roses," 11 months, 1 week, 4 days-old; bred by Mr. William Tudge, of

Adforton, Leintwardine, Herefordshire; sire, "The Doctor" (5045); dam, "Roseleaf," by "Lord Hythe" (3937); g. d., "Rosebud," by "Sir Thomas" (2228); gr. g. d., "Rose," by "North Star" 2138); gr. g. g. d., "Rose," by "The Grove" (1764).

*Hereford Cows above Three Years old.*

THE REPRESENTATIVES OF MR. WARREN EVANS, Llandowlais, Usk, Monmouthshire: FIRST PRIZE, 20*l.*, for "Lady Blanche," 4 years, 4 months, 3 weeks-old, in-calf and in-milk, calved January 7, 1878; bred by the late Mr. Warren Evans; sire, "Von Moltke 2nd" (4234); dam, "Fairmaid," by "Prince Alfred" (3342); g. d., "Countess 3rd," by "Monnaughty" (2117); gr. g. d., "Countess 2nd," by "Oakley" (1673); gr. g. g. d., "Countess," by "Gaylad" (400).

THE EARL OF COVENTRY, Croome Court, Severn Stoke, Worcester: SECOND PRIZE, 10*l.*, for "Giantess," 5 years, 11 months, 3 weeks, 6 days-old, in-milk, calved May 25, 1878; bred by Mr. W. Tudge, of Adforton, Leintwardine, Herefordshire; sire, "Sir Roger" (4133); dam, "Haidee," by "Battenhall" (2406); g. d., "Diana," by "Carbonel" (1525); gr. g. d., "Young Dainty," by "The Doctor" (1083); gr. g. g. d., "Dainty," by "Orleton" (901).

JOSEPH E. SPENCER, Fommon, Cowbridge, Glamorganshire: THIRD PRIZE, 5*l.*, for "Princess of Wales," 4 years, 6 months, 2 weeks, 5 days-old, in-calf; bred by himself; sire, "Von Moltke" (4234); dam, "Princess," by "Mansel" (3240); g. d., "Tiny," by "Avenger" (1855); gr. g. d., by "Sir Harry" 3443).

*Hereford Heifers, in-milk or in-calf, not exceeding Three Years old.*

SARAH EDWARDS, Wintercott, Leominster, Herefordshire: FIRST PRIZE, 15*l.*, for "Leonora," 2 years, 10 months, 2 weeks, 6 days-old, in-calf; bred by herself; sire, "Winter de Cote" (4253); dam, "Lovely," by "Tomboy" (3546); g. d., "Lady Grove," by "Adforton" (1839); gr. g. d., "Young Lively," by "Ben" (1870); gr. g. g. d., "Lively," by "Leominster" (1634); and SECOND PRIZE, 10*l.*, for "Beatrice," 2 years, 10 months, 1 week, 2 days-old, in-milk, calved Jan. 13, 1878; bred by herself; sire, "Winter de Cote" (4253); dam, "Brownmaid 2nd," by "Tomboy" (3546); g. d., "Brownmaid," by "Pompey" (2683); gr. g. d., "Barmaid," by "Royal George" (2197); gr. g. g. d., "Prettypaid 2nd," by "Croft."

JOHN H. B. LUTLEY, Brockhampton, Worcester: THIRD PRIZE, 5*l.*, for "Teacher the 2nd," 2 years, 11 months, 3 weeks, 3 days-old, in-calf; bred by himself; sire, "Coriolanus" (3769); dam, "Governess," by "Shamrock 2nd" (2210).

*Hereford Yearling Heifers, above One and not exceeding Two Years old.*

JOHN MORRIS, Lulham, Madley, Hereford: FIRST PRIZE, 15*l.*, for "Empress," 1 year, 11 months, 4 weeks-old; bred by himself; sire, "Sir Charles" (4959); dam "Cowslip 3rd," by "Banquo" (3667); g. d., "Cowslip," by "Interest" (2046); gr. g. d., "Beauty," by "Little Tommy" (985).

SARAH EDWARDS, Wintercott, Leominster, Herefordshire: SECOND PRIZE, 10*l.*, for "Spangle 3rd," 1 year, 11 months, 2 weeks, 3 days-old; bred by himself; sire, "Royalist" (4921); dam, "Sonnet," by "Leominster 3rd"



(3211); g. d. "Silk," by "Comet" (2469); gr. g. d., "Silva," by "Adforton" (1839); gr. g. g. d., "Silver 2nd," by "Sir Newton" (1731).

JOHN MORRIS, Lulham, Madley, Hereford: THIRD PRIZE, 5*l.*, for "Tidy 3rd," 1 year, 3 months, 4 weeks, 1 day-old; bred by himself; sire, "Columbus" (4447); dam, "Tidy 2nd," by "Banquo" (3667); g. d., "Tidy 1st."

WILLIAM TAYLOR, Showle Court, Ledbury, Herefordshire: the *Reserve Number* to "Lancashire Lass," 1 year, 10 months-old; bred by himself; sire, "Tredegar;" dam, "Lovely," by "Tenant Farmer" (2806); g. d., "Brown," by "Twin" (2284).

### *Hereford Heifer Calves, above Six and under Twelve Months old.*

JOHN HUNGERFORD ARKWRIGHT, Hampton Court, Leominster, Herefordshire: FIRST PRIZE, 15*l.*, for "Gaylass 4th," 10 months, 3 weeks, 6 days-old; bred by himself; sire, "Ivington Boy" (4662); dam, "Gaylass 2nd," by "Sir Hungerford" (3447); g. d., "Gaylass," by "Riff Raff" (1052); gr. g. d., "Gaily," by "Quicksilver 2nd;" gr. g. g. d., "Curly," by "Jupiter" (1289).

WILLIAM TAYLOR, Showle Court, Ledbury, Herefordshire: SECOND PRIZE, 10*l.*, for "Empress," 11 months, 2 weeks, 2 days-old; bred by himself; sire, "Tredegar" (5077); dam, "Young Beauty," by "Sir Francis" (3438); g. d. "Beauty," by "Holmer" (2043); gr. g. d., "Hazel," by "Tomboy" (1097); gr. g. g. d., "Hazel."

JOHN HUNGERFORD ARKWRIGHT, Hampton Court, Leominster, Herefordshire: THIRD PRIZE, 5*l.*, for "Abigail," 10 months, 3 weeks, 3 days-old; bred by himself; sire, "Ivington Boy" (4662); dam, "Miss Abigail 2nd," by "Sir Oliver" (1733), g. d., "Miss Abigail."

THOMAS FENN, Stonebrook House, Ludlow: the *Reserve Number* to "Downton Rose," 11 months, 5 days-old; bred by Mr. Thomas Fenn, The Brakes, Ludlow; sire, "Blakemore;" dam, "Rose of the Teme," by "Silver Chief;" g. d., "Queen of the Teme," by "Severus 2nd" (2747), gr. g. d., "Victoria," by "Wilson" (4250); gr. g. g. d., by "Havelock" (1609).

### *Hereford Cows, and each with not less than Two of her Offspring.\**

THOMAS THOMAS, St. Hilary, Cowbridge, Glamorganshire: FIRST PRIZE, 25*l.*, for "Rosaline," 7 years, 11 months, 1 week, 3 days-old; bred by himself; sire, "Sir John 3rd" (3456); dam, "Fairy," by "Shamroek" (2750); g. d., "Fairmaid 2nd," by "Goldfinder 2nd" (959); gr. g. d. "Fairmaid," by "Young Royal" (1469). And *Offspring*, bred by himself: bull, "Goldfinder," 1 year, 10 months, 1 week, 5 days-old; sire, "Horace 2nd" (4655); heifer calf, "Rosaline 2nd," 9 months, 2 weeks-old; sire, "Horace 2nd" (4655).

THOMAS JAMES CARWARDINE, Stoekton Bury, Leominster, Herefordshire: SECOND PRIZE, 15*l.*, for "Cherry," 5 years, 11 months, 3 weeks, 2 days-old; bred by himself; sire, "De Cote" (3060); dam, "Lilae," by "Heart of Oak" (2035), g. d., "Tulip," by "Counsellor" (1939). And *Offspring*, bred by himself: heifer, "Plum," 1 year, 2 months, 4 weeks-

\* Prizes given by the Gloucestershire Agricultural Society.

old; sire, "Longhorns" (4711): heifer calf, "Apple Blossom," 3 months, 4 weeks, 1 day-old; sire, "De Cote."

JOHN MORRIS, Lulham, Madley, Herefordshire: **THIRD PRIZE, 10*l.***, for "Browney," 8 years, 4 months, 3 weeks, 6 days-old; bred by himself; sire, "The Sabre" (3527); dam, "Nuttly 2nd," by "Interest" (2046); g. d., "Old Nutty," by "Greengage" (1266). And *Offspring*, bred by himself: steer, 1 year, 10 months, 2 weeks, 3 days-old; sire, "Sir Charles" (4959): steer calf, 9 months, 3 week-old; sire, "Columbus" (4447).

WILLIAM TAYLOR, Showle Court, Ledbury, Herefordshire: the *Reserve Number* to "Lovely," 12 years-old; bred by himself; sire, "Tenant Farmer" (2806); dam, "Browny," by "Twin" (2284). And *Offspring*, bred by himself: heifer, "Modesty," 2 years, 10 months, 2 weeks, 3 days-old; sire, "Tredegar" (5077): heifer calf, "Adelaide," 11 months, 1 week, 3 days-old; sire, "Tredegar" (5077).

*Devon Bulls, above Three Years old.*

VISCOUNT FALMOUTH, Tregothnan, Probus, Cornwall: **FIRST PRIZE, 25*l.***, for "Sirloin" (1443), 3 years, 8 months, 3 weeks, 2 days-old; bred by himself; sire, "Lord of the Valley" (1150); dam, "Peach" (2095A), by "Young Forester" (759); g. d., "Picture 4th" (2224), by Davy's "Napoleon 3rd" (464); gr. g. d., "Picture" (337).

GEORGE TURNER, JUN., Thorpelds, Northampton: **SECOND PRIZE, 15*l.***, for "Volunteer," 3 years, 11 months, 2 days-old; bred by Captain Taylor, Priesthaus, Eastbourne, Sussex; sire, "Abbott" (980); dam, "Profit's Duchess" (2986), by "Duke of Flitton" (613); g. d. "Profit" (2288), by "Nelson" (83).

MAJOR BULLER, C.B., Downes, Crediton, Devonshire: the *Reserve Number* to his 5 years, 3 months-old; bred by the late Mr. James H. Buller, of Downes, Crediton, Devon.

*Devon Bulls, above Two and not exceeding Three Years old.*

WALTER FARTHING, Stowey Court, Bridgwater: **FIRST PRIZE, 25*l.***, for "Royal Aston," 2 years, 8 months, 3 weeks, 6 days-old; bred by himself; sire, "Master Robin;" dam, "Pretty Face," by "Lovely's Duke;" g. d., "Prettyface," by "Sir George."

VISCOUNT FALMOUTH, Tregothnan, Probus, Cornwall: **SECOND PRIZE, 15*l.***, for "Reflector" (1433), 2 years, 10 months, 4 weeks, 1 day-old; bred by himself; sire, "Lord of the Valley" (1150); dam, "Reflection" (3880), by "Sunflower" (937); g. d., "Picture 4th" (2224) by Davy's "Napoleon 3rd" (464), gr. g. d., "Picture" (337).

MAJOR BULLER, C.B., Downes, Crediton, Devonshire: the *Reserve Number* to his 2 years, 11 months, 3 weeks-old; bred by himself.

*Devon Yearling Bulls, above One and not exceeding Two Years old.*

WALTER FARTHING, Stowey Court, Bridgwater, Somerset: **FIRST PRIZE, 25*l.***, for "Lord Newsham," 1 year, 7 months, 3 weeks, 6 days-old; bred by himself; sire, "Master James;" dam, "Famous," by "Son of Lord Quantock;" g. d., "Famous," by "Duke of Chester;" gr. g. d., "Famous," by "Sultan."

VISCOUNT FALMOUTH, Tregothnan, Probus, Cornwall: SECOND PRIZE, 15*l.*, for his 1 year, 11 months, 2 weeks, 3 days-old; bred by himself; sire, "Master Flitton" (1160); dam, "Christmas Rose" (3280), by "Sunflower" (937); g. d., "Rosa Bonheur" (3009), by "Corrector" (809); gr. g. d., "Picture 4th" (2224), by Davy's "Napoleon 3rd" (464); gr. g. d., "Picture" (337); and THIRD PRIZE, 5*l.*, for his 1 year, 10 months, 1 week, 2 days-old; bred by himself; sire, "Duke of Tregothnan" (1324); dam, "Brunette" (3240), by "Sunflower" (937); g. d., "Cinnaminta" (2572B), by "Protector" (711).

MAJOR BULLER, C.B., Downes, Crediton, Devon, the *Reserve Number* to his 1 year, 6 months-old; bred by himself.

*Devon Bull Calves, above Six and not exceeding Twelve Months old.*

WALTER FARTHING, Stowey Court, Bridgwater, Somerset: FIRST PRIZE, 15*l.*, for "Master Stowey," 9 months, 2 weeks, 3 days-old; bred by himself; sire, "Master Willic;" dam, "Prettyface," by "Lovely Duke;" g. d. "Prettyface," by "Sir George;" gr. g. d. "Young Pink;" by "Viscount."

VISCOUNT FALMOUTH, Tregothnan, Probus, Cornwall: SECOND PRIZE, 10*l.*, to his 10 months, 2 weeks-old; bred by himself; sire, "Sirloin" (1443); dam, "Water Lily" (5050), by "Jonquil" (1131), g. d., "Watercress" (4006), by "Sunflower" (937); gr. g. d., "Cheesewring" (2572A), by "Protector" (711); gr. g. d., "Lilias" (2825), by "Duke of Chester" (404).

WILLIAM HOOD WALROND, New Court, Topsham, Devon: THIRD PRIZE, 5*l.*, for "Master Jack," 11 months, 1 day-old; bred by Mr. Walter Farthing, Stowey Court, Bridgwater; sire, "Master Willie" (1163); dam, "Gentle" (2728); g. d., "Cherry," by "Nelson" (83).

MAJOR BULLER, C.B., Downe, Crediton, Devon: the *Reserve Number* to his 7 months, 2 weeks-old; bred by himself.

*Devon Cows, above Three Years old.*

WALTER FARTHING, Stowey Court, Bridgwater, Somerset: FIRST PRIZE, 20*l.*, for "Prettyface," 5 years, 6 months, 1 week, 3 days-old, in-milk and in-calf, calved Sept. 14, 1877; bred by himself; sire, "Lovely's Duke;" dam, "Prettyface," by "Sir George;" g. d., "Young Pink," by "Viscount:" and SECOND PRIZE, 10*l.*, for "Picotee," 3 years, 9 months, 3 weeks-old, in-milk and in-calf; calved Dec., 15, 1877; bred by Mr. Trevor Lee Senior; sire, "Major;" dam, "Pink."

MRS. MARIA LANGDON, Flitton Barton, North Molton, Devon: THIRD PRIZE, 5*l.*, for "Actress 8th" (3149), 4 years, 10 months, 2 weeks, 5 days-old, in-milk and in-calf, calved Jan. 4, 1878; bred by herself; sire, "Duke of Flitton 8th" (1072); dam, "Actress 5th" (3146), by "Duke of Flitton 4th" (827); g. d. "Actress" (1749), by "Palmerston" (476); gr. g. d., "G. M. Temptress" (1672), by Davy's "Napoleon 3rd" (464); gr. g. g. d., "Pink" (955), by "Nelson" (83).

RICHARD JULYAN, Great Gargass, Grampound, Cornwall: the *Reserve Number* to "Fancy," 4 years, 1 week, 2 days-old; in-milk; calved April 28, 1878; bred by the late Mr. T. Julyan, Tregidgio, Grampound; sire, "Sweet William" (1222); dam, "Jenny Lind" (2775), by "Warrior" (548); g. d. "Famous" (1965), by "Duke of Chester" (404); gr. g. d., "Famous" (1319), by "Sultan" (318); gr. g. g. d., "Famous" (163), by "Watson" (129).

*Devon Heifers, in-milk or in-calf, not exceeding Three Years old.*

MRS. MARIA LANGDON, Flitton Barton, North Molton, Devon: **FIRST PRIZE**, 15*l.*, for "Temptress 8th" (5001), 2 years 1 month, 2 weeks, 2 days-old; in-calf; bred by herself; sire, "Duke of Flitton 10th" (1074); dam, "Temptress 5th" (3963), by "Duke of Flitton 5th" (1069); g. d., "Temptress 2nd" (3070), by "Duke of Cornwall" (820); gr. g. d., "Gold Medal Temptress" (1672), by Davy's "Napoleon 3rd" (464); gr. g. g. d., "Pink" (955), by "Nelson" (83).

WILLIAM SMITH, Whimble House, Whimble, Devon: *the Reserve Number* to "Madge," 2 years, 10 months, 1 week, 3 days-old; in-calf; bred by Mr. John Venn, Whimble; sire, "Duke of Devonshire" (1062); dam, "Lavender," by son of "Prince Jerome."

*Devon Yearling Heifers, above One and not exceeding Two Years old.*

WALTER FARTHING, Stowey Court, Bridgwater, Somerset: **FIRST PRIZE**, 15*l.*, for "Prettyface 2nd," 1 year, 9 months, 2 days-old; bred by himself; sire, "Master Willie;" dam, "Prettyface," by "Lovely Duke;" g. d. "Prettyface," by "Sir George;" gr. g. d., "Young Pink," by "Viscount."

MRS. MARIA LANGDON, Flitton Barton, North Molton: **SECOND PRIZE**, 10*l.*, for "Temptress 12th" (5005), 1 year, 4 weeks-old; bred by herself; sire, "Jonquil" (1131); dam, "Temptress 2nd" (3070), by "Duke of Cornwall" (820); g. d., "Gold Medal Temptress" (1672), by Davy's "Napoleon 3rd" (464); gr. g. d., "Pink" (955), by "Nelson" (83); gr. g. g. d., "Pink" (348); and *the Reserve Number* to "Cherry 10th" (4221), 1 year, 11 months, 4 weeks-old; bred by herself; sire, "Duke of Flitton 10th" (1074); dam, "Cherry 5th" (3264), by "Duke of Flitton 4th" (827); g. d., "Cherry 2nd" (2571), by "Duke of Flitton 2nd" (825); gr. g. d., "Cherry" (1207), by Davy's "Napoleon 3rd" (464); gr. g. g. d., "Old Cherry" (65), by "Duke" (30).

*Devon Heifer-Calves, above Six and under Twelve Months old.*

WILLIAM ROLLES FRYER, Lytehett Minster, Poole, Dorset: **FIRST PRIZE**, 15*l.*, for "Kalmia," 11 months, 3 weeks, 1 day-old; bred by Viscount Portman, Bryanston, Blandford, Dorset; sire, "The Earl" (1464); dam, "Quail" (4880), by "Emperor" (1096); g. d., "Queen" (4886).

WALTER FARTHING, Stowey Court, Bridgwater, Somerset: **SECOND PRIZE**, 10*l.*, for "Famous 2nd," 8 months, 3 weeks, 3 days-old; bred by himself; sire, "Master Willie;" dam, "Famous," by son of "Lord Quantock;" g. d., "Famous," by "Duke of Chester;" gr. g. d., "Famous," by "Sultan."

WILLIAM ROLLES FRYER, Lytehett Minster, Poole, Dorset: **THIRD PRIZE**, 5*l.*, for "Harebell," 11 months, 2 weeks, 4 days-old; bred by himself; sire, "Nero" (1414); dam, "Alice" (3161), by "Emperor" (1096); g. d., "Annie," (3175), by "Duke of Flitton 2nd."

MRS. MARIA LANGDON, Flitton Barton, North Molton, Devon: *the Reserve Number*, to "Cherry 13th," 11 months, 2 weeks, 5 days-old; bred by herself; sire, "Jonquil" (1131); dam, "Cherry 5th" (3264), by "Duke of Flitton 4th" (827); g. d. "Cherry 2nd" (2571), by "Duke of Flitton 2nd" (825); gr. g. d., "Cherry" (1207), by Davy's "Napoleon 3rd" (464); gr. g. g. d., "Old Cherry" (65), by "Duke" (30).



*Sussex Bulls, above Three Years old.*

EDWARD and ALFRED STANFORD, Eatons, Ashurst, Steyning, Sussex: FIRST PRIZE, 15*l.*, for "Dorchester," 6 years, 7 months, 3 weeks, 1 day-old; bred by themselves; sire, "Volunteer;" dam, "Mary Fern."

*Sussex Bulls, above Two and not exceeding Three Years old.*

JOHN AND ALFRED HEASMAN, Angmering, Arundel, Sussex: FIRST PRIZE, 15*l.*, for "Hereford" (263), 2 years, 9 months, 2 weeks 1 day-old; bred by themselves; sire, "Leopold" (228); dam, "Sandgate" (1661).

JAMES BRABY, Maybanks, Rudgwick, Sussex: SECOND PRIZE, 10*l.*, for "The Czar," 2 years, 6 months-old; bred by the late Mr. John Verrall, Swanborough, Lewes; sire, "The Speaker;" dam, "Daisy," by "Itford Bull;" g. d., "Gentle 2nd" (979); gr. g. d., "Gentle" (803); gr. g. g. d., "Gentle," by "Bluebeard."

ALFRED AGATE, Broomhall Farm, Horsham, Sussex: the *Reserve Number* to "Berry" (259), 2 years, 9 months, 2 weeks, 3 days-old; bred by himself; sire, "Frankenstein" (181); dam, "Young Betsy," by "Midsummer" (39).

*Sussex Yearling Bulls, above One Year and not exceeding Two Years old.*

JOHN AND ALFRED HEASMAN, Angmering, Arundel, Sussex: FIRST PRIZE, 10*l.*, for "Lord Bath" (280), 1 year, 9 months, 2 weeks, 6 days-old; bred by themselves; sire, "Calcetto" (273); dam, "Crocus" (1692), by "Lord of Lorne" (207); g. d., "Cheerful," by "Botting Bull."

EDWARD AND ALFRED STANFORD, Eatons, Ashurst, Steyning, Sussex: SECOND PRIZE, 5*l.*, for their 1 year, 9 months, 3 weeks, 1 day-old; bred by Mr. Louis Huth, Possingworth, Waldron; sire, "Allchorn;" dam, "Virgin 3rd."

*Sussex Bull Calves, above Six and not exceeding Twelve Months old.*

JOHN AND ALFRED HEASMAN, Angmering, Arundel, Sussex: FIRST PRIZE, 10*l.*, for their 9 months, 1 week, 6 days-old; bred by themselves; sire, "Calcetto" (273); dam, "Sultana" (1664), by "Southampton" (155).

ALFRED AGATE, Broomhall Farm, Horsham, Sussex: SECOND PRIZE, 5*l.*, for "Oxford," 9 months, 2 weeks, 4 days-old; bred by himself; sire, "Berry" (259); dam, "Honesty 2nd" (1618), by "Alfred 2nd" (177); and the *Reserve Number* to "Berry 1st," 9 months old; bred by himself; sire, "Berry" (259); dam, "Actress 4th" (1676), by "Grand Duke" (183).

*Sussex Cows, above Three Years old.*

JAMES BRABY, Maybanks, Rudgwick, Sussex: FIRST PRIZE, 15*l.*, for "Bouncer" (1472), 6 years, 3 months, 2 weeks-old; in-milk; calved April 23, 1878; bred by himself; sire, "Jupiter" (170); dam, "Beauty" (1151), by "Blackstone" (68).

JOHN AND ALFRED HEASMAN, Angmering, Arundel, Sussex: SECOND PRIZE, 10*l.*, for "Crocus" (1692), 4 years, 8 months, 1 week-old; in-milk and in-calf, calved Sept. 16, 1877; bred by themselves; sire, "Lord of Lorne" (207); dam, "Cheerful," by "Botting Bull."

CHARLES WHITEHEAD, Barming House, Maidstone, Kent: the *Reserve Number* to "May Duchess;" 3 years, 3 months, 2 weeks, 1 day-old, in-milk and in-calf, calved December 16, 1877; bred by himself; sire, "Kentish Red No. 1" (188), dam, "Cherry Blossom" (1595), by "Durrant Bull," g. d., "Curly Smith."

*Sussex Heifers, in-milk or in-calf, above Two and not exceeding Three Years old.*

JOHN and ALFRED HEASMAN, Angmering, Arundel, Sussex: FIRST PRIZE, 15*l.*, for "Rosebud," 2 years, 9 months, 3 weeks-old; in-calf; bred by themselves; sire, "Leopold" (228); dam, "Rose" (1653), by "Southampton" (155).

JAMES BRABY, Maybanks, Rudgwick, Sussex: SECOND PRIZE, 10*l.*, for "Larky" (1788), 2 years, 9 months, 3 weeks, 1 day-old; in-calf; bred by himself; sire, "Headley" (248); dam, "Lilac" (1524), by "Jupiter" (170); g. d., "Loxwood" (1126).

JOHN and ALFRED HEASMAN, Angmering: the *Reserve Number* to "Lady Oxford," 2 years, 8 months, 5 days-old; in-calf; bred by themselves; sire, "Bristol;" dam, "Firle" (1262).

*Sussex Yearling Heifers, above One and not exceeding Two Years old.*

JAMES BRABY, Maybanks, Rudgwick, Sussex: FIRST PRIZE, 10*l.*, for "Rival" (1813), 1 year, 9 months, 1 week, 1 day-old; bred by Messrs. J. and H. Heasman, Caleetto Farm, Arundel, Sussex; sire, "Caleetto" (273); dam, "Firle" (1262).

ALFRED AGATE, Broomhall Farm, Horsham: SECOND PRIZE, 5*l.*, for "Betsy 2nd," 1 year, 9 months, 3 weeks, 6 days-old; bred by himself; sire, "The Duke" (268); dam, "Young Betsey," by "Midsummer" (39).

EDWARD and ALFRED STANFORD, Eatons, Ashurst, Steyning: the *Reserve Number* to their 1 year, 10 months, 1 week, 3 days-old; bred by themselves; sire, "Bedford;" dam, "Strawberry" (1565).

*Sussex Heifer Calves, above Six and not exceeding Twelve Months old.*

JOHN and ALFRED HEASMAN, Angmering, Arundel: FIRST PRIZE, 10*l.*, for "Flora," 8 months, 2 weeks, 3 days-old; bred by themselves; sire, "Hereford" (263); dam, "Hannah" (1780); by "Egerton;" g. d., "Michaelham" (1128).

ALFRED AGATE, Broomhall Farm, Horsham: SECOND PRIZE, 5*l.*, for "Spite 2nd," 10 months, 3 weeks, 2 days-old; bred by himself; sire, "The Squire" (269); dam, "Spite 1st," by "Monarch."

CHARLES WHITEHEAD, Barming House, Maidstone, Kent: the *Reserve Number* to "Cherry Brandy," 11 months, 2 weeks, 2 days-old; bred by himself; sire, "May Duke" (252); dam, "Cherry Bud" (1691), by "Kentish Red" (188); g. d., "Crawl" (1305); gr. g. g. d., "Young Gentle."

*Longhorn Bulls, above Two Years old.*

THE DUKE OF BUCKINGHAM AND CHANDOS, Stowe, Buckingham: FIRST PRIZE, 15*l.*, for "Conqueror 3rd," brindle and white, 6 years, 11 months, 3 weeks-old; bred by himself; sire, "Young Conqueror;" dam, "Lady," by "Boyeott."



MAJOR-GEN. SIR FREDERICK FITZWYGRAM, Bart., Leigh Park, Havant, Hants : SECOND PRIZE, 10*l.*, for "Prince Victor," brindled red and white, 4 years, 3 months-old; bred by Mr. Shaw, Fradley Old Hall, Lichfield, Staffordshire; sire, "Earl of Upton 7th;" dam, "Princess," by "Burbery's Bull;" g. d., "Victoria."

RICHARD HALL, Thurlston, Derby: the *Reserve Number* to "Blue Knight," brindle and white, 5 years, 5 months-old; bred by Mr. J. Godfrey, Wigston Parva, Hinckley, Leicestershire; sire, "Earl of Upton 2nd;" dam, "Rolbright 3rd," by "Red Rover."

*Longhorn Bulls, above One and not exceeding Two Years old.*

THE DUKE OF BUCKINGHAM AND CHANDOS, Stowe, Buckinghamshire: FIRST PRIZE, 15*l.*, for "Sambo," brindle and white, 1 year, 9 months, 1 week, 5 days-old; bred by himself; sire, "Earl of Temple;" dam, "Barmaid," by "Conqueror 3rd;" g. d., "Negress 2nd," by "Conqueror."

JOHN GODFREY, Wigston Parva, Hinckley, Leicestershire: SECOND PRIZE, 10*l.*, for "The Captain," red and white, 1 year, 3 months, 2 weeks, 5 days-old; bred by himself; sire, "Blue Knight;" dam, "Fair," by "Sampson;" g. d., "Curly Coat," by "Old Sparkenhoc;" gr. g. d., "Lady," by "Perfection;" gr. g. g. d., "Bright Eye," by "Dordon."

*Longhorn Cows, in-calf or in-milk, above Three Years old.*

RICHARD HALL, Thurlston, Derby: FIRST PRIZE, 15*l.*, for "Calke," brindle and white, 7 years, 3 months, 1 week, 1 day-old; in-calf; bred by Mr. R. H. Chapman, St. Asaphs, North Wales; sire, "Earl of Warwick;" dam, "Old Brindled Beauty," by "Old Sparkenhoe;" g. d., "Fillpail."

*Longhorn Heifers, in-calf or in-milk, not exceeding Three Years old.*

RICHARD HALL, Thurlston, Derby: FIRST PRIZE, 15*l.*, for "Bodelwyddan 2nd," red and white, 2 years, 2 months, 1 week, 2 days-old; in-calf; bred by himself; sire, "Earl of Upton 3rd;" dam, "Maid of Bodelwyddan," by "Messenger;" g. d., "Lady Whitacre; gr. g. d., "Lily;" and SECOND PRIZE, 10*l.*, for "Polly 2nd," red and white, 2 years, 3 months, 1 week, 4 days-old; in-calf; bred by himself; sire, "Earl of Upton 7th;" dam, "Polly," by "Sir Oliver;" g. d., "Razor-back," by "Sir Richard."

*Jersey Bulls, above Two Years old.*

CECIL BERNARDINO DIXON, The Vinery, Hurley Warren, Southampton: FIRST PRIZE, 15*l.*, for "Saint Brelade," fawn grey, 3 years, 2 months, 1 week-old; bred by Mr. J. Vautier, St. Brelade, Jersey; sire, "Rupert;" dam, "Rosena."

HERBERT ADDINGTON RIGG, Wykcham Lodge, Walton-on-Thames, Surrey: SECOND PRIZE, 10*l.*, for "Gipsy Lad," silver grey, 2 years, 4 months, 1 week-old; bred by himself; sire, "Gipsy King;" dam, "Topsy," by "Grays."

WILLIAM ALEXANDER, Trinity Manor Farm, Jersey: THIRD PRIZE, 5*l.*, for "Grey King," grey, black points, 2 years, 1 month, 4 weeks-old; bred by himself; sire, "Duke" (76); dam, "Lily Grey" (770).

JOHN CARDUS, Town Hill, West End, Southampton: the *Reserve Number* to "Dairy King," silver grey, 3 years, 4 weeks, 1 day-old; bred by Mr. W. J. Beadel, Springfield Lyons, Chelmsford; sire, "Ducat;" dam,

"Milklike," by "Banboy;" g. d., Milkmaid," by "Jack Weller;" gr. g. d., "Grasshopper," by "Omer Pacha;" gr. g. g. d., "Tramp," by "Bradwell."

*Jersey Bulls, above One and not exceeding Two Years old.*

- THE EARL OF EGMONT, Cowdray Park, Midhurst, Sussex: FIRST PRIZE, 15*l.*, for "Lord Montague," silver grey, 1 year, 8 months-old; bred by himself; sire, Lord Grey;" dam, "Curly."
- FINDLATER CRANG, Timsbury, Bath, Somersetshire: SECOND PRIZE, 10*l.*, for "Ranger," dark grey, 1 year, 8 months, 2 weeks, 5 days-old; bred by himself; sire, "Yankee" (69); dam, "L'Echappée."
- LORD CHESHAM, Latimer, Chesham, Bucks: THIRD PRIZE, 5*l.*, for "Emperor," silver grey, 1 year, 4 months, 1 week-old; bred by himself; sire, "Fanfaron;" dam, "Evelyn," by "Dandy;" g. d., "Elfin," by "Vampire;" gr. g. d., "Elfin," by "Fowler;" gr. g. g. d., "Elk," by "Wapiti."
- WILLIAM ALEXANDER, Trinity Manor Farm, Jersey: the *Reserve Number* to "Tommy," grey, black points, 1 year, 3 months-old; bred by himself; sire, "Princee;" dam, "Nelly."

*Jersey Cows, above Three Years old.*

- THOMAS BARKER MILLER, Bishops Stortford, Herts: FIRST PRIZE, 15*l.*, for "Duchess," silver grey, 5 years, 4 months-old; in-milk, calved Mareh, 1878; bred by Mr. Gosling, Hassobury, Bishops Stortford; sire, "Banboy."
- LORD CHESHAM, Latimer, Chesham: SECOND PRIZE, 10*l.*, for "Haphazard," silver grey, 4 years, 2 months, 3 weeks, 3 days-old; in-milk, calved May 10, 1878; bred by Mr. Gilbey; sire, "Banboy;" dam, "Hap," by "Banboy;" g. d., "Jersey;" and THIRD PRIZE, 5*l.*, for "Laura," dark silver grey, 4 years, 10 months, 2 weeks, 4 days-old; in-milk, calved April 13, 1878; bred by himself; sire, "Baron;" dam, "Laburnum;" g. d., "Lily."
- WILLIAM HOOD WALROND, Newcourt, Topsham, Devon: the *Reserve Number* to "Beauty," silver grey, 4 years, 8 months, 2 weeks, 5 days-old; in-milk, calved May 6, 1878; bred by himself; dam, "Dairy Maid."

*Jersey Heifers, in-milk or in-calf, not exceeding Three Years old.*

- JAMES ODAMS, The Grange, Bishops Stortford, Herts: FIRST PRIZE, 15*l.*, for "Faney," light fawn, 1 year, 5 months old; in-calf; bred by himself; sire, "Nobleman;" dam, "Fantail," by "Don."
- LORD CHESHAM, Latimer, Chesham: SECOND PRIZE, 10*l.*, for "Laurel," silver grey, 1 year, 2 months, 2 weeks-old, in-calf; bred by himself; sire, "Sambo;" dam, "Laura," by "The Baron;" g. d., "Laburnum;" gr. g. d., "Lily."
- THOMAS BARKER MILLER, Bishops Stortford, Herts: THIRD PRIZE, 5*l.*, for "Beauty," fawn, 1 year, 10 months-old; in-calf; bred by himself; sire, "Nobleman;" dam, "Daisy;" g. d., "Princess."
- LORD CHESHAM, Latimer: the *Reserve Number* to "Patti," silver grey, 1 year, 6 months-old; in-calf; bred by himself; sire, "Sambo;" dam "Pretty," by "Host;" g. d., "Sultana."

*Guernsey Bulls, above One Year old.*

- ROBERT N. G. BAKER, Heavitree, Exeter, Devon: FIRST PRIZE, 15*l.*, for "Prince Charlie," red and white, 2 years, 5 months, 3 weeks, 4 days-old; bred by himself; sire, "Johnnie;" dam, "Primrose."
- WILLIAM HOOD WALROND, New Court, Topsham, Devon: SECOND PRIZE, 10*l.*, for "The Count," yellow and white, 1 year, 6 months, 5 days-old; bred by himself; sire, "Young Duke;" dam, "Lady Elizabeth," by "Lord John."
- JAMES JAMES, Les Vauxbelets, Guernsey: the *Reserve Number* to "Chieftain," light red and white, 1 year, 10 months, 2 weeks, 4 days-old; bred by himself; sire, "Royal Duke;" dam, "Lassie 2nd," by "Lord of the Isles;" g. d., "Lassie 1st," by "Charles 1st;" gr. g. d., "Dairymaid."

*Guernsey Cows, above Three Years old.*

- ROBERT N. G. BAKER, Heavitree, Exeter: FIRST PRIZE, 15*l.*, for "Young Nancy," yellow and white, 3 years, 9 months, 2 days-old; in-calf; bred by himself; sire, "Johnnie;" dam, "Nancy," by "Champion;" g. d., "Lucy."
- REV. J. R. WATSON, La Favorita, Guernsey: SECOND PRIZE, 10*l.*, for "Miranda," fawn and white, 4 years, 7 months, 1 week, 3 days-old; in-calf; bred by himself: and the *Reserve Number* to "Sylvia No. 2," light fawn and white, 4 years, 2 weeks, 3 days-old; in-calf; bred by himself; sire, "Cloth of Gold No. 2;" dam, "Sylvia No. 1;" g. d., "Placida."

*Guernsey Heifers, in-milk or in-calf, not exceeding Three Years old.*

- ROBERT N. G. BAKER, Heavitree, Exeter: FIRST PRIZE, 15*l.*, for "Dolly," yellow and white, 2 years, 1 week-old; in-milk, calved April 10, 1878; bred by himself; sire, "Johnnie;" dam, "Nelly:" SECOND PRIZE, 10*l.*, for "Lady Jane," yellow and white, 2 years, 6 months, 1 week-old; in-milk, calved April 10, 1878; bred by himself; sire, "Johnnie;" dam, "Lady Bird," by "Charlie;" g. d. "Susan:" and the *Reserve Number* to "Crocus," yellow and white, 2 years, 10 months-old, in-milk, calved March 20, 1878; bred by himself; sire, "Johnnie;" dam, "Snowdrop," by "Highland Bull;" g. d., "Primrose."

*Pairs of Dairy Cows, in-milk, over Four Years old, milking properties specially considered.\**

- RICHARD STRATTON, The Duffryn, Newport, Monmouthshire: FIRST PRIZE, 20*l.*, for his roan shorthorns, "Fairy Queen," 7 years, 5 months-old; sire, "Reflector" (27259): and "Alice," 9 years, 4 months-old; sire, "Orontes" (24695); bred by himself.
- JOHN REYNOLDS KEEN, Chewton Farm, Stone Easton, Bath: SECOND PRIZE, 10*l.*, for "Dairy Maid," dark roan shorthorn, 5 years, 10 months, 3 weeks, 4 days-old; sire, "Quaker:" and "Red Rose," red shorthorn, 5 years, 6 days-old; sire, "Quaker;" bred by Mr. J. T. Smith, Quinton, Northamptonshire.
- FREDERICK HARVEY, Churchman House, Gloucester: THIRD PRIZE, 5*l.*, for his roan shorthorns, "Sovereign," 5 years-old, and "Lady," 6 years-old; bred by himself.

---

\* Prizes given by the Bristol Local Committee.

JOHN YALLAND, Fishponds, Bristol: the *Reserve Number* to his light dun shorthorn, 6 years old; bred by Mr. Williams, of Dodddington, Gloucester; and his red and white shorthorn, 7 years old; bred by himself.

*Pairs of Dairy Cows, not exceeding Four Years old, milking properties specially considered.\**

SIR PHILIP MILES, Bart., Leigh Court, Bristol: FIRST PRIZE, 20*l.*, for "Dauntless 24th," roan shorthorn, 3 years, 7 months, 2 weeks, 4 days-old; sire, "Proud Youth" (32224); dam, "Dauntless 14th," by "Cormorant" (19511): and "Julia," red and white shorthorn, 3 years, 5 months, 1 day-old; sire, "Proud Youth" (32224); dam, "Katie," by "Spree" (25208); bred by the late Sir William Miles, Bart., of Leigh Court, Bristol.

JOHN YALLAND, Fishponds, Bristol: SECOND PRIZE, 10*l.*, for his roan shorthorn, 3 years, 4 months, 2 weeks, 5 days-old: and his white shorthorn, 3 years, 2 months, 3 weeks, 2 days-old; bred by himself.

*Pairs of Heifers, in-calf, under Three Years old.\**

RICHARD STRATTON, The Duffryn, Newport, Monmouthshire: FIRST PRIZE, 15*l.*, for his roan shorthorns, "Pearl," 2 years, 11 months, 2 weeks, 3 days-old; sire, "Rob Roy" (29806); dam, "Oyster," by "Reflector" (27259): and "Bonnet," 2 years, 2 months, 1 week, 5 days-old; sire, "Rob Roy" (29806); dam, "Bonny," by "Orontes" (24695); bred by himself.

JOHN YALLAND, Fishponds, Bristol: SECOND PRIZE, 10*l.*, for his white shorthorn, 2 years, 2 months, 1 week, 5 days-old: and his roan shorthorn, 2 years, 5 months, 2 weeks, 3 days-old; bred by himself.

JOHN CARDUS, Town Hill, West End, Southampton: the *Reserve Number* to "Topsy," smoky-fawn Jersey, 2 years, 9 months, 2 weeks-old; sire, "Chandos;" dam, "Brunette:" and "Darling," grey-fawn Jersey, 1 year, 10 months, 4 days-old; sire, "Prince Charlie;" dam, "Barwell;" bred by himself.

*Welsh Black Bulls, Two Years-old and upwards.†*

CHARLES SALUSBURY MAINWARING, Llaethwryd, Corwen, Denbighshire: FIRST PRIZE, 20*l.*, for "Taihirion," black, 3 years, 2 months, 3 weeks, 3 days-old; bred by Mr. R. Roberts, Pentrevoelas, Llanrwst.

EARL CAWDOR, Stackpole Court, Pembroke: SECOND PRIZE, 15*l.*, for "Prince of Wales," black, 3 years, 5 months, 2 weeks, 3 days-old; bred by Mr. Prosser, Llanrian, Haverfordwest, Pembroke; sire, "Ap Gelert;" dam, "Ruth 2nd;" g. d., "Ruth 1st."

DAVID DAVIES, Cringwheel, Llanybyther, Cardiganshire: THIRD PRIZE, 10*l.* for "Young Robin Dhu," black, 2 years, 4 months, 4 days-old; bred by Mr. John Davies, Capeldewi, Ganol, Carmarthen.

HENRY LEACH, Corston, Pembroke: the *Reserve Number* to "Turk," black, 3 years, 1 month, 3 weeks 3 days-old; bred by Mr. Griffiths, Penally Court, Tenby; sire, "The Shah" (20).

\* Prizes given by the Bristol Local Committee.

† Prizes given by noblemen and gentlemen residing in Wales.

*Welsh Black Bulls, not exceeding Two Years old.†*

- WILLIAM JAMES, Talybont House, Narbeth, Pembrokeshire: FIRST PRIZE, 20*l.*, for "Nigger Boy," black, 1 year, 10 months, 3 weeks, 3 days-old; bred by himself; sire, "The Duke;" dam, "Bedwen."
- JOHN SLATER WILKINSON, Paskeston, Pembroke: SECOND PRIZE, 15*l.*, for "The Devil," black, about 1 year, 5 months-old; bred by Mr. Griffiths, of Penally, Tenby.
- MRS. LETTICE WILLIAMS, Love Lodge, Llandilo, Carmarthen: THIRD PRIZE, 10*l.*, for "Lyman," black, 1 year, 11 months, 2 weeks, 1 day-old; bred by herself; sire, "Tichborne 2nd;" dam, "Victoria," by "Irving;" g. d., "Queen;" gr. g. d., "Colby."
- RICHARD HUMPHREYS, Royal Goat Hotel, Beddgelert, Carnarvon: the *Reserve Number* to "Prince Llewelyn 3rd," black, 1 year, 9 months, 3 weeks, 5 days-old; bred by himself; sire, "Prince Llewelyn 1st;" dam, "Black Duchess."

*Welsh Black Cows, above Three Years old, in-calf or in-milk.†*

- JOHN CHARLES BEST, Plas-yn-Vivod, Llangollen: FIRST PRIZE, 15*l.*, for "Welsh Duchess," black, 6 years, 3 weeks, 2 days-old; in-calf; bred by Mr. Richard Humphreys, Royal Goat Hotel, Beddgelert; sire, "Prince of Wales, 1st;" dam, "Jenny."
- JOHN WALTERS, Molfreisa, Carmarthen: SECOND PRIZE, 10*l.*, for "Favouritc," black, 8 years, 4 months, 1 week, 4 days-old; in-calf; bred by himself.
- JOHN CHARLES BEST, Plas-yn-Vivod: THIRD PRIZE, 5*l.*, for "Black Queen," black, 8 years, 1 month, 2 weeks, 1 day-old; in-calf; bred by Mr. Richard Humphreys, of Royal Goat Hotel, Beddgelert.
- HUGH HARRIES, Veynor, Narberth, Pembroke: the *Reserve Number* to "Mary Anne," black, 13 years, 3 months-old; in-calf; bred by himself; dam, Fanny; g. d., "Wingould."

*Welsh Black Heifers, in-Milk or in-Calf, above Two and not exceeding Three Years old.†*

- WALTER JENKINS, Glanwern, Talsarn, Cardiganshire: FIRST PRIZE, 15*l.*, for "Nell," black, 2 years, 4 months; in-calf; bred by himself; sire, "Arvon" (35); dam, "Glen," by "Prince Arthur;" g. d., "Beauty."
- EARL CAWDOR, Stackpole Court, Pembroke: SECOND PRIZE, 10*l.*, for "Kitty 6th," black, about 2 years, 4 months-old, in-calf; bred by Mr. R. H. Harvey, Slade Hall, Haverfordwest, Pembrokeshire; sire, "Laurel" (44); dam, "Kitty 5th" (57); and THIRD PRIZE, 5*l.*, for "Vivandieria," black, about 2 years, 5 months-old; in-calf; bred by Mrs. Williams, of Love Lodge, Llandilo; sire, "Tichborne 2nd" (64); dam, "Lovely" (145); g. d., "Beauty."

*Welsh Black Heifers, above One and not exceeding Two Years old.†*

- EARL CAWDOR, Stackpole Court, Pembroke: FIRST PRIZE, 15*l.*, for "Leonora," black 1 year, 11 months, 6 days-old; bred by Mr. Morgan, of Lamphy, Pembroke; dam, "Leda;" g. d., "Martha."

---

† Prizes given by noblemen and gentlemen residing in Wales.



- RICHARD HUMPHREYS, Royal Goat Hotel, Beddgelert, Carnarvonshire : SECOND PRIZE, 10*l.*, for "Black Queen 2nd," black, 1 year, 9 months, 4 days-old; bred by himself; sire, "Prince Llewelyn 1st;" dam, "Black Queen."
- MRS. LETTICE WILLIAMS, Love Lodge, Llandilo, Carmarthenshire : THIRD PRIZE, 5*l.*, for "Myfanw," black, 1 year, 2 months-old; bred by herself; sire, "Tichborne 2nd;" dam, "Rosal," by "Lover;" g. d., "Victoria," by "Irving;" gr. g. d., "Queen;" gr. g. g. d., "Colby."
- JAMES DAVIES, Pengawse, Whitland, Pembrokeshire : the *Reserve Number* to "The Gift," black, 1 year, 8 months, 2 weeks, 5 days-old; bred by Mr. J. Griffiths, Penally Court, Tenby; sire, "Roger Tichborne;" dam, "Lovely;" g. d., "Blacky."

## SHEEP.

*Leicester Shearling Rams.*

- TEASDALE HILTON HUTCHINSON, Manor House, Catterick, Yorkshire : FIRST PRIZE, 20*l.*, for his 1 year, 3 months, 3 weeks-old; bred by himself.
- HEBDEN BORTON, Manor House, Barton-le-Street, Malton : SECOND PRIZE, 10*l.*, for his 1 year, 3 months, 2 weeks-old; bred by himself.
- WILLIAM BROWN, High Gate House, Holme-on-Spalding-Moor : THIRD PRIZE, 5*l.*, for his 1 year, 3 months-old; bred by himself.
- HEBDEN BORTON, Manor House, Barton-le-Street, Malton : the *Reserve Number* to his 1 year 3 months, 2 weeks-old; bred by himself.

*Leicester Rams of any other age.*

- TEASDALE HILTON HUTCHINSON, Manor House, Catterick, Yorkshire : FIRST PRIZE, 20*l.*, for his 2 years, 3 months-old; bred by himself; sire, "Royal Taunton."
- HEBDEN BORTON, Manor House, Barton-le-Street, Malton : SECOND PRIZE, 10*l.*, for "Liverpool," 4 years, 4 months-old; bred by himself: and THIRD PRIZE, 5*l.*, for "Broughton," 2 years, 3 months, 2 weeks-old; bred by himself.
- WILLIAM TREMAINE, Polsue House, Grainpound, Cornwall : the *Reserve Number* to his 2 years, 3 months-old; bred by himself; sire, "Young Inge."

*Leicester Shearling Ewes, Pens of Five.*

- GEORGE TURNER, jun., Thorpeldans, Northampton : FIRST PRIZE, 15*l.*, for his 1 year, 2 months, 2 weeks-old; bred by himself: and SECOND PRIZE, 10*l.*, for his 1 year, 2 weeks, 2 weeks-old; bred by himself.
- WILLIAM BROWN, High Gate House, Holme-on-spalding-Moor, Yorkshire : THIRD PRIZE, 5*l.*, for his 1 year, 3 months-old; bred by himself.
- WILLIAM TREMAINE, Polsue House, Gram-pound : the *Reserve Number* to his about 1 year, 3 months-old; bred by himself; sire, "Birmingham."



*Cotswold Shearling Rams.*

JOHN GILLETT, Oaklands, Charlbury, Oxon: FIRST PRIZE, 15*l.*, for his 1 year, 5 months, 1 week-old; bred by himself.

RUSSELL SWANWICK, the Royal Agricultural College Farm, Cirencester, Gloucestershire: SECOND PRIZE, 10*l.*, for his about 1 year, 4 months-old; bred by himself: and THIRD PRIZE, 5*l.*, for his about 1 year, 4 months-old; bred by himself.

JOHN GILLETT, Oaklands: the *Reserve Number* to his 1 year, 5 months, 1 week-old; bred by himself.

*Cotswold Rams of any other age.*

RUSSELL SWANWICK, Royal Agricultural College Farm, Cirencester: FIRST PRIZE, 20*l.*, for his about 3 years, 4 months-old; bred by himself.

THOMAS BROWN, Marham Hall, Downham Market, Norfolk: SECOND PRIZE, 10*l.*, for his 3 years, 4 months, 2 weeks-old; bred by himself.

RUSSELL SWANWICK, Royal Agricultural College Farm: THIRD PRIZE, 5*l.*, for his about 2 years, 4 months-old; bred by himself.

THOMAS BROWN, Marham Hall: the *Reserve Number* to his 2 years, 4 months, 2 weeks-old; bred by himself.

CHAMPION PRIZE, 25*l.*, for the *Best Ram in the two preceding Classes, given by the Gloucestershire Agricultural Society.*

RUSSELL SWANWICK: for his 3 years, 4 months-old.

*Cotswold Shearling Ewes, Pens of Five.*

JOHN GILLETT, Oaklands, Charlbury, Oxon: FIRST PRIZE, 30*l.*,\* for his 1 year, 5 months, 1 week-old; bred by himself.

THOMAS and STEPHEN GEORGE GILLETT, Kilkenny, Faringdon: SECOND PRIZE, 10*l.*, for their 1 year, 4 months, 2 weeks-old; bred by themselves.

JOHN GILLETT, Oaklands, Charlbury: THIRD PRIZE, 5*l.*, for his 1 year, 5 months, 1 week-old; bred by himself.

SAMUEL SMITH, Somerton, Deddington, Oxfordshire: the *Reserve Number* to his 1 year, 4 months, 2 weeks-old; bred by himself.

*Lincoln Shearling Rams.*

HENRY SMITH, The Grove, Cropwell Butler, Bingham, Notts: FIRST PRIZE, 20*l.*, for "Maxwell," 1 year, 4 months-old; bred by himself.

ARTHUR GARFIT, Sothorn, Lincoln: SECOND PRIZE, 10*l.*, for his 1 year, 4 months, 2 weeks-old; bred by himself.

WILLIAM and HENRY DUDDING, Pantou House, Wragby: THIRD PRIZE, 5*l.*, for their 1 year, 3 months, 2 weeks-old; bred by themselves: and the *Reserve Number* to their 1 year, 3 months, 2 weeks-old; bred by themselves.

\* Of this sum 15*l.* is given by the Gloucestershire Agricultural Society.

*Lincoln Rams of any other age.*

HENRY SMITH, The Grove, Cropwell Butler, Bingham, Nottinghamshire : FIRST PRIZE, 20*l.*, for "Hermit," 4 years, 4 months-old ; bred by Mr. T. Casswell, Pointon, Folkingham.

CHARLES SELL, Poplar Farm, Bassingbourne, Royston, Cambridgeshire : SECOND PRIZE, 10*l.*, for his 3 years, 4 months-old ; bred by Mr. E. Howard, Nocton Rise, Lincoln.

ALGERNON HACK, Buckminster, Grantham, Lincolnshire : THIRD PRIZE, 5*l.*, for his 3 years, 4 months-old ; bred by himself.

WILLIAM and HENRY DUDDING, Panton House, Wragby, Lincolnshire : the *Reserve Number* to their 2 years, 3 months, 3 weeks-old ; bred by themselves.

*Lincoln Ewes, Pens of Five.*

CHARLES SELL, Poplar Farm, Bassingbourne, Royston : FIRST PRIZE, 15*l.*, for his 1 year, 3 months, 3 weeks-old ; bred by himself.

THOMAS GUNNELL, Willow House, Milton, Cambridge : SECOND PRIZE, 10*l.* for his 1 year, 4 months-old ; bred by himself.

JOHN BYRON, Kirkby Green, Sleaford, Lincolnshire : THIRD PRIZE, 5*l.*, for his 1 year, 4 months-old ; bred by himself.

JOHN PEARS, Mere, Lincoln : the *Reserve Number* to his 1 year, 4 months-old ; bred by himself.

*Oxfordshire Down Shearling Rams.*

CHARLES HOWARD, Biddenham, Bedford : FIRST PRIZE, 20*l.*, for his 1 year, 4 months, 2 weeks-old ; bred by himself.

CHARLES HOBBS, Maisey Hampton, Fairford, Gloucestershire : SECOND PRIZE, 10*l.*, for his 1 year, 4 months, 2 weeks-old ; bred by himself.

JOHN TREADWELL, Upper Winehendon, Aylesbury : THIRD PRIZE, 5*l.*, for "Baron Heythrop," about 1 year, 3 months, 2 weeks-old ; bred by himself ; sire, "Chipping Norton."

CHARLES HOBBS, Maisey Hampton, Fairford : the *Reserve Number* to his 1 year, 4 months, 2 weeks-old ; bred by himself.

*Oxfordshire Down Rams of any other age.*

JOHN TREADWELL, Upper Winehendon, Aylesbury : FIRST PRIZE, 20*l.*, for "Royal Liverpool," about 2 years, 4 months, 2 weeks-old ; bred by himself ; sire, "Freeland;" and SECOND PRIZE, 10*l.*, for "The Swell," about 2 years, 4 months, 2 weeks-old ; bred by himself ; sire, "Freeland."

FREDERIC STREET, Somersham Park, St. Ives, Hunts : THIRD PRIZE, 5*l.*, for "Royal Liverpool," 2 years, 5 months-old ; bred by himself.

CHARLES HOBBS, Maisey Hampton, Fairford, Gloucestershire : the *Reserve Number* to his 2 years, 4 months, 2 weeks-old ; bred by himself.

*Oxfordshire Down Ewes, Pens of Five.*

ALBERT BRASSEY, Heythrop Park, Chipping Norton, Oxon : FIRST PRIZE, 15*l.*, for his 1 year, 5 months-old ; bred by himself.

JOHN TREADWELL, Upper Winchendon, Aylesbury: SECOND PRIZE, 10*l.*, for his about 1 year, 4 months, 2 weeks-old; bred by himself.

GEORGE ADAMS, Pidnell Farm, Faringdon, Berkshire: THIRD PRIZE, 5*l.*, for his 1 year, 4 months, 1 week-old; bred by himself; sire, "Clarence."

GEORGE WALLIS, Old Shifford, Bampton, Faringdon: the *Reserve Number* to his 1 year, 5 months, 2 weeks-old; bred by himself.

*Southdown Shearling Rams.*

LORD WALSINGHAM, Merton Hall, Thetford, Norfolk: FIRST PRIZE, 20*l.*, for his 1 year, 4 months-old; bred by himself: and SECOND PRIZE, 10*l.*, for his 1 year, 4 months-old; bred by himself.

HUGH GORRINGE, Kingston-by-Sea, Shoreham, Sussex: THIRD PRIZE, 5*l.*, for his about 1 year, 4 months, 2 weeks-old; bred by himself.

WILLIAM RIGDEN, Ashcroft, Kingston-by-Sea, Shoreham: the *Reserve Number* to his 1 year, 4 months-old; bred by himself.

*Southdown Rams of any other age.*

LORD WALSINGHAM, Merton Hall, Thetford, Norfolk: FIRST PRIZE, 20*l.*, for his 2 years, 4 months-old; bred by himself: SECOND PRIZE, 10*l.*, for his 3 years, 4 months-old; bred by himself: and THIRD PRIZE, 5*l.*, for his 2 years, 4 months-old; bred by himself.

HUGH GORRINGE, Kingston-by-Sea, Shoreham, Sussex: the *Reserve Number* to his about 2 years, 4 months, 2 weeks-old; bred by himself.

*Southdown Ewes, Pens of Five.*

LORD WALSINGHAM, Merton Hall, Thetford: FIRST PRIZE, 15*l.*, for his 1 year, 4 months-old; bred by himself.

SIR NICHOLAS WILLIAM THROCKMORTON, Bart., Buckland, Faringdon, Berkshire: SECOND PRIZE, 10*l.*, for his 1 year, 4 months-old; bred by himself.

H.R.H. THE PRINCE OF WALES, K.G., Sandringham, King's Lynn, Norfolk: THIRD PRIZE, 5*l.*, for his 1 year, 4 months-old; bred by His Royal Highness.

CHARLES CHAPMAN, Frocester Court, Stonehouse, Gloucestershire: the *Reserve Number* to his 1 year, 3 months, 2 weeks-old; bred by himself.

*Shropshire Shearling Rams.*

HENRY TOWNSEND, Caldicote Hall, Nuneaton, Warwickshire: FIRST PRIZE, 20*l.*, for his about 1 year, 4 months-old; bred by himself; sire, "Example."

GEORGE GRAHAM, The Oaklands, Birmingham: SECOND PRIZE, 10*l.*, for his 1 year, 4 months, 2 weeks-old; bred by himself; sire, Mrs. Beach's "No. 18."

THOMAS JAMES MANSELL, Dudmaston Lodge, Bridgnorth: THIRD PRIZE, 5*l.*, for his 1 year, 4 months, 2 weeks-old; bred by himself; sire, "May Duke."

THOMAS NOCK, Sutton Maddock, Shifnal: the *Reserve Number* to his 1 year, 4 months-old; bred by himself; sire, "Aston."

*Shropshire Rams of any other age.*

HENRY TOWNSHEND, Caldicote Hall, Nuneaton, Warwickshire: FIRST PRIZE, 20*l.*, for "Talisman," about 3 years, 4 months-old; bred by himself; sire, "Sample."

EDWARD CRANE and ALFRED TANNER, Shrawardine, Montford Bridge, R. S. O.: SECOND PRIZE, 10*l.*, for their 2 years, 3 months, 1 week-old; bred by themselves.

HENRY JAMES SHELDON, Brailes House, Shipton-on-Stour, Warwickshire: THIRD PRIZE, 5*l.*, for his about 2 years, 4 months-old; bred by himself.

EDWARD CRANE and ALFRED TANNER, Shrawardine: the *Reserve Number* to their 2 years, 3 months, 2 weeks-old; bred by themselves; sire, "Claude Duval."

*Shropshire Ewes, Pens of Five.*

LORD CHESHAM, Latimer, Chesham, Bucks: FIRST PRIZE, 15*l.*, for his 1 year, 3 months-old; bred by himself.

CHARLES BYRD, Littywood, Stafford: SECOND PRIZE, 10*l.*, for his 1 year, 4 months-old; bred by himself.

THOMAS NOCK, Sutton Maddock, Shifnal: THIRD PRIZE, 5*l.*, for his 1 year, 4 months-old; bred by himself; sire, "Touchstone."

GEORGE GRAHAM, The Oaklands, Birmingham: the *Reserve Number* to his 1 year, 4 months, 2 weeks-old; bred by himself.

*Hampshire and other Short-woolled Shearling Rams.*

ALFRED MORRISON, Fonthill House, Hindon, Wilts: FIRST PRIZE, 20*l.*, for his Hampshire Down, 1 year, 5 months, 3 weeks-old; bred by himself.

HENRY LAMBERT, Great Abington, Cambridge: SECOND PRIZE, 10*l.*, for his Hampshire Down, about 1 year, 5 months-old; bred by himself.

JOHN BARTON, Hackwood Farm, Basingstoke, Hants: THIRD PRIZE, 5*l.*, for his Hampshire Down, 1 year, 5 months, 1 week-old; bred by himself.

ALFRED MORRISON, Fonthill House: the *Reserve Number* to his Hampshire Down, 1 year, 5 months, 1 week-old; bred by himself.

*Hampshire and other Short-woolled Rams of any other age.*

ALFRED MORRISON, Fonthill House: FIRST PRIZE, 20*l.*, for his Hampshire Down; bred by himself.

JOHN AND MATTHEW ARNOLD, Westmeon, Petersfield, Hants: SECOND PRIZE, 10*l.*, for their Hampshire Down, "Gladstone," 3 years, 5 months, 2 weeks-old; bred by themselves; sire, "Last Parker."

FRANK R. MOORE, Littlecot, Pewsey, Wilts: THIRD PRIZE, 5*l.*, for his Hampshire Down, 2 years, 4 months, 3 weeks-old; bred by himself.

ROBERT COLES, Middleton Farm, Warminster, Wilts: the *Reserve Number* to his Hampshire Down, 2 years, 3 months, 2 weeks-old; bred by himself.

*Hampshire and other Short-woolled Shearling Ewes, Pens of Five.*

JAMES READ, Homington, Salisbury, Wilts: FIRST PRIZE, 15*l.*, for his Hampshire Downs, about 1 year, 6 months-old; bred by himself: and SECOND

PRIZE, 10*l.*, for his Hampshire Downs, about 1 year, 6 months-old ; bred by himself.

*Devon Long-woolled Shearling Rams.*

RICHARD CORNER, Torweston, Williton, Somerset : FIRST PRIZE, 10*l.*, for his 1 year, 4 months-old ; bred by himself.

SIR J. H. HEATHCOAT AMORY, Bart., M.P., Knightsbays Court, Tiverton, Devon : SECOND PRIZE, 5*l.*, for his 1 year, 4 months-old ; bred by himself : and the *Reserve Number* to his 1 year, 4 months, 2 weeks-old ; bred by himself.

*Devon Long-woolled Rams of any other age.*

SIR J. H. HEATHCOAT AMORY, Bart., M.P., Knightsbays Court, Tiverton : FIRST PRIZE, 10*l.*, for his 2 years, 4 months-old ; bred by himself.

RICHARD CORNER, Torweston, Williton, Somerset : SECOND PRIZE, 5*l.*, for his 2 years, 4 months-old ; bred by himself.

ALFRED BOWERMAN, Capton, Williton, Taunton, Somerset : the *Reserve Number* to his 2 years, 4 months, 1 week-old ; bred by himself.

*Devon Long-woolled Ewes, Pens of Five.*

SIR J. H. HEATHCOAT AMORY, Bart., M.P., Knightsbays Court, Tiverton, Devon : FIRST PRIZE, 10*l.* for his 1 year, 4 months-old ; bred by himself.

RICHARD CORNER, Torweston, Williton, Somerset : SECOND PRIZE, 5*l.*, for his 1 year, 4 months-old ; bred by himself.

*Somerset and Dorset Horned Shearling Rams.*

HERBERT FARTHING, Nether Stowey, Bridgwater : FIRST PRIZE, 10*l.*, for his 1 year, 5 months, 3 weeks-old ; bred by himself.

JAMES CULVERWELL, Clavelshay, North Petherton, Bridgwater : SECOND PRIZE, 5*l.*, for his 1 year, 6 months-old ; bred by himself.

*Somerset and Dorset Horned Rams of any other age.*

HERBERT FARTHING, Nether Stowey, Bridgwater : FIRST PRIZE, 10*l.*, for his 2 years, 5 months, 3 weeks-old ; bred by himself.

*Somerset and Dorset Horned Ewes, Pens of Five.*

JOHN MAYO, Broadway Farm, Dorchester, Dorset : FIRST PRIZE, 10*l.*, for his 1 year, 6 months, 2 weeks-old ; bred by himself : and SECOND PRIZE, 5*l.*, for his 1 year, 6 months, 2 weeks-old ; bred by himself.

*Dartmoor Shearling Rams.*

JOHN LENDON BREMIDGE, Martin Farm, Whiddon Down, Okchampton, Devon : FIRST PRIZE, 10*l.*, for his 1 year, 2 months, 2 weeks-old ; bred by himself : and SECOND PRIZE, 5*l.*, for his 1 year, 2 months, 2 weeks-old ; bred by himself.



ROGER PALMER, Venn Farm, Beaworthy, Exbourne, Devon: the *Reserve Number* to his 1 year, 3 months, 2 weeks-old; bred by himself.

*Dartmoor Rams of any other age.*

ROGER PALMER, Venn Farm, Beaworthy, Exbourne: FIRST PRIZE, 10*l.*, for his 4 years, 2 months, 2 weeks-old; bred by himself.

WILLIAM SQUIRE, Bonnaford Farm, Brentor, Bridestowe, Devon: SECOND PRIZE, 5*l.*, for "Tom," 2 years, 3 months, 3 weeks-old; bred by Mr. Jackman, Meadwell, Kelly, Lifton, Devon: and the *Reserve Number* to "Bob," 4 years, 3 months, 3 weeks-old; bred by Mr. Cole, Lanwyllen, Cornwall.

*Dartmoor Ewes, Pens of Five.*

JOHN LENDON BREMRIDGE, Martin Farm, Whiddon Down, Okehampton, Devon: FIRST PRIZE, 10*l.*, for his 1 year, 2 months, 2 weeks-old; bred by himself.

*Exmoor Shearling Rams.*

LORD POLTIMORE, Poltimore Park, Exeter: FIRST PRIZE, 10*l.*, for his 1 year, 4 months-old; bred by himself: and SECOND PRIZE, 5*l.*, for his 1 year, 4 months-old; bred by himself.

MRS. MARIA LANGDON, Flitton Barton, North Molton, Devon: the *Reserve Number* to "Big Ben," about 1 year, 3 months, 2 weeks-old; bred by herself; sire, "Tiverton."

*Exmoor Rams of any other age.*

EARL FORTESCUE, Castle Hill, South Molton, Devon: FIRST PRIZE, 10*l.*, for his about 5 years-old; bred by Mr. James Quartley, Newport Terrace, Barnstaple.

MRS. MARIA LANGDON, Flitton Barton, North Molton, Devon: SECOND PRIZE, 5*l.*, for "King of the Forest," about 2 years, 3 months, 2 weeks-old; bred by herself; and the *Reserve Number* to "Rent Payer," about 3 years, 3 months, 2 weeks-old; bred by herself; sire, "Champion 2nd."

*Exmoor Ewes, Pens of Five.*

LORD POLTIMORE, Poltimore Park, Exeter: FIRST PRIZE, 10*l.*, for his about 1 year, 4 months-old; bred by himself.

EARL FORTESCUE, Castle Hill, South Molton: SECOND PRIZE, 5*l.*, for his 1 year, 3 months, 1 week-old; bred by himself; and the *Reserve Number* to his 1 year, 3 months, 1 week-old; bred by himself.

PIGS.

*Large White Breed—Boars, above Six Months and not exceeding Twelve Months old.*

JAMES AND F. HOWARD, Britannia Farms, Bedford: FIRST PRIZE, 10*l.*, for "Tiger 3rd," 9 months, 2 days-old; bred by themselves; sire, "Darby;" dam, "Golden Fly," by "Ranger."



RICHARD ELMHIRST DUCKERING, Northorpe, Kirton Lindsey, Lincolnshire: SECOND PRIZE, 5*l.*, for "Cultivator 17th," 11 months, 1 week-old; bred by himself; sire, "Cultivator 15th."

*Large White Breed—Boars, above Twelve Months old.*

THE EARL OF ELLESMERE, Worsley Hall, Manchester: FIRST PRIZE, 10*l.*, for "Samson 2nd," 3 years, 6 months-old; bred by Mr. M. Walker, Chaddesden, Derby; sire, "Samson;" dam by "Victor 2nd."

JAMES AND F. HOWARD, Britannia Farms, Bedford: SECOND PRIZE, 5*l.*, for "Tiger 2nd," 2 years, 7 months, 3 weeks, 5 days-old; bred by themselves; sire, "Baron Saron;" dam, "Silver Hair 2nd," by "Duke."

RICHARD ELMHIRST DUCKERING, Northorpe, Kirton Lindsey: the *Reserve Number* to "Cultivator 15th," 3 years, 9 months-old; bred by himself; sire, "Cultivator 13th."

*Large White Breed—Pens of three Breeding Sow Pigs.*

THE EARL OF ELLESMERE, Worsley Hall, Manchester: FIRST PRIZE, 10*l.*, for his 5 months, 3 weeks, 6 days-old; bred by himself; sire, "Samson 3rd;" dam by "Yorkshire Hero."

ROBERT TOMMAS, Winson Green, Birmingham: SECOND PRIZE, 5*l.*, for his 5 months, 3 weeks-old; bred by himself; sire, "Emperor;" dam, "Blanche," by "The Shah."

JAMES AND F. HOWARD, Britannia Farms, Bedford: the *Reserve Number* to their 5 months, 1 week, 4 days-old; bred by themselves; sire, "Major;" dam, "Violet," by "Duke."

*Large White Breed—Breeding Sows.*

RICHARD ELMHIRST DUCKERING, Northorpe, Kirton Lindsey: FIRST PRIZE, 10*l.*, for his 1 year, 10 months, 1 week-old; bred by himself; sire, "Cultivator 13th."

THE EARL OF ELLESMERE, Worsley Hall, Manchester: SECOND PRIZE, 5*l.*, for "Duchess;" age and breeder unknown: and the *Reserve Number* to "Pride of the Village," 2 years, 6 months-old; bred by himself; sire, "Samson;" dam by "Yorkshire Champion."

*Small White Breed—Boars, above Six Months and not exceeding Twelve Months old.*

THE EARL OF ELLESMERE, Worsley Hall: FIRST PRIZE, 10*l.*, for "The Swell," 10 months, 3 weeks, 3 days-old; bred by himself; sire, "XL;" dam, "Nelly Farren."

SANDERS SPENCER, Holywell, St. Ives, Hunts: SECOND PRIZE, 5*l.*, for his 11 months-old; bred by himself; sire, "Puritan;" dam, "Oh Yes," by "The Czar."

GEORGE MUMFORD SEXTON, Wherstead Hall, Ipswich: the *Reserve Number* to "Victorious," 11 months, 6 weeks-old; bred by himself; sire, "Triumph;" dam, "Riot," by "Disturbance."

*Small White Breed—Boars, above Twelve Months old.*

- SANDERS SPENCER, Holywell, St. Ives: FIRST PRIZE, 10*l.*, for "Omega," 1 year, 5 months, 5 days-old; bred by himself; sire, "Puritan;" dam, "Oh No," by "The Czar."
- THE EARL OF ELLESMERE, Worsley Hall, Manchester: SECOND PRIZE, 5*l.*, for "2nd Duke of Lancaster," about 4 years-old; bred by himself; sire, "Duke of Lancaster;" dam, "Queen."
- SANDERS SPENCER, Holywell: the *Reserve Number*, to "Pat," 1 year, 3 months, 5 days-old; bred by himself; sire, "Tom Thumb;" dam, "Purc Small," by "Disturbance."

*Small White Breed—Pens of Three Breeding Sow Pigs.*

- THE EARL OF ELLESMERE, Worsley Hall, Manchester: FIRST PRIZE, 10*l.*, for his 5 months, 2 weeks, 4 days-old; bred by himself; sire, "Young XL;" dam, "Beauty."
- THE EARL OF RADNOR, Coleshill House, Highworth, Wiltshire: SECOND PRIZE, 5*l.*, for his 5 months, 3 week, 4 days-old; bred by himself; sire, "Warwick;" dam, "Cushion," by "Coleshill."

*Small White Breed—Breeding Sows.*

- SANDERS SPENCER, Holywell, St. Ives, Hunts: FIRST PRIZE, 10*l.*, for his 1 year, 3 months, 5 days-old, in-pig; bred by himself; sire, "Tom Thumb;" dam, "Pure Small," by "Disturbance."
- LORD MORETON, Tortworth Court, Falfield, Gloucestershire: SECOND PRIZE, 5*l.*, for "Pearl," 1 year, 3 months, 3 days-old; in-pig; bred by himself; sire, "Barrister;" dam, "Topsy 7th," by "Prince."
- RICHARD ELMHIRST DUCKERING, Northorpe, Kirton Lindsey: the *Reserve Number*, to his 1 year, 8 months-old; bred by himself.

*Small Black Breed—Boars, above Six and not exceeding Twelve Months old.*

- GEORGE MUMFORD SEXTON, Wherstead Hall, Ipswich: FIRST PRIZE, 10*l.*, for "Childeric," 10 months, 3 weeks-old; bred by himself; sire, "Prince Charlie;" dam, by "Blair Athol;" SECOND PRIZE, 5*l.*, for "Thurio," 10 months, 1 week, 4 days-old; bred by himself; sire, "Gladiateur 2nd;" dam, "Betsy," by "Prodigal;" and the *Reserve Number*, to "Sir Joseph," 11 months, 3 weeks, 5 days-old; bred by himself; sire, "Prince Charlic;" dam, "Adventuress," by "Adventurer."

*Small Black Breed—Boars, above Twelve Months old.*

- GEORGE MUMFORD SEXTON, Wherstead Hall, Ipswich: FIRST PRIZE, 10*l.*, for "Insulaire," 1 year, 1 month, 1 day-old; bred by himself; sire, "Prodigal;" dam, by "Gladiateur."
- JOHN PARTRIDGE, Hillerton House, Bow, North Devon: SECOND PRIZE, 5*l.*, for his 1 year, 3 months-old; bred by himself.
- GEORGE TURNER, JUN., Thorpelands, Northampton: the *Reserve Number* to his 2 years, 10 months, 2 weeks-old; bred by himself.

*Small Black Breed—Pens of Three Breeding Sow Pigs.*

- WILLIAM F. COLLIER, Woodtown, Horrabridge, South Devon : FIRST PRIZE, 10*l.*, for his 3 months, 3 weeks, 3 days-old ; bred by himself ; sire, "Liverpool;" dam, by "Bedford."
- THE EARL OF PORTSMOUTH, Eggesford House, Wembworthy, North Devon : SECOND PRIZE, 5*l.*, for his 3 months, 1 week, 4 days-old ; bred by himself ; sire, "Duke of Camborne;" dam, "Queen 2nd," by "General."

*Small Black Breed—Breeding Sows.*

- THE REV. WILLIAM HOOPER, Chilfrome Rectory, Dorchester, Dorset : FIRST PRIZE, 10*l.*, for "Gipsev Queen," 1 year, 1 month, 2 weeks, 6 days-old ; in-pig ; bred by himself ; sire, "Sultan."
- JOHN PARTRIDGE, Hillerton House, Bow, North Devon : SECOND PRIZE, 5*l.*, for his 1 year, 9 months-old ; in-pig ; bred by himself.
- THE EARL OF PORTSMOUTH, Eggesford House, North Devon : the *Reserve Number* to his 1 year, 3 weeks, 4 days-old ; in-pig ; bred by himself ; sire, "Gaffer;" dam, "Queen 2nd," by "General."

*Berkshires—Boars, above Six Months and not exceeding Twelve Months old.*

- HEBER HUMFREY, Kingstone Farm, Shrivvenham, Berks : FIRST PRIZE, 10*l.*, for "Bertie Saverna," 11 months, 1 week, 5 days-old ; bred by himself ; sire, "Lieutenant Savern;" dam, "Mill Court," by "Whitesmith."
- ARTHUR STEWART, Saint Bridge Farm, Gloucester : SECOND PRIZE, 5*l.*, for "Major," 11 months, 2 weeks, 6 days-old ; bred by himself ; sire, "Hesperian Major;" dam, "Kalvellie the 3rd," by "Robin Hood."
- WILLIAM HEWER, Sevenhampton, Highworth, Wilts : the *Reserve Number* to "Hopewell 2nd," 9 months, 1 week-old ; bred by himself ; sire, "Union Jack 2nd;" dam, "Hyacinth," by "Wallace."

*Berkshires—Boars, above Twelve Months old.*

- HEBER HUMFREY, Kingstone Farm, Shrivvenham : FIRST PRIZE, 10*l.*, for "Mountain Walk," 2 years, 2 weeks, 3 days-old ; bred by himself ; sire, "Duke of Swinetown;" dam, "Sidewalk," by "Kingcraft."
- WILLIAM HEWER, Sevenhampton, Highworth, Wilts : SECOND PRIZE, 5*l.*, for "Unison," 2 years, 2 months, 1 week-old ; bred by himself ; sire, "Union Jack 2nd;" dam, "Fashion," by "Wallace."
- ARTHUR STEWART, Saint Bridge Farm, Gloucester : the *Reserve Number* to "Victor," 1 year, 4 weeks-old ; bred by himself ; sire, "Robin Hood 2nd;" dam, "Cirencester," by "Royal Pennant."

*Berkshires—Pens of Three Breeding Sow Pigs.*

- ARTHUR GARFIT, Scothern, Lincoln : FIRST PRIZE, 10*l.*, for his 5 months, 1 week, 4 days-old ; bred by himself ; sire, "The Nigger," dam, "Cherry."
- ARTHUR STEWART, Saint Bridge Farm, Gloucester : SECOND PRIZE, 5*l.*, for his 5 months, 3 weeks, 6 days-old ; bred by himself ; sire, "Royal;" dam, "Last Link."

WILLIAM HEWER, Sevenhampton, Highworth, Wilts: the *Reserve Number* to his 5 months, 3 weeks, 6 days-old; bred by himself; sire, "Wrangler;" dam, "Hester," by "Rover."

*Berkshires—Breeding Sows.*

ARTHUR GARFIT, Scothern, Lincoln: FIRST PRIZE, 10*l.*, for "Cherry Blossom," 1 year, 5 months, 2 weeks, 4 days-old; in-pig; bred by himself; sire, "The Nigger;" dam, "Cherry."

HEBER HUMFREY, Kingstone Farm, Shrivenham, Berkshire: SECOND PRIZE, 5*l.*, for "Donna Louise," 2 years, 1 month, 3 weeks, 6 days-old; in-pig; bred by Mr. D. Ashcroft, Blackamoor's Head, Preston, Lancashire; sire, "Sir Roger;" dam, "Belladonna," by "Kingcraft."

RICHARD FOWLER, Broughton, Aylesbury, Bucks: the *Reserve Number* to his 2 years, 1 month-old; in-pig; bred by himself.

*Other Breeds—Boars, above Six Months and not exceeding Twelve Months old.*

RICHARD ELMHIRST DUCKERING, Northorpe, Kirton Lindsey: FIRST PRIZE, 10*l.*, for his white, 11 months, 1 week-old; bred by himself.

THE EARL OF ELLESMERE, Worsley Hall, Manchester: SECOND PRIZE, 5*l.*, for "Young Hero," white, 11 months, 3 weeks, 6 days-old; bred by himself; sire, "Hero;" dam, "Dolly Varden."

ROBERT TOMMAS, Winson Green, Birmingham: the *Reserve Number* to "Puneh," white, 11 months, 1 week-old; bred by himself; sire, "Esau;" dam, "Jenny," by "Samson."

*Other Breeds—Boars above Twelve Months old.*

PETER EDEN, Cross Lane, Salford, Manchester: FIRST PRIZE, 10*l.*, for "Star of the East," white with spots, 2 years 10 months-old; bred by himself; sire, "King;" dam, "Sunrise," by "Major."

ROBERT TOMMAS, Winson Green, Birmingham: SECOND PRIZE, 5*l.*, for "Esau 2nd," white, 1 year, 11 months-old; bred by himself; sire, "Esau 1st;" dam, "Minerva," by "Jerry."

THE EARL OF ELLESMERE, Worsley Hall, Manchester: the *Reserve Number* to "King Victor," white, 1 year, 11 months, 3 weeks, 4 days-old; bred by himself; sire, "Young King;" dam, "Duchess."

*Other Breeds—Pens of Three Breeding Sow Pigs.*

THE EARL OF ELLESMERE, Worsley Hall, Manchester: FIRST PRIZE, 10*l.*, for his white, 5 months, 3 weeks, 6 days-old; bred by himself; sire, "Hercules;" dam, "Yorkshire Queen."

THOMAS PULLIN, Oxwick Farm, Yate, Chipping Sodbury, Gloucestershire: SECOND PRIZE, 5*l.*, for his white, 4 months, 3 weeks, 6 days-old; bred by himself.

CHARLES MORT, Burlton, Shrewsbury: the *Reserve Number* to his white, 5 months, 3 weeks, 3 days-old; bred by himself; sire, "Hero;" dam, "Stump Tail," by "Dick."

*Other Breeds—Breeding Sows.*

- THE EARL OF ELLESMERE, Worsley Hall: FIRST PRIZE, 10*l.*, for "Kate Vaughan," white, 2 years, 3 months-old; bred by himself; sire, "Prince Royal;" dam, "Fairy Queen."
- PETER EDEN, Cross Lane, Salford, Manchester: SECOND PRIZE, 5*l.*, for "Sunset;" white, 2 year, 5 months, 3 days-old; bred by himself; sire, "Prince 3rd;" dam, "Sunshine," by "Major."
- RICHARD ELMHIRST DUCKERING, Northorpe, Kirton Lindsey, Lincolnshire: the *Reserve Number* to his white, 1 year, 10 months-old; bred by himself.

## CHEESE.\*

*Four Cheeses over Eighty-four Pounds each, any make or colour, made in 1877.*

- CHARLES THATCHER STALLARD, Stanton Wick Farm, Pensford, Gloucestershire: FIRST PRIZE, 20*l.*
- JAMES WILLCOX, Stomacher Farm, Shepton Mallet: SECOND PRIZE, 15*l.*
- WILLIAM and THOMAS ALLEN, Crookwood Farm, Erchfont, Devizes, Wiltshire: THIRD PRIZE, 10*l.*
- CHARLES ROBERT MABY, Storridge Farm, Westbury, Wilts: the *Reserve Number*.

*Four Cheeses under Eighty-four Pounds each, made in 1877.*

- JOHN BENNETT, Wanstrow, Frome: FIRST PRIZE, 15*l.*
- CHARLES CREES, Seymour's Court Farm, Beckington, Bath: SECOND PRIZE, 10*l.*
- JAMES HODDINOTT, Hill House, Lipyeat, Bath: THIRD PRIZE, 5*l.*
- JOHN LEE, Halghton Hall, Bangor-Isycoed, Wrexham, Flintshire: the *Reserve Number*.

*Four Cheeses over Seventy Pounds each, made in 1878.*

- WILLIAM CORP, Sandford Orcas, Sherborne, Dorset: FIRST PRIZE, 20*l.*
- JOHN BENNETT, Wanstrow, Frome, Somerset: SECOND PRIZE, 15*l.*
- GEORGE GIBBONS, Tunley Farm, Bath: THIRD PRIZE, 10*l.*
- JAMES WILLCOX, Stomacher Farm, Shepton Mallet, Somerset: the *Reserve Number*.

*Four Cheeses under Seventy Pounds each, made in 1878.*

- JAMES HODDINOTT, Hill House, Lipyeat, Bath: FIRST PRIZE, 15*l.*
- JOHN BENNETT, Wanstrow, Frome, Somerset: SECOND PRIZE, 10*l.*
- CHARLES ROBERT MABY, Storridge Farm, Westbury, Wiltshire: THIRD PRIZE, 5*l.*
- EDWIN PARROTT, St. Algar's Farm, Frome, Somerset: the *Reserve Number*.

\* Prizes given by the Bristol Local Committee.

*Award of Prizes at Bristol.*

*One Hundredweight of Thin Cheeses, under Twenty Pounds each, made in 1878.*

JOHN BENNETT, Wanstrow, Frome, Somerset: FIRST PRIZE, 20*l*.

THOMAS JOHN MOON, Vallis Farm, Frome, Somerset: SECOND PRIZE, 15*l*.

JOHN SMITH, Nupdown Farm, Thornbury, Gloucester: THIRD PRIZE, 10*l*.

CHARLES CREES, Seymour's Court Farm, Beckington, Bath: the *Reserve Number*.

*One Hundredweight of Truckle Cheese, under Twenty Pounds each, made in 1878.*

JOHN BENNETT, Wanstrow, Frome, Somerset: FIRST PRIZE, 20*l*.

EDWIN PARROTT, St. Algar's Farm, Frome, Somerset: SECOND PRIZE, 15*l*.

EDWARD BENNETT, Netherstreet, Bromham, Chippenham, Wilts: THIRD PRIZE, 10*l*.

JEFFERY HAM, Chapel Farm, East Brent, Bridgwater, Somerset: the *Reserve Number*.

## BUTTER.\*

*Six Pounds of Fresh Butter in 1*lb*. or  $\frac{1}{2}$ *lb*. prints or rolls.*

JAMES DAVIS, Katherine Farm, Henbury, Bristol: FIRST PRIZE, 10*l*.

ELIZABETH WITHEY, Yew Tree Farm, North Wick, Dandry, near Bristol: SECOND PRIZE, 8*l*.

ELIZABETH VOWLES, Tickenham, Clevedon, Somerset: THIRD PRIZE, 5*l*.

ABRAHAM DAVIS, Kingroad Farm, Shirehampton, Bristol: FOURTH PRIZE, 3*l*.

*Twenty Pounds of Salted Butter, to be delivered at Bristol twenty-eight days before the Show.*

EDWIN GEORGE HALLETT, Alston Farm, Chardstock, Chard, Somerset: FIRST PRIZE, 7*l*.

LORD POLTIMORE, Poltimore Park, Exeter, Devon: SECOND PRIZE, 5*l*.

CATHERINE BOWEN, Trevayog, Fishguard, Pembroke: THIRD PRIZE, 4*l*.

JOSEPH SAUNDERS, North Leaze Farm, Castle Carey, Somerset: FOURTH PRIZE, 2*l*.

## FARM PRIZES.\*

*For the best-managed Farms in Gloucestershire, East Somerset, and North Wilts.*

SECTION I.—ARABLE FARMS with at least two-thirds of their area under rotation of cropping.

*Farms of two hundred acres and upwards in extent.*

THOMAS REDMAN HULBERT, North Cerney, Cirencester: PRIZE of 50*l*.

WILLIAM ARKELL, Jun., Glebe Farm, Hatherop, Fairford: SECOND PRIZE, 25*l*.

\* Prizes given by the Bristol Local Committee.



SECTION II.—DAIRY OR STOCK FARMS where the course of cultivation is chiefly directed to the production of cheese or butter, or of animal food.

*Farms of two hundred acres and upwards in extent.*

ALBERT JAMES STEEDS, Red House Farm, Stratton-in-the-Fosse, Bath : FIRST PRIZE, 50*l*.

GEORGE GIBBONS, Tunley Farm, Bath : SECOND PRIZE, 25*l*.

JOHN REYNOLDS KEEN, Chewton Farm, Stone Easton, Bath : SPECIAL PRIZE, 10*l*.†

JOHN MASKELEYNE, Hankeston, Malmesbury : SPECIAL PRIZE, 10*l*.†

*Farms above eighty and under two hundred acres in extent.*

JOHN WILLIAM LONG, Kellaway's Farm, Chippenham : FIRST PRIZE, 30*l*.

JAMES HODDINOT, Lipyeat, Bath : SECOND PRIZE, 15*l*.

---

### IMPLEMENTS.

*For the best Milk-can, suitable for conveying milk long distances by road or rail without injury.*

W. ALWAY and SONS, 37, Chapel Street, Pentonville, London : FIRST PRIZE, 10*l*.

VIPAN and HEADLY, Leicester : *Highly Commended.*

*For the best Churn for churning a sufficient quantity of milk to produce not more than 20lbs. of Butter.*

E. AHLBORN, Hildesheim, Hanover, Germany; for his Holstein Vertical Churn : PRIZE, 10*l*.

*For the best Churn for churning a sufficient quantity of cream to produce not more than 20lbs. of Butter.*

THOMAS and TAYLOR, 80 and 82, Lower Hillgate, Stockport, Cheshire : PRIZE, 10*l*.

ROBINSON and RICHARDSON, Kendal, Westmoreland : *Highly Commended.*

T. BRADFORD and Co., The Crescent Ironworks, Manchester : *Highly Commended.*

*For the best mechanical or automatic Butter-worker, suitable for large dairies and for factories.*

E. AHLBORN, Hildesheim, Hanover, Germany : PRIZE, 10*l*.

*For the best mechanical or automatic Butter-worker, suitable for small dairies; price to be specially considered.*

E. AHLBORN, Hildesheim, Hanover, Germany : PRIZE, 10*l*.

---

† Prizes given by the Royal Agricultural Society.

*Award of Prizes at Bristol.*

*For the best Cheese-tub ; economy of labour to be specially considered.*

R. CLUETT, Bank Buildings, Tarporley, Cheshire : PRIZE, 10*l.*

*For the best Curd-knife.*

W. GILMAN, Hartington, Ashbourne, Derbyshire : PRIZE, 5*l.*

*For the best Curd-mill.*

HENRY BAMFORD and SONS, Leighton Ironworks, Uttoxeter, Staffs : PRIZE, 5*l.*

*For the best Cheese-turning Apparatus:*

CARSON and TOONE, Wiltshire Foundry, Warminster, Wilts : PRIZE, 10*l.*

*For the best automatic means of Preventing the Rising of Cream.*

H. E. MINES, 79, Redcliff Street, Bristol : for his Automatic Milk Agitator : PRIZE, 10*l.*

*For the best Milk-cooler.*

LAWRENCE and Co., 22, St. Mary Axe, E.C. : PRIZE, 10*l.*

*Special Prize.*

E. AHLBORN, 10*l.* : for Cooling Vat and Milk Pans on Swartz System.

#### GOLD MEDAL

*For an efficient Sheaf-binding Machine, either attached to a Reaper or otherwise,*

To WAITE, BURNELL, HUGGINS, and Co., 228, Upper Thames Street, London : for McCormick's Harvester and Self-binder.

WALTER A. WOOD, 36, Worship Street, London : *Highly Commended* for his Self-binding Harvester.

#### MISCELLANEOUS AWARDS.

##### SILVER MEDALS.

R. HORNSBY and SONS, Spittlegate Ironworks, Grantham : for their Machine for Cutting and Trimming Hedges.

JOHN FOWLER and Co., the Steam Plough Works, Lcds : for their Circular Valve attached to 16-Horse Power Cultivating Engine.

MORRIS and GRIFFIN, the Ceres Works, Wolverhampton, Staffs : for Turton's Permanent Rick Coverings.

## AGRICULTURAL EDUCATION.

*Senior Examination Papers, 1878.*

---

### EXAMINATION IN AGRICULTURE.

MAXIMUM NUMBER OF MARKS, 200. PASS NUMBER, 100.

*Tuesday, April 23rd, from 10 a.m. till 1 p.m.*

1. State the mode of cultivation of a light-land farm of 500 acres, 100 of which are grass, viz. :—

The rotation of crops.

The necessary operations for each crop.

The manures to be applied per acre.

The quantity of seed required per acre and the time of sowing.

The probable produce of corn and roots per acre.

The treatment of the grass-land and the proportion which should be cut for hay, and the mode of making it.

2. State the mode of cultivation of a strong or heavy clay land farm of 500 acres, 100 of which are grass, viz. :—

The rotation of crops.

The necessary operations for each crop.

The manures to be applied per acre.

The quantity of seed required per acre and the time of sowing.

The probable produce of corn and roots per acre.

The treatment of the grass-land and the proportion which should be cut for hay, and the mode of making it.

3. Give the number of horses required to work each farm, and the number that would be saved, if the occupier were the owner of a steam ploughing apparatus.

4. Describe the system of harvesting crops and the cost per acre for the manual labour of the various operations, in the district with which you are acquainted.

5. What is the amount of capital required for each of the above farms, the live-stock required and its probable cost, and the annual amount to be paid for labour ?

6. What are the necessary implements required for each farm, with their cost ?

7. Describe the method of managing farm horses, and give their cost for keep, harness, shoeing, &c., for each horse per year.

8. Describe the mode of feeding three-year-old bullocks from the 1st of November to the 1st of March, the kind and quantity of food for each bullock with its weekly cost, together with the weekly increase in weight for each bullock, which such feeding would produce.

9. Describe the management of a dairy herd during the winter months, and state the kind and quantity of food with its cost, and the probable yield of milk and butter from each cow weekly.

10. Describe the mode of weaning calves.

11. What is the age at which a heifer should have her first calf, and what is the term of gestation?

12. Describe the management of a flock of ewes from the 1st of October until after the lambing season, with the most suitable kind of food for ewe and lamb up to the time of weaning, the kind of food adapted for lambs after weaning, until put to roots.

13. Give the number of hoggets required to consume 20 acres of roots, of 20 tons per acre, to be made fat from the 1st of November to the 1st of March with the amount of cake and corn they should each receive daily, with the probable increase in weight during three months.

14. What are the indications of age of cattle, sheep, and horses?

15. What are the most prevalent diseases in cattle and sheep, and the premonitory symptoms of each?

16. Describe the mode of preparing and laying down land to permanent pasture.

17. What is the average cost of the following operations in the district with which you are acquainted?—

Wheat hoeing at 8 inches apart per acre.

Bean hoeing at 18 inches apart per acre.

Roots hoed and singled at 24 inches apart per acre.

Topping, cleaning, and clamping turnips per acre.

Getting up mangolds and filling into carts per acre.

Planting cabbages at 24 inches apart per acre.

Filling and spreading manure at per load.

Thatching at per square.

Washing and shearing sheep at per score.

Cutting and laying a hedge and doing out ditch at per rod.

Trimming hedges at per chain.

Draining 3 feet deep at per chain.

Cost of draining 3 feet deep, 22 feet apart, including tiles, at per acre.

EXAMINATION IN CHEMISTRY.

MAXIMUM NUMBER OF MARKS, 200. PASS NUMBER, 100.

I. GENERAL CHEMISTRY.

*Wednesday, April 24th, from 10 a.m. till 1 p.m.*

1. In what respect does a solution of a salt (say nitre) in water resemble a chemical compound, and in what does it differ from one?
2. Describe the preparation of sulphurous acid gas (1) from sulphur, (2) from sulphuric acid, and explain the chemistry of the processes. Give an account of the chief characters of that gas. How can you distinguish it from hydrochloric acid? What is its action on ferric chloride?
3. Show by a comparison of compounds what other elements are most nearly allied to (1) phosphorus, (2) iodine, (3) manganese.
4. What weight of caustic soda is required to neutralise exactly 210 grains of sulphuric acid? What quantity of bicarbonate of soda will also neutralise that quantity of acid? (C : S : O : N  $\alpha$  = 12 : 32 : 16 : 23.)
5. Describe and explain the artificial preparation of nitre.
6. Describe, and explain the cause of, ebullition. If you want to determine accurately the boiling-point of a liquid such as ether, explain how you would proceed, and give reasons for the precautions you would take.
7. Explain the chemical changes which go on in the alcoholic fermentation. State the circumstances which appear necessary in order to this fermentation. What other kinds of fermentation are there besides the alcoholic, and in what respects do they resemble it?
8. By what tests can you detect (1) iron, (2) aluminum, (3) calcium phosphate, in a solution; separately, and when they are altogether?
9. What is the composition of urea? How can you prove the presence in it of each of the elements you name? What decomposition does it most readily undergo, and under what circumstances?

II. AGRICULTURAL CHEMISTRY.

*Wednesday, April 24th, from 2 p.m. till 5 p.m.*

1. Compare the composition of light sandy soils with that of heavy clay soils, and show in what manner the chemical and physical characters of light and heavy soils affect their cultivation.

2. What do you understand by permanent and temporary fertility of land? What are the reasons that alluvial soils are generally very fertile?

3. Point out some of the peculiarities of land newly reclaimed from the sea and the treatment of land accidentally flooded by sea-water.

4. Write a short paper on the assimilation of nitrogen by plants.

5. State in general terms the composition of Peruvian guano and of nitrate of soda, compare their value and proper use in agriculture.

6. Good farmyard-manure on an average contains  $\frac{3}{4}$  per cent. of nitrogen. How much nitrate of soda, or how much sulphate of ammonia, must you use to obtain the same quantity of nitrogen which is contained in 20 tons of farmyard-manure?

7. How can you detect the presence of arsenic, copper, and mercury in the stomach of an animal, suspected to have been poisoned by one or the other of these metallic poisons?

8. Mention the composition, preparation, and properties of carbolic acid. For what purposes may carbolic acid be usefully employed by agriculturists, and in what form?

9. Describe the chemical changes which have taken place in turning barley into malt. What is the composition of malt-dust and kiln-dust, and their value for feeding and manuring purposes, in comparison with barley and malt?

## EXAMINATION IN MECHANICS AND NATURAL PHILOSOPHY.

MAXIMUM NUMBER OF MARKS, 200. PASS NUMBER, 100.

*Thursday, April 25th, from 10 a.m. till 1 p.m.*

1. What is the centre of gravity of a body? Why cannot a body have more than one centre of gravity?

2. When a body consists of two parts of known weights, and the position of the centre of gravity of each part is known, how can the centre of gravity of the whole be found?

2. What is the construction for finding the resultant of two forces acting on a particle? How is the construction extended to the case of three or more forces?

Draw  $Ox$ ,  $Oy$ , two lines at right angles to each other, and  $OP$  a third line, making angles of  $60^\circ$  and  $30^\circ$  with  $Ox$  and  $Oy$  respectively; forces of 7, 12, and 6 units respectively act on a particle at  $O$  along



O  $x$ , O P, and  $y$  O respectively; find their resultant by construction, or otherwise.

3. A B is a uniform rod or lever, 8 feet long, weighing 10 lbs.; it is capable of turning freely round a hinge at A; it rests in a horizontal position on a point C, distant 2 feet from B; what force is exerted on C and on the hinge at A? What difference will there be in these forces ( $a$ ) when a weight of 10 lbs., ( $b$ ) when a weight of 20 lbs., is hung at B?

4. Given three equal pulleys in separate blocks; describe any one way of combining them into a system for raising a heavy body. In the system described, whatever it may be, what length of rope is required for raising the weight 10 feet; and what power is required to balance a weight of 3 cwt.?

5. It is said that a mill working with 1-horse power can grind a bushel of corn in an hour; a stream has a fall of 10 feet; its cross section is 6 square feet, and its velocity through the section is 3 miles an hour; how many bushels of corn could it be made to grind in eight hours, if the water-wheel by which its power is applied can render useful three-quarters of the work done by the stream (*i. e.*, modulus of wheel is 0.75)?

6. A body thrown vertically upwards passes a point A with a velocity  $v$ , the highest point it reaches is B; give a formula connecting  $v$  with the height A B and the force of gravity.

Show that the kinetic energy or accumulated work which the body had when it passed A, equals the work which gravity would do on the body while it falls from B to A.

7. State the conditions that must be fulfilled when a body floats.

A thin rod of uniform section weighs 2 lbs.; its specific gravity is  $\frac{2}{3}$ ; a weight (which is to be treated as a point) is fastened to one end; what is the smallest value of the weight for which the rod will float vertically?

8. State "Boyle's Law," and describe briefly the experiment by which its truth can be shown.

Is the law exactly or only proximately true?

The barometer stands at 30 inches; the pressure of the air within the receiver of an air-pump is 4 inches; what part of the quantity of air originally within the receiver has been withdrawn?

9. What is the radiation of heat? If a number of things at different temperatures were placed in a room, which was then shut up, why would their temperatures tend to become equal? Mention any circumstance that occurs to you as likely to prevent this tendency from having full effect.

## EXAMINATION IN MENSURATION AND SURVEYING.

MAXIMUM NUMBER OF MARKS, 100. PASS NUMBER, 50.

*Thursday, April 25th, from 2 p.m. till 5 p.m.*

1. State the principal rules for finding the area of a triangle.

Find the area when the sides are 751, 645, 604 feet long respectively.

2. The sewage of a household of six people can be disposed of on an area of 100 feet by 10 feet; at the same rate how many acres of ground would be needed for a like purpose in the case of a small town with a population of 2500 people?

3. State a rule, or write down a formula for determining the volume of a sphere in terms of its radius.

A ball 4 inches in diameter weighs  $8\frac{1}{2}$  lbs.; what will be the weight of a ball of the same material 7 inches in diameter?

4. A heap of earth or stones is made on level ground; the top is a rectangle, 20 feet long by 10 feet wide; the base is also a rectangle 24 feet long by 14 feet wide; the slope of the sides is uniform all round, and the heap is 3 feet in vertical height; how many cubic yards of stones or earth are there?

5. Explain how a knowledge of the specific gravity of a substance can be used for the approximate determination of the volume of a known weight of the substance.

What is the volume of 18 tons 15 cwt. of granite, the specific gravity of which is 2.625?

6. A wood is enclosed by four straight boundary lines; you are not allowed to cross the wood in any direction, nor can you see through it; you are provided with nothing but a measuring-tape and pickets; how would you obtain data for drawing a correct plan of the boundary?

7. Explain briefly the principle of the vernier, and show how it is applied in the following cases:—

(a) A line is divided into 10ths of an inch, and with the help of the vernier the observer is to be enabled to read to 100ths of an inch.

(b) An arc is graduated to half-degrees, and with the aid of the vernier the observer is to be enabled to read to minutes.

8. A is a point on one side of a river, P is a flagstaff on the opposite side; a base A B of 500 feet is measured, and the angles P A B

and A B P are observed to be  $98^{\circ} 30'$  and  $75^{\circ} 20'$ ; from these data find the distance A P.

9. Plot the accompanying notes; and if the first station is 200 feet above the sea-level, what is the height of the last station above the sea-level?

DISTANCE.	BACK-SIGHT.	FORE-SIGHT.
100	6.28	2.60
100	5.78	3.62
70	7.32	2.20
50	5.00	8.35
80	2.36	9.95
100	3.44	8.29

### EXAMINATION IN BOOK-KEEPING.

MAXIMUM NUMBER OF MARKS, 200. PASS NUMBER, 100.

*Friday, April 26th, from 10 a.m. till 1 p.m.*

Journalise and post into a ledger, in proper technical form and language, the following series of facts and transactions, and, from such ledger, make out a Trial Balance, a Profit and Loss Account, and a Balance Sheet.

*Liabilities and Assets of JOHN CARTER, 1st January, 1878.*

#### LIABILITIES.

	£	s.	d.
Amount due to Peter Lawson .. .. .	560	0	0
Do. Peter Bell, rent due at Christmas, 1877	100	0	0
Do. London and County Bank Loan Account	2000	0	0
Security—3 warrants for wheat at Victoria Docks, value 2500 <i>l.</i>			
Acceptance due 18th January .. .. .	98	7	6
Do. February .. .. .	101	12	6
	<u>£2860</u>	<u>0</u>	<u>0</u>

#### ASSETS.

Stock of Wheat .. .. .	3000	0	0
Bill receivable, due 28th January .. .. .	1250	0	0
Due from Philip James .. .. .	250	0	0
Cash at London and County Bank, Current Account	1550	17	9
Petty Cash in hand .. .. .	26	2	3
	<u>£6077</u>	<u>0</u>	<u>0</u>

		£	s.	d.
1878.				
Jan.	1. Bought of Peter Lawson, Wheat .. ..	500	0	0
"	" Paid Peter Lawson .. .. ..	460	0	0
"	" Sold to Philip James, Wheat .. ..	1100	0	0
"	3. Accepted Peter Lawson's Draft, due 4th of July, 1878 .. .. ..	615	0	0
"	" Interest charged by Lawson .. .. ..	15	0	0
"	5. Received Philip James's Acceptance, 4th March .. .. ..	1000	0	0
"	8. Discounted with the London and County Bank, Bill due 28th January £1250 0 0 Do. 4th March ..	1000	0	0
		2250	0	0
"	" Discount charged by Bank .. .. ..	10	12	7
"	" Paid off Loan Account at London and County Bank .. .. ..	2000	0	0
"	" Interest charged by Bank .. .. ..	2	4	0
"	10. Received Warrants for Wheat from London and County Bank .. .. ..			
"	15. Sold Peter Smith, Wheat .. .. ..	250	0	0
"	16. Paid Peter Bell .. .. ..	100	0	0
"	18. Paid Acceptance due this day .. .. ..	98	7	6
"	20. Received from Peter Smith, Bill on Barings', due 4th July .. .. ..	253	10	0
	Charged Peter Smith, Interest .. .. ..	3	10	0
"	25. Bought of Peter Lawson, Wheat .. .. ..	600	0	0
"	28. Bill due this day, returned by Bank unpaid	1250	0	0
"	" Drew from Bank for private use .. .. ..	75	0	0
"	" Paid out of Petty Cash— Dock Charges on Wheat .. .. ..	13	6	8
"	" Discounted at London and County Bank, Bill due 4th July .. .. ..	253	10	0
"	" Discount charged by Bank .. .. ..	2	5	0
"	31. Advanced out of Bank to Petty Cash .. ..	20	0	0
"	" Paid John Jones one month's salary .. ..	12	10	0
"	" Paid Insurance on Wheat .. .. ..	15	15	0
"	" Stock of Wheat on hand this day .. ..	3000	0	0

EXAMINATION IN GEOLOGY.

MAXIMUM NUMBER OF MARKS, 100. PASS NUMBER, 50.

*Friday, April 26th, from 2 p.m. till 5 p.m.*

1. Name the chief divisions of rocks which constitute the crust of the earth, and give their distinguishing characters.
2. Define and explain the origin of schist, slate, flagstone, and shale.
3. Explain the different geological conditions favourable for the origin of springs.
4. Describe the effects of rain and frost as agents in the weathering of rocks.
5. Name the characteristic fossils of the three great divisions of stratified rocks.
6. What are the distinctive features of the carboniferous flora? Arrange the chief genera under their respective classes.
7. State the geological position of the principal mineral fertilisers found in England.
8. Tabulate the divisions of the cretaceous rocks, mention their lithological characters, and the nature of the soils derived from them.
9. What is the geological position of the following deposits:—Alum shale, Fuller's earth, Collyweston slate, Petworth marble, Kentish ragstone, and the gypsum of Derbyshire?
10. Explain the differences between the soils on the chalk downs (north or south) and those in the adjacent valleys.

---

EXAMINATION IN BOTANY.

[It is expected that Eight Questions at least will be answered.]

MAXIMUM NUMBER OF MARKS, 100. PASS NUMBER, 50.

*Saturday, April 27th, from 10 a.m. till 1 p.m.*

1. Name, describe, and give samples of the principal modifications of leaves, excluding those connected with the flower.
2. Give the reasons for applying the term frond to some leaves, and specify the groups of plants which have fronds.
3. What is duramen, albumum, and bast tissue?
4. What is cellulose, starch, sugar, and chlorophyll?

5. Explain the meanings of ovary, ovule, embryo sac, embryo and seed, and state in what group or groups of plants these organs are present.

6. By what organs in the plant, and in what way are manures appropriated?

7. Has the barberry any connection with the disease of smut in wheat? and if so, what connection?

8. Give the principal characters of the Natural Order Cruciferae, and specify the plants of this Order, grown by agriculturists.

9. Give the technical names and natural orders of the dodder, lint, potato, onion, and nettle.

10. Name and describe, in systematic language, the plants A, B, and C.

---

## EXAMINATION IN ANATOMY AND ANIMAL PHYSIOLOGY.

MAXIMUM NUMBER OF MARKS, 100. PASS NUMBER, 50.

*Saturday, April 27th, from 2 p.m. till 5 p.m.*

1. Name the bones of the hind extremity of the ox, in their regular order, commencing from above; and point out the principal differences which exist in each when compared with the corresponding bone of the horse.

2. Give a brief description of the development and growth of a long bone and a flat bone.

3. Describe the differences which exist in the bones of the head in horned and polled oxen.

4. State the several uses which bones serve in the animal body, and the manner in which they are nourished.

5. What are cartilages? Describe their varieties, and the structural differences between them and tendons.

6. What are ligaments? Name their several uses, and state whether their structure in all cases is the same.

7. What are muscles? Are all the muscles of the body of the same kind? If not, give a familiar example of each.

---

---



## MEMORANDA.

**ADDRESS OF LETTERS.**—The Society's office being situated in the postal district designated by the letter *W*, Members, in their correspondence with the Secretary, are requested to subjoin that letter to the usual address.

**GENERAL MEETING** in London, December, 1878.

**GENERAL MEETING** in London, May 22, 1879, at 12 o'clock.

**METROPOLITAN MEETING** at Kilburn, July 1879.

**MONTHLY COUNCIL** (for transaction of business), at 12 o'clock on the first Wednesday in every month, excepting January, September, and October: open only to Members of Council and Governors of the Society.

**ADJOURNMENTS.**—The Council adjourn over Passion and Easter weeks, when those weeks do not include the first Wednesday of the month; from the first Wednesday in August to the first Wednesday in November; and from the first Wednesday in December to the first Wednesday in February.

**OFFICE HOURS.**—10 to 4. On Saturdays, 10 to 2.

**DISEASES of Cattle, Sheep, and Pigs.**—Members have the privilege of applying to the Veterinary Committee of the Society, and of sending animals to the Brown Institution, Wandsworth Road, S.W.—(A statement of these privileges will be found on page civ.)

**CHEMICAL ANALYSIS.**—The privileges of Chemical Analysis enjoyed by Members of the Society will be found stated in this Appendix (page cv.)

**BOTANICAL PRIVILEGES.**—The Botanical and Entomological Privileges enjoyed by Members of the Society will be found stated in this Appendix (page cvii).

**SUBSCRIPTIONS.**—1. Annual.—The subscription of a Governor is £5, and that of a Member £1, due in advance on the 1st of January of each year, and becoming in arrear if unpaid by the 1st of June. 2. For Life.—Governors may compound for their subscription for future years by paying at once the sum of £50, and Members by paying £10. Governors and Members who have paid their annual subscription for 20 years or upwards, and whose subscriptions are not in arrear, may compound for future annual subscriptions, that of the current year inclusive, by a single payment of £25 for a Governor, and £5 for a Member.

**PAYMENTS.**—Subscriptions may be paid to the Secretary, in the most direct and satisfactory manner, either at the Office of the Society, No. 12, Hanover Square, London, W., or by means of post-office orders, to be obtained at any of the principal post-offices throughout the kingdom, and made payable to him at the Vere Street Office, London, W.; but any cheque on a banker's or any other house of business in London will be equally available, if made payable on demand. In obtaining post-office orders care should be taken to give the postmaster the correct initials and surname of the Secretary of the Society (H. M. Jenkins), otherwise the payment will be refused to him at the post-office on which such order has been obtained; and when remitting the money-orders it should be stated by whom, and on whose account, they are sent. Cheques should be made payable as drafts on demand (not as bills only payable after sight or a certain number of days after date), and should be drawn on a London (not on a local country) banker. When payment is made to the London and Westminster Bank, St. James's Square Branch, as the bankers of the Society, it will be desirable that the Secretary should be advised by letter of such payment, in order that the entry in the banker's book may be at once identified, and the amount posted to the credit of the proper party. No coin can be remitted by post, unless the letter be registered.

**NEW MEMBERS.**—Every candidate for admission into the Society must be proposed by a Member; the proposer to specify in writing the full name, usual place of residence, and post-town, of the candidate, either at a Council meeting, or by letter addressed to the Secretary. Forms of Proposal may be obtained on application to the Secretary.

---

\*.\* Members may obtain on application to the Secretary copies of an Abstract of the Charter and Bye-laws, of a Statement of the General Objects, &c., of the Society, of Chemical, Botanical, and Veterinary Privileges, and of other printed papers connected with special departments of the Society's business.

## Members' Veterinary Privileges.

### I.—SERIOUS OR EXTENSIVE DISEASES.

No. 1. Any Member of the Society who may desire professional attendance and special advice in cases of serious or extensive disease among his cattle, sheep, or pigs, and will address a letter to the Secretary, will, by return of post, receive a reply stating whether it be considered necessary that the Society's Veterinary Inspector should visit the place where the disease prevails.

No. 2. The remuneration of the Inspector will be 2*l.* 2*s.* each day as a professional fee, and 1*l.* 1*s.* each day for personal expenses; and he will also be allowed to charge the cost of travelling to and from the locality where his services may have been required. The fees will be paid by the Society, but the travelling expenses will be a charge against the applicant. This charge may, however, be reduced or remitted altogether at the discretion of the Council, on such step being recommended to them by the Veterinary Committee.

No. 3. The Inspector, on his return from visiting the diseased stock, will report to the Committee, in writing, the results of his observations and proceedings, which Report will be laid before the Council.

No. 4. When contingencies arise to prevent a personal discharge of the duties confided to the Inspector, he may, subject to the approval of the Committee, name some competent professional person to act in his stead, who shall receive the same rates of remuneration.

### II.—ORDINARY OR OTHER CASES OF DISEASE.

Members may obtain the attendance of the Veterinary Inspector on any case of disease by paying the cost of his visit, which will be at the following rate, viz., 2*l.* 2*s.* per diem, and travelling expenses. Applications should be addressed to the Superintendent of the Brown Institution, care of the Secretary of the Royal Agricultural Society, 12, Hanover Square, London, W.

### III.—CONSULTATIONS WITHOUT VISIT.

Personal consultation with Veterinary Inspector	..	..	5 <i>s.</i>
Consultation by letter	..	..	5 <i>s.</i>
Consultation necessitating the writing of three or more letters			10 <i>s.</i>
Post-mortem examination, and report thereon	..	..	10 <i>s.</i>

A return of the number of applications from Members of the Society during each half-year is required from the Veterinary Inspector.

### IV.—ADMISSION OF DISEASED ANIMALS TO THE BROWN INSTITUTION, WANDSWORTH ROAD, LONDON, S.W.; INVESTIGATIONS, LECTURES, AND REPORTS.

No. 1. All Members of the Society have the privilege of sending cattle, sheep, and pigs to the Infirmary of the Brown Institution, on the following terms; viz., by paying for the keep and treatment of cattle 10*s.* 6*d.* per week each animal, and for sheep and pigs "a small proportionate charge to be fixed by the Professor-Superintendent according to circumstances."

No. 2. The Professor-Superintendent of the Institution has also undertaken to carry out such investigations relating to the nature, treatment, and prevention of diseases of cattle, sheep, and pigs, as may be deemed expedient by the Council.

No. 3. A detailed Report of the cases of cattle, sheep, and pigs treated in the Infirmary of the Institution, or on Farms in the occupation of Members of the Society, will be furnished to the Council quarterly; and also special reports from time to time on any matter of unusual interest which may come under the notice of the Institution.

By Order of the Council,  
H. M. JENKINS, *Secretary.*

## Members' Privileges of Chemical Analysis

THE Council have fixed the following rates of Charges for Analyses to be made by the Consulting Chemist for the *bonâ fide* use of Members of the Society; who, to avoid all unnecessary correspondence, are particularly requested, when applying to him, to mention the kind of analysis they require, and to quote its number in the subjoined schedule. The charge for analysis, together with the carriage of the specimens, must be paid to him by Members at the time of their application.

No. 1.—An opinion of the genuineness of Peruvian guano, bone-dust, or oil-cake (each sample) .. .. .	5s.
„ 2.—An analysis of guano; showing the proportion of moisture, organic matter, sand, phosphate of lime, alkaline salts and ammonia .. .. .	10s.
„ 3.—An estimate of the value (relatively to the average samples in the market) of sulphate and muriate of ammonia, and of the nitrates of potash and soda .. .. .	10s.
„ 4.—An analysis of superphosphate of lime for soluble phosphates only .. .. .	10s.
„ 5.—An analysis of superphosphate of lime, showing the proportions of moisture, organic matter, sand, soluble and insoluble phosphates, sulphate of lime, and ammonia ..	£1.
„ 6.—An analysis (sufficient for the determination of its agricultural value) of an ordinary artificial manure .. .. .	£1.
„ 7.—Limestone:—the proportion of lime, 7s. 6d.; the proportion of magnesia, 10s.; the proportion of lime and magnesia .. .. .	15s.
„ 8.—Limestone or marls, including carbonate, phosphate, and sulphate of lime and magnesia, with sand and clay ..	£1.
„ 9.—Partial analysis of a soil, including determinations of clay, sand, organic matter, and carbonate of lime .. .. .	£1.
„ 10.—Complete analysis of a soil .. .. .	£3.
„ 11.—An analysis of oil-cake or other substance used for feeding purposes; showing the proportion of moisture, oil, mineral matter, albuminous matter, and woody fibre; as well as of starch, gum, and sugar, in the aggregate ..	£1.
„ 12.—Analysis of any vegetable product .. .. .	£1.
„ 13.—Analysis of animal products, refuse substances used for manure, &c. .. .. . from 10s. to 30s.	
„ 14.—Determination of the “hardness” of a sample of water before and after boiling .. .. .	10s.
„ 15.—Analysis of water of land drainage, and of water used for irrigation .. .. .	£2.
„ 16.—Determination of nitric acid in a sample of water .. .. .	£1.

N.B.—*The above Scale of Charges is not applicable to the case of persons commercially engaged in the Manufacture or Sale of any Substance sent for Analysis.*

The Address of the Consulting Chemist of the Society is, Dr. AUGUSTUS VOELCKER, F.R.S., 11, Salisbury Square, Fleet Street, London, E.C., to which he requests that all letters and parcels (Postage and Carriage paid) should be directed.

By Order of the Council,

H. M. JENKINS, *Secretary.*

## INSTRUCTIONS FOR SELECTING AND SENDING SAMPLES FOR ANALYSIS.

**ARTIFICIAL MANURES.**—Take a large handful of the manure from three or four bags, mix the whole on a large sheet of paper, breaking down with the hand any lumps present, and fold up in tinfoil, or in oil silk, about 3 oz. of the well-mixed sample, and send it to 11, SALISBURY SQUARE, FLEET STREET, E.C., by post: or place the mixed manure in a small wooden or tin box, which may be tied by string, but must not be sealed, and send it by post. If the manure be very wet and lumpy, a larger boxful, weighing from 10 to 12 oz., should be sent either by post or railway.

Samples not exceeding 4 oz. in weight may be sent by post, by attaching two penny postage stamps to the parcel.

Samples not exceeding 8 oz., for three postage stamps.

Samples not exceeding 12 oz., for four postage stamps.

The parcels should be addressed: DR. AUGUSTUS VOELCKER, 11, SALISBURY SQUARE, FLEET STREET, LONDON, E.C., and the address of the sender or the number or mark of the article be stated on parcels.

The samples may be sent in covers, or in boxes, bags of linen or other materials. No parcel sent by post must exceed 12 oz. in weight, 1 foot 6 inches in length, 9 inches in width, and 6 inches in depth.

**SOILS.**—Have a wooden box made 6 inches long and wide, and from 9 to 12 inches deep, according to the depth of soil and subsoil of the field. Mark out in the field a space of about 12 inches square; dig round in a slanting direction a trench, so as to leave undisturbed a block of soil with its subsoil from 9 to 12 inches deep; trim this block or plan of the field to make it fit into the wooden box, invert the open box over it, press down firmly, then pass a spade under the box and lift it up, gently turn over the box, nail on the lid and send it by goods or parcel to the laboratory. The soil will then be received in the exact position in which it is found in the field.

In the case of very light, sandy, and porous soils, the wooden box may be at once inverted over the soil and forced down by pressure, and then dug out.

**WATERS.**—Two gallons of water are required for analysis. The water, if possible, should be sent in glass-stoppered Winchester half-gallon bottles, which are readily obtained in any chemist and druggist's shop. If Winchester bottles cannot be procured, the water may be sent in perfectly clean new stoneware spirit-jars surrounded by wickerwork. For the determination of the degree of hardness before and after boiling, only one quart wine-bottle full of water is required.

**LIMESTONES, MARLS, IRONSTONES, AND OTHER MINERALS.**—Whole pieces, weighing from 3 to 4 oz., should be sent enclosed in small linen bags, or wrapped in paper. Postage 2*d.*, if under 4 oz.

**OILCAKES.**—Take a sample from the middle of the cake. To this end break a whole cake into two. Then break off a piece from the end where the two halves were joined together, and wrap it in paper, leaving the ends open, and send parcel by post. The piece should weigh from 10 to 12 oz. Postage, 4*d.* If sent by railway, one quarter or half a cake should be forwarded.

**FEEDING MEALS.**—About 3 oz. will be sufficient for analysis. Enclose the meal in a small linen bag. Send it by post.

On forwarding samples, separate letters should be sent to the laboratory, specifying the nature of the information required, and, if possible, the object in view.

H. M. JENKINS, *Secretary.*

## Members' Botanical and Entomological Privileges.

The Council have fixed the following Rates of Charge for the examination of Plants, Seeds, and Insects for the *bonâ fide* use of Members of the Society, who are particularly requested, when applying to the Consulting Botanist, to mention the kind of examination they require, and to quote its number in the subjoined Schedule. The charge for examination must be paid to the Consulting Botanist at the time of application, and the carriage of all parcels must be prepaid.

### I. BOTANICAL.

- |   |      |
|---|------|
| No. 1.—A report on the purity, amount and nature of foreign materials, perfectness, and germinating power of a sample of seeds .. .. .  | 5s.  |
| ,, 2.—Detailed report on the weight, purity, perfectness, and germinating power of a sample of seeds, with a special description of the weeds and other foreign materials contained in it .. .. . | 10s. |
| ,, 3.—Determination of the species of any weed or other plant, or of any epiphyte or vegetable parasite, with a report on its habits, and the means of its extermination or prevention .. .. .    | 5s.  |
| ,, 4.—Report on any disease affecting the farm crop .. .. .   | 5s.  |
| ,, 5.—Determination of the species of a collection of natural grasses found in any district on one kind of soil, with a report on their habits and pasture value .. .. .                          | 10s. |

### II. ENTOMOLOGICAL.

- |  |     |
|--|-----|
| ,, 6.—Determination of the species of any insect, worm, or other animal which, in any stage of its life, injuriously affects the farm crops, with a report on its habits and suggestions as to its extermination .. .. . | 5s. |
|--|-----|

### INSTRUCTIONS FOR SELECTING AND SENDING SAMPLES.

In sending seed or corn for examination the utmost care must be taken to secure a fair and honest sample. If anything supposed to be injurious or useless exists in the corn or seed, selected samples should also be sent.

In collecting specimens of plants, the whole plant should be taken up, and the earth shaken from the roots. If possible, the plant must be in flower or fruit. They should be packed in a light box, or in a firm paper parcel.

Specimens of diseased plants or of parasites should be forwarded as fresh as possible. Place them in a bottle, or pack them in tin-foil or oil-silk.

All specimens should be accompanied with a letter specifying the nature of the information required, and stating any local circumstances (soil, situation, &c.) which, in the opinion of the sender, would be likely to throw light on the inquiry.

N.B.—*The above Scale of Charges is not applicable in the case of Seedsmen requiring the services of the Consulting Botanist.*

Parcels or letters (Carriage or Postage prepaid) to be addressed to Mr. W. CARRUTHERS, F.R.S., 4, Woodside Villas, Gipsy Hill, London, S.E.

H. M. JENKINS, *Secretary.*

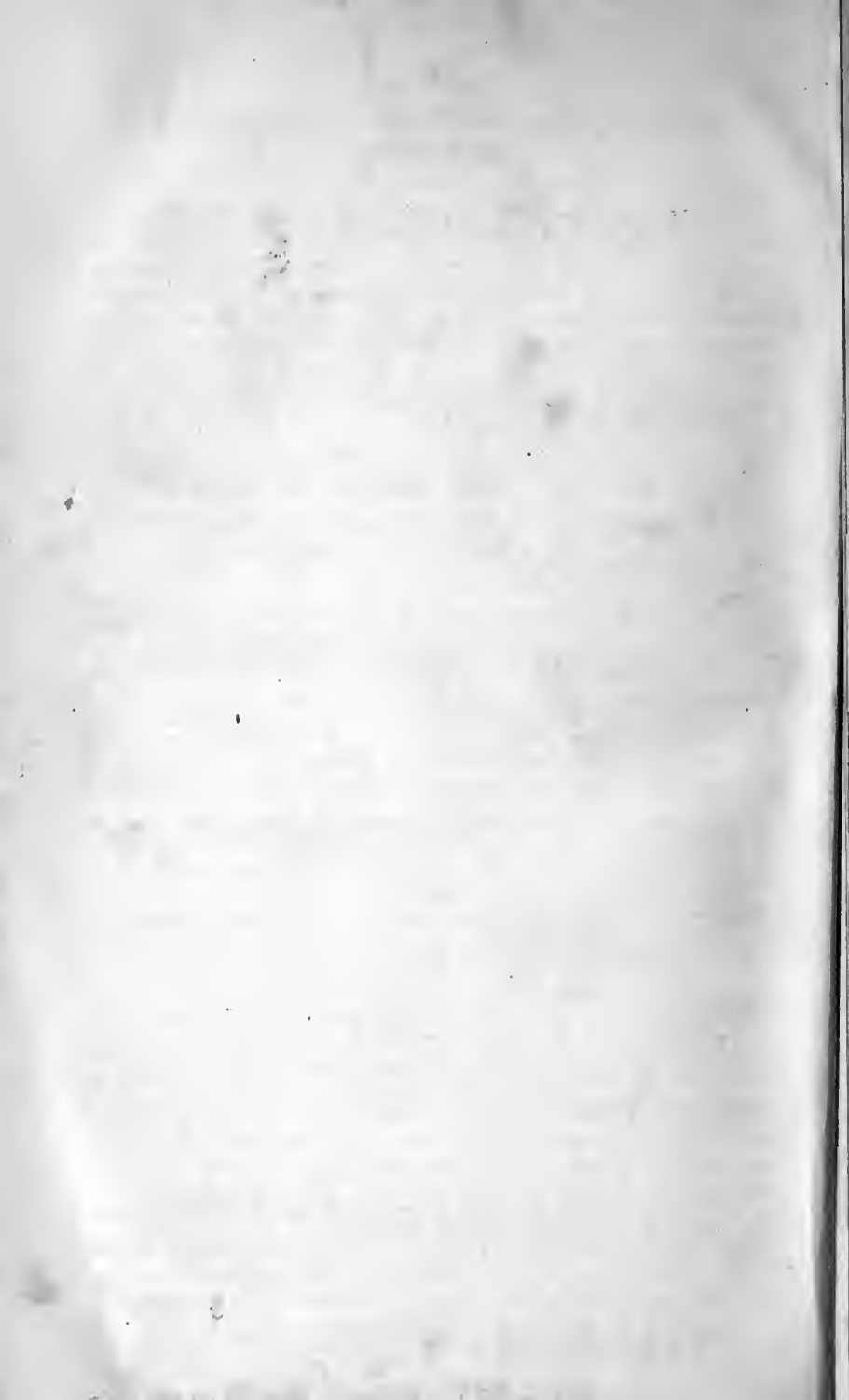



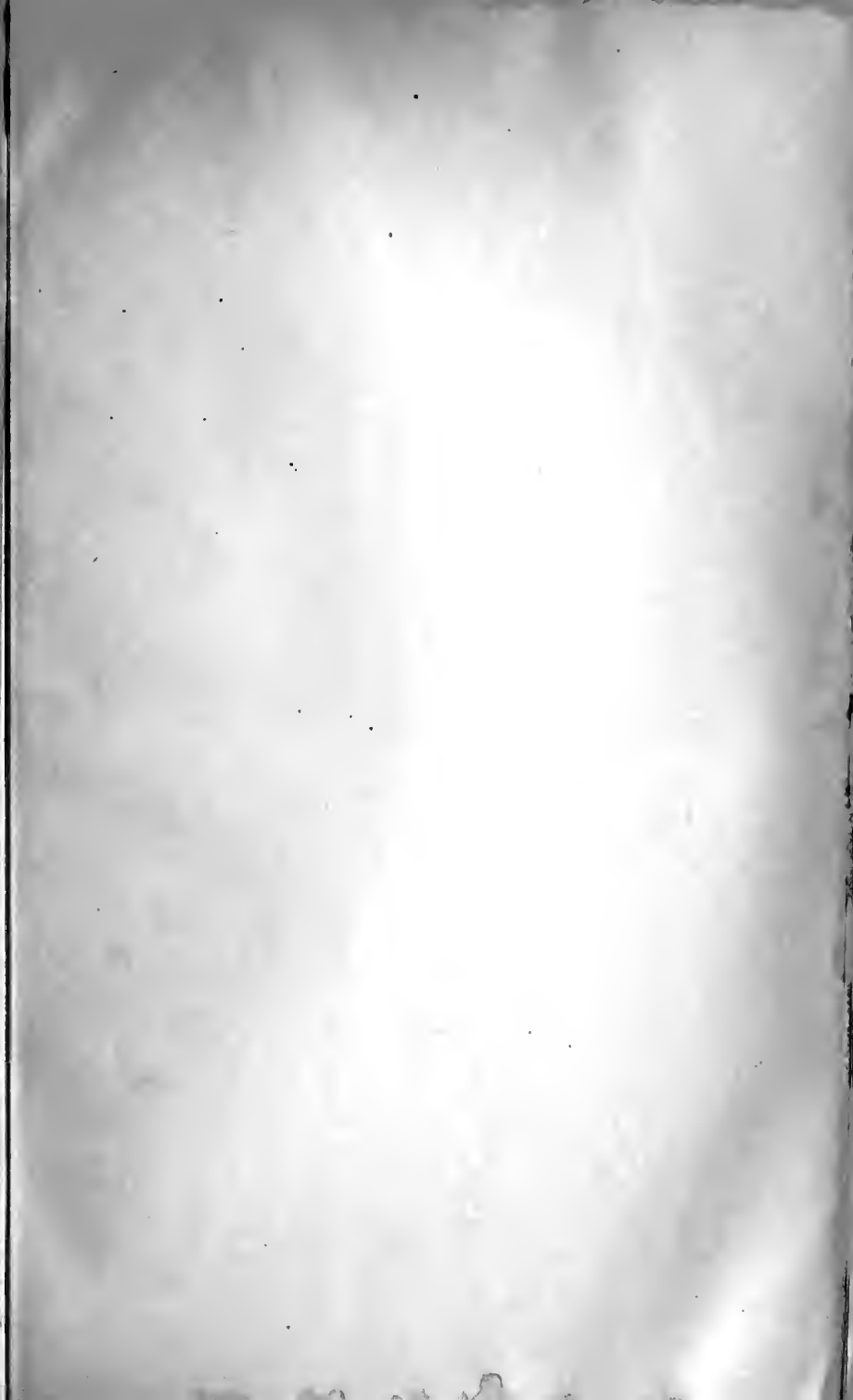





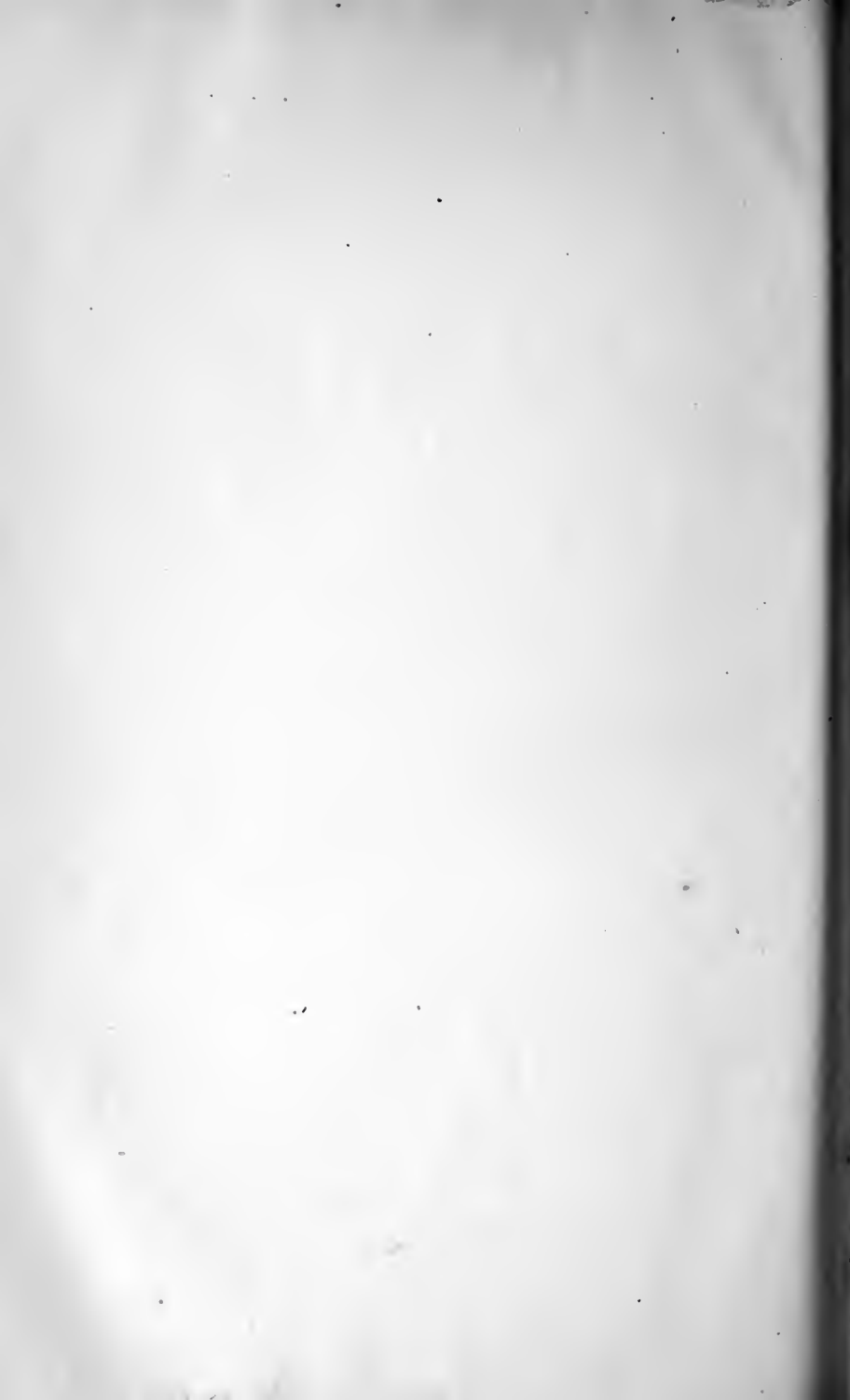

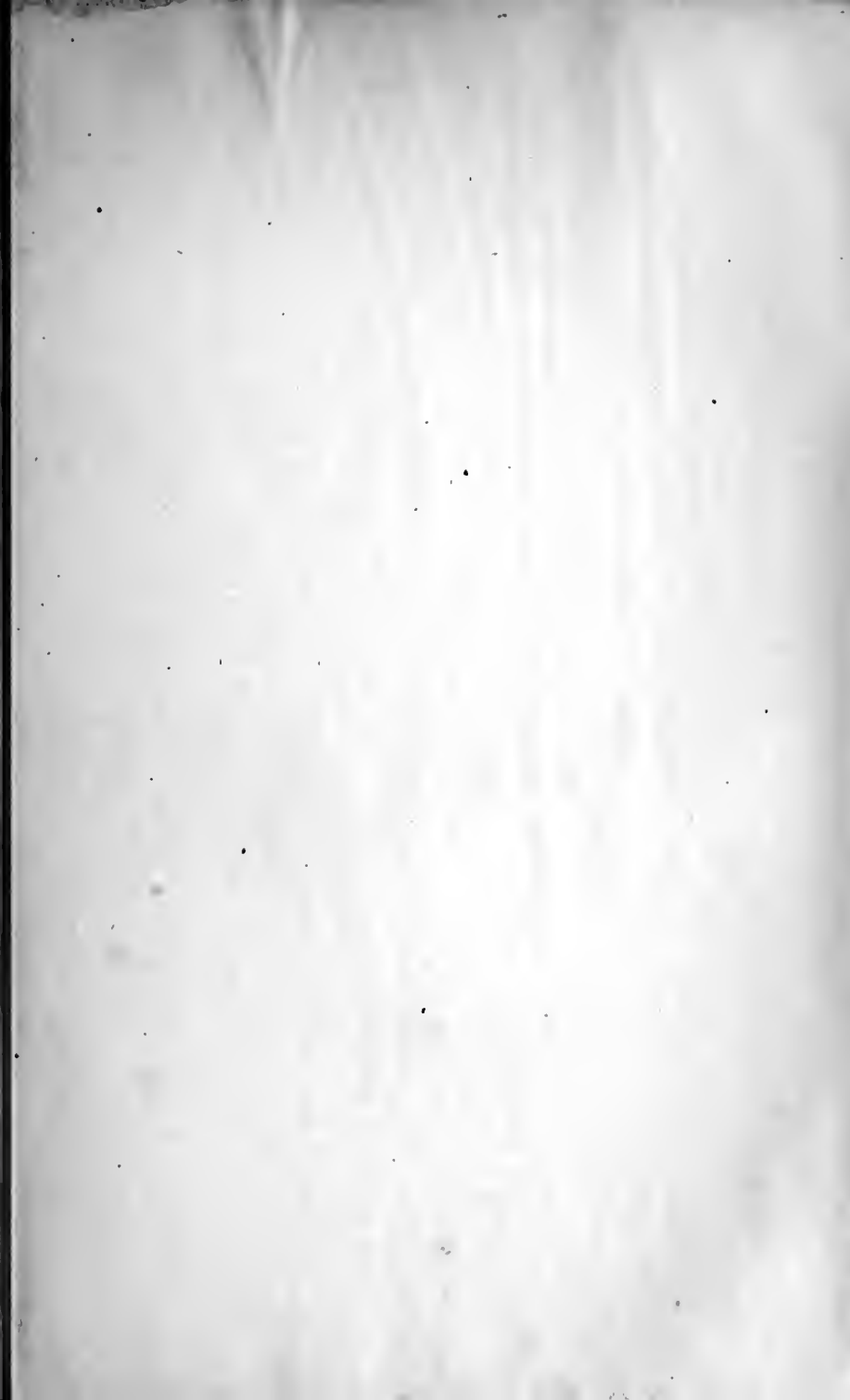





New York Botanical Garden Library



3 5185 00257 6476

