





THE  
JOURNAL  
OF THE  
ROYAL AGRICULTURAL SOCIETY  
OF ENGLAND.

SECOND SERIES.

VOLUME THE SECOND.

---

PRACTICE WITH SCIENCE.

---

LONDON:  
JOHN MURRAY, ALBEMARLE STREET.

1866.



XJ  
18933  
1012  
2nd Series

THESE EXPERIMENTS, IT IS TRUE, ARE NOT EASY; STILL THEY ARE IN THE POWER OF EVERY THINKING HUSBANDMAN. HE WHO ACCOMPLISHES BUT ONE, OF HOWEVER LIMITED APPLICATION, AND TAKES CARE TO REPORT IT FAITHFULLY, ADVANCES THE SCIENCE, AND, CONSEQUENTLY, THE PRACTICE OF AGRICULTURE, AND ACQUIRES THEREBY A RIGHT TO THE GRATITUDE OF HIS FELLOWS, AND OF THOSE WHO COME AFTER. TO MAKE MANY SUCH IS BEYOND THE POWER OF MOST INDIVIDUALS, AND CANNOT BE EXPECTED. THE FIRST CARE OF ALL SOCIETIES FORMED FOR THE IMPROVEMENT OF OUR SCIENCE SHOULD BE TO PREPARE THE FORMS OF SUCH EXPERIMENTS, AND TO DISTRIBUTE THE EXECUTION OF THESE AMONG THEIR MEMBERS.

VON THAER, *Principles of Agriculture.*

# CONTENTS OF VOL. II.

## SECOND SERIES.

STATISTICS :—	PAGE
Vital Statistics for the six months ending December 31, 1865	I
Meteorology ditto ditto ..	III, VI
Price of Provisions—Pauperism ditto ..	V, VIII
Imports of Corn, &c. ditto ditto ..	VIII
British Wheat sold, and Average Prices .. .. .	IX, X
Certain Articles of Foreign and Colonial Production imported in the three years 1863-65; and their quantities ..	X
Vital Statistics for the six months ending June 30, 1866 ..	XI
Emigration ditto ditto ..	XI
Meteorology ditto ditto ..	XIV-XVII
Prices of Provisions—Pauperism ditto ..	XVIII
British Wheat Sold, and Average Prices .. .. .	XIX
Imports of Corn and other Produce .. .. .	XX

ARTICLE	PAGE
I.—On Middle-Class Education, having reference to the Improvement of the Education of those who depend upon the Cultivation of the Soil for their Support. By R. Vallentine. Prize Essay .. .. .	1
II.—Middle-Class Education, with special reference to our Grammar Schools. By the Rev. Lewis Evans .. .. .	19
III.—Middle-Class Education, having reference to the Improvement of the Education of those who depend upon the Cultivation of the Soil for their Support. By Rev. W. H. Beever, M.A.	29
IV.—The Management of Cattle. By William Little. Prize Essay	45
V.—On Cross-Breeding Cattle. By G. Murray .. .. .	52
VI.—On Rainfall, Natural Drainage, and Subterranean Water Storage. By Professor D. T. Ansted, M.A., F.R.S., &c. ..	62
VII.—The Poultry of France. (From materials furnished by the 'Journal d'Agriculture Pratique.') By P. H. Frere .. .. .	79
VIII.—On Disinfectants: with a Report of further Experiments, &c. By Dr. A. Voelcker .. .. .	93
IX.—On the Management of Ponds and Wells. By R. Orlebar ..	107
X.—On the Comparative Cheapness and Advantages of Iron and Wood in the Construction of Roofs for Farm-Buildings. By Arthur Bailey Denton (Junior). Prize Essay .. .. .	116
XI.—On the Comparative Cheapness and Advantages of Iron and Wood in the Construction of Roofs for Farm-Buildings. By Philip D. Tuckett, Land Agent and Surveyor .. .. .	140
XII.—Rural Economy of the Netherlands; Report read to Academy of Moral and Political Science. Translated by H. Evershed	148
XIII.—On Anthyllis Vulneraria (Lady's Fingers) as a Fodder Plant. By James Buckman, F.L.S., F.G.S., &c. .. .. .	161
XIV.—On the Cultivation of Flax in Belgium. Report by R. Percy Ffrench, Second Secretary to H.B.M.'s Legation at Brussels	168
XV.—Professor Voelcker's Annual Report .. .. .	180
XVI.—Upon the Nature of Diseases in Plants. By Baron Liebig ..	187
XVII.—Statistics of Live Stock and Dead Meat for Consumption in the Metropolis: with Letter on arrangements for Meat-Markets. By Robert Herbert .. .. .	195
XVIII.—On the Composition of Orange Globe Mangolds, Bulbs and Tops. By Augustus Voelcker .. .. .	201

MAY 17 1915

ARTICLE.	PAGE
XIX.—Summary of the Proceedings of the Royal Agricultural Society of England in reference to Agricultural Education. By S. Benj. L. Druce, Hon. Secretary of the Committee .. .. .	209
XX.—Experiments with Artificial Manure as Top-dressing, used at Wonston Manor Farm, Hants. By W. J. Moreton Pocock	226
XXI.—The Cattle-Plague. By Howard Reed .. .. .	230
XXII.—A Report on the Farming of Leicestershire. By W. J. Moscrop. Prize Essay .. .. .	289
XXIII.—On Increasing our Home Production of Poultry. By John Algernon Clarke .. .. .	338
XXIV.—Mountain Breeds of Sheep. By Henry H. Dixon. Prize Essay	360
XXV.—Report of the Improvement of Grass-land on the Manor Farm, Braydon, Wilts. By Dr. A. Voelcker and Professor Coleman	377
XXVI.—On Agricultural Statistics and the Cattle Census. By J. Lewis	393
XXVII.—The Improvement of Waste Lands connected with Mines. By W. Little. Prize Essay .. .. .	430
XXVIII.—The Supply of Meat to Large Towns. By Robert Herbert ..	440
XXIX.—On Clovers. By James Buckman, F.L.S., F.G.S., &c. ..	446
XXX.—General Cattle Mutual Insurance Fund. By W. Farr, F.R.S.	455
XXXI.—Field Experiments on Clover-Seeds. By Dr. Augustus Voelcker	472
XXXII.—Statistics of Live-Stock and Dead Meat for Consumption in the Metropolis. By Robert Herbert .. .. .	491
 ABSTRACT REPORT OF AGRICULTURAL DISCUSSIONS :	
The Cattle Plague. A Lecture by Professor Simonds .. .. .	270
The Present State of the Cattle-Plague and the Practical Working of the "Cattle Diseases Prevention Act, 1866." By Earl Cathcart .. .. .	496
The Conditions to be observed in carrying out Agricultural Experiments in the Field. By Dr. Voelcker .. .. .	513
The Supply of Meat to Large Towns. By R. Herbert .. .. .	526
Insurance of Live Stock. By W. Farr .. .. .	534
Sheep <i>versus</i> Cattle. By W. Torr .. .. .	549

## APPENDIX.

	PAGE
List of Officers of the Royal Agricultural Society of England, 1866	i, xvii
Standing Committees for 1866 .. .. .	iii, xix
Memoranda of Meetings, Payment of Subscription, &c. .. .. .	vi, xxi
Reports of the Council to the General Meeting, December 13, 1865; and May 22, 1866 .. .. .	vii, xxii
Yearly Cash Account, from 1st January to December 31, 1865 .. ..	xi
Cash Accounts and Balance-sheets, from 1st July to Dec. 31, 1865; and from Jan. 1 to June 30, 1866 .. .. .	xii, xxviii
Country Meeting Account, Plymouth, 1865 .. .. .	xiv
Prizes offered in connection with Cambridge Local Examination, Dec., 1866	xxx
Essays and Reports.—Awards for 1865–1866; and Prizes for 1867	xxxiii–xxxvi
Members' Chemical Analysis and Veterinary Privileges	xv, xvi, xxxvii, xxxviii

## DIRECTIONS TO THE BINDER.

The Binder is desired to collect together all the Appendix matter, with Roman numeral folios, and place it at the *end* of each volume of the Journal, excepting Titles and Contents, and Statistics, &c., which are in all cases to be placed at the *beginning* of the Volume: the lettering at the back to include a statement of the *year* as well as the *volume*; the first volume belonging to 1839-40, the second to 1841, the third to 1842, the fourth to 1843, and so on.

In reprints of the Journal, all Appendix matter (and in one instance an Article in the body of the Journal), which at the time had become obsolete, were omitted; the Roman numeral folios, however (for convenience of reference) were reprinted without alteration in the Appendix matter retained.

# CONTENTS OF PART I., VOL. II.

## SECOND SERIES.

### STATISTICS :—

	PAGE
Vital Statistics for the six months ending December 31, 1865	I
Meteorology ditto ditto ..	III, VI
Price of Provisions ditto ditto ..	V, VIII
Pauperism .. .. .	V, VIII
Imports of Corn, &c. ditto ditto ..	VIII
British Wheat sold, and Average Prices .. .. .	IX, X
Certain Articles of Foreign and Colonial Production imported in the three years 1863-65; and their quantities .. ..	X

### ARTICLE

### PAGE

I.—On Middle-Class Education, having reference to the Improvement of the Education of those who depend upon the Cultivation of the Soil for their Support. By R. Vallentine. Prize Essay .. .. .	1
II.—Middle-Class Education, with special reference to our Grammar Schools. By the Rev. Lewis Evans .. .. .	19
III.—Middle-Class Education, having reference to the Improvement of the Education of those who depend upon the Cultivation of the Soil for their Support. By the Rev. W. Holt Beever, M.A., Oxon .. .. .	29
IV.—The Management of Cattle. By William Little. Prize Essay	45
V.—On Cross-Breeding Cattle. By G. Murray .. .. .	52
VI.—On Rainfall, Natural Drainage, and Subterranean Water Storage. By Professor D. T. Austed, M.A., F.R.S., &c. ..	62
VII.—The Poultry of France. (From materials furnished by the 'Journal d'Agriculture Pratique.') By P. H. Frere .. ..	79
VIII.—On Disinfectants: being the substance of a Lecture delivered in December, 1865, with a Report of further Experiments, &c. By Dr. A. Voelcker .. .. .	93
IX.—On the Management of Ponds and Wells. By R. Orlebar ..	107
X.—On the Comparative Cheapness and Advantages of Iron and Wood in the Construction of Roofs for Farm-Buildings. By Arthur Bailey Denton (Junior). Prize Essay .. ..	116
XI.—On the Comparative Cheapness and Advantages of Iron and Wood in the Construction of Roofs for Farm-Buildings. By Philip D. Tuckett, Land Agent and Surveyor .. ..	140
XII.—Rural Economy of the Netherlands; being a Report read by M. de Lavergne to the Academy of Moral and Political Science. Translated from the 'Journal d'Agriculture Pratique,' by H. Evershed .. .. .	148

ARTICLE.	PAGE
XIII.—On Anthyllis Vulneraria (Lady's Fingers) as a Fodder Plant. By James Buckman, F.L.S., F.G.S., &c., Professor of Geology and Rural Economy .. .. .	161
XIV.—On the Cultivation of Flax in Belgium. Report by R. Percy Ffrench, Second Secretary to H.B.M.'s Legation at Brussels	168
XV.—Professor Voelcker's Annual Report .. .. .	180
XVI.—Upon the Nature of Diseases in Plants. By Baron Liebig ..	187
XVII.—Statistics of Live Stock and Dead Meat for Consumption in the Metropolis; with Letter on arrangements for Meat- Markets. By Robert Herbert .. .. .	195
XVIII.—On the Composition of Orange Globe Mangolds, Bulbs and Tops. By Augustus Voelcker .. .. .	201
XIX.—Summary of the Proceedings of the Royal Agricultural Society of England in reference to Agricultural Education. By S. Benj. L. Druce, Hon. Secretary of the Committee .. ..	209
XX.—Experiments with Artificial Manure as Top-dressing, used at Wonston Manor Farm, Hauts. By W. J. Moreton Pocock .. .. .	226
XXI.—The Cattle-Plague. By Howard Reed .. .. .	230

ABSTRACT REPORT OF AGRICULTURAL DISCUSSIONS :

The Cattle-Plague. A Lecture by Professor Simonds .. .. .	270
---	-----

---

APPENDIX.

	PAGE
List of Officers of the Royal Agricultural Society of England, 1866 ..	i
Standing Committees for 1866 .. .. .	iii
Memoranda of Meetings, Payment of Subscription, &c. .. .. .	vi
Report of the Council to the General Meeting, December 13, 1865 ..	vii
Yearly Cash Account, from 1st January to December 31, 1865 .. ..	xi
Cash Account and Balance-sheets, from 1st July to December 31, 1865	xii
Country Meeting Account, Plymouth, 1865 .. .. .	xiv
Members' Chemical Analysis and Veterinary Privileges .. .. .	xv, xvi

---

DIRECTIONS TO THE BINDER.

The Binder is desired to collect together all the Appendix matter, with Roman numeral folios, and place it at the *end* of each volume of the Journal, excepting Titles and Contents, and Statistics, &c., which are in all cases to be placed at the *beginning* of the Volume: the lettering at the back to include a statement of the *year* as well as the *volume*; the first volume belonging to 1839-40, the second to 1841, the third to 1842, the fourth to 1843, and so on.

In reprints of the Journal, all Appendix matter (and in one instance an Article in the body of the Journal), which at the time had become obsolete, were omitted; the Roman numeral folios, however (for convenience of reference), were reprinted without alteration in the Appendix matter retained.

# VITAL STATISTICS; METEOROLOGY; PRICES OF FOOD; PAUPERISM; BRITISH WHEAT SOLD; IMPORTATIONS OF CORN AND OTHER PRODUCE.



*The facts are selected from the Reports of the REGISTRAR-GENERAL; from Mr. GLAISHER'S Meteorological Tables, and Notes on the Weather; and from Returns of the BOARD OF TRADE.*

## THE UNITED KINGDOM.

The Registers of the United Kingdom show that 114,328 persons married in the quarter that ended in June, 1865; that the births of 243,119 children, and the deaths of 148,167 persons of both sexes, were registered in the three months ending on September 30th. The natural recorded increase of population in 92 days was 94,952, or 1032 daily. Exclusive of 11,490 foreigners, 53,564 emigrants sailed from these islands in the September quarter. So about 582 emigrants left daily; and allowing for defects in registration, which has only recently been established in Ireland, the increase in the home population has been about 506 daily.

The estimated population in 1865 of England, Scotland, and Ireland, was 29,772,294. The death-rate was 1.974 per cent. in the three months ending September 30th.

During the three months scarlatina was epidemic in many parts of England. Diarrhoea was prevalent and often fatal to children; and scattered cases of summer cholera were as usual fatal in unhealthy districts. At the end of the quarter four deaths from cholera occurred in Southampton, two of which were pronounced epidemic cholera. The meteorology of the season was extraordinary, the potato was in many places blighted, and the cattle were struck down by zymotic disease; yet the people were untouched by pestilence. While Marseilles and Paris were smitten by cholera, London and the large cities of the United Kingdom enjoyed immunity.

### BIRTHS AND DEATHS IN THE LAST SIX MONTHS OF 1865 IN ENGLAND AND WALES.

In the *third quarter* (July, August, September) the number of births was 181,642, the highest number that has ever been registered

in the summer quarter. The mean daily number of births was 1974. The birth-rate in the quarter was 3·429 per annum, against an average of 3·325.

In the *fourth quarter* (October, November, December) the number of births was 179,020. The birth-rate was 3·370, against an average rate of 3·297.

In the *third quarter* 113,404 deaths were registered, and the mortality was at the annual rate of 2·141 per cent.; that is ·169 above the average, but differing little from the mortality of the two preceding summer quarters.

This is the result of a balance of high and low rates in the eleven divisions of the kingdom. The rate for all England was 21 per 1000 living in the two summer quarters of 1864 and 1865. Yorkshire here proclaims aloud in the increasing death-rate her sanitary failings; the summer mortality rose from 24 to 25. In Lancashire and Cheshire the mortality was 23 and 26. The Eastern Counties also experienced an increase; so did the Northern Counties. There was a decisive fall in the mortality of Gloucestershire, Staffordshire, Worcestershire, and Warwickshire, reducing the mortality of the West Midland Counties from 22 to 19. Various sanitary improvements have been carried out with good effect. This is also the case with London, where the works of the Metropolitan Board are apparently beginning to display their effects. The mortality of London in the summer quarter of 1864 was at the rate of 24; in the summer of 1865 it was 22.

In the *fourth quarter* 121,304 deaths were registered; and the mortality was at the rate of 2·284 per cent. annually. It was lower than it had been in the same quarter of 1864, but slightly higher than the autumnal average (2·180).

The rate of mortality in the country districts was about 19 in 1000 living; in the town districts nearly 26, and in the kingdom generally nearly 23 per 1000 living.

The mortality was lowest in the South-Western Counties (19), highest in the North-Western Counties (29); thus the annual rate was 10 per thousand higher in Lancashire and Cheshire round the Mersey than it was in the counties between the Bristol Channel and the British channel.

The following Table shows how great is the waste of human life in many large towns where the productive industry of the nation is most active, and where science is applied to almost every purpose except the preservation of health:—



Cities, &c.	Estimated Population in the Middle of the Year 1865.	Births in 13 Weeks ending 30th Dec., 1865.	Deaths in 13 Weeks ending 30th Dec., 1865.	Annual Rate to 1000 living during the 13 Weeks ending 30th Dec., 1865.		Mean Temperature in 13 Weeks ending 30th Dec., 1865.	Rainfall in inches in 13 Weeks ending 30th Dec., 1865.
				Births.	Deaths.		
Total of 11 large towns	5,586,870	51,212	39,773	36.12	28.05	45.3	8.8
London .. .. .	3,013,494	26,544	18,393	35.33	24.05	46.0	9.2
Liverpool (Borough)	476,368	4,758	4,861	40.09	40.96	47.5	5.8
Manchester (City) ..	354,930	3,172	3,156	35.87	35.69	43.7	8.5
Salford (Borough) ..	110,833	1,008	949	36.50	34.37	45.3	8.1
Birmingham (Borough)	327,842	3,210	2,145	39.30	26.26	45.2	8.4
Leeds (Borough) ..	224,025	2,379	1,841	42.62	32.98	44.8	8.1
Bristol (City) .. ..	161,809	1,450	967	35.97	23.99	46.2	11.6
Hull (Borough) .. ..	103,747	972	754	37.60	29.17	..	..
Edinburgh (City) ..	174,160	1,492	1,254	34.38	28.90	43.4	5.8
Glasgow (City) .. ..	423,723	4,201	3,434	39.79	39.53	43.9	12.4
Dublin (City and some suburbs) .. .. .	317,666	2,026	2,019	25.60	25.51	46.6	10.0

### METEOROLOGY.

During the first three weeks of July the weather was unsettled; the temperature of the air was alternately in excess and defect. Rain fell frequently between the 6th and the 18th of July all over the British Islands, and some complaints were heard of mildew in the crops. The potato crop which had needed moisture became very promising after the rain. About the 20th of July the weather became clear and dry—a change which proved most beneficial to the growing as well as to the maturing crops. Till the 30th day the temperature was in excess to the amount of 2° daily. On the 31st the weather changed again to cold and wet: harvest-work was a good deal interrupted. In the first week of August indications of the potato disease were seen both in Ireland and England. The weather continued unsettled, rain fell heavily in various parts of the country, and the deficiency of temperature amounted to 3° daily. Harvest-work was stopped for several days together, and much uneasiness was felt about the crops, of which by far the larger portion in the United Kingdom was still standing. The potato crop also displayed increased symptoms of disease. On the 20th the weather improved a little, and there were intervals of bright sunshine. From the 20th day to the end of the month the temperature was in excess to the amount of one degree daily. The month of August was very unfavourable to the crops.

With September came an auspicious change: the temperature was high, there was but little cloud, either night or day; the sun shone with great brilliancy, harvest-work proceeded simultaneously over England, Ireland, and Scotland. In many places very little rain fell, not amounting in the whole month to one-tenth of an inch; the

greatest fall at any place was 1·9 inches at Cockermouth in Cumberland. The reading of the barometer was remarkably high. The temperature frequently exceeded  $80^{\circ}$  at places south of  $53^{\circ}$  latitude, and in some cases rose to  $85^{\circ}$ ,  $86^{\circ}$ , and  $87^{\circ}$ . The average daily excess of temperature was  $7\frac{1}{4}^{\circ}$  for the whole month, which proved to be the hottest month of the year. In consequence of this remarkable weather, the cereal harvest was generally completed earlier than it has been here for many years past. The yield of the wheat crop was spoken of as variable both in quality and quantity, and was thought to fall short of an average. The barley crop was not so deficient.\* At the end of the month rain was much needed to assist the working of the plough, and to supply water for cattle, as many ponds were dried up.

The mean temperature of these three months was  $62^{\circ}\cdot5$ ; in the year 1859, for the same period, it was  $62^{\circ}\cdot8$ ; in 1857 was  $63^{\circ}\cdot3$ ; in 1846 was  $62^{\circ}\cdot6$ ; in 1825 was  $62^{\circ}\cdot3$ ; in 1818 was  $63^{\circ}\cdot5$ ; in 1780 was  $62^{\circ}\cdot7$ ; and in 1779 was  $63^{\circ}\cdot2$ . In all other years back to 1771 it was below  $62^{\circ}$ .

The mean temperature of September was  $63^{\circ}\cdot9$ , being  $7^{\circ}$  above the average of the same month in the preceding 24 years, and  $7^{\circ}$  above that of 1864. The nearest approach to this high temperature was  $60^{\circ}\cdot3$  in 1858;  $60^{\circ}\cdot1$  in 1846;  $60^{\circ}\cdot7$  in 1818;  $62^{\circ}\cdot3$  in 1815;  $60^{\circ}\cdot8$  in 1795; and  $60^{\circ}\cdot7$  in 1779; so that this month was by more than  $1\frac{1}{2}^{\circ}$  of higher temperature than any on record.

Both the day and night temperatures were above their averages in July and September, and were both below in August. The excess of  $9^{\circ}$  by day and  $5^{\circ}$  by night in September is very remarkable.

The remarkably fine and dry weather which had prevailed in September continued during the first week in October: the barometrical reading during this time was about 30 in.; at the beginning of the second week there were indications of a change, the temperature fell, and the barometrical pressure decreased on the 12th day to nearly 29 in., then increased rapidly to 29·9 in. by the 15th, and decreased to below 29 in. by the 18th day; from this time rain fell very heavily, and heavy gales of wind were experienced; the weather continued stormy to the end of the month, rain falling in abundance. At the beginning of November there were frequent gales, and much stormy weather; at about the 10th day the weather assumed a more settled character, the barometrical reading ascended above the average, and was nearly 30·4 in. on the 12th; from the 17th to the 22nd it decreased very rapidly, and was 28·8 in. on the last men-

---

\* The light lands suffered severely from the drought, the Eastern counties especially from a frost in May; but the good, strong lands bore a full average crop of cereals.—P. H. F.

tioned day, accompanied by a fearful gale, acting with ruinous effects on both land and sea. The reading of the barometer was very unsettled during the remainder of the month.

December opened with light south-east winds, the air mild and warm. The reading increased by the 11th day to 30·8 in. About the middle of the month trees budded and daisies were in blossom. Towards the end of the month the mercury fell quickly till it was 29·0 in. by the 29th. Frequent and violent gales occurred, causing many shipwrecks. The force of the wind on the last day reached 24 lbs. on the square foot, both at Greenwich and at Liverpool. The temperature during the whole quarter, with the exception of a few days about the middle of October, the beginning of November, and the middle of December, was in excess of the average, to the daily amount of  $1\frac{3}{4}^{\circ}$ .

The fall of rain in the whole year (1865) was 29 in., and was about  $3\frac{1}{2}$  in. above the average.

#### PRICES OF PROVISIONS.\*

*Third Quarter.*—The average price of wheat was 43s. 3d. a quarter during the three months ending with September 30th; thus it was a shilling a quarter higher than in the corresponding season of 1864, and 2s. 4d. lower than in that of 1863. The price of wheat was remarkably steady during the two years, the three months' average ranging little above or below the average (40s. 9d.) of the whole period. The best potatoes at the Waterside Market, Southwark, sold on an average at 85s. a ton; so the price was lower by 15s. than it was in the corresponding quarter of 1864, and somewhat lower than the price of the same season in 1863.

*Fourth Quarter.*—The best potatoes at the Waterside Market, Southwark, sold at prices ranging from 60s. to 90s. a ton. The prices were much lower than in the autumn of 1864. The average price of wheat was 44s. 10d. a quarter.

#### PAUPERISM.

*Third Quarter.*—A gratifying reduction of pauperism was observable; during the last three summers the numbers of in-door and out-door poor fell from 939,984 to 855,039 and to 836,761.

*Fourth Quarter.*—On an average 129,036 paupers received complete relief in the workhouses; 725,259 paupers out of doors received relief sufficient to supply some of their wants, but not enough for subsistence. The numbers relieved in the workhouses scarcely varied; the numbers out of doors fell from 804,941 to 771,879, and to 725,259 in the last three autumnal quarters.

---

\* For prices of meat, see Mr. Herbert's Report.

## METEOROLOGICAL OBSERVATIONS TAKEN AT THE ROYAL OBSERVATORY, GREENWICH.

1865. MONTHS.	Temperature of												Elastic Force of Vapour.		Weight of Vapour in a Cubic Foot of Air.				
	Air.			Evaporation.			Dew Point.		Air—Daily Range.			Water of the Thames.		Mean.	Diff. from average of 24 years.	Mean.	Diff. from average of 24 years.		
	Mean.	Diff. from average of 94 years.	Diff. from average of 24 years.	Mean.	Diff. from average of 24 years.	Mean.	Diff. from average of 24 years.	Mean.	Diff. from average of 24 years.	Mean.	Diff. from average of 24 years.	Mean.	Diff. from average of 24 years.						
July .. ..	63·8	+2·4	+2·1	58·6	+1·3	54·2	+0·6	21·4	0	21·4	+0·6	65·9	0	0	0	4·7	+0·1	grs.	grs.
August ..	59·9	-0·8	-1·4	56·4	-1·0	53·4	-0·4	19·4	-0·3	19·4	-0·3	64·2	0	0	0	4·5	-0·1	grs.	grs.
September..	63·9	+7·5	+7·0	59·5	+5·7	55·9	+5·0	22·8	+4·3	22·8	+4·3	65·7	0	0	0	5·0	+0·8	grs.	grs.
Mean ..	62·5	+3·0	+2·6	58·2	+2·0	54·5	+1·7	21·2	+1·5	21·2	+1·5	65·3	0	0	0	4·7	+0·3	grs.	grs.
October ..	50·9	+1·2	+0·4	49·0	+0·5	47·0	+0·7	16·3	0	16·3	+1·7	55·4	0	0	0	3·6	-0·1	grs.	grs.
November ..	44·8	+2·4	+0·8	43·2	+1·6	41·4	+1·5	12·1	+0·4	12·1	+0·4	43·9	0	0	0	3·0	+0·2	grs.	grs.
December ..	42·4	+3·4	+2·1	41·0	+2·2	39·4	+2·4	8·6	-1·0	8·6	-1·0	43·2	0	0	0	2·8	+0·2	grs.	grs.
Mean ..	46·0	+2·3	+1·1	44·4	+1·4	42·6	+1·5	12·3	+0·4	12·3	+0·4	47·5	0	0	0	3·1	+0·1	grs.	grs.

NOTE.—In reading this table it will be borne in mind that the sign (-) minus signifies below the average, and that the sign (+) plus signifies above the average.

## METEOROLOGICAL OBSERVATIONS TAKEN AT THE ROYAL OBSERVATORY, GREENWICH.

1865. MONTHS.	Degree of Humidity.		Reading of Barometer.		Weight of a Cubic Foot of Air.		Rain.		Daily Horizontal movement of the Air.	Reading of Thermometer on Grass.				
	Mean.	Diff. from average of 24 years.	Mean.	Diff. from average of 24 years.	Mean.	Diff. from average of 24 years.	Amount.	Diff. from average of 50 years.		Number of Nights it was				
										At or below 30°.	Between 30° and 40°.	Above 40°.	Lowest Reading at Night.	Highest Reading at Night.
July ..	72	- 6	in. 29.796	in. -0.007	grs. 527	grs. - 1	in. 2.3	in. -0.3	Miles. 212	0	1	30	0	60.5
August ..	80	+ 3	29.712	-0.082	529	- 0	4.0	+1.6	210	0	5	26	36.1	55.3
September ..	76	- 5	30.071	+0.254	531	- 3	0.2	-2.2	157	0	5	25	33.2	59.4
Mean ..	76	- 3	29.860	-0.055	529	- 1	Sum 6.5	Sum -0.9	Mean 193	0	11	Sum 81	Lowest 33.2	Highest 60.5
October ..	87	0	in. 29.440	in. -0.256	grs. 533	grs. - 6	in. 5.9	in. +3.1	Miles 227	4	15	12	0	0
November ..	88	- 1	29.720	-0.029	546	- 2	2.4	0.0	265	8	14	8	25.3	50.7
December ..	89	+ 1	30.056	+0.233	554	- 2	0.9	-1.0	221	5	23	3	24.0	46.9
Mean ..	88	0	29.739	-0.017	544	- 2	Sum 9.2	Sum +2.1	Mean 238	Sum 17	Sum 52	Sum 23	Lowest 24.0	Highest 50.7

NOTE.—In reading this table it will be borne in mind that the sign (-) minus signifies below the average, and that the sign (+) plus signifies above the average.

The AVERAGE PRICES of CONSOLS, of WHEAT, of MEAT, and of POTATOES; also the AVERAGE NUMBER of PAUPERS relieved on the *last day* of each Week; and the MEAN TEMPERATURE; in each of the Nine Quarters ending December 31st, 1865.

Quarters ending	AVERAGE PRICES.					PAUPERISM.		Mean Temperature at Greenwich.
	Consols (for Money).	Wheat per Quarter in England and Wales.	Meat per lb. at Leadenhall and Newgate Markets (by the Carcase).		Best Potatoes per Ton at Waterside Market, Southwark.	Quarterly Average of the Number of Paupers relieved on the <i>last day</i> of each week.		
			Beef.	Mutton.		In-door.	Out-door.	
1863 Dec. 31	£. 92 $\frac{7}{8}$	s. d. 40 6	4d.—6 $\frac{1}{4}$ d. Mean 5 $\frac{5}{8}$ d.	5d.—7d. Mean 6d.	60s.—80s. Mean 70s.	130,072	804,941	46·8
1864 Mar. 31	91	40 4	4 $\frac{1}{2}$ d.—6 $\frac{1}{2}$ d. Mean 5 $\frac{1}{2}$ d.	5 $\frac{1}{2}$ d.—7d. Mean 6 $\frac{1}{4}$ d.	55s.—70s. Mean 62s. 6d.	139,606	855,728	37·9
June 30	91 $\frac{1}{8}$	39 7	4 $\frac{1}{4}$ d.—6 $\frac{1}{4}$ d. Mean 5 $\frac{1}{4}$ d.	5 $\frac{1}{4}$ d.—7d. Mean 6 $\frac{1}{8}$ d.	40s.—60s. Mean 50s.	122,717	785,825	53·1
Sept. 30	89 $\frac{1}{8}$	42 3	4 $\frac{1}{2}$ l.—6 $\frac{1}{2}$ d. Mean 5 $\frac{1}{2}$ d.	5 $\frac{1}{2}$ d.—7d. Mean 6 $\frac{1}{4}$ d.	80s.—120s. Mean 100s.	115,698	739,341	59·4
Dec. 31	89 $\frac{5}{8}$	38 5	4 $\frac{1}{2}$ d.—7d. Mean 5 $\frac{5}{8}$ d.	5 $\frac{1}{4}$ d.—7 $\frac{1}{4}$ d. Mean 6 $\frac{1}{4}$ d.	80s.—95s. Mean 87s. 6d.	128,322	771,879	43·7
1865 Mar. 31	89 $\frac{3}{8}$	38 4	4 $\frac{1}{2}$ d.—7d. Mean 5 $\frac{3}{4}$ d.	5 $\frac{1}{4}$ d.—7 $\frac{1}{4}$ d. Mean 6 $\frac{1}{4}$ d.	85s.—97s. Mean 91s.	142,329	813,371	36·5
June 30	90 $\frac{6}{8}$	40 6	4 $\frac{3}{4}$ d.—6 $\frac{3}{4}$ d. Mean 5 $\frac{3}{4}$ d.	6 $\frac{1}{4}$ d.—8 $\frac{1}{2}$ d. Mean 7 $\frac{3}{8}$ d.	90s.—115s. Mean 102s. 6d.	125,846	776,016	56·2
Sept. 30	89 $\frac{6}{8}$	43 3	4 $\frac{1}{2}$ d.—7d. Mean 5 $\frac{3}{4}$ d.	6 $\frac{1}{4}$ d.—8 $\frac{3}{4}$ d. Mean 7 $\frac{1}{2}$ d.	65s.—100s. Mean 85s.	117,172	719,589	62·5
Dec. 31	88 $\frac{1}{8}$	44 10	4 $\frac{1}{4}$ d.—6d. Mean 5 $\frac{3}{8}$ d.	5 $\frac{1}{4}$ d.—8 $\frac{1}{4}$ d. Mean 6 $\frac{5}{8}$ d.	60s.—90s. Mean 73s.	129,036	725,259	46·0

QUANTITIES of WHEAT, WHEATMEAL and FLOUR, BARLEY, and OATS, IMPORTED into the UNITED KINGDOM in each of the last SIX MONTHS of 1865.

1865.	Wheat.	Wheatmeal and Flour.	Barley.	Oats.
THIRD QUARTER.				
	cwts.	cwts.	cwts.	cwts.
Four weeks, ending July 29	1,284,089	272,014	617,969	995,104
Four weeks, ending Aug. 26	1,815,545	231,686	388,734	900,703
Five weeks, ending Sept. 30	2,421,523	372,544	703,376	709,384
FOURTH QUARTER.				
Four weeks, ending Oct. 28	2,824,691	280,454	672,928	809,468
Four weeks, ending Nov. 25	1,784,174	354,974	1,290,737	440,583
Five weeks, ending Dec. 30	2,785,407	813,302	848,778	814,454
Total in twenty-six weeks ..	13,515,429	2,324,974	4,522,522	4,669,696

The average weekly importation of wheat was in the third quarter 470,858 cwts. and in the fourth quarter it was 568,790 cwts.

QUANTITIES of BRITISH WHEAT SOLD in the TOWNS from which Returns are received under the Act of the 27th and 28th VICTORIA, cap. 87: and their AVERAGE PRICES: in each of the last SIX MONTHS of the Years 1861-65.

	QUANTITIES IN QUARTERS.				
	1861.	1862.	1863.	1864.	1865.
Seventh month .. .. .	quarters. 159,152	quarters. 163,720	quarters. 162,817	quarters. 257,510	quarters. 222,961
Eighth month .. .. .	206,400	136,810	187,011	264,939	201,953
Ninth month (five weeks) ..	455,324	264,410	390,306	322,292	316,893
Tenth month .. .. .	427,435	273,000	333,609	311,169	304,054
Eleventh month .. .. .	345,028	265,160	325,209	302,446	295,632
Twelfth month (five weeks)	359,246	315,599	472,876	399,358	391,941

	AVERAGE PRICES PER QUARTER.				
	1861.	1862.	1863.	1864.	1865.
	s. d.	s. d.	s. d.	s. d.	s. d.
Seventh month .. .. .	50 8	57 0	46 7	42 0	42 10
Eighth month .. .. .	50 8	57 8	46 2	43 7	43 3
Ninth month (five weeks) ..	54 7	56 1	44 6	42 0	44 0
Tenth month .. .. .	56 10	49 5	40 10	38 9	41 10
Eleventh month .. .. .	59 10	49 0	39 11	36 10	45 7
Twelfth month (five weeks)	60 10	46 8	40 9	38 3	46 8

AVERAGE PRICES per Quarter of WHEAT, BARLEY and OATS in the Third and Fourth Quarters of 1865.

	Wheat.		Barley.		Oats.	
	s.	d.	s.	d.	s.	d.
Third quarter .. .. .	43	3	29	0	22	10
Fourth quarter .. .. .	44	10	32	3	22	0

VALUE of WHEAT IMPORTED in each of the TWELVE YEARS, 1854-65.

	£.		£.		£.
1854 .. .. .	11,693,737	1858 .. .. .	9,050,467	1862 .. .. .	23,203,800
1855 .. .. .	9,679,578	1859 .. .. .	8,713,532	1863 .. .. .	12,015,006
1856 .. .. .	12,716,349	1860 .. .. .	16,554,083	1864 .. .. .	10,674,654
1857 .. .. .	9,563,099	1861 .. .. .	19,051,464	1865 .. .. .	9,775,616

The payment for wheat in 1865 was below that of any year in 1860-64; not equal to half of the payment in 1862.



## WHEAT IMPORTED in 1865; and COUNTRIES whence IMPORTED.

	Cwts.
Wheat from Russia .. .. .	8,093,879
„ Prussia .. .. .	5,403,914
„ Denmark .. .. .	641,273
„ Schleswig, Holstein, and Lauenburg .. .. .	254,159
„ Mecklenburg .. .. .	647,685
„ Hanse Towns .. .. .	486,069
„ France .. .. .	2,252,873
„ Turkey and Wallachia and Moldavia .. .. .	574,185
„ Egypt .. .. .	10,063
„ United States .. .. .	1,177,618
„ British North America .. .. .	306,765
„ Other countries .. .. .	1,114,480
Total .. .. .	20,962,963

## CERTAIN ARTICLES of FOREIGN and COLONIAL PRODUCTION IMPORTED in the Three Years 1863-65; and their QUANTITIES.

	1863.	1864.	1865.
Animals living:—			
Oxen, Bulls and Cows .. .. . number	109,653	179,507	227,528
Calves .. .. . number	41,245	52,226	55,743
Sheep and Lambs .. .. . number	430,788	496,243	914,170
Swine and Hogs .. .. . number	27,137	85,362	132,943
Bones (burnt or not; or as animal charcoal) .. .. } tons	77,494	68,870	74,307
Cotton, Raw .. .. . cwts.	5,978,422	7,975,935	8,731,949
Flax .. .. . cwts.	4,458,962	1,842,947	1,913,132
Guano:—From Peru .. .. . tons	196,704	113,086	210,784
From all other parts .. .. . tons	36,870	18,272	26,609
Total Guano .. .. . tons	233,574	131,358	237,393
Hemp .. .. . cwts.	1,038,159	1,010,888	1,065,705
Hops .. .. . cwts.	147,281	98,656	82,489
Hides Untanned:—Dry .. .. . cwts.	355,306	272,431	292,751
Wet .. .. . cwts.	667,518	682,075	675,312
Petroleum .. .. . tuns	35,347	21,077	14,046
Oilseed Cakes .. .. . tons	88,566	105,570	109,941
Potatoes .. .. . cwts.	1,248,946	742,404	806,753
Bacon and Hams .. .. . cwts.	1,877,813	1,069,390	713,346
Salt Beef .. .. . cwts.	282,677	302,860	228,296
Salt Pork .. .. . cwts.	168,939	189,411	183,155
Butter .. .. . cwts.	986,708	1,054,617	1,083,717
Cheese .. .. . cwts.	756,285	834,844	853,277
Eggs .. .. . number	266,929,680	335,298,240	364,013,040
Lard .. .. . cwts.	530,512	217,275	136,898
Clover Seeds .. .. . cwts.	272,626	226,278	214,071
Flax Seed and Linseed .. .. . quarters	1,104,578	1,434,973	1,435,414
Rape .. .. . quarters	313,577	235,578	206,111
Sheep and Lambs' Wool .. .. . lbs.	173,975,082	203,809,018	209,394,249
Wheat .. .. . cwts.	24,364,171	23,196,713	20,962,963
Barley .. .. . cwts.	7,383,530	4,921,362	7,818,404
Oats .. .. . cwts.	6,495,588	5,562,959	7,714,230
Wheatmeal and Flour .. .. . cwts.	5,218,976	4,512,391	3,904,471

VITAL STATISTICS; EMIGRATION; METEOROLOGY; PRICES OF FOOD; PAUPERISM; BRITISH WHEAT SOLD; IMPORTATIONS OF CORN AND OTHER PRODUCE.

---

*The facts are selected from the Reports of the REGISTRAR-GENERAL; from Mr. GLAISHER'S Meteorological Tables, and Notes on the Weather; and from Returns of the BOARD OF TRADE.*

---

UNITED KINGDOM.

The population of England, Scotland, and Ireland, at home, estimated for the middle of the year 1866, is 29,935,404.

ENGLAND AND WALES: BIRTHS AND DEATHS IN THE FIRST SIX MONTHS OF 1866.

In the *First Quarter* the births in England were 196,737, against the high number 194,287 in the corresponding period of 1865. The annual birth-rate for the same period was 3·776 per cent.; the average being 3·644. The birth-rate is always higher in the first six months of the year than in the last; but the tables for the last ten years furnish no instance of a rate so high as that which prevailed in that quarter.

Whilst the births were 196,737, the deaths were in the same time 138,233, and the excess of the former over the latter was 58,504.

The total number of emigrants in the March quarter from ports in England, Scotland, and Ireland, was 39,672, of whom about 11,000 were of English origin. Irish emigration from the same ports was nearly double that amount. Of the total number 33,000 emigrants had chosen the United States for their destination, 6000 the Australian Colonies. Of the 21,000 Irish emigrants, 19,000 went to the United States.

Emigration had declined greatly in the first quarter of 1865; but it again increased, and was as active as in the two previous years, 1863-64.

In the *Second Quarter* the births in England were 192,459 against 173,263 in the same period of 1866. The annual birth-rate of the quarter was 3·644 per cent. of the population, the average of ten

previous springs being 3·620. The deaths were 128,692. The natural increase of population was, therefore, 63,767.

The total number of emigrants from ports in the United Kingdom was 80,303, of whom about 19,000 were of English origin; while the Scotch were nearly 5000, and the Irish 45,000. About 65,000 were destined to the United States, a number which exceeds the emigration to the same part in any June quarter in the last twelve years, with the exception of 1864.

The annual rate of mortality in the first quarter in England was 2·653 per cent.; the average of ten previous winters being 2·504. But it is remarkable that this excess above the average was contributed entirely by the large towns; for in the country districts the death-rate, 2·252, was actually lower than the average, 2·295. The annual rate of mortality in the 142 town districts was 2·967, against the average, 2·680. These results confirm the conclusion that there were other destructive causes at work besides unfavourable states of the weather—that epidemic diseases, which commit so much havoc in towns, were extensively fatal, and acquired additional vigour from influences peculiar to the season.

If the map of England were shaded to represent the rates of mortality of the March quarter in the registration districts, the eye, travelling from the lighter south to the darker north would be drawn to a spot of portentous darkness on the Mersey; and the question would be asked whether cholera, the black death, or other plague, had been introduced into its busy and populous seaport. Fever, probably developed or aided by the mild and damp atmosphere of the season, and by overcrowding in an increasing population, was at work. The annual mortality of the borough of Liverpool in the three months was excessive: it rose to 4·593 per cent. This implies that if this death-rate were maintained for a year, forty-six persons out of a thousand in the population would die in that time, or fifteen more than died in Glasgow, its northern rival; nineteen more than in London. The mortality of the city of Manchester, though far less than that of Liverpool, was also very high; it was 3·742 per cent., and that of Leeds was hardly less.

The deaths in the quarter that ended on June 30th exceeded the average of the season. Their number was 128,692, and the mortality, after taking increase of population into account, exceeded the customary rate; for instead of 2·186 the mortality was at the rate of 2·437 per cent. The spring quarter is usually not only healthier than the quarter of winter or autumn, but healthier than the whole round of the year.

The country districts, containing about 9,279,270 inhabitants, died at the rate of 22 in 1000 in the last spring quarter; a rate exceeding the average (20) of those districts by 2. The town districts, of about 11,903,049 inhabitants, suffered still more, for in them the rate was over 26 in 1000, whereas their average is 23.

Cities, &c.	Estimated Population in the Middle of the Year 1866.	Births in 13 Weeks ending 31st March, 1866.	Deaths in 13 Weeks ending 31st March, 1866.	Annual Rate to 1000 living during the 13 Weeks ending 31st March, 1866.		Mean Temperature in 13 Weeks ending 31st Mar., 1866.	Rainfall in inches in 13 Weeks ending 31st Mar., 1866.
				Births.	Deaths.		
London .. .. .	3,067,536	28,407	20,029	37·17	26·66	41·2	9·3
Bristol (City) .. ..	163,680	1,482	1,315	36·34	32·25	41·3	11·1
Birmingham (Borough)	335,798	3,404	2,565	40·69	30·66	41·3	7·0
Liverpool (Borough) ..	484,337	5,078	5,542	42·08	45·93	41·9	6·0
Manchester (City) ..	358,855	3,422	3,346	38·27	37·42	40·6	8·5
Salford (Borough) ..	112,904	1,101	936	39·14	33·27	40·1	8·5
Sheffield (Borough) ..	218,257	2,212	1,818	40·68	33·43	39·6	8·2
Leeds (Borough) ..	228,187	2,535	2,095	44·59	36·85	40·3	6·5
Hull (Borough) .. ..	105,233	1,072	730	40·89	27·84	—	—
Newcastle-on-Tyne (Borough) .. .. }	122,277	1,299	962	42·64	31·58	38·9	3·5
Edinburgh (City) ..	175,128	1,555	1,313	35·64	30·09	38·4	8·6
Glasgow (City) .. ..	432,265	4,678	3,376	43·44	31·37	38·6	15·6
Dublin (City and some suburbs) .. .. }	318,437	2,306	2,423	29·07	30·54	41·8	7·6

Cities, &c.	Estimated Population in the Middle of the Year 1866.	Births in 13 Weeks ending 30th June, 1866.	Deaths in 13 Weeks ending 30th June, 1866.	Annual Rate to 1000 living during the 13 Weeks ending 30th June, 1866.		Mean Temperature in 13 Weeks ending 30th June 1866.	Rainfall in inches in 13 Weeks ending 30th June 1866.
				Births.	Deaths.		
London .. .. .	3,067,536	26,776	19,291	35·03	25·29	53·0	7·9
Bristol (City) .. ..	163,680	1,429	1,039	35·04	25·48	52·6	6·4
Birmingham (Borough)	335,798	3,236	2,059	38·68	24·61	52·1	6·2
Liverpool (Borough) ..	484,337	4,802	4,569	39·79	37·86	54·1	5·0
Manchester (City) ..	358,855	3,353	2,701	37·50	30·21	52·6	5·8
Salford (Borough) ..	112,904	1,090	856	38·75	30·43	51·2	6·3
Sheffield (Borough) ..	218,257	2,180	1,667	40·09	30·66	50·2	6·5
Leeds (Borough) ..	228,187	2,591	1,925	45·57	33·86	51·3	4·7
Hull (Borough) .. ..	105,233	1,048	646	39·97	24·64	—	—
Newcastle-on-Tyne (Borough) .. .. }	122,277	1,281	872	42·05	28·62	50·4	4·6
Edinburgh (City) ..	175,128	1,658	1,179	38·00	27·02	49·2	3·7
Glasgow (City) .. ..	432,265	4,693	3,533	45·43	32·80	49·9	5·1
Dublin (City and some suburbs) .. .. }	318,437	2,374	2,054	29·92	25·89	51·5	7·8

## METEOROLOGY.

[*Deduced from Observations made at the Royal Observatory, Greenwich.*]

The weather at the beginning of the year 1866 was stormy, with gales of wind. The temperature was high for the season. On the 11th day there was an unusual fall of sticking snow, of very great specific gravity. The street traffic in London was extremely difficult; the telegraphic wires were so loaded with snow, and the wind was so violent, that many poles gave way, and telegraphic communication all round London was greatly interrupted. The snow was of that unusually dense character, that 6 inches in depth produced water to the depth of  $1\frac{1}{2}$  in. nearly. A very rapid thaw set in, and within two or three days all the snow disappeared, and floods ensued. All the low-lying lands along the valley of the Thames were under water. The weather continued changeable throughout January, with heavy rains and gales of wind. The characteristic feature of this month was its extraordinary warmth, it being  $6\frac{1}{4}^{\circ}$  above its average value from 50 years' observation. This unusual temperature continued till 12th February, and the average daily excess of temperature up to this time was  $6^{\circ}$ . From the 13th day of February till 15th March the weather was cold, and almost constantly below the average for the season of the year. The average daily defect of temperature for this period was  $2^{\circ}\cdot9$ ; four days of warm weather followed, each day being about  $2^{\circ}$  in excess of its average temperature. This was succeeded by four days of very cold weather, the defect averaging  $4\frac{1}{2}$  daily; and the quarter closed with eight days whose temperature exceeded their averages by  $6^{\circ}$ .

The extremely mild weather in January and the first part of February stimulated vegetation to a very unusual activity for this season. Hedges and early fruit-trees were budding, and some were ready to burst into blossom.

The change in the middle of February, from a mild and damp, to a colder and dryer atmosphere, prevented vegetation advancing too rapidly, and was otherwise beneficial to agricultural operations, by enabling farmers to do much field and farm work, which in many places, owing to the sodden state of the ground, was in a very backward state.

At the end of the quarter vegetation was sufficiently checked by the cold weather, and the growing crops generally were sufficiently advanced to be secure from the danger of sudden frosts.

At the beginning of April the weather was cold, the temperature being below the average to the mean amount of  $2^{\circ}\cdot4$  during the

first nine days. The nights were also very cold and rain fell copiously throughout the first two weeks. On the 10th of the month a sudden change to heat set in, continuing till the 28th day, during which time the weather was unusually fine and very hot for the season, and but little rain fell. This sudden drying weather much impeded spring operations, particularly in agriculture, which was generally in a backward state. The budding of trees was in general late, but the backward fruit-trees, &c., burst at once into leaf and blossom. On the 29th of April a cold ungenial period set in, continuing to the 1st of June, with only an occasional day of somewhat warmer character intervening. The mean daily deficiency of temperature during this time amounted to  $3^{\circ}1$ , and at night the thermometer frequently fell to below  $32^{\circ}$ .

This weather seriously affected all the crops and cut off much of the blossom from fruit-trees. The growth of wheat, barley, and oats was much retarded, although on some very rich lands the cereal crops had in a measure recovered by the end of May. Pasture land made little or no progress, and rain was much required.

On June 2nd the weather again changed and became much warmer, and a mean daily excess over the average temperature occurred to the amount of  $4^{\circ}2$  till the 11th day. A similar cold period followed, but on the 21st day the temperature again increased considerably, and fine weather followed till the end of the quarter, the mean daily excess of temperature amounting to nearly  $5^{\circ}$ . By this time the crops were generally in a pretty favourable condition. Hay-making had progressed well, though somewhat below the average in quantity. There were some fears that the wheat crop would be light. Potatoes were promising, and free from disease.

## METEOROLOGICAL OBSERVATIONS TAKEN AT THE ROYAL OBSERVATORY, GREENWICH.

1866. MONTHS.	Temperature of										Elastic Force of Vapour.		Weight of Vapour in a Cubic Foot of Air.	
	Air.		Evaporation.		Dew Point.		Air—Daily Range.		Water of the Thames.		Mean.	Diff. from average of 25 years.	Mean.	Diff. from average of 25 years.
	Mean.	Diff. from average of 95 years.	Mean.	Diff. from average of 25 years.	Mean.	Diff. from average of 25 years.	Mean.	Diff. from average of 25 years.	Mean.	Diff. from average of 25 years.	in.	in.	grs.	grs.
January ..	42.6	0	40.7	+3.8	36.4	+3.4	11.1	0	42.1	0	.234	+0.32	2.7	+0.3
February ..	40.5	+2.2	38.5	+1.5	35.9	+1.3	12.4	+1.1	40.5	40.5	.211	+0.09	2.4	0.0
March ..	40.5	-0.5	38.0	-1.4	34.8	-1.7	13.9	-0.8	41.7	41.7	.202	-0.15	2.3	-0.2
Mean ..	41.2	+2.7	39.1	+1.3	36.4	+1.0	12.5	+0.6	41.4	41.4	.216	+0.09	2.5	0.0
April ..	47.9	0	44.9	+1.2	41.5	+1.2	17.4	0	51.3	0	.262	+0.11	3.0	+0.1
May ..	50.1	-2.5	45.6	-3.7	40.8	-4.9	20.6	+0.3	52.6	52.6	.255	-0.49	2.9	-0.6
June ..	60.9	+2.8	56.9	+2.3	53.5	+2.8	21.2	+0.4	62.6	62.6	.410	+0.38	4.6	+0.4
Mean ..	53.0	+0.8	49.1	-0.1	45.3	-0.3	19.7	-0.1	53.5	53.5	.309	'000	3.5	0.0

NOTE.—In reading this table it will be borne in mind that the sign (-) minus signifies below the average, and that the sign (+) plus signifies above the average.



## METEOROLOGICAL OBSERVATIONS TAKEN AT THE ROYAL OBSERVATORY, GREENWICH.

1866. MONTHS.	Degree of Humidity.		Reading of Barometer.		Weight of a Cubic Foot of Air.		Rain.		Daily Horizontal movement of the Air.	Reading of Thermometer on Grass.				
	Mean.	Diff. from average of 25 years.	Mean.	Diff. from average of 25 years.	Amount.	Diff. from average of 51 years.	Sum	Miles.		At or below 30°.	Number of Nights it was		Lowest Reading at Night.	Highest Reading at Night.
											Between 30° and 40°.	Above 40°.		
January ..	86	- 2	in. 29.701	in. -0.056	grs. 548	grs. - 6	in. 3.7	in. +2.0	Miles. 361	10	15	6	0	41.2
February ..	85	0	29.529	-0.269	547	- 7	4.0	+2.5	337	13	13	2	17.3	42.8
March ..	81	- 1	29.527	-0.229	547	- 3	1.6	0.0	239	16	11	4	16.2	49.6
Mean ..	84	- 1	29.586	-0.185	547	- 5	Sum 9.3	Sum +4.5	Mean 312	Sum 39	Sum 39	Sum 12	Lowest 16.2	Highest 49.6
April ..	79	0	in. 29.743	in. -0.026	grs. 543	grs. 0	in. 2.4	in. +0.7	Miles 292	2	20	8	0	45.8
May ..	71	- 5	29.813	+0.039	542	0	1.9	-0.2	240	7	18	6	26.0	47.1
June ..	77	+ 3	29.774	-0.025	529	- 2	3.6	+1.6	242	0	5	25	35.1	56.9
Mean ..	76	- 1	29.777	-0.004	538	- 1	Sum 7.9	Sum +0.7	Mean 258	Sum 9	Sum 43	Sum 39	Lowest 26.0	Highest 56.9

NOTE.—In reading this table it will be borne in mind that the sign (-) minus signifies below the average, and that the sign (+) plus signifies above the average.

The AVERAGE PRICES of Consols, of Wheat, of Meat, and of Potatoes; also the AVERAGE NUMBER of PAUPERS relieved on the *last day* of each Week; and the MEAN TEMPERATURE; in each of the Nine Quarters ending June 30th, 1866.

Quarters ending	AVERAGE PRICES.					PAUPERISM.		Mean Temperature at Greenwich.	
	Consols (for Money).	Wheat per Quarter in England and Wales.	Meat per lb. at Leadenhall and Newgate Markets (by the Carcase).		Best Potatoes per Ton at Waterside Market, Southwark.	Quarterly Average of the Number of Paupers relieved on the <i>last day</i> of each week.			
			Beef.	Mutton.		In-door.	Out-door.		
1864	£.	s.	d.					°	
June 30	91 $\frac{1}{8}$	39	7	4 $\frac{1}{4}$ d.—6 $\frac{1}{4}$ d. Mean 5 $\frac{1}{4}$ d.	5 $\frac{1}{2}$ d.—7d. Mean 6 $\frac{1}{4}$ d.	40s.—60s. Mean 50s.	122,717	785,825	53°1
Sept. 30	89 $\frac{1}{8}$	42	3	4 $\frac{1}{2}$ d.—6 $\frac{1}{2}$ d. Mean 5 $\frac{1}{2}$ d.	5 $\frac{1}{2}$ d.—7d. Mean 6 $\frac{1}{4}$ d.	80s.—120s. Mean 100s.	115,698	739,341	59°4
Dec. 31	89 $\frac{3}{8}$	38	5	4 $\frac{1}{2}$ d.—7d. Mean 5 $\frac{3}{4}$ d.	5 $\frac{1}{4}$ d.—7 $\frac{1}{4}$ d. Mean 6 $\frac{1}{4}$ d.	80s.—95s. Mean 87s. 6d.	128,322	771,879	43°7
1865									
Mar. 31	89 $\frac{3}{8}$	38	4	4 $\frac{1}{2}$ d.—7d. Mean 5 $\frac{3}{4}$ d.	5 $\frac{1}{4}$ d.—7 $\frac{1}{4}$ d. Mean 6 $\frac{1}{4}$ d.	85s.—97s. Mean 91s.	142,329	811,371	36°5
June 30	90 $\frac{6}{8}$	40	6	4 $\frac{3}{4}$ d.—6 $\frac{3}{4}$ d. Mean 5 $\frac{3}{4}$ d.	6 $\frac{1}{4}$ d.—8 $\frac{1}{2}$ d. Mean 7 $\frac{3}{8}$ d.	90s.—115s. Mean 102s. 6d.	125,846	776,016	56°2
Sept. 30	89 $\frac{6}{8}$	43	3	4 $\frac{1}{2}$ d.—7d. Mean 5 $\frac{3}{4}$ d.	6 $\frac{1}{4}$ d.—8 $\frac{3}{4}$ d. Mean 7 $\frac{1}{2}$ d.	65s.—100s. Mean 85s.	117,172	719,589	62°5
Dec. 31	88 $\frac{1}{8}$	44	10	4 $\frac{1}{4}$ d.—7d. Mean 5 $\frac{5}{8}$ d.	5 $\frac{1}{4}$ d.—8 $\frac{1}{4}$ d. Mean 6 $\frac{7}{8}$ d.	60s.—90s. Mean 75s.	129,036	725,259	46°0
1866									
Mar. 31	87	45	6	4 $\frac{1}{2}$ d.—6 $\frac{3}{4}$ d. Mean 5 $\frac{3}{8}$ d.	5 $\frac{1}{4}$ d.—7 $\frac{3}{4}$ d. Mean 6 $\frac{3}{8}$ d.	55s.—90s. Mean 72s. 6d.	139,546	759,402	41°2
June 30	86 $\frac{1}{8}$	46	6	4 $\frac{3}{4}$ d.—7d. Mean 5 $\frac{7}{8}$ d.	5 $\frac{1}{2}$ d.—8 $\frac{1}{2}$ d. Mean 7d.	60s.—95s. Mean 77s. 6d.	123,657	734,139	53°0

QUANTITIES of WHEAT, BARLEY, and OATS, IMPORTED into the UNITED KINGDOM in each of the first SIX MONTHS of the YEAR 1866.

1866.	Wheat.	Barley.	Oats.
	cwts.	cwts.	cwts.
First month .. .. .	1,393,997	346,767	170,435
Second month .. .. .	2,506,969	452,359	375,306
Third month (five weeks) ..	1,848,963	969,046	669,800
Total in the first quarter ..	5,749,929	1,768,172	1,215,621
Fourth month .. .. .	1,425,043	811,389	508,998
Fifth month .. .. .	1,926,562	659,155	773,745
Sixth month (five weeks) ..	2,536,996	716,542	981,443
Total in the second quarter ..	5,888,601	2,187,086	2,264,186

QUANTITIES OF BRITISH WHEAT SOLD in the Towns from which Returns are received under the Act of the 27th and 28th VICTORIA, cap. 87; and their AVERAGE PRICES; in each of the first SIX MONTHS of the Years 1861-66.

	QUANTITIES IN QUARTERS.					
	1861.	1862.	1863.	1864.	1865.	1866.
First month ..	quarters. 262,527	quarters. 220,266	quarters. 262,923	quarters. 344,930	quarters. 300,816	quarters. 212,713
Second month	197,236	242,229	239,882	306,713	296,271	259,999
Third month (five weeks) }	253,620	277,410	281,405	350,974	373,669	331,295
Fourth month..	201,551	173,174	243,552	285,286	261,501	250,159
Fifth month ..	214,432	185,356	267,587	284,601	327,694	250,896
Sixth month (five weeks) }	220,608	208,042	302,897	333,201	283,528	245,393

	AVERAGE PRICES PER QUARTER.					
	1861.	1862.	1863.	1864.	1865.	1866.
	s. d.	s. d.	s. d.	s. d.	s. d.	s. d.
First month ..	57 0	61 4	47 5	40 7	38 6	45 10
Second month..	54 4	60 0	47 3	40 8	38 3	45 7
Third month (five weeks) }	54 3	59 3	45 8	40 1	38 6	45 4
Fourth month..	56 5	58 0	45 7	40 0	39 8	44 10
Fifth month ..	55 0	58 0	46 4	39 2	41 0	46 3
Sixth month (five weeks) }	53 5	54 7	46 8	39 8	41 5	48 3

AVERAGE PRICES OF BRITISH CORN per Quarter (imperial measure) as received from the INSPECTORS and OFFICERS of EXCISE according to the Act of 27th and 28th VICTORIA, cap. 87, in each of the first TWENTY-SIX WEEKS of the Year 1866.

Week ending	Wheat.	Barley.	Oats.	Week ending	Wheat.	Barley.	Oats.
	s. d.	s. d.	s. d.		s. d.	s. d.	s. d.
January 6 ..	46 3	32 9	23 6	April 7 ..	44 9	37 2	24 6
January 13..	46 1	32 6	22 8	April 14 ..	44 5	37 0	24 2
January 20..	45 7	32 10	22 10	April 21 ..	44 9	37 2	24 8
January 27..	45 6	33 1	23 3	April 28 ..	45 5	36 3	24 6
February 3..	45 10	33 0	23 1	May 5 ..	45 9	36 3	25 0
February 10	45 5	33 6	23 6	May 12 ..	45 9	36 4	24 10
February 17	45 9	33 9	23 0	May 19 ..	46 1	36 2	25 2
February 24	45 5	34 8	23 10	May 26 ..	47 4	36 6	25 4
March 3 ..	45 7	34 11	23 5	June 2 ..	47 5	35 4	25 11
March 10 ..	45 4	35 7	23 11	June 9 ..	47 1	35 9	25 8
March 17 ..	45 6	35 10	23 10	June 16 ..	47 4	36 0	25 9
March 24 ..	45 3	36 6	24 1	June 23 ..	48 5	34 4	26 7
March 31 ..	44 11	36 9	23 11	June 30 ..	51 0	34 0	26 0

	Wheat.	Barley.	Oats.
	s. d.	s. d.	s. d.
Average price in First Quarter of the Year	45 7	34 3	23 5
Average price in Second Quarter of the Year	46 7	36 0	25 3

Notwithstanding the lowness of quotations, the arrivals of foreign wheat in this country during the first half of 1866 were 11,508,676 cwts., being 55 per cent. over those of the corresponding half of 1865, and 15 per cent. over 1864. The chief increase was from France and Russia, but there was likewise a considerable augmentation from miscellaneous sources—that is to say, from the various places that are individually unimportant, and figure under the general head of “other countries.” From the United States, which so recently as the year before last sent nearly 40 per cent of our entire foreign supply, the proportion in the first six months of 1866 was only 3 per cent. Russia sent 32 per cent.; France, 23 per cent.; Prussia, 15 per cent.; Mecklenburg, 3 per cent.; the Hanse-Towns, 3 per cent.; Turkey, 2 per cent.; Denmark, 1 per cent.; Schleswig-Holstein, 1 per cent.; Egypt and British North America, each merely a few hundredweights, and other countries 17 per cent. Of flour the importations were 3,134,484 cwts., being double those of the same period of 1865, and 11 per cent. over those of 1864; and in this case also France showed the chief increase, the quantity thence having been 87 per cent. of the whole, the United States having contributed only 5 per cent. Of other kinds of grain the arrivals were mostly large, especially of Indian corn, of which we received three times as much as in 1865, and nearly six times as much as in 1864. Beans are the only grain that shows any material falling off, the importation of these having been only of about half the extent of those of 1864 and 1865. Oats show an increase of 13 per cent., and peas 150 per cent.

‡ GRAIN, FLOUR, POTATOES, LIVING ANIMALS, CHEESE, GUANO, IMPORTED  
in the FIRST SIX MONTHS of 1864-5-6.

	1864.	1865.	1866.
Wheat .. .. . cwts.	10,047,102	7,462,268	11,508,676
Barley .. .. . ,,	2,448,611	4,161,894	3,954,929
Oats .. .. . ,,	1,769,726	3,081,990	3,490,490
Wheatmeal and Flour .. .. ,,	2,774,751	1,562,375	3,134,484
Potatoes .. .. . ,,	235,334	411,789	216,210
Oxen, Bulls, and Cows .. number	47,966	74,392	72,812
Calves .. .. . ,,	15,928	18,785	9,122
Sheep and Lambs .. .. . ,,	129,350	250,212	411,729
Swine and Hogs .. .. . ,,	18,802	38,706	29,873
Cheese .. .. . cwts.	234,176	240,503	190,409
Guano:—From Peru .. .. . tons	40,957	92,988	59,469
From other countries .. .. ,,	7,671	13,255	12,883
Total Guano .. .. . ,,	48,628	106,243	72,352

# JOURNAL

OF THE

## ROYAL AGRICULTURAL SOCIETY OF ENGLAND.

---

---

I.—*On Middle-Class Education, having reference to the Improvement of the Education of those who depend upon the Cultivation of the Soil for their Support.* By R. VALLENTINE.

### PRIZE ESSAY.

STRICTLY speaking the main question is, How the rising generation of farmers is to be educated in a suitable manner for their future profession and position in society, at such a cost of time and means as can be afforded.

I have found it most difficult to come to any practical conclusion on this important question, although aided by many expressions of public opinion, also by extensive reading and correspondence on the subject of education generally.

It is now fully admitted on all hands that the rural or National Schools are not suited to the requirements of farmers' sons. On the other hand, the leading public schools are too classical, and costly in both time and money, for farmers' sons, who must generally have finished their schooling when other pupils are only advancing towards the completion of their education at the Universities. There are doubtless in some neighbourhoods good private schools, well adapted to the demands of farmers; but these are rather the exception than the rule. If then, on the whole, the schools at present in existence are not sufficient and cannot be made so, there is no alternative but to erect new schools, which ought to be under such direction and inspection as would be a guarantee for a thorough system of efficient teaching in those studies which are essential to the future farmer. Then how are these to be started, and how many would probably be required? Mr. Brereton and some others recommend county schools; others advocate professional education at agricultural colleges. The new schools would, at all events, be chiefly boarding-schools, and consequently rather more costly than local schools situated within walking distance of the pupils' homes. Such schools, if efficiently conducted, could hardly charge less than 30*l.* a year, a sum

which few farmers who occupy under 150 acres could afford to pay.

According to the Census Tables, there are about 40,000 farmers in England occupying above 150 acres of land each. It is with the education of their sons that we are chiefly concerned. In order to form some conception of the annual number of deaths amongst a given number of farmers, I have taken a hundred farms for comparison, and find that in 20 years there have been about 63 deaths out of 100 farmers. At this rate, on 40,000 farms, 1200 young farmers would be required annually to fill up the death vacancies. If these calculations be near enough for our purpose, and schooling occupy, say, three years, 3600 would be in training. I think that on an average two farmers have three sons, which would give 5400 pupils, rather than 3600; and agricultural schools, if conducted on a broad basis, might educate all these lads for their future callings, though there would not be farms for them all. Still, for many reasons, I anticipate no such result, and reckon only on much smaller numbers. A great many farmers would not at present so far appreciate a distant boarding-school as to send their sons to it. Some could scarcely afford it; others who live near to towns would prefer to send their sons to the best schools within easy reach. I am well assured that a very large number of farmers would avail themselves of good schools for their sons when once fairly started; many would also assist in starting them. On the other hand, however, many would not assist in any way, being uneducated themselves, and therefore prejudiced and apathetic, or at least unable duly to appreciate the value of education. Many towns, and even some villages, have already very good schools for the middle-classes, and some of these have a special leaning towards agricultural training. These would continue to educate a good many farmers' sons, although new agricultural schools were started in every county to-morrow. Reasoning, therefore, upon the best evidence which presents itself, I think that for *some years at all events* not more than 2000 scholars would be found to attend any schools established upon the principle of being self-supporting.

As a matter of course, day-scholars, as well as boarders, of all ages, might be admitted to the schools. For young men of from sixteen to even twenty years of age, who may have left school without having had an opportunity of learning land-surveying, natural philosophy, and chemistry, a year or two spent at these *district schools* would be of great value, more especially as at that age the value of education would be deeply felt. The sons of townspeople might also avail themselves of county schools, and there obtain a good general education by selecting those

branches which alike suit all classes and professions, and rejecting such as may be exclusively appropriate for farmers. Classics would then be taught to all who desired it.

I have therefore come to the conclusion that *half a dozen large district schools*, scattered throughout England, would meet, for some time to come, the educational demand of farmers' sons, &c. These schools, with those already established, would in a few years be capable of turning out a very large number of young men, well grounded in a plain general education, and so far introduced to the study of some branches of science connected with agriculture that they could pursue them after leaving school. The necessary funds might be raised by the joint exertions of landowners, farmers, and others, the landowners helping to build the schools, and the farmers supporting them, when built, by sending their sons to them. If this be too much to expect, Joint-Stock Companies, or one Joint-Stock Company, might be formed, with shares of not more than 10*l.* each, for building first one school and then another, according to the means available, and the demand for accommodation. Those districts which contributed the most should naturally have the first schools. By concerted action some preliminary expenses might be diminished, and a broader basis of action adopted.

Both in the South-east and the South-west England appears to be already fairly provided in these respects. There are the schools of Cornwall, Devon, Dorset, and Surrey, besides Hurstpierpoint, in Sussex; in the West, Cirencester College, and in the East, the Suffolk Memorial College. That every farmer may have a school within easy reach, one school in Hertfordshire, one in Northamptonshire, and one in each of the counties of Worcester, Lincoln, Derby, and York, might be provided at once, whatever expansion the system might attain hereafter.

Each school ought to have from ten to twenty acres of land attached to it as a playground and for other purposes. Ten thousand pounds would be sufficient to start each school, capable of containing 200 pupils, at first, and of receiving further additions, if required, at a moderate outlay. Buildings of a highly ornamental character are costly both to erect and to keep up, and are by no means necessary. The internal arrangements should be those of a school rather than a college, because professorial teaching is not suited for boys of thirteen, who have only been moderately grounded beforehand. They require the more usual method of question and answer. Too much has generally been attempted; a curriculum of studies which is either too high or too extensive does harm. Boys should not try to run before they can walk; they only get bewildered if they are expected to attend half a dozen lectures a day, and prepare as many

subjects for examination. Even at the Universities Professors are not the only, or the most important teachers. Without previous grounding in the subjects by the aid of tutors, and of expensive private tutors, their lectures would be of little use even to University students.

Some people set up a very high standard indeed for farmers' sons—a wide, very wide range of studies, which, if all thoroughly mastered, would produce a host of *Admirable Crichtons*. I am not quite so sanguine as some in this respect. I do not see the use of *professorial* instruction for the great bulk of farmers' sons, who cannot be sufficiently prepared for such a system. Neither would I send a youth to an agricultural boarding-school until he had mastered the elements of a common English education. No one should attempt to learn mathematics, chemistry, and geology until he can spell, at least moderately well, and understand fractions.

Being a practical farmer, I may state without presumption what branches of study I have found most useful to myself, in addition to a plain English education: these are, chemistry, land-surveying, all kinds of measuring, the principles of geology, an acquaintance with the power, properties, and use of the steam-engine, and other machines. Some knowledge of medicine, and the treatment of domestic animals, is also very useful. Mathematics ought to be taught at school as the best kind of mental discipline, algebra and logarithms being specially included; plane geometry should be learnt, as being the theory of which all practical rules followed in measuring of all kinds are the application. Land-surveying may be learned by much practice *without* mathematics, but in a much less time *with* mathematics. Every farmer ought to know how to measure a field quickly and correctly, that he may be quite at home in calculating the progress and extent of every operation going on, almost daily, on his farm. I do not mean that the chain should be often in use, but that the correct lengths of the various fields being known, a mere stepping across any piece of ploughing, drilling, hoeing, reaping, or manuring may enable you to cast up in your mind, within a trifle, the amount of work done. When a farmer can measure and calculate with readiness and accuracy, there is no difficulty in carrying out any ordinary experiment in manures, or in calculating the weight of a root-crop, by merely measuring some rows or pieces, and ascertaining the produce by measured cart-loads of known weight. Such experiments as these may be carried out near enough for general purposes with little trouble or expense. I have thus carried out about *forty* such in a year with scarcely any expense.

Chemistry is also of frequent use even for those who are not



capable of making an exact analysis; it affords many good tests of the value of manures, soils, &c. It points out the composition of everything to those who can understand the meaning of chemical terms; enables a man to judge what his land may want without going to the doctor, and tells him whether the proper medicine be on the farm or not. For instance, land may require lime; but if good marl or chalk can be found free of cost and near at hand, either one of these may generally take the place of lime. Chemistry tends to open the eyes and enlarge the understanding; it awakens inquiry and reflection—weighs, ponders, and suggests what is useful to be known. It is never entirely learned, and therefore has a never-failing interest.

In the scientific teaching of an agricultural school, Natural Philosophy in general, and Chemistry in particular, should have prominence; for although boys, as boys, might not make much advance at school, the groundwork would be laid for further improvement.

Geology, which has an intimate connexion with the chemistry of soils, should be taught to some extent in agricultural schools, but not professorially or much in detail. It is always a highly interesting supplement to a general education; but I think it a waste of time for boys of average attainments to learn the technical names of the fossils belonging to the various strata. Nor is it worth while to enter into speculative theories as to whether Adam and the Alps were created within some millions of years of one another. There are faults and slips in geological reasoning as well as in the natural phenomena to be dealt with, so that it is not easy to account for the half dozen different kinds of soil frequently found in the same field.

Botany is also a very interesting study, and useful to gardeners, or to the adventurous farmer who aspires to introducing some new plant or some new variety of plants, &c. If, however, there are coarse grasses in a field which nothing will eat, they should be destroyed without even so much as inquiring their names. Practical farming shows various ways of doing this.

Few practical farmers occupy much time with botany.

“The primrose by the river’s brim,  
A simple primrose is to him,  
And it is nothing more.”

And perhaps it is as well that it is so; for the life of a man is too short for him to learn everything; and it is better to learn what is undoubtedly useful than what may only happen to be so. If there is scarcely time for more, let the groundwork of a good general education be secured, with the rudiments of those sciences which have the most intimate connexion with the special profession to be followed.

A good education may be limited in its range, and yet be good of its kind. A good English education should of course include grammar, correct spelling, geography; also somewhat of ancient and modern history: some say entirely modern history; but this is a mistake. History, it is said, repeats itself; so that an insight into the leading events and causes in times long past may throw some light upon the present, and even the future. But we cannot cast as impartial an eye on modern, as on ancient history; modern politics would certainly be introduced to some extent; and it would scarcely do to discuss a living Prime Minister's principles in a boys' school.

A boy should be able to read a page of a good author without stumbling, sniffing, or singing; to write a page correctly from dictation; to state and calculate without hesitation or mistake any ordinary question in arithmetic. He should know the principles of book-keeping, and the changes between the Dr. and Cr. side which so frequently occur in the entries which relate to various articles in a set of books.

In all pursuits *a knowledge of principles is everything*; and the mere unintelligent copying of printed forms is almost valueless. A youth intended to be a farmer should decidedly be kept to his arithmetic and mathematics as a task until he can measure a field, or any other ordinary surface or solid. It may be said that if a knowledge of pure mathematics be obtained, it may be applied when a man pleases. To this I would say, he may probably never please to practise after leaving school unless he practised at it. Moreover, a distinction between theory and practice exists everywhere, and few University men—who have pursued pure mathematics to a much greater length than boys could be expected to do—are able to survey land; nor could they keep the field-book, without practice, where any extent had to be surveyed.

Drawing might be practised in connexion with mathematics, and the study of machinery. The drawing of a steam-engine, for instance, on a larger or smaller scale than the design given to work from, is a very good exercise. After practice of this kind, a plain examination of an engine when in rest and at work, with a teacher to describe everything, soon makes any one acquainted with the whole construction, working, and use of the various parts.

It is well for a young farmer to comprehend the simple mechanical powers, such as the lever, screw, &c., but not to devote much of his time to such subjects as suit the professional engineer—the construction of docks, sea-walls, embankments for rivers, reservoirs, canals, railway levelling, the construction of railways or roads, the building of bridges, &c.

With respect to Classics being taught or not at Agricultural

Schools, I would say, by all means let them be taught, if they can be made supplementary to more necessary subjects which must be thoroughly mastered. I scarcely think, however, that the young farmer will find much leisure for acquiring Classics, either during his school-days or in after life.

The knowledge of other languages gives a clue to English, points out the roots of words, and shows how words and sentences are formed, besides affording a great deal of actual historical information and mental training. Still, the great bulk of mankind must be satisfied with merely knowing that words have certain meanings, without being able to trace the connexion of these meanings or even to refer the word to its primary root. Most men have forgotten much more than they remember, and those who know the most have much more to learn than all they do know. Seeing, therefore, that all knowledge is comparative, but never complete, I advocate selection of those studies which it is most material for the farmer to learn, rather than aiming at high accomplishments which the bulk can never acquire, and in the pursuit of which much valuable time will be spent which could be turned to better account.

With such a system of education as I have suggested, three masters, with some assistants, would be able to conduct a school of two or three hundred boys.

A debtor and creditor account of such a school, according to my calculations, should be nearly as follows:—

<i>School.</i>	
Dr.	£.
To Building, &c., and Preliminary Expenses .. .. .	8,000
To Chapel, if required .. .. .	1,000
Land .. .. .	1,000
	£10,000

ANNUAL STATEMENT.

<i>School.</i>			
Dr.	£.	Cr.	£.
To Board, Washing, &c., for 200 Scholars, at 20 <i>l.</i> each	4000	By School Fees from 200 boys, at 30 <i>l.</i> each .. .. .	6000
To Educational Staff, Servants, &c. .. .. .	1000		
To Balance available for Interest on Building Fund, after providing for the Repair of the Buildings .. .. .	1000		
	£6000		£6000

Such a statement cannot be taken as actually correct. Most

people would say, "It is too good to be true." At all events, it is an approximation which we need not be far from realising if the building be not too pretentious and scholars can be found at once.

This much, at least, may be said, that unless 300 scholars are forthcoming for half-a-dozen district schools, it would be altogether hopeless to expect that 40 county schools could find the requisite support for an expensive staff of efficient teachers. The Suffolk School contemplates taking children of nine years of age. Could the attendance of scholars of this age and upwards to seventeen be secured, my calculations and anticipations would be far exceeded. But I certainly do not expect that parents in general will send boys of nine years of age to a large and distant boarding-school. On the score of expense alone few would do so to self-supporting schools. Head-masters would not teach children their *primers*. Besides, the health and training of the heart of a child would be better attended to at home. The education of the heart—the moral training of youth—is a parent's duty and pleasure, if he is what a parent ought to be. At school the precepts of religion may be taught; but—much more than precepts—mere precepts, and reading of Scripture, are acquired at home. Then who can take the place of a parent who feels the immortal responsibility of his trust? "A little learning may be a dangerous thing," when not accompanied by moral training; but more learning under such circumstances would be still more dangerous. The proverb is true that "knowledge is power," but power may be used for evil just as much as for good. It were better that the child who writes obscene words upon a wall had never learned to write at all, if he can put his learning to no better use. Knowledge may give skill in forgery, and many other such misapplications of skill. Without the restraints which moral principles impose, a man may be an educated demon,—the more intellectual, the more dangerous to all around him.

Since I hold that children up to twelve or thirteen years of age are generally best left under their parents' daily care, I think it desirable that the present Rural Schools should so far extend their elementary teaching as to include grammar and a little plane geometry. These schools must, for a long time to come, be the chief preparatory schools for either county or district seminaries, and it is highly important that they should provide a satisfactory grounding. Now that, under the Revised Code, teachers are paid according to the results of the examination of scholars, there is no longer reason to fear that the poorer children might be neglected if farmers' sons were taught in advanced classes, defraying, of course, the whole cost of their education.

If this object induced their parents to unite in taking a more active interest in such schools, it might lead to their improvement. So long as farmers of small occupations are not able or inclined to send their children to any other than parochial schools some change in the present system is urgently required.

The rural parochial schools in Scotland afford an education for all classes who attend them of a very liberal character. The school-fees, it appears, are also very moderate, running from 2*l.* to 5*l.* a year for day-scholars. In many such schools farmers' sons have the opportunity of obtaining a good general education, with Classics, French, or German,—in short, everything they can require but chemistry, and even this has in some cases been attempted. It is not likely, however, that chemistry will ever be well taught in any parochial schools, since much deeper knowledge is required of the teacher than an ordinary school-master can ever acquire. Moreover, chemistry cannot well be taught to large classes, at all events, of boys, who require at first such special instruction and attention as can be paid only to a few at a time; though youths who had already received a grounding in chemistry might undoubtedly profit by attending chemical classes, well taught by a professional chemist, the expense of which could only be afforded by the resources of a large educational establishment. For this, amongst other reasons, large district schools are required for the support of professional teachers.

I am at a loss to assign any reason for the general advanced state of education in Scotland, other than the high appreciation in which it is held by parents who have been pretty well educated themselves.\*

Success in the education of the middle-classes in their early years depends as much upon the aid and encouragement afforded by parents, as upon the efforts of the regularly-appointed school-master. If this be the case, it is evident that during the brief period of one generation no great educational stride can be made.

In the 'North British Agriculturist' newspaper may be found frequent reports of meetings of farmers' clubs, &c., in all parts of Scotland, at which practical as well as scientific matters are very ably discussed. The numbers who take part in these discussions show how well informed the generality of Scotch farmers are, and how eagerly they seize any opportunity for advancing in useful knowledge. Those who do not read Scotch papers cannot but have observed that Scotch bailiffs and gardeners are very

---

\* This only removes the difficulty a generation back. The true solution of this striking phenomenon will probably be found in several peculiarities in the constitution of the Scotch Kirk.—P. H. F.

numerous in England, and that most of them are proficient in writing and arithmetic. Yet these are not so well educated as the farmers in Scotland. The young Scotchman often looks rather dull at first sight, so as to lead a stranger to suppose he can neither read nor write; but if he be set down to write out an account, or such like, his hand goes like a little engine, and shows at once that both schoolmaster and scholar have been at work. In England the reverse is frequently found. A smart-looking youth discourses very fairly—very fully, perhaps, so as to create an impression that he is well educated, and of an observing turn of mind, which impression may last till something in writing is required, and then he will be utterly at fault, or perform his task in a bad, shaky manner; showing at once that the schoolmaster had been out of the way, and that he is much wanted.

Another instance of the active influence which education has exercised on the Scotch farmers may be found in the career of the Highland Agricultural Society, which was constituted more than half a century before the Royal Agricultural Society of England, and throughout its course has been more generally supported by farmers than the English Society. This I take to be a sign of a defect in English education, which leads to prejudice as well as ignorance. There ought to be more members—far more—belonging to the Royal Agricultural Society. The Society educates by its Journal, its Shows, &c. Every farmer of 100 to 200 acres ought to belong to a Society which endeavours to diffuse—and to a great extent does diffuse—a great deal of useful agricultural information amongst its members. Some members, it is true, complain that the Journal is not so instructive as it might and ought to be. To those we would suggest that they should make some personal efforts to contribute such articles as appear to be required. Were the members of the Royal Agricultural Society more numerous, it might be advantageous to publish the Journal quarterly with more short articles. There will undoubtedly be many more contributors by-and-by, if agricultural schools are started and properly managed.

The Agricultural Society of Scotland has very recently been taking steps for promoting agricultural education, of which the following are the chief points:—

“The examination of candidates of not less than eighteen years of age, for a certificate of proficiency in farm accounts, mensuration, and a good knowledge of practical agriculture; also a general acquaintance with the elements of botany, chemistry, and natural history.”

“That candidates who possess the certificate, and have passed their twenty-first year, should receive a diploma, if found on a final examination to possess a *thorough* knowledge of the theory

and practice of agriculture, of mechanics, and mensuration; of the physiology and treatment of domestic animals, and of the application of botany, chemistry, and natural history to agriculture."

If such be the test of merit, I would say that any one who could take in and hold such a large and varied amount of knowledge would be meritorious indeed, and might well exclaim, like the accomplished young lady after completing her education, that—

"The more she thought the more the wonder grew,  
That *one* small head could *carry* all it knew."

At the same time, when it is taken into account that young men in Scotland have special opportunities for obtaining a liberal education at a small cost, which may be prolonged to twenty-one years of age, there need be no fear of some being forthcoming capable of passing a satisfactory examination on many branches of study, and showing such a proficiency as may be deemed sufficient, if the examiners do not exact too much from them.

It appears that the Agricultural Society of Scotland obtained an extra charter in 1856, which enabled it to confer degrees upon agricultural students.

The subjects for examination, as at first proposed, were more numerous than those named by the new Board of Examination. Very few candidates have hitherto presented themselves at these examinations, either because they were too comprehensive, or else because the honours to be conferred were not sufficiently attractive. The new system may perhaps meet with greater success, though I much doubt whether well-educated young men of twenty-one years of age will travel long distances from home to be examined by a central board, which may *not* award a diploma, and thus do positive injury to the prospects of some candidates.

I should have the same misgivings as to the result if the Royal Agricultural Society were to offer to examine men on their agricultural education. This is a very different thing from testing by the examination at the end of a period of study the proficiency obtained by the scholars from a definite course of instruction. That is an almost necessary guarantee that teachers have really done what they professed to do. The Scotch system, however, presumes a large general acquaintance with practical agriculture.

The system of schools which I have proposed in this Essay does not refer to the learning of practical agriculture at all, because well-digested popular opinion coincides with my own, that the acquirement of a good theoretical education only is all

that can be expected up to that age, when the great majority of those intended for farmers must leave school.

Cirencester College is a very good establishment for combining education with instruction in practical agriculture. It is, however, more suited to the wants and means of those who can afford to prolong their school-days, than to the sons of ordinary farmers.

Having had good opportunities of becoming acquainted with the history and working of Cirencester College, I may be allowed to say that the previous education of a great many of the pupils before entering the College was not, by any means, good enough to enable them to profit, to any great extent, by the advanced lectures in chemistry, botany, geology, veterinary science, civil engineering, &c., and other means of training there placed at their service. This was certainly the case during a long period, and there is no reason to suppose that the educational standard of the pupils lately entered differs materially from that of their predecessors.

Most of the pupils at Cirencester have been gentlemen's sons, and as such have had superior opportunities for obtaining a good groundwork of education. If the collegiate system of teaching has not suited them, how can we expect that it will prove as useful for farmers' sons as that of less pretentious schools? Nowhere in England can a young man with a good English education learn so much of the science and practice of agriculture combined as at Cirencester; but if he be deficient in this respect, the mode of teaching, chiefly by lectures, does not suit him, and both time and money are nearly thrown away. A practice, it appears, has lately sprung up, of having lectures on a great variety of practical agricultural subjects, which are, no doubt, well intended, and may do some good in certain instances. But many question the policy of lecturing a body of inexperienced youths on controverted points, of either theory or practice. The discussion of extreme thin seeding, and the comparative merits of particular breeds of stock, are subjects little adapted to a mere learner of the A B C of farming.

The character of the College has always been more or less measured by the supposed success or otherwise of the farm, and of the teaching connected therewith. When it was first started many farmers took up the notion that the College was intended to teach them how little they knew, or, at least, that the pupils would there hear much that reflected upon them. The method of teaching as pursued at first did not quite dispel prejudice against the College, neither has it been entirely removed up to the present time. A farm is an object which cannot be hidden or put to one side, when everything does not



please the public eye; therefore, when the College was first started, the farm had to be put to rights by the removal of old fences, the erection of new fences, the making of roads, the cleaning of the land; and, in addition, the erecting of new farm buildings. I did not happen to see the College in its very earliest stage, but I can easily judge that we ought to make great allowances for some disorder during the transition state, though these points were undoubtedly seized upon as an evidence of failure by those who considered their old practices *more money-making* than the proceedings of the College.

There was also a well-meant attempt at familiarising students with the different breeds of cattle, horses, sheep, and pigs, by keeping them upon the farm. Field-experiments were also undertaken. These practices caused a very heavy expense during the first few years of the College career, which has told against it in every respect up to the present day.

It is but fair to state these matters, and to remember that the Cirencester College was like a pioneer in a new country where few find a good path to guide them. Moreover many people are not aware of the enormous cost which is incurred in converting a farm out of order into a model one. The farms of many noblemen, which are thought very highly of for their neatness of appearance and the fulness of their crops, have cost as much money in improvements as the College Farm, if not more. In the one case, the public know nothing of the quiet outlay; whilst, in the other, rumours of debt get abroad, which, in relation to man or institution, must always be damaging. After all, I think the College with its farm is well adapted for affording a finished agricultural education to the higher classes; and if it were well supported by landed proprietors for the education of their sons who would have to do with land in after life, it might surely answer the purpose of the directors to have some classical professors attached to the educational staff.

A farm connected with a college or school need not necessarily be experimental. There are so many people with ample means and time to try any new plants, systems of cultivation, manuring, &c., that it is altogether out of the question to attempt to try every novelty on *one* farm. There are many professed botanists and geologists in the kingdom, many botanic gardens and private collections of plants, &c.; by these means every new plant may be tried and tested before the farmer need trouble himself about them. Gentlemen who can afford themselves a long college career and the aid of special tutors, may learn a great deal as a source of amusement, or to obtain distinction in examinations, which the farmer's son cannot aspire to; but I must again protest against the cram-system which tries to put

science upon science into a boy's head until it is utterly bewildered. After all, I have no doubt that many students at Cirencester have learned much before leaving the College, but many more might have profited, and to a greater extent, if before they were entered they had *learned how to learn*. The establishment has not hitherto been successful in a financial point of view, for reasons, some of which have been alluded to. The teaching, however, may be just as good as if the College were paying a large dividend, although the result would not conduce to the establishment of institutions of a similar kind from which shareholders, as a rule, would expect some interest for their money.

Where farms are attached to schools or colleges they should be managed by a rent-paying farmer, farming in the same manner as others who must live by their farms. I can scarcely see how any mode of farming can be called good unless it pays, let the crops or stock be what they may.

It is a mistake to suppose that young men can learn the practice of farming by a few minutes' work now and then, or that they can, under any circumstances, learn the *practice* of marketing on a school-farm. Instead of working-pupils being of any actual use, they are more frequently a very great hinderance to the regularity of the various operations of a farm which are being carried on by the regular labourers.

The Glasnevin Training School in Ireland, where the boys work a good deal, is not nearly self-supporting, notwithstanding that the labour of the pupils is valued at from 150*l.* to 200*l.* a year. The crops have generally been very good; still the whole concern does not pay.

There is at Limerick a branch Model Farm in connexion with Glasnevin, where all the pupils receive education almost gratis, some entirely so. There are buildings enough for 60 resident pupils. So late as January, 1865, there were only 7 in-door pupils, although gratuitous education and board would be afforded by the National Board of Ireland for 11 pupils! Such a state of affairs as this affords but little encouragement to the establishment of more such schools, in *some* districts at least. Farming in Ireland for some years past has been rather flat, so that some farmers could not spare the labour of a son of 17 years of age, even though he might be boarded and educated for nothing!

*Glasnevin School* and its branches have, however, done a great deal of good to those who have attended them for some time, and probably, in a national point of view, the outlay incurred in sending out good practical farmers and land-stewards will be much more than repaid by improved farming and the force of example upon others.

There are many persons who say it is altogether wrong to aim at making a school-farm pay; that it should be a place where the best methods of agriculture are in practice, and where the best class of stock is kept, but that profit should be kept entirely out of sight. To my mind, this is like leaving out the part of Hamlet, and I think that most farmers agree with me. There is certainly some ground for saying that good methods of cultivation may be taught to an apprentice taking part in them, although his part of the labour is a loss. It might be of service to him to build a corn-stack which would not stand a day, or if it did, might require so much labour in propping that the cost would have been less if the apprentice had been idle. Still I cannot see how the best farming—the so-called best farming—should cause a loss, if the pupils were drilled thoroughly and well, and under such supervision as ordinary labourers are. Here, however, lies the difficulty. Farmers' sons will not bear the same kind of *ruling* as those who must live entirely by their labour; and without good discipline and good order there can be no profit either on a farm or elsewhere.

In Huntingdonshire nearly 20 years ago an agricultural school with some land attached to it, was started for those intending to become farmers. A good English education was taught, with a little mathematics, and practical land-surveying. By the aid of local subscriptions the school went on fairly for a time, but not being self-supporting it fell off, and when I last heard of it, was nearly extinct. The school-fees were too low in the first instance, and had to be raised afterwards; this is in itself a great obstacle to ultimate success. In this instance theory combined with practice did not succeed.

In Herefordshire, some years ago, a gentleman farmer boarded, lodged, and educated a number of boys, who paid for these advantages by merely working upon the farm. When started this plan did not pay, but it was supposed it might do so after a time. This expectation has not, however, been realised.

I do not mention these instances of failure in a financial point of view, for the purpose of condemning the combination of instruction in agriculture with general education; but for the information of persons who, not having heard the results of attempts already made to unite learning and working, are over-sanguine of success from such efforts.

To the Rev. J. L. Brereton, Prebendary of Exeter Cathedral, Devonshire and the adjoining counties are much indebted for the establishment of a very good school suited to the wants of farmers' sons and the middle-classes generally; many others have given substantial support, but Mr. Brereton has pulled the

labouring oar. The Devon County School was very nearly self-supporting in 1864, and is expected to be quite so in 1865. Mr. Brereton contemplates a school and farm combined, with a scale of fees graduated according as the pupil works part of the day or not. Those who do not work would be charged 45*l.* a year; those who work on the farm 7 hours a day, 10*l.* a year. This scale *appears* to value the labour of a pupil at 35*l.* a year; but this is not exactly the right way to state the matter, as the richer scholars may prefer not to work and so to some extent help those who are poorer. If this half-time system could be carried out it would be a very good one; but I rather fear it would not be a self-supporting scheme. Any gentleman of considerable personal influence, by contributing both time and money, and thus setting an example, may start almost any feasible scheme; but it frequently happens that after being started, when both the money and the enthusiasm begin to flag, the scheme also fails, unless at the outset it is based on sound self-supporting principles which do not require the constant watchfulness of the *first* promoter.

Middle-class education is now a subject of general interest, and those who require education for their families make their voices heard. I have no doubt whatever but that a small school for farmers' sons might be started here and there if a general local move were made in the matter; but it appears to me advisable for us to have some uniform system for the whole country to go by in the first instance, and the Royal Agricultural Society is by its influence well adapted for promoting a general scheme. If some few persons were appointed by the Society to travel for a time to consult with the chief land-proprietors of every county, and to make the Royal Agricultural Society's ideas on the subject known amongst farmers and others, abstracts of information might be prepared and duly considered in Council before a definite prospectus was issued to the public.

I have a very high opinion of the persevering industry of farmers generally, but it is useless to contend that they have had such an education as the middle-classes in towns. The latter have great advantages in a greater choice of schools, without the daily expense and trouble of providing a conveyance to take the children to school, the cost of which, for one or two boys (at the distance, say only of six miles) is quite equal to the extra expense of a distant boarding-school. While farmers live on their land there will always be some drawbacks to the attendance of their children at the school even of the town nearest at hand. Farmers are not naturally more obtuse than other classes; but it is harder

for them to obtain education at a cheap rate, or to find opportunities for meeting together to discuss matters of common interest, or attend lectures, &c., for intellectual improvement.

Some farmers set less store by education, because they see that some highly educated men are unsuccessful in business; or rather, this affords them a certain excuse for continuing ignorant of book-learning. Undoubtedly both the educated and the uneducated fail at times; it is not, however, the education which is to blame, but some defect in another quarter,—the want of practical experience, of sufficient capital, of sufficient attention to business, expensive habits, want of knowledge of, or attention to the peculiarities of the district. If scientific hobbies are carried to a great extent to the neglect of that which is undoubtedly practical and paying; if an enthusiastic entomologist should run about catching bees and butterflies half the day, and using the microscope the other half to see that,

“Bigger flies have little flies  
Upon their backs to bite ’em;  
And little flies have lesser flies,  
And so *ad infinitum*”—

much greater misfortunes than one fly biting another may ensue, but it is hardly fair to lay them to the charge of education, and especially of a sound general education.

Upon the whole, whilst admitting the great value of school learning up to a certain age, I am inclined to think that any one intending to become a farmer should learn the practical part upon a farm when sixteen or seventeen, instead of continuing at school or college till twenty-one or twenty-two years of age, even if the expense were of no consideration. What theoretical knowledge may be gained by protracted schooling might be outweighed by loss of practical experience. One might as soon expect to learn to be a practical sailor at school as there to learn practical farming. Education is never of course complete; both at school and in after life every one must, to a great extent, educate himself. The greater part of schooling consists in learning rules, and getting hold of keys to unlock the stores of knowledge contained in both books and men, for living teachers are more ready directors than dead books.

An agricultural pupil, whether learning on his father’s, or any other farm, should keep a daily journal of every operation which he sees carried out, or even if working elsewhere himself, should get information and carefully note it down—a register of the weather, the quantities of seed sown of various kinds, how the live stock thrive, an estimate of crops, and anything that can be of any likely service afterwards. The keeping of

such accounts fixes things upon the mind, induces habits of observation, and keeps the hand and head in some kind of training. If this appear to some to be only useless trouble, I can only say, that without it young men may remain for years upon a farm, and really learn scarcely a single thing; many have found out this afterwards and regretted it. Working with the hands is a very suitable method of learning a good deal of farming. Unless a learner has a pretty large fortune to start business with, after serving an apprenticeship, he should do some work; if he does not he will never be really practical, and consequently will just require a larger fortune to enable him to bear greater losses, or to be satisfied with a smaller profit than a thoroughly practical man, who had less means to start with. Besides an idle youth, with a horse to gallop about the country frequently gets into scrapes, and there is always a risk that Satan will find mischief for idle hands to do; he had better work, or if idle had better walk—a walking-pace is quite fast enough for getting into scrapes. It is a good plan for farmers to exchange sons to serve an apprenticeship.

A farm out of order and in course of being put into order, is the best in general to learn farming upon. Some who attempt to learn how to farm on their own account, by going to highly cultivated park-farms, and such like, may be at fault when set to bring a sour, undrained, unlevel, foul farm into a good state of cultivation.

However, the cultivation of the mind stands first, and I do sincerely hope that as union is strength, landowners, farmers, and all others interested, specially and generally, may be able to start a good set of schools for the future generation of farmers, who ought to have as much mental training as the members of other middle-class professions, now so eagerly striving after scholastic improvement. The subject of education is endless, therefore without entering into more details I shall conclude with Cowper's lines:—

“To follow foolish precedents, and wink  
 With both our eyes, is easier than to think;  
 And such an age as ours balks no expense,  
 Except of caution, and of common sense;  
 Else such notorious fact, and proof so plain  
 Would turn our steps into a wiser train.”

*Burcott Lodge, February, 1865.*

---

II. — *Middle-Class Education, with special reference to our Grammar Schools.* By the Rev. LEWIS EVANS.

EDUCATION is one of the leading questions of the day. To show what importance the subject has attained, and how gradually but surely it has risen to this importance, we have only to review the history of the last thirty years, and direct our attention to two or three leading facts. The first and most gratifying is the great increase in the number of educated persons in this country during that period. The next is the large and rapidly increasing grants of the public money made for educational purposes. Last, and not least, the interest excited by the several Royal Commissions issued to inquire into the existing state of our most important institutions for the promotion of education.

If we look into these three points in detail, we shall find, with regard to the first, that, from a recent report of the Registrar-General, 32·7 per cent. of the male minors who married in 1841 were obliged to sign the register with *marks*. This proportion diminished year by year, till 1862, when the percentage was 23·7. Among women, in 1841, 48·8 per cent. of minors could not write their names: in 1862 the percentage was only 28·5. In other words, during twenty years, from 1842 to 1862, the proportion of men who can write has risen from being only two-thirds to be three-fourths; and of women, from being one-half to be nearly two-thirds: or, we may put it thus, that where four persons had to “make their mark” then, there are only three now.

With respect to the second point, it appears that in 1840 the parliamentary grant for public education amounted to 30,000*l.*; in 1850 it rose to 180,110*l.*; in 1862 to 774,743*l.* From the Report laid before Parliament in 1863 with the Estimates, it appears that the grants for education from the public expenditure, from 1839 to December, 1862, amounted to 6,710,862*l.* 14*s.* 10*d.*

As to the third point, we may simply remark, that the ‘Report’ recently published on the Public Schools of England, has not only been the universal topic of conversation and discussion, but there is not a single periodical, possessing even a very moderate amount of circulation, that has not made it the subject of a special review.

The subject of education, then, having excited such general interest, it is a very striking fact that this great educational development is confined to *one* class alone, and is mainly, if not solely, due to the fostering care bestowed on the primary schools.

With regard to the great public institutions of the country, the benefits of which are manifestly limited to a small class, we

may fairly say, without any undue disparagement, that the Report of the Commissioners shows that they have not kept pace with the general advance of education among the lower orders. If, however, those for whose benefit they are especially designed are satisfied with the amount of intellectual and moral culture there obtainable, the question ceases to be of much practical importance to those who have neither the desire nor the means to participate in those advantages. Between these two extremes lies the great middle class, composed of men who are becoming daily more and more sensible of the inefficiency of the existing means of providing education for their children, and more alive to the importance of providing such means as shall enable them to "hold their own" in the great struggle of life.

Of this great middle class (without regard to any other consideration than that of numbers) no section is of as great importance as that which is connected with agriculture; and for this large body of persons there are at present no adequate means of education provided. Let us briefly look at the question in a *practical* point of view. One great cause—we may say the vital cause—of this deficiency has arisen from education not being duly appreciated by that class. What men have never had, they never feel the want of. The higher classes, so far as they have reaped the advantages of a good education, take every care that their children shall share the same. Those for whom they can and do legislate they take care to provide in a proportionate degree with similar advantages. But the middle classes cannot and *will* not be legislated for; and in most instances have been hitherto quite satisfied if the modicum of education which they have themselves received continue to be doled out to their children.

It is true of course that there is a gradually increasing feeling among the middle classes that something better should be provided for their offspring, and that a few noble efforts have been made in order to attain that end; but is it not a fact that the feeling of this deficiency has come upon them from without, rather than arisen spontaneously within their own body? This remark especially applies to the agricultural middle classes. As a rule, farmers are not "speculative" men. They are hardly, in the truest sense of the word, "men of business;" their isolated lives, and the nature of the subjects which generally occupy their minds are not conducive to united action either for social or political objects.

But the education of the agricultural section of the community cannot be advantageously severed from that of others occupying the same social position; let us therefore look to these few practical points, under which the general subject of middle class education may be regarded:—



i. The means existing at present for the education of the middle classes in England.

ii. The means adopted in other countries of Europe for supplying any deficiency.

iii. The schemes that have been started for a similar purpose in England.

iv. And conclude with a practical suggestion for, at the least, a partial remedy of the acknowledged evil.

I. As a general rule, our middle classes have been compelled practically to rest contented with what are called "commercial schools"—speculations conducted by teachers of very varied qualifications, but too often the last resource of an ill-educated man, who had failed in every mercantile pursuit in which he had previously embarked. This may seem a hard saying, but those who are best qualified to judge will admit that the statement is not overdrawn.

II. What methods have been adopted in foreign countries for providing means of education for the middle classes? Let us first take the five great powers of Europe:—

1. In *England* we may at once confess that nothing has of late been done.

2. In *France* we have one most important fact—there is a Minister of Public Instruction. Moreover, it appears from the Returns of October, 1863, that there were 82,135 establishments of primary instruction (being an increase of 16,136 since 1848); out of this number 41,426 were public and free schools, where subjects adapted to the requirements of the middle classes are especially taught. During this period (1848-1863) the number of scholars had increased by nearly a million. The sum voted in July, 1862, to the Ministry of Public Instruction amounted to 2,548,178*l*.

3. In *Austria* there is no Minister of Public Instruction; but, in 1857, there were 442 middle schools (exclusive of military, national, and superior schools), with 4500 professors and teachers attached to them, and an attendance of 72,646 scholars. We may observe by the way that more than two-thirds of the population of Austria are engaged in husbandry, the total population, in 1862, being computed at 35,795,000.

4. In *Russia* there is a Minister of Public Instruction; and, according to his official Report, in 1860, there were in the whole empire 8937 schools, with 950,002 pupils, giving one pupil to every seventy-seven inhabitants. The grants from Government to these schools amount annually to 593,832*l*. The division of the schools into "elementary schools," "gymnasias," and "Lycæa," seems to correspond with that in Germany. The "subjects,"

“courses of study,” and “examinations to be passed,” are all fixed by Government. In these schools the requirements of the middle classes are amply satisfied.

In *Prussia* we shall find a very superior order of things. Here again the agricultural element forms a very large portion of the population; out of 18,500,000 of inhabitants, about 8,500,000 being employed in agriculture as their sole or chief occupation.

There is not only a Minister of Public Instruction, but also a Minister of Agriculture.

The educational system is the most complete in Europe; education is compulsory on all classes from the ages of six to fourteen. Every parent being compelled to give satisfactory proof that, if his child does not attend one of the state schools, he is receiving a proper education either at home or in some private seminary.

In every province the public schools are under the superintendence of a board of education appointed by Government.

In 1861, according to the official returns, there were 23,859 Protestants, and 9895 Roman Catholic elementary schools.

The number of children between six and fourteen amounted to more than 3,500,000, and of these nearly 3,000,000 attended the public schools. In the same year there were gymnasia, or higher schools, with 39,737 pupils, and 1823 professors and teachers.

In all these schools, the fees for education are exceedingly moderate, and the children of all who are unable to pay these, are instructed gratuitously at the expense of the State.

Such is the provision made for middle class education in the five great powers of Europe.

As to the other countries, we find that,

In *Denmark*, there is a Minister of Instruction and Ecclesiastical Affairs. Education is also compulsory from the age of seven to fourteen; there are 4000 parochial schools with gratuitous education, and all the considerable towns have their normal schools, academies, and grammar schools.

In *Belgium* there is no Minister of Instruction. Education, which under the Dutch Government was compulsory on all classes, ceased to be so after the revolution of 1830. About 9000 persons, however, seem now to be employed in public instruction.

In the *Netherlands* the Minister of the Interior superintends the public education. There are dependent on him an Inspector-General, with a staff of 70 school inspectors, whose duty it is to inspect the public schools, of which there were, in 1857, 2478.

The attendance on these schools was one in eight of the entire population, about 3,000,000. Besides these public schools there are 944 higher educational establishments.

In *Greece* there were, in 1852, 936 schools, public and private, costing the State 26,772*l.* King Otho established an Agricultural School at Tiryns, but it proved a failure.

One-seventh only of the area of Greece is under cultivation.

In *Italy*, according to the official returns in 1863, the population is computed at nearly 22,000,000. But this must be considered as only an approximation to the truth. There is a Minister of Public Instruction, and also a Minister of Commerce, Industry, and Agriculture. Great efforts have been made in the cause of education, and most favourable results may be anticipated. Great part of the property confiscated from the Monastic establishments has been devoted to public education; and in addition to this a sum of 600,000*l.* is annually voted by the Parliament. Since 1860, 33 great model schools have been opened.

In *Portugal* public instruction is superintended by the Secretary of State for the Home Department. Under him there is a Superior Council of Education, which holds its sittings at Coimbra, which is the seat of a university, founded A.D. 1290.

Public education is free from the supervision and control of the Church. By a law, passed in 1844, education was made compulsory, but the law does not seem to be strictly enforced. In 1854 there were 1200 public schools; in 1861, 1788. The average attendance in 1862, being one scholar to every thirty-six inhabitants.

To return to some of the smaller German States.

In the Grand Duchy of *Baden* education is made compulsory on all classes, and the penalties for non-compliance are strictly enforced. In 1861 there was one school for every 530 of the population.

In *Bavaria* there is a Minister of Education and Ecclesiastical Affairs. Education is compulsory on all classes to the age of 14. There are "Volks-schulen" in all parishes. In 1861 there were 7126 schools, with 8205 teachers. The annual cost to the state is 96,000*l.* Out of every 1000 persons 679 are employed in Agriculture.

In *Saxony* also there is a Minister of Education and Ecclesiastical Affairs. By a law of 1835 attendance at some place of education is compulsory on all classes; 95 out of every 100 being in actual attendance.

*Hanover* has also a Minister of Education and Ecclesiastical Affairs. In 1861 there were 4781 schools; primary, secondary, elementary and industrial.

In *Wurtemberg* also education is under the supervision of a Minister of Education and Ecclesiastical Affairs. In 1840, besides classical seminaries, there were 2500 elementary schools, and to the honour of this little country it is stated that in that year there was no single individual of the inhabitants above the age of 10 unable to read and write.

The above statement will abundantly show how thoroughly, in other countries of Europe, the education of the middle classes, as well as that of the higher and lower, is provided for and secured by the State.\*

On a general review of this part of the subject it would seem quite clear that *theoretically* the whole question admits of a very simple solution, viz., that the State should provide schools, teachers, and funds, and make education compulsory.

There is only one objection to such a scheme, but it is a fatal one;—it is simply *not practicable*.

It would be looked upon with a jealous eye, as an interference with the liberty of the subject. The middle classes would not submit to be, as it were, pauperised, by receiving State assistance, and the State would not grant the assistance, without retaining to itself the right of inspection and supervision; and, lastly, apart from political questions, there would immediately arise the one great difficulty, insuperable in this country, the *religious* element.

Does, then, the problem admit of no—even partial—solution, or are there in this country any means that could be made available for the purpose, unaccompanied by the drawbacks at which I have hinted?

I should answer, simply, there are institutions existing already, which, with such modifications from State intervention as we may hope will result from the Commission recently issued, would go a very long way to supply the existing defects. I refer to the Endowed Grammar Schools of England; these may be put down in round numbers as at least 700.† They are scattered in nearly equal proportions through the various counties of England, and without any violent changes in their present constitution, they might in a very great measure be made to carry out the object proposed. It is pretty clear that such was their original design, and if so, that their founders, could they be recalled to life, would gladly consent to such modifications as would adapt them to the requirements of the present age.

\* All allusions to universities and the higher order of schools have been purposely omitted.

† Including those foundations which are very small, and would not fall under consideration, there are said to be about 2000.

The means, then, being to a certain degree ready to our hands, let us see how they might be made available.

To show what might be done with endowed grammar schools, perhaps the best practical course will be to state briefly what in some instances has been done. I will therefore describe a system which has been carried out in one grammar school with which I am connected, and adopted as a model by several other schools of a similar kind.

On my first appointment to that school, about fourteen years ago, I found that practically it had sunk to the lowest possible ebb. The school was represented by a commercial school of the character which I have above described. The system of education was barely equal to that of the worst kind of parochial school; it was two centuries at least behind the age, and utterly unsuited to the neighbourhood.

The first thing to be done, then, was to make the study of the dead languages compulsory on no boy whose destination in life was to be purely commercial or agricultural. The next step was to introduce a large element of purely English instruction. English grammar, English history, and some acquaintance with English literature, together with a large amount of arithmetic, were made the staple subjects of teaching, and were taught to all boys.

The study of modern languages was next encouraged in every possible way by offering numerous prizes for proficiency, and by reducing the rates of payment to the smallest possible sum. Shortly after, a master was added to the staff for the especial purpose of teaching the elements of natural science. Particular attention was paid to chemistry as applied to the useful arts, manufactures, and agriculture; and a laboratory was constructed, with every convenience for enabling boys to carry out practically the lessons they had learned theoretically, particularly with regard to agricultural chemistry and the analysis of soils, manures, &c.

In addition to these subjects, book-keeping was taught thoroughly, as also land measuring. "Practical classes" were also formed of senior boys, who, under the superintendence of the natural-philosophy master, went out and measured with their own hands all the land in the immediate neighbourhood of the school. The accuracy to which this class attained in a short time was surprising, and many of the neighbouring farmers availed themselves of the services of the boys, for the purpose of ascertaining the area of lands in their holding, which had before been doubtful or disputed. The "mapping out" of these surveys was afterwards most carefully executed.

Such a system of education, at a very trifling cost, seems to

me to combine most of the elements of which middle class education ought to consist. All this was, of course, the work of time, and required a great struggle and much self-sacrifice, so that, if all connected with the school had not had their heart and soul in it, the plan could not have been carried out; but trustees, masters, and boys all combined heartily, and the result was a successful one.

But the very difficulties we had to encounter only tend to show how practical the scheme is. The funds of the school were too limited, and the endowment for the mastership too small to allow the necessary outlay to proceed from either the funds of the trust or the pocket of the head master. While the scheme, therefore, was still only an experiment (*i. e.* for three years) the funds necessary for the payment of the natural-philosophy master were most liberally provided by contributions from the neighbouring noblemen and gentlemen. At the expiration of that term the experiment was pronounced to be successful. The numbers of the school had risen to above 100, and, in spite of many drawbacks, the average attendance for the last six years has amounted to 94. To meet the additional payments required, a small capitation-fee was charged on all boys whose parents were not resident within the limits of the townships which have the right of free admission to the school.

The proficiency of the boys in all other branches of study, as tested by yearly public examinations, has proved that the system introduced has not interfered with the general efficiency of the school with regard to those subjects which are generally made the primary objects of grammar-school education.

No better proof of the practical working of the system can be given than the fact that we are constantly applied to by the trustees and headmasters of other schools for information (in all cases readily given) as to our system of working, time-table, &c., and for the services of our masters in testing by examination the proficiency of their pupils who have been trained in a method borrowed from our own. The time-table would show how very slight a "bifurcation" is necessary in this scheme of instruction, would indicate the subject taught, and the time which is, on the average, necessary to be bestowed on each subject to ensure the attainment of a good practical knowledge of its rudiments as an introduction to the active pursuits of after life. Enough has perhaps been said to show that this scheme is not a crude theory, but the result of real working and the practical experience of years.

What we have done other grammar schools might do—we may almost venture to say ought to do, and most of them may do, with far fewer difficulties than we have had to surmount. And if,

as has been said, we have 700 such institutions existing through the length and breadth of the land, we may fairly hope that, with a proper amount of intervention on the part of the State and a fixed honest purpose to carry out the intentions of the original founders, in the spirit if not in the letter, something approximating to a satisfactory solution may be given to the important question of middle class education.

For, up to the present time, what has been done to supply this acknowledged want? No general system has been pursued, no comprehensive plan even suggested, that would in any sense grapple with the difficulty. A few isolated efforts have been made, and what do they amount to? Let us glance at a few of them.

The Agricultural College of Cirencester, of course, first deserves our notice. Noble institution as it is, it cannot in any sense be considered as exactly suited to the object we are now considering. The instruction given is only adapted to more advanced pupils: indeed it commences at a point to which, as a rule, the youth of the middle classes hardly attain before they have finished their education. The rates of payment are also too high for our object, and its position not sufficiently central. With every good wish, therefore, for its success, we may dismiss it with this brief notice.

The educational establishment at Shoreham, with its adjuncts, though intended to embrace a much larger section of the middle classes, and though free from the faults just mentioned, has yet one vital defect—it is so unmistakably identified with particular religious views, that it will be regarded with somewhat of jealousy by all who do not share those peculiarities, and consequently it can hardly become a national institution.

The Agricultural School in Surrey, Prince Albert's School in Suffolk, and especially that at South Molton, though fostered by wealthy and powerful patrons, for that very reason are not such as can be offered as general objects of imitation; though, in one sense, model schools they can be looked upon at present only as successful experiments, of which time alone can prove the practical utility.

The schools established by the "commercial travellers" for the education of their children are too exclusive in their principle and too restricted in their operation to serve as a model for our imitation.

The specious scheme of "perambulating teachers," proposed with the noblest intentions by one of the most enlightened and benevolent of her sex, appears to be open to this strong objection, *in limine, i. e.*, that it would (or might) provide *instruction* without *education*.

The moral training, the cultivation of habits of order, discipline, and punctuality—the creation of a sort of *esprit de corps*, which are the very life and soul of our most celebrated schools and colleges—would in this case be absolutely thrown into the background. Apart from other difficulties, which it would be ungracious to suggest, this one consideration appears to me to decide the whole question.

Let us, then, briefly sum up the advantages that would arise from the adoption of the plan suggested:—

1. That the requisite machinery is actually *in existence*, ready to our hand, and requires only a slight modification to render it generally available.

2. That it is *systematic*, and might be made to provide education on a comprehensive plan throughout the country, and that as such it would go far to supersede those isolated and commercial schools, which are the bane of the middle classes.

3. That as support would not be derived directly from the State, the good old English feeling of independence and self-reliance would still be maintained, all necessity for Government interference and inspection avoided, as well as the manifest injustice of taxing the whole community for the benefit of one special class. By the imposition of a small capitation fee, the schools may in any case be made self-supporting, so far as any extra machinery in the shape of additional masters is required.

4. That an education approximating and analogous to the great system of public-school education (which for the classes to whom it is confined is confessedly the best for moral, physical, and intellectual training) may be secured to the middle classes.

5. That from the intervention of the State as a Visitor, rather than an organiser and legislator, the whole “religious difficulty” may be surmounted and the necessity of State inspection may be obviated by making general what is now not uncommon, *i. e.*, the employment of examiners from the Universities to test periodically the efficiency of the schools.

6. That the children of the middle classes would no longer be educated in *exclusive* seminaries, but mix with and be trained along with others of their own age, and undoubtedly be improved in every way by associating on equal terms with some of those who in social position may be somewhat their superiors.

7. That this plan is surely better than that of extending *upwards from below* the system already provided for the education of the lowest classes.

Lastly, as a corollary to all these advantages, the great existing difficulty of providing efficiently trained masters for middle-class schools is obviated. These endowed classical schools, being already in the majority of instances under the direc-



tion and management of competent men, selected from those who have graduated at our Universities with credit, if not with distinction. Such a plan still leaves open the question of the desirableness of creating County Colleges for giving further instruction to such pupils as are able and desirous to receive more advanced information.

Such, then, are some of the advantages which it appears to me would result from the adoption of the scheme here proposed—a scheme which certainly meets many of the difficulties that beset this important question, and is based on practical experience. Therefore, with all humility, but at the same time with some confidence, I offer these suggestions to the consideration of the Royal Agricultural Society of England.

*Sandbach.*

---

III.—*Middle-Class Education, having reference to the Improvement of the Education of those who depend upon the Cultivation of the Soil for their Support.* By Rev. W. HOLT BEEVER, M.A., Oxon.

WHAT I write upon this subject will be based upon my experience in the management of a country grammar-school, mainly filled from the ranks of the middle classes; not a small proportion of the scholars being the sons of well-to-do farmers. Of the latter section several obtained high honours at Oxford, two (specially mentioned in the Report of Her Majesty's Commissioners to inquire into the management, &c., of certain Colleges and Schools, in 1864), having been University scholars as well as first-class men; another obtained his appointment to Woolwich from school, and is now an officer of high promise in the Royal Engineers; and another distinguished himself at Cirencester College. Moreover I have for some nine years had a farm of my own, and have been successful as an exhibitor of stock. I shall then at least not be drawing on my imagination in the sketch I shall commit to paper.

The charges at this school come pretty near the mark assigned by Mr. Edmunds (in his Lecture before the Central Farmers' Club, February, 1865), as the fair price for Middle-Class Education; that is to say, from twenty-five to forty guineas per annum were paid for Board, according to the "House," and ten guineas for tuition in Latin, French, German, English, Mathematics, and Drawing; Greek, Music, Dancing, Drill, and Singing, being "extras." Besides the Head-Master there were, for about sixty boys, two Assistant-Masters (Classical and Mathematical), Uni-

versity and Public School men; a Writing and Commercial Master; a Drawing Master (an artist who exhibits at the Academy); a French and German Master; all resident, with salaries guaranteed by the Head-Master; the teachers of music and dancing attended weekly.

My subject relates to Middle-Class Education, with special reference to the agricultural section of the community; but, after much consideration, I have come to the conclusion that, up to the age of fourteen, the education of the future farmer need not differ from that of others, and that even after that age the difference should be but slight, as I hope to show in detail.

The regular classical instruction given at the public schools I regard as given specially in preparation for the Universities, and consequently superfluous for the young farmer beyond a certain limit, although, up to that limit, the best education of any for all classes. The outdoor discipline of a public school is confessedly the most admirable training for any sphere of life, but such discipline is attainable at any large and well-officered establishment where proper confidence in youth is shown. The presence and example of superior masters, gentlemen of energy and high moral character, in the play-field as well as in the class-room, will raise the tone of feeling among the boys, if, from leading a secluded life at home, with none but inferiors at hand, any of them are at first wanting in refinement and consideration for the feelings of others. Of such masters there has been of late years, from a variety of causes, an abundant supply. They must be fairly paid, but this is the cheapest policy in the end, as the annals of many a college and school can testify. The cheap usher is a mainspring of vulgarity, and is too often given to low excesses, which rapidly infect his pupils.

The grand difficulty that besets a scheme for education at all points in a small school is not the consumption of time (for by a methodical adjustment of hours an intelligent master may impart to industrious pupils a surprising amount of knowledge), but the expense that is entailed by the engagement of adequate teachers; and this difficulty has been much increased of late in consequence of the general diminution in the number of the scholars who attend the smaller grammar schools. Several causes have led to this result:—

1. The facilities afforded by the railways to the local gentry for sending their sons to public schools, and the increase of such schools under the operation of the Limited Liability Act, and otherwise.

2. The increase of commercial academies professing to give the so-called Middle-Class Education.

3. The indifference of the farmers in the choice of a school,

and the prevalent feeling that grammar schools do not give the education which is required now-a-days, and that their mission has gone by.

It has, therefore, become difficult for the head-master of any school not well endowed and most centrally placed to hold his own at all. It seems impossible for the smaller grammar schools to compete with joint-stock education, unless they can be so remodelled that they may become the effective nuclei of large local establishments on the "Bifurcation" plan: that is, having two departments—one Classical and the other Modern—working side by side.

To determine what the required education is, let us run through the subjects taught in a good school, which adopts a comprehensive scheme of instruction, and consider which portions are essential or profitable to the farmer.

*Religious Instruction.*—The rule laid down for the Albert Middle-Class College, Suffolk, can hardly be improved, it is as follows:—"Religious instruction in accordance with the Doctrines and Practice of the Church of England. (N.B. Special exemption from distinctive Church-of-England teaching, and from Sunday attendance at the Parish Church or College Chapel will be granted to sons of Dissenters upon application to the Head-Master: the parents of such boys undertaking their care and management on the Sunday to the satisfaction of the Governors)."

*The Classics.*—Seeing that this study need occupy no time that can be required for any other learning, there is no good reason why the farmer who begins his education in time should not attain a certain fair proficiency therein. A wise man will ever after be thankful that he attained, when he did not feel the exertion, such an amount of classical knowledge at least as the professions of Medicine and Law demand.

I am glad to see that Latin figures on the prospectus of the Suffolk Middle-Class College. But I advocate further the introduction of Greek to a *certain point*, though of course I am content to be coughed down when I start this oft disputed question. Those only who are acquainted with the language can appreciate its value, at once as an instrument to train the mental faculties, and to throw light on the inmost shades of meaning in many a subtle word that figures daily in the leader of their morning paper. Contrary to the vulgar idea, Greek is a singularly easy language, and a very short study of it would effect the main purpose for which I advocate its introduction into every middle-class school, viz., for the purpose of etymology. With this view the Greek "Delectus," thoroughly taught, might answer every purpose, and this surely could not, in the eyes of the most bigotted, absorb much valuable time to the detriment of other studies.

In fact, as every schoolmaster will state, the difficulty is to find the English class enough to occupy their time with. This difficulty the purely commercial academy meets by the incessant reduplication of writing and ciphering, all the beneficial effect of which wearisome practice may be equally well attained in a few months under a more reasonable régime.

I have stated that to a certain point the instruction required is much the same for all, and that it is only after some progress has been made that teaching branches off to meet the special requirements of the various professions and spheres of life. This point may be reached at the age of twelve or fourteen, according to the pupil's natural talent, and thenceforth he that is intended for college will mainly devote his time to the study of the classics, yet granting some part to the attainment of modern language and science; while the commercial lad will distribute his day in the inverse proportions, making modern knowledge his primary aim, yet not altogether neglecting the classics. So might a far higher general tone of intellectual polish, a more extended mental sympathy, be diffused throughout society, whilst the peculiar acquirements of each profession were still respected, in accordance with its distinguishing type. I cannot admit that the intended farmer has at school no spare time for training of this sort. The simple fact is that the young agriculturist is usually of an idle sort as regards books, being given rather to out-door sport, in which he is too much encouraged by the injudicious remarks made at home. Granted that he cannot often expect, like a Burns, to express in touching verse the poetry of all the simple objects around him; or, like Ferguson, to take astronomical observations by the help of a slate-frame strung across with beads as he watches his flock by night; yet that which he can easily acquire may give him great additional grasp of mind, and gild many a tedious wintry or wet hour, such as Virgil suggests may be devoted to the sharpening of hurdle-stakes.

*French.*—To decide whether French be needful to the modern farmer, it may suffice to take a look at our show-yards, and remark the number of foreigners there present, and the extent of their purchases both of stock and machinery. Every child should acquire its difficult accent, and learn to converse with ease at as early an age as possible.

“I only speak,” said an accomplished traveller and linguist to me the other day, “with the inevitably bad pronunciation of one who began French at twenty-three.”

*German.*—For the same reason, though not to the same extent, would early instruction in German be of advantage.

*Mathematics.*—In this study the young farmer need not advance

beyond a certain limit. But it is essential he should be taught thus much, even if it be only to produce exactness of thought. He should be strictly trained in the elements of geometry and the laws and properties of matter. To go more into detail, he should in arithmetic be quite at home in the four first rules, vulgar and decimal fractions, proportion, extraction of square root, logarithms, and book-keeping, so far as it can be taught in schools.

Three times a week too he should be exercised in class (a practice that from the keen competition tends admirably to sharpen wits) in what is called *mental arithmetic* (M<sup>r</sup>Leod's handbooks are excellent) an accomplishment of great value in any walk of life, but especially for those to whom rapidity of calculation gives so much advantage in the market. In Algebra he should perfectly master simple equations, then have some little practice in quadratic equations, and get on to ratio, proportion, arithmetical and geometrical progression, permutations, combinations, interest. This need occupy no long period if the teacher be able and the pupil willing, but further it were needless to go, for here you leave the practical, which alone concerns us, and enter the realms of pure science.

Of *Euclid* all *gentlemen* should learn most thoroughly Books i. ii. iii. iv. It should be taught in class on a black-board, the teacher first going through the problem himself as he expects it to be said, then the next day calling upon his pupils to do the same. The tutor's going through it first I know to be a mighty help, that robs the volume of its horrors. After practice on the black-board the class should go down, and in the presence of the teacher carefully write out the proposition they have just taken up in class, the MSS. to be carefully supervised by the teacher and rewritten by the pupil. Then the next day when they take up their new lesson they should be called upon briefly and rapidly to indicate the key-point of each of these same propositions, not going, as on the first day, religiously through each ABC, DCF and GCH as they might by rote, but in just a dozen words pointing out the kernel of the problem. This is the best way to teach *Euclid*, rendering it thoroughly available for future practical purposes.

The elements of *mechanics*, *the laws of matter and motion*, *hydraulics*, &c., eminently useful as they are to every farmer, experience leads me to think can seldom be taught, even from Messrs. Chambers' nice handbooks, with profit to a lad under sixteen years of age, which I have fixed for the limit of the young farmer's school-days.

*Writing* is of course a *sine quâ non*; and our late distinguished Premier did much good by laying such emphatic stress on the

advantages of a good hand—preaching which he is said to have illustrated in practice. Beautiful handwriting is, as most teachers will testify, from some strange cause, an hereditary gift. There are some boys to whom its attainment costs nothing; there are others who could never acquire it, even by the most painful application. Still, generally speaking, there is much to be done in the way of improvement by a skilful teacher. Written impositions are sadly detrimental to a good style of handwriting. I should, for this reason mainly, recommend that all impositions be learned by heart, that they be well-selected passages, and be always said over again a month after they were due and first repeated. Then will punishment help to instruct: nor does my experience induce me to think that the same objection can be urged against such policy in schools as applies to prison discipline, where it is reported that the treadmill loses half its pain when used to grind corn, or do other such good service; the sting of the punishment being keener in proportion to the worthlessness of the work.

*English Grammar* is tedious and needless to anyone who has learnt the Latin Grammar.

The necessity of *Geography* and *History* it were superfluous to dilate upon. The amount taught of each will depend altogether on the teacher. A clever one needs no counsel: to the inefficient no hint would be of service. For all practical purposes I know no work so good as Cornwell's 'Geography,' and to Chambers' 'Handbooks on History' I must yield their fair meed of praise.

As regards *Composition*, we will speak first of its material aid, *Spelling to Dictation*. *Spelling* should be taught at a very early age at home by the mother or governess, when its first principles are acquired quite mechanically. We all know how puzzling it is to come to think how such and such a word is spelt. After ten, which is the earliest period at which a child should be sent to a regular boys' school, this branch of instruction will be continued by the method of dictation. I would here only suggest that the passages read out should not be taken at random, but carefully selected from choice authors, and that the pupil should subsequently say them by heart, and afterwards reproduce them on paper from memory. Thus, beyond the mere attainment of spelling, without effort, gradually and insensibly will be formed a habit (instinctive as the dropping on the right note in music) of clothing in appropriate garb each native thought as it rises in the mind; the pen learning to run on and to print each idea as it occurs, a performance which is at the very root of facile expression.

Perhaps the most successful plan of teaching composition and

spelling together to young beginners is to read out rapidly, but distinctly, a passage from an interesting volume of any first-rate Natural History—Yarrell's 'British Quadrupeds and Birds,' for instance—a description, say, of the mole, the swallow, the fox, the raven. It is essential that the subject be attractive to the class. Only the most picturesque and striking passages of the chapter should be read, the boys standing around in class. They then take their seats immediately beneath the master's eye, having an hour to employ, during which time they are expected to cover two sides of a large slate from their recollection of the matter they have just heard read to them; all original remarks being interdicted.

At the first they are extremely shy to begin, or thought refuses to flow; and you see the poor little fellow bend his head in agony upon his hands, as if in a vain attempt to squeeze out something from his vexed brains. But after a while a thaw sets in, and when they once begin, the allotted two sides of a slate are soon covered, after a fashion.

So far so good; but now for the grand improvement. Forbid the use of a single "and" or "also" throughout the whole exercise, and the effect is magical. The first essay in composition of any child will show at once how he depends upon these unhappy particles, the result being a medley of all sorts of thoughts linked together incongruously. Forbid their use, and he at once casts about, under considerable difficulty at first, for the best modes of breaking up and commencing his sentences. It is surprising how great a variety of endings and beginnings he will strike out, how terse and neat a style so formed will ultimately become. As a teacher I reckoned it a lucky hour when this expedient was hit upon, so great was the relief it gave me. Let any one give the plan a trial, and he will soon be convinced of its value.

There is an equally rapid and successful mode of teaching a boy to write an essay on any subject; which, however, it scarcely falls within my limits to describe.

*Drawing* is not only of eminent service to the officer and surgeon, but it improves the eye and taste of all. I do not advocate a child's beginning too young. Little boys, unless possessed of real artistic talent, only get wearied and disgusted by incessant practice in straight strokes and shading. Besides that, the drawing-class is too often the refuge of the idler. It is impossible for the master to do much with lads of this sort, while the annoyance they give the more delicately organised artist will unhinge the best temper, and prevent fair attention being given to the more industrious. The little idling vagabond knows well that

it is far easier to shirk work there than in the schoolroom. Affecting attention so long as the master is leaning over his shoulder, the minute after he will occupy himself with the nearest neighbour of his own stamp, telegraphing to him all sorts of mischief in a variety of ingenious ways; rubbing up a favourite marble and exhibiting it to public gaze; making crackers of his indianrubber; whittling his unhappy pencil, or bedaubing his fingers and paper with a lump of homemade toffy.

The future farmer need not begin drawing until about twelve or fourteen years of age, and two years ought to be an ample allowance of time for the attainment of such proficiency as he requires, for although his knowledge should be thorough to be of use, the extent required is small. He should be able to draw straight and curved lines with facility, and so as to make a simple sketch from nature. To mechanical drawing and the use of instruments he should pay considerable attention. Light and shade he should learn, and he should have some practice in isometrical projection. That small but excellent volume, the 'Illustrated London Drawing-Book,' includes all this. The tests should be practical, such as, "Produce the working drawings of a steam-engine;" "Draw a roller or waggon, with and without the help of instruments, and put them into shade;" "Draw isometrically a set of farm-buildings."

The great advantage of drawing, however, to the farmer is that the eye thereby learns to take in proportions accurately, to judge at a glance the distinctive features of two rival animals, or the number of square yards in a given space. In this last respect of course the study of geometry will be a further help; still, to be really skilful, he will require the two.

Too much time should not be spent in dawdling over finished specimens (to be taken home at the holidays), indebted too often for their telling touches to the master's pencil; for all that the young farmer need be taught is to sketch roughly, but effectively and quickly, say, an octagon or egg, to throw the same into shade, the light shifting as the master may direct, and further, to place them in parallel or oblique perspective. No more need be taught; all else that may be required fair practice will effect, due allowance being made for industry and genius.

But for an agricultural drawing-class I would have also studies of sheep, pigs, cows, and horses, in every posture—grazing, standing, lying down—drawn with skill, not in the artistic, but the *show-yard* point of view: some, too, without a feature to redeem them, as the drunken Helot, for contrast sake. The farm-yard animals "as they should be, and as they should not be" set forth, after the manner of Lawrence in his *Treatise on the Horse*,



should be studied by the pupil until he can point out in life as on paper the distinguishing excellences or defects of any animal presented for his criticism.

To lay a flat tint in water-colours is an easy accomplishment, which is useful in every sphere of life. Instruction in the few plain primary facts which relate to the theory of colours might be of service in preventing many a grotesque combination, as well in dress as in furniture, &c. But in this respect much will depend upon teacher and pupil.

*Pathology and Medicine* may be reserved for the Agricultural College, for, up to sixteen, those few boys who are gifted with a strong inborn taste for the dissection of birds and frogs, &c., would alone feel interest in the study; and one of these is more likely to turn out an Abernethy or a Buckland than a Jonas Webb. Even the knowledge of simple recipes, such as carbonate of soda with ginger, to be administered if frosted turnips or vetches have soured the lamb's stomach, or a solution of chloride of lime in case of hoove,—all suchlike lore, so quickly learnt when the youth is old enough to give it heed, belongs not to the period of marbles and hardbake.

*Geology, Botany, Chemistry, Physical Science, &c.*, may best be made the subject of clear pleasant evening lectures, with diagrams and experiments to illustrate the lecturer's remarks. Easy textbooks on these subjects might, however, be in use during school-hours, and prizes might be offered for the best portfolio of dried wild flowers and grasses (systematically arranged as to order and class), and the best cabinet of geological specimens collected in the neighbourhood; every boy being obliged so to exert himself as to show weekly a sufficient collection of some sort, or the competition would soon become too narrow. Pursuits of this sort give a charm to country walks, and are a bar to mischief. To ensure greater attention to the lecture than the fascination of the moment may elicit, questions should be set on the subject of each lecture at the quarterly examination.

Of *Fencing, Drill, Dancing, &c.*, I say nothing. Such accomplishments give grace and ease of manner, but are scarcely essential to success on the agricultural arena.

*Singing and Music.*—With our present social habits, and the increasing interest taken in the choir of almost every parish, it must be an advantage to the young farmer to be taught class-singing and music, as far as native ability allows. Every headmaster, on his part, must be thankful to have boys of a musical turn under his charge; a valuable centre for innocent amusement in a school is the youthful pianist.

For *Gardening* a taste may be encouraged during play-hours,

by giving each boy a plot for his amusement, it being imperative that the plot be fairly cultivated, for there are a number of boys who will shirk all labour whatever if they can. A small exhibition should be held, and prizes given, at the fitting season. Simple experiments with manures, superphosphate, dung, urine, oak-leaves, &c., may be made, all of which will leave in the mind a useful sediment of information for after life.

*Carpentering.*—Since, as Mr. Mechi truly says, so much of the farmer's prosperity depends upon an accumulation of small gains, and, I may add, the avoidance of unnecessary outlay, I would have him competent to direct and value the repairs of his implements, out-houses, &c. Something of this useful art the boys might be easily taught on wet half-holidays, when they are too apt to resort to the nearest public-house to drink on the sly, or to the boot-maker's to smoke; the axe, chisel, plane, and other simple tools may then be put into their hands. Accomplishments in the way of turning will follow of themselves. These labours should be superintended by a competent instructor who can maintain his authority—that is a vital point; for few things are more *demoralising* to a school, in the military sense of the word, than an instructor who fails to command attention. I have found by experience that the best disposed lads left to themselves in a carpenter's shop or turning-room too often do exceeding and thoughtless damage.

If a boy have his playtime so occupied, he must have some compensation when the rain has passed, or the result will be damaging to his disposition. It is then a good plan to substitute a boys' concert or an amusing lecture for the usual evening's work.

*Hours.*—I have seen and known all sorts of "hours" tried, but I never knew any plan that could surpass that which places the hardest head-work early in the day (before the intellectual edge is blunted, and the mental eye wearied by the multitude of images that cross it), and the most fagging days earliest in the week; so you rob the necessary labour of half its pain; the week slips away insensibly and pleasantly, leaving a heap of work done, of which the boy has scarcely felt the producing. I would have the school up and at work at half-past 6 o'clock in the morning, and the school day over at 3 P.M., when the boys should dine, having had bread and butter at half-past 12. So you dis sever work from play, each being in its own time most thorough. The system of intermixing the two throughout the whole day makes school hateful, and can be likened only to giving half a dose of medicine, which sadly sickens without producing the intended beneficial effect. Especially oppressive both to pupil and

teacher, and consequently unproductive, are heavy afternoon lessons following an early dinner. The early morning school prevents much moral mischief in the dormitories.

Reckoning classics and mathematics to be harder than English, French, and German, which in turn are harder than arithmetic and drawing, as these last rank before writing and dictation, I arranged my scheme of hours accordingly, and found it popular on trial both with masters and boys.

*School Management, Rules, &c.*—I apprehend from the terms of the thesis that our subject is limited to school teaching; I therefore pass by what might be a fruitful theme with the single remark that too much confidence (to be exhibited in a hundred ways) cannot be reposed in boys. The good feeling of the mass under a judicious management will always check and set right the vagaries and vicious propensities of the few. It is astonishing how soon a new fellow tones to the school. A black sheep detected, should of course be got rid of, if clearly incurable, as quickly, but as quietly as possible.

And now we have got to the limit of our subject. My conclusion is, that, all the young farmer need know, he can learn well at school by the time he is sixteen. If, having begun at a fair age, he has not done so, it would be perilous, in a moral point of view, both to himself and others, to leave him longer among little boys.

But after sixteen—what then? A few of the more ambitious might wish for the opportunity to push on in studies that are now just opening brightly on their view. But, as a rule, he who settles down as a boy to the idea of being a farmer, and nothing else, is not of an ambitious turn as regards study or intellectual improvement of any sort.

At sixteen, when the commercial class is leaving for the counting-house, the professional for the desk and surgery, what are we to do to fill up satisfactorily for the young agriculturist this most hazardous season? It is a time of life and a state of circumstances that present exceeding temptations to idleness and vicious courses. I cannot see, after much consideration, that at this age a lad can do better than go for a year's course to some such place as Cirencester College or Glasnevin, near Dublin.

Of course this implies capital and pecuniary advantage on the parent's part; but so does modern farming in itself. Moreover, the case will be materially altered if noble institutions like the Suffolk Middle-Class College spring up over the land, and, similarly to the grammar schools, be endowed with exhibitions, which, having already acted as a stimulus to exertion at school, shall help the less wealthy to a collegiate education.

To keep a lad of ordinary spirit steady at sixteen years of age,

he must have enough to occupy him, and he should be subjected to competition with other lads of his age. It is a dangerous plan to keep him about home. Few parents—I should say not one in a thousand—are capable even of managing, much less of teaching their sons, so as to ensure industry and improvement. The discipline of a collegiate establishment seems the only safeguard for the lad who is leaving a middle-class school, such as I have sketched. Having obtained his diploma at such a college as Cirencester, and being possessed of character and steady principles, he will, I conceive, now need only sufficient acreage and sufficient cash to float him.

Such an education as I have sketched may possibly be condemned by a few as being on a too ambitious scale; but, in drawing it up, I have had my eye on the successful career of two young lads, sons of farmers in my neighbourhood, who have been as distinguished for practical skill in agriculture as for other attainments.

It may not perhaps be appreciated by, or acceptable to indolent mediocrity, but it is such as the intelligent eager youth will jump at, and such as shall satisfy his every requirement as an agriculturist, although he will now have to compete, not as formerly with some few neighbouring parishes, not merely with all England, but with all the world—such an education as shall fit him most thoroughly to make the earth yield him her increase at least expense and with the most satisfaction to himself.

---

#### NOTES.

Having arranged and written down my own thoughts on the subject of Middle-Class Education, I then went through and made certain extracts from the official analysis of the evidence in the 'Report of Her Majesty's Commissioners appointed to inquire into the Revenues and Management of certain Colleges and Schools, and the studies pursued and instruction given therein' (1864), bearing upon various points which I have discussed. These extracts I append below.

*Scholarship may be secured by Economy of Time.*

Right Hon. Sir J. T. COLERIDGE.—“In a public-school system *education and instruction* should be *distinguished*: the best teaching is that of the classical languages: there is an absolute necessity of carrying on concurrently a considerable amount of special instruction: regards natural history, mathematics, and so on as essential: would add French or German and some amount of music and drawing. Would not try at Eton to make a perfect soldier, or a perfect doctor, or anything of the kind, but would bring the boy's mind into such a state that he should be more ready to embrace the more perfect knowledge which would be given him afterwards. Would make scholarship as perfect as possible, and carry on those other collateral branches of education by *economy of time* in the mode of teaching.”

*Difficulties of a "Modern" Education.*

Rev. G. G. BRADLEY, Marlborough.—“In answer to the question ‘How far is it possible to give a really good public school education on any other basis than that of instruction in the dead languages?’ I do not believe that we are at present in a position to answer the question finally and decidedly, for the experiment has not yet been fairly tried, but I may state briefly my own opinion. While I should deliberately prefer as the best education, when attainable, that mixture of careful study of the language and substance of the great writers of antiquity, with modern reading and mathematics, which I attempt to combine in my own teaching, yet I believe that a thoroughly sound education may be given, and at the same time the advantages of public-school life enjoyed by boys with whom for various reasons a different plan is pursued, a large space devoted to mathematics and science, and a thorough study of German and French substituted for classics. But the difficulties of working out this experiment are great,” &c.

*Cheap Masters are dear Burgains.*

Rev. Dr. TEMPLE, Rugby.—“We might have more masters by engaging at lower salaries. But this would be an improvement in one way at the cost of a serious damage in another. Good men cannot be got below a certain price. The work is very severe, and a man must have the means of saving money against the time when he can continue such work no longer. There is probably no employment which exhausts a man so thoroughly as teaching: and this is well known, and men will not enter on such a profession unless they have the prospect of providing for independence when retirement from work has become necessary. Moreover, to be a thoroughly good teacher requires a combination of many qualities: and the men who possess that combination are proportionably rare.”

*Greek an easy Language.*

Mr. CALVERT, Shrewsbury School.—“A son of a solicitor in Shrewsbury, intending his son for his own profession, placed him in the Non-Collegiate Class, where his progress in Latin was so great that by it alone he placed himself at the head of the Fifth Form: at witness’s suggestion the father then consented to the boy learning Greek, and in seven months, never having seen a Greek book before, he was able with a little preparation to construe a passage of the *Odyssey*. With Grammar and Dictionary he would probably in less than an hour construe a chance passage of thirty lines.”

*The English Form an Idle Form.*

Dr. KENNEDY, Shrewsbury.—“I think a few put themselves on the Non-Collegiate list merely from idleness. They are the idle boys of the school.”

Mr. CALVERT, Shrewsbury.—“The Non-Collegiate Class has a tendency to encourage indolence.”

Mr. BENTLEY, Shrewsbury.—“The Non-Collegiate Class established to meet the wants of those who do not send their sons to the University do *Latin* with the Class; but instead of Greek and Verses, extra modern languages and mathematics. They do not make more progress than the Collegiate boys, though they have four hours a week in modern languages against two hours of the Collegiate boys. It is joined by a class of boys who hope thereby to escape a portion of their regular form work—generally at the requirement of the parents.”

*Bifurcation System.*

Rev. E. BENSON, Wellington College.—The boys in working their way up the school follow one uniform course into which the *beginning of Greek* enters

until they reach the middle of the school. At this point a bifurcation takes place, and boys can pursue either the mathematical or the classical course. Latin remains their chief common ground, together with divinity, history, and modern languages. This, however, is not the point at which the clever 'Moderns' will usually divide from the others. It is suited for those who are backward or who are to leave school young. The more advanced now continue their Greek with a view to make it available in examinations; and as all the boys have four hours a week at mathematics, to which they can add two or three under a private tutor, there is time for them, if forward in mathematics, to continue longer in the classical division, and to join the mathematical divisions higher in the school."

Rev. R. ELWYN, Charter House.—"In the lower forms all the boys learn Latin, Greek, mathematics, history, and geography, and the greater number French. But when a boy has reached the fourth or any higher form if he is desirous of entering into any profession for which special examinations have to be passed, or for which the usual course of education in the school may not be specially adapted, he is allowed to leave off the study of Greek and verse composition, and to devote the time which he would otherwise have given to these subjects to mathematics, history, geography, &c. There are as has been already mentioned, drawing and chemistry classes for those who wish to study these subjects."

#### *The Classics.*

Rev. H. LATHAM, Trinity Hall, Cambridge.—"I have, after much consideration and some change of opinion, come to the decided conclusion that classics and mathematics are the best subjects to make the staple of education. I have found that boys from schools at which it was made an object to give *information* seldom recollected what they had learnt with sufficient accuracy to be able to rely on it for any practical purposes, and were generally deficient in the power of expressing their thoughts. In examining schools when there has been a modern department, I have usually found that the boys who had learnt *Latin and Greek* beat the boys in the other department in their *own subjects* (except perhaps in something purely technical, as drawing), and the impression was irresistible that the classical boys had received better cultivation and could use their faculties to better purpose."

G. B. AIRY, Esq., Astronomer Royal, although a "Mathematician by profession," cannot express the great importance which he attaches to the classics, and would not on any account disturb classical learning as the basis of English education at our great schools, but sees no difficulty but rather great advantage in superadding mathematics and good scientific knowledge.

Rev. C. EVANS, Rugby, in answer to Lord Clarendon:—"You say that having acquired a solid groundwork in Latin and Greek they might then be permitted to drop a certain portion of their classical work (say versification and Greek), and devote the time thus gained to mathematics principally, to physical science, history, and modern language, care being of course taken to guard against superficial smattering?" (Answer).—"That meets exactly what I think are the requirements of the age, and what parents now desire but know not how to achieve.

"A valuable mental education would be afforded by the prosecution of the study of mathematics or physical science, combined with a *groundwork of classics*. I should give the same education to all boys up to the average age, I think, of fifteen. Up to fourteen I think a boy's mind is not fitted for the prosecution of the study of physical science. I should make the education up to fourteen almost identical with the education a boy now gets up to that age—the staple being the classics, mathematics, and French. I do not propose in any case to drop Latin up to Horace, Livy, Virgil, Cicero: would drop Greek simply for the sake of the time spent on it."

Sir J. F. W. HERSCHELL.—“ I know it is a common idea that classical and mathematical proficiency are incompatible, and imply fundamentally different conditions of mind. This, however (except as regards the higher degrees of proficiency which go to render a man distinguished either as a scholar or a mathematician, and the proposition might be then extended to every other form of excellence), I disbelieve; I believe that a great mass of good mental power which might have become available to human progress, if duly fostered and developed, has thus hitherto been lost to the community.”

*Arithmetic.*

Dr. WHEWELL.—“ Practical mensuration should be taught at school. It would be a great advantage if the use of Logarithms were also taught. If arithmetic were already taught effectually at school, I should be disposed to add the use of Logarithms (I mean the practical use) as an art of great value for abridging laborious arithmetical operations.”

*On French Masters.*

Dr. MOBERLEY, Winchester.—“ Foreigners can seldom be found to manage and teach effectually classes of English boys who are not anxious to learn.”

Rev. C. B. SCOTT, Westminster.—“ The difficulty of working a French class efficiently is greatly enhanced by the fact that it is on many grounds desirable that the master should be French by birth; and that if so he is sure to find it a hard task to manage English boys. They constantly misunderstand each other, and neither the instruction nor the discipline is what it is at other times.”

Rev. G. G. BRADLEY, Marlborough.—“ In both departments (classical and modern) foreign languages are taught by Englishmen.”

Rev. E. W. BENSON, Wellington College.—“ One foreign master in each language is employed, and the system adopted with them is to put under them the *best* modern scholars and the *beginners* in each school, and to place under English masters those boys who from their state of progress require to be steadily worked in exercises, and construing after a classical manner, rather than to be practised in the nice polish of the language, or on the other hand to begin the rudiments of grammar and pronunciation. These appear to be the points in which foreign masters take pleasure and excel, and they have not the same difficulties of discipline with either of these two classes of pupils as with others. I cannot but be of opinion that if a school can include one Frenchman and one German on its staff for the purpose of correcting pronunciation and looking over the higher kinds of composition, and can then intrust the greater part of the French and German teaching to Englishmen who have had an University Education, and who having lived abroad are thoroughly versed in the foreign language which they undertake to teach, the work will be far more effectively done than by any other arrangement.”

MAX MÜLLER, Esq., Oxford.—“ I find as a general rule that fluency in speaking is never acquired at any public school whatever. Whenever I find fluency in speaking I can always trace it to an extraneous source. I think the experience of continental as well as English schools is against attempting to impart to schoolboys a conversational command of the language. To acquire fluency in the foreign languages, especially English and French, has been attempted at the Reale Schulen, not in the Gymnasia. One hour a week or a fortnight, devoted to the principles of comparative grammar, would be a saving of more than ten hours in teaching French and Latin.” Recommends that both French and German be taught in schools by *Englishmen* who have had opportunities, either by travel or by birth, of acquiring a fair knowledge of the

languages. "They should ground the boys, but there should be a French and German assistant under the supervision of the Englishman to read aloud to the boys, to dictate to them also, and to give them any facility for acquiring any exceptional knowledge of the language. Accent is very much an affair of ear." "Almost impossible to remove a bad accent once acquired." "I believe that a great deal of time might be saved in the teaching of French at public schools if it were grafted on the knowledge of Latin which most of the boys possess." "Goethe, in spite of his great partiality for physical science, I believe would have grudged every hour taken from *Greek and Latin* in the education of boys at school."

*Drawing.*

T. D. AGLAND, Esq.—"By drawing is meant such expression of linear form as may be learned by any one who can write: the cultivation of the artistic faculty, which is rare, is another question."

Right Hon. Sir J. T. COLERIDGE—"Thought it very desirable for boys to be instructed in drawing and music."

"I remember that a great many years ago now I was at Pestalozzi's Institute, when the old man was alive, and I brought away some of his copy-books and drawing-books, and it appeared to me that all the boys in that immense school were drawing figures, chairs, and tables, and so on, all drawing by perspective. He said he found everybody could do it. If it did not go beyond that the boy would still have acquired that which would be useful to him in after life."

*Little boys need not begin.*

Dr. HESSEY, Merchant Tailors.—"Drawing is taught in the school to the boys of the head, second, third, and fourth mathematical classes."

*Physical Sciences, &c.*

REPORT of the COMMISSIONERS on Rugby School ("the only one amongst those constituting the object of the present inquiry in which physical science is a regular part of the curriculum").—"We are of opinion therefore that boys even in the lower forms of the school may advantageously be permitted to receive school instruction in the elements of physical science. *Lectures* treating such topics as may be suitable to beginners, and handling them in such a considerate style of statement, explanation, and illustration as may divest them of unnecessary difficulty, will perhaps be a more wholesome and agreeable relief to the learning and application of grammar rules and to the technical working of arithmetic than any other studies, and will furnish a most salutary exercise of many faculties which at such an age are ripe for cultivation."

*Lectures on these subjects are recommended also by* Dr. WHEWELL and Professor FARADAY.

Professor OWEN.—"Would recommend every boy of a proper age, say about fifteen, to be compelled to listen to a course of lectures on Natural History, embracing Zoology, Botany, &c., one hour a week for six months," &c.



IV.—*The Management of Cattle.* By WILLIAM LITTLE.

## PRIZE ESSAY.

It is universally admitted that there is no subject connected with farm produce of more importance at the present day than the management of cattle. The relative prices of beef and grain affords sufficient evidence of this. Taking it for granted that too much has not as yet been written upon this subject, I propose to give a plain report of the general management of cattle throughout the estate with which I am connected, and more particularly to state the results of some experiments conducted by me during the summer and autumn of 1864, on one farm in a high state of cultivation in connexion with a colliery.

The estate referred to is Lambton, the property of the Earl of Durham. Several important collieries are worked by the proprietor, and, although the greater portion of the land is let on lease to good tenants, the requirements of the coal-mines necessitate the retaining of several arable farms of various sizes in the owner's hands. It very frequently happens that when agriculture is thus closely allied to the working of a commercial enterprise it only receives a very secondary share of attention, but such is not the case here. The greatest attention is paid to the cultivation of the land as well as to the working of the mines.

In connexion with the cultivation of the land the management of the cattle is deemed a matter of the first importance. Our course of breeding is a successful system of crossing between two established breeds. The larger proportion of the herd is from a cross between the Shorthorn bull and the West Highland heifer. The result of this cross is a finely-developed animal for the butcher, which invariably possesses in a great degree the size, form, and feeding qualities of the sire, whilst at the same time inheriting the hardy constitution of the dam. About 50 or 60 West Highland heifers (a year and a half old) are annually bought at the Falkirk Tryst or Fair in Scotland. They are brought home to the highest-lying farm, where they are wintered on straw and a few turnips, and merely kept in a fair thriving condition. In May they are turned out to pasture on the same farm, and the Shorthorn bull is put amongst them in the beginning of July. In the autumn they come down to the lower-lying farms, where they get a run over the pastures which have carried the feeding-stock, and on the annual draft of fat cattle being disposed of before Christmas they are taken into the fold-yards. They are kept upon a moderate allowance of turnips, oat-straw, and water in the folds. They generally drop

their calves in the yards, chiefly during April and the beginning of May. No inconvenience or loss from accident ever arises from their calving in the yards, as none of them ever injure a young calf. The calves are allowed to suckle their dams, and are turned out to pasture with them between the 10th and 15th of May. They, *i. e.* the heifers with calves, are generally thinly distributed over the sheep pastures on second year's grass (seeds) or secondary old grass-land, where they have an abundant supply of water. The calves are weaned from their dams about the latter part of October, and the mothers are taken to low-lying sheltered fields, where they get dry in milk; and, about Christmas, as the fat stock is cleared off, succeed to the empty boxes. They have turnips,—a moderate allowance at first, but gradually increased to as many as they can eat, except in seasons such as that of 1864, when the turnip-crop, being deficient, was supplemented with a daily allowance of 3 lbs. or so of barley-meal and Indian corn-meal mixed. It has been customary to give the turnips sliced, but last year the pulper was introduced, and has been found to be a valuable economiser of roots. No fodder is used for our keeping or feeding cattle, but good oat-straw, which when grown upon early land, and given with turnips, is found to have as good an effect as the best of hay. The Kyloes are kept in the boxes until about the 10th or 12th of May, when they are turned out to good old grass-land. On their pasture failing, about August, they get the aftermaths of the fields cut to supply hay for the coal-pits. They come in again to the boxes in autumn and receive turnips, cake, and meal, and are sold by auction at home at the annual Christmas sale held in December.

In the bad, dry season of 1864, this description of stock, having got nothing in addition to their pasturage, were not so ripe as usual, but at the sale our Kyloe heifers,  $4\frac{1}{2}$  years old, averaged 24*l.* odd. When purchased, they cost between 5*l.* and 6*l.* If it be thought, on calculating their keep up to the time of sale, that there is little margin for profit, I may observe that, until they have a calf at their feet, their keep is nominal, as they are made the scavengers or gleaners of what other stock leaves; besides, they benefit the farm to which they are [first taken by converting the straw into manure in a locality not adapted for fattening stock.

Our cross-breeding is now extended with great success, though not quite to an equal extent, with the Galloway heifer and Shorthorn bull. The result of this cross is a fine, noble animal, of excellent symmetry and great weight. The Galloways are treated exactly as their sisters the West Highlanders, except that being scarcely so hardy they require, on pastures failing, to be earlier removed to better keep. This is reasonable, because the

Galloways are much the larger and heavier animals; and in 1864 two of the Galloways weighed, when killed, 86 imperial stones odd, and a West Highland Kyloe heifer, reached the respectable *weight of 63 imperial stones* ( $4\frac{1}{2}$  years old).

#### THE CROSSES OR HALF-BREDS.

The calves (half-bred Kyloes and Galloways), when taken from their dams in October, are put into comfortable and roomy folds and upon good keep. They have good old-land hay, a few turnips steamed, with hay-chaff and a small daily allowance of oilcake. This plan of feeding is found to be very healthy, the steamed food and oilcake being a preventive to quarter-ill. After the first winter they have no more cooked food nor hay. In the spring they are turned out to fine old grass-land. In order to inure them to the variableness of the weather and to avoid the risk of a sudden change, they go out for a few days and come in at night, before being sent to their summer's grazing. On their pastures failing, they either follow feeding stock on the old-land aftermath or have a secondary aftermath allowed them. They come into yards in the autumn either at the same time with the feeding stock or shortly after, and receive turnips and 2 lbs. or 3 lbs. of meal. The object is to keep them in a steadily improving condition, avoiding even a single check to their progress. The meal in such a season as the present (1864) is cheaper feeding than turnips. In May again they are turned out to the best old pastures on the estate, and, before being stalled in the autumn, have the run of the best of the aftermath. They are generally brought into boxes about the middle of October, and receive turnips, 4 lbs. or 5 lbs. of meal, and 2 lbs. or 3 lbs. of good oilcake. They are sold by auction in December for Christmas consumption, when about  $2\frac{1}{2}$  years old (or little over), and generally average close upon 30*l.* It will thus be seen that the mothers are sold one year before their produce, but along with a former year's lot of half-breds; and, as this system is steadily pursued, the result is that a prime lot of fat cattle is annually disposed of at Christmas which, along with an equally prime lot of sheep, realises between 5000*l.* and 6000*l.* Several of the picked animals of this class and age have of late years brought 50*l.* and over.

#### EXPERIMENTS.

Within the last two years (1863, 1864) a slight deviation has been made from the usual routine of management, which the reader will be the better able to comprehend after having become acquainted with the general treatment of the stock. The soiling system, or feeding in the yards on cut grass, meal, &c., has been for two

successive seasons tested against grazing in the open field with the same allowance of meal, cake, &c., as well as against grazing without any supplementary food. Our experiments for the first year, though they gave satisfactory results, did not receive such minute attention as would enable me to illustrate them by figures. In 1864 it was resolved to be more systematic and methodical in our arrangements; and, although we had the disadvantage of experimenting with cattle of different ages and breeds, this difficulty was got over by employing competent practical judges to value the various lots at the commencement of the experiments. Taking the difference between the valuation and the sum realised at sale, we are able to arrive at the value each lot left per acre for the crop consumed.

Lot 1.—Twelve in number, consisted of 5 Galloway heifers, 4 years old, valued on 12th May, 1864, at 25*l.* each; 5 half-half-bred heifers, 2 years old (crosses between West Highland Kyloe, and Shorthorn bull), valued at same date at 19*l.* each, and 2 West Highland Kyloe heifers, 4 years old, valued also at 19*l.* each; the total value of the 12 cattle being 258*l.*

From 12th May to 13th October they were kept upon a 6-acre field of Italian rye-grass and clover, daily cut and carted to them in the yards; and from 13th October to 17th November they were fed upon turnips, &c. Along with their grass, and subsequently with their turnips, they had 5 lbs. each per day of Indian corn-meal and barley-meal mixed; and from 13th August to 17th November they had, in addition to the above, 2 lbs. each of best oilcake. The cost of the meal and cake respectively is 10*d.* per imperial stone for the former, and 15*d.* for the latter (or 10*l.* per ton), cash prices. The sum the lot realised at sale was 377*l.* 5*s.*, from which deduct 3*d.* per pound discount for cash (= 4*l.* 14*s.* 3*d.*), leaving 372*l.* 10*s.* 9*d.*

	£.	s.	d.
Thus 12 cattle, prime value of lot .. .. .	258	0	0
5 lbs. meal per day, from 12th May to 17th November	33	15	0
2 lbs. oilcake per day, from 13th August to 17th	10	5	0
November .. .. .			
	302	0	0

372*l.* 10*s.* 9*d.* against 302*l.* gives a difference of 70*l.* 10*s.* 9*d.* for grass and turnips consumed. While upon turnips the lot consumed, on an average, besides the meal and cake, 6 stones of sliced roots per head per day: these were swedes, and the best crop on the farm. The weight of the crop (cleaned bulbs) was about 30 tons per acre (6 tons per acre below the maximum in 1863 on the same farm). It will thus be seen, from the quantity of sliced roots consumed per day and the weight of the crop, that the above lot, during the time they were upon turnips, were

kept on little over half an acre. We therefore debit the account with 7*l.*, as the value of half an acre of turnips consumed upon the place, leaving of the above balance 60*l.*, or 10*l.* per acre, for Italian rye-grass. The grass would have done more, had the season not been an exceptional one. It was top-dressed with a mixture of Peruvian guano and nitrate of soda in the beginning of April, at a cost of rather more than 1*l.* per acre. It afforded three cuttings, and after the two first received a good watering from the liquid-manure tanks with the water-cart. The farm-horses were all kept in yards during the summer, fed with grass supplied from another field, and in the latter part of August and September with tares. The urine from the above stock did not suffice for the liquid-manuring of the 6-acre field, which also received that which remained in the tanks from the winter-fed stock. The yards are all well supplied with water, and, in order to economise straw, we only litter the covered portions with it and the outrake with sawdust. It is hardly necessary, nor would it be easy, to state the cost of attendance on the above lot of cattle, as one man cut the grass and tares for both horses and cattle and attended on the latter as well as the other grazing stock on the farm. The value of manure made from feeding in the house I estimate at more than an equivalent for the expense in top-dressing, labour in cutting grass, cartage, and attendance. Since the middle of October, too, the keeping ewes have frequently had a run over the field cut for soiling, thereby also contributing to profit or the lessening of expense.

Lot 2.—Twelve half-bred heifers, 2 years old (crosses between the West Highland Kyloe and Shorthorn bull), were turned out to graze on a 9-acre field of rich old grass on the 12th of May. They came into the folds for a few nights when first turned out. They were valued at the same time and by the same persons as Lot 1 at 16*l.* each. They received in every respect the same quantity and quality of supplementary food as Lot 1. They were also put upon turnips at the same date, and with the same accommodation in boxes 9 feet square.

	£.	s.	d.	£.	s.	d.
This lot realised at the sale 293 <i>l.</i> , or deducting						
3 <i>l.</i> per pound discount .. .. .				289	6	9
It is debited with cost price .. .. .	192	0	0			
5 lbs. meal per day each, from 12th May to						
17th November .. .. .	33	15	0			
2 lbs. oilcake per day each, from 13th August						
to 17th November .. .. .	10	5	0			
	—————			236	0	0
				53	6	9

a balance of 5*l.* 3*s.* per acre for rent of grass field, besides 7*l.*

for half an acre of turnips consumed. This lot, being all young growing stock, consumed, as nearly as we could calculate, the same quantity of turnips per day as Lot 1. The field of old grass upon which they grazed lies contiguous to the field from which Lot 1 was fed, and is, if anything, to be preferred to it for quality of land.

Lot 3.—Sixteen West Highland heifers, 4 years old, were grazed upon an 18-acre field of old grass. They were valued, when put to grass on 12th May, at 14*l.* each. They had neither meal nor cake while upon grass, and were brought into turnips on the same day and received the same allowance of turnips, cake, and meal as the two former lots.

	£.	s.	d.		£.	s.	d.
This lot realised at the sale, deducting discount				}			
as before .. .. .					.. ..	311	10
It is debited with cost price .. .. .	224	0	0				
5 lbs. meal per day each, from 13th October		8	6	}			
to 17th November .. .. .			8		8		
2 lbs. oilcake per day each, from 13th October		5	0	}			
to 17th November .. .. .			0		0		
					£37	6	8
Which gives a difference ..					74	3	4

Thus 311*l.* 10*s.* against 237*l.* 6*s.* 8*d.* gives a difference of 74*l.* 3*s.* 4*d.*, from which sum 8*l.* 3*s.* 4*d.* must be deducted for turnips (at the rate of 14*l.* per acre), leaving a balance of 66*l.* for rent of 18 acres of grass, or 3*l.* 13*s.* 4*d.* per acre.

The land upon which this lot grazed we estimate at 10*s.* per acre less in value than that depastured by Lot 2, the herbage being coarser and not so feeding as the other, so that in contrast to the other field, we are justified in stating the result at 4*l.* 3*s.* 4*d.* per acre.

The deductions we make from the above experiments are, 1st. That soiling or feeding in the house during summer gives about double the return obtained from grazing in the open field with supplemental food; and 2nd. That grazing with supplementary food gives a return of at least 1*l.* per acre more than grazing without anything supplementary. Every grazier knows that the months of August and September are critical, as pastures to a great degree have lost much of their nutriment, and unless cattle either get a little meal or cake upon them they very frequently lose what they have gained during the three previous months. The soiling is found to be the most profitable in every respect, (especially from the superior efficacy of the manure so made), and would be resorted to on a larger scale, but that it curtails the crop of new land hay, of which a large quantity is required for the horses in the coal-pits. On the different farms, however, between 30 and

40 cattle were so kept during the summer of 1864. In speaking of the general treatment of the stock we have mentioned the aftermath, but in 1864, in consequence of the drought, it never became fit to carry stock, and in consequence of a general shortness of turnips the sale took place a month sooner than usual.\*

#### THE PULPING OF TURNIPS.

We introduced the pulper in the autumn of the year 1863-4. For the first season we only fed a part of our number of cattle with pulped turnips and cut chaff, to test the value of the system as against the usual plan of feeding with sliced roots. The result showed, firstly, a decided economy from the use of the pulped food; and secondly, that the cattle so fed were, if not better, at least equal in quality to those fed on the old plan. From actual experiment, we find that by giving each beast 10 lbs. of cut straw mixed with pulped roots there is a saving of 21 lbs. of turnips per day on each animal. Two lots of 8 each were set apart for the experiment. Those on sliced roots consumed on the average 8 imperial stones per day, with 8 lbs. each of oat-straw out of the racks uncut. They had what they would eat of both. The other lot had a mixture of cut straw and pulped turnips, what they would eat, with oat-straw uncut *ab libitum*, and consumed on the average  $6\frac{1}{2}$  stones of pulped roots and 10 lbs. of cut straw, with  $4\frac{1}{2}$  lbs. of long straw per day each beast. We now pulp for 63 cattle, and, estimating the saving of roots at  $1\frac{1}{2}$  stone each per day, we save above 4 tons 2 cwt. per week on the average, and above 106 tons during the half-year, equivalent to  $3\frac{1}{2}$  acres at 30 tons per acre.

We have substituted horse for hand power in the working of the pulper, and fitted up an outhouse convenient for the supply of the yards and feeding-boxes. The cost of erecting horse-gin and fittings, with the machine itself, was about 20/. The expenses for attendance on the above cattle are, charging for the horse  $2\frac{1}{2}$  hours per day (the time occupied in pulping) and the partial services of one woman extra, 10s. per week more than when they were fed with sliced roots in the usual way.

Perhaps some might effect, by a larger admixture of straw with the pulped turnips, a far greater saving than that stated, without bias, as the result of our experience, and with which we are satisfied. Those who object to so considerable an admixture of straw should bear in mind that the stomach of the

---

\* The labour for soiling the cattle on the Italian rye-grass, must be equal to 30s. per acre; and we think it is not desirable or profitable, as a rule, to keep 12 beasts on 18 acres of land for nearly six months without any change of pasture, though such management much facilitated a comparative experiment.—R. M.

ox is fitted for a large amount of bulky food not necessarily all of a very nutritious kind. This must be filled before he lies down to ruminate contentedly. He can and will eat as much of rich food as of the comparatively innutritious sort, but not with an equally good effect. His system cannot assimilate more than a moderate quantity of the flesh or fat forming substances contained in rich food, and consequently it becomes overloaded and irritated so that scouring is produced, especially at the first. All who are acquainted with the feeding of cattle know that when first put upon turnips—as many as they can eat—they for a considerable time get worse in condition, instead of improving. This is particularly the case with cattle low in condition, and could be entirely avoided by the judicious use of the pulper. Besides, the argument for its use at first, applies with no less force to its general adoption. Although the cattle with which we have to do are seldom low in condition, still we consider it a duty to economise as much as we can the available food for live stock, as a means of increasing the number of our cattle and, consequently, the supply of beef for the public. The demand for beef and mutton is not met by a corresponding supply; let us then welcome every implement which can help us to either to grow more food or economise its consumption.

---

V.—*On Cross-Breeding Cattle.* By G. MURRAY.

I PROPOSE in this paper to consider briefly the chief means within our reach for cross-breeding, and the chief inducements which encourage us to make the attempt; to take a rapid survey of the principal changes already wrought, casually or designedly, in various counties in England and in Scotland, and of the most important breeds employed to that end; that after this introduction I may direct more special attention to a scheme for establishing a new breed, which has been carried out deliberately and systematically under my personal observation.

Although the improvements of our breeds of cattle has long received the close attention of a few energetic agriculturists, it is only of late years that our efforts have become general, scientific, and systematic.

The modern breeder has now a great advantage over his predecessors, because the pains taken by one generation has much facilitated the labours of their successors and enabled them to enlarge their sphere of operations. The first point was thoroughly to establish certain breeds of indubitable purity, as attested by authentic records: this was a work of time, yet it was a necessary



preliminary to attempts at cross-breeding, unless of the most random and indiscriminate character.

When such attempts have been unsuccessful, the failure has in most instances arisen from the use of inferior bulls, since the increased value of the offspring depends on their bearing in a marked degree the superior stamp and quality of the sire.

Whilst the materials for successful cross-breeding are now ready at hand, new inducements, new aids, and new lights are not wanting for our encouragement and guidance. The demand for meat is not only larger but more fastidious—even the artisan class being now more dainty in their choice; the coarser animals are, therefore, more depreciated than formerly: moreover science, by teaching us to note the action of different kinds of food on the animal economy, leads us to set a special value on those breeds whose powers of assimilating rich food are greatest. Veterinary science also not only enables us to treat ordinary forms of disease, but prompts us to try to reconcile by cross-breeding the two great desiderata—a vigorous constitution with aptitude to fatten.

Whilst I advocate judicious cross-breeding, let it be distinctly understood that I fully appreciate the importance of maintaining our principal breeds in their utmost purity. This object, however, will be best effected by reserving all the most perfect female specimens for the maintenance of the pure race, and by appropriating to cross-breeding those only which are defective in some few points.

The importance of using, even for cross-breeding, none but first-class bulls, can hardly be sufficiently insisted upon. Indeed the marked success which has attended the use of short-horn bulls may be attributed not less to their established position than to the intrinsic merits of the race.

There are few of our domesticated animals, to the breeding of which as much time, talent, and capital has been devoted as to the improved short-horn. He has, in consequence, acquired a permanent stamp and character which is of the utmost value for the object of improving common dairy stock, because the breeder feels assured that the valuable properties so carefully elaborated in the parent will be transmitted to the offspring.

Commencing our survey with the South-west of England, we find in the mild, moist, congenial climate of Devonshire a race almost faultless in form (especially in North Devon), which, while maintaining its purity at home, has exerted much influence on the cattle of other counties. The cows would be of great value to put to Hereford or short-horn bulls, particularly the latter, and we have seen some good specimens of this cross shown in the Agricultural Hall, Islington, in 1862 and 1863; but the

best breeders jealously guard their cows from contamination. In the richer pastures of Cornwall the native breed is less pure, but attains a greater size: they are frequently crossed with the short-horn or Hereford, but the produce is generally coarse in the horn, has a large head, a profusion of bone below the hocks and knees, and a thick tail. Its muscular development is more remarkable than its disposition to fatten. The ribs are generally flat—a flat-sided animal of any breed is particularly liable to derangement of the digestive organs. Good new blood is here much required; but it must be thoroughly good, to work an effectual change. In Hampshire, Devon bulls have been largely used; but as the produce were shallow milkers, short-horn, Ayrshire and Channel Island sires have been preferred. The use of the two last has led to improved milking capabilities—the former to greater aptitude for feeding; but in each case the success or failure of the experiment has depended greatly on the purity of the male parent. In Somersetshire the old original breed, when put to the improved Devon or Hereford bull, have bred on the rich feeding-lands cows of gigantic size, highly prized by the dairy-farmers. Many of the heifers and barren cows may be seen at the fair held at Kingston-on-Thames on the second of August.

The county of Hereford, with its fruitful soils resting on the old red sandstone formation, and moist climate, favourable for crops both of grass and of roots, has not only celebrated cattle, but farmers who are first-rate managers of stock. Foremost among these was Mr. Benjamin Tomkins, who, commencing his career about the year 1769 with two cows, “Mottle” and “Pigeon,” by judgment, industry, and perseverance, raised himself from a humble position and made himself a name in the annals of agriculture. The best breeders jealously preserve the purity of their stock, yet in cases where a cross with the short-horn has been tried, the produce has invariably been a superior animal for the grazier.

In Shropshire the Hereford bull has been largely and successfully used for crossing with Welsh and native cows, and the combination of the Welsh and Hereford blood has by frequent repetition become almost a distinct breed. They are of a dark red colour, with mottled faces, are thick-fleshed, and generally more hardy than the best-bred Herefords, but do not attain so early a maturity: they are highly esteemed by the graziers, and are known in the fairs of Leicester and Northampton by the name of Shropshires.

The Pembroke or North Wales breed are sometimes crossed with the short-horn, but more frequently with Hereford bulls. The first cross are in some cases an improvement on the original stock of the district; yet they are slow growers, and being less

hardy, are on the whole ill adapted to bear exposure to that climate until the extension of cultivation and general improvement have modified its character. In like manner the Glamorgan or South Wales breed have been crossed with the Devon and Hereford (the latter having the preference), but with so little success that the breeder will here best promote his interest by attending to the improvement of the existing races.

The Hereford bull has likewise been extensively used with the home-bred dairy cows in the counties of Gloucester, Warwick, and Worcester, which have the general character of the short-horn (though not of the improved type), with some peculiarities. The produce is commonly seen in the fairs and markets in the counties just named, as also at Banbury and occasionally at Northampton. They are large and weigh well, have great aptitude to fatten, are of first-rate quality, and consequently are in good favour with the butcher. Many graziers prefer them to the average run either of Herefords or Devons.

In the east of England the polled Suffolks, a much improved breed which is highly esteemed for the quantity and quality of their milk, offers suitable subjects for crossing with the short-horn bull. The first cross are good in quality, feed to great weights, and attain maturity at an early age. We have some experience of a cross between a short-horn bull and some cows purchased of Lord Sondes, and the produce evince great promise. We have also tried a cross between the short-horn and Channel Island breeds, and find that the cows of the first cross are of greater size; the yield of milk is increased in quantity frequently at the expense of quality; the steers feed readily, and reach a good weight, but the meat, particularly the fat, invariably retains the yellow tinge peculiar to this breed.

If we now turn to Scotland we shall find among its native breeds some of the best materials for cross-breeding.

Galloway, which comprises the counties of Wigton, Kirkeudbright, and Dumfries, was once the exclusive home of the polled Galloway breed which bears this name; even at home it has had for some years to struggle for the ascendancy with the dairy cows from Ayrshire. Formerly the Galloways were bred on most farms in this district, grazed for three years on the inferior pastures, and then sent to be finished off in the eastern and midland counties; modern improvements, however, have now generally enabled the breeder to fatten his animals at home. The improved Galloway is almost faultless in form, and is well adapted for crossing, as it readily amalgamates with other breeds, more particularly the short-horn. We have the authority and precedent of the late Richard Booth as a guarantee of the superior value of this cross, since one tribe, and that not the

least valuable in the invaluable Warlabby herd, trace their descent to a cross between a red Galloway heifer and a short-horn bull. Where only one cross is attempted the produce is highly prized by the feeders of the south and western counties of Scotland, as well as by salesmen at the Liverpool and other markets of the North of England. Here, as elsewhere, the only cause of failure has arisen from the use of inferior sires. We should have much cause for regret if the Galloway breed, which has already been much encroached upon by the Ayrshires, were endangered by indiscriminate cross-breeding. It is of great importance that a selection of the best animals, both male and female, the most perfect in form and pure in descent, be reserved for coupling together, and at the same time that the practice of spaying the heifers, which is more general here than elsewhere, be discontinued. A much greater number of the inferior heifers would then be available for putting to short-horn bulls of the best kind which, after breeding one calf, would grow much larger, and attain a greater weight with but little loss of time, and consequently be of greater value for feeding purposes than the spayed heifer.

The head-quarters of the Ayrshire breed is a tract of country stretching for many miles along the Frith of Clyde, which enjoys a moist but temperate climate, well adapted to the growth both of roots and natural grasses. Under these peculiarities of soil and climate this breed stands unsurpassed for the purpose of the dairy, and has within the last twenty years been much improved with special reference to its milking capabilities; they are of a kindly disposition, and feed readily when tied up in the stall or put on good pasture.

The breed has become extensively distributed throughout Scotland, wherever dairy farming is practised to any extent. They have also been tried in England, but with less success; as after the first year the soil and climate of the south produce such a change on the organs of secretion and assimilation that the nourishment instead of being converted into milk is deposited on the body in the form of fat. In their native county they are now extensively crossed with the short-horn, and the first cross generally produces good animals. Mr. Wright, of Girvan Mains, a large dairy-farmer, crosses all his cows with the short-horn; the produce is fed off at from two and a half to three years; the breeding herd being maintained by the purchase of pure bred heifers from other farmers. Mr. Wright has for several years been a successful exhibitor of fat steers and heifers both at Edinburgh and Glasgow, as well as at district shows. At two and a half years old the half-bred steer weighs from 10 to 15 stones (of 8 lbs.) more than a pure Ayrshire of the same

age, both being treated alike; but the heifer is inferior to the pure breed for the yield and quality of her milk, and is no favourite in the dairy; the Ayrshire is also extensively put to the Galloway, Aberdeen, and polled Angus bulls, and the produce is very useful; but for early maturity and fattening qualities nothing equals the cross with the short-horn.

In the counties of Forfar and Kincardine (forming the eastern seaboard of Scotland) the principal geological formation, as in Herefordshire, is the old red sandstone. Here both breeding and feeding is carried on to a great extent, the soil and climate, with the convertible system of husbandry, insuring an abundant supply of keep at all seasons. The native breed, the black-polled Angus, greatly resembles the Galloway, but they attain to greater weights, due, in great measure, to their superior treatment, being generally wintered in yards, with a plentiful supply of roots. They are also particularly well adapted for crossing with the short-horn, and furnish a great number of the magnificent specimens of half-breds which compete for prizes at the great fat shows throughout the kingdom. The polled cattle of Aberdeenshire differ but little in character from the last-named. That county lying farther to the north, and being principally confined to the gneiss and granite formations, has fewer natural advantages, but finds some compensation in high farming, and the introduction of first-rate short-horn bulls. A distinct race of cattle has thus been originated, which, for weight and quality and early maturity, is equal, if not superior, to any of the pure breeds of the country.

In consequence of the increasing attention now bestowed on dairies throughout the eastern and north-eastern counties, great numbers of Ayrshires have been introduced, and these are frequently crossed by the native polled breeds. The first cross is generally considered more valuable for the dairy than the native races. They attain a greater weight when fat than the Ayrshires, but are generally slow feeders. As breeders of cross-breds from this part of the country, the names of Stewart, Martin, and Knowles, are familiar to all who frequent our exhibitions of fat stock, as is that of McCombie as an exhibitor of the Aberdeen and polled Angus.

The county of Fife possesses a peculiar breed of cattle, black and white, of large size, with horns of considerable length, and famous milkers. How the race originated cannot now be clearly shown. From the fact that the kings of Scotland had a palace at Falkland in this county, it is surmised that these are descended from stock sent as a present to some monarch either from England or from Holland, their stamp and character apparently

favouring the latter conjecture. They are freely crossed with the Angus, Ayrshire, and short-horn, the last-named cross being most highly esteemed.

---

After this general survey, I now come to a modern instance of deliberate and systematic cross-breeding, based upon a careful consideration of the principles of physiology, the requirements of our markets, our modern system of management, and the consequent changes in the type, constitution, and habits of our cattle.

In 1850, a gentleman in the Midland Counties,\* an extensive occupier of land, a first-rate judge, and experienced breeder of short-horn stock, determined on establishing a distinct breed by engrafting the short-horn blood on some of the other pure races. After a careful deliberation, the West Highlander was selected as the most suitable for the purpose. The West Highlander, as found in his native glens of Argyleshire, with his broad chest, springing rib, and capacious trunk, possesses in a high degree the external characteristics indicative of a robust constitution, and a disposition to fatten readily and rapidly. Ten carefully-selected cows were purchased, some at Falkirk, others from well-known breeders in Argyleshire. They were all of a red colour, inclining to the lighter or yellow shade, and had the orange tinge of the inside of the ears and skin, so much valued in many pure breeds, as indicating a kindly disposition. They were all put to a pure-bred short-horn bull, and, after having produced their second calf, were fattened off or otherwise disposed of. Of their offspring the steers were all fed off at from  $2\frac{1}{2}$  to 3 years of age, but the heifers were put to the best short-horn bulls that could be procured, either bred by, or descended from, the herds of Lord Spencer, Sir Charles Knightley, Joseph Robinson, of Clifton, or of that of the late Mr. Richard Booth. It was an interesting study in itself to watch the effect of the cross with the different bulls, and it was remarked that the Booth blood always left the clearest impression. In some cases it was difficult even for a practised eye to distinguish the second cross from a pure short-horn; but invariably the last traces of their mountain origin were to be detected in the length and thickness of the horns, width of the forehead, and shortness of nose or distance from the eyes to the muzzle. The original cows, like all mountain-breeds in a semi-wild state, were shallow milkers, though the milk was of a very superior

---

\* John Beasley, Esq., Chapel Brampton, Northampton.

quality. As the produce receded from the Scot and merged in the short-horn, the quantity of milk increased with each cross, yet retained much of the quality of the original dam.

#### FIRST CROSS, SHORT-HORN AND WEST HIGHLAND.

The first cross is inferior in size to that between the short-horn and Aberdeen or polled Angus, and some of the other large breeds, but for disposition to fatten economically and quality of meat is surpassed by none. As practical illustrations of those capabilities I may mention several cases as occurring under my own observation. Just previous to the great Christmas market of 1859, eight of the steers, then under three years old, were sold at 33*l.* per head to Mr. John Allday, now of the firm of Morgan and Allday, salesmen, New Cattle Market. Those beasts had received no extra indulgence, but were kept during the winter in the usual way in the open yards along with other store cattle of the same age. During the winter of 1858 their principal food was barley-straw and straw-chaff, with a small admixture of hay, and one bushel per head per diem of cut roots. They went out to grass on the 20th of May, 1859, on an ordinary pasture, where they remained till the 29th of October without any extra food; at this date they were put into the stalls, from whence, about the 15th of December, they were taken direct to the great market. In the stalls their daily allowance of food was 1 bushel of cut swedes, 8 lbs. of linseed cake, 6 lbs. of meal—half bean, half barley; they were much admired, and were pronounced to be equal in quality to anything on offer that day. We had not an opportunity of ascertaining their exact weights; they were, however, estimated by good judges to average from 125 to 130 stones of 8 lbs. each.

#### SECOND CROSS; HISTORY OF ONE STEER.

To one steer having two crosses of short-horn blood more attention was devoted, and a correct account was kept of every particular of food, weight, &c.; though this was by no means an isolated case, for others of the same class made equally good animals. This steer was calved April 28th, 1858, was allowed to suck his dam for 12 weeks; he was then weaned, and treated as others of the same age. During the winter of 1858-59, in addition to the usual allowance of swedes, hay, and cut chaff, he had 3 lbs. per diem of good linseed-cake. About the middle of May, 1859, he, with others of the same age, was put into a second-rate old pasture, where he remained to the end of September, living on grass alone; he was then put into a box, and

received daily 4 lbs. of linseed-cake and one bushel of cut roots, with plenty of cut straw-chaff and a small modicum of hay. On the 1st of March, 1866, the quantity of cake was increased to 6 lbs., and 6 lbs. of meal, bean and barley, were added. He was sold for 30*l.* on the 8th of June, 1860, to a butcher in a neighbouring village, and weighed when dressed 115 stones of 8 lbs., being then under twenty-six months of age.

A promising animal, with three crosses of short-horn blood, was saved as a bull, being of a fashionable roan colour, and good in all his points; he was sold at ten months old, for 30*l.*, to a farmer in the neighbourhood, who keeps a small herd of well-bred short-horn cows: the cross has so far been successful, the calves look promising, are well shaped, with abundance of flesh, and plenty of hair. Another of the fourth cross, saved as a bull, is a promising animal of his age, but he is still under a year old; his quality, colour, and general appearance are those of a pure-bred short-horn, from which he can scarcely be distinguished. The cows and heifers have all been regular breeders, and the total number of calves reared from this family considerably exceeds a hundred, although about four years ago they were visited by *pleuro-pneumonia*, and a number of the best animals, in spite of every effort, succumbed to the disease.

Without a single exception the stock bred has been free from any approach to black even in the muzzle, which has been invariably of a light or flesh colour—a distinguishing mark of a thrifty animal.

The first and second crosses were principally red roans, with a few blood-reds. It is, however, remarkable, that of the first cross a considerable number were white, or white with red ears; all the bulls used have been either red, red and white, or dark roan.

The first and second cross retain much of the wild and restless habits so characteristic of the Highlander; and it is not until they become more closely related to the short-horn that they acquire his docile habits.

Cows and heifers from this herd have been exhibited from time to time at the local cattle-shows, and have carried off prizes when competing with pure-bred stock. Steers and oxen have in like manner taken prizes in the classes for fat beasts—a steer, having two crosses of short-horn, took first honours, both at Birmingham and London, in the same year.

The beef of cross-bred cattle is now generally admitted in the English markets to possess superior quality—as having a greater quantity of lean than that of most of the pure breeds, and also from the fat being well mixed with the flesh or muscular parts,



besides carrying a greater quantity of meat on the more valuable parts, and consequently presenting more roasting meat and less offal than most other animals. Again, as regards profit, reckoning from birth to maturity, we may safely assert that they may be equalled, but cannot be surpassed by any of our pure breeds for producing an equal weight of meat at a given age. Those who visited the Birmingham, London, and Liverpool shows for Fat Cattle, as also the great Christmas market of Dec. 12, in 1864, can testify that cross-bred oxen from Scotland and the North of England fairly distanced all competitors.

To those about to commence breeding crosses, whatever be the race to which the cows may belong, our observation and experience incline us to recommend short-horn sires, as their purity can be better depended upon than that of other bulls; and we are fully convinced that even for the purpose of cross-breeding, the purer the blood on the paternal side the more clearly will excellence be stamped on the progeny. In Scotland it may be difficult to find a sufficient number of short-horned bulls of good pedigree to supply the increasing demand for the purpose of crossing: in England such a difficulty will seldom arise.

What constitutes a pure-breed animal is a point not very clearly defined. Mr. Strafford, the editor of 'Coates's Herd-book,' a high authority on such matters, considers that animals which cannot show a descent for four generations from pure bulls are ineligible for entry in the Herdbook; and it is generally considered that such a pedigree will suffice to produce an animal possessing all the characteristics of his male progenitors. The herd of crosses we have attempted to describe consists at the present time of forty females, several of which have reached the fourth cross, and some have been entered in the Herdbook: those which have attained this stage possess the general character of the improved short-horn; they are straight in the back, well ribbed, short in the leg, with abundance of hair, and of very superior quality; in short, in appearance they could not be distinguished from that breed, and promise, if their management be carried out with the same liberality and intelligence which have hitherto been displayed, to become at no distant date a most important and valuable breed of cattle.

*Elvaston Castle, Derby.*

---

VI.—*On Rainfall, Natural Drainage, and Subterranean Water Storage.* By Professor D. T. ANSTED, M.A., F.R.S., &c.

INTRODUCTION.

THE natural circulation of water through the agency of the atmosphere and the earth is a subject of extraordinary interest and importance to the agriculturist, and includes perhaps those departments of meteorology and geology which are of greatest use to the practical man. But in its practical application the details of each particular case are so much determined by various local circumstances that the general outline to be met with in scientific books on the subject is not sufficient to satisfy the requirements of this class of readers, whilst there is very little special literature in our own language, and scarcely any in the French and German languages, available for their purpose.

Materials no doubt exist, and have been partially brought together, but observations are still wanting in many departments, and many observations recorded have not been reduced. There is certainly great need of information on the subject, and I will endeavour in the present article to point out, so far as space will allow, both what has been done and what remains to be done.\* If I can only hope to do so imperfectly, I may at any rate be able to give useful information, and offer a few practical suggestions.

The subject before us is clearly enough defined by the title. It embraces three distinct but closely allied groups of phenomena, each separately important and interesting, but all mutually dependent, and all combining to form the one great subject of the circulation of water on and within the earth. I will not preface these details with more remarks than are strictly necessary, but confine myself to such a general outline as may serve to connect and illustrate them.

That matter should exist on the earth in the three forms of solid, liquid, and gaseous or ærial, is a truth so obvious as to be generally admitted without consideration.

Yet we may well pause to consider that without them there could exist no such forms of life as those we are alone acquainted with, and that without some such association the earth could yield us no satisfactory history of the past, inasmuch as there could be no strata of sandstone, limestone, and clay containing

---

\* Since this article was commenced, Mr. Glaisher has undertaken to prepare a Report on the subject of British Rainfall, which may be looked for at some early meeting of the British Association. The subject could not be in better hands, but it will hardly supersede the matter I have here brought together, and the Report cannot be available for some time.

the remains of its former inhabitants. The whole being of the earth, as anything more than an inert mass of inorganic matter, is thus bound up in these varieties of the mechanical state of matter. The varieties themselves result from the mode in which force acts on matter, developed in one case as gravitation, in another as heat, then again exhibited in light, or in the various forms of electric and chemical force, and finally culminating in life itself. The various forms of force resulting in organisation produce this result apparently by means analogous to some of those by which inorganic matter is influenced.

Many important conclusions follow from this view of matter and force. Geologically it excludes all possibility of connecting the earth as it is with an earth in which matter should be exclusively either gaseous, or liquid, or solid, and not an admixture of the three. The earth may no doubt at some former time have existed in a vaporous or liquid state, like a comet, or like some of its fellow planets, or it may once have been solid, resembling, perhaps, the moon, or some other bodies in our system.

Who, indeed, can say what might not have happened with regard to the earth that can happen to matter? But of all this there is not one particle of evidence in the condition of the earth's outer crust. We may therefore dismiss all such theories, for no rock that was ever yet seen by man has needed for its formation any other conditions than those that exist at present; and we have no analogy to show that any one of these rocks could have been formed without air, water, and earth, associated and derived just as rocks\* now are, and mutually dependent.

This is by no means a matter of mere theory. So much has been said and written of igneous rocks and a steam atmosphere, so imaginative are many expressions of geologists in speaking of the earth's origin, that the general reader and even the geological student may be excused for supposing that there is some evidence to support them. There is absolutely none, nor can we carry back the history of the world by means of observation and investigation to any period when the sun did not shine, when the air did not float over earth and ocean, when the waves, and tides, and currents did not keep the waters of the ocean in perpetual movement, and dash them against the land, and when the water was not lifted into the air, conveyed by it to the land, condensed and deposited there, and either carried off by rivers, absorbed into the earth, or re-absorbed into the atmosphere by evaporation.

---

\* The term rock is used here and throughout this memoir in its technical geological sense, and is intended to include all mineral masses. Thus chalk and even incoherent sand or clay are rocks as much as hard limestones and sandstones.

The reader must be content to accept this statement, and the conclusions and inferences that result from it. Without some definite notion of the earth's structure and history the circulation of water cannot be understood. But this history is written only in the rocks of which its surface is made up, and that surface is but a thin crust. This is all we have to deal with, for it includes all that we can examine; and it is amply sufficient for our purposes, for as all known rocks and minerals were formed by and with water and air, always within such limits of temperature as made a complex condition possible, this view of rocks simplifies the question, and enables us to proceed at once a step further.

### I. RAINFALL: ITS DISTRIBUTION AND QUANTITY.

Owing to the form of the earth and its position and movements with respect to the sun, and owing also to the fact that the surface of the earth is only partially covered by water and entirely by air, there is a perpetual movement of the water in its bed and a constant circulation of air above. The circulation of the air is effected partly by the varied influence of the sun, partly by the motion of the earth. There are certain very important atmospheric currents that are constant and on a very grand scale, and many others that are variable or only periodical. Of the former the Trade-winds are examples. The latter are familiar to every one. With regard to the Trade-winds, we perceive but a small part of their regularity. They are only parts of currents that rise in the tropics, range steadily at vast elevation, and return from the Poles in a never-ceasing circuit. Many other currents exist, but most of them are so constantly interfered with and localised near the earth that we regard the winds as inconstant. Like all the great operations of nature, they obey certain laws, and are really constant in the highest and most important sense of the term. It is one result of the action of these laws that within the limits of temperate latitudes there is a region especially characterised by variable winds.

The circulation of air by currents is the cause of a grand system of circulation of water. Air dissolves water as water dissolves salt. It takes up a certain portion without losing its transparency. The quantity taken up is larger or smaller according to the temperature, and when the temperature is lowered the water continues in the air in a visible state as cloud. Thus, for example, a very large quantity of water is dissolved by and rises with the hot air that is about to commence its circuit from the regions near the equator. This hot air gets both cooler and less dense as it rises, and is thus gradually less and less

able to sustain so large a quantity of water. Some may shortly come back again in heavy showers, and part of the water lifted is carried on in a visible form until it can no longer be retained owing to the altered condition of the air. Visible vapour is mist or cloud; from mists or clouds large quantities of water fall to the earth as rain hundreds or even thousands of miles from the spot whence it started. As rain, it generally falls gently on the soil. Some of it runs off in water-courses, which in time, by union with millions of similar streamlets, become mighty rivers, and run back to the parent ocean. Some is at once made use of by thirsty vegetable or animal life, and is converted into leaves, stems, flowers or forest-trees, or enters into the flesh and tissues of animals by combining with carbon and a few other solid elements. Another part sinks into the earth.

But each part—including this last part—is greatly subdivided, and has a distinct history. Thus, one group of those drops that remain at the surface may trickle into a shallow pool and be re-evaporated directly; other drops may form part of a rivalet and be conveyed to a deep lake; and others, again, may return to the sea by some river with as little delay as possible. So, again, of that water that enters the earth the history is very varied. Such considerations form the subject-matter of important chapters of physical geography. The actual quantity of the rainfall in a given period, and its distribution in days, months, and years, is another inquiry altogether. The facts involved in this latter inquiry can only be determined by careful observation extending over a long period of time. The causes are extremely varied, and depend on a multitude of peculiarities in the physical condition of the earth's surface. As these vary, so the quantity and distribution vary; no two localities are precisely alike in this respect, and it is only as a matter of average and approximation that we can consider the question or come to a conclusion. It is not difficult to understand in a general way the causes of difference, but in any particular case it is almost impossible either to explain fully the result when we know it, or anticipate the result by theorising.

Still it is a very important question to all practical men, as well as a very interesting inquiry in general science, to decide what is the average annual rainfall in a particular place or district. Not less is it important to know the causes to which the quantity of rainfall is due so far as they are local. The ordinary or extraordinary limits within which the rainfall varies monthly, seasonally, and annually; the existence or non-existence of periods of larger or smaller supply ranging over many years; and finally the definite and permanent changes that seem to take

place in the distribution or quantity of rain in a district; these are only to be determined by comparing long series of observations, and we can only enter upon the discussion of them by accumulating, reducing and comparing all the facts known on the subject. And here lies the difficulty. Records exist, but unfortunately they are by no means of equal value, nor do they always admit of exact comparison. Referring to the best of them, however, let me endeavour to state some of the results as clearly and usefully as may be.

The existing tabular statements of the amount of rainfall at various stations in our own islands afford abundant matter for consideration. Taking first the averages for ten well-observed years, which more extended observations in a limited number of stations warrant us in regarding as not far from a general average, we shall find that whereas at one place, Bishopswearmouth in Durham, there fell on an average 16·91 inches per annum during the period from 1st Jan., 1850, to 31 Dec., 1859, the average at Seathwaite in Cumberland during the same time was 126·98 inches per annum, or about seven and a half times as much. It is not difficult to explain this difference by reference to the geographical position of the two stations. Seathwaite receives the rain produced by the condensation of the warm moist winds from the Atlantic as they are driven up the chilled and snow-clad sides of the Cumberland mountains. Bishopswearmouth, on the other hand, receives the rain chiefly, if not solely, from winds already partially drained by crossing the mountains and moors that lie between it and the Atlantic. These are extreme cases. There are few parts of Northern Europe where the average rainfall is below that of Bishopswearmouth, and few places out of the tropics where it exceeds that of Seathwaite. The results of extremely wet years further heighten the contrast. Thus the average of the three wet years, 1860-1862, at Seathwaite, was 164·94 inches, while at Bishopswearmouth it amounted only to 21·66 inches, and during the year 1862 when there fell 182·58 inches at Seathwaite, there only fell 19·30 inches at Bishopswearmouth.

There are two other stations, one at Coniston in Lancashire, and the other at Torosay in the isle of Mull, in each of which the rainfall occasionally amounts to 100 inches, but these are all very extreme cases and due to local causes.

To understand the rainfall of England, it will be convenient to take the mean or average amount for ten years in certain stations in different parts of the country. Thus, excluding the stations at Seathwaite and Coniston as exceptional, we find that the average of six stations situated in Lancashire and the West Riding of Yorkshire, all on the west side of England,

amounted to 38·05 inches per annum during the years 1850-1859 already alluded to. For nine places in Cornwall, Devon, Wiltshire, Hampshire, and Sussex—all near the south coast of England—the average was 34·18 inches. For seven places in Gloucestershire, Oxfordshire, Worcestershire, Shropshire, Leicestershire, Derbyshire, and the middle of Yorkshire, the average was 25·49 inches. Lastly, for seven places in Middlesex, Essex, Norfolk, and the East Riding of Yorkshire, the average during the same ten years was 23·70 inches. The result is represented in the annexed Diagram No. I. The period assumed

was, on the whole, rather drier than usual, but this would not much affect the values of the averages, and relatively they would probably exhibit no change at all. The average of all England during the same years, excluding Sea-thwaite and Coniston, was 29·84 inches, which is about the mean at Cirencester in Gloucestershire; and it is clear, from a very slight consideration of these figures, that the principal rainfall in England is on and near the west and south coasts; while in the middle of England there falls a very sensibly larger quantity of rain than on or near the eastern coast. It will also be evident, from a consideration of the general form of the land, that as the gentle slopes face chiefly towards the east, and the steep hill-sides towards the west, such a result is perfectly in accordance with the physical configuration and geological structure of the country. The fact itself is well illustrated in the Cotswold Hills and in the main ranges of the chalk hills, but is not less true elsewhere. So again, the dip or inclination of the strata being generally to the east and south, the drainage of the country is in accordance with the main features of its geology.

DIAGRAM I.—*Illustrating the Difference of Mean Annual Rainfall in different Districts of England on an average of Ten Years, from 1850 to 1859, both inclusive.*

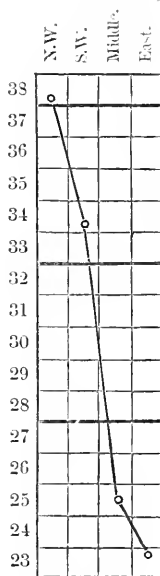

It may be well to mention the broad fact that Scotland and Ireland agree generally with England in these respects. In both there is a difference amounting to 15 inches between the rainfall on the west and east coasts. In Ireland the south-west coast, and in Scotland the western islands, are exceedingly wet, while the neighbourhoods of Dublin and Edinburgh are singularly dry. The former averaged only 21·78 inches, and the latter 24·72,

during the ten years 1850-59; while at Greenwich, in the same period, the average rainfall was 24·28 inches.

The monthly distribution of rain throughout the whole of England varies not less than the total annual rainfall. October and March are, however, almost always and everywhere the wettest months, while February and November are the least rainy. Of the rest, April and August are wetter than the other months not mentioned. The average fall of rain during the six summer months is greater than that during the winter months in the ratio of 6 to 5; but during the three warmest months, when evaporation is greatest, the average rainfall is almost the same as the mean monthly rainfall of the whole year. Almost everywhere in England the heaviest rains fall in October, and the fewest heavy rains in February. In the other months there is a great difference at different stations. Thus May and September, which in most places have either more than, or as much as, the monthly average, have not much more than half the average at Seathwaite. Many other peculiarities of the same kind are noticeable.

In a general way there is more rain in hilly than in flat districts. This is, no doubt, partly due in England to the greater prevalence of hilly country towards the west and south of our island, where, on other accounts, the excess of rainfall takes place, but it is an universal phenomenon, and results, at least partly, from physical configuration. Much more rain, however, falls close to the earth than at a moderate height in the air, therefore the rain-gauge should always be placed near the earth, and its exact position noted and recorded, if we would make accurate observations. At York Professor Phillips many years ago established this fact, and found that of three rain-gauges—one on the ground, one at 44 feet, and the other at 213 feet above the ground—the rain collected during one year was 26·71, 19·85, and 14·95 inches respectively.

At Greenwich, in 1864, there fell 16·34 inches close to the ground; at the height of 10 feet above the ground the quantity was 16·09 inches; at 22 feet 4 inches only 13·85 inches; at 38 feet 4 inches 11·96 inches; and at 50 feet 8 inches, only 10·40 inches. The site of the lower gauges is about 156 feet above the sea; of the highest about 205 feet. It is certain that the increased rainfall on hilly ground and on mountain-sides is due to local conditions, among which the position of the sea is one of the most important; but there are many exceptions, both real and apparent, to every rule that can be stated in reference to this subject.

In ordinary years the largest rainfall in the British islands is to be found in the Lake District of Cumberland and Westmore-



land, and in the Isle of Mull in Scotland. The west coast of Ireland and the northernmost islands of Scotland come next; the south of Ireland, the western counties of England, and the coast of Wales succeed. The middle of England is much behind, and the east coast far more so, as will be evident from the annexed diagram. The neighbourhood of London, though below the general average, is by no means so dry as the counties of Norfolk, Cambridgeshire, and Suffolk. With few exceptions, the various stations agree in showing that local rainfalls have some relation to the average of the whole country.

The quantity and distribution of rain being dependent to a very great extent on the peculiar physical features and the condition of the surface of the country, the inquiry naturally suggests itself whether there has been any modification of these features in England within the last half century. During this time, although no great changes have been wrought except in the drying up of a few large sheets of water, much has been done to the surface by draining and cultivating the land, and there has also been a large increase of population, a vast development of manufactures, and a consumption of fuel steadily increasing, and now amounting to almost eighty millions of tons per annum.

Some years ago (in 1859) Mr. Glaisher suggested that the mean annual rainfall in the neighbourhood of London was apparently diminishing in quantity. This idea was met by objections expressed forcibly enough by Mr. G. J. Symonds, and published in the 'Proceedings of the British Meteorological Society' for January, 1863. The conclusion had previously been opposed by Mr. Jamieson, who, in an Essay referring chiefly to Scotland, but including a wider area, set forth that a small decrease at one station was met by a corresponding increase in another, and that the compensation was complete. Arago had previously stated that in the neighbourhood of Paris there had been no appreciable change for 130 years; but the records of the rainfall made so long ago are hardly to be trusted. Many years must elapse before the accurate rain-gauges now used at many stations in the British islands and the Continent will have yielded a sufficient collection of observations to enable us to obtain from them such information as may settle the question finally, one way or the other, for all parts of England.

The rain observations made at Greenwich are, beyond doubt, the most to be depended upon of any on record. Up to the present time (September, 1865) they include a period of fifty years, commencing January 1, 1815, and ending December 31, 1864; and a careful study of them affords a reliable basis on which an opinion can be founded. Let us endeavour to determine the facts deducible from these records.

The mean rainfall at Greenwich for the period in question was 25·22 inches only. The largest rainfall was in 1824, and amounted to 36·3 inches. The lowest was 16·3 inches, and

DIAGRAM II.—Annual Rainfall at Greenwich during each Year for Fifty Years, from January 1, 1815, to December 31, 1864.

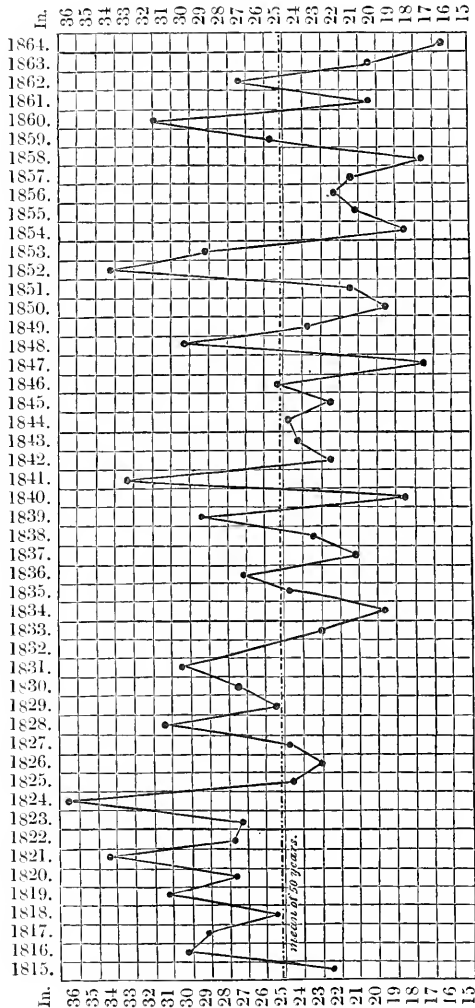

occurred in 1864. The extreme amount of range in different years is thus 20 inches, or more than half the maximum. The diagram marked II. will exhibit the facts recorded in the simplest and best manner.

From tabular statements of this nature it necessarily requires

a careful and minute observation of averages to obtain trustworthy and decisive conclusions as to progressive change. I will endeavour to put the case as fairly and in as varied a manner as possible, to enable the reader to judge of the value of the conclusion I feel bound to come to.

Estimating the mean of the period at 25·25 inches, let us first regard as ordinary years all those in which the total rainfall was within 5 inches on either side of this mean. Years when the rainfall was not within these limits may be taken as maximum or minimum years. Within the first twenty-five years of the period under consideration there were eighteen within the assumed limits of ordinary years, nine during which the fall was more, and nine during which it was less than the mean. There were five years of maxima and two of minima. During this period the mean fall was 26·69, or 1·44 inches above the general mean of the fifty years. Within the succeeding period of twenty-five years the mean fall was 23·75 inches, or nearly 3 inches less than in the first twenty-five. Fifteen of the years may be regarded as ordinary, but in these the rainfall was above the mean only four times, and below it eleven times. Only three times during the period did the rainfall amount to a maximum, or exceed 30·25 inches, but as many as seven times it must be regarded as minimum, the fall not amounting to 20·25 inches.

DIAGRAM III.—Mean of the Rainfall during the Five Decennial Periods from 1814 to 1864, both inclusive.

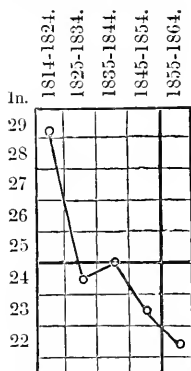

If we next divide the whole into periods of ten years, we find a result which is best expressed in the above Diagram (III.):—

But it affords a much fairer estimate of the average if we divide the fifty years into nine decennial periods, commencing at intervals of five years. We then obtain the following result:—

Means of the Rainfall during Decennial Periods, commencing at intervals of Five Years, from 1815 to 1864 inclusive.

Years.	Mean annual rainfall	Inches.
1815—1824.		29·17
1820—1829	”	28·25
1825—1834	”	24·51
1830—1839	”	24·60
1835—1844	”	24·95
1840—1849	”	24·25
1845—1854	”	24·25
1850—1859	”	23·15
1855—1864	”	22·44

These facts are important, and tell their own story so far as averages can do. They seem to show a steady, and even considerable decrease in the amount of rain, in whichever way we take the periods. If we go a step

DIAGRAM IV.—*Mean Rainfall during Periods of Five Years, from 1814 to 1864 inclusive.*

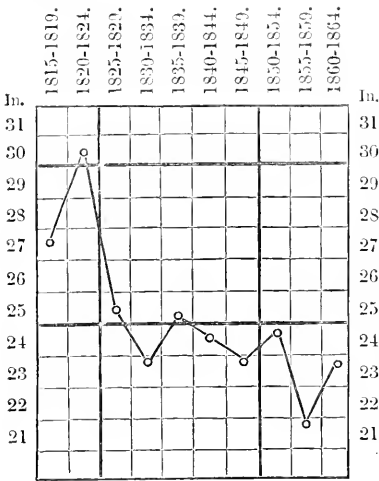

into ten of five years, the result is nearly similar, although we then perceive a peculiarity of the distribution, which can be best seen by the eye in a diagram. In these short intervals the diminution is not regular, but there are alternate maxima and minima; the general result being a decrease, as already shown in the longer periods.

This tendency to alternate maxima and minima is, however, shown much more clearly and decidedly if we compare the rainfalls of the various years placed before the eye as in the preceding diagram (No. II.). It will be evident that there is a tendency to a succession of maxima and minima, or rainfalls alternately above and below

the average, and also of groups of maximum and minimum years. Thus there is a group of maxima between 1814 and 1824, a group of means succeeded by two maxima and one minimum thence to 1841, and more recently small groups of maxima and minima. It will also be evident that the tendency during the whole period has been towards fewer and smaller maxima, and more, as well as lower, minima.

Both electric and magnetic storms or disturbances in the electrical state of the earth, as exhibited in the atmosphere, affect the rainfall in a very decided manner. It has been found of late years that these have reference to the dark places on the surface of the sun, which undergo a change in cycles of about eleven years. During such periods, then, it might be expected that the rainfall should be subject to useful comparison. Several cycles require to be compared before any conclusion of value can be arrived at; but availing ourselves of the records of half a century we shall at least have a starting-point. The result is shown in Diagram No. V. It agrees precisely with all that has been hitherto said. It is even more decided, and presents, as will be seen, a very regular curve.

We must now return to Diagram II., which is very important and instructive. It shows, as I have already pointed out, that there is, on the whole, a tendency to alternate maxima and minima in the rainfall, first in successive years, and next in cycles. These cycles are variable, ranging from six to twelve years. But it is clear that during the last half century the years and cycles of heavy rainfall have been growing fewer and smaller, and those of minima more frequent, while all the averages are lower. Thus there may be said to be sixteen periods of different duration, measuring from minimum to minimum, during the fifty years. The total in the years of heaviest rainfall lately has never exceeded the totals of half a century ago. The total rainfall during the dry years lately has been very much below the smallest rainfalls of former times, and has not been at all compensated by the increase due to the wet years 1852 and 1860.

DIAGRAM V.—Mean Rainfall during Five Periods of Magnetic Disturbance, from 1815 to 1858 inclusive.

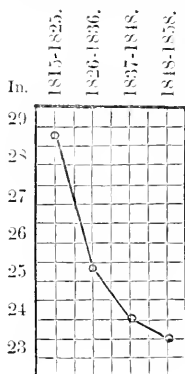

Exhibited to the eye, the reduction of the rainfall is recognised in Diagram II. rather by the general tendency of the curve to decline towards the right, than by any regular difference or group of differences. There is a certain regularity even in the jumps that are to be observed from one year to another, and the rarity of the occasions on which the mean rainfall is the actual fall of the year serves to illustrate the nature of the law governing the distribution.

There would seem to be nothing gained by assuming other periods for comparison. I have, however, taken the averages for three and seven years, but the results are of the same general nature, and hardly deserve recording in separate diagrams. The triennial period is too short to give valuable results. The septennial shows as follows:—

Means of Rainfall at Greenwich during succeeding periods of Seven and Fourteen Years, from 1815 to 1863 inclusive.

Years.	Mean rainfall	Inches.	Mean of 14 Years.
1815—1821.		28.7	} 28.3
1822—1828	„	27.9	
1829—1835	„	24.3	} 26.1

*Rainfall, Natural Drainage,*

Years.	Mean rainfall	Inches.	Mean of 14 Years. Inches.
1829—1835.	Mean rainfall	24·3	} 24·7
1836—1842	„	25·1	
1843—1849	„	24·1	} 24·6
1850—1856	„	23·8	
1857—1863	„	23·7	} 24·
			} 23·8

It will be observed that the means of the fourteen years, taken at intervals of seven years, are singularly regular, decreasing each period without exception, though by a small amount. As the years 1864 and 1865 have been particularly dry, it is evident that no alteration in the way of increase of the averages can be looked for at present.

I do not think it can be necessary to carry the tabulation of the Greenwich rainfall any further. It seems to me fully proved that there has been during the past fifty years a diminution in the quantity of rain, at least in the south-east of England, and in the neighbourhood of the metropolis. I think also it is proved that this diminution has been on the whole gradual; wet years, as usual, alternating with dry years, but the wet years not generally so wet, and the dry years generally drier as time has advanced. The form of the curve, though extremely zigzag, seems to indicate this, and the calculations of averages extending over several years unquestionably points to this as the general rule. The period of fifty years, though not very considerable, is sufficient both to yield an average and also to justify a deduction, especially when this deduction is in conformity with the observations both personal and recorded of those who have paid attention to the subject. The locality is also not unfavourably placed.

It is important to observe that this difference in the rainfall corresponds with, and is accompanied by, an apparent change both in the mean temperature and the distribution of the temperature in England. Mr. Glaisher has established the fact that, within the last hundred years the mean annual temperature has risen 2° Fahr. During that time the winter months have become much warmer in proportion, and the summer months not cooler. Thus the January temperature has increased as much as 3°. Such an alteration alone may be regarded as sufficient to produce a change of climate in many important respects, both in the rainfall and in the fitness of England now for the favourable production of many plants not before grown. The increased temperature would naturally tend to diminish the rainfall, other things remaining the same.

It will no doubt be said that even if the rainfall at Greenwich has diminished during the last half-century, the result may be due to purely local causes, and may perhaps not necessarily involve a similar result in other parts of England. It may be due to the immediate influence of the metropolis, for as far as one can in any way estimate the result of the accumulation of a large multitude of human beings within a limited area, and the consumption by them or for them of enormous quantities of fuel, the result might be to check the rainfall. The augmentation of temperature appears to be uniform throughout the country, and not local, and this cause must certainly everywhere act in the same direction, if not to the same extent, and if it have any influence, tend to the general diminution of rainfall.

It is much to be regretted that long series of observations on rainfall made with trustworthy instruments can only be obtained for a very small number of stations. This great need is now in the way of being supplied. Commencing with 1850, there are upwards of thirty stations in England, fifteen in Scotland, and four in Ireland, in all of which good records are kept, but the time is as yet somewhat too short to justify important generalisations. The mean of the fifteen years, 1850-1864, is certainly too low for all the stations, if we assume the absolute mean to be that obtained from a long series of years. Still with proper corrections these fifteen years are valuable for purposes of comparison. For Greenwich the result thus obtained is 23·4 inches, or  $7\frac{1}{2}$  per cent. less than the mean. It does not, of course, follow that this diminution is regular and uniform, or that it is certain to continue, but as by referring to Diagram No. II. it will be seen that during the last fifteen years at Greenwich there occurred two of the largest rainfalls of any years within the fifty, and that in other respects there were few extraordinary seasons, except, perhaps, that of 1864, we may safely assume it to have some foundation in fact.

I have found extreme difficulty in obtaining reliable data on which to base a definite proof of a gradual diminution of rainfall in various districts in England. The published reports of the Registrar-General, although valuable and interesting, are not absolutely continuous for the same places, nor is it always to be known whether the rain-gauge used was to be depended on, or whether it was situated near to or at some distance above the ground. This is especially the case with the older observations. Since 1848 the number of the stations has been increasing, but till very recently there has been little harmony of observing, and occasional interruptions in the record diminish the value of the lists. For purposes of comparison, however, the following diagram (No. VI.), prepared from such records as exist will, I think,

DIAGRAM VI.—Rainfall at Stations in different parts of England, from 1848 till 1864 inclusive.

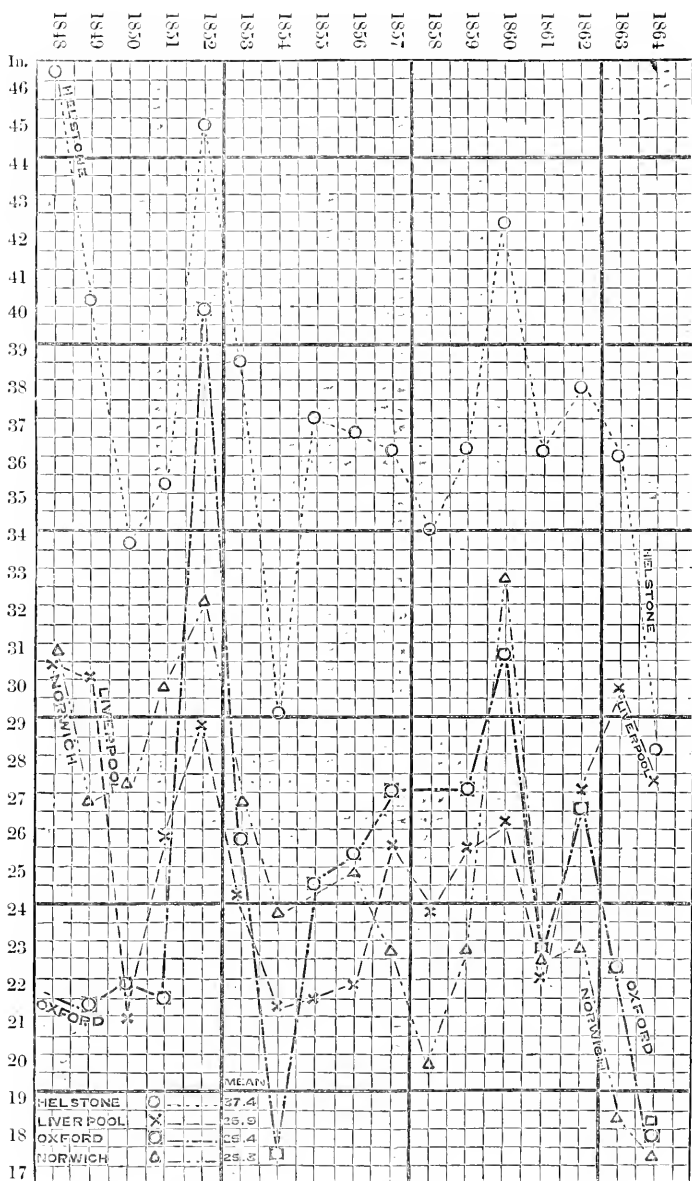

establish the fact, that there is a general accordance in each of the principal rainfall districts with that of Greenwich, in so far



as the question at issue is concerned. If the reader will carry his eye along the line of marks indicating the rainfall of each year in each place named, and also compare the position of the marks with those in Diagram No. II. for the same year, he will perceive a general accordance. If he will compare the different marks he will see that with the usual tendency to maxima and minima, there seems equally clear proof of diminished rainfall at least in these localities. The localities themselves are not indeed the best that could have been selected. I should have greatly preferred stations more typically representing the different parts of our island, but the materials for such a calculation, if they exist, are not at my disposal. I should also willingly have made the comparison run over a longer period, but for this also the materials have not been obtainable.

It is at any rate certain\* that the rainfall during the ten years 1850-1859 was five per cent. lower than the mean annual rainfall of the fifty years ending 1861, if we exclude the small district of the lakes, which is altogether exceptional. It is equally certain that although 1862 was slightly above the mean, the two succeeding years (1863 and 1864), and the year now just concluded, 1865, have been very much below and have been exceptionally dry. And the study of the carefully prepared and complete tables, now in course of publication by Mr. Symonds, shows that where rain-gauges are similarly placed, and can fairly be compared, they all point to the same general conclusion. But there is still much to be done, and a vast amount of information to be collected and tabulated before the subject can be fully discussed in all its bearings. A succession of years of short water-supply is a very serious event, and very injurious to the well-being of any country. In England, where the supply is usually somewhat large, and there exists a large subterranean accumulation, it might be expected that the evil would be less felt than on the continent of Europe, but practically this is not the case. The general style of cultivation turns upon crops the majority of which are calculated to endure, and even to benefit by, very frequent rain and a comparatively large rainfall, and we are sometimes exposed to great suffering, not only by diminished quantity, but by an altered mode of distribution. It is only very lately that good observations concerning the rate of distribution have been made, and it is as yet too soon to deduce general conclusions. The number of rainy days in each month, and in the year, might, one would think, be decided easily enough, but even in this matter there has hitherto been a want of system that render observations nearly worthless. Thus, while

---

\* British Association Reports for 1862, p. 296 (G. T. Symonds, Esq.)

one person considers every day rainy on which any rain falls, another requires that his rain-gauge shall register something, however small, and a third, that there shall be a definite and stated quantity. It is evidently quite impossible to compare statements where there is so little agreement as to the terms made use of. But in this again there is now a spirit of improvement, and after the lapse of a few years the agriculturist will know better than he can do at present, both whether the climate of England is really changing, and if so whether the change is for good or evil.

The mean rainfall for the whole of the British islands is so different from the means for England, Scotland, and Ireland taken separately, and the mean of all England is also so different from the means of certain districts taken separately, that a collection of observations made over a large district cannot safely be tabulated together without great precaution being taken to avoid error. It is, indeed, specially necessary to define natural districts, with a knowledge of the proximate conditions, and with an express view to this branch of meteorology. The districts assumed at present are twenty-three in number: eleven in England, eight in Scotland, and four in Ireland. So far even as England and Scotland are concerned, these are certainly very imperfect, and Ireland must undergo re-arrangement as soon as the state of the observations will permit. These divisions, however, rather refer to geographical position than to similar physical conditions. The total number of stations at which observations are now made is very large.

It has often happened that a year of drought in many large tracts of the United Kingdom has been a year of excessive rainfall in others, but for this there have generally been assignable reasons. More usually the causes producing exceptional years must be looked for from a distance, and affect large districts of Europe as well as the British islands. One general law of rainfall, however, seems to obtain in every part of the land of the north temperate zone, in which records have been carefully kept for a considerable time; and although England gives somewhat extreme examples of the operation of this law, and may even seem sometimes exceptional, the general tendency of the observations proves the existence of a considerable amount of harmony and inter-dependence.

If, then, it be the case, as seems very probable, that a diminution of rainfall is taking place in England, it is evident that the cause for such a result may be local, and the result of human influence and the cultivation of the land. On the other hand the cause may be cosmical; it may affect all Europe, and be connected with other changes of various kinds, such as the elevation

of land, the shallowing of certain large seas, and the result of that modifying force which never ceases to act, but of whose mode of action we know so little. The change of temperature or rainfall only lately suggested as a possibility in England, may be part of a far greater change that has been affecting our climate, not only since the glacial period of geologists, but since the earth first began to exist as a fit habitation for civilized man.

(*To be continued.*)

---

VII.—*The Poultry of France.* (From materials furnished by the ‘*Journal d’Agriculture Pratique.*’) By P. H. FRERE.

IN the spring of 1864 a new feature was added to the celebrated exhibitions of fat animals at Poissy, by the announcement of prizes and medals to be awarded to the best fat poultry. This led to a fair amount of competition, but especially brought for the first time upon the metropolitan stage some provincial celebrities which had hitherto been attracted towards the Lyons market. The success of this new effort was mainly due to the strenuous exertions of Count Le Hon, who took special care that his own district, La Bresse (in Burgundy), should be worthily represented. La Bresse consequently had far the largest entry, and quite eclipsed its rivals, so that its poultry rose 25 per cent. in value.

A stir was thus created, and, on the representations made to him, the Minister of Agriculture instituted a special Show for fat poultry at Paris, selecting the following month of December as, on the whole, the most convenient time for such an exhibition. Gold medals, together with a sum of 160*l.*, were to be awarded to winners of first prizes, and medals of silver and bronze as second and third prizes.\* The fowls were distributed into five classes: La Bresse, Houdan, La Flèche, Normandy, and “All other breeds;” the same medals were assigned to each class, which it was proposed to divide into two sections, one for capons, the other for “poulardes.”

In December, 1864, the event came off—2000 head of poultry of various kinds were exhibited in 500 lots, of these about 1500 were fowls: 600 from La Bresse, 200 Houdan, 200 Norman, 150 La Flèche, &c., all killed and prepared for cooking.

On this occasion the jury was composed of two country gentlemen, three officials of the agricultural department, three

---

\* The show included turkeys, geese, ducks, but this paper treats only of the fowls.

farmers, and four salesmen or poulterers. La Bresse kept the lead, gaining, after a struggle with La Flèche, the gold medal for the best fowls of any class, and receiving ten prizes and as many medals for capons and poulardes (exhibited in separate classes), against six or seven prizes awarded to several of the competing breeds for mixed classes.

The proceedings did not terminate with the award of the prizes; for at the Agriculturists' monthly dinner held during the show, the poultry became the leading feature, and the foremost agriculturists in France were called upon to decide *practically* on the comparative merits of two breeds—those of La Bresse and of Normandy. Fowls were discussed in every sense both during and after dinner. Their feeding, cost, age, market price were enlarged upon by keen advocates with a view to giving prominence to the peculiar merits of their respective favourites; the loss of weight occasioned by various modes of cookery came at last under discussion, and the questions mooted became too subtle and various to be decided without an adjourned meeting and more elaborate tests. At this dinner, speaking of the "poularde," M. Reynal, the naturalist, denied that the pullet's ovary can be removed, and maintained that a "poularde" is just what we call a pullet, a view which as we shall see further on is endorsed by high practical authority. M. de Kergolay, when speaking of his Norman fowls, explained that they were fed on a paste made of buckwheat, oats and barley in equal proportions, and had daily two drinks of water mixed with flour or sweet milk. He asserted that the chickens served up were only three months old, the capons six months, and the latter were sold at four to five francs a-piece. His remarks as to age led to some discussion.

At the dinner on the 26th of January, 1865, the grand tournament was renewed, and some Houdan breeders claimed to enter the lists against M. de Kergolay's Normans, and M. Le Hon's Bressians, the former competitors—to say nothing of Southdown mutton, a leporide, &c., presented by others among the guests.

M. de Lavergne, who was for the second time in the chair, gave the toast of the evening, "À la poule au pot," recalling an aspiration of Henri Quatre, and glancing in the following lines at the obstacles which have hitherto beset its attainment—

Enfin la poule au pot sera donc bientôt mise,  
On doit au moins le présumer ;  
Car depuis deux cents ans qu'on nous l'avait promise  
On n'a cessé de la plumer.

The dishes were too numerous, and the dicasts too much dispersed and excited to come to a formal verdict, and for the sake of harmony the chairman was glad to postpone giving

judgment, but much and varied information was elicited, especially as to the differences between the weights of the fowl alive, when plucked and trussed, or lastly, cooked and served up. In these days, when our supplies of meat are so fearfully threatened, any hints that bear upon the economy of feeding animals, or *preparing that food for the table*, deserve our most serious attention.

Five specimens were selected from each of the three rival breeds for special comparison, and were weighed before and after being prepared for the cook, and also when roasted. An experiment to show the comparative waste from roasting in the open air, or "brazing," that is, cooking in a covered vessel, had been contemplated, but I do not find a record of any such results.

The *average* weight of these lots were as follows :—

	La Bresse.		Houdan.		Normandy.	
	lbs.	ozs.	lbs.	ozs.	lbs.	ozs.
Unprepared .. .. .	6	12	5	4	4	11
Prepared for the cook .. .. .	5	5½	4	3	3	14
Dressed (après la cuisson) .. .. .	3	3¾	2	15¾	2	12½

Or more precisely the loss per cent. was as follows :—

	La Bresse.	Houdan.	Normandy.
In preparing for cook .. .. .	20·98	20·32	17·58
In cooking .. .. .	40·68	28·83	28·42
Total loss per cent. .. .. .	52·51	44·32	40·95

The advocates of La Bresse would remind us that the greater loss in their fowl is not to be set down as pure waste, as there is probably a greater amount of gravy, which has a certain value.

The Normandy chickens are stated by M. de Kergolay to have been younger than their rivals, and on that account to have lost less weight, since the fattening process had not been carried so far in their case. But the Houdan breed are also very precocious. Those hatched with the new year being ready for market by the middle of April, after three weeks of fattening on barley-meal moistened in milk, "bolted" three times a day without drink, the cost of food being 1s. to 1s. 3d.; these chickens are reared among woods, where they are to be seen picking up much insect food, kept in droves of 300 or 400. They are mostly hatched under hen-turkeys.

*Economics in reference to Poultry.*

When attention had been thus directed to poultry at gatherings over which M. de Lavergne presided, larger and graver inquiries followed as a matter of course. The chief authority on agricultural statistics in France (from whose countersign, even in England our random "guesses at truth" in this department get some sort of warranty for being gravely announced as "fact"), at once took up the larger aspect of the subject, in which M. Barral had to a certain extent anticipated him.

To the number of the *Journal d'Agriculture Pratique*, for January 5, 1865, M. de Lavergne contributed a paper on the Importance of Poultry in France, from which I shall venture to borrow largely.

He therein shows that in 1840 no notice was taken of poultry in the statistics of the empire; in 1858 it was stated incidentally that the proceeds amounted to 88 million francs (3,500,000*l.*), derived half from poultry proper, and half from eggs and feathers, an estimate much below the mark, as he proceeds to show.

With reference to eggs there are accurate accounts by which that estimate may be approximately tested. First, the value of the export trade, 24 million francs; secondly, the consumption at Paris, equivalent to 12 million francs: in all, 36 millions—leaving only 8 millions for all the rest of France, even if the feathers are quite left out of the account. Such an estimate is therefore quite inadmissible.

Since the population of Paris is one-twentieth of that of all France, at Paris *rates* the total value would be 240 million francs.

M. Lavergne, however, admitting that the consumption per head in the provinces is less than at Paris, considers it may be fairly set at rather more than half as great; and that the eggs, which at Paris are worth 60 francs per 1000, average 40 francs per 1000 in the country. He thus obtains a total of 100 million francs, or with the export, 125 millions as the annual value of French eggs, and considers this estimate to be under the truth. As to the poultry, it is harder to generalise. That sold in Paris at 1 franc per lb. is choice and dear: in the country it is not so much in use, and cheaper. On the whole, he concludes that the poultry may, like the eggs, be valued at 125 million francs (5,000,000*l.*); a result sufficient to provoke further and more precise investigation, for his estimates only profess to be tentative and approximate. At this rate the consumption amounts to 5*s.* per head for the whole of the population.

For Paris a more exact account is kept, which exhibits very striking results. The value of the poultry and game together

consumed in that city rose from 560,000*l.* in 1852, to 800,000*l.* in 1862; and that of the eggs from 246,000*l.* to 480,000*l.* It is estimated that there is about five times as much poultry as game consumed. The population of the capital had meanwhile increased by 300,000 souls. It is calculated that prior to 1789, the Parisians consumed annually 8 lbs. per head of game and poultry, but in 1862, 30 lbs: a very significant index of increased wealth and prosperity!

The next point for consideration is the distribution of this rural wealth, *i. e.* which departments are most and which least noted for breeding fowls. A long string of names of departments will never speak to a foreigner with the same significance as those genuine old landmarks the Provinces, so it will be sufficient to state that of the twenty leading departments, eleven encircle and supply Paris; with these two other departments, Calvados and Eure-et-Loire, may perhaps best be classed; "Le Nord" and Pas de Calais have a large home consumption to meet; two departments supply Lyons, and the remaining five are in the valley of the Garonne, where both soil and climate are so favourable that chickens form part of the common food of the inhabitants. As a rule the districts that grow buckwheat are famous for poultry; not so, those which grow rye.

It further appears that the export has been quadrupled within ten years. M. Barral when calling attention to the statistics of 1852, thus discussed by Lavergne, had further stated the total value of the animal produce of France at 112,000,000*l.*

#### Houdan Fowls and Trade.

These statistical inquiries were followed up by a more detailed inquiry by M. Barral into the sale of the Houdan poultry in the department Seine-et-Oise. The official returns for the three districts which rear these fowls are as follow:—

	Poultry.	Eggs and Feathers.
	£.	£.
Arrondissement of Mantes .. ..	12,593	9,761
Arrondissement of Dreux .. ..	8,937	7,516
Arrondissement of Nogent .. ..	2,278	2,804
	<hr/>	<hr/>
	23,808	20,081

or in round numbers the chickens sold may be set at 24,000*l.* But a private return by M. Delafosse values the fat chickens sold in the three leading market-towns as follows:—

Houdan (chief market in Mantes) .. ..	£.
Dreux .. ..	76,800
Nogent .. ..	96,000
	<hr/>
Total .. ..	67,200
	<hr/>
	240,000
	G 2

a sum ten times as large as the official returns assign to the whole of the three "arrondissements." Of this sum 136,000*l.*, according to M. Delafosse, is paid by the purveyors of Paris to three communes alone in these proportions:—

	£.
Gonssainville .. .. .	64,000
Saint Lubin de la Haye.. .. .	60,000
Havelu .. .. .	12,000
	<hr/>
	136,000

The remainder is drawn from other communes or purchased by poulterers of Versailles, St. Germain, &c. The inference drawn from the comparison of these two statements is that M. de Lavergne is quite within the mark when he multiplies the official return by three.

#### *The Management of Fowls.*

To get an insight into the general management of poultry in France, our best course will be to state in detail how some of the most noted breeds are kept by breeders of the greatest experience, that we may learn from a comparison what is essential to success or worthy of our imitation; bearing in mind that if we leave the beaten track in management, half measures will be of no avail: Nature's ways are very complete after their kind, and if we strike out a new line we must use much intelligence, vigilance, care, and method, or else we may fail egregiously.

#### *An Account of La Bresse and its Poultry.*

La Bresse, which now constitutes the "arrondissement" of Bourg in the department of Ain, extends from the banks of the Saône eastward to the spurs of the Jura, and consists of three very distinct districts. The western district joining the Saône is populous (having 97 inhabitants to 100 acres), the lands, which mostly belong to the occupiers, are worth from 80*l.* to 100*l.* per acre, more than half being in excellent pasture, and much stock is kept; in the district on the extreme east, adjoining the mountains, the population (23 to 100 acres) is alert, hard-working, and frugal, but hardly lives at ease; there are 100 acres of arable to 22 of meadow, for which the vineyards are but a poor substitute; much of the land is still waste.

The central region (which includes the towns of Bourg and Coligny) is in most respects midway between the other two; most of the soil is reclaimed or on the point of being so, and the rents (now 24*s.* to 32*s.* per acre) have doubled since the old French Revolution. No region has had greater difficulties to surmount than this, none has combated them more vigorously.



The land was flat and impermeable, destitute of lime, covered with stagnant pools of water, and the roads were proverbially bad. To get rid of the water, the arable fields have with incalculable toil and perseverance, been raised at the middle so as to slope to the four borders, and intersected by a network of open drains at right angles one to the other. Leases some centuries old contain covenants that the farmer shall cart 2000 to 3000 cartloads of earth yearly. The work seems to have been completed in the early part of the eighteenth century. After this beds of marl were found and applied generally to the land; since 1836 the roads have been set to rights.

Alternate husbandry with crops of roots and clover followed, stolen green crops were procured; and this peculiarity caught the special attention of M. de Lavergne, that here alone is the growth of maize combined with that of buckwheat.

La Bresse is much given to fattening animals on corn, whether they be oxen, pigs, or poultry; all of which find a good market at Lyons.

These introductory remarks have more to do with our subject than may at first sight appear. The conduct of the Bressian peasant in rearing his poultry is quite of a piece with his indefatigable and enlightened perseverance in other respects, and if we would share his success we must imitate his virtues.

There is distinct evidence in ancient leases that from about the year 1700 the fattening of poultry was an established and growing practice. By a lease dated 1694 the proprietor is to be furnished with fat capons: in another lease are reserved two *chapons paillés*—straw-coloured, *i. e.* fattened.

By the end of the eighteenth century, the districts had established its reputation for capons and “*poulardes* ;” about the same time, in spite of restrictive covenants, the growth of maize became general, for consumption by oxen and pigs as well as poultry.

The fowls of La Bresse have certain features which clearly distinguish them from other breeds of the neighbourhood. They are above the average size, short legged, small boned, the plumage white, with some few spots of grey. The comb is single, straight, and indented. They have four toes on the leg, which is brown and smooth; the skin is fine and the flesh delicate and savoury.

The hen begins to lay in February, and for a month or six weeks lays daily, then three or four times a week, till she has laid about 160 eggs, besides rearing two or three broods.

Cocks are changed continually; local experience confirms the general opinion that the produce of young males fatten the most readily.

The first broods come off in March, the earliest chickens

appear at market at the beginning of May—they then, at two months old, weigh 2 lbs. and sell for 2 to 2 $\frac{1}{4}$  francs.

The chickens when young are fed on a paste made of skim-milk, bran, and potatoes, boiled and mashed; when older they have tail corn or buckwheat. The “pillettes” which are to become “poulardes” are put into the coup at the age of three to three and a half months; the capons at four months. In the extreme cold of winter the fattening process occupies three or four weeks longer than at other times.

A fat poularde of La Bresse at four or five months weighs 6 lbs., a capon six months old, 8 to 10 lbs. Making capons, is a trade followed by certain women who travel about; an incision is made with scissors by the side of the anus. The comb will soon show whether the operation has been perfectly or incompletely performed. In the latter case the comb swells, or if it has been previously cut, grows again: in such case the fowls lose one-fifth of their value at market, for the capon not only fattens faster but has more white and delicate flesh.

The fattening goes on in a closed and dark chamber; each fowl has a small box allotted to it, and is kept almost motionless. The food given is a mixture of the meal of white maize and of buckwheat, moistened with skim-milk. The poultry-woman takes three or four between her knees, opens the beak with her left hand, and inserts a pellet with her right. After three or four weeks of fattening they are killed by bleeding them at the palate: they are carefully plucked at once, and then wrapped in a piece of fine linen steeped in milk, and fastened on with a piece of string: this is kept on until they are sold.

Their whiteness, fine grain, and rounded form, create great demand. The best specimens are bought on the premises by purveyors, who despatch them to various parts of France, Germany, Switzerland, and Italy. The home markets have a weekly supply of some thousands throughout the winter, weighing from 2 to 6 lbs. apiece. Several communes realize more than 80*l.* per week for four or five months for their poultry. The price varies with the season, and is highest about New Year's Day, especially if the weather is cold, and admits of carriage to a distance.

The general run of prices at Bourg Market is—

		<i>s.</i>	<i>d.</i>	<i>s.</i>	<i>d.</i>
For fowls, half-fat, weighing 3 lbs.	..	2	6 to	3	4
”                  ”                  4 lbs. . .	..	4	0	”	5 0
Choice specimens:—					
Poulardes, 6 lbs. (nett)	.. .. .	7	0	”	8 0
Capons, 8 lbs.	.. .. .	8	0	”	10 0
”   10 lbs.	.. .. .	12	0	”	14 6

Very choice capons sometimes make as much as 1*l.* apiece.

During the last twenty years the price has not varied materially, but the sale has at least tripled.

On every farm poultry is fattened to a certain extent, but the trade in choice specimens is, in some measure, confined to small proprietors or farmers in certain communes on the borders of La Bresse and Revorimont. One of these "*Chambriers*" will sell between September and March 200 to 300 fowls, half-fat, or prime-fat specimens, making of his poultry alone from 3*l.* to nearly 5*l.* per acre of his occupation.

All do not succeed alike even when favourably circumstanced, for certain families and farms enjoy a special reputation; but success generally depends on having the breed quite pure. Cross-breeding has been tried at various times to increase the size or improve the quality of the race, but these attempts proved failures. When a cross with the far-famed Cochins was tried there was a gain in size, but a loss in delicacy and flavour, so that this cross is now quite interdicted. Any fowl that shows the least sign of cross-breeding by a yellow tinge, or even by having scales on the legs, loses at once one-fifth or one-sixth of its value at market. These attempts have served at least to establish the value of the breed, and the importance of maintaining its purity.

In short, their delicate mould, early maturity, and readiness to fatten, make them the short-horns of the poultry-yard, with this advantage over their bovine rivals—that the quality of the flesh is first-rate, as various renowned epicures have testified. Until lately the poultry of La Bresse was little known or appreciated at Paris, though for forty years it has been exported to St. Petersburg.

The breed is hardy, and will adapt itself to all parts of France. But the fattening trade is not so accommodating. To insure success not only the pure breed and the proper food (white maize and buckwheat) must be procured, but the skill and the habits handed down from one generation to another among the farmers of La Bresse must be naturalized and followed up.

Such is the evidence of M. Dubost, the able advocate of this breed of poultry.

#### *The Poultry of La Flèche.*

With the preceding narrative we may compare an account of twenty years' experience in fattening the breed of La Flèche by Mdlle. Millet Robinet, a lady who appears to be the author of a *Manual on Poultry*, and a high authority on the subject.

As a preliminary she clears up the meaning of a "*poularde*," assuring us that it has never been operated upon in any way, and thus describes a good specimen:—

“The Poularde should be (1) five or six months old; (2) virgin; (3) never have laid an egg; (4) have white flesh under the wings; (5) the eyes under the lid should be circled with red; (6) the claws should be short, the rump and shoulders large; (7) it should be in fair condition when put up to fat.”

Since Mdlle. Robinet considers “cramming” the most effectual and economical means of fattening, that alone is described.

This involves having sparred coops, in which each fowl has its own compartment. The coop is a long narrow box in white wood, set on legs  $1\frac{1}{2}$  foot high: the outer walls and partitions are close boarded, and the bottom only is made with rounded spars  $1\frac{1}{2}$  in. in diameter, running lengthways of the coop, on which the fowls perch, their dung falling through the bars. The top consists of a sliding door, nearly as wide as the compartment, by which the chickens are taken in or out. The partitions are 8 inches apart, so that the fowl cannot turn itself round. The length of each box may be regulated by circumstances, care being taken that the attendant has room to pass along and to sit down; and furthermore, that cocks, capons, and poulets, or the lean and the fat lots be not mixed up indiscriminately. If fowls of different sexes are in close proximity, though nothing beyond *vocal* relations be established between them, the fattening process will be delayed: or again, fowls of different degrees of fatness should not inhabit the same box, because their rations will differ, and the new comers will disturb the older settlers by their noise.

Young cocks will fatten, though not so readily as capons; their flesh is somewhat inferior in delicacy to that of capons, and yet more so to that of pullets.

The floor below the boxes is covered with ashes or dry earth to catch the droppings, which are removed every two days with a scraper. The dung is equal in value to guano, and should be preserved from waste and moisture in old casks.

### *Feeding.*

The best food for fattening fowls is buckwheat meal, “bolted” quite fine. This is kneaded up with sweet milk till it gets the consistency of baker’s dough; it is then cut up into rations about the size of two eggs, which are made up into “rolls” about the thickness of a woman’s finger, but varying with the sizes of the fowls; these are subdivided by a sloping cut into “pâtons,” pellets,  $2\frac{1}{2}$  inches long.

A board is used for mixing the flour with the milk, which in winter should be lukewarm; it is poured into a hole made in the heap of flour, and mixed up little by little with a wooden spoon so long as it is taken up; the dough is then kneaded by the hands till it no longer adheres to them.

Some say that barley, or even oatmeal, is a good substitute for buckwheat-meal, but Mdlle. Millet is not of that opinion. Indian corn, the white variety, may do, but it is dear, and makes "short" paste, unless mixed with buckwheat, when it answers well if cheap enough; but buckwheat is a hardy plant, which may be grown anywhere at small cost.

The food is thus administered:—The attendant puts on an apron which will stand being soiled or torn, and takes the pellets on a board with a bowl of clear water. She takes the first fowl from its cage gently and carefully, not by the wings or the legs, but with both hands under the breast. She then seats herself with the fowl upon her knees, putting its rump under her left arm, by which she supports it; the left hand then opens its mouth (a little practice makes this very easy), and the right hand takes up a pellet, soaks it well in the water (*this is essential*), shakes it on its way to the open mouth, puts it straight down, and carefully crams it with the forefinger well into the gullet; when it is so far settled down that the fowl cannot eject it, she presses it down gently with thumb and forefinger into the crop, taking care not to fracture the pellet; for if some scraps of it remained in the gullet they might cause inflammation.

Other pellets follow the first, till the feeding is finished, in less time than one would imagine. It sometimes happens, particularly in the early stage of fattening, that the tracheal artery is compressed together with the gullet; this makes the poor creature cough, but is not of any serious consequence, and with a little experience this mishap is easily avoided. The fowl when fed is again held with both hands under its breast, and replaced in its cage without *fluttering* it; and so on with each fowl.

The chicken should have two meals in twenty-four hours twelve hours apart, provided with the utmost punctuality; if it has to wait it becomes uneasy, if fed too soon it has an indigestion, and in either case loses weight. On the first day of cramming only two or three pellets are given at each meal; the allowance is daily increased by one at a time till it reaches twelve to fifteen pellets. The stomach may be *filled*, but at each meal you must make sure that the last is duly digested, which is easily ascertained by gently handling the crop. If there be any dough in it, digestion has not gone on properly; the fowl must miss a meal, and have rather a smaller allowance next time; if too much food be forced upon the animal at first it will get out of health and have to be set at liberty.

The fattening process ought to be complete in two or three weeks, but for extra fat poultry twenty-five or twenty-six days are required; with good management you may go on for thirty days;

after this the creature becomes choked with accumulated fat, wastes away, and dies.

To judge of the fatness of the fowl, handle it at the upper part of the back, between the wings, or just under the wings, or again on either side of the tail, below the rump.

When a fowl is to be killed, it should first be fasted for twelve to fifteen hours, and then held carefully (not hung up by the heels, which would suffocate it), the mouth opened, and either the under side of the tongue cut with sharp scissors, or the pointed blade of a knife thrust into the palate till it pierces the brain; or thirdly, a few feathers may be plucked from the left side of the head, just below the ear, and a good incision made at the spot. In any case it must be fastened up by the heels immediately afterwards, that it may bleed freely, for on this the whiteness of the flesh depends; but during the death-struggle let it be held by the head.

Directions are further given for drawing and trussing which it is hardly necessary to record. The chicken is bandaged, till cold, to mould its form; and if the weather is warm it is plunged for a moment into very cold water. An average fowl takes about  $1\frac{1}{10}$  peck of buck-wheat to fat it. The fat of fowls so managed is of a dull white colour; their flesh is as it were transparent beneath a delicate skin.

Such is the management recommended by Mdlle. Millet, who is a Corresponding Member of the Imperial and Central Agricultural Society of France.

#### *Poultry in a Suburban Household.*

Another aspect of the subject is presented by M. de Chavannes, who discusses the question whether fowls reared in confinement can yield a profit for the benefit of those who, by increasing house-rents, are disseminated, "like mushrooms, in widening circles" around large towns. Such persons cannot abandon the garden to the beak and claws of a dozen "cacklers," so restraint is indispensable.

The author himself occupies a house six miles from Paris, with no ground attached to it but "a modest garden," and has to buy all his poultry-food: if he can make both ends meet, no one need despair. Now, his account-book (in which receipts and expenses are entered to a centime) shows that he has had a supply of eggs and fowls at a cheaper rate than that at which he could have bought them, though, on the other hand, he would have sold these proceeds at a loss, for the price at which a poulterer will buy of a "bourgeois" is ludicrously low.

But a poultry-yard which is to pay must be *well kept*; for all

animals require special care and intelligence in their management; amateurs therefore require to have pointed out to them their most common blunders.

In the first place, their fowls are often ill lodged. Every transplanted "cit" dreams of new-laid eggs; but it is only after providing for flowers, vegetables, and fruits that the Parisian who buys land by the foot asks himself, "How shall I house the hens?" After a search he discovers some corner where plants will not live for want of air and sun, and there he sets up his trellice, painted bright green in cruel mockery. "How many of these dens," writes M. de Chavanne, "did I come across in a three months' quest of a home! How many victims did I behold, who, with one leg in the mud, and the other buried in the breast-feathers, invoked the cook's knife to put an end to their misery! Poultry must have space, air, and sun, or the balance-sheet will tell a sorry tale."

The next source of mischief is an aspiration after fancy poultry of various kinds, often selected for eccentricities in plumage; from such a jumble of races this alone can be foreseen, that the produce will *not* be good layers and ready fatteners. The feeding too is often mismanaged; in a suburban establishment the poultry gets overlooked; and if the corn is given with regularity, the water-trough is often empty, or, even in a well-ordered establishment, a supply of "greens" is overlooked, or the indispensable box filled with ashes or sand—the fowls' only resource against parasites—is withheld.

M. de Chavanne commenced by buying a cock and hen of the Houdan breed, at the Jardin d'Acclimatisation, with other hens, to be weeded out hereafter. His outfit, including these purchases, the cost of enlarging his poultry-yard, and of the necessary utensils, came to 85 francs (3*l.* 8*s.*). The rest of the expenditure for food, straw for litter, &c., from Aug. 1862 to Dec. 31, 1864, came to 318 francs, making a total of 403 francs (16*l.* 2*s.* 6*d.*) In 1863, 790 eggs were collected, and 33 chickens eaten; in 1864, 1087 eggs were collected, and 22 chickens eaten up to the 1st of Jan. 1865. The stock then consisted of 29 fowls. If the pullets consumed are valued at 2*s.* 6*d.* apiece, and the live stock at 1*s.* 8*d.*, the eggs eaten at all seasons have averaged 4 centimes a piece (less than 8*d.* per score). The pullets averaged 2 $\frac{3}{4}$  lbs. a piece—no great weight for Houdan fowls, for they will easily reach 5 lbs.; but they suited M. de Chavanne's taste when less fat.

The Houdan breed, which was selected after much deliberation, has the following merits. They are early layers; March chickens will sometimes lay in the following November; although they are slow to begin to sit, and sometimes intermit a year,

they are very good mothers, cover their eggs well, boldly protect their chicks, and are tame and tractable—not like some hens, which the attendant cannot approach without creating a violent commotion. In 1863 two pullets, which had each 15 eggs put under them, reared 28 chickens. Since the Houdan hen could not be relied upon for sitting, some Cochin China hens were procured, the yellow colour of whose eggs obviated all risk of mistakes, and these are undeniable sitters.

---

I have thus endeavoured to collect the substance of various articles, printed in the ‘*Journal d’Agriculture Pratique*,’ on a subject which seems of late to have received more attention in France than in England. Indeed it is but too probable that with us the care of poultry has retrograded; for as the smaller holdings have been absorbed by large farms, many an active, frugal housewife has been withdrawn from rural life who had the will and the means for rearing poultry for the market. Neither the cottager with his allotment (instead of a share in the village green or common) nor the artisan has range enough for breeding chickens to advantage, though M. de Chavanne points out that with due attention they may be profitably reared for home consumption under any circumstances.

It is quite needless for me to enlarge upon the importance, at the present moment, of maintaining and developing our supplies of animal food, particularly that of a superior quality. With an abundance of inferior and cheap grain, our supplies of pork may be rapidly extended. This meat is, however, but a poor substitute for beef and mutton (except for our hardy rural population), more particularly at a moment when Drs. Cobbold, Crisp, &c., are sounding a “tocsin” of alarm respecting the German “*Trichinen*.” This same grain may be speedily converted into the most delicate of food, if we forbear—not to kill the fowl that lays the egg—but to eat some of the eggs that may become chickens.

If, further, we pay attention to raising special food for poultry, and trust Mlle. Millet Robinet’s experience, buckwheat may be speedily grown; one consideration, however, suggests both an encouragement and a difficulty—all birds, large and small, are particularly fond of this grain; and neither the axe nor the gun of the “*chasseur aux petits oiseaux*” has effected such a clearance in our fields as in the wide plains of France. Can buckwheat be imported to any considerable extent at a cheap rate?

---



VIII.—*On Disinfectants: being the substance of a Lecture delivered in December, 1865, with a Report of further Experiments, &c.*  
By DR. A. VOELCKER.

CONTAGION or infection signifies the communication of disease by actual contact with sick animals, by contact with normal discharge or abnormal secretions, or by means of effluvia arising from their bodies, or by all articles which have been in contact with diseased animals or their discharges.

This power to communicate certain diseases appears to reside in extremely subtle substances, which under favourable conditions develop and reproduce themselves in healthy animals with which they come into contact. Hence the danger that infected animals and all materials touched by them may spread the Cattle Plague.

Our present knowledge of the structural and chemical properties of infectious poisons is so scanty, and the difficulties attending investigations into the nature of these subtle and unstable bodies are so great, that we must not be surprised if the opinions of scientific men respecting the nature of Cattle Plague poison are greatly divided. That we have to deal with a material though extremely subtle poison, is, if I am not mistaken, generally admitted, not so the form and precise nature of the poison. Although a good many microscopical and physiological researches on this subject have been undertaken in this country since the outbreak of the plague, the results obtained are not sufficiently numerous and precise to warrant their publication in detail. Whilst investigations of that kind are still actively pursued, and men best informed on the subject hesitate to give a decided opinion on the structure or the functions of the Cattle Plague poison, it would not be right for me to mention names in connection with any facts, or supposed facts, which the microscope may or may not have brought to light.

Without offering an opinion on the correctness of the observations, I may state that careful microscopic observers have noticed, more especially in the feces of cattle attacked by the plague, very minute and peculiarly organised cells filled with numerous spherical bodies, moving to and fro with great activity. These cells and their animated globular contents are extremely small, so that the highest power of the most powerful microscope is necessary for witnessing their existence. According, then, to certain competent authorities, that which produces the Cattle Plague is exceedingly subtle organic matter disposed in organic cells, and only revealed by microscopic research. This poison in more than one respect resembles in general character ordinary vaccine virus. It may be dormant three or four days before its peculiar vitalised cells with their contents become active.

It is not the part of the chemist to say how the plague was produced, or what are the remedies to be applied in order to effect a cure. I have no intention to trespass on the legitimate province of the veterinarian, but I have felt it incumbent upon me to direct special

attention to the fact that we have to deal with a very subtle but *material* body, whether disinfection or cure be our object.

I propose to make some observations on—

1st. The various disinfectants recommended by different persons, their mode of action, and their comparative efficacy.

2nd. The application of disinfectants, to particular purposes, as the disinfection of cow-sheds, carriages, trucks, manure-heaps, &c.

3rd. Preventives: an inquiry which would have special reference to disinfectants in relation to the Cattle Plague.

With respect to the word "disinfectant," very vague and confused notions are prevalent: and it would be well if the word were confined solely to those solid, liquid, or gaseous materials which possess the power of disorganising or destroying all matter capable of reproducing disease in animals; frequently, however, the word is applied to substances which, though they remove disagreeable gases and vapours, such as those produced by sulphuretted hydrogen, fail to destroy the cause and source of the nuisance: properly these are deodorisers, not disinfectants; and of these there are many. But the application of chlorine or nitrous acid, not only removes the smell proceeding from faecal matters, but breaks up or destroys the organic matter and resolves it into ultimate gas products, comparatively harmless, as completely as fire could do. Chlorine and nitrous acid, therefore, are not merely deodorisers, but true disinfectants; and such substances are always deodorisers, although deodorisers are not always disinfectants.

Agents used to prevent or retard that putrefaction which gives rise to foul odours, are often regarded as disinfectants. If, however, a disinfectant be that which breaks up and destroys the constitution of organic matter, the term is inapplicable to substances which, instead of hastening destruction, preserve organic matter from disorganisation. Such substances are, properly speaking, antiseptics. Thus, carbolic acid, creosote, and other preparations of tar, which, in minute quantities, are capable of preventing the putrefaction of meat, blood, urine, and other animal matters exceedingly prone to enter on decomposition, are true antiseptics, and the very reverse in their action to disinfectants, such as chlorine, and nitrous acid. It is true that, in a concentrated state, carbolic acid and creosote are strong destroyers of organic matter; but it must be borne in mind that, in such a form, they could not practically be used for disinfecting purposes. Moreover, in common parlance, the term disinfection is applied to substances which merely deodorise places from which foul gases emanate; and this is much to be regretted, because such a use of the word involves confusion of ideas and errors in practice. I call disinfectants, therefore, those substances which destroy all matter capable of producing disease; deodorisers those which neutralise foul gases without destroying the organic bodies from which they emanate; whilst substances employed to prevent or impede putrefaction I call antiseptics rather than disinfectants.

## 1. ON VARIOUS DISINFECTANTS—THEIR MODE OF ACTION AND PRACTICAL UTILITY.

*a. True Disinfectants.*

The following are some of the best known true disinfectants:—

Chloride of lime, chlorine gas, sulphurous acid, nitric acid, nitrous acid, quick lime, soda ash, wood and peat charcoal, dry earth, manganese and permanganates of potash or soda (Condy's disinfectant), fire, heat, and air.

All true disinfectants, as stated already, destroy more or less rapidly organic matters. On account of the rapidity with which some exert their power, they are highly injurious to animal life, and therefore cannot be used in cowsheds or stables in which animals are kept at the time when disinfection has to be practised.

Others destroy organic matters only slowly, but in the end most effectually; and still others dissolve infectious matters readily, but, unlike chlorine or nitric acid, act upon it very gradually. These differences in the actions of disinfectants, and their general applicability or their use in special cases, will best appear as we go through the list given above.

*Chloride of Lime.*—Slaked lime absorbs large quantities of chlorine gas, and becomes changed into hypochloride of lime and chloride of calcium. Both these combinations, with more or less unchanged quick lime, carbonate of lime, and even all the impurities originally present in the quick lime employed, are present in chloride of lime or bleaching-powder; a preparation which is made by passing chlorine gas into slaked lime, so as to saturate it more or less completely. The active principle is hypochloride of lime, which is readily decomposed by all mineral acids. Even the weak carbonic acid, always present in ordinary air, acts upon it, forming carbonate of lime and disengaging hypochlorous acid. Chlorine and oxygen, the constituent elements of hypochlorous acid, are held together in this acid but very feebly; in consequence of which it readily splits into free oxygen and chlorine gas. Chloride of lime of commerce thus is a preparation which merely on exposure to a moist air gives off oxygen in a nascent condition and chlorine gas, which is distinguished from most other elementary gases by its great affinity for hydrogen.

Chlorine unites not only with great violence with pure hydrogen, but it also takes hydrogen from its combination with other substances. In most organised substances, carbon, hydrogen, and oxygen are never-failing constituents. The hydrochloric acid is very rapidly destroyed, or rather it breaks up very rapidly into free oxygen and chlorine; two gases which, acting upon meat and nearly all animal and vegetable matters, burn and disorganise them completely. If we take a piece of meat and boil it well in chloride of lime for a sufficient time, it is altogether destroyed, and disappears, being resolved into gaseous and comparatively harmless products. This is unquestionably one of the most active and most available artificial disinfectants we can use, either for disinfecting carcases or for brushing over the walls and floors of tainted sheds. For such uses, mix 1 lb. of chloride of lime

with three gallons—a small pailful—of water; this will give a milky liquid. For some purposes a clear solution of chloride of lime is useful; this is produced by putting 2 ounces of chloride in 1 gallon of water, and after shaking up the milky liquid allowing it to settle, and finally drawing off the clear watery liquid from the insoluble lime deposit.

Although chloride of lime is perhaps the most generally useful disinfecting agent, its extensive use in cowsheds or stables cannot be recommended as long as stock are kept in them, for if spread about in such abundance as to destroy contagion it is sure to injure the health of cattle, or if used more sparingly its efficiency in destroying the infectious matter will be doubtful,

*Chlorine gas* is a still more powerful and concentrated disinfectant, in a form which is convenient for certain purposes, such as the disinfection of cowsheds or the holds of cattle-sheds by fumigation. Chlorine fumigations are made either by placing in a slop-basin or deep jar finely powdered black oxide of manganese and pouring upon it common muriatic acid; or by mixing together 3 parts of common salt, 1 part of black oxide of manganese, 2 parts of oil of vitriol, diluted with an equal proportion of water.

The mixture of salt and manganese may be kept ready mixed for use, and the diluted oil of vitriol poured upon some of the mixture in a shallow vessel when required.

For fumigating a large cowshed about  $1\frac{1}{2}$  lb. of finely powdered black oxide of manganese and  $1\frac{1}{2}$  pint of muriatic acid will be sufficient. The heat generated by the oxide in acting upon the black oxide of manganese disengages a good deal of chlorine; but if it is desired to obtain all the chlorine which the mixture is capable of yielding, it is advisable to place the vessel in which the acid and manganese are mixed together on a gentle charcoal fire. Another plan of generating chlorine is to pour dilute sulphuric acid (1 part of strong acid and 10 of water) upon chloride of lime.

As chlorine is an extremely poisonous gas, the person who is about to fumigate an unoccupied place must take care not to inhale any of the gas.

*Sulphurous acid*, which acts, not in the same, but in a similar manner, may also be used for disinfecting purposes with very great propriety, and it is very readily prepared. Light some flowers of sulphur (about 1 or  $1\frac{1}{2}$  lb.): the resulting gas is sulphurous acid, a most powerful destroyer of organic matter, which may be usefully applied to parts of buildings not otherwise accessible to bleaching powder or other disinfectants.

*Nitric and nitrous acids* are powerful oxydising agents which destroy organic matters by yielding to them oxygen in an active state. They burn up, in fact, organic matters at a low temperature in a manner similar to that in which fire destroys them at an elevated temperature. Nitrous acid fumigations were introduced by Dr. Carmichael Smith, who, in 1797, received a reward from Parliament of 5000*l.* for the publication of his formula. Nitric and nitrous acid vapours may be produced in the following manner:—4 ozs. of powdered nitre are put

into a shallow earthenware vessel and mixed with 4 ozs. of oil of vitriol and 2 ozs. of water; the vessel containing this mixture is then placed over heated cinders, the heat of which causes the acid gases to be evolved in abundance.

Still more conveniently, and without the application of heat, nitrous acid fumes may be generated by pouring  $\frac{1}{2}$  lb. of concentrated nitric acid upon 3 ozs. of copper shavings or turnings put into a tall jar or basin.

*Quick Lime.*—Quick lime disorganises and by degrees destroys animal and vegetable matters, and at the same time absorbs products of decomposition, such as sulphuretted hydrogen and carbonic acid. It is thus at once a disinfectant and a deodorizer. It ought to have been recently burnt, and may be used for disinfecting purposes, either in the form of dry powder or stirred up with about ten times its bulk of water, as milk of lime.

In the shape of a thick lime-wash quick lime receives extensive application as a disinfectant; and in the form of dry powder it is a good and the most practically available means for disinfecting carrion, dung, and manure-heaps from cattle that have died of plague.

*Soda-ash.*—Crude carbonate of soda, or soda-ash generally contains some caustic soda in addition to carbonate, and as it is a cheap material and its action upon organic matters similar to that of quick lime, but more energetic, it deserves to be employed more extensively than it is at present for disinfecting purposes.

Soda-ash is readily soluble in water. 1 lb. of soda-ash dissolved in 2 gallons of warm water is a liquid which, apart from its disinfecting powers, recommends itself by its excellent detergent properties for removing organic filth adhering to woodwork, mangers, wooden stable utensils, and all other articles which may have become soiled by infected cattle.

Quick lime is only sparingly soluble in water, and for this reason does not dissolve organic matters so readily as soda-ash, nor does quick lime destroy them so rapidly as the caustic alkali in the soda-ash.

*Wood or peat charcoal* possesses a remarkable destroying power on organic substances. If dry, charcoal absorbs different gases in very different proportions, as will be seen in the following tabular view of Saussure's results:—

*Absorption of Gases by freshly-burned Charcoal.*

One volume of charcoal absorbed—	Volumes.
Ammonia .. .. .	90.0
Hydrochloric acid .. .. .	85.0
Sulphurous acid .. .. .	65.0
Sulphuretted hydrogen .. .. .	55.0
Protoxide of nitrogen .. .. .	40.0
Carbonic acid .. .. .	35.0
Bicarburetted hydrogen .. .. .	35.0
Carbonic oxide .. .. .	9.4
Oxygen .. .. .	9.2
Nitrogen .. .. .	7.2
Carburetted hydrogen .. .. .	5.0
Hydrogen .. .. .	1.7

It had been supposed that charcoal preserved meat, but the investigations of Dr. Stenhouse have shown that it hastens very much the destruction of flesh, and all kinds of animal matter. It possesses the power not only of absorbing certain smelling gases—sulphuretted hydrogen and ammonia—but also of destroying the gases thus absorbed. For otherwise its purifying action would soon be greatly impaired. It is very porous, and its pores are filled with condensed oxygen to the extent of eight times its bulk. We have, therefore, in charcoal oxygen gas (which supports combustion, or lights fires), in a condensed and more active condition than in the common air which we breathe. Hence it is that organic matter in contact with charcoal is so rapidly destroyed. The beauty of charcoal is, that the destruction takes place imperceptibly, and that its power of burning organic matter is continually renewed by the surrounding atmosphere, so that it is a constant carrier of atmospheric oxygen in a condensed state in its pores: the oxygen which acts on organic matter, and burns it up, is speedily replaced, and the process goes on continuously. Hence it is that a comparatively small quantity of wood or peat charcoal is capable of destroying a very large quantity of organic matter. The substance before me on the table is part of the hind-quarters of a fox. It has been perfectly inodorous from the first day when I put it in the jar and covered it with powdered charcoal: it was sent me for another purpose—to ascertain if poison was in it; but Dr. Stenhouse having just discovered that charcoal hastened the decomposition of organic matter, I thought that while examining for poison I might further test the properties thought to reside in charcoal; but, as Dr. Stenhouse has said, the meat is rapidly destroyed, and nothing but skin and bone is left behind. Wood-charcoal, therefore, is an excellent means of destroying animal matter, and for covering up urine. *Peat-charcoal* might be similarly used. Where neither can be obtained, *earth* is an efficient disinfectant.

In a similar manner, and perhaps more powerfully for some purposes, quick lime or caustic soda, or soda-ash, act in destroying animal matter. The soda-ash of commerce appears to be superior to quick lime for disinfecting purposes, for the simple reason that it rapidly dissolves in water, and can enter porous substances—like wood—which cannot be readily touched by quick lime. Moreover, soda is a powerful detergent, a good washer, and removes what would not be attacked by bleaching-powder.

*Condy's Disinfecting Liquid* is a solution of much utility as a disinfectant, but scarcely applicable to the wants of the farmer. In permanganic acid we have oxygen in an active condition, operating as a powerful destroyer of organic matter.

*Fire, air, heat, steam* (at 250° Fahrenheit) readily destroy infectious poison. Boiling water, and, better still, high-pressure steam, completely disinfects meat from diseased animals, and hence may be used for boiling down carcasses of diseased animals, and utilising the fat.

Of deodorisers, perchloride of iron in solution, sulphate of iron, sulphate of zinc, nitrate of lead, chloride of zinc, may be mentioned.

Amongst antiseptics, or preventers of putrefaction, prepared from coal tar, McDougall's and Tomlinson's Disinfectants may be named.

#### THE APPLICATION OF DISINFECTANTS.

Under this head we have to consider the disposal of animals which have died from the Plague, or have been slaughtered on account of it; the disinfection of cowsheds; the disposal of the manure of infected animals; the disinfection of pastures, agricultural implements, and harness. Chlorine, the most powerful destroyer of animal matter, cannot be used in sheds where animals are kept, and manganic and permanganic salts, or Condy's disinfectants, cannot, for obvious reasons, be employed in disinfecting manure-heaps and bulky materials. For all the purposes for which a farmer or dairyman may require to have recourse to disinfectants, his choice of materials may well be confined to chloride of lime, quick lime, and earth, to which may perhaps be added fumigation with sulphur and chlorine. In applying disinfectants like chloride of lime, many persons are unmindful of the fact that all disinfectants must be used in quantity proportionate to the amount of matter or surface to be disinfected; a mere sprinkling will not do. One other general observation: soap or soda, plenty of water, a copious supply of fresh air, are the most important disinfectants on which to rely for the purifying of sheds; for although certain artificial disinfectants are necessary for the perfect destruction of the infectious matter, yet the use of these should always be preceded by the free use of soft soap or soda-ash and water, and be followed up by fully ventilating the place two or three days before putting healthy stock again into the premises.

*Burial of Cattle.*—If animals have died of the disease, where there is a convenient place of burial immediately adjoining the premises where the death has taken place, the carcase should be buried five feet deep, and covered with six inches of quick lime, or, still better, peat-charcoal: the spot must not be near a well or other source of water-supply. If there be no convenient place for burial in the neighbourhood, the carcase should be removed from the premises, and recourse must be had to disinfectants, and the most available would be chloride of lime. For one animal, about 4 lbs. or 5 lbs. of chloride of lime will suffice, which should be mixed with a little water, until it has the consistence of cream, and then combined with 3 pailsful of water and stirred thoroughly with a stick or iron spoon, adding the remaining water. The carcase should be thoroughly mopped over with this mixture, a portion of which should be poured into the mouth and nostrils (followed by a stopping of tow), and a further portion into the rectum and vagina; these to be plugged in the same manner. This is in accordance with the recommendation of the Committee of Privy Council, in cases where burial cannot take place immediately.

In and around large towns, where no convenience for burial exists, the carcase is best disposed of by boiling it down in large coppers by high-pressure steam, which will disorganise and completely disinfect the flesh, entrails, and even the bones; the fat would be available, and the flesh, could be used for manuring purposes. The hides, horns,

and hoofs of diseased animals should be mopped with a solution of chloride of lime— $1\frac{1}{2}$  lb. or 2 lbs. to a pail of water.

Then as to the disinfection of cowsheds and stables. The discharge from diseased animals or their skins is the principal and primary seat of the infectious matter of the Cattle Plague. Therefore, manure which the cattle have made should be disinfected; every part of the shed they have used should be well scraped and washed with soft soap and water, or, better still, with 1 lb. of soda-ash to a pail of warm water, followed by cold water. The pavement should be taken up and cleansed; a hot mixture of lime and water, and lastly of chloride of lime, should be used, and the pavement should be relaid in a fresh bedding of concrete, the old materials being carefully buried; the floor should be mopped over with  $1\frac{1}{2}$  lb. of chloride of lime to a pail of water. The infection might be carried into the walls and rafters; in such case fumigate with sulphurous acid, chlorine, or nitrous acid gas. In order to effect this, all ventilators, windows, and apertures must be closed beforehand to prepare for the fumigation, for the poisonous gas will kill the operator if he does not make a rapid escape after setting the fumigation to work. 1 lb. of sulphur burned on the floor in three or four places, will afford a copious supply of sulphurous acid for a shed which will hold 12 cows. The windows and doors of the cowhouse must be well closed, for otherwise the fumes would create a nuisance in the neighbourhood. This indeed is an objection to the employment of chlorine or sulphurous acid gas in a densely populated locality—remedies which would make the whole neighbourhood cough and run away for safety, if the sheds were in a dilapidated condition, or could not be effectually closed. After the fumigation has been carried on for twenty hours, the shed should be ventilated by opening the windows and doors, and the walls should be whitewashed. If the floors are taken up, cleansed, and relaid in the manner described, and the shed afterwards fumigated and whitewashed, the disinfection will be as perfect as it can be.

#### THE DISPOSAL OF MANURE, STRAW, &c.

Any hay or straw left by the diseased cattle should be burned at once: it would be well if the manure could be burned; but there is a practical difficulty about doing this; for even when a good fire is first lighted, and the manure gradually put on it, the water (80 to 85 per cent.) contained in it will smother the fire, and produce a smoke which might possibly disseminate the Cattle Plague over the land. However, what can be burned should be burned at once, and the manure to be removed should be covered over with lime; not less than 5 cwt. of lime, newly slaked, for a ton or cartload of manure: it would be useless to substitute a small quantity of chloride of lime. The manure should be carted into the field, and covered with earth in alternate layers, ending with earth. As an extra precaution I would cover the heap with peat-charcoal or quick lime. In three or four months there would be a valuable compost heap, which might be spread without any fear of its containing infectious matter. This would be found to be the most practical plan.



In Sweden and France, where a good deal of artificial nitre is produced, urine, solid manure, and refuse are put up in heaps together with earth and lime, and left for six months or more, so as to form artificial nitre beds.

*The Disinfection of Pastures.*—All that can be done is to knock about with the pitchfork the droppings of cows, and then apply a dressing of lime at the rate of 100 bushels to the acre. The air and the soil will do the rest. In two or three weeks, provided rain has fallen in the interim, stock may be safely placed in such pastures.

Articles of small value, such as ropes and half-used-up straps, should be burned or buried. Shovels and stable utensils should be cleansed with soft soap and chloride of lime, half a pound to a pailful of water. Iron is best disinfected by being heated red-hot in the fire.

#### PREVENTIVES.

Are there any means by which the disease can be prevented from extending? Undoubtedly there are. There should be perfect isolation of diseased stock; perfect destruction of the infection by fire, chloride of lime, sulphurous acid, or other disinfectants. Inasmuch, however, as artificial disinfectants, if powerful, cannot always be employed, because themselves destructive to animal life, we are practically thrown on perfect isolation as the only means at present known of securing safety from the spread of the Cattle Plague; and the sooner the farmers and the Government recognise this important fact, and act upon it, the sooner will this frightful calamity disappear from the country.

It is vain to speculate, from imperfectly ascertained indications in physical science, upon the effect which certain substances, recommended as preventives, may produce in protecting healthy cattle, but I do not know of a single case in which it is clearly shown that by placing certain materials in a cowhouse, the cows had been guarded against contagion; spreading about the cowsheds sawdust saturated in carbolic acid might do good; so might Terebane Phenyl, or Macdougall's disinfecting powder, or other preparations which owe their efficacy to the distillation of tar; but experience, our best guide, has not yet furnished us with any decisive facts.

#### EXPERIMENTS WITH CARBOLIC ACID UPON BEEF.

Thinking it desirable that some trial should be made of the anti-septic powers of carbolic acid, I began a series of experiments with 1 lb. of perfectly fresh beef on the 27th of December, 1865.

1.  $\frac{1}{4}$  lb. was placed in a beaker with 2 ozs. of distilled water.

2. Another  $\frac{1}{4}$  lb. was placed in 2 ozs. of a solution of carbolic acid in water containing 1 part of carbolic acid to 1000 of water.

3. The third  $\frac{1}{4}$  lb. of beef was covered over with a solution containing 1 part of carbolic acid in 100 parts of water; and

4. The fourth  $\frac{1}{4}$  lb. of beef was put into a solution containing 1 part of carbolic acid in 50 parts of water.

The four beakers were covered with glass plates and placed side

by side in a room, the temperature of which was  $53^{\circ}$  Fahr. on the 27th of December.

The contents of the beakers were examined from time to time.

1. *Beef covered with Water only.*

On the 1st of January, 1866, the meat in experiment No. 1 began to smell badly, and on the following day it gave off a horrible stench. On the 3rd of January abundance of gas-bubbles were given off from the putrefying meat, and sulphuretted hydrogen was readily detected with lead-paper in the gases generated from the rotten beef.

The temperature of the room during this period ranged between  $53^{\circ}$  and  $58^{\circ}$  Fahr.

2. *Beef immersed in a solution of 1 part of Carbolic Acid in 1000 of Water.*

On the 3rd of January the meat was still quite sound. It remained so until the 8th of January, when a fungus began to be formed on the surface of the liquid in which it was immersed, and a few gas-bubbles were also observed to rise from the meat.

On further examination I found that fermentation had set in, and that the watery liquid had a strongly acid reaction, and that lactic acid had been formed apparently in considerable quantities. It is worthy of particular notice that no disagreeable smelling gases were given off on the 8th of January. It is plain therefore that the minute quantity of carbolic acid in the water in which the beef was immersed in this experiment had the effect of retarding the decomposition for 10 days, after the lapse of which it did not enter into putrefaction but into lactic acid fermentation. The fungus on the surface of the liquid rapidly increased, and after a few more days a slightly disagreeable smell gradually became perceptible. Examined again on the 15th of January the fungus was found completely to cover the surface of the liquid, and the smell given off from the meat was decidedly bad. The next day it was worse, and the stench became so intolerable on the day following that the meat had to be thrown away.

We thus learn from this experiment that a very weak carbolic acid solution, although it greatly delayed the changes which rapidly took place in the meat immersed in water and caused it after a period of 10 days to pass through the lactic acid fermentation, did not ultimately prevent its putrefaction.

3. *Beef immersed in Water containing 1 part of Carbolic Acid in 100 of Water.*

Up to the present date (February 3) the beef in this experiment is still free from any disagreeable smell; the liquid has turned slightly acid and its colour has become somewhat unsightly, but no gas-bubbles nor any trace of fungoid growth are noticeable.

4. *Beef immersed in Water containing 1 part of Carbolic Acid in 50 of Water.*

The meat in this experiment is still (3rd of February) perfectly

sound and unchanged in colour or general appearance since the 27th of December, 1865, when the experiment began.

In the preceding experiments the highest temperature of the room was 61° Fahr., the lowest 53° Fahr.

In the next place I tried the following experiments, partly with a view of ascertaining whether carbolic acid destroyed or merely masked the fœtor proceeding from putrid meat, and partly with a view of ascertaining whether putrid meat is capable or not of tainting fresh meat in an atmosphere strongly impregnated with carbolic acid vapours.

About  $\frac{1}{4}$  lb. of putrefying beef was put into a jar, covered with water, and some concentrated carbolic acid was added. The putrid smell disappeared instantaneously, and I am quite satisfied that the smell was not merely masked but completely destroyed by the solution; for the jar, which previously could not be opened without filling the whole room with an insufferable stench, now gave out no smell but that of carbolic acid perceptible even at its mouth, nor was there any smell perceptible in the further part of the room.

In the next place  $\frac{1}{2}$  lb. of fresh beef was cut into two equal pieces, and  $\frac{1}{4}$  lb. was suspended in a large wide-mouthed stone jar by means of a wire fixed in the cover of the jar.

In the course of 4 days the meat emitted so strong and putrid a smell that it had to be removed.

The second  $\frac{1}{4}$  lb. of beef was suspended in the same manner and at the same time in a large stone jar, in the bottom of which a piece of putrefying meat was placed, after a little concentrated carbolic acid had been allowed to flow round the sides of the jar for the purpose of impregnating the air with the vapours of the volatile acid.

After a lapse of exactly a month the beef in the second jar is free from taint, but of course smells strongly of carbolic acid and is unfit for consumption.

Flesh when immersed in a concentrated carbolic acid solution shrivels up and becomes hard like leather. How long it will remain in this condition I have not yet ascertained, but probably for an indefinite period.

#### EXPERIMENTS WITH CARBOLIC ACID ON RENNET AND MILK.

The object of the following experiment was to determine whether weak and moderately strong solutions of carbolic acid destroyed or left unaltered the peculiar property of rennet to coagulate the casein of milk, or destroyed its active organic principle as chlorine or nitric acid do.

The solution of rennet which I employed was tested in the first place, as it had been made a long time ago.

1. A quarter of an ounce added to two ounces of milk thoroughly coagulated the milk in less than 10 minutes.

2. One-eighth of an ounce of concentrated carbolic acid added to two ounces of milk did not curdle it.

3. In the next place I added to a quarter of an ounce of rennet

one-eighth of an ounce of concentrated carbolic acid, and then mixed the two with two ounces of milk.

The addition of the concentrated carbolic acid prevented the coagulation of the milk.

The concentrated acid thus destroyed the active principle in rennet.

4. Two ounces of the same milk were mixed with a quarter of an ounce of rennet and a quarter of an ounce of a solution of carbolic acid containing 1 part in 1000 of water.

The milk curdled in about 20 minutes.

5. A solution containing 1 part of carbolic acid to 100 of water similarly applied did not prevent the action of rennet.

6. To two ounces of milk a quarter of an ounce of rennet and a quarter of an ounce of carbolic acid solution containing 1 part of acid in 50 of water were added. The milk coagulated in about 20 minutes.

7. Lastly, a quarter of an ounce of the same carbolic-acid solution which was used in the preceding experiment (1 in 50), added to milk, did not coagulate it.

It thus appears that the active principle in rennet is only destroyed or materially altered in character when it is brought into contact with *concentrated* carbolic acid.

Different organic substances most probably are variously affected by carbolic acid, and it is quite possible that, whilst some are more readily altered in their chemical composition than rennet, others may resist its action with greater force. I found that solutions containing 1 part of carbolic acid in 50 of water in some experiments destroyed the power of yeast to cause alcoholic fermentation. I am not, however, prepared to speak decisively on this point until the experiments have been repeated.

The power of carbolic acid to arrest the decomposition of urine I also find to be very great.

The most convenient, and perhaps most efficient, plan of using carbolic acid in stables, cowhouses, &c., is to mix equal parts of water and crude carbolic acid together, and to soak up the liquid completely by dry sawdust. Or two gallons of the mixture may be poured at once over a sackful of sawdust. The sawdust so impregnated may be handled with perfect safety, and when spread about in cattle-sheds will charge the air with the volatile vapours of the most powerful known antiseptic.

The prepared sawdust should be kept in bags, and a little of it spread every morning and afternoon. If it does no good otherwise, it will certainly have the effect of keeping the shed free from the taint of putrid urine and decomposing manures.

Since the effects produced on animals by carbolic acid are very remarkable, and the crude concentrated acid can be purchased at 5s. per gallon, it is desirable to give it an extensive trial as a preventive agent: in one way only can such trials be injurious, if they encourage farmers to become indifferent or careless about perfect isolation—our only effectual safeguard.

In conclusion, vigilance in excluding from farms, as far as practicable, butchers, veterinary inspectors, farm-servants coming from places

where Rinderpest prevails, and all who may have come into contact with diseased stock, cannot be too strongly urged upon all stock-owners.

11, Salisbury-square, Fleet-street, February, 1866.

*Abstract of the Discussion which took place after the Delivery of  
PROFESSOR VOELCKER'S Lecture.*

THE CHAIRMAN (Lord Berners) was quite sure that all present would agree with him that this interesting lecture on a subject of the utmost importance should be published as soon as possible. The lecture contained a great number of practical hints as to the cleansing of sheds and implements, fumigation by burning half a pound of sulphur on the floor, limewashing, and ventilation, all of which could be done with materials at the hands of every farmer. He agreed with the lecturer as to the difficulty of getting rid of manure by burning. But how would it be affected if treated with lime in the way proposed? Would not the ammonia be volatilised, and might they not in such a case use gypsum to fix it? And did the Professor think it would be safe to turn the heap of infected manure and earth, disposed in layers as he had described in as brief a period as he had named?

PROFESSOR VOELCKER replied in the affirmative. In answer to the question as to the effect of lime on the manure-heap, he said that fresh manure contained scarcely any ammonia: the ammonia was produced during the decomposition, and therefore it was not desirable to mix lime with *rotten* dung.

THE CHAIRMAN: You would use it while the manure was green. There was another important point. They all knew that there was no greater fertiliser than the carcase of an animal. Supposing then a diseased animal was buried, would it be safe to use the body as manure three months afterwards, or in what time?

PROFESSOR VOELCKER: I would leave the diseased animal in his grave.

THE CHAIRMAN stated that some time ago he had a tank, near where he kept his prize stock, which smelled very disagreeably. One morning he found the tank covered with a thick green slime, and ordered a bushel of gypsum to be thrown over it: in the afternoon there was not the slightest smell, and the scum was gone, but the colour remained. He constantly used gypsum in his yards, and cow-houses, and pig-houses, and it almost entirely prevented any smell.

Dr. CRISP remarked that the learned Professor had much simplified the subject of the Cattle Plague, when he stated that it originated in living cells. He had himself examined for a long time the excretion of animals dying from Cattle Plague, but with no higher power than 500 or 600. He would like to ask what power was used in the discovery of the cells, and were the cells peculiar to the Cattle Plague? Monads and other animalcules were found in scores of animals. Was

there in the Cattle Plague a peculiar cell? It was most important to know that this was a statement that could be depended upon.

Mr. LEES remarked that a more powerful analyst than the microscope was the screen, the action of which was most extraordinary. Had these cells been examined in that way?

PROFESSOR VOELCKER said it was not his intention to touch upon the medical question. He merely alluded to it in order to have a convenient opportunity of showing that we had to deal in this disease with a material substance. He could not say whether the microscopic cells were in existence or not. He had no intention to open this question, although it was most important that we should know whether the disease had a material origin.

Mr. TORR asked what proportion the acid bore to the sawdust?

PROFESSOR VOELCKER said the sawdust should be mixed with about 20 per cent. of carbolic acid.

Colonel TALBOT said he was a practical farmer, holding a dairy-farm close to London, and the owner, during the last five months, of 100 cows, not one of which had been attacked by the Cattle Plague till last Thursday (December 7th). When the plague was first heard of, being of opinion that charcoal would be a good antiseptic, he gave his bailiff orders to administer to each cow a quarter of a pint of prepared charcoal daily, and an ounce of nitre dissolved in a pint of cold water each other day. His bailiff, a practical man, who had for twelve years had the charge of 300 cows, told him a few days afterwards, that the unpleasant odour of the cows' breath, which he had experienced in drenching them, had disappeared. He also used very largely Burnett's Disinfecting Fluid, which he believed was chloride of zinc; he used it freely in the drains, with a watering-pot, and poured it about the sheds and mangers. He also lime-whited the buildings. The result was that the sheds were perfectly inodorous, although generally the smell of a cowshed is discernible two or three hundred yards off. The animals were bought at farm-houses, and not at fairs and markets: and when they reached home they were washed with Burnett's Disinfecting Fluid. They were kept in the most perfect isolation that he could devise; but yet, after all, the plague at last attacked them.

He could not in any way trace the origin of the disease. It attacked an old cow; not one of the new ones. He had read everything that had been written on the subject, and by chance he heard of a medicine called *Worbena*,\*—a most potent medicine. On Friday night last he had 11 cows suffering from the plague. One of them he treated homœopathically, and she died. The other 10 he treated with the *Worbena*. To-day 6 of them had perfectly recovered, and one yielded 19 quarts of milk a-day; and they were so ravenous for food, that they were eating haybands.

The proper course to pursue was to watch with the greatest care every animal in the herd and the moment they found any one the

---

\* Col. Talbot has since informed the Editor that this, and all other remedies he had tried, proved ineffectual at last.

least off its food, treat it as if it had the plague. He would administer an aperient, 1½ lb. of treacle, 2 or 3 ozs. of salts, 2 table-spoonsful of sulphur, and a bottle of Day's Fluid: he would allow that aperient to work for 12 hours, and then administer the Worbena. If this did not cure the animal in two days, they should adopt further measures. He would cover the animals, as recommended by Mr. Graham, with three wet rugs and three dry ones, to produce perspiration, and if this did not succeed, he would proceed thus—he had a cow under treatment of this sort—he had her stomach rubbed with turpentine and mustard, two seatons placed in the stomach, and the whole covered with a hot poultice. What the result would be he did not know.

The CHAIRMAN thanked Colonel Talbot for giving the meeting the result of his experience; he imagined that the precautions taken by the gallant officer had rendered his animals less likely to take the disease.

Professor VOELCKER said he had had no experience of the effect of charcoal taken medicinally.

Mr. RANDALL said the Professor, in speaking of the probable means of preventing the plague, had insisted on the necessity of perfect isolation; but when the fields were near to roads, it was impossible to prevent the men from treading on the droppings of diseased cattle, and bringing the taint into the fields. He would suggest that lime should be spread in the gateways and approaches to the yards.

The Earl of SHREWSBURY proposed a vote of thanks to the Professor for his kindness in delivering his lecture, the ability he had shown, and the good advice he had given.

Mr. J. J. LUNDY remarked, that though there was no ammonia in green manure, ammonia made its appearance in 48 hours. He dissented from the suggested use of the quick lime, and advocated the use of the permanganates.

#### IX.—*On the Management of Ponds and Wells.* By R. ORLEBAR.

ONE cubic inch of rain represents a fall of 100 tons of water per acre! So says that most accurate of calculators, the Registrar-General; and the calculation is easy of proof. Now the average annual rainfall of England varies from about 20 or 25 inches on the east coast, to 40, 60, and 80, or even more, on the hills and on the west coast. Supposing that we take 30 inches as the average, we find that 3000 tons, equal in round numbers to about 13,000 hogsheads of water, are showered down for every acre of England, at some time or other in the course of the twelve months.\* Yet all England has, so to speak, been starved for

\* It may of course be objected that a fall of 40 inches in one place does not compensate for one of only 20 inches in another; but I think even the small fall of 20 inches may, with care, be made to provide a supply sufficient for all ordinary occasions.

want of water. Most incumbent is it, then, upon every thoughtful man to try and remedy the waste which evidently must occur somewhere; and to inquire how the bountiful supply from the skies may be best husbanded against a period of necessity.

In cities and large towns the demand for water—the most important, perhaps, of all the commodities of life—is such, that even a slight deficiency in the usual supply causes so great inconvenience to all classes, that a remedy more or less expensive is sure to be applied almost as soon as the want has made itself known. But in rural parishes, the case is very different; and there are two main reasons why this is so. One, and probably the chief, is their poverty and general inability to carry out, unaided, any great enterprise; while the other is the apparent mental apathy of men bred and born in the country as compared with the inhabitants of towns, whose energies are daily and hourly rubbed up and sharpened, as it were, by intercourse with their fellows. Most of us who live in rural parishes, are more or less dependent upon agriculture for our daily bread and daily occupation; and agriculture in its turn is so dependent upon seasons and the weather, that we country people are too apt to imagine that other things are equally dependent upon the same source: we think what is to be is to be; and so, resigning ourselves to our fate, we often overlook a remedy which really lies within our own power.

It is clear from the above-quoted statement of the Registrar-General, that there can be but few parishes in England in which, supposing that there were no waste, sufficient rain does not fall to provide an ample supply of water for all agricultural and domestic purposes. Our inquiry, then, should rather be directed towards the ascertainment of the best means of storing up our supply, than of increasing it or creating a new one. It is not my present purpose to trace the origin and extent of that great fresh-water ocean which is beneath our feet, or to treat of springs—the overflowing of that vast bed of water, but rather to inquire how a sufficient supply of water may be obtained and kept in those places where the springs are too deep to be easily or cheaply available.

This must be done by means of ponds or wells, open or covered reservoirs. First, then, let us inquire as to ponds. Most rural parishes have some of these about the farms or close to the villages. But of what sort are they, in what situations, and how are they treated? Too often they are but wide shallow pools, giving off plenty of damp and fog in winter, while in summer they are perhaps quite dry, or at best contain but a few inches of clear water above a deep bed of slush and mud. The deepest part of the pond is almost invariably the farthest from the mouth,



consequently, when cattle go to drink, they trample further and further into the mud, as the water recedes before them, and the mud consumes almost as much, if not more than the cattle, themselves.

Every pond should have a mouth, if only for the convenience of cleaning it out; but most assuredly that part which is nearest to the mouth should be the deepest; and I would have the whole pond so constructed, with a regular slope from every part towards the mouth, that the last cupfull should be found there. Those who resort to it, be they men or cattle, would then have the water always fresh and clean, and there would be no occasion for them ever to advance into the pond beyond the mouth. Lest, however, cattle should be tempted by the heat of the weather to bathe or stand in the pond, I consider it very important that a line of posts and rails should be erected across the pond, just in front of the mouth. The mouth itself should be a gradual slope from the surface of the ground down to the level of the bottom of the pond; and it is only true economy to pave or pitch it, so that the cattle may stand on a hard bottom. This pitching should be of good sound flattish stones, set up edgewise, and filled in with sand and lime. Pebbles and round stones do not answer, as they are very slippery for stock to stand on, besides being liable to get kicked up, and moved from their places. The bottom course should be a good piece of oak timber, well pegged down to two or three stout piles, to prevent the rest of the pitching from slipping by degrees into the pond. This pitching would be of great help, too, in case of its being necessary at any time to send a cart down for water. For my own part, however, I should say that, never on any pretext, should a water-cart be sent down the mouth; but I would use a small hand or garden pump, and, by means of two short pieces of hose, pump the water into the cart while standing on the level; for I am convinced that by this means much waste both of water and labour would be avoided, besides wear and tear of horseflesh, and damage to the pond.

I would next call attention to the very great importance of making ponds sufficiently deep. Many ponds will hold water throughout an ordinary summer; but directly that an unusual drought comes, and the want of water is really felt, it may be said without exaggeration that four ponds out of five are suddenly found to be dry. Whatever may be the superficial size, there should be a minimum depth of not less than six or eight feet at the mouth, which is, as I said before, to be the deepest part. By every additional inch or foot in depth, a great hoard of water is most economically stored up; for a small, deep pond has three great advantages over a larger and shallower one. In the first

place it occupies less space ; secondly, it loses less in proportion by evaporation, from its smaller surface ; while thirdly, when the water gets low, that which remains is effectually shaded by the high banks.

This mention of shade brings me to another important item in the design of a pond. It is astonishing what an effect a little shade has in checking evaporation. A pond that is well shaded will hold water for weeks after one of equal dimensions, but lacking shade, has become dry. Yet how recklessly this very summer have I seen men cutting up every bush and tree round the banks of their ponds. True, a few leaves may drop into the water ; but if the pond-owner will only take the trouble to observe the marvellous tenacity of a thoroughly saturated leaf, he will, I am sure, be soon convinced that many an autumn must pass away ere the accumulation of leaves which may *drop*\* into his pond can do him any harm. Always, therefore, if possible, have the mouth of your pond on the north side, and shade on the south. The best shade is that given by fir-trees, for they give it all the year round. Moreover a less quantity of leaf falls from them than from other trees, and that which does fall, being specifically heavy, falls straight, and is not likely to be blown by the wind when fallen. Neither are the branches of fir-trees as liable as others to die and fall off, unless they are allowed to grow too thick together. It is a maxim among those who cultivate the fir for its beauty, that no tree of this sort should ever touch its neighbour. At the same time, in exposed situations, they must not be planted in too narrow a belt, or the wind will blow through and stunt them all. It may be as well, too, to remark that the Scotch fir, from its more hardy habit, is infinitely better adapted for exposure than its more delicate congener, the spruce. The yew would, perhaps, be even better for shade than the fir, but for its poisonous qualities. After the fir, I doubt whether there is, on the whole, any better plant for shade than the hawthorn bush. Its leaves sprout early, and fall late ; and it possesses, besides, the great advantage that it forms its own fence ; for it is of great importance that a pond should be well fenced, and no access allowed to it except at its appointed mouth, otherwise there will be danger of children and cattle being drowned, to say nothing of banks broken and trodden into the water.

I have so far endeavoured to show what I consider to be the proper construction of a pond, where only a single mouth is

---

\* The case would of course be very different where a pond is surrounded on all sides by many trees, or is fed by a ditch or brook which will bring leaves from elsewhere ; but then the mischief is caused by the leaves which are *blown* or *brought*, not by those which *drop* into the pond.

required. It remains to see what is the best situation for such a pond, and then how far its construction may be modified by its situation.

Our forefathers appear to have adopted the plan, in very many parts of England, of digging their ponds in the middle of the field; and as a consequence each farm was provided with almost as many ponds as fields. To their ideas, a pond evidently was a pond, and they fancied that the more ponds they had, the better were they supplied with water. The last two seasons, however, have shown the fallacy of this reasoning, and we have discovered to our cost that the title of pond was too often an empty one.

Now-a-days every pole of ground is so much more valuable than it was in the time when these old ponds were dug, that few farmers can afford a pond to every field. It is, therefore, an object to make the same pond serve for two or even four fields. If for the latter, it must of course be in the corners of the fields; and when we reflect on the great and constantly recurring inconvenience arising from a pond in the centre of a ploughed field, it will be seen that, *ceteris paribus*, the corner is the best place for a pond, even where it is required for one field only. It is impossible to plough quite into a corner, therefore the space may as well be occupied by a pond as become a receptacle for weeds and rubbish. In a field of good permanent pasture, which is never likely to be broken up, there would be, of course, no more land wasted by a pond in the centre than by one in the corner; but my previous remarks upon shade and fences prove, I think, that the corner is, in this case also, the best site.

There are several matters, however, besides convenience, which the digger should take into consideration before he commences a new pond. He should ask himself whether, in the first place, the spot selected is likely to gather a sufficient supply of water; and, if so, then whether it is likely to hold what it has gathered?

Now it is well known to scientific men that a rain-gauge placed upon the ground gathers more water than one raised a few feet from the ground; in fact, that the higher the gauge is placed, the less rain does it gather. The reason of this is that every drop has, in its descent, to pass through a very humid atmosphere, and by the law of attraction is continually aggregating to itself moisture from this atmosphere until it reaches the ground. It is clear, therefore, that the nearer to the clouds each drop is arrested, the smaller in proportion it will be. It follows from this reasoning, that the lowest part of a field will gather the most rain;

and if a pond be placed there, drains from the rest of the field can in addition be brought into the pond. Nor, unless the land is very flat, need the waste-pipe (which is in effect but a continuation of a drain) be placed quite as low as the supply-pipe; for I have often seen water running fast into a pond from a drain whose mouth was considerably below the surface of the water in the pond. At the same time, as the bulk of water in the pond *must* have a tendency to hold back the water in the drain, I dare not recommend that the waste-pipe should ever be more than 12 or 18 inches higher than the supply-pipe, and then only in cases where the land to be drained is some feet higher than the surface of the pond, otherwise I should be particularly careful to keep a clear fall of some depth below the supply-pipe.

By thus draining a field into a pond, or in other words, making a pond at the mouth of a drain, a good supply of water may often be obtained in summer from a thunder-shower, which would otherwise have raised the pond only an inch or two; so that this single advantage often makes a very small pond, or even a good deep hole at a drain's mouth, equivalent to a large pond in a worse situation.

Need I remind my readers that rats, rabbits, and foxes are very fond of frequenting drains? Indeed I once knew a 4-inch pipe between two ponds blocked up by the bodies of two eels which had tried to pass each other in opposite directions. All danger, however, of this sort may be easily avoided by the simple precaution of inserting between the two last pipes of the drain a piece of perforated zinc, or galvanised wire-netting of a small mesh. But where the water from a ditch is conducted into a pond, it is very essential to filter it through a strong close wattle, or better, through two, at a distance of a few feet from each other; otherwise the pond will be soon choked up, the ditch proving of more harm than good.

We now come to the second question, viz., is a pond in this lowest part of the field likely to hold water? And here the would-be pond-digger will find a small acquaintance with geology very useful. If he knows what stratum is subjacent to the surface-soil, he can tell to what depth he may safely penetrate. Should the stratum be porous, as sand, gravel, or limestone, he must not dig down to it, for he could never *depend* upon his pond holding water, except perhaps where the adjoining country is almost a perfect flat; as, for instance, an elevated table-land, or low-lying meadows, where gravel is often a good water-bearing stratum. If, however, there is any fall of the land in the neighbourhood of the pond, a porous substratum will be almost sure to let out the water. It is possible, certainly, so to puddle the bottom and

banks with clay, that leakage may seldom occur; but the process is costly, besides the constant danger of cracks coming through heat or accidents.

Unless, therefore, the pond is likely to hold water in the lowest part of the field, the digger must choose some other spot. And the next best site will, nine times out of ten, be in the highest part; for I have shown already that nearly everywhere in England sufficient rain falls to give directly a fair ordinary supply of water, apart from that which may be *derived* from drainage. Trusting, then, that his pond will be filled from the skies, let the digger select as flat a place as he can, and this, if not at the lowest, will, I think, be more often found at the highest part of a field than at any intermediate level. Above all things, let him bear in mind that it is almost useless to dig a pond on the side of a hill, where there is anything like a sharp fall below the pond; for the law of gravity will certainly cause the water to ooze out below, unless the subsoil is a regular stiff clay. Such, and indeed most ponds, will hold plenty of water in winter; but our object is to discover one that will not fail in a dry summer.

Let us next briefly consider the third point, namely, the treatment of the pond. The pond is too commonly left to take its chance. When cattle want to drink, they are allowed to go into it as far as they please; if water from it is wanted for another place, the water-cart is backed down deep into its muddy bosom; and when, at the end of some dry summer, the pond also is found to be dry, a few loads of mud are taken out of that part farthest from the mouth, the sheltering bushes are cut down, and the pond is declared to have been well cleaned out. Such treatment will, no doubt, enable the pond to hold water till the next dry summer comes, when in all probability it will again fail, and the unfortunate proprietor will wonder to himself and complain to his neighbours that he cannot anyhow get his pond to hold water. If, however, anyone will take the trouble to wade through this essay, and adopt the course suggested by it, I can promise him that he may, if he likes, wade also up to his neck in his own pond at the end of the next dry summer, and the expense shall be less, on an average of years, than he is now put to by the constant expense of carting water from a distance, to say nothing of the partial cleanings out, which under the old system occur so frequently. I repeat, then, never on any account allow cattle to go further into the pond than the edge of the pitching in the mouth. To prevent this, it is absolutely necessary to have a line of rails, or a chain, or some such obstacle, across *each* mouth of the pond. As regards the use of the water-cart, I need only refer to what I have before said on this subject. And lastly, as regards cleaning out, I maintain that a pond made, placed, and

treated as I have recommended, will hardly ever require that process. But if, in the course of thirty or forty years, it should appear to be getting more choked up than is desirable, I would advise the owner, instead of waiting till it dries itself, to take an opportunity (say after harvest) of pumping out the water that may be left. He might then leave it to dry for a few days, and as soon as he begins to clean it out, let him put several hands on at once and get the job done quickly and well, taking care to keep the bottom in its proper shape, and to repair the pitching and rails if necessary. I have known so many instances where a pond has been partly cleaned out, and the remainder of the work stopped and spoiled by a heavy rain, that I wish to urge the advisability of not loitering over such a work. If rain comes on when the mud has been removed from only a part of the pond, the mud in the other part is again floated, and comes back to spread itself over the clean, and so lower part. Where a large pond has to be cleaned out, it is a great help to the men to attach a horse by a long chain to the wheelbarrows. Each wheelbarrow, when loaded, is placed on the plank; the horse draws it up to the tipping-place, where the man tips it, unfastens the chain, and returns on the down plank, the horse also returning for the next load.

I have now exhausted all the suggestions which I have to offer about ponds; but before quitting the subject I should like to add a few words as to the great importance and desirability of having a large deep reservoir close to every good homestead. I know of a case where a landlord dug one for his tenant (the latter finding the carting), and the very next year the tenant's stacks were all burnt down by an incendiary, as is supposed; and there is not the slightest doubt but that all the landlord's buildings would also have been consumed if there had not been a copious supply of water from the reservoir, just dug, so close at hand. As it was, the buildings were hardly injured at all. This, of course, is an extreme case; but the value of a good supply of water at the commencement of a fire is almost beyond calculation. In the eastern and midland counties it is generally difficult to get a large *natural* supply of water at any distance from the villages, which always congregate round the springs. But it is very essential for farm-premises to be as near as possible to the centre of the farm, often many miles away from any stream or spring. A pond, then, or a well, is all that can be looked to for the stock or for a fire; and in the latter case a pond is, of the two, decidedly the more useful, as several engines may be fed from it at the same time, leaving plenty of room for labourers to dip their buckets.

A deep well is very expensive to dig, besides the risk of not

finding water when you have penetrated as far as means or inclination allow; and any well, where the water lies at more than about 26 feet from the surface of the ground, requires a costly pump. I consider, therefore, that for farm-buildings, where there is no other supply, the best plan is to make a good wide well (for a pump), about 26 or 28 feet deep, and to dig, a few yards off, a really useful pond. Let all the water from the spouting be conducted into the well, and make a waste-pipe from near the top of the well into the pond. Thus, in a dry time, a shower will fill the well first, and the surplus, if any, will be saved in the pond.

I will conclude with some remarks on springs and wells in connection with the water-supply in rural parishes. A well without a spring is, in reality, only a covered pond, though, being covered, it suffers no loss from evaporation by either sun or wind. In some places a well sunk to a given stratum will be quite sure to find water, while in other localities the springs are so precarious that one well may never fail, though another, a few yards off, may be worthless. A gentleman of my acquaintance had a tolerably good well, about 25 feet deep, which never failed for many hours together, though it had no great supply. He was wise enough not to tamper with this, but wanting more water, dug another well a few yards off. Having dug down to about 50 feet without finding any water at all, he bored down still deeper, until at last the water rose into the bore with a great rush, and he fancied he was going to have a grand supply. The next morning, however, it had all vanished, and he could never again get any water there. He had, in fact, tapped a spring; which, almost as soon as it was tapped, lost itself again through a vein of sand. Strange to say, the original well was in nowise affected by the new one.

But here let me say a word of caution against a deception which I have known to be practised by professional well-borers. At a certain homestead a well was dug down to a limestone-rock without finding any water; the borers were then ordered to pierce the rock till they did find water. The men accordingly spent some days at the bottom of the well, and professed to have bored to some unheard-of depth, but without success, and the job was reluctantly given up. For some years the tenant was put to the expense of carting water from a distance almost every day. At last, however, he engaged a man, who had been successful with a deep well in a neighbouring parish, to try and obtain water for him. This man examined the well, and feeling sure that there must be water in the rock, he began to excavate. The work had proceeded very little way before he discovered that the original borers had only-penetrated about *two feet* further than the well,

though they had been paid for I don't know how many feet. Encouraged by this discovery he renewed his work, and was very soon rewarded by an ample supply of water.

We often see springs issuing from the ground and running to waste, spoiling perhaps a considerable piece of ground before their water is collected into a ditch or other channel. If the owner would only take the trouble to follow the spring back into the ground for a few feet, and place in it a draining-tube which should empty into a small tank or tub let into the soil, with a waste-pipe at the opposite side, he might have an excellent supply at a minimum of cost; and two loads of stone, placed round the tank to give firmness to the earth, would make it as good a drinking-place as could be desired.

Again, in many places a brook, which is often dry or nearly so in summer, may be made to give a certain and ample supply all through the year by erecting sluices across it at intervals; and though the cost of this is considerable, yet it will often pay, simply by making the brook a good fence instead of a bad one.

Lastly, a few words about spouting. Spouting is, I am well aware, expensive in the first instance; but were all the cottages in a village and all the buildings on a farm well spouted, and the water conducted into *capacious* tanks or wells, many places which now constantly suffer from lack of water would hardly ever know the want. And I think that at least half the cost of the spouting would be saved in the item of repairs to the buildings; for nothing makes a wall more damp, or saps the foundations more surely, than a dripping eave.

In conclusion, let me remark that, although we cannot actually increase the supply of water which nature provides, nevertheless by management we may obtain more of that supply for our own use, and by care we can keep what we obtain.

*Hinchwick Hall, Wellingborough.*

---

X.—*On the Comparative Cheapness and Advantages of Iron and Wood in the Construction of Roofs for Farm-Buildings.* By ARTHUR BAILEY DENTON (Junior).

PRIZE ESSAY.\*

FOR some years past the minds of practical men have been advancing towards a conviction that increased covering, under

---

\* One of the Judges reports as follows:—

The opinions of the Essayists seem to be nearly unanimous on the following points, viz.:

1. That timber grown upon estates in Great Britain should be disposed of for



most conditions of climate, is advantageous alike to all the produce of the farm; that, provided light and ventilation be given with proper regard to temperature, live stock will thrive better, dead stock will last longer, manure will be better made and preserved, and corn and hay crops will be better harvested and brought into condition for sale, under permanent covering than when exposed to the elements, or left to the chances of being thatched at the right season.

The acceptance of this truth prevails with greater or less force as we pass from the cold of the north and the rain of the west, towards the warmth of the south and the dryness of the east, and as we recognise the degree of necessity that may exist for economising straw.

It is not my present purpose to dwell on the value, in a commercial sense, of covering fold-yards, stock-yards, or manure-heaps, though it might be easily shown that in each case true economy is best served by the provision of a greater extent of roofing or shelter than now generally prevails.

It is upon the assumption that, at no distant period, the covering of yards will be generally recognised as the rule rather than as the exception, that the comparison about to be given has been extended beyond the roofs of ordinary farm-buildings to those suitable for spaces, which, fifty years ago, it would have been considered the height of extravagance to think of covering.

To make the necessary comparisons of cost, it is desirable to classify the roofs according to the materials employed.

Thus: 1st. Timber roofs, constructed wholly of wood.

2nd. Timber and iron roofs, constructed partly of wood and partly of iron.

3rd. Iron roofs, constructed wholly of iron.

And it will be necessary to recognise a difference in the roofing of ordinary farm-buildings (apart from the covering of yards) by distinguishing the single-floored buildings, for which a standard width of 20 feet, outside measurement, has been taken,\*

---

other purposes, and good Baltic timber only employed in the roofs of farm-buildings.

2. That for roofs of a span not exceeding 30 feet, there is no economy in using iron in combination with wood, and still less iron alone.

3. That iron does not answer as a roof-covering, unless, perhaps, corrugated iron, and in exceptional cases.

\* The standard widths here selected are taken from 'The Farm Homesteads of England,' a work recently published by Messrs. Chapman and Hall, of Piccadilly. In the "Golden Rules," Nos. 2 and 4, p. 145, the following passages occur:—"All lateral single-storied buildings should, if possible, be made of one breadth; 20 feet outside measurement (brickwork) is considered the best width. The advantage of an uniform width is found to consist in the capability of conversion from one purpose to another, as necessity for alteration or extension arises. All the higher buildings should be of one uniform width. The outside

from the double-floored buildings, for which a general width of 24 feet, inside measurement, has been selected.

In dealing with yards intended for internal subdivision, there is room for much difference of treatment. Where the appropriation of the space can be definitely pre-arranged, the character of the roof can be determined accordingly, and the evil avoided of placing storey posts or columns in places where they may afterwards be found in the way.

Roofs constructed of wide spans to avoid the inconvenience of internal columns, are open to the serious objection that while they are more expensive, the shelter is less complete, and that where erected in exposed situations they are more subject to injury from wind, as well as to changes of temperature, than roofs of small spans.

Before bringing into notice the different roofs offered for illustration, a few words on some leading principles are necessary to simplify comparison.

The desiderata governing the materials and construction of the roofs of all farm-buildings are, strength and durability, an equable temperature, and a comfortable and cheerful appearance in conjunction with economy of cost. All embellishment should be avoided; the best appearance of farm-buildings being that in which symmetry of proportion is combined with propriety of the design with reference to the object of the buildings.

The attainment of these advantages will depend on the nature of the covering, which will rule the form and strength of the framework, and consequently the cost of the whole structure. This general observation includes the "pitch" of the roof, which essentially depends on the covering material employed. Much has been written and said upon this point, and most elaborate tables have been prepared, to prove that the angle of roofs should vary with climate. Without, however, entering upon, or endorsing such a refinement as this, we may accept the following "pitches" as correct for various descriptions of covering.

1st. For straw roofs a pitch equal to one-half of the span; 2nd. For tile roofs of all kinds, a pitch equal to one-third; 3rd. For slate roofs a pitch equal to one-fourth; and 4th. For iron coverings of all kinds, a pitch equal to about one-fifth of the span.

The following is a statement of the weight per square of 100

width will vary according to the materials used; but the best width, measured from the internal walls, is 24 feet. This is found to admit of alteration with the least disturbance of the external shell, and it is well to anticipate a possible re-division of the buildings consequent upon improvements in machinery."

feet (10 feet  $\times$  10 feet) of the various roofing materials referred to, with the relative cost of each:—

Character of the Covering.	Weight per square of 100 feet (10 feet $\times$ 10 feet) of the covering only.	Cost of Materials per square of 100 feet of covering only, exclusive of labour, nails, laths, &c., delivered on the ground.	Cost of covering materials at the Builder's yard.
		£. s. d.	£. s.
Plain tiles .. ..	15 cwt.	1 4 9	1 12 per 1000.
Slates (countess) .. ..	6 cwt.	1 8 4	9 10 per 1000.
Iron (sheet) .. ..	253 lbs.	2 5 0	18 15 per ton.
Iron (corrugated) .. ..	318 lbs.	2 19 0	19 10 per ton.

These several prices, as well as the prices of timber, which will be subsequently given, are quoted as a datum or standard for the cost of roofs, worked out in detail hereafter, *simply for the purpose of comparison*, and they are based upon the assumption that the best materials and workmanship will be employed. They must be accepted with the general reservation, that they will vary with the market prices of different localities, which will sometimes be lower or perhaps higher than the prices quoted.

The effective value of different materials used for covering will vary; each is found to possess some counteracting quality: thus straw, which best preserves an equable temperature beneath, is a wasteful and perishable material for thatch, deprives the farmer of the more legitimate application of straw as fodder and manure, and should, therefore, be discarded from further consideration. Tiles, both plain and pantiles, preserve an excellent temperature beneath them, and, particularly so, when laid upon straw or reed. A preference will be given to plain tiles over pan tiles, because the latter, although somewhat cheaper, are apt to be blown off, and, under general circumstances, present a less pleasing appearance. Plain tiles, on the contrary, have a decidedly neat appearance and agreeable colour, but they are heavy, comparatively with slate, and require to be laid to a higher pitch.

Slates are economical, because, as just stated, they admit of a reduced pitch, and are very durable, but they are quick conductors of heat and cold, unless laid on boards, when they become a very superior, though expensive covering.

Iron covering, consisting of rolled sheet iron, is a ready conductor of heat and cold, and, therefore, must be laid on boards, when it forms an expensive covering. This fact, in conjunction with its readiness to corrode, renders sheet iron, though galvanised, inapplicable to farm-buildings.

The objection to iron as a covering, however, does not apply in the same degree to arched corrugated iron, where the strength thus given to the material renders the employment of trusses unnecessary. It has therefore been much recommended on the score of lightness and cheapness. But experience has proved that it is not durable, particularly when used as covering for buildings where stock are confined; in such cases the corrosion which ensues is, no doubt, in a great measure caused by the vapours which arise from all animals, and from their manure, which influences even galvanism is powerless to resist.

The weight that a roof has to support is of two kinds: one constant, and the other variable. The first is the weight of the roof itself, and the second consists of the external pressure of wind and rain, and the weight of snow when it occurs. The allowance due for wind is taken at about 7 or 8 lbs. per square foot, and for snow at about 5 or 6 lbs. Altogether the weight of the roof, together with the variable pressure of wind, rain, &c., varies from about 23 lbs. as a minimum, to 40 lbs. as a maximum per square foot, the latter is commonly taken as the basis of calculation.\*

The scantlings of the timbers of roofs, sanctioned by the Inclosure Commissioners for England and Wales have been adopted in the several illustrations and comparisons given in this Essay, and as they form the rule for all landowners, who as tenants for life desire to erect farm-buildings, and charge their estates with the cost, it has been considered well to give the Commissioners' minutes verbatim.

“In all cases where fir timber is used, that obtained from Memel or Norway, and battens from Dram, St. Petersburg, or other Norway or Baltic ports, is to be preferred.

“All oak used to be of English growth.

“No timber to be placed nearer to the inside of any flue than one foot.

“All timbers to be cut die square, and to hold the scantlings specified when finished.

\* M. Mathieu, a French engineer, in the ‘Annales de la Construction’ for 1863, makes the following calculations on the same point:—

“If a roof be of slate, we may reckon that the maximum pressure under the most unfavourable circumstances amounts to 125 kilos. per square mètre, distributed as follows:—

Weight of slates, laths, &c. . . . .	35
“ of framework of roof, &c. . . . .	45
“ of snow . . . . .	25
Pressure (ordinary) of wind . . . . .	20
	125.”

This is equal to nearly 28 lbs. per square foot.

ROOFING.

Scantlings of Memel or Norway fir, for the timbers of Roofs, &c., in the following Table, will be sanctioned by the Commissioners, viz. :—

Description of Roof.	Span.	Tie Beams.	Principal Rafter.	King Posts.	Queen Posts.	Struts.	Straining Piece.	Sill Piece.	Purlins.	Common Rafter.	Wall Plates.	Pole Plates.
	feet.	in. in.	in. in.	in. in.	in. in.	in. in.	in. in.	in. in.	in. in.	in. in.	in. in.	in. in.
King Post	18	7½ × 3	5 × 3	4 × 3		3 × 2½			6 × 3½	3½ × 2	4 × 3	4 × 4
	20	8 × 3	5½ × 3	4½ × 3		3½ × 2½			6½ × 3½	3½ × 2	4 × 3	4 × 4
	22	8½ × 3½	6 × 3	4 × 3½		3½ × 3			7 × 3½	4 × 2	4½ × 3	4 × 4
	24	9 × 3½	6 × 3½	4½ × 3½		4 × 3			7½ × 3½	4 × 2	4½ × 3	4 × 4
	26	9½ × 4	6½ × 3½	5 × 3½		4½ × 3			8 × 4	4½ × 2	5 × 3	4 × 4
	28	10 × 4	6½ × 4	5 × 4		4½ × 3½			8½ × 4	4½ × 2	5 × 3	4 × 4
Queen Post	30	10½ × 4½	7 × 4	5½ × 4		5 × 3½			8½ × 4½	5 × 2	5 × 3	5 × 4
	30	9 × 4	5½ × 4		4½ × 4	4 × 3	7 × 4	4 × 4	7 × 5½	4 × 2	5 × 3	4 × 4
	32	9½ × 4	6 × 4		5 × 4	4 × 3½	7½ × 4	4½ × 4	7½ × 5½	4 × 5½	5 × 4	4 × 4
	34	10 × 4½	6½ × 4		5½ × 4	4½ × 3½	8 × 4	5 × 4	8 × 4	4½ × 2½	5 × 4	4 × 4
	36	10 × 5	6½ × 4½		5½ × 4½	5 × 3½	8 × 4½	5 × 4½	8 × 4½	5 × 2½	6 × 4	5 × 4

TIMBER ROOFS, framed wholly of wood.—From causes which need no explanation, timber has been almost exclusively used for roofs in this country up to the commencement of the present century; and timber-framed roofs will still be preferred, to the

exclusion of iron, under certain circumstances. Where wood is plentiful, of good quality, and suitable character and growth, it is decidedly cheaper and better, as will hereafter be shown, for roofs of small spans, not exceeding 30 feet in width, than either wood and iron in union, or iron by itself.

Wood is known to preserve a more equable temperature than iron. Live stock are therefore better housed under wood than iron; and as buildings for stock seldom exceed 20 feet in width, the health and comfort of the stock afford additional reasons to that of economy of cost, for the use of timber in these buildings.

It is a great mistake to suppose that wood, when fairly dealt with, is a less durable material than iron. Timber of suitable character and growth, properly protected when placed in the roof, will last for centuries; and while iron is known to corrode from exhalations rising from live stock and manure, timber, under the same influences, will show no symptoms of decay.

This admission of the inapplicability of iron for the roofing of cattle-sheds is not made in disparagement of its use in its proper place. It is the abuse of timber that has brought discredit upon it. Landowners, in their eagerness to use timber grown upon their estates, frequently employ elm and ash, and sometimes poplar and lime, for the roofing of farm homesteads, and these in an unseasoned condition.

This indiscriminate use of home-grown timber has led to rapid decay in the shape of dry-rot, and to ugly, distorted roofs by reason of the warping of fresh-felled wood; thus turning anticipated cheapness into decided waste. How often do we see used in farm-buildings immature larch, weighing 35 lbs. to the cubic foot, in connection with heavy oak, weighing upwards of 50 lbs. to the cubic foot, without due regard to the difference of weight and quality, conditions contradictory enough in themselves to weaken the best-designed roof.

Practical experience indeed has proved that true economy is opposed to the use of home-grown timber for roofing, and that it is better to sell the wood produced on estates for appropriate uses, and to resort to Baltic timber for the framework of roofs. For this preference two excellent reasons may be assigned: the first is, its superior adaptability, strength, and durability when compared with the ill-grown, sappy, English timber generally employed; the second is, its superior condition for immediate use, owing to its being always seasoned in some degree by the time taken in its preparation and transport to this country. Throughout the examples which illustrate the employment of timber, it is assumed that foreign timber of the kind just specified is used, and that the cost is calculated at the following prices:—

									Per foot Cube.
Baltic fir :—									s. d.
When framed .. .. .									3 4
Unframed for Plates .. .. .									2 10
Cost price in builder's yard .. .. .									2 7

Wood, however, it should be understood, only deserves the preference, to the exclusion of iron, for spans limited to 30 feet. It is true that wrought-iron rods, with cast-iron rafters, shoes, and junctions, are introduced into the trusses of the smallest spans ; but this is simply a fashion opposed to economy. They insure an *appearance* of lightness by the reduced size of the tie and suspending-rods, when compared with the wood they displace ; though they are so heavy when all the metal is weighed as to directly defeat the object professedly aimed at. If this is found to be the case when the materials are compared in the scales, the preference for wood is still more decided with respect to cost of labour, as will be seen by a comparison of the cheapest examples of each character of roofing. The examples given of timber roofs for 20 feet span (outside measurement) are shown on **Sheet 1**, and are four in number. The cheapest is Fig. 1, adapted for slate, and is that most generally adopted by those architects who are more influenced by a regard for economy than appearance. The cost of this roof will be found to be 8*l.* per bay of 10 feet, including one truss, or 4*l.* 3*s.* 6*d.* per square (10 feet × 10 feet) of roof, or 4*l.* 11*s.* 8*d.* for each square of ground (10 feet × 10 feet) covered.

The examples of roofs of 20 feet span, outside measurement, will be found to cost as below :—

Sheet 1.		Cost of Roofing complete per square of 100 feet (10 × 10).								
		Calculated on the angle of the Roof.				Calculated on the horizontal space covered.				
						£.	s.	d.		
Fig. 1	.. ..	Slates	.. ..	.. ..	4	3	6	4	11	8
„ 2	.. ..	Do.	.. ..	.. ..	4	9	7	4	18	2
„ 3	.. ..	Do.	.. ..	.. ..	4	15	10	5	10	6
„ 4	.. ..	Plain tiles	.. ..	.. ..	3	17	1	5	0	1

The examples of timber roofs of 24 feet span, inside measurement, are shown on the same sheet, and are four in number. The cheapest of these is Fig. 5, which is often used in spans from 20 to 30 feet, adapted for slate, and is of the ordinary king-post construction ; the cost is 4*l.* 3*s.* 4*d.* per square, or 4*l.* 15*s.* 10*d.* per square of ground (10 × 10) covered. Fig. 6 is somewhat

more expensive, but still of moderate cost. This form of truss has been much objected to on the ground that its construction is contrary to scientific principles; but its cheapness of cost, in addition to the fact that it gives head-room, has often led to its adoption. This roof will be found to cost 4*l.* 7*s.* 6*d.* per square.

The examples of roofs of 24 feet span, inside measurement, will be found to cost as below:—

Sheet 1.		Cost of Roofing complete per square of 100 feet (10 × 10.)							
		Calculated on the angle of the Roof.			Calculated on the horizontal space covered.				
		£. s. d.			£. s. d.				
Fig. 5	.. ..	Slates	.. ..	4	3	4	4	15	10
„ 6	.. ..	Do.	.. ..	4	7	6	5	0	10
„ 7	.. ..	Do.	.. ..	4	7	6	5	0	10
„ 8	.. ..	Do.	.. ..	5	6	3	5	16	8

As I have stated that all roofs of a span not exceeding 30 feet in width are better constructed of timber than of iron, it might be assumed that this rule applied to roofs of double-storied buildings, without exception; but this is not exactly the case, as there are instances in which iron suspending-rods may be advantageously used in supporting the floor from the trusses of a timber-framed roof.

The following example of a granary, on the late Lord Palmerston's Broadlands estate, shows how this idea has been carried out (see p. 125).

Again, a timber roof, formed by arched trusses of laminated deals, might be given as an exception, in which the use of iron may be advantageously limited to two iron rods, which tie the ends of the trusses, and at the same time support the floor. This roof and floor, shown on **Sheet 2**, Fig. 9, by cross and longitudinal sections, are specially applicable to granaries in which head-room is required; and may be compared with a granary roof on the same sheet, Fig. 10, of a queen-post construction, made wholly of wood, where the tie-beam also forms the floor, which will be found to cost less than the former example by about 10*s.* per square (10 × 10) of ground covered.

Beyond a span of 30 feet, the requisite strength is obtained, when timber only is used, by scantlings, which not only give an exceedingly heavy and objectionable appearance to the roof, but are practically so much more heavy than wrought iron of equal strength as to require walls of a greater thickness, and therefore



of greater cost, than would be required with an appropriate introduction of iron into the truss. This will be shown when I treat of roofs of mixed materials.

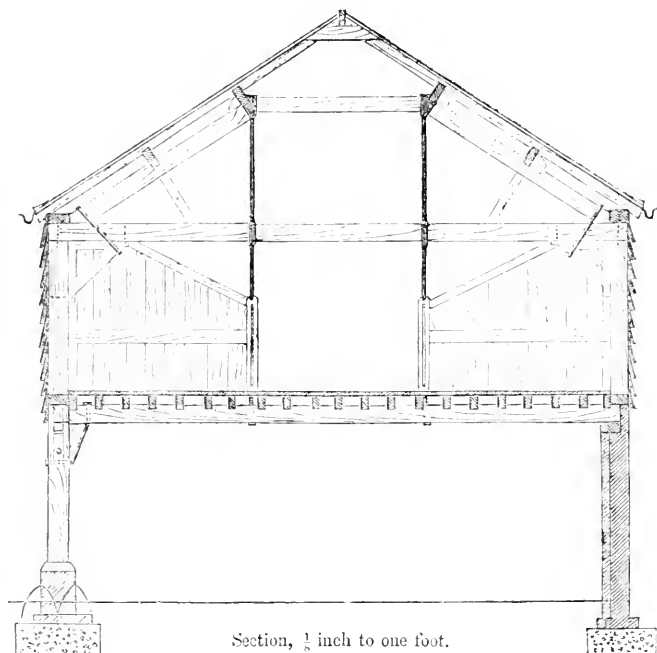

The timber roofs suitable for yards and wide spaces are shown on **Sheet 3**. They are three in number, viz.: Fig. 11, a roof with a span of 50 feet, the cost of which will be found to be 6*l.* per square, or 6*l.* 15*s.* 6*d.* per square of ground (10 × 10) covered. Fig. 12, a roof divided into 25 feet spans, supported on wooden storey posts, the cost of which will be 4*l.* 18*s.* per square, or 5*l.* 14*s.* 7*d.* per square of ground (10 × 10) covered—which shows that by adopting two spans for one in timber-framed roofs, the price is reduced very considerably; and thirdly a roof of somewhat novel construction. In this example the principals, which have a bearing of 24 feet, are placed at intervals of 12 feet. The trusses are framed with a glass front of rough agricultural glass. This arrangement, which secures a perfect light throughout the yard, is shown by the plan and sections of Fig. 13. It will be found to cost 5*l.* 4*s.* 2*d.* per square, or 6*l.* 19*s.* 7*d.* per square of ground (10 × 10) covered.

TIMBER AND IRON ROOFS, framed partly of Wood and partly

*of Iron.*—Iron enters into the construction of roofs in two forms—firstly, in the shape of corrugated or sheet iron, as a covering material, which is elsewhere treated of; and secondly, as part of the framework, in the form of cast and wrought iron, which we will now proceed to discuss.

The relative properties of cast and wrought iron are thus described by Mr. Fairbairn:—

“Cast iron is a hard, rigid, crystalline, inmalleable substance, which presents a great resistance to a force of extension, but a somewhat less resistance to that of compression; and from its low degree of ductility, it undergoes but little elongation when acted upon by tensile force. On the contrary, wrought iron is a flexible, malleable, ductile substance, which presents a great resistance to a force of extension, but a somewhat less resistance to that of compression. From its high degree of ductility, it undergoes a considerable elongation when acted upon by a tensile force. When the two metals are released from the action of a tensile force, the *set* of the one metal differs widely from the *set* of the other. The flexibility of wrought iron is from eight to ten times greater than that of cast iron. Under the same increase of temperature the expansion of wrought-iron is considerably greater than that of cast iron. While wrought iron yields to a stroke, cast iron is readily broken by a severe collision, or by any vibratory action.”

The slight resistance that cast iron, as compared with wrought iron, offers to tensile strains or sudden influences, and its crystalline, brittle, and inflexible character preclude its employment in long lengths, where yielding elastic qualities are required; while its great resistance to the force of compression indicates its adaptability for struts, braces, and straining-bars. But there are two great drawbacks to the employment of cast iron, even in these forms: the first is the weight, the second is the cost in consequence of the weight. Cast iron weighs about 450 lbs. per cubic foot, while the weight of a cubic foot of Memel fir is only  $34\frac{1}{2}$  lbs. The former is consequently about 13 times heavier than wood of equal dimensions. The average cost of iron ready for the founder is 1*l.* 2*s.* 6*d.* per cubic foot, whereas the cost of a cubic foot of Baltic fir ready for the sawyer is 2*s.* 7*d.*—thus making the cost of iron 9 times greater than that of wood of equal bulk. In addition to this it must be remembered that the cost of casting iron for struts or straining-bars is three times dearer than the expense of manual labour in preparing wood for like purposes.

The figures relative to the weight and cost of iron and wood are given by way of preliminary contrast, but do not of course in themselves convey any tangible results, nor supply direct data

for application ; this is better shown by a practical instance. For example, in Fig. 24, **Sheet 5**, a roof of 50 feet span shows a timber strut 4 feet long. This member contains 1152 cubic inches, weighs 23 lbs., and would cost when worked and fixed 2s. 2*d.* ; a strut of cast iron of equal strength, but containing only 366 cubic inches, would weigh 96 lbs., and would cost, taking the lowest price of casting with fixing, 12s. Hence, it follows that economy is better displayed by the use of wood than cast iron, though so much more material is used. If we consider, too, that the risk of an accident from an imperfect casting or a sudden change in the temperature, which may compromise the whole structure, is much greater than if wood were used, we show sufficient reasons why the employment of cast iron should not supersede that of wood for struts in the framework of roofs which do not exceed the ordinary limits of agricultural buildings. For the smaller parts and adjuncts of a truss, however, such as rafter-shoes and junctions, which are many times used in the same form in any considerable length of roofing, and which are better moulded and more economically made of cast-iron than of any other material, the use of that metal is unquestionably desirable ; but the preference of cast iron ends with these minor parts of the roof.

Wrought iron, though not economically admissible in small-spanned roofs, has much to recommend it in connection with timber in roofs of larger spans than 30 feet, for those members of a truss which serve to resist tensile strain, cast iron being used in the minor parts before enumerated, and timber for those members in which rigidity is essential. The advantage of using wrought iron instead of timber for tie and suspending rods will be understood when it is stated, that while Baltic fir will only bear a straining force of 2500 lbs. per inch, wrought iron may be safely strained by 50,000 lbs. per inch, as stated by Tredgold ; or by 60,000 lbs., according to Fairbairn, which shows the superior strength of iron to be from 20 to 24 to 1 as compared with wood. Hence, where rigidity is not required, and the width of the span is sufficient to admit of its adoption with economy, wrought iron may take the place of wood in proportion of 1 for 20 in size ; and as iron is only 13½ times heavier, and only 9 times dearer than wood of equal bulk, the advantage both of weight and cost is in favour of iron : but these figures apply to the tension-rods only. When the rafter-shoes and junctions are taken into consideration, the amounts of weight and cost are altered. An examination of the examples given will show the actual cost of different forms.

The illustrations given on **Sheet 4**, of timber and iron roofs for 20 feet spans, outside measurement, are four in number, three

of which are adapted to slate covering, and one to tiles. The cheapest of these is Fig. 14. It is the common king-rod truss, in which a wrought-iron rod takes the place of a wooden post. Its cost will be found to be 4*l.* 5*s.* 5*d.* per square of roofing or 5*l.* per square of ground (10 × 10) covered. This example of combined materials, when compared with the cheapest roof of the same span framed wholly of wood, shows a difference of 1*d.* per square foot of ground covered in favour of timber.

The next example (Fig. 15) is a form of truss much adopted, for roofs of from 20 to 30 feet span, in France; but, as far as the writer's experience extends, it is not much used in this country. The tie-rods are double; and this arrangement reduces the iron employed to a minimum in size.

The examples of 20 feet span (outside measurement), which include two roofs Nos. 15 and 16, in which the slates are laid upon boards, are as follow:—

Sheet 4.		Cost of Roofing complete per square of 100 feet (10 × 10).						
		Calculated on the angle of the Roof.			Calculated on the horizontal space covered.			
			£.	s.	d.	£.	s.	d.
Fig. 14	.. ..	Slates .. ..	4	5	5	5	0	0
„ 15	.. ..	Do. .. ..	4	17	11	5	12	6
„ 16	.. ..	Do. .. ..	5	4	2	5	16	8
„ 17	.. ..	Plain tiles .. ..	4	11	8	6	5	0

The examples of timber and iron roofs used for 24 feet spans, inside measurement, are also four in number, but any one of the preceding examples for 20 feet spans might safely be extended to wider spans, with a proportional increase of dimensions and cost. The prices of the four examples are as follow:—

Sheet 4.		Cost of Roofing complete per square of 100 feet (10 × 10).						
		Calculated on the angle of the Roof.			Calculated on the horizontal space covered.			
			£.	s.	d.	£.	s.	d.
Fig. 18	.. ..	Slates .. ..	5	0	0	5	12	6
„ 19	.. ..	Do. .. ..	5	4	2	5	16	8
„ 20	.. ..	Plain tiles .. ..	4	19	6	5	17	6
„ 21	.. ..	Do. .. ..	4	15	10	5	15	8

Three examples of economical arrangement of wrought iron in the roofing of agricultural buildings are shown in Sheet 5. In these instances wrought-iron rods take the place of tie-beams

and suspending-rods; timber is used for the rafters and struts, and cast iron for the shoes and junctions, but in each case the quantity of materials is reduced to a minimum.

Fig. 22, is a roof of 35 feet span; it is useful as providing head-room, and has a light appearance. A roof constructed in this form may be seen at Uphampton Home Farm, belonging to Lord Bateman. The cost of this roofing will be 6*l.* 8*s.* per square, or 6*l.* 19*s.* 6*d.* per square of ground (10 × 10) covered. Fig. 23, is a roof for a like span; it has been constructed by the General Land Drainage and Improvement Company at Burleigh, Hertfordshire. The cost is 5*l.* 12*s.* 6*d.* per square of roofing, or 6*l.* 17*s.* 6*d.* per square of ground (10 × 10) covered. Fig. 24 is an example of a light and cheap double tie-rod roof, on the plan recommended by Colonel Emy, the French engineer. Sheet 6 illustrates the covering of yards and large spaces. The prices of the several examples will be as follow:—

Sheet 6.		Cost of Roofing complete per square of 100 feet (10 × 10).					
		Calculated on the angle of the Roof.		Calculated on the horizontal space covered.			
		£. s. d.			£. s. d.		
Fig. 25	.. ..	Slates	.. ..	6 0 10	6	13	4
„ 26	.. ..	Do.	.. ..	6 7 2	6	18	6
„ 27	.. ..	Do.	.. ..	6 5 0	6	13	6

**IRON ROOFS.**—The words “Iron Roofs” are generally understood to mean those roofs in which both covering and framework are wholly of iron, although when speaking of timber roofs, the designation applies to the framework only, since no one concludes that the covering is made of wood.

In treating this branch of the subject it may be better, without discussing terms, to repeat that *iron covering*, for reasons already given, is deemed inapplicable to agricultural buildings, except in the case of corrugated iron, in which the circular form it generally assumes, renders support by framework unnecessary.

The reason why *iron framework* for the support of the covering is not resorted to will be manifest on an examination of the following examples with the relative cost.

They are six in number, as shown on Sheet 7. Fig. 28 is constructed altogether of rolled flat iron. The principals are placed 6 feet apart, and the boards which carry the slates are laid from principal to principal.

The remaining examples of roofs of this span are constructed of rolled T-iron rafters, purlins, and struts.

Here the boards are laid upon the purlins, and the principals are 10 feet apart. The cost of these several examples, including the covering as mentioned in the preceding examples, will be found to be as below:—

Sheet 7.		Cost of Roofing complete per square (10 × 10).	
Fig. 28	.. .. .	£7	8 8
” 29	.. .. .	7	13 9
” 30	.. .. .	8	0 4
” 31	.. .. .	8	10 8
” 32	.. .. .	8	7 4
” 33	.. .. .	9	0 10

These figures, when compared with the preceding examples of timber-framed roofs, prove that it is not economical to resort to iron framework in small spans. Of roofs of 24 feet span, inside measurement, two examples are given. Fig. 35 is constructed of rolled T-iron for the rafters and purlins, and of flat rolled iron for the ties and struts. The cost of this example will be found to be 6*l.* 10*s.* 6*d.* per square of roofing. Fig. 34 is the more expensive example, and is constructed of rolled T-iron for the rafters, purlins, and struts, and rod-iron for the ties and bolts. The cost of this roof will be found to be 6*l.* 15*s.* 7*d.* per square of roofing. For roofing of yards and large spaces two specimens are given on Sheet 8. Fig. 36 represents an arrangement where rolled T-iron is employed for the rafters and struts, and round iron for the tie-rods. The principals are placed 6 feet apart, purlins are dispensed with, but, as in a preceding example, boards stretch from truss to truss. The cost of this roof is 9*l.* 2*s.* 10*d.* per square of roofing. The second illustration, Fig. 37, is of cheaper construction:—three spans in this instance taking the place of two as in the previous case. The cost of this roof will be found to be 8*l.* 11*s.* 10*d.* per square.

Many of our ablest civil engineers have used iron framework for the roofing of railway stations, but as these roofs are generally of large span, and the object for which they are used sanctions more than ordinary outlay, they form no precedent for adoption in agricultural buildings.

Mr. Hawkshaw, the President of the Institution of Civil Engineers has thought it necessary to warn his brother engineers against the use of iron, even when galvanised, for roofs. It should be observed that his observations have reference more to covering than to framework, but they are so decided that they cannot be discarded from consideration. He says, “the result of not more than four years’ wear was such as to convince him (Mr. Hawkshaw), that galvanised-iron ought never to be used for

covering in or near large towns. His experience of it had been such that he had determined never to use it again; and he thought it worth while for those who were constructing roofs of that description, to be careful how they employed that material for roofing in a humid climate, and where coal is used for fuel."

But though this advice applies to all iron covering, we must make a modified exception in the case of *corrugated* iron, which decidedly forms the cheapest of roofs (in its first cost), and, therefore, under special circumstances, may be applicable.

The advantage claimed by its supporters are (1) strength, (2) lightness, (3) cheapness, (4) portability, and (5) simplicity of construction, and there is no doubt that in some measure these qualities are rightly applied, for the arched form in which corrugated iron is used does away with the necessity of any framework beyond a few iron ties to keep the covering in its circular form; it has a light appearance, and can be readily fixed to spans not exceeding 35 feet.

Fig. 38, on Sheet 8, exemplifies this statement. The cost of this roofing will be found to be 3*l.* 5*s.* per square of roofing. These figures, however, should not be taken as representing the actual cost, as it is necessary, in order to preserve corrugated roofing, to paint it frequently.

Still we can believe, that with such a difference of first cost it may be advantageously adopted in situations free from damp and vapour, and where durability is not of the first importance.

CONCLUSION.—Such being the inferences which we have deduced from our experience, which the different examples of roofs given in this Essay will support, it is only necessary here to repeat, briefly, that timber-framed roofs are the best and most economical for spans not exceeding 30 feet; that directly the width of 30 feet is reached, a judicious introduction of iron into the truss reduces the cost, and by giving superior lightness, improves the roof; and that iron alone can only be employed for the covering of agricultural buildings in very exceptional cases, and never economically for the framework.

TIMBER ROOFS.



FOR SLATES.

FIG. 1.

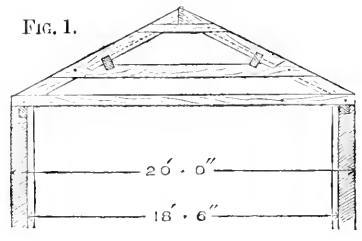

FOR SLATES.

FIG. 5.

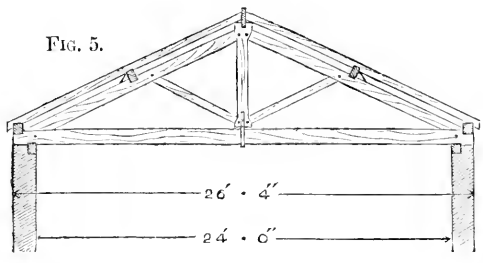

FOR SLATES.

FIG. 2.

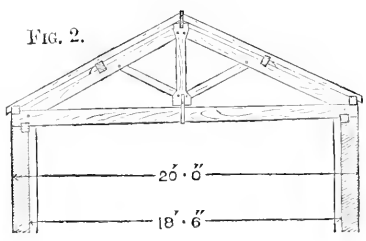

FOR SLATES.

FIG. 6.

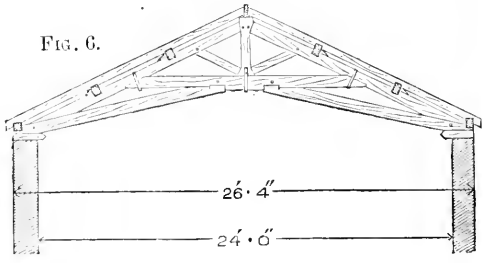

FOR SLATES ON BOARDS.

FIG. 3.

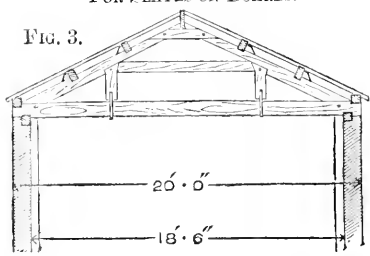

FOR SLATES.

FIG. 7.

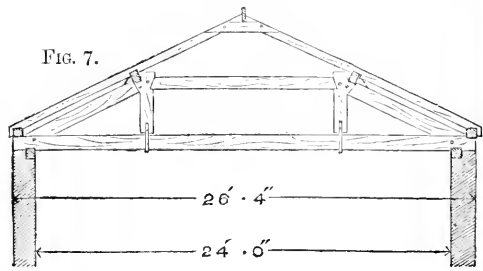

FOR TILES.

FIG. 4.

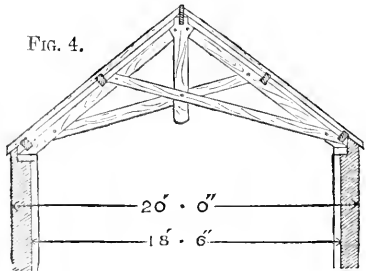

FOR SLATES.

FIG. 8.

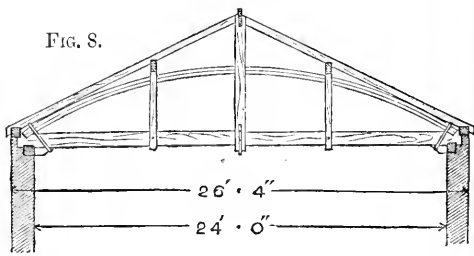

The Scantlings of Timbers shown on this Sheet accord with the Schedule of the Inclosure Commissioners.—See page 121.



FIG. 9.  
FOR SLATES.

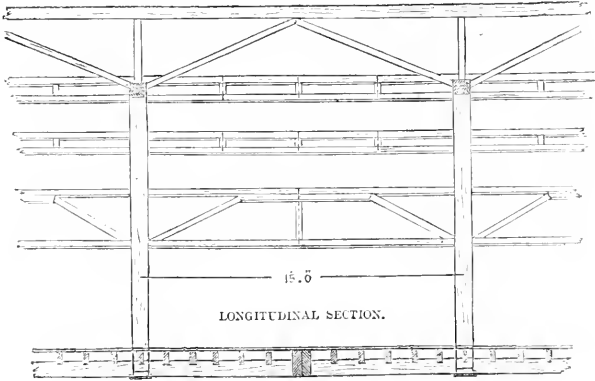
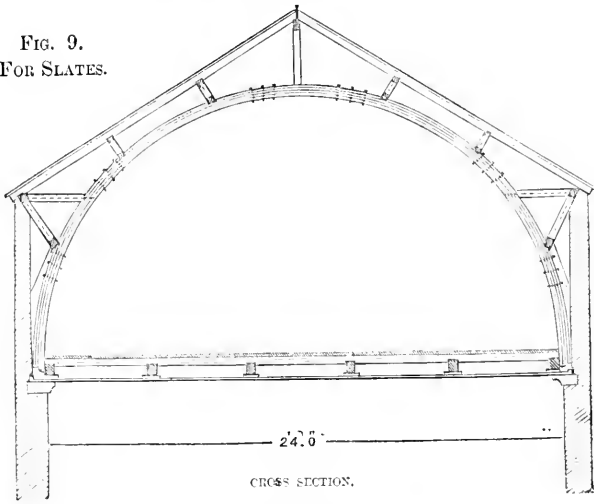
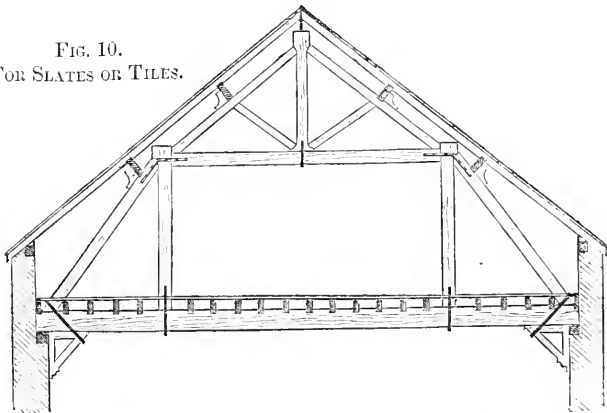

FIG. 10.  
FOR SLATES OR TILES.



The Scantlings of Timbers shown on this Sheet accord with the Schedule of the Inclosure Commissioners.—See page 121.

TIMBER ROOFS.



FIG. 13.

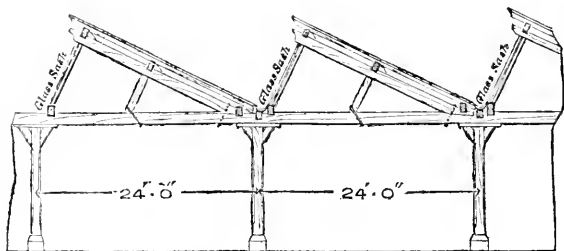
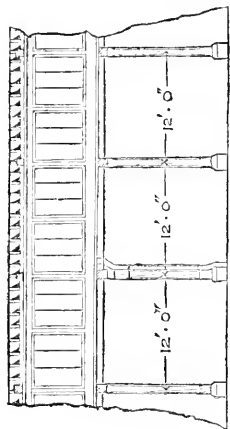

SECTION FROM A TO B

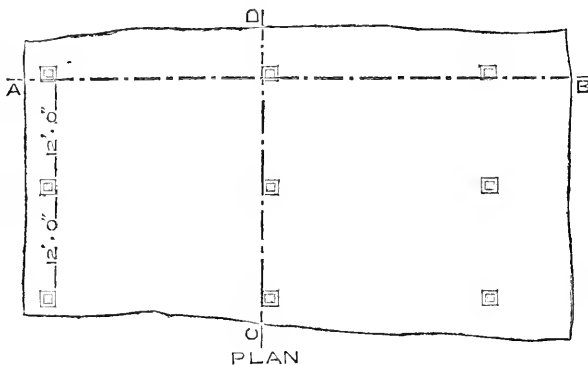

FIG. 11.

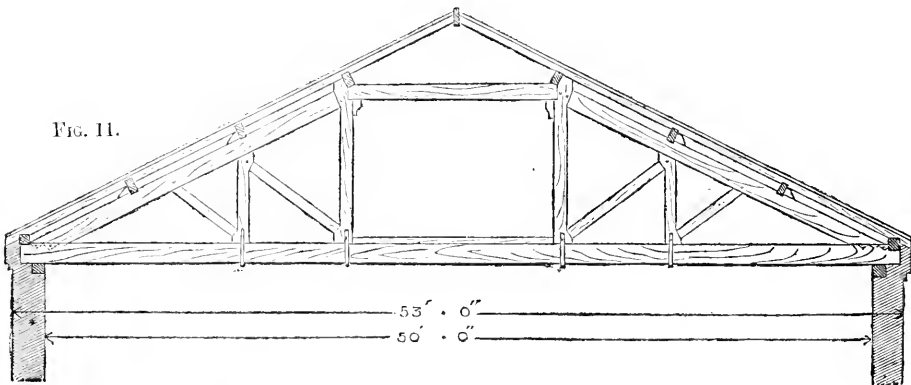
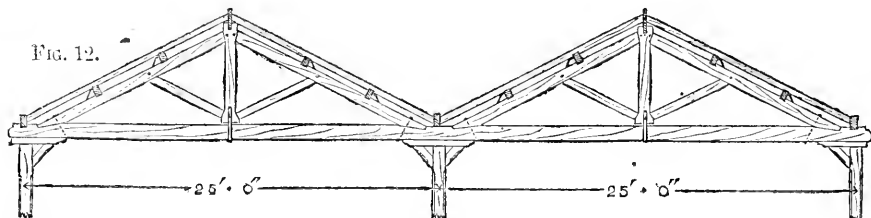

FIG. 12.



The Scantlings of Timbers shown on this Sheet accord with the Schedule of the Inclosure Commissioners.—See page 121.

## TIMBER AND IRON ROOFS.



FOR SLATES.

FIG. 14.

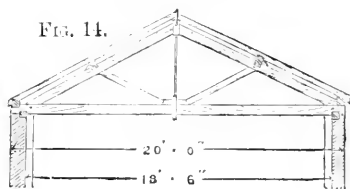

FOR SLATES.

FIG. 18.

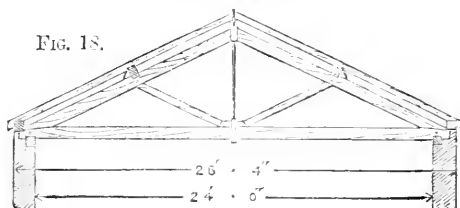

FOR SLATES ON BOARDS.

FIG. 15.

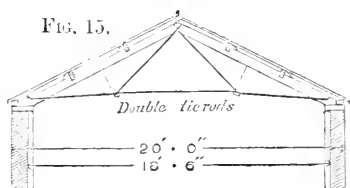

FOR SLATES.

FIG. 19.

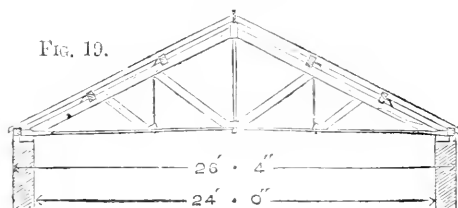

FOR SLATES ON BOARDS.

FIG. 16.

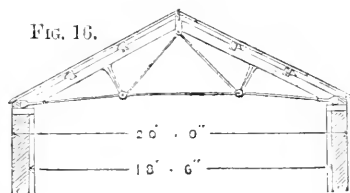

FOR TILES.

FIG. 20.

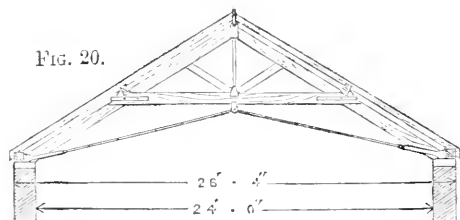

FOR TILES.

FIG. 17.

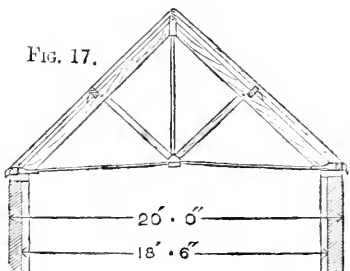

FOR TILES.

FIG. 21.

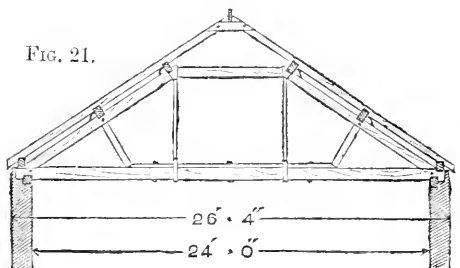

The Scantlings of Timbers shown on this Sheet accord with the Shedule of the Inclosure Commissioners.—See page 121.

## TIMBER AND IRON ROOFS.



FOR SLATES ON BOARDS.

FIG. 22.

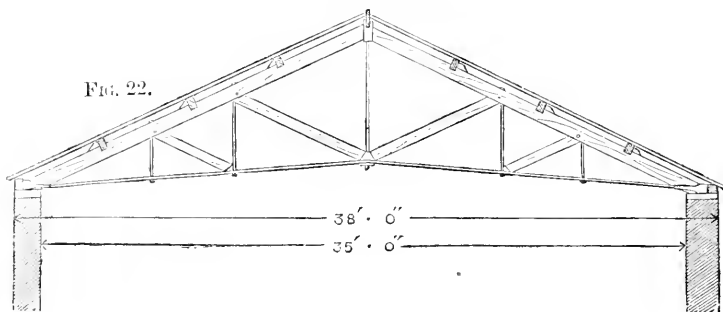

FOR TILES.

FIG. 23.

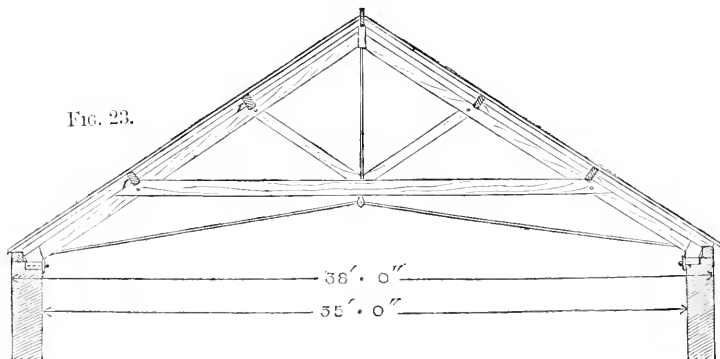

FOR SLATES ON BOARDS.

FIG. 24.

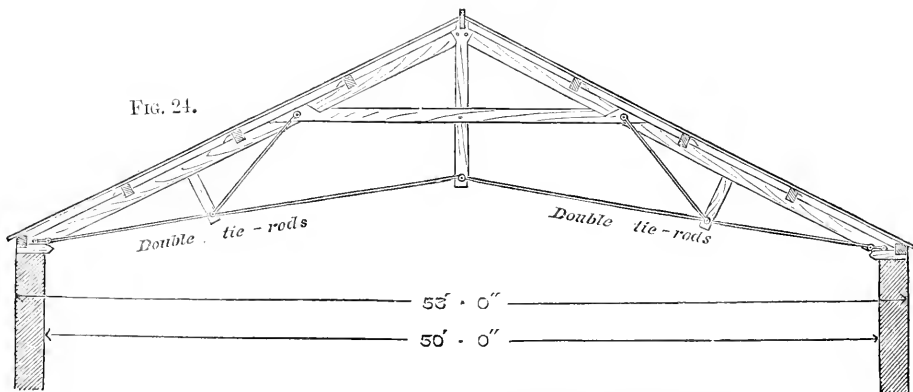

The Scantlings of Timbers shown on this Sheet accord with the Schedule of the Inclosure Commissioners.—See page 121.

TIMBER AND IRON ROOFS.

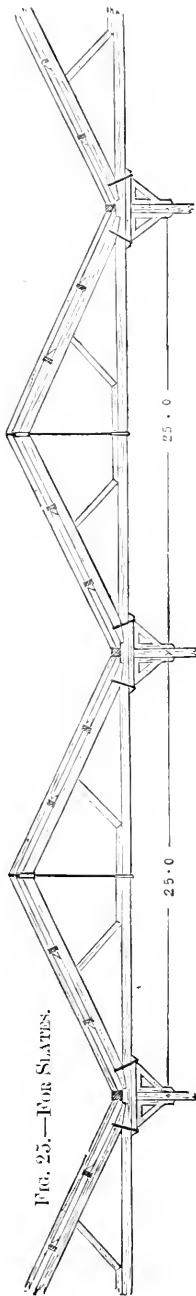

FIG. 25.—FOR SLATES.

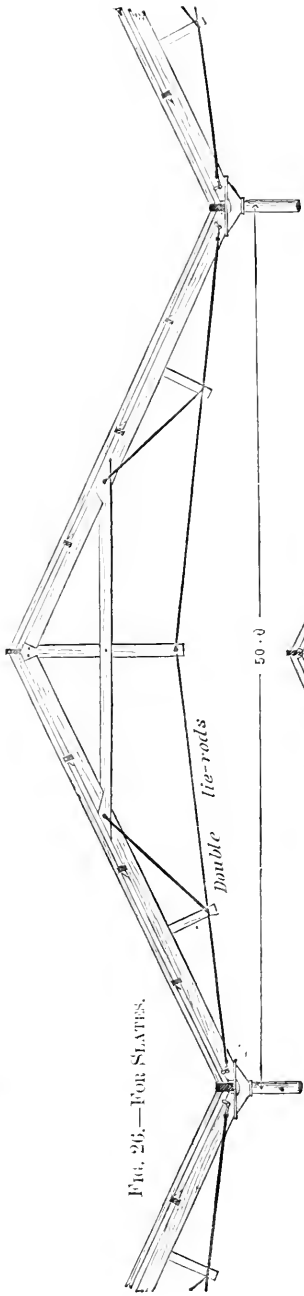

FIG. 26.—FOR SLATES.

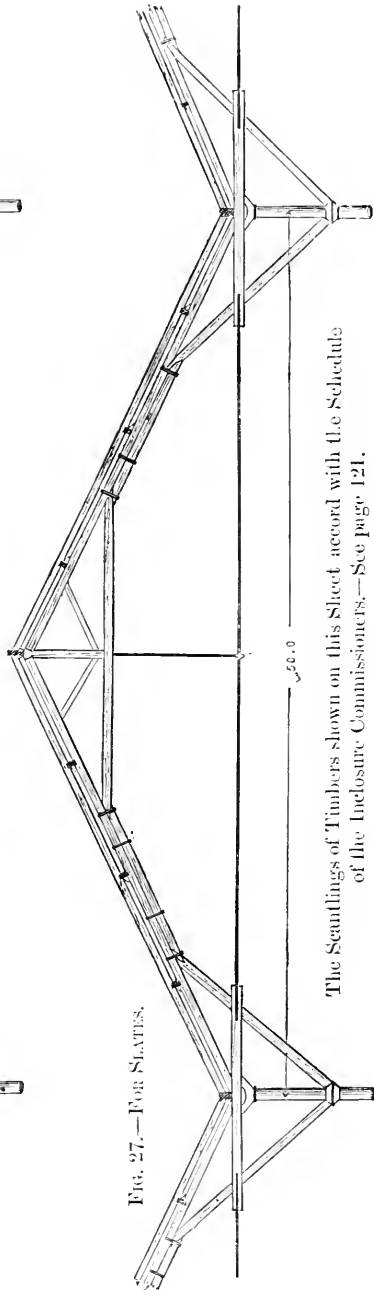

FIG. 27.—FOR SLATES.

The Scaulings of Timbers shown on this Sheet accord with the Schedule of the Inclosure Commissioners.—See page 121.

## IRON ROOFS.



FOR SLATES ON BOARDS.

FIG. 28.

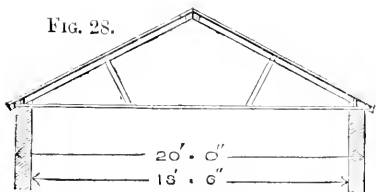

FIG. 31.

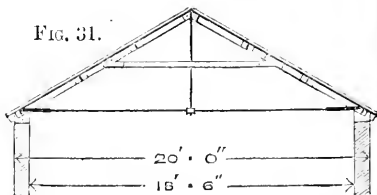

FIG. 29.

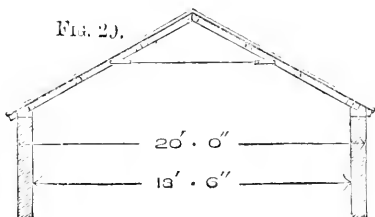

FIG. 32.

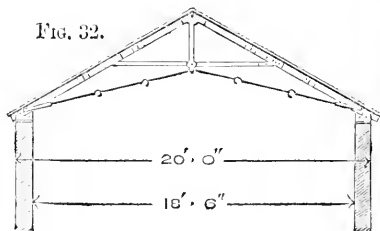

FIG. 30.

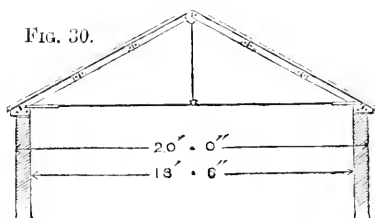

FIG. 33.

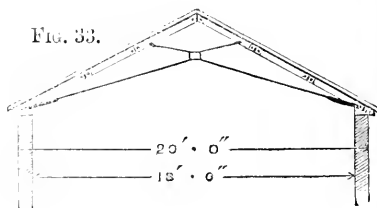

FIG. 34.

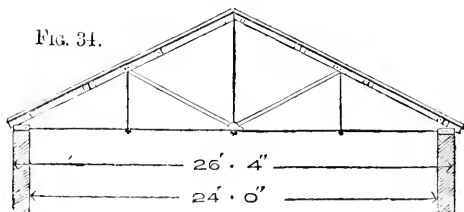
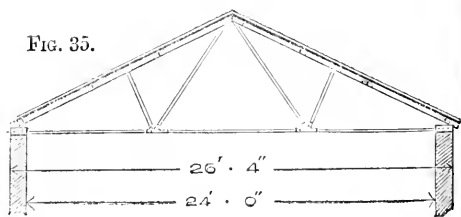

FIG. 35.



## IRON ROOFS.



FIG. 36.

FOR SLATES ON BOARDS.

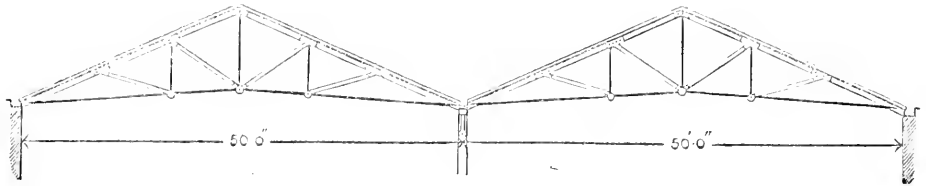

FIG. 37.

FOR SLATES ON BOARDS.

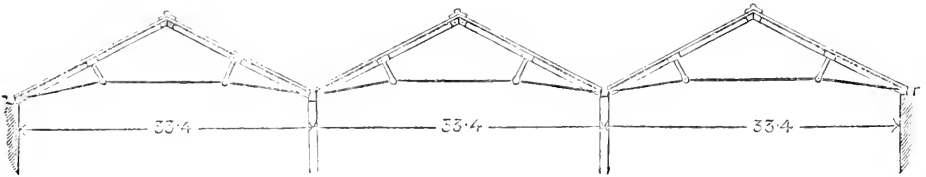
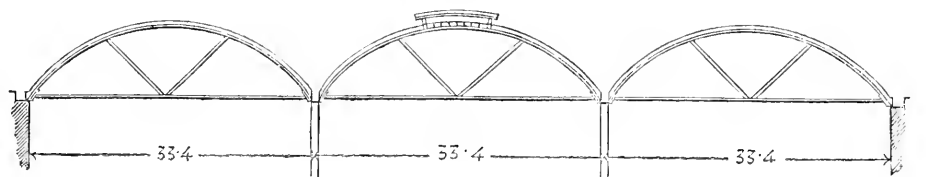

FIG. 38.

CORRUGATED IRON.



XI.—*On the Comparative Cheapness and Advantages of Iron and Wood in the Construction of Roofs for Farm-Buildings.* By PHILIP D. TUCKETT, Land Agent and Surveyor.

THE inquiry whether iron roofs are not as applicable to farm buildings as to railway stations, warehouses, &c., is so natural in itself, and was so often put before me by friends and clients, that I was induced, for my own satisfaction and guidance, to go into a series of detailed calculations as to cost, scantlings, &c., the results of which are given below. I approached the subject with no prepossessions on either side, and a perfectly unbiassed judgment, or, if anything, with some natural feeling of sympathy for the newer and less bulky material.

Iron may be applied—

1. As a roof-covering in place of slate, tiles or other material.
2. In the framing or main construction of a roof instead of timber, and irrespective of the material of the roof-covering.

1. As a roof-covering, plain or corrugated iron can be constructed at a very moderate cost, but the objections to its use are numerous.

Galvanised sheet-iron, of which these roofs are generally formed, should theoretically be free from rust, but the coating of zinc which the iron receives in this process is scarcely ever so pure and uniform as to secure this result, and unless pretty frequently painted or otherwise coated (an inconvenient and expensive liability) the iron is very liable to rust through in a few years, producing leaks, which involve constant trouble and cost in repairing. Its expansion and contraction under alterations of temperature is another objection, especially in the case of plane iron, rendering it liable to “buckle up” if not very carefully laid, and also tending to the bulging out of the side walls or other supports on which it is placed; the difficulty of inserting skylights, when the roof is curved, is a smaller inconvenience. But perhaps the two chief objections to the use of iron for farm-buildings are: First. That, being a good conductor of heat, it exposes the live stock to needless extremes of heat and cold; and Secondly, That, treat it how you will, it seems difficult to avoid positive ugliness, and this is hardly excusable in farm-buildings, however plain, especially if they are connected with a country house.

For these reasons iron must clearly wholly be condemned as a roof-covering for agricultural buildings.

That a roof either of corrugated or plain sheet-iron can be put up at a moderate price will be seen by reference to the specimen roofs, Nos. 3, 4, 5, 6 and 7, described below; but Nos. 1 and 2



are also given, not as thoroughly good roofs, but to show that, if reduced cost be the object, a light roof calculated to last for a number of years, and free from many of the objections to iron as a heat conductor, &c., can be easily put up at a still smaller cost.

II. The employment of iron instead of timber in the framing or main construction of a building is advantageous, when a building exceeding 30 or 35 feet in width has to be roofed without internal supports. In the buildings of an ordinary homestead there is none that admits of such a span; and in the case of covered yards (the benefits of which are likely to be more and more appreciated) although a single roof might be resorted to, yet advantage may always be taken of a line of fencing for a set of story-posts or columns without interfering with the yards, and a series of open gables of moderate dimensions, with ornamental barge-boards, may be made to present a more pleasing elevation than a higher roof in one span, whilst its cost will always be less whether of iron or timber. Good and efficient roofs of moderate span, such as suit a farm, may be easily framed either in timber or iron. On the score of appearance there will be little to choose between them; from the outside the roof-timbers are entirely invisible, even in the case of an open gable being concealed by a barge-board, and as to the look of the outside, tastes may well differ.

Some proprietors may be influenced by the consideration that timber can be found upon the estate, but I attach no weight to this, because I am fully satisfied that roofs should always be framed from foreign fir, that of English growth being reserved for weather-boards, fencing, and other purposes, where its warping will not involve serious damage to the main structure of the building; I have known numerous instances in which a new roof has been required after only a few years, in consequence of the injudicious saving of the few pence per foot, which represent the difference in price between English and foreign timber.

Whether a roof be framed of sound foreign fir, or of rolled and wrought iron, it should, if properly treated, be nearly equally durable; on the one hand the iron will require occasional painting to prevent rust (of which 40 tons are said to have been scraped off the Britannia Bridge); on the other, if the roof-covering is neglected, and the rain allowed to run down the timbers, the wood will perhaps first suffer; but except through negligence, either may be considered as practically permanent.

Unless every part of a building is of fire-proof construction, there is no special advantage in a roof framed of iron. For a fire can hardly originate in the roof-timbers, whilst when a fire has

attained a sufficient height to burn the roof, the heated iron will bend and twist in a way that will destroy the building quite as quickly as in the other case. It is said that the London Fire Brigade have a great aversion to iron construction, and feel much less safe in such buildings when on fire.

The expansion and contraction of iron principals in ordinary changes of temperature, is sometimes regarded as an objection, as tending to weaken the walls; but, if sufficient play is allowed for this in the construction, I do not think any inconvenient results are to be apprehended. The question, then, whether iron or wood should be used in the frame of a roof resolves itself into one of cost.

With a view of arriving at a reliable conclusion on this point, I have supposed a building 50 feet long by 20 feet broad, which may be taken to represent an average farm-building, to be covered with a span roof, and I append descriptions of eleven different roofs of this size, with estimates of their cost. The first seven refer to the first part of the subject, the *coverings* of roofs; the last four to their frame, be it iron or wood. Nos. 10 and 11 are thoroughly *well*-constructed roofs, covered with countess slating laid on close boarding, without doubt the best roofing for farm-buildings.

It will be seen that the areas of the several roofs vary, according to the slope, from  $12\frac{1}{2}$  to 14 squares, and that the substitution of iron for timber principals entails an additional cost of about 1*l.* per square in each case; and this is a very moderate estimate of the difference. For the prices given below, varying from 2*l.* to 5*l.* per square, are calculated upon the full London rates of wages and full prices for timber, whilst the ironwork is priced at the lowest estimate I have been able to obtain. Now, all the carpenter's work will be subject to considerable reduction in most country situations, where any ordinary village tradesman can frame a wooden roof. Not so the ironwork. The ordinary village smith is not equal to framing an iron roof, and as it would generally be needful to bring experienced smiths from some large town, it will be found that the more remote and thoroughly rural the district, the greater will be the cost of such work; and in such situations a difference of even 2*l.* per square is not improbable. It is this last circumstance that occasions so marked a contrast between farm-homesteads and other buildings, with reference to iron construction.

That the price of timber may eventually materially increase, that rolled iron may hereafter be produced at a cheaper rate than at present, and that ordinary country tradesmen may gradually become more accustomed to iron work, are by no means improbable speculations; but I am unable to resist the conclusion,

that the period has not yet arrived when iron can economically be substituted for timber in the construction of the roofs of farm-buildings.

The employment of cast iron in roofing has not been mentioned, as its weight and expense must ever preclude its use in ordinary buildings, although the roofs of the Houses of Parliament are constructed of wrought-iron principals, covered with sheets of cast iron three-eighths or half-an-inch thick.

Some other forms of roof-covering have also been omitted in the following descriptions, but enough have probably been selected for the present purposes of comparison:—

*Descriptions and Estimates of the Cost of Eleven Span-Roofs, constructed of various materials, but each covering a Building 50 feet long by 20 feet wide.*

No. 1.—The cheapest roof that can be constructed is formed with six pair of principals of the following scantling:—Tie-beams, 8 × 3 in. Principals, 4 × 3 in. King-post, 4 × 3 in. Strutts, 3½ × 2 in. Iron straps and wedges. Wall-plates, 4½ × 3. Ridge, 7 × 1½ in. Covered with Croggon's patent asphaltic felt,\* tarred and sanded, on purlins about 1 ft. 9 in. apart, 4½ × 2½ in.†

The cost of which, as per detail, is .. .. . 26*l.* 10*s.* 11*d.*

Or about 2*l.* per square.‡

A roof of this kind would, of course, be only desirable in outbuildings, where no flues are used. It forms a warm covering, and if properly attended to, and coated from time to time with tar and sand, may last a good while, whilst it admits of easy repair; but unless it receives more than ordinary care, it soon shows cracks and openings, through which the rain finds its way, and speedily decays the timbers. This kind of roofing is extensively used on railways. The chief objection is, that the felt lies hollow. This is obviated in

No. 2.—A stronger roof than the foregoing, formed of principals of the same scantling, but with fir rafters, 3 × 1½ in., 1 ft. 6 in. apart, on two purlins, 4½ × 2½ in., and covered with 1-in. rough battens about 6 in. apart, and Croggon's felt tarred and sanded, as before described.

The cost of this is .. .. . 31*l.* 17*s.* 4*d.*†

Or about 2*l.* 7*s.* per square.‡

This makes a much stronger and more sightly roof.

No. 3.—A roof formed of wood principals of the same scantling as before, covered with Morewood's patent continuous iron roofing, nailed on wood purlins, 4½ × 2½ in., 1 ft. 9 in. apart, with wall-plates, 4½ × 3 in., and ridge, 7 × 1½ in.

The cost of which is .. .. . 45*l.* 9*s.* 8*d.*†

Or about 3*l.* 7*s.* 6*d.* per square.‡

\* Croggon's asphaltic felt costs 14*s.* per square.

† See for details of cost, pp. 145, 146.

‡ The details show 13 square in the 3 first roofs.

This makes a good incombustible roof, and with occasional painting, or some preservative process, will last for a considerable time. The disadvantages are, that lying hollow it soon buckles; and in case of repair, it is difficult to make a sound job without disturbing a great deal of the roofing.

No. 4.—This roof is formed in a similar manner to the foregoing, but laid on rafters,  $3\frac{1}{2} \times 2$  in. (instead of purlins), 1 ft. 9 in. apart, rounded on the edge. 2 purlins,  $4\frac{1}{2} \times 3\frac{1}{2}$  in. Ridge,  $7 \times 1\frac{1}{2}$  in.

The cost of which is .. .. . 51*l.* 8*s.* 4*d.*\*

By the means of the rafters, the iron is dressed round them, and gives the appearance of an Italian roof. This gives a stronger roof than the other; the sheets of iron being in less lengths are not so liable to buckle, and are easily removed.

No. 5.—A roof similar to No. 3, but formed of eight wrought-iron principals, of the following scantlings:— $\frac{3}{4}$  in. diameter round iron tie and king rods.  $\frac{1}{4}$  in. T-struts, 4 in. area.  $\frac{3}{8}$  in. T-principals, 5 in. area. Purlins,  $4\frac{1}{2} \times 2$  in. Wall-plates, ridge and iron covering as before.

The cost of which is .. .. . 59*l.* 15*s.* 3*d.*\*

No. 6.—Wrought iron principals as last, and covered as described in No. 4, but with purlins,  $4 \times 3$  in.

The cost of which is .. .. . 63*l.* 5*s.* 1*d.*

It will be thus clearly seen that the cost is increased from 12*l.* to 15*l.* by the use of iron instead of wood principals.

No. 7.—A segmental roof formed of corrugated iron, No. 24 guage, with eight  $\frac{3}{4}$  in. diameter tie and king rods.

The cost of which is .. .. . 47*l.* 18*s.* 7*d.*\*

The detail shows 14 squares in this instance, a segmental roof having more surface.

The disadvantages of corrugated roofs are their liability to decay, their extreme ugliness, and the difficulty in forming skylights, if so desired.

No. 8, for Pantiling.—A roof constructed of six wood principals of the following scantlings:—Tie-beam,  $10 \times 4$  in. Principals,  $6 \times 4$  in. Braces,  $4 \times 2\frac{1}{2}$  in.  $2 \times \frac{1}{2}$  in. straps and  $\frac{3}{4}$  in. bolts at feet of principals. Wrought iron king-rod, 1 in. in diameter, and cast-iron head. Wall-plates,  $4\frac{1}{2} \times 3$  in. Ridge,  $7 \times 1\frac{1}{2}$  in. Rafters, 1 ft. apart,  $4 \times 2\frac{1}{2}$  in., on purlins,  $8 \times 4$  in., and covered with pantiling, laid dry on stout laths.

The cost of which is .. .. . 44*l.* 12*s.* 10*d.*\*

Detail shows 12 $\frac{1}{2}$  squares; pantiling having no waste, not requiring very much eaves or a very high slope.

This I consider a cheap roof; very substantial and capable of easy repair; forming a warm covering to cattle-sheds, and one which may be recommended wherever the appearance of pantiles is not objected to.

No. 9, the same with iron introduced.—A roof formed of eight wrought-iron principals of the following scantling:—1 in. diameter tie and king

\* See for details of cost, pp. 146, 147.

rods,  $\frac{1}{4}$  in. T-strutts, 5 in. area.  $\frac{3}{8}$  in. T-principals,  $6\frac{1}{2}$  in. area.  
 Purlins,  $8 \times 3$  in. Rafters, wall-plates, tiling and lathing, as No. 8.  
 The cost of which is .. .. . 56*l.* 5*s.* 11*d.*\*

Showing an addition of nearly 1*l.* per square in cost of iron over wood in framing roof.

No. 10, for Slating.—A roof formed of six wood principals of the following scantling:—Tie-beams,  $8 \times 4$  in. Principals,  $4 \times 4$  in. Braces,  $3\frac{1}{2} \times 2$  in.  $2 \times \frac{1}{2}$  in. wrought-iron straps and bolts at feet of principals. Wrought-iron king-rod, 1 in. diameter, and cast-iron king-head. Four purlins and ridge,  $7 \times 2\frac{1}{2}$  in. Wall-plates,  $4\frac{1}{2} \times 3$  in. 1 in. rough close boarding, and best countess slating,  $2\frac{1}{2}$  in. lap, each slate fixed with two zinc nails. Slate ridges.

The cost of which is .. .. . 56*l.* 11*s.* 6*d.*\*

This shows about 13 $\frac{1}{2}$  squares of slating, because there is an allowance for cut slates and wide eaves.

This is without doubt the best roof in every respect. It is easy of construction, very durable, easily repaired, presents the best appearance externally and internally, and, being boarded under the slating, effectually protects the interior from extreme alterations of temperature.

No. 11, the same with iron introduced.—The roof formed of eight iron principals of the following scantlings:—Tie and king rods, 1 in. in diameter.  $\frac{1}{4}$  T-strutts, 4 in. area.  $\frac{3}{8}$  T-principals,  $5\frac{1}{2}$  in. area, with purlins,  $6 \times 2\frac{1}{2}$  in., wall-plates and ridges, boarding, slating and ridge, as described in No. 10.

The cost of which is .. .. . 68*l.* 9*s.* 0*d.*\*

This, again, shows an increase of nearly 1*l.* per square, merely from the substitution of iron for wooden principals.

*Detailed Calculations of the foregoing Estimates.*

No. 1.

*Wood Principals covered with Croggon's Felt on Purlins.*

ft.	in.					£.	s.	d.	
38	8	cube.	Fir in tie-beams, principals, king-posts	}	3 <i>s.</i>		5	16	0
			and braces .. .. .						
			No. 6 iron straps and wedges to king-	}	at 2 <i>s.</i>		0	12	0
			post .. .. .						
cwt.	qr.	lb.							
1	1	17	Wrought iron in straps, principals and	}	4 <i>d.</i> lb.		2	19	0
			screw-bolts .. .. .						
			Fixing iron-work .. .. .				0	10	0
							9	17	0
43	0	cube.	Fir framed in purlins and ridge .. ..	2 <i>s.</i> 10 <i>d.</i>		6	1	10	
9	5	„	Fir framed in wall-plate .. ..	2 <i>s.</i> 9 <i>d.</i>		1	5	11	
50	0	run.	Labour to rounded edge of ridge .. ..	1 <i>d.</i>		0	4	2	
1300	0	sup.	Croggon's felt, nailed, tarred and sanded	14 <i>s.</i> sq.		9	2	0	
							£26	10	11

\* See for details of cost, pp. 147, 148.

## No. 2.

*Similar Principals to No. 1, but with Rafters covered with Battens and Croydon's Felt, as before.*

ft.	in.		£.	s.	d.
		Principals as No. 1 .. .. .	9	17	0
35	0 cube.	Fir framed in rafters, purlins and ridge	2s.	9d.	4 16 3
600	0 sup.	1 in. rough battens and fixing .. ..	22s.	sq.	6 12 0
		Wall-plates, rounded edge, and felt as } No. 1 .. .. .	10	12	1
					<hr/>
					£31 17 4

## No. 3.

*A Roof formed of Wood Principals as No. 1, and covered with Morewood's Patent Continuous Iron Roofing on Purlins.*

			£.	s.	d.
		Principals as before .. .. .	9	17	0
9	5 cube.	Fir in wall-plate .. .. .	2s.	9d.	1 5 11
43	0 ,,	Fir framed in ridge and purlins .. ..	2s.	10d.	6 1 10
150	0 run.	Labour to splayed edge of ridge and } plates .. .. .	1d.	0	12 6
1300	0 sup.	Morewood's patent No. 28 galvanized iron } continuous roofing .. .. .	34s.	sq.	22 2 0
1200	0 run.	Punching holes in ditto .. .. .	$\frac{1}{4}$ d.	1	5 0
700	0 ,,	Zinc nailing .. .. .	$\frac{3}{4}$ d.	2	3 9
50	0 ,,	Iron ridge-cap and fixing .. .. .	10d.	2	1 8
					<hr/>
					£45 9 8

## No. 4.

*A Roof formed with Wood Principals as before, but with rounded Rafters, covered with Morewood's Iron Roofing, as before.*

			£.	s.	d.
		Principals as before .. .. .	9	17	0
9	5 cube.	Fir in wall-plates .. .. .	2s.	9d.	1 5 11
57	6 ,,	Fir in purlins, ridge and rafters .. ..	2s.	10d.	8 3 0
667	0 run.	Labour to rounded edge of rafters .. ..	1d.	2	15 7
1392	0 sup.	Morewood's continuous roofing .. ..	35s.	24	7 2
696	0 run.	Punching and zinc nailing .. .. .	1d.	2	18 0
50	0 ,,	Iron ridge-cap and fixing .. .. .	10d.	2	1 8
					<hr/>
					£51 8 4

## No. 5.

*A similar Roof to No. 3, but with Iron Principals.*

			£.	s.	d.
15 $\frac{1}{2}$	cwt.	Wrought iron in framed principals ..	27s.	21	5 3
		No. 80 iron angle brackets for fixing } purlins to iron principals .. ..	1s.	4	0 0
		Purlins, 4 $\frac{1}{2}$ x 2 in., and wall-plates. } Ridge, iron roofing and ridge-cap as } No. 3 .. .. .	..	34	10 0
					<hr/>
					£59 15 3

No. 6.

*A similar Roof to No. 4, but with Iron Principals.*

		£.	s.	d.
15 $\frac{3}{4}$ cwt.	Wrought iron in principals, as described } for No. 5 .. .. . }	..	21	5 3
	No. 16 iron angle brackets for purlins ..		0	16 0
	Wall-plates, rafters, rounding, iron roof- ing and ridge as No. 4, but with purlins 4 x 3 in. .. .. . }	..	41	3 10
				<hr/>
				£63 5 1

No. 7.

*A Segmental Roof of Corrugated Iron, No. 24 gauge and Principals.*

ft.	in.			£.	s.	d.
9	5 cube.	Fir in wall-plates .. .. .	2s. 9d.	1	5	11
100	0 run.	Labour to splayed edge .. .. .	1d.	0	8	4
		No. 8 $\frac{3}{4}$ iron bolts to secure wall-plate to wall .. .. . }	2s.	0	16	0
1400	0 sup.	No. 24 corrugated iron curved sheets and fixing .. .. . }	3l. sq.	42	0	0
cwt.	qrs.	lbs.				
2	2	3	Wrought iron in tie and suspension rods	27s.	3	8 4
					<hr/>	
					£47	18 7

No. 8.

*A Roof formed of Wood Principals, covered with Pantiles on Laths.*

ft.	in.			£.	s.	d.
64	9 cube.	Fir framed in principals .. .. .	3s.	9	14	3
cwt.	qrs.	lbs.				
2	2	4	Wrought iron in straps and bolts .. .. .	4d. lb.	4	14 8
			No. 6 cast-iron heads to king-bolts ..	7s.	2	2 0
			Fixing bolts, straps, &c. .. .. .	20s.	1	0 0
ft.	in.					
9	5 cube.	Fir in wall-plate .. .. .	2s. 9d.	1	5	11
97	3 „	Fir framed in rafters and purlins .. ..	2s. 10d.	12	15	7
1250	0 sup.	Lathing and pantiling, laid dry .. ..	20s.	12	10	0
50	0 run.	Tile-heading as ridge .. .. .	2 $\frac{1}{2}$ d.	0	10	5
					<hr/>	
					£44	12 10

No. 9.

*A Roof similar to No. 8, but with Wrought-iron Principals.*

cwt.	qrs.	lbs.			£.	s.	d.
21	2	23	Wrought iron in framed principals ..	27s.	29	5	9
			No. 16 iron brackets to fix purlins ..	1s.	0	16	0
			Wall-plates, rafters, purlins, lathing and pantiling, as No. 8, except reduction of 1 in. in width of purlins .. .. . }	..	26	4	2
					<hr/>		
					£56	5	11

## No. 10.

*A Roof formed of Wood Principals, covered with 1 inch rough Boarding, on Purlins and Slated.*

ft. in.			£.	s.	d.
9	5	cube. Fir in wall-plates .. .. .	2s. 9d.	1	5 11
48	0	„ Fir framed in principals .. .. .	3s.	7	4 0
cwt. qrs. lbs.					
2	2	4 Wrought iron in king-rods and straps ..	4d. lb.	4	14 8
		No. 6 cast-iron heads and fixing .. ..	7s.	2	2 0
		Fixing ironwork .. .. .	..	1	0 0
30	5	cube. Fir framed in purlins and ridge ..	2s. 10d.	4	6 3
1250	0	sup. 1 in. rough boarding .. .. .	21s. sq.	13	2 6
200	0	run. Labour to splayed edge of wall-plate and	} 1d.	0	16 8
		ridge .. .. .			
1340	0	sup. Best countess slating, 2½ in. lap, each	} 30s.	20	2 0
		slate fixed with two zinc nails ..			
50	0	run Sawn-slate ridge and fixing .. .. .	9d.	1	17 6
				<hr/>	<hr/>
				£56	11 6

## No. 11.

*A Roof similar to No. 10, but with Wrought-iron Principals.*

cwt. qr.			£.	s.	d.
19	1	Wrought iron in tie-rod, king-rod, prin-	} 27s.	25	19 9
		cipals and struts .. .. .			
		No. 32 iron angle-brackets for fixing	} 1s.	1	12 0
		purlins .. .. .			
		Purlins, plates, boarding, slating, ridge	} ..	40	17 3
		&c., as No. 9, except reduction of 1 in.			
		depth of purlins .. .. .			
				<hr/>	<hr/>
				£68	9 0

76, Old Broad Street, London, E.C.

XII.—*Rural Economy of the Netherlands; being a Report read by M. de Lavergne to the Academy of Moral and Political Science.* Translated from the ‘Journal d’Agriculture Pratique,’ by H. EVERSHERD.

I HAVE already called the attention of the Academy to a work on the ‘Rural Economy of Belgium,’ by M. Emile de Laveleye, the professor of Political Economy at the University of Liège. The same author has now given us, in a second publication, an equally interesting picture of the kingdom of the Netherlands, and I shall now attempt to follow him in his more recent travels.

The Netherlands, exclusive of the Grand Duchy of Luxemburg, contains 8,190,000 acres, and is nearly as large as Belgium.



The population is 3,500,000, or a little more than 100 to 250 acres, while in Belgium it is 160, and in France only 68. The produce of the land suffices for its inhabitants, and even shows a small surplus, for although food to the value of 2,400,000*l.* is imported every year, the value of the exports is 4,000,000*l.* Such agricultural prosperity is the more remarkable because it is of recent date. Holland formerly, like Venice, of all the states of Europe owed the greatest portion of its wealth to commerce, and the least to agriculture. The country was supported, not by the plough tilling the bosom of the earth, but by her navy furrowing the waves of every sea. Since the decline of her commercial greatness (that is for more than a century) her attention has been turned to agriculture, and little by little, unnoticed abroad, and almost unobserved by the country itself, without noise, without fuss, Holland, which once existed by trade only, has become famous for agriculture.

The territory is divided into two portions, equal in extent, but differing much in fertility; the low, clayey districts of the sea-coast, and the higher sandy district of the interior.

The clay district, which is by far the most fertile, comprises 3,750,000 acres, after deduction has been made for land taken up by roads, lakes, canals, towns, &c. It includes the provinces of Zealand and North and South Holland, and extends over a great portion of Friesland, Groningen, and Over-Yssel. The perfectly level plain of the country proves that it was formed in the depths of still water. In short, it owed its origin to three rivers which had their mouths here, viz., the Scheldt, the Meuse, and the Rhine. On entering the Low Countries the rivers have hardly any fall, and when the fresh water meets the salt, the current is entirely arrested, and the ooze settles in banks. These low lands are protected by embankments and dykes, which were begun in the earliest historical times. From the sixteenth century a record has been kept of the works of this kind that have been successively executed, and it appears that in 350 years, 875,000 acres of the richest land have been won from the waters.

This region is on the whole one of the richest in Europe. M. de Laveye estimates the average value of the land at 48*l.* per acre. The country, of which about two-thirds are in grass, has the appearance of an immense pasture. This is the home of those famous cows which yield 900 to 1100 quarts of milk a year. Nowhere is farming more simple in its details, and at the same time more profitable. The province most famous for its grass-land is North Holland, a low projecting peninsula, which stretches northwards from Amsterdam, with the ocean on the west, and the Zuyder Zee on the east. It would long ago

have been divided into many islets if it had not been artificially protected from the waves. Holland signifies in the native language, *hollow land*, and hollow it is in fact, for when you look over the country you see in all directions canals above the level of the fields, and boats sailing above the heads of the cows. Under such circumstances natural drainage is impossible; to get rid of the surface-water recourse is had to windmills, by means of which it is pumped into the canals. Meadows occupy seven-eighths of the land, and during the summer the cows remain day and night in the pastures. Cheese is largely made, and is called by the name of the little town of Edam, where a large cheese-market is held. Hard, dry, and round, they will keep for a year and more in the hottest climates, which makes them particularly useful for the navy. England is a large consumer. Bullocks are also fattened for the Amsterdam market, and a good many milking cows are sold to Belgium and France. The whole of the farmer's profit comes from cattle.

M. de Laveleye gives details respecting the wealth of the Dutch farmers, which would seem incredible if they were not established by all kinds of evidence. The unit by which a fortune is reckoned in the Low Countries is a "tonne" of gold, that is about 8540*l.* A farm-landowner who is worth one "tonne" is not esteemed rich, it is common to meet with men who are worth two or three.

M. de Laveleye gives the following account of a country wedding which passed him in the street:—"Forty carriages, filled with the guests, went along at a smart pace. These vehicles are of an antique and very pretty form; they call them "chaises," they are, in fact, the gigs of the eighteenth century, with the bodies in the form of a shell, hung high, and covered with gilding and ornament (*en chicorée*). They are so narrow that there is hardly room for two to sit. So the young girls with fluttering lace and ribbons, and golden frontlets glittering in the sun, were squeezed close by the side of their jovial companions, who, with arms stretched out, drove their strong, black, nags at a great rate. In the evening the guests came to the hotel where I was, to take refreshments, I asked one of these yeomen if the bride was rich, 'Oh! yes,' was the answer, 'not badly off, a tonne and a half I dare say, but,' presenting a smart lass with black eyes, 'this is my intended, who is much more comfortably provided for, she will have two.'"

These country folk are nearly all owners of the land they hold, which is of such great value that seventy-five acres, well stocked, represents a tonne. Most of them make investments in the public funds. All have their houses furnished in luxurious style, and make a great display of handsome silver plate; since

the opening of the English market raised the value of their products, they are not content with having silver tea-services, but the goblets and large dishes of all sorts must be of the same metal, and some people finding even silver too common, have come out with gold plate.

In South Holland the grass-lands are about equal in extent, but not quite so good in quality. This province is the heart of the Low Countries, and with reason gave its name to the whole kingdom. Here are to be found, not far distant from each other, the cities of Amsterdam, Rotterdam, the Hague, and Leyden, which are the pride of these regions. The two divisions of Holland are together nearly as large as a French department, and can boast of a population of 1,200,000 souls, or more than 200 to 250 acres, the same rate as in our Department du Nord, and as in the most thickly populated parts of Belgium and England. Such is the reward of indefatigable industry, and of indomitable attachment to liberty.

Among the most recent agricultural achievements is the drainage of the lake of Haarlem. This magnificent enterprise was commenced in 1839. The cost reached 760,000*l.*, or nearly 17*l.* per acre; for the lake of Haarlem covered 45,000 acres. Making deduction for the land occupied by dykes and canals, 42,500 acres have been sold by auction at an average price of 16*l.*, which almost covered the outlay. The land now sells readily for 32*l.* to 40*l.* an acre. This ancient lake, which once produced nothing, now yields a gross agricultural return of 160,000*l.*

The gardens of Holland have long been celebrated. Their head-quarters are in a belt of country stretching along the sea-coast, and called Westland. Although situated in the midst of the clay district, this spot is sandy; it was formerly covered with embankments, but for more than four centuries the work of reducing them and removing the sand elsewhere has been carried on at a cost so enormous that the value of the land seems hardly to repay it. The proximity of populous cities, affording a ready market, has enabled Westland to acquire its extraordinary fertility. It is a perfect garden, where cultivation has almost worked miracles; for, with a soil naturally poor, and with a rigorous climate, it produces exotics which do not always thrive even under the gentle skies of Nice. Near Haarlem are to be seen large broadths of tulips, hyacinths, and jonquils, whose bulbs are exported to all parts of the world. The charming village of Bloemendal, "the valley of flowers," sent forth bulbs to the value of nearly 200,000*l.* in 1862. Roses are here grown on a large scale for their blossoms, which are used for perfumery, besides plants used in medicine, asparagus, figs, early beans,

immense nurseries of fruit-trees, and of trees for ornamental planting; and lastly, magnificent grapes fit for a royal table. The gardeners of Belgium and Paris, now so skilful, were the pupils of the gardeners of Westland.

It is very clear how this remarkable culture originated. The merchants of Holland drew their wealth from traffic; all their energy was directed to navigation; they possessed little land, and preferred to invest their spare capital in the public funds, national or foreign. This explains how it was that landed property fell almost entirely into the hands of the country people. Moreover, the grass district required only a pastoral routine of the simplest kind, which did not involve the employment of much capital. The merchants then were satisfied with having a country house or a villa and garden, built on some sandy elevation above the high-level of the waters, and not far from the city; and there the men of business came for retirement. The rich capitalists spared no expense in adorning their retreat; they prided themselves in collecting the rarest flowers and the most exquisite fruits. This taste in time became general; and the number of small country houses, kept up with the greatest care, has become immense. The Dutch literature is rich in poetry, written in celebration of the pleasures of a country life: these bucolics are called the *Arcadias*; and although the greater portion of them may be rather antiquated in style, some among the number are really natural and genuine in expression.

On the other side of the *Zuyder Zee*, that great gulf hollowed out by the tempests of the twelfth century, extends the "green region" of Friesland. In Holland, cheese is the staple production; in Friesland, butter: the cheese, made from the churned milk, is considered only an accessory; it is in butter-making that the Friesland farmer displays that perfect cleanliness which characterises him. The Friesland butter is so fine in quality that in the London market, to which it is largely exported, it sells at an exceptional price. The quantity of butter taken to the various provincial markets reached, in 1860, 140,000 cwts., which, at the average price of 5*l.*, would realise 700,000*l.* The domestic animals of Friesland are celebrated. The cows are as good as those of Holland; and the introduction of Durham bulls will produce a cross breed which is expected to yield more cream from a smaller quantity of milk, and to fatten more readily. The black Friesland horses, with small lively heads and swan-like necks, are capital trotters. In fact, the agricultural productions of Friesland are little inferior to those of Holland, but the farmers are generally less wealthy. There are not so many proprietors among them; and the length of lease being only seven years on an average, the rise of rents is continual.

For many years the fertility of these countries has been increased by means of a process peculiar to the locality. On the sea-side little hillocks, 13 feet to 19½ feet high, may be observed at short distances; they are called *Terpens*. These hillocks were formed by the hand of man; and when opened, their contents prove that they belong to an ante-historical epoch. They were without doubt places of refuge, where the ancient inhabitants took shelter with their herds during the high tides. Formed of clay and manure, they contain much fertilizing matter. The practice is to spread them on the meadows, and thereby not only is the quantity of herbage increased, but the quality is improved.

To the north of Friesland is the province of Over-Yssel, less fertile and less prosperous. It begins with a wide region of peat intersected in all directions by large lakes and numerous ponds and ditches. The earth, drowned in water all round, looks like a sea of mud. Towards autumn numberless herds enliven these green solitudes; but up to the middle of July the only living things that are to be seen are the various water-fowl and sea-gulls. These amphibious tracts exhibit many ingenious methods of cultivation. All sorts of marsh-plants grow here with great luxuriance, and they are collected to make manure. The reeds furnish cheap and excellent covering for roofs; rushes are used to make mats, which serve as carpets for the humble dwellings, and are also exported to England. By such means a tolerable revenue is obtained from the swamps.

This is also the land of floating islands, which originate in the accumulation of vegetable *débris* on the surface of the lakes, and in time become firm enough to carry cows. There are certain spots of drier and firmer land; and the delta formed at the mouths of the Yssel rivals in richness the best portions of Holland and Friesland.

The province of Zealand is situated at the point where Belgium ends: formed by the mouths of the Scheldt, it is made up of many islands separated by the arms of that river. There is much less grass-land than in Holland, one-half of the province being arable. The principal crops are madder, flax, rape-seed, wheat, and beans. In this damp climate, and under exposure to the ocean blast, it is singular to meet with a plant so delicate as madder, which delights in the warm fields of Avignon. But it succeeds here very well, and appears to have been introduced in the fifth century. Official statements estimate the produce of 2½ acres planted with madder at 30 cwts., worth 60*l.* at the ordinary price (24*l.* an acre). But M. de Laveleye states that the real return is generally superior to that. The best farmed portion of the province is the island of Walcheren. The farms there

are small (50 to 60 acres), and admirably kept. The land is never allowed to rest. The picturesque costume of the peasants, so often a subject for the artist, gives completeness to the unique character of the country.

In the Zealand coat-of-arms a lion is represented lifting himself by a bold attempt above the waves that were ready to engulf him. The motto is *Luctor et emergo*, "I strive and I rise above water." The device is true in a double sense, both as applied to the battle which these islands may be said to wage against the ocean, and to the heroic struggle by which they established their independence. Zealand cut through its dykes and gloriously let in the flood rather than submit to the yoke of Philip II.; and it had afterwards to reconstruct, with great labour, what its patriotism had destroyed in one day.

At the other extremity of the Low Countries is the province of Groningen, the most northern of all. It is a republic established and governed by a rural population, which is both wealthy and enlightened. That aristocracy, which is the pride of rural life in Britain, does not here exist. The only houses are those of the farmers, and they are all alike. The buildings are unequalled. Between the road and the dwelling-house is the garden planted with ornamental and exotic trees, with a lawn laid out in flower-beds. At the background is the kitchen-garden filled with fruit-trees and a variety of vegetables. The extent of the façade, the numerous windows, the embroidered curtains, the furniture in American oak, the piano, the capital library, all proclaim easy circumstances and the habits which result therefrom. Behind the dwelling-house is a great building, lofty and long like a church, containing stables, cattle-houses, barns, &c.; all under one roof. On entering you find barn-room sufficient to store the crops of 250 acres, a collection of the most improved tillage implements, sixty cows perhaps in one row, and twenty splendid black horses, the pride of their owner. The cultivation of arable land prevails as in Zealand, and it is as well understood as in England. On the clays, a crop of 44 to 55 bushels per acre of beans, 55 to 66 bushels of barley, and 77 to 88 bushels of oats is not uncommon. To give an idea of the number of cattle reared, we may cite the parish of Aduard, with not more than 2000 inhabitants, which exported in 1860, 389 milking cows, 420 fat oxen, 78 heifers, 86 horses, 1254 sheep, add 700 cwts. of butter, and it does as much every year.

How are we to account for these large returns, and this great agricultural wealth? M. de Laveye finds an explanation in the custom of tenancy, which obtains in the country, and which is called the *beklem-reqt*, or hereditary tenancy. It is the right of permanent occupation, on payment of a fixed annual sum,

which the landlord cannot increase. This passes to the heir both in a direct or collateral line; the tenant can devise it, sell it, lease it, or mortgage it without consent of the lessor; but whenever the lease changes hands by heritage, or sale, the proprietor claims one or two years' rent. One of the essential characteristics of this hereditary tenancy is that the holding cannot be divided, but must be held by one individual; consequently one of the heirs must take it as his portion. When a tenant fails, the *beklem-regt* does not go to the liquidation of his debts to the full amount of its value; the creditors have power to sell it, but the buyer is bound to pay any arrears due to the landlord. This kind of contract which dates from the middle ages is not without analogy in other parts of Europe. M. de Laveleye cites the life contract (*contratto di Livello*) of Lombardy; in France even we have long had something equivalent in the "tenancy subject to notice" (*domaine congéable*) in use in Brittany. One can also find remote traces of a similar custom in what is called, in some cantons of Picardy, the "ill-will" (*le mauvais gré*).

Only in Brittany the landlord has the right to give notice to quit when he pleases, paying the tenant a valuation on any buildings he has erected; whilst in Groningen this right does not exist, or exists no longer, for it seems the landowners did reserve it originally, but in the midst of the revolutions of sixteenth and seventeenth centuries it fell into disuse.

The opposite appears to have happened in Brittany, where formerly the occupiers did not admit the right of dismissal. On the one hand the interest of the farmer has prevailed, on the other the right of the landowner. It is a natural consequence of this discrepancy that in Brittany the *domaine congéable* is going out of use, whilst in Groningen according to M. de Laveleye the *beklem-regt* becomes more general. The Dutch economists, he says, have unanimously pronounced in its favour, and in a recent agricultural congress, after an exhaustive discussion, they came to the conclusion that it was desirable to adopt the custom in other provinces. These facts deserve the more attention, because they are entirely opposed to the ideas which prevail elsewhere in Europe.

With complete ownership land sells for 80*l.* an acre in Groningen. But it often happens that when the hereditary tenancy is of old date, the annual rent payable to the landowner does not exceed 3*s.* 2*d.* to 3*s.* 10*d.* an acre. In that case the farmer may be considered the real proprietor, since he pays only a trifling rent, about equal to the tax he pays to the state. These rich countrymen seldom care to become purchasers and to combine the ownership with the cultivation of the land. They

prefer to remain farmers, and in fact by so doing they can obtain a greater profit on their capital.

M. de Laveleye points out a new practice which threatens to interfere with the action of this tenure. The value of agricultural productions has been very much increased since England became a customer, and the profits of the farmers have grown so large, especially in the case of those who pay a low rent, that they have adopted the practice of sub-letting their land under the conditions of an ordinary lease. The land thus carries a double rent, and the advantages which hitherto attended the hereditary tenancy cease to exist, because the farmer is no longer the actual lessor but an under-tenant. So the *beklem-regt* seems likely to become a dead letter in consequence of the success which has attended it.\*

Nowhere, perhaps, is intelligence so generally diffused as in these countries. Most of the farmers are accustomed to engage in theological debates. Many of them belong to the *Mennonites*, who are the Quakers of Holland. "One day," says M. de Laveleye, "I remarked four fine farms one after the other. I asked the landlord of an inn at which I was stopping, to whom they belonged." "To Quakers," was his answer, "they are wealthy, each is worth not less than 26,000*l.*" (three tonnes). "I have heard the remark that there are no poor among the members of that fraternity, is that the case here?" "Yes," says mine host, "they have only a single poor person among them, and when he dies there won't be one!" Severe manners, work and mutual assistance, have banished want from these little communities, where every one is known, all are cared for, and each one helps the other.

The other half of the Low Countries, with a similar area of 9,750,000 acres, offers a striking contrast to the former. It is a belt, naturally sterile, extending on the one side to the Belgian "Campine" or plain, and on the other to the sands of Prussia, being on an average about 50 feet above the level of the sea. It

---

\* An educated Englishman can hardly fail to recognise the strong resemblance between the *Beklem-regt* and our own free or copyhold tenures, under the lord of a manor, at an earlier stage of their existence. With us the sums fixed for reserved or quit rents are so small, because they are of such ancient date, and the fine upon transfer is so considerable, whenever it is set upon the *present* annual value, that to our view the rent is quite eclipsed by the fine, and left out of account—yet it represents an old English *Beklem-regt*.

This resemblance may remind us of the days when England was distinguished from other European nations mainly by her yeomanry, but it must also teach us that no mere law of tenure can permanently resist the changes which time and circumstance promote. For ourselves, it has become a matter of congratulation that, in spite of the lawyers, we are getting rid of the trammels of copyhold tenure, now thoroughly antiquated.—P. H. F.



comprises the provinces of Drenthe, Brabant, Limbourg, and part of those of Over-Yssel and Gelderland, and of Utrecht. One-half of this vast expanse is still uncultivated. In 1860 the province of Drenthe numbered only 94,000 inhabitants on 665,000 acres, namely, 36 to 250 acres, equivalent to the population of our department at Landes, and less than that of any other province of the Low Countries. Its population has almost trebled since the end of the last century, when it was only 37,000.

Encompassed on all sides with swamps and peat-bogs, this region is like an island of sands and heaths, shut out from all communication with the rest of the country. The old constitution of the Saxon Marches exist here up to the present time. The word *March* applies, especially, to the waste lands that surround the cultivated fields of a tribe, and form an uninhabited border that serves as the frontier. In France we meet with the same word, to designate one of our ancient provinces, which was formerly almost a desert, and where there are immense breadths of uncultivated commons even at the present time. In Drenthe it has been decided by the Courts of Justice that the ancient Marches can be sold, or divided among the co-proprietors. The result of this decision is that the Marches disappear rapidly; and in proportion as individual ownership gains ground the population increases.

Even where the enclosures took place long since, some relics of the old rural commonalty have been preserved. Formerly each inhabitant had his plot for cultivation in the common fields allotted to him every year. These allotments have now become pretty nearly private property, but the ownership is far from being complete, for all the old customs of common-field cultivation continue to subsist. The cultivated land is divided into a number of small plots, on which no stock can be turned while the general crop is on the ground; so that they must be all sown with the same kind of grain, tilled, and seeded, and harvested at the same time. The three-crop rotation is followed:—first, winter rye; second, spring rye; third, fallow, now replaced by buckwheat. The collective body of farmers is called *The Boor* (in other words the *countryman*). They meet in full assembly under the venerable oak-trees, to settle the periods for cultivation, seed-time and harvest. After the gathering of the crop, the entire land is free as common pasture. Similar customs still remain in the east part of France, especially in Lorraine.

The wretched system of cropping would have impoverished the soil long ago, if they did not keep up its condition by a plan just as barbarous as the cropping—that of paring the turf and heather from off the waste lands, and laying it on as compost.

The peat-bogs that fill the hollows of this region give rise to a special kind of farm management. No man lives there, indeed he can hardly move about them without danger. The neighbouring farmers therefore lease, or as they express it, purchase the land for twelve years. In the spring they dry the surface of the bog by making drains in it, then they cut the turfs, which are left through the summer to dry. In the spring of the following year they set fire to the dried turfs, level them with a harrow, and sow buckwheat. The land so treated produces five or six crops in succession, ; after the third, the yield begins to fall off; from the fourth, spurrey, a plant not native to the peat-bogs, makes its appearance, and gradually overruns the land, so that in the sixth year spurrey and buckwheat together are cut as forage for cattle. When the land is completely exhausted it is again abandoned to the natural herbage. Twenty-five or thirty years must elapse before the bog is restored, so as to offer a seed-bed for cultivated plants. The area burnt every year is so great that the thick columns of smoke, driven by the north wind, spread over the half of Europe; a special odour, says M. de Laveleye, accompanies the appearance of this singular phenomenon, which the people call dry, or northern mists, without questioning their origin.

We have got very far away from the pastures of Holland and the gardens of Westland. These wild regions, whose aspect carries us into ancient Germany, as described by Tacitus, abound in those singular monuments which the Celtic race have everywhere left behind them. We refer to the enormous blocks of granite, placed one upon the other, like gigantic tables. They are called in the locality the beds, or tombs, of the Huns, and according to popular tradition, they were set up by the hordes of Attila; but it is quite evident that their origin is the same as that of Carnac stones in Brittany, or of Stonchenge in England.

Happily the sandy tract is not everywhere equally barren. M. de Laveleye states, that in the other provinces the best systems of cultivation have been introduced. More importance is given to green crops, rye is less frequently repeated, clover is grown, and some approach is made to the alternate system of cropping. Both the practice and the products of husbandry are then nearly the same as in Belgium. One portion of the province of Limbourg, which is naturally more productive, is exceedingly thriving. In the peaty tract of Groningen, peat-farming has given rise to real colonies, that furnish one of the brightest pages in the agricultural history of the country. The work of settlement proceeds at the present time. The city of Groningen, possessing a large extent of unreclaimed peat, has made a canal, and opened the way to new settlers. The

system of hereditary lease is applied to their clearings, and the city may well be satisfied with it, for the farmers bring to the work that energetic action to which the feeling of ownership gives rise.

At another spot has arisen the little colony of the Society of Benevolence, established about forty years ago by General Van den Bosch. Owing to the devotedness of the managers, and the generosity of the subscribers, 434 little homesteads have been built, 3500 acres of land have been brought into cultivation, and a laborious population of 3000 souls has been removed beyond the reach of poverty. It is true that the outlay has been disproportionate to the results, and this gives rise to doubts as to the future.

Planting the poor land is a work which is not open to the same uncertainty. The Netherlands are deficient in woods, having in all only 562,500 acres, almost all situated in the provinces of Gelderland and Brabant. A change is taking place in this respect, and extensive planting has been undertaken. The timber trees which succeed best are the Scotch fir and the black Austrian pine. This new source of wealth promises to be some day highly productive. M. de Laveleye remarks, with justice, that if the Low Countries during the last century had devoted to the planting of their heaths all the money they have invested in foreign loans, their returns would have been more steady, and less exposed to risk from the possible bankruptcy of involved governments.

To sum up, the 7,500,000 acres capable of cultivation in the territory of the Netherlands is disposed as follows:—

	Acres.
Natural Pasturage .. .. .	3,375,000
Arable land .. .. .	1,812,500
Wood .. .. .	562,500
Uncultivated land .. .. .	1,750,000
	7,500,000

These figures show that the Netherlands (together with Switzerland) have the largest proportion of pasturage of any country. If we add the root-crops and artificial grasses, it appears that twice as much land is appropriated to feed domestic animals as is devoted to cereals and other vegetable products that serve as food for man.

Among cereal crops rye stands first, occupying nearly 500,000 acres. Wheat is only grown in the most fertile portion, and the entire crop does not exceed 620,000 qrs., or one bushel and eleven gallons per head of the population. Bread made from wheaten flour is here an article of luxury; that in general consumption,

in town as well as in country, is made of rye-flour. The crop of rye exceeds 1,200,000 qrs., or two bushels six gallons per head. After adding to these figures 515,625 qrs. of buckwheat, it still appears that the crop of grain is insufficient to meet the consumption, notwithstanding a large growth of potatoes. Consequently the Low Countries import grain every year to the amount of three-fourths of a million to a million quarters, of which the greater part is rye. The agricultural exports consist chiefly of cheese, butter, and other animal products.

A century ago the Netherlands grew no wheat, and much less rye than it produces now, but it had nevertheless become the granary of Europe, although all the grain that flooded its ports came from abroad. The merchants of Amsterdam had found it easier and shorter to draw their supplies from the Baltic than from the soil of their own country; they sold corn to France and to England, and even carried it as far as the Mediterranean. When this commerce came to an end the cultivation of cereals was developed; it is constantly extending, and M. de Laveleye affirms that the time will come when the country will be supported by its own produce. If so, it will be one of the most striking revolutions in the rural economy of Europe.

The farming on the seaboard is already unsurpassed even by that of England, Belgium, Lombardy, or French Flanders. It is the inland belt, with its immense tracts of uncultivated land, that pulls down the average; but an impetus has been given to improvement, and it cannot fail to be sustained.

Since 1790 the population of the Low Countries has increased 50 per cent., whilst that of France has only increased 30 per cent. in the same period. The improvement has been particularly marked in the district described as "sandy." The possibility of such progress could have been little anticipated at the period when the Dutch lost the monopoly of naval transport; but agriculture has retrieved everything. Consequently there is no country where rural economy is held in greater honour. There are numerous agricultural associations; the agricultural society of the two provinces of Holland alone numbered 7000 members in 1860. They talk of uniting the members of all these societies in one powerful association, and hope to bring up the number to 40,000, fixing the annual subscription at 2s. At present, instead of such a combination, there are agricultural meetings which assemble every year, sometimes in one province, sometimes in another, to which proprietors and farmers flock from all parts of the kingdom. Many of these agricultural societies publish a report of their labours. All questions touching upon rural economy are handled in a number of journals, books, and pamphlets, and all foreign works of importance are translated.

The province of Groningen supports, at its own expense, an agricultural school, which is well attended. Among the circumstances favourable to agriculture, the number and excellence of the means of communication must be taken into account. Heavy traffic is all managed by water. Unrivalled facilities for navigation are afforded by the extent of sea-coast; by the Zuyder Zee, which penetrates far into the country, like an inland sea; by the multitudes of islands and river-mouths; by the rivers and canals that interlace and cross each other. On the seaboard there is not a farm without its dyke communicating with the nearest canal, with its boat for the conveyance of hay, manure, and the crops. It is by boat that the milk is brought home morning and evening from the pastures. The roads that complete this network are paved with bricks so hard that they ring like metal; perfectly kept, neat, even, without dirt or dust, you roll along as smoothly as upon the floor of a room.

Up to the present time there have been no railways over a great part of the country, and indeed they were less required here than elsewhere. They are now making progress every day.

---

XIII.—*On Anthyllis Vulneraria* (*Lady's Fingers*) as a Fodder Plant. By JAMES BUCKMAN, F.L.S., F.G.S., &c., Professor of Geology and Rural Economy.

THE *Anthyllis Vulneraria* (*Lady's Fingers*, or kidney vetch), is a plant commonly met with in this country, as well as over a great part of Europe and Asia. It is found, according to Bentham, 'In dry pastures and rocky stony places, chiefly in hilly districts throughout Europe and Western Asia, from the Mediterranean to the Arctic Circle. Ranges generally over Britain, although here and there considerable districts may be without it.'\*

The fact that this plant is tabulated in nineteen out of twenty local Floras, shows how general is its growth throughout our own island. It is, however, a lover of limestones, or calcareous soils, such as the oolites of the Cotswolds, the chalk ranges both in the South and West, and (according to Leighton) in Shropshire, 'on all limestone soils, especially Wenlock Edge (*Wenlock limestone*), Glecton Hill, near Wenlock (*Wenlock limestone*), &c."†

The *Anthyllis* may be distinguished by a compact head of yellow flowers, which is composed of two many-flowered bunches,

---

\* 'Handbook of British Flora,' p. 172.

† Leighton's 'Flora of Shropshire,' p. 351.

and, as the corolla, or more conspicuous part of each flower dies away, the hairy whitish calyx expands and becomes more conspicuous. This downy calyx (which is especially seen when the plant is grown in poor soils), and the downy aspect of the whole herbage would at first sight indicate that the *Anthyllis* is too dry and sapless to be relished as cattle-food.

In 1862, when my attention was called to this plant as being reported to yield a large crop of hay and green food, possessing "extra good qualities," upon exceedingly poor soils, namely, sandy chalk, and "without any manure," this peculiarity in its appearance made me hesitate, and express in print\* "some doubt about the good qualities in a feeding point of view of plants that can be grown on next to nothing," as such produce is usually found to be what the farmers term "without proof," a most expressive phrase, meaning "of a low feeding value." The soil accompanying the specimen sent to us was light and sandy in the extreme. Still "it must be conceded that the *Anthyllis Vulneraria* belongs to the same great natural order as the clovers and saintfoin, though, unlike them, its tap-root has by no means the same long penetrating character. It is, then, just possible that manure may much improve its qualities, and probably its yield, but it will be by producing a new variety (as the result of cultivative processes) that will be able to bear better with riches than with poverty."

The hay, of which a specimen was then sent, seemed from the extraordinary hairiness of its enlarged calyx, to offer but a poor choking diet for any kind of animal; this characteristic, as in hairy grasses, being a sign of want of flavour and quality no less than a mechanical impediment to such fodder being made the most of. I concluded, however, by remarking that plants quite hairy in the wild state lose that condition on cultivation; as examples we may give parsnips, and even the broad-leaved clovers. In these and in other plants which might be adduced the advance of smoothness and succulency is concurrent with improvement in produce as well as in feeding value. Again, in speaking of this hairiness of the foliage, and indeed the whole plant, I further directed attention to the fact that the specific name, *vulneraria*, is derived from its reputed efficacy in staunching blood and healing wounds; and as it has no astringent qualities, suggested that its property of stopping bleeding may have been due to its soft hairy qualities; so that any virtue it may possess in this way may only be found in the wild plant.

Having, then, stated these opinions in 1862, on establishing an experimental garden at Bradford Abbas, in 1864, it was

---

\* See 'Agricultural Gazette' for December 13, 1862, No. 60.

determined to make trial of the *Anthyllis* under cultivation, and I now proceed to glance at the results.

Having obtained two packets of seed from the Messrs. Sutton, named as follows, *Anthyllis Vulneraria* and *Anthyllis jaune*, these were drilled in rows nine inches apart, in May, 1864. Now, as every one will remember, this was an exceedingly dry summer, so that the plants barely established themselves before winter: however, on the 1st of May, 1865, the following results were noted, which I give in connection with those obtained from clover and its allies, of which more than fifty varieties were in cultivation in my experimental garden. These results were tabulated on the 1st of May, as evidence of the value of each plant for green food at a season when, as all farmers well know, succulent food for soiling is specially valuable from its scarcity.

*Results of some Experiments with Clovers and Kindred Plants.*

Botanical Name.	Common Name.	Height in Inches.	Estimated weight per Acre.	
			Tons.	Cwt.
<i>Anthyllis Vulneraria</i> .. ..	Lady's Fingers .. ..	6	7	0
" <i>jaune</i> .. ..	A French variety .. ..	8	8	12
<i>Trifolium pratense</i> .. ..	Broad Red Clover .. ..	4	2	0
" " var. <i>perenne</i>	Cow Grass Clover .. ..	4	2	0
" <i>pratense</i> .. ..	Broad Red, fine variety ..	6½	3	0
<i>Onobrychis sativa</i> .. ..	Saintfoin .. ..	16	5	0
" var. <i>bifera</i> .. ..	Giant Saintfoin .. ..	18	6	8
<i>Vicia cracca</i> .. ..	Cow Vetch .. ..	16	3	1
" <i>sativa</i> .. ..	Common Field Vetch ..	12	4	0
<i>Melilotus leucantha</i> .. ..	White Melilot .. ..	8	2	4
" " var. <i>major</i>	Bokhara Clover .. ..	13	4	12
" " <i>officinalis</i>	Common Yellow Melilot ..	6	2	5
<i>Lathyrus pratensis</i> .. ..	Yellow Vetchling .. ..	7	1	2

The conclusions to be drawn from this table in reference to the other varieties of this order under trial may be reserved for future consideration.

The *Anthyllis jaune*, or *Trèfle jaune des Sables* of the French, and the *Gemeiner Wimoklee* of the Germans has been under cultivation both in France and Germany for some time; I have, therefore, no doubt that our seed of *Anthyllis jaune* was from the plant in cultivation in France, and that of the *Anthyllis Vulneraria* of our list was from the seed introduced to the notice of English agriculturists. But be this as it may, the difference is apparent, not only in the weight of the produce, but in other particulars now to be mentioned. In the wild plant the terminal leaflet of the pinnate leaves is about an inch long and three-eighths of an inch broad, and is covered with

*long silky hairs*; in cultivation this often attains a length of two inches, and a breadth of five-eighths of an inch, and is *only slightly hairy*; such is the improved English plant. In the French plant this leaflet attains the length of three inches, and the breadth of one inch, and is *quite smooth*. I am disposed to think that the size of these leaflets may be roughly taken as a measure of the succulency and feeding value of each variety, and I have already stated that my experiments in 1865 on the cultivated and smoother varieties of the *Anthyllis* had modified the opinion which I had formerly expressed with reference to the wild plant with its hairy foliage.

My experiments with the clover and the kindred species also brought out the fact, that while most of the true clovers were attacked by the Broomrape (*Orobanche*), the *Anthyllis* in all my plots entirely escaped. I find, moreover, in the French 'Journal d'Agriculture Pratique' for April, 1864, mention of the *Trèfle violet* (Lucerne) being injured by dodder, while the *Anthyllis jaune* escaped.

I have not as yet given this plant any extended trial in field-cultivation, but I purpose to do so this year, and think that it is of sufficient importance to warrant my asking other farmers to join in the inquiry. I still hold, however, that the plant in its wild unaltered form, as grown on poor soils "where nothing else will grow," will only give results that are more or less disappointing; but if by good cultivation and more generous treatment we can succeed, as there seems reason to anticipate, in making of this stunted hairy kinsman of the clovers a fine smooth succulent forage-plant, it may encourage us to deal in like manner with other members of this family, which I am convinced includes many species that may be made useful to the farmers besides those at present in cultivation. The French Agricultural Journals strongly recommend the cultivation of the crop in question, and generally upon the grounds that it comes in as a green crop a little later than the *Trifolium incarnatum*, or even than the *Trifolium incarnatum extra-tardif*. It is grown in France much in the same way as the *T. incarnatum*, namely, well harrowed after harvest into the oat or wheat stubbles to be ready for feeding the following summer. It, however, differs from the *T. incarnatum* in that this is annual, while the *Anthyllis* is a perennial plant, and if grown in good mixed marly or calcareous soils it holds on to the ground with great pertinacity, though repeatedly cut down. In fitness for a hay crop it is superior to the *T. incarnatum*, as it is not so sticky and more juicy, if taken at a right time just as the flowers have opened, but this superiority of course depends upon whether we have the cultivated sort which will best be secured



by procuring French or German seed. I am not aware that any analysis has as yet been made of the plant; this, however, should be done from specimens taken both in its green or grazing state, and in the shape of hay.

---

*Letter from MR. GEORGE TURNER, of Barnham, near  
Thetford, to the Editor.*

“SIR,—In answer to your request, I give you the results of my experience in the growth of the *Anthyllis* (or kidney vetch), although I fear they are hardly worth recording.

“Knowing the district in which Mr. H. Stebbing gathered his original stock of seed, and afterwards seeing it growing on his farm at Stow Beedon, I felt convinced it was a valuable plant, especially for light sandy lands, with a chalk subsoil, the nearer the chalk the better. I began by sowing one acre and an half in the spring of 1860, which piece I fed in the following spring, from the first week in April until the 21st of May, then shut it up to mow; finding it well headed I saved it for seed, cut it on the 19th of August, and had two good waggon-loads, which produced 5 bushels (of 70 lbs. each) of seed; the following year I fed it all summer; in 1863 I again fed this same piece, together with another piece sown in 1862, until the 21st of May, and I then took another crop of seed; I began to cut on the 5th, and carted on the 12th day of August, the two pieces had two waggon-loads per acre, and averaged 5 bushels of fine seed per acre,—this is the best crop I have grown. After a seed-crop my land has produced but little after-feed. The two following years I had not so good a plant, neither have the seasons been so favourable.

“As to ‘drawing’ the seed, I have always found this a very slow and troublesome job; but I get all my seeds drawn by contract, with steam-engine and barrel-machine, at 5s. per bushel. Last year it took me five days to cob and draw the 45 bushels of *Anthyllis* which I grew; but the rain which fell upon it in 1865, whilst it slightly affected the colour of the seed, assisted the drawing very much.

“To show how I appreciate this plant, I began with  $1\frac{1}{2}$  acre the first year, had 5 acres the second, 20 acres the third, 40 acres the fourth, 60 acres the fifth, and 35 acres the sixth (last year), all of which (with the exception of 5 acres) is still laying, and constantly fed by sheep.

“I have always drilled 16 or 17 lbs. per acre with a seed-drill, and the earliest sown in the spring is the best and strongest plant. I think it will bear to be fed very close without injury to the

plant; I never have cut any for hay, my object having been to cultivate it more for the feed, which the sheep eat with great avidity, and are soon satisfied. I think it a good astringent when there is a tendency to scour. I ought to tell you that mine is a large light-land sheep-farm, the greater part very poor sand; and it is on the poorest parts that I have been growing the kidney vetch.

“I am, Sir, yours very truly,

“GEORGE TURNER.”

Jan. 26, 1866.

P. H. FRERE'S *Experience of Anthyllis*.

IN the spring of 1863, on the recommendation of Mr. Stebbing (of Stowe Beeton, Attleborough, Norfolk), I was induced to sow about 4 acres as a layer, instead of rye-grass and trefoil, on some poor heath-land—black sand with a chalk subsoil. In that dry season the seeds on the rest of the field adjoining failed almost entirely; the *Anthyllis* looked very thin in April, 1864, and was condemned, but was so much improved in May, that a part, and then the whole plot, received a respite, and did very good service in the scorching July that followed. After all the other layers had been depastured by the sheep, and no fresh feed had sprung up, the *Anthyllis* was still in reserve.

I find the following note in my farm-book: “1864, July 26. The lambs finished the *Anthyllis*; having had 12 days feed for 220; 307 ewes were kept 4 days on the land after the lambs left. Some little after-feed grew, and was eaten off by sheep which also ranged over an adjoining heath, and left a light folding.

I observed that where some stray seeds had been blown by the wind at sowing-time on to the adjoining land (sown with rye-grass and trefoil), the plants which grew therefrom were picked off first by the sheep when that land was folded. In 1865 the layer, now in its second year, was partly sheep-fed, partly cut for seed. The farm-book notes, 1865, July 10, 90 shearling ewes finished 1 a. 2 r. 18 p.; 14 days' keep. Calculating the week's keep at 6*d.* per head, the value of the feed comes to 3*l.* 4*s.* per acre, and it was reckoned to be as abundant and quite as hearty as the best red clover on my farm growing on land of double the value; the ewes, which were for sale, and therefore fresh in condition, received a little cotton-cake in addition to the *Anthyllis*.

The remainder of the plot, 2 a. 3 r. 27 p., was cut for seed on the 21st of July, and carted on the 28th; there were 6 waggon-loads; estimated at 5 tons of stover, or 1 ton 14 cwts. per acre. This has lately been thrashed lightly by hand, to knock off the

husk and seed, and the stover has been cut into chaff for stock, and proved most serviceable in a season when our straw is extremely short in quantity and bad in quality. We value the stover at 3*l.* per ton, or 5*l.* per acre for 1 ton 14 cwt.

To part the seed of this plant from the husk must always be a troublesome job: not having a proper "cannon" for drawing the seed, I have employed my own American grist-mill and steam-engine for the purpose, which did the work well, but slowly, for it is not easy to feed the mill fast enough. I have only got 7 bushels of seed in all, and it has taken 7 days to pass the husk through the mill and finish off the sample for market. On two of these days I used a hired "cannon," but did not get on much the faster. Had it been clover-seed, the whole job would have been completed in one day.

Mr. Stebbing likewise informs me that he has much trouble in preparing *Anthyllis* seed for market. In 1864 he grew 64 bushels of clean seed on 18 acres of land, and estimates the cost of drawing, &c., at 36*l.* 13*s.* 8*d.*, or 11*s.* 5½*d.* per bushel. His trouble and expense were, however, increased, because there were seeds of self-sown red clover and rib-grass on the land, which had to be got rid of by frequent siftings, and the smaller *Anthyllis* seed went with them. This inferior seed was sold, and the proceeds diminished the cost of drawing, &c., from 11*s.* 5*d.* to 8*s.* 9*d.* per bushel on the prime seed.

Mr. Stebbing last year thrashed with a common thrashing-drum; passed the cob twice through Holmes' chaff-riddles, which he highly recommends; then began drawing by passing the cob three or four times through that same drum, then again used the riddle and the fan, and on the last day finished off with a hired "cannon." The motive power was provided by an engine, hired at 20*s.* per day. This year he is using horse-power, and finds it more economical to put the cob through a dressing-machine, than to use riddles and fans. The work is not yet complete (Feb. 19, 1866).

It appears, then, that the yield of seed is generally small, and the trouble and cost of separating it from the husk or cosh must always be considerable, so that its price will generally be higher than that of any other variety of the clover tribe.

I have bought the seed direct from the grower first at 1*s.*, then at 1*s.* 6*d.* per lb., and am told that the price has risen as high as 2*s.* 6*d.* per lb. In France I believe it sells at 2 francs per lb. and upwards. If, on an average, 3 bushels of seed weighing 70 lbs. each, and worth 1*s.* per lb. can be grown on an acre, besides 1½ ton of stover (worth 4*l.* 10*s.*), the return from this crop will be as good as any that thin chalky land in a dry climate can produce in these times.

I am inclined to think that when intended for a crop of seed, the Anthyllis should be grown on land of better quality than that sown merely for sheep-feed. By acting on this impression I shall carry out Professor Buckman's view of *improving* the plant by higher culture.

---

XIV.— *On the Cultivation of Flax in Belgium.* Report by R. PERCY FRENCH, Second Secretary to H.B.M.'s Legation at Brussels.\*

#### INTRODUCTION.

PLINY, the naturalist, informs us that the Marini, whose territory corresponded with what is now the South of Flanders, excelled in the art of weaving flax. There is no doubt but that it was cultivated to a considerable extent in the eighth century; for Charlemagne, in his Capitularies, requires that the ladies of his Court "shall prepare and spin flax to make garments."

At the beginning of this century flax occupied in Belgium at least one-third more space than all the other so-called industrial plants united: since then, and especially since 1840, the extent of land devoted to this culture has sensibly diminished.

In 1840 there were 40,998 hectares (102,495 acres, nearly) under flax; in 1846, only 29,879 hectares (74,695 acres), yielding 211,782 hectolitres of seed (582,398 bushels), and 17,407,730 kilogrammes (about 17,400 tons) of fibre.

Two varieties are generally grown in Belgium: the "vulgar" flax, bearing a blue flower, and that which has a white flower.

The last-mentioned, which is grown in the "Pays de Waës," gives a coarse but abundant and hardy filament, almost exclusively employed for mixing with hemp. The American white-flowered flax has been tried in different districts with varied results. The blue-flowered flax is less hardy, but yields a finer and softer filament.

The choice of seed is of great importance. There are many ways of testing its quality, but the surest is by germination: in some of the localities about Termonde two-year-old seed is considered preferable. It is winnowed in autumn, exposed five or six days to the sun, then deposited in a dry place, and stirred from time to time.

Great attention is paid to the origin of the seed, whether it be grown for seed or for filament; northern seed being used for the former, and southern for the latter purpose.

---

\* Placed at the disposal of the Royal Agricultural Society by Her Majesty's Secretary for Foreign Affairs.

Three sorts of seeds are employed in Belgium—those of Riga and Zealand, and that of the country, called “Après-tonne.”

The seed grown in the country is generally considered to be inferior to that of Riga, unless cultivated with especial care and gathered from plants of a superior quality.

That bearing the name of Zealand is nothing more than seed gathered in Holland from plants produced from Riga seed. Its plants are sometimes weak, but oftener full and flexible, the stalks retaining a green hue when ripe; the filament is also very fine and flexible. This seed is much used in the Western Flanders, and chiefly in the district of Courtrai, where the land is heavy.

The seed of Pernau (situated on the Gulf of Riga) is also much used: the plants produced by it are vigorous and healthy, and the filament long, fine, heavy, silky, and of a silvery colour. Experiments have shown that it gives one-fifteenth more filament than the seed of Riga.

*Climate.*—Flax can only be raised in a temperate climate, neither too wet nor too dry. Heavy winds, storms, hail, heavy rain, &c., are extremely prejudicial to it. The best aspect for it is to the north and east. If there be too much shade or the atmospheric influences of warm, damp, heavy weather, the filament becomes light and weak from the forced growth of the stalk.

*Quality of soil required.*—The finest flax is grown on loamy land, but many varieties of soil will bear a crop, provided they are properly prepared by deep tillage and manure. On a sandy soil, the filament, albeit long and fine, will be far less strong than that grown in a richer soil. In heavy wet land it will grow (in good seasons) to a great length, but the filament is never fine. Light fertile land gives a shorter crop, but a finer and silkier filament. The “Pays de Waës” bears an European reputation for its flax, though the soil is sandy; it is, however, extensively manured.

Of manures the principal are: ordinary yard-dung, cakes made of the seed of rape, poppy, hemp, and cameline (or gold of pleasure), guano, Dutch ashes, lime, and liquid manure. For light land the ordinary stable-manure is found to be the best. In the Western Flanders the cakes of rape and poppy are found to accelerate the growth and to give a finer texture to the filament. These cakes are also much used in Hainault, and mixed with cameline, which imparts a beautiful colour to the flax.

According to a calculation made by M. de Gasparin, 100 kilogrammes of dried flax contain 1 kilogramme 12 grammes of azote taken out of the land.

*Preparation of the soil.*—The preparation of the soil in Belgium,

as elsewhere, naturally depends on the succession of the crops. Light sandy soil is generally ploughed to a depth of 12 inches, moderately fertile land 8 inches. Loamy land is ploughed a second time before winter, and the manure turned in, which becomes gradually absorbed.

Clover, if it has preceded the flax, is ploughed into the land in autumn with dung or Dutch ashes, and a harrow passed over it to level the soil; a second and third stirring are given before the winter. In the spring the land is again harrowed and the flax sown.

After rye and turnips, a light dressing of manure is dug or ploughed into the land in March; the plough and harrow are again used, and Dutch ashes or liquid manure applied a few days previous to sowing the flax.

After oats, which have been well manured, one turn of ploughing is sufficient, and the soil is watered with "purin" (fermented night-soil).

Flax sown after a crop of hemp gives the best and finest return.

In the Western Flanders ploughs are generally used, while in the Eastern Flanders they still use the spade.

In the country about Courtrai they spread over the land, already half-manured, a mixture of the aforesaid cakes of rape and poppy, with "purin" in the proportion of from 1200 to 1600 cakes, and from 1800 to 2600 gallons of "purin" per acre.

The mixture is made ten days before using, worked up in tubs or barrels, and spread uniformly over the whole surface of the soil.

In wet lands these cakes (called "tourteaux") are reduced to powder and spread over the land, which is afterwards watered with "purin"—1300 to 1550 gallons per acre (150 to 175 hectolitres per hectare).

An acre of land, fully prepared for receiving the seed, costs in the environs of Courtrai from 7*l.* 4*s.* to 8*l.* 4*s.*, thus accounted for :—

	£.	s.	d.	£.	s.	d.
Rent and taxes .. .. .	1	10	0	2	0	0
Manure of all sorts .. .. .	5	4	0	5	14	0
Labour .. .. .	0	10	0	0	10	0
Total .. .. .	7	4	0	8	4	0

In the "Pays de Waës" from 8*l.* to 9*l.* 6*s.* :—

	£.	s.	d.	£.	s.	d.
Rent and taxes .. .. .	1	18	0	2	14	0
Solid manure .. .. .	2	10	0	3	0	0
Liquid manure .. .. .	2	16	0	2	16	0
Labour .. .. .	0	16	0	0	16	0
Total .. .. .	8	0	0	9	6	0

About Tournai an acre costs 8*l.*, and in general an acre of what is called "lin ramé" (fastened to sticks), costs, everything included, from 14*l.* to 14*l.* 5*s.*

*Rotation of Crops.*—Formerly the flax-crop was only taken every fifteen to twenty years: there is now a great diversity of opinion on the necessity of so long an interval. In many places it has been reduced by half, and a crop is taken every seven years. Rapid succession deteriorates the quality of the fibre, which is generally considered to be not so good now as it used to be. The lands of Wynkel St. Eloi, near Courtrai, which were overworked during the Empire, produced no good flax for thirty years, nor have they yet recovered their former value.

In the Western Flanders the rotation varies from five to ten years; Eastern Flanders, five to nine; Brabant, five to eight; and Hainault, seven to twenty years.

In Belgium there are two sowings of flax, the early and the late, the former between the end of March and the 10th of April, and the latter from the 15th of April to the end of May.

The flax-growers consider that the early crop produces the finest quality of flax, the late crop being good only for coarse tissues, &c. Much depends naturally on the weather and the quality of the soil.

The seed is sown thick, if fibre is the object; but thin, to produce seed; 13 stone per acre is a common amount. In Belgium fibre is the principal object, and if not closely planted, the flax loses its fineness and the stalks are "branchy."

In the Western Flanders it is generally sown alone; in the Eastern Flanders with carrots and clover. Flax sown in soft calm weather appears above ground in about a week or ten days; it is then carefully weeded by women. As soon as each plant has received 1205 degrees of heat after germination, they begin to bear flowers, and are supported by small sticks to prevent the crop being laid. The process of weeding costs from 19*s.* to 28*s.* per acre.

The process of gathering is the same throughout the whole of Belgium. When the plants are standing they are seized by handfuls, care being taken not to entangle the stalks: if lodged, they are gathered carefully and shaken so as to separate the tops, then made into bundles, which are set up in "schocks." After ten or fourteen days of fine weather they are made into fresh bundles, containing 10 to 14 lbs. each, and stowed in barns or sheds.

An acre of flax gives from 24 to 70 cwt. of stems, containing from 12 to 18 per cent. of fibrous substance, and producing from 3 to 6½ cwt. of filament fibre.

The cultivation of flax and hemp occupies in the two Flanders,

a part of Brabant and Hainault, from 75,000 to 100,000 acres of excellent land. This has to be carefully tilled and manured in order to produce 20,000 tons of what is called "lin teillé" (peeled flax), representing in value at least 1,440,000*l.* As a raw farm-produce it yields 120,000 tons of green flax.

The number of labourers who find employment in the producing, steeping, scutching, cleaning, and exporting of flax, cannot be ascertained.

On an average, the exports amount to 18,000 tons of vegetable fibre. In 1860 the value was estimated at 880,000*l.*, now much exceeded, owing to the cotton crisis.

In Flanders there were lately 220,551 female hand-spinners, 57,148 weavers, and 60,000 souls employed in cleaning, preparing, bleaching yarns, &c.

In 1846, 74,695 acres of flax were grown in Belgium; in 1856, 82,090 acres; showing an increase of 7393 acres.

In 1846, the quantity of flax produced amounted to 17,405 tons, making an average of about 37 stone per acre.

The entire extent of land under cultivation in this country amounts to 4,576,290 acres; and since of these 82,090 are given up to flax, this crop constitutes  $\frac{1}{57}$ th upon the whole.

The rise in the price of cotton, occasioned by the American war, has led to an increase in the cultivation of flax, reckoned at 22,000 to 25,000 acres.

There are two systems of steeping generally followed in Belgium—one, "rural steeping," in the open air; and the other, in covered barns, called "American factory."

The rural system is subdivided into steeping by dew and steeping in rivers.

The first named, principally practised in the provinces of Hainault and Namur, and the cantons of Grammont and Ninove, consists in spreading the flax over a field of grass or clover late in the autumn, or in the months of January and February. The winter steeping gives the best and whitest flax.

In France, before spreading, it is customary to wet it with a solution of alkali; and in Holland with sea-water, to prevent its being stained. This process of steeping occupies about a month. The expense of this process is on an average 19*s.* per acre. This system produces a grey or bluish fibre, and is only resorted to in places where water is scarce.

*Steeping in Stagnant Pools.*—The water should be as clear as possible, and devoid of iron or chalk, which affect the quality and colour of the flax.

In the province of Waës, two sorts of "routoirs" (steeping-pools) are employed—the "routoir bleu argentin," which owes its colour to the natural sediment of the soil, and the "routoir



jaune," also owing its colour to the same natural causes. Alder-leaves and poppy-heads are supposed to improve the colour of the flax. The flax-plants are made into bundles, placed in the pool, and covered with planks and stones to keep them under water, and are left to soak for ten or twelve days. This process costs from 19s. to 1*l.* per acre.

*Steeping in Rivers.*—The flax must be a year old, and the stream limpid, so as to preserve the whiteness of the filament. In the environs of Courtrai it is generally kept for two or three years before being steeped. It is placed either horizontally or vertically; flax steeped horizontally is not so white, but more soft, the water making its way through it much less rapidly, so as to cause putrefaction, and thus produce softness. The bundles of flax are tied with osier twigs, fastened to stakes embedded in the river, and are kept stationary by means of cords fastened to posts on the banks of the river.

Flax that is to be steeped vertically is either fastened to poles, and plunged under water, or else placed in cages or frames lined with straw, containing 150 bundles; the cage once filled, and the top of it covered with 1 or 1½ inch of straw, is fastened by cords to posts, and let down into the river. At the end of a few days fermentation sets in, and the cage becomes heavier; care must be taken not to disturb its equilibrium. This process generally requires from seven to ten days, the time varying according to the season and temperature: thus, in May, it requires between nine and ten days; in August, seven days; and in October, twelve days.

The steeping of an acre of flax, including what is called the "arrière rouissage" (the latter process), costs 48s.

This process generally gives a coarse fibre, but strong and of a good colour, and in quantity inferior to that produced by the steeping in stagnant pools.

The "arrière rouissage" consists in stacking the bundles after they have been taken out of the steeping-cages, and are free from water. When once the flax is well dried it is again spread over a field to whiten.

The "factory," or American process, is already well known in Ireland, under the name of "Schenk's Patent System for Steeping Flax;" it would be therefore superfluous to describe it.

After steeping ("rouissage") and stripping ("teillage"), which is done by hand, or on pieces of wood with teeth like a saw (called "broyoires"), the flax is divided into what is called "brin," the finer portion, and tow, the coarser; the first named being used for thread.

Until lately the system of "rouissage" (steeping) practised on the banks of the River Lys was considered the best in Belgium;

but it has many drawbacks. Firstly, that of vitiating the atmosphere and tainting the water, and so producing disease; on which grounds numerous petitions have been presented to the Chamber of Representatives to obtain the abolition of this practice; secondly, the inconveniences that arise from atmospheric irregularities, quantities of flax being annually destroyed by storms, or even by the influence of an impending storm.

M. Alkan (a celebrated French engineer, Professor of the Conservatoire des Arts et Métiers, &c.), remarks in a Report on the treatment of flax, that "the intelligent flax-growers of the banks of the Lys have learnt by experience, that it is impossible to obtain satisfactory results from a single process of steeping; that the two operations, at the interval of a year, occasion great loss of time and money; that ulterior manipulation is still indispensable; and that after all, the results are unsatisfactory, because the filament is never properly divested of its gummy element, and its chemical state, colour, quality, and appearance, are affected by the impurity of the water."

On account of these defects, which are inherent to the preparation of flax in the open air, with no system of control beyond that which is more or less exercised by the eye and the touch, every effort has been made to supersede the rural system of steeping ("rouissage rural"), which, if performed in stagnant pools, is a source of infection and disease, and if in running water, adds a considerable loss of time to the above-mentioned drawback.

To this end the so-called American system has been employed, which consists in steeping the flax in tubs of hot water; but the immense size of the premises required, the great losses occasioned to the workmen by the use of drying machines, the relative slowness of the process, and the extra care required, have caused the gradual abandonment of this system, which does not separate the fibres of the filament any better than former ones.

M. Julien Léfébure, a Belgian, being struck by the unsatisfactory results of the American process, devoted all his time and attention to the discovery of a system, the important advantages of which have been admitted by the most competent authorities.

M. Léfébure obtained a gold medal for flax and hemp steeped and combed by his system, at the London Exhibition of 1862; and the "Société Linière" of Brussels also obtained a medal for their linen and thread, prepared by M. Léfébure's system; but although its successful results have been satisfactorily displayed, the system cannot as yet be said to have superseded the old ones, or to be generally in use.

The following extracts from M. Alkan's Report, in which he recognises the incontestable superiority of M. Léfébure's invention, seem to be worthy of attention:—

“The principal characteristic of the filament obtained by M. Léfébure’s process (by alkalis) is the admirable way in which the fibres are separated without affecting the quality of the flax. This filament possesses a brilliancy, fineness, regularity, strength, and uniformity of colour, such as we have never seen produced by any other system of steeping.

“The thread is longer and more elastic than that produced by the ordinary systems, and the linen far superior.

“The results will be the more evident, in proportion as the filament becomes employed with means appropriate to its special character.

“M. Léfébure’s process is based upon a combination of chemical and mechanical appliances. Let the time required, the quantity of liquid, and the substance it contains, be what they may, the flax in the bundles is as uniform after as before immersion; they preserve a uniformity of colour, which indicates the regularity of the action, as well as its efficacy; it, moreover, realises simultaneously the effect which in the other systems requires two distinct operations at long intervals.

“Thus, according to the present system, with its indifferent effects, it is necessary, in order to avoid accidents, to stop the operation before the textile matter is relieved of the gum, thereby causing grey and dark tints in the thread and tissues, and the necessity of ‘ungumming,’ discharging, the gum from them later, as thread, or when already made up into linen, and often in both cases. This occasions loss of time and money, an expense of from 20 to 25 per cent. on each kilogramme of thread, and considerable waste.

“By M. Léfébure’s system the steeping and *crémage* (term applied to the second operation generally performed to extract the gum) can be done simultaneously in twelve hours (the maximum required), instead of the twelve days required for the ordinary steeping, or sixty hours, according to the American system.

“We should add, that although the system of Léfébure comprises operations and manipulations, requiring care and an intelligent superintendence, it presents no difficulty whatever in its application. Any one commonly conversant with the ordinary process of sorting and manipulating flax can be easily initiated in the new method.

“A question of vital importance to persons desirous of investigating practically a new system of steeping, is to know what amount of good filament can be obtained from a given quantity of flax.

“The proportion varies from 10 to 18 and 20 per cent.; in the actual state of things the variation must depend—

“1. On the nature and quality of the flax.

“2. On the degree of perfection to which the steeping has been brought.

Comparative trials made in Belgium with large quantities of flax prove that steeping in warm water gives a far more regular result than steeping in rivers, and our experience of M. Léfébure's system confirms us in the idea that its results are far better than those obtained by any of the others. We can affirm that the system of Léfébure properly applied produces the entire amount of filament contained in the stalk, according to the highest calculation; that this system is founded upon true principles, and employs agents easily applied without endangering the quality of the substance, or causing useless expenditure; in its bearing upon the filament, it presents the advantage of acting on the mass of fibre alone, of employing only the liquid substance strictly useful, of considerably diminishing the amount that requires drying, of acting with greater precision and certainty than any other system, and finally of turning to account a considerable portion of the waste matter.”

M. Alkan also states that the system Léfébure has the further merit of superior economy, if it be taken into account that it does away with the operation of “*crémage*” (washing), to get rid of the gum, which costs 8*d.* per cwt. of dressed fibre. As a difference of opinion exists on this point, I will not follow him through his calculations, but simply state that he estimates the cost of transforming 1 cwt. of flax-stalks into filament, including everything, crushing, stripping, placing in tubs, alkaline water, heating, manual labour, drying, &c., at a maximum of 4 francs; and supposing a return of 15 per cent. in fibre, the preparation of 1 cwt. of fibre costs 26 francs and 66 centimes.

He puts the total cost of steeping by the old system at 2*l.* 2*s.* (42 francs 25 centimes) per cwt. He attaches, however, the chief importance to the certainty of obtaining rapidly and regularly thread and tissue of a quality and texture hitherto unequalled, of being able to separate and refine the fibre in a way that so much facilitates all ulterior transformation, and further to the avoiding of all risk of destruction to the crop, and all irregularity in its quality.

“In short, the plants prepared on the one hand by the ordinary process of steeping, and on the other by the new system, produce filaments of such different quality that the superiority of the latter speaks for itself.”

I have also before me the Report of a Commission appointed by the “*Société Centrale d'Agriculture de Belgique*” to examine M. Léfébure's system, with a view to the suppression of the system of “*rural steeping*.”

The three members composing this Commission were—M. Taek, a great linen-manufacturer at Courtrai, and member of the Chamber of Deputies; M. Rey, the most important “filateur” in this country; and M. Van den Broeck, an experienced chemist.

Nothing can be more favourable than their Report, of which I subjoin the following passages:—

“M. Léfèbure’s system differs from those hitherto practised, and we will commence by stating that the flax steeped by it is whiter, stronger, and more silky than that produced by any one of the older systems.

“We must beg leave, however, to differ on one point from M. Alkan, who has shown in detail the important advantages of this process in his able Report, *i. e.*, that relative to the comparative expense of steeping in the two systems.

“According to experiments made by one of the members of this Commission, the expense was found to be about the same as that of the steeping performed in the River Lys, agreeing perfectly with that announced by M. Léfèbure, but exceeding M. Alkan’s calculation. The great advantage, then, lies in the immense superiority of the ‘textile matter’ produced by the system Léfèbure; and we may justly ask why, in spite of such incontestable proofs, our great spinners and manufacturers have not as yet more generally adopted this system.

“The opinion of those who have been consulted is that the machinery should be modified, in order to admit of the flax being spun at its full length, and in cold water (as in hand-spinning), instead of being cut into three lengths, as is now the case. To effect this revolution in their machinery would be a considerable expense for the spinners, and without it they cannot conveniently use the flax prepared by the new system; and under existing circumstances the manufacturers cannot procure a sufficient quantity of flax prepared in this manner to feed their establishments: the spinners are consequently afraid of being losers by this new outlay.

“On the other hand, the cultivators cannot individually undertake a system of steeping requiring an apparatus and motive power appertaining rather to manufacturers.

“Under these circumstances it appears to us that the system Léfèbure is destined to create some great undertaking for steeping and spinning that will furnish weavers with thread of a quality that will replace the ‘fil crémé’ (skimmed thread).

“This thread, being already ‘crémé’ by the steeping, would be stronger, would produce superior tissues, and would bear an extra value of 20 per cent.

“The reason why the thread produced by M. Léfébure’s process is stronger and better than that given by rural steeping is, that according to his system the steeping is performed instantaneously, thereby preventing the fibre from deteriorating by putrefaction; while by the rural process the fibre is often damaged by the rotting of the straw, not to mention the risks from the state of the atmosphere, temperature, overflowing of rivers, &c.

“All these accidents are avoided by the system Léfébure.

“The chemical action of the alkali (used in this process) upon the fibre is highly approved by the member of the Commission specially acquainted with this point, who states that the liquid residue proceeding from the operation is extremely serviceable as manure.

“Finally, great public and private interests are interested in the solution of this problem in a sanitary point of view; and, in furtherance of these, we may mention the constant complaints and protests of the inhabitants of Ghent against the system of steeping in the river Lys.

“We consider that this new system is called upon to replace the former ones; and the more so, since there is every probability of its expense being diminished.

(Signed)

“TAEK.

“REY.

“VAN DEN BROECK.”

The Léfébure process resolves itself into three successive operations; to explain these, I will suppose an establishment in which 1 ton of undressed flax is daily treated, producing about  $3\frac{1}{2}$  cwts. of prepared flax, ready for spinning.

*First operation, Crushing* (“*Broyer*”).—One ton of flax in bundles, or in the straw, occupies a space of 15 or 16 cubic “mètres” (525 to 560 cubic feet), and when crushed gives a return of—

1st.  $6\frac{1}{2}$  cwts. of crushed flax, occupying a space of about 1 to  $1\frac{1}{2}$  cubic mètres (35 to 50 cubic feet).

2ndly. 12·8 cwt. of “chenevottes,” or “shoves,” occupying 3 mètres cubes (105 cubic feet). (This product, when reduced to ashes, gives a potash of 24 degrees of strength.)

Lastly. 40 kils. (88 lbs.) of “natural waste,” which is useful for making paper or coarse packing-cloths, and occupies a space of 0·30 mètres cube.

*Second operation, Steeping and Washing.*—The steeping apparatus should measure  $4\frac{1}{2}$  feet in height, length, and breadth, containing 320 kilogrammes of raw filament in 20 or 23 frames (cadres); there should also be a “basin,” “cuve,” 6 feet 3 inches

in length, and 4 feet 7 inches in depth, to contain 823 gallons of liquid.

The chemical substances employed in this process (which are exclusively alkaline) cost in Belgium 14s.; in England, 11s. 6d., for the above-mentioned quantity of flax.

*Third operation, Drying.*—A “séchoir,” or apparatus for drying the fibre produced by 1 ton of green flax, which, when washed and crushed, will be reduced to  $6\frac{1}{2}$  cwts. of flax, measuring 22 yards cube; the flax should be hung upon wooden bars placed one above the other at a distance 19 inches. The return of dried flax is about  $3\frac{1}{2}$  cwts.

Recapitulation of process for dressing 1 ton of green flax:—

	Cwts.
Prepared flax .. .. .	3.5
Shoves or <i>chenevottes</i> .. .. .	12.8
Waste material .. .. .	0.8
Residue after washing (an excellent manure mixed with 1540 gallons of water) .. .. .	4.9
	20.0

*Hands required.*

- 2 workmen.
- 13 boys for “crushing.”
- 2 men for making bundles.
- 3 boys for making bundles.
- 4 boys for cleaning.

*Washing.*

- 1 man.
- 2 boys for washing.
- 2 boys for drying.
- 5 boys for “kneading” the flax (rendering it supple).
- 1 master workman.

Total .. 35 men.

*Expense at Brussels.*

	Fr.	c.	s.	d.
1 master .. .. .	4	0	=	3 2½
5 workmen, 12 hours, at 13 centimes per hour	7	80	=	6 3
29 boys at 4 centimes per hour (12 hours) ..	13	92	=	11 1½
	25	72	=	20 7
Chemicals .. .. .	16	0	=	12 9
Coals (100 lbs.) .. .. .	5	20	=	4 2
	46	92	=	37 6

The average return being 175 kilogrammes of flax ( $3\frac{1}{2}$  cwts.) ready for weaving, the cost of preparation is of 26 or 27 centimes per kilogramme ( $1\frac{1}{4}$ d. per lb. nearly). The expense of machinery, &c., necessary for dressing from five to six tons of flax per diem is 1512l.

Such being the opinions of very competent persons called

upon to decide on the merits of this new system, it would seem that the chief obstacle to its success arises from the difficulty of reversing a system which is hallowed by long existing custom. Were a company organised in Great Britain or Ireland to establish on a large scale such works as M. Léfébure could only set up on a smaller basis, most satisfactory and economical results would probably be obtained.

*Brussels.*

## XV.—PROFESSOR VOELCKER'S *Annual Report.*

### INVESTIGATIONS IN PROGRESS.

THE following subjects for investigation have already occupied my attention in the past season, and are likely to engage a considerable portion of my time in the coming spring and summer.

1st. The composition of waters used for irrigation, and the causes of the highly beneficial effects which characterise the action of some natural waters, and the indifferent or injurious effects of others.

2ndly. An inquiry into the chemical conditions involved in the growth of clover-seeds (artificial grasses).

3rdly. The changes which take place in grass and clover during hay-making in the field, and storing in the stack.

Although a good many analyses have been completed in the past season, having special reference to the two last-named investigations, the results obtained do not furnish a sufficiently strong chain of analytical and practical evidence to warrant the publication at the present time of papers on such important subjects.

### INVESTIGATIONS COMPLETED.

1. An inquiry into the absorbing properties of soils of known composition for soda, and the functions of salt in agriculture. The results of this investigation are embodied in a paper published in last number of the Society's Journal.

2. *On the Composition of Mangold Tops and Bulbs.* A paper on this subject is already in type, and will appear in the forthcoming volume of the Journal.

3. I have further nearly completed an investigation into the solubility of phosphatic materials, with special reference to the various forms in which bones are employed in agriculture, and their economical uses.

### FIELD EXPERIMENTS.

At the request of the Chemical Committee, I have carried out the following field-experiments:—



*a. On the Efficiency of Salt as a Fertiliser.*

Experiments with salt on mangolds, potatoes, swedes, and clover-seeds were tried in several parts of the country.

In most instances no very marked effect could be noticed in the crops so manured. The unusually dry and hot summer, which was very unfavourable to the growth of swedes, prevented the beneficial action which salt, under more favourable circumstances, is capable of exercising.

In some instances the application of salt, no doubt on account of deficiency of moisture, and an unusually high temperature in spring, had a decidedly injurious effect on vegetation.

In one series of experiments in which quantities of salt, varying from 1 to 8 cwt., were applied to mangolds, grown on a very light sandy soil, the increase of the crop was very considerable, and much larger on the plots on which salt was more freely used than on those on which it was applied more sparingly.

On light soils, especially, salt appears to be useful for mangolds, and in all probability to turnips and swedes, and other root-crops. The failure of the same series of salt-experiments on certain light soils, contrasting with their success on other very similar soils, induces me to think that salt (and probably other valuable and highly soluble manures) is often put on the land too late in the season. Even on light land I would suggest that 4 or 5 cwt. of salt be sown broadcast as early as February, and that its application be not delayed until the time of sowing of turnips or mangolds, and still less until the roots are singled.

*b. On the practical Effect of crude Potash Salts from Germany.*

As stated in my last report, the comparatively cheap rate at which the Stassfurth manure is sold renders field-experiments with these salts very desirable.

Last year the dry season unfortunately spoiled the experiments. I therefore have obtained a fresh and larger supply than last year, and induced several of my friends to test their efficacy in the field.

Most of the experiments were tried under my immediate superintendence, and care taken to avoid mistakes.

Mr. Frere, our editor, also tried some experiments with these salts upon potatoes, and upon clover; but whether it is due to the circumstance that the potash-manure was applied too late in the season, or that the weather was too dry, or that potash was not deficient in the soil on which the experiments were tried, or whether there was any other disturbing influence at work, the

results hitherto obtained have not been such as to encourage the farmer to incur expense. At the same time neither Mr. Frere nor I myself consider these experiments to be conclusive evidence as to the real value of potash-salts as a manure.

These salts were also tried, under my direction, by Mr. James Kimber, of Tubney Warren, Abingdon, Oxon, on mangolds, in a very light sandy soil. Their effect here was very marked; but on the whole not greater than that produced by common salt, which was tried alongside, for the sake of comparison with the potash experiments.

As the crude potash-salts contain a very large amount of common salt, we are left in this case in uncertainty whether potash has had any effect on the increase in the mangold-crop.

Still less decisive, as regards the practical utility of potash, were the results of experiments tried under my directions on swedes, mangolds, and carrots, by Mr. R. Vallentine, Burcott Lodge, Leighton Buzzard.

On the whole, the field-trials this season have left unsettled the question as to the utility of supplying potash artificially to the soil in the shape of these crude salts.

#### *c. Field Experiments on Clover-seeds.*

At my request Mr. Jacob Wilson, of Woodhorn Manor-house, Morpeth, tried again the same experiments which last season (see last year's Report) produced results which in many respects were very interesting and suggestive.

With the exception of a few unaccountable discrepancies, which every one must have noticed who has tried field-experiments, Mr. Wilson's experiments this year accord perfectly well with the results of his last year's field-trials.

Precisely the same manuring agents, on which I experimented on Mr. Jacob Wilson's farm, were applied by Mr. Bigge, Bourton Grange, Wenlock, both to permanent pasture and to one year's seeds, after barley.

As it is impossible to do justice to these field-trials in a short report, I purpose to prepare for a future number of the Journal a paper on Field-trials on Clover-seeds.

#### SUGGESTIONS FOR EXPERIMENTS.

##### *Field Experiments on the Efficacy of Salt and crude Potash-Salts for Roots—Mangold, Swedes, Turnips, and Carrots.*

I would suggest the following experiments for any of these crops with a view to determine the efficacy of crude potash-salts, and of

common salt as additional manures on light soils in good heart. Each plot to be one-twentieth of an acre.

Plot.

1. No salt.			
2. 33 lbs. common salt .. ..	or at the rate of 6 cwt. per acre.		
3. 16½ lbs. crude potash-salts .. ..	"	3	"
4. 16½ lbs. common salt .. ..	"	3	"
5. 5½ lbs. crude potash-salts .. ..	"	1	"
6. No salt.			
7. 11 lbs. common salt .. ..	"	2	"
8. 11 lbs. crude potash-salts .. ..	"	2	"
9. 22 lbs. common salt .. ..	"	4	"
10. 22 lbs. crude potash-salts .. ..	"	4	"
11. 44 lbs. common salt .. ..	"	8	"
12. No salt.			

All the plots should be manured with good stable-dung at the rate of 10 cwts. per acre, and the salt and crude potash be sown beforehand on the manure before it is ploughed in.

The same series of experiments may be tried on 1 acre of ground not manured, and on another acre manured with 3 cwt. of superphosphate of lime.

*Experiments on Salt, crude Potash, and Mineral Phosphates on Potatoes.*

The following experiments are specially recommended for light soils.

Each plot equal to one-twentieth of an acre.

Plot.

1. No manure.			
2. Mineral superphosphates (or dis- solved coprolites) .. ..	} 22 lbs., or at the rate of 4 cwt. per acre.		
3. Good farmyard-manure .. ..		15 cwt.	15 tons per acre.
4. { Mineral superphosphate .. ..	}	22 lbs.	4 cwt. per acre.
		and	
5. { Crude salts of potash .. ..	}	22 lbs.	4 "
6. Crude salts of potash .. ..		22 lbs.	4 "
7. Common salt .. ..		22 lbs.	4 "
8. { Mineral superphosphate .. ..	}	22 lbs.	4 "
		and	
9. { Common salt .. ..	}	22 lbs.	4 "
10. Farmyard-manure .. ..		15 cwt.	15 "
10. No manure.			

The artificials should be sown by hand, quite early in spring, at the time when the stable-dung is put on the land, and the potatoes are planted.

It will be seen that three plots are to be left unmanured, and two are to be manured with a good dressing of common dung. It is very desirable that all these plots, so necessary for the proper

interpretation of the results of experiments, should not be omitted in this series.

### Artificial Grasses.

#### Plots of one-twentieth of an acre.

Plot.		
1.	Nitrate of soda .. .. .	22 lbs.
2.	Sulphate of ammonia .. .. .	22 lbs.
3.	Mineral superphosphate (dissolved coprolites) .. .. .	22 lbs.
4.	Common salt .. .. .	22 lbs.
5.	Nothing.	
6.	Muriate of potash .. .. .	22 lbs.
7.	Sulphate of potash .. .. .	22 lbs.
8.	Sulphate of lime .. .. .	1 cwt.
9.	{ Mineral superphosphate .. .. .	22 lbs.
	{ Nitrate of soda .. .. .	22 lbs.
10.	{ Mineral superphosphate .. .. .	22 lbs.
	{ Muriate of potash .. .. .	22 lbs.
11.	Nothing.	

The manures should be applied not later than the end of February, and the first crop as well as the aftermath be weighed green. The produce of each plot should be weighed directly it is cut.

### Experiments on Permanent Pasture.

#### Each experimental plot to be one-tenth of an acre.

Plot.		
1.	Quicklime .. .. .	10 bushels.
2.	{ Quicklime .. .. .	10 bushels.
	{ and	
	{ Common salt .. .. .	56 lbs.
3.	Fine bonedust .. .. .	1½ cwt.
4.	{ Mineral superphosphate (dissolved coprolites) .. .. .	56 lbs.
	{ and	
	{ Crude potash-salts .. .. .	56 lbs.
5.	No manure.	
6.	Common salt .. .. .	56 lbs.
7.	Peruvian guano .. .. .	56 lbs.
8.	Crude potash-salts .. .. .	56 lbs.
9.	{ Mineral superphosphate (dissolved coprolites) .. .. .	56 lbs.
	{ and	
	{ Peruvian guano .. .. .	56 lbs.
10.	No manure.	

The effect of the manures in the preceding experiments should be observed for at least four successive seasons. The experimental acre should be hurdled off from the rest of the pasture-field, and the whole produce be carried off and weighed every year, and not fed off by stock.

### LECTURES.

During the past season I had the honour of delivering before the members of the Society two lectures:—

1. On Natural Potash Deposits in Germany.
2. On Waters used for Irrigation.

*Unwholesome Drinking-waters.*

Public attention having been directed to the deficient and frequently unwholesome supply of drinking-water, more especially in rural districts, a good many samples were sent to me for examination by members of the Society. Amongst them several were found to be totally unfit for drinking.

As examples of bad water, I may mention two. In one of them I found a considerable quantity of nitrogenous organic matter, and an unusually large amount of oxide of lead, a constituent which occurs but rarely in well-water. An accurate determination gave me nearly one-half grain of oxide of lead in the imperial gallon; and I ascertained that this poisonous oxide occurred in solution partly as bi-carbonate of lead, partly as nitrate of lead. On inquiry I found that the water was naturally very soft, and came from a well situated near a manure-heap, the drainage of which no doubt passed into it in a more or less oxydised condition. It is well known that in soils, more especially porous sandy soils, animal refuse-matter gives rise to the formation of nitrates, which act upon lead. It appears also probable that decomposing animal matters exert a similar injurious effect upon leaden pipes. The unfavourable position of the well in this case fully accounts for the contamination of the water with deleterious animal matter, and the still more poisonous oxide of lead.

The second sample of water, unlike the first, which was slightly discoloured, was perfectly colourless, bright, and, as far as smell and appearance went, quite unobjectionable. On examination, however, it was found to contain an unusually large amount of saline constituents, and amongst these no less than 19 grains of nitrate of potash in the imperial gallon, as will be seen by the subjoined analysis.

An imperial gallon, on evaporation, left 72·05 grains of solid residue (dried at 300° Fahr.), containing,—

	* Grains.
Organic matter .. .. .	1·51
Oxides of iron and alumina, and traces of phosphoric acid ..	1·15
Lime .. .. .	15·12
Magnesia .. .. .	1·75
Sulphuric acid .. .. .	8·51
Chlorine .. .. .	8·30
Nitric acid .. .. .	10·29
Potash, soda and carbonic acid .. .. .	23·47
Soluble silica .. .. .	1·95

---

72·05

These constituents combined together represent the composition of the water as follows:—

	Grains.
Organic matter .. .. .	1.51
Oxides of iron and alumina, and traces of phosphoric acid ..	1.15
Sulphate of lime .. .. .	14.46
Carbonate of magnesia .. .. .	3.78
Carbonate of lime .. .. .	16.37
Chloride of sodium .. .. .	13.67
Nitrate of potash .. .. .	19.24
Soluble silica .. .. .	1.95
	<hr/>
Total residue in the gallon .. .. .	72.13

It is hardly necessary for me to add that such a water is totally unfit for drinking, and bad for all domestic purposes.

#### *Adulterated Linseed-cakes.*

Notwithstanding the repeated exposition of the fraudulent admixture of bran, pollard, rice-dust, and similar cheap mill-refuse to linseed-cake, professedly sold as pure or genuine linseed-cakes, I regret to be compelled to repeat that linseed-cakes are still largely adulterated by unprincipled oil-crushers.

In most cases the adulterating materials are cheap and less nutritious feeding-substances than linseed; but occasionally cupidity and ignorance leads to sophistications which are highly injurious to stock fed upon the adulterated cake. Thus, in one instance, I found a linseed-cake which had a very good appearance, and a nice taste, to be largely adulterated with croton-oil beans, a powerful irritating poison. The cake in question was sent to me for examination, on account of the serious mischief which it had done when it was given even in very small quantities to cattle.

#### ANALYSES.

The number of analyses made for members of the Society during the past season was fully as large as in former years. Soil and water analyses were more numerous, and guano and artificial manures fewer, indicating that the trade in manures is more and more carried on by respectable persons.

#### *Cotton-seed Meal.*

I beg to direct attention to the high-feeding value of crushed cotton-seed, from which a portion of the coarse and indigestible husk is removed by sifting. A sample of such cotton-meal on analysis gave the following results:—

Moisture .. .. .	8.86
Oil .. .. .	29.34
*Albuminous compounds (flesh-forming matters) .. .. .	22.75
Gum, mucilage, and sugar .. .. .	7.58
Woody fibre (cellulose) .. .. .	24.69
Mineral matters .. .. .	6.78
	100.00

\*Containing nitrogen .. .. . 3.64

AUGUSTUS VOELCKER,

11, *Salisbury Square, Fleet Street, E.C.*,  
Dec. 1865.

## XVI.—*Upon the Nature of Diseases in Plants.*

BY BARON LIEBIG.\*

### *Experiments on the Growth of Potatoes.*

SOME plants, as for instance the potato, require an unusually large quantity of alkalies or alkaline earths for their full development. The object proposed in the experiments here described was to discover the relative effects of soils containing these elements in different proportions upon the growth of such a plant.

The experiments were carried on in the Botanic Garden at Munich, under the superintendence of Professor Nägeli and Dr. Zöllner. Three boxes, numbered I., II., III., were filled with coarsely-powdered turf, and sunk in the open ground. Each box was about 5 feet long, 4 feet broad, and  $1\frac{1}{2}$  foot deep, thus containing about 30 cubic feet of turf, of which the weight was about 5 cwts. 77 lbs. Two of these boxes, II. and III. were manured; the third, I., contained natural turf. To the turf in II. was added 863 grammes (= 1 lb. 12 oz.) of phosphate of ammonia, 383 grammes ( $12\frac{1}{2}$  oz.) of sulphate of ammonia, and 378 grammes ( $12\frac{1}{2}$  oz. nearly) of carbonate of ammonia. To the turf in III. was added 600 grammes (1 lb. 3 oz.) of phosphate of soda, 250 grammes ( $\frac{1}{2}$  lb.) of phosphate of potash, 790 grammes (1 lb. 10 oz.) of carbonate of potash, and 500 grammes (about 1 lb.) of gypsum.

These manures were most carefully and intimately mixed with the turf, and their proportions were so chosen that the turf was about half saturated. Hence it was certain that no appreciable quantity of them would be dissolved by watering and carried to such a depth as to be beyond the reach of the roots of the plants.

On the 9th of May 9 potato tubers were set in each box about

\* Translated from a paper communicated to the Journal of the Bavarian Agricultural Society, 1864, p. 52.

8 inches deep; the tubers were nearly of equal weight— $1\frac{1}{4}$  oz. on the average. The turf was not, as in the earlier bean experiments,\* from Schleissheim, but from the moor at Haspelmoor, near Rosenheim, which when employed in other experiments had grown barley exceedingly well, each grain of barley throwing up three or four shoots, which produced full ears and a yield equal to that of a thoroughly good barley soil.

*Analysis of the Haspelmoor Turf.*

100 parts of turf dried in open air contained:—

Water .. .. .	17.26
*Combustible and volatile substances .. .. .	72.15
Ash .. .. .	10.59
	<hr/>
	100.00

\*Containing nitrogen .. .. . 2.46

100 parts of ash consisted of:—

Soda .. .. .	0.22
Potash .. .. .	1.04
Magnesia .. .. .	0.90
Lime .. .. .	10.45
Sesquioxide of iron and alumina .. .. .	21.23
Chlorine .. .. .	0.37
Phosphoric acid .. .. .	2.07
Sulphuric acid .. .. .	1.14
Silica .. .. .	21.18
Sand, clay, carbonic acid, &c. .. .. .	41.40
	<hr/>
	100.00

The turf, on being burnt, gave 10.59 per cent. of ash, and hence each box contained 25.2 kilogrammes ( $\frac{1}{2}$  cwt.) of ash-constituents. Consequently, the turf in the three boxes contained the following constituents in 1000 parts of turf:—

	Box I. In unmixed Turf.	Box II. The same con- stituents as Box I., and in addition:	Box III. The same con- stituents as Box I., with the addition of:
Phosphoric acid .. .. .	2.20	1.96	0.93
Potash .. .. .	1.1	..	2.83
Soda .. .. .	0.23	..	0.44
Lime .. .. .	11.08	..	0.68
Chlorine .. .. .	0.39	..	..
Silicic acid .. .. .	22.45	..	..
Sulphuric acid .. .. .	1.21	0.98	0.98
Magnesia .. .. .	0.95	..	..
Sesquioxide of iron and alumina .. .. .	26.4	..	..
Nitrogen .. .. .		24.6	..
Ammonia .. .. .	..	1.83	..

\* Experiments described in previous transactions of the Agricultural Society of Bavaria.



The growth of the potato-plants varied very much in the three boxes.

In Box I. (pure turf) and Box III., which had received no ammonia, the shoots were visible above ground on the 10th of June. In Box II. they made their first appearance 10 days later.

The growth of the tops in Box III. was much more rapid than in the two others. By the beginning of July the stems in this box were almost twice as strong and tall as those in the other boxes. But towards the end of the period of vegetation the tops in Box. II. (dressed with ammonia) looked fully as luxuriant as those of Box III. The colour of the leaves and stalks of the plants in III. was brighter and of a more yellow green than in the others. On the 3rd of July the plants were earthed up; flowerbuds appeared on the 9th of August in Box II., and in Box III. four days later. Towards the end of September the stalks began to wither, and on the 3rd of October all were taken up. The tubers and tops, on being weighed, gave the following results :—

				<i>Tubers.</i>			
				Box I.	Box II.		Box III.
				Turf alone.	Turf with Ammonia.		Turf without Ammonia.
Grammes .. .. .	2520	3062	7201				
Proportion .. .. .	100	121	285				
Weight of set tubers being	7·6	9·7	21·7				
				<i>Tops.</i>			
				I.	II.	III.	
Grammes .. .. .	1837	3535	2870				
Proportion .. .. .	100	192	156				

At these rates the produce of tubers per acre would have been about—

In Box I., 112 cwt.; II., 136 cwt.; III., 320 cwt.

The constitution of the soil, therefore, in III. was so favourable that it far surpassed that of the best arable land, since, according to the usual data, the maximum yield of such lands seldom exceeds 180 cwts.

The growth, both of tops and tubers, calculated as dry substance, exhibited somewhat altered proportions. The quantity of solid matter and of water in the tops and tubers was as follows :—

				<i>Tops.</i>		<i>Tubers.</i>			
				Solid matter.	Water.	Solid matter.	Water.		
				Grammes.	Grammes.	Grammes.	Grammes.		
I. .. .. .	462·36	1374·64	386·72	2133·45					
II. .. .. .	716·22	2818·78	696·03	2365·07					
III. .. .. .	672·85	2197·15	1427·24	5773·76					
				Per Cent.	Per Cent.	Per Cent.	Per Cent.		
I. .. .. .	25·17	74·83	15·34	84·66					
II. .. .. .	20·53	79·47	22·74	77·26					
III. .. .. .	23·45	76·55	19·82	80·18					

From these figures it would seem that there is a simple law with reference to the quantity of water and of dry vegetable matter in the leaves and in the tubers of the potato-plant, for the confirmation of which further experiments are required.

An inverse relation between the two may be gathered from the above experiments. Whereas in Boxes I., III., the *tubers* were watery, the *tops* of those plants were rich in solid matter; on the other hand, in Box II., the *tops* contained much water, whilst the *tubers* were rich in solid vegetable matter.

It has been mentioned that our turf unmanured formed a good barley-soil (at least, for one crop). The development of the potato-plants, and the yield of tubers, prove that it may be called fruitful for this crop likewise, as the produce amounted to two-thirds of that which would be given by a soil of the best quality under ordinary cultivation. From these facts we gather that the food-materials for the barley and the potato-plants were contained in this turf in such quantity and so distributed that they were sufficient to mature a full crop of barley and a moderate growth of potatoes. The food, however, absorbed by the two kinds of plants was not regularly but irregularly diffused throughout the soil; and hence is immediately explained the influence which the addition of ammonia, phosphoric acid, and sulphuric acid in Box II. exercised upon the increase in the produce of tubers and tops.

To estimate this influence justly it is well to imagine the case of a piece of ordinary arable land, where the plant-food is always unequally distributed. In such a soil, at one place molecules of phosphoric acid, potash, lime, magnesia, silica, &c., will occur in such juxtaposition and proportion that the fibres of the roots of a plant which requires them for its growth can, on arriving at this spot, absorb of them all in appropriate proportion; whilst at another spot in the same ground *all* these elements do not occur, or not in immediate proximity; but here may be phosphate of lime without potash, magnesia, or silica; there again alkalies, alkaline earths, and silica, but no phosphoric acid.

It is clear that on such a soil an increase in the crop would be obtained by the addition of manures of totally opposite characters. If, for example, it were manured by wood-ashes, many spots would receive an excess of potash, which there would be inoperative; but at another place this addition would supply the existing lack, and render effective the phosphoric acid and other elements, which without the potash would be useless. A consequence of this would be an increase of crop. Exactly the same would follow from manuring with phosphates. Whenever phosphoric acid already existed in sufficient quantity in the soil, that which was added would, of course, be unem-

ployed; but where all other necessary elements of food except phosphoric acid were present, there the supply of phosphoric acid would make the others effective. Thus, by using phosphates as manure an increased crop would be obtained.

If, by the use of phosphoric acid in a perfectly homogeneous soil (which, however, does not exist in nature), a larger crop were produced, it would be impossible to gain a similar result by alkalis or alkaline earths: for the beneficial effect of the phosphoric acid would depend on an existing excess of other elements of food *everywhere* in the soil, which, before inactive, would be rendered available by the added acid. To increase in such a field the *inactive* element would clearly not increase the yield.

Our turf-soil contained altogether in each box 277 grammes of potash. A full crop of barley would withdraw from a surface of 1·8 square metres (20 feet) the superficies of our boxes 9 grammes of potash, or about 1-30th of that in our soil.

This amounts to nearly two-thirds of the quantity required to produce a full potato-crop both in tops and tubers. There was just double as much phosphoric acid present in the turf as potash, but *unequally* distributed; as, by increasing the quantity of phosphoric acid, the yield of tubers (as appears by the Tables) was increased 21 per cent, that of tops 92 per cent., over the produce of the unmanured turf.

Again, our soil contained ten times as much lime and about the same quantity of magnesia as of potash. Potato-tops are rich in lime and magnesia, and poor in potash; for in 100 parts by weight of ash they contain 60 parts of alkaline earth and 4 parts of potash. On the other hand, the tubers abound in potash and are poor in alkaline earths, containing in their ash about 86 per cent. of alkalis and soluble alkaline salts, but only 14 per cent. of alkaline earths.

The weights of tops and tubers grown in Boxes I., II.—the one containing, as will be remembered, turf alone, the second turf, with the addition of ammonia and phosphoric acid—were in the following ratios:—

					Tops.			Tubers.
Box I.	..	..	..	..	7·2	..	..	10
Box II.	..	..	..	..	11·0	..	..	10

As from II., 542 grammes more of tubers, and 1698 grammes more of tops were obtained than from I. (pure turf), the *proportionate* increase was:—

					Tubers.			Tops.
Box II.	..	..	..	..	10	..	..	31

The use of phosphoric acid and salts of ammonia as manure had unquestionably brought a certain quantity of lime, magnesia,

and potash into use which previously had been inoperative; the deficiency of potash, however, interfered with a development of tubers proportionate to that increase in tops which was promoted by the abundance of magnesia and lime.

In this way is explained the enormous addition to the yield of tops and the comparatively small increase in the crop of tubers, consequent on the use of the manure.

In Box III., where the turf was manured with alkalis, lime, and phosphoric acid, the quantity of potash increased, and ammonia completely excluded, the growth of the plant was stimulated in a very different direction. Although the turf had received only half as much phosphoric acid as that in Box II., yet the additional potash (although only 3-10ths per cent. of the whole mass of soil) brought about an entirely different proportion in the produce of tubers and tops.

Subtracting the crop of Box III. from that of Box I., the excess is found to be 1038 grammes of tops and 4681 grammes of tubers. The relation between tubers and tops was:—

	Tubers.		Tops.	
On the whole produce	..	10	..	4
On the increase	..	10	..	2

These facts, as well as those supplied by the bean-experiments already mentioned, appear to me to be very instructive with regard to the relative growth (vegetations—*verhältnisse*) of our cultivated plants, their proportionate or disproportionate development, and pave the way for a full understanding of them by-and-by.

Every experiment hitherto directed towards the determination of the influence of special elements of plant-food has been almost without value in consequence of its having been tried on soils of unknown composition; for this, of course, made it exceedingly difficult, if not impossible, to estimate the share taken by the elements already present in the soil in producing the observed results.

I believe that it is only by experiments on the growth of different cultivated plants in *soils* of *known* composition that a precise knowledge can be gained of the influence wrought by the diminution or increase, by the lack or excess, of special fertilisers in the soil upon the total produce, as well as upon special functional developments of the plants, such as their grain or straw, tubers or roots.

It stands to reason, that, if this influence is exactly known, the agriculturist will in future be in a better position to judge of the quality of his soil from the produce of his field,—the relative proportions of corn and straw, of stems and roots which it yields. It will thus become easy for him to select the manure best fitted

to increase his produce in the direction which he considers most advantageous.

The ascertained facts, I think, establish this point: that, in arable land containing the ordinary amount of nitrogen, ammonia may be excluded as manure for potatoes without prejudice to the crop; and that, moreover, in soils rich in potash the addition of phosphates, and in soils poor in potash, but containing a sufficient quantity of phosphoric acid, the addition of wood-ashes is absolutely essential to an increased yield of tubers.

Theory, indeed, would presuppose these conditions in any given case; and these experiments were quite unnecessary to establish the principle that, for obtaining a full crop of potatoes, every element of food of the plant ought to be present in the soil in proper proportion and in sufficient quantity. Their value consists in this,—that by them a definite notion has been obtained of the extent of the influence which the defect or excess of one nutritive substance can exert upon special functional developments; and that without the application of ammonia (that chief element in animal manure) the produce of a field in potato-tubers can be made, under the most favourable relations, to exceed in great degree the largest yield which has hitherto been obtained on the best of soils. Theory alone could never have settled this point.

It appears, therefore, unquestionable from these experiments that a farmer may, in the culture of potatoes, dispense altogether with animal manure, and with great advantage employ in its stead a properly-selected combination of phosphates, wood-ashes, and sulphate of lime.

Although this is significant enough in itself, it, nevertheless, is not the most important result of these experiments. One still more important yet remains.

Of the potatoes grown in the two sorts of soil (Boxes I., II.), where the elements essential to conditions of growth were not present in sufficient quantities or in due proportion, every tuber was attacked by the potato-disease. The eyes first turned black; then, after a few weeks, decomposition set in, which extended from these inwards. This decay only appeared, as has been already observed, in those tubers which were grown in the natural turf, or in that which was dressed with ammonia.

Every one of the tubers, on the other hand, which were grown in the soil dressed with the fixed ash-constituents has remained so far perfectly sound; not a trace appeared in any one of them of what is usually described as the potato-fungus.

It follows incontestably, from these experiments, *that the conditions which favour the normal development of the plants are precisely those which ward off the disease*; and hence, as whatever external harmful influences there might have been acted equally

upon the plants of *each* plot, that the proximate cause of the destructive malady is to be sought for in the soil. Wherever the soil furnishes in sufficient quantity and proper proportions the elements required for the structural development and active working of the plant, then the plant obtains thereby a power of resisting noxious influences from without sufficient entirely to obviate their bad effects.

These facts throw the clearest light upon diseases of plants in general—for instance, upon the so-called vine-disease; and I entertain no doubt whatever that this and the silkworm-disease are explained by a change in the constitution of the soil or by its exhaustion.

Nowhere, in no single spot, has any one yet succeeded by the employment of any of the usual remedies in guarding against a return of the vine-disease. Even where, in the early years, the grape-fungus was dispelled by one dose of sulphur-powder, a fourfold application now fails to save the crop; and it can be distinctly foreseen that in course of time the use of sulphur for this purpose will become perfectly vain.

The foundation of the silkworm-disease is simply this,—that the mulberry-leaves no longer contain in proper quantity and form those constituents which are essential to the healthy growth of the worm: in other words, the ground can no longer fulfil the conditions requisite to supply those elements which are necessary for their production, and which, without renewal, have for centuries been withdrawn from it. The worms fed on these leaves die before spinning their cocoons, and in this way the silk-crop in North Italy has continuously diminished for the last sixteen years.

On travelling in North Italy I found that wherever the grape-disease prevailed, there too the mulberry gave no more silk, but where the silkworm was flourishing the vine-plant was sound.

If the silkworm is fed on leaves taken from trees or shrubs newly planted in places where no similar tree has ever grown, and where the soil is still fully furnished with the food of these plants, it is then quite healthy and produces silk.

It is difficult adequately to represent the magnitude and extent of both these evils in Northern Italy. For the last ten years no wine has been made; yet wine is there as important an article of common consumption as beer is in Germany. As a consequence of the lamentable falling off in the supply of silk, the wealth of Lombardy is disappearing and an impoverishment of the country is setting in. Hundreds of families which once were in comfortable circumstances have been reduced to want. Estates on the Lake of Como, with elegant villas, which formerly commanded an income of 100,000 fr. (4000*l.*) can now find no purchasers at a fifth part of their former value; and the industrious

population, which used to find remunerative employment in the numerous silk-grounds, is now being driven by scarcity to emigrate in crowds.

This is the great secret to be learnt: that man, if he would prolong his existence upon that earth out of which he was formed, and which has supplied him with the most important elements of his frame, must cultivate it aright; for any violation of this great law will, in some way or other, be avenged on his children even to the thousandth generation!\*

XVII.—*Statistics of Live Stock and Dead Meat for Consumption in the Metropolis; with Letter on Arrangements for Meat-Markets.* By ROBERT HERBERT.

NOTWITHSTANDING the ravages of the cattle plague, the metropolitan market was heavily supplied with beasts during the last six months of 1865; whilst in the general quality of the stock there was a decided improvement on the corresponding period in 1864. The Lincolnshire "season," which generally closes in December, was this year prolonged during the whole of January, in which month nearly 6000 beasts, which ought not to have made their appearance until July next, were thence received in a half-fat state. This movement, caused by the anxiety of the graziers to guard against the risk of future heavy losses—is most important and ominous. Obviously the receipts from Lincolnshire will fall off considerably between June and December next, and a considerable rise in prices may be anticipated from this cause alone. The compensation now provided for all losses caused by cattle plague, will no doubt check for the future such wholesale destruction of young stock; whether it will effectually put a stop to it of course depends on the adequacy of the compensation by law provided.

It is very questionable how far our importations from the Continent will keep pace with a large additional demand. It may be readily assumed that the arrivals from Holland, Germany, France, &c., will increase both in number and quality; but we must bear in mind, that apart from our present calamity, the supplies of English stock have been decreasing every year, and becoming less adequate to meet the demand without foreign aid. Moreover, the

\* It is to be regretted that so exceptional a seed-bed as turf cut from off a heath should have been selected for this experiment, since it is nearly as important that the seed-bed should be normal, as that it should be uniform. It could hardly be anticipated that nitrogenous manures would act to advantage when the seed-bed itself was a compost of decaying vegetable matter rather than earth. Inferences as to the artificial supply of nitrogen to the potato-crop when growing on ordinary arable land most assuredly cannot be drawn with safety from this experiment.—P. H. F.

imports of foreign dried and cured provisions have seriously declined during the last twelve months, and prices have, as a consequence, risen enormously. Our American advices give us very little hope of a change in this respect; for in all their leading ports, pork, bacon, hams, &c., are considerably dearer than in England, so as to preclude shipments.

The price of beasts during the six months, has been decidedly easier than in 1864—inferior stock having given way 4*d.*, and prime, 2*d.* per 8 lbs. Middling beasts may be considered about stationary. In December, the market was much depressed, and the prices realised were very unsatisfactory, owing, in a great measure, to the large supplies brought forward.

Scotland forwarded 4512 Scots and crosses in admirable condition; but the supply from Ireland exhibited no improvement whatever, being about 2000 head less than last year. From Lincolnshire, Leicestershire, and Northamptonshire, the receipts are on the decline. In 1862, over 74,000 beasts were reported from those districts; but last season the number did not exceed 52,270 head. The Eastern counties fell off; but, from other parts of England, in consequence of the closing of various local markets, the numbers were a full average. Very few really pure Scots, Devons, or Herefords made their appearance, and we should estimate the proportion of crosses and mongrel breeds to pure stock as three to one.

In the last six months, the supplies of native beasts exhibited in the London market were as under:—

*District Bullock Arrivals.*

Last half of year.	Northern Districts.	Eastern Districts.	Other parts of England.	Scotland.	Ireland.
1860 .. ..	66,140	9500	20,500	1151	7,852
1861 .. ..	71,450	2500	9,700	4586	14,340
1862 .. ..	74,570	5050	19,620	3307	14,820
1863 .. ..	66,510	3850	21,250	3213	11,280
1864 .. ..	60,350	8400	19,400	3625	7,079
1865 .. ..	52,270	1600	20,070	4512	5,011

At one time, in January, this year, the orders issued prohibiting the removal of stock without the range of Charing Cross had at first a most depressing effect, and prices declined considerably, as country buyers refused to purchase; but, eventually, they advanced 4*d.* to 6*d.* per lb., as the supplies from all quarters fell off considerably.

We may safely assume that all kinds of meat will be high in price for some time to come whatever may be the extent of our importations of live stock.

The demand for sheep was very active in the six months, and



prices ruled unusually high, although 890,160 head were brought forward, as against 769,814 head in 1864. The additional number, however, was composed of foreigners, which are still defective in weight, though in their quality there was a marked improvement; most of the Dutch, German, and French sheep were crosses with our South Downs. At one time, the best quality of mutton was worth 7s. per 8 lbs.; whilst the general range was 6s. 8d. In 1864, the quotation did not exceed, 5s. 10d. per 8 lbs. The great abundance of winter food in most countries brought forward the sheep rapidly; and the supply was of really good quality, which yielded rather a large quantity of internal fat. There was a good consumptive inquiry for calves, at steady currencies. Nearly the whole of the supply disposed of in the London market was composed of foreign importations. Pigs were very dear; but the high prices, coupled with the fall in the price of inferior beef, checked consumption considerably. The result was that, at the close of the year, the advance was not supported.

The following return shows the total supplies of stock exhibited in the last six months of 1865:—

	Head.
Beasts .. .. .	181,400
Cows .. .. .	2,177
Sheep and Lambs .. .. .	890,160
Calves .. .. .	21,532
Pigs .. .. .	16,151

The total supplies of stock brought forward in the five previous seasons were:—

*Total Supplies of Stock Exhibited.*

Last half of year.	Beasts.	Cows.	Sheep and Lambs.	Calves.	Pigs.
1860 .. ..	145,420	3015	762,740	15,766	15,470
1861 .. ..	149,750	3187	774,260	12,441	20,116
1862 .. ..	159,450	3148	759,671	12,579	18,220
1863 .. ..	168,232	3127	761,070	14,822	17,550
1864 .. ..	177,944	3221	769,814	17,967	19,306

*Average Prices of Beef and Mutton.*

Per 8 lbs., to sink the Offal.

BEEF.

	1861.	1862.	1863.	1864.	1865.
	s. d.	s. d.	s. d.	s. d.	s. d.
Inferior .. ..	3 0	3 2	3 4	3 6	3 2
Middling .. ..	4 0	4 0	4 2	4 6	4 6
Prime .. ..	5 0	4 10	5 0	5 6	5 4

## MUTTON.

	1861.	1862.	1863.	1864.	1865.
	<i>s. d.</i>	<i>s. d.</i>	<i>s. d.</i>	<i>s. d.</i>	<i>s. d.</i>
Inferior .. ..	3 2	3 8	4 0	4 2	4 6
Middling .. ..	4 6	4 8	5 0	5 2	5 6
Prime .. ..	5 8	5 6	5 10	5 10	6 8

The number of foreign stock imported into London alone was 557,875 head. In the last six months of 1864, the supply was 362,709; hence the increase was 195,266 head. In every item that increase was marked, and the large number of pigs received told materially upon the pork trade. The supplies were shipped from the undermentioned ports:—

*Imports of Foreign Stock into London during the last Six Months of 1865.*

From	Beasts.	Sheep.	Lambs.	Calves.	Pigs.
Aalborg .. ..	63	834	..	..	..
Amsterdam .. ..	..	1,571	..	..	..
Antwerp .. ..	2,431	18,371	653	796	255
Boulogne .. ..	746	6,748	27	6	6,874
Bremen .. ..	5,537	6,297	760	122	493
Cadiz .. ..	1,088	12	..	..	..
Caen .. ..	49	..	..	..	..
Calais .. ..	1	1,104	..	283	728
Carril .. ..	100	..	..	..	..
Christiana .. ..	58	..	..	..	..
Copenhagen .. ..	185	298	..	..	..
Delftzyl .. ..	276	958	..	..	..
Dieppe .. ..	18	..	..	..	..
Dordt .. ..	5,219	13,678	3,009	1,681	1,225
Dunkirk .. ..	253	786	..	31	2,201
Gothenburg .. ..	1,727	1,821	1	24	905
Hamburg .. ..	3,827	69,058	..	3	15,831
Harburg .. ..	..	..	..	..	176
Harlingen .. ..	5,146	37,505	1,172	1,777	10,568
Haire .. ..	..	117	..	..	..
Jersey .. ..	..	314	98	..	..
Königsberg .. ..	4	539	..	..	..
Malins .. ..	14	404	..	..	..
Malino .. ..	33	186	..	3	35
Medlenblik .. ..	1,396	41,402	..	64	14
New Dieppe .. ..	404	2,920	..	31	..
Oporto .. ..	522	..	..	..	..
Ostend .. ..	440	1,821	..	547	3
Rotterdam .. ..	21,568	119,342	12,685	14,161	11,024
Stettin .. ..	..	..	29	..	..
Stockholm .. ..	6	106	..	..	..
Tønning .. ..	36,795	44,489	9,113	6	..
Uddewalla .. ..	298	492	..	..	102
Vigo .. ..	489	13	..	..	..
Wyborg .. ..	77	467	..	..	11
<b>Total .. ..</b>	<b>88,775</b>	<b>371,673</b>	<b>27,547</b>	<b>19,535</b>	<b>50,445</b>

Imports into the United Kingdom in previous Periods.

Last half of year.	Beasts.	Sheep and Lambs.	Calves.	Pigs.
1864 .. ..	76,922	238,121	16,793	30,803
1863 .. ..	61,435	241,209	17,497	18,936
1862 .. ..	57,356	250,140	19,610	17,279
1861 .. ..	59,049	266,249	19,715	25,919
1860 .. ..	59,817	243,804	19,594	21,510

Large as the numbers of stock may appear for the last six months of 1865, a considerable increase may be anticipated in them this year. From the circumstance that great efforts are being made by the Continental breeders to increase the weight of both beasts and sheep by crossing with our best breeds, an improved quality of meat may be safely calculated upon. Singularly enough, whilst disease has carried off large numbers of beasts in this country, the health of the stock abroad has been very good.

Rough fat has changed hands at from 2*s.* 7*d.* down to 2*s.* 4*d.* per 8 lbs. The fall in price may be attributed to the increased quantities on sale.

The supplies of meat on offer in Newgate and Leadenhall were moderately extensive, and the trade, generally, was far from active. Prices, however, were well supported. Beef sold at from 2*s.* 10*d.* to 4*s.* 8*d.*; mutton, 3*s.* 4*d.* to 5*s.* 4*d.*; lamb, 6*s.* to 8*s.*; veal, 4*s.* to 5*s.* 2*d.*; pork, 3*s.* 10*d.* to 5*s.* 4*d.* per 8 lbs. by the carcase.

The public sales of colonial wool held in the metropolis went off freely, at an advance of from 2*d.* to 4*d.* per lb. English qualities, however, were inactive, at about stationary prices. The imports of foreign wool in the last six months fell off as compared with 1864; but there was a considerable increase in the arrivals from our colonies. The supplies from all sources during the four years were as under:—

	Bales.
1862 .. ..	567,668
1863 .. ..	596,326
1864 .. ..	670,907
1865 .. ..	685,634

The prices of English wool at the close of 1864 and 1865 were:—

Fleeces:—	1864.		1865.	
	s. d.	s. d.	s. d.	s. d.
South Down hoggetts .. ..	2 0	to 2 1½	1 9½	to 1 10
Half-bred hoggetts .. ..	2 5	to 2 6	1 11½	to 2 0½
Kent fleeces .. ..	2 2	to 2 2½	1 11½	to 2 0½
South Down ewes and wethers	1 11	to 2 0	1 8½	to 1 9
Leicester ditto .. ..	2 1	to 2 2	1 10½	to 2 0

Sorts:—	1864.				1865.					
	s.	d.	s.	d.	s.	d.	s.	d.		
Clothing picklock .. .. .	2	0	to	2	0½	1	10	to	1	11
Prime and picklock .. .. .	1	10	to	1	10½	1	8	to	1	8½
Choice .. .. .	1	9	to	1	9½	1	7	to	1	7½
Super .. .. .	1	6	to	1	6½	1	6	to	1	6½
Combing:—										
Wether matching .. .. .	2	1½	to	2	2	1	11½	to	2	0
Picklock .. .. .	2	0	to	2	0½	1	8	to	1	9½
Common .. .. .	1	8	to	1	10	1	5	to	1	6
Hog matching .. .. .	2	2	to	2	3	2	0	to	2	0½
Picklock matching .. .. .	2	0	to	2	2	1	8	to	1	9½
Super ditto .. .. .	1	8	to	1	10	1	5	to	1	7

From the great improvement in the woollen trade in this country as well as in France and Belgium, strong prices are expected to be realised for wool during the present year. In our opinion, there is ample room for a steady upward movement in the value of English qualities.

*Arrangements for the Supply of Meat for the Metropolis.*

TO THE EDITOR.

DEAR SIR,—The passing of the measure prohibiting the removal of live stock to London has thrown the whole trade into a state of great confusion. The Metropolitan Cattle Market is still open for the sale of beasts and sheep, as well as calves and pigs, but they are now wholly derived by water-carriage from Scotland and the Continent. Preparations are being made to ship stock from Ireland to London; but from that quarter very little relief can be expected. The various railways are bringing immense quantities of dead meat from different parts of the country, and almost every steamer from the North is heavily laden with carcasses of beef and mutton. The high prices now ruling in London must continue to attract supplies from numerous sources, and I understand that large quantities are about to be shipped from Hamburg; indeed, since the commencement of the year over 200 tons have been reported from that source. All arrivals of live stock by sea are, I may observe, permitted to travel to the cattle market, and are disposed of for immediate slaughter within the radius of four miles from Charing Cross; so that the consumption in London will still be partly met by live animals. Complete isolation may do something towards arresting the prevailing disease; but obviously it would be impossible to keep the present law in force during the summer months.

No additions have been made to the number of dead meat markets in the metropolis; but the City authorities have stopped the traffic through Newgate-street till late in the afternoon to

enable the railway companies' waggons to reach Newgate and Leadenhall. The scene of confusion, however, baffles description. Thousands of tons of meat remain for many hours in the waggons, as the meat salesmen have not sufficient room in their shops for the arrivals, and the process of unloading can only take place after the shops have been partly cleared by the purchasers, many of whom come from very distant parts of the country. There can be no help for this state of things until after the new dead meat markets are formed; so that those who succeed in getting their meat into the market in the early part of the morning will secure the most remunerative prices.

The Scotch and foreign graziers will, if I mistake not, be greatly benefited by the working of the new Act, because the first-class butchers will more readily purchase live animals than dead meat. There is one feature in the trade which remains to be noticed. Not a few of the large butchers in the metropolis have agents in various parts of the country for the purchase of meat, which is conveyed by the railway companies direct to the shops. Some delay has frequently occurred in the delivery, owing to the enormous traffic going on; but my impression is that the new system will be found to work advantageously.

Yours very truly,

ROBERT HERBERT.

4, *Argyle Square, King's Cross, London.*

---

XVIII.—*On the Composition of Orange Globe Mangolds, Bulbs and Tops.* By AUGUSTUS VOELCKER.

IN 1862 I tried some experiments with salt on mangolds, and published the results in Vol. XXV., Part 1, of this Journal.

The soil of the experimental field, a stiffish calcareous clay, containing no sand, though well worked and properly manured, was too heavy and retentive to suit mangolds well; the season also was unfavourable to that crop. Under these adverse circumstances salt produced no decidedly beneficial effect. Subsequently, however, I have shown that by the use of salt a considerable increase was obtained on a light sandy soil.

As we do not possess many complete analyses of mangolds grown in England, I took advantage of the opportunity for ascertaining the composition of roots and tops taken from each of the nine experimental plots. One plot (No. 5) received no salt, the eight others were dressed at the rate of 1 to 8 cwts. of common salt per acre. The produce on an average did not exceed 15 tons of clean roots.

The object I had in view in making the analyses was to ascertain the average composition of mangolds grown on heavy soils and in a bad season, and to determine more especially whether the application of salt in different quantities had any effect on the percentage of sugar. A fair average size mangold was selected for analysis from each plot, and the weight of bulbs and tops found to be as follows:—

Plot.	Salt applied per Acre.		Weight of Bulb.		Weight of Top.		
			lbs.	ozs.	lbs.	ozs.	
No. 1	..	..	1	..	..	1	8
.. 2	..	..	2	..	..	1	4½
.. 3	..	..	3	..	..	1	1
.. 4	..	..	4	..	..	1	8
.. 5	..	..	no salt	..	..	1	2
.. 6	..	..	5	..	..	1	2
.. 7	..	..	6	..	..	1	4
.. 8	..	..	7	..	..	1	0
.. 9	..	..	8	..	..	1	2

In the tops I only determined the proportions of water, mineral matter, nitrogenous compounds, and chloride of sodium in the ash, &c. In the bulbs, the amount of water, sugar, fibre, and pectinous compounds (crude fibre), soluble and insoluble albuminous compounds, and soluble and insoluble mineral substances, was determined in the following manner:—

1. *Determination of Water.*—A whole root was divided longitudinally into two halves. One-half was cut into thin slices, and 2000 grains of these were dried, first in the air, subsequently at a gradual increased temperature, and finally in the water-bath at 212° Fahr., until the substance ceased to lose weight.

The loss in weight represents the amount of water in 2000 parts.

2. *Determination of Ash.*—The dried sliced root was next reduced to a coarse powder, which was well mixed and again dried in the water-bath. A weighed portion of the dried and powdered root was burnt to ashes in a platinum capsule at a very moderate heat.

3. *Determination of Albuminous (Flesh-forming) Matter.*—Another portion of the dried root was reduced into an impalpable powder, of which from 18-20 grains were weighed out for a nitrogen combustion with soda-lime, according to the well-known method of Will and Varentrepp.

Since albuminous or flesh-forming compounds contain on an average 16 per cent. of nitrogen, their amount is arrived at if we multiply by 6¼ the percentage of nitrogen found in the analysis, provided all the nitrogen found in the analysis really exists as albumen, casein, gluten, or a similar albuminous compound.

3. *Determination of Woody Fibre and Pectinous Substances.*—The second half of the mangold was reduced into a homogeneous pulp by grating it on a fine grater. 2000 grains of this pulp were digested with some cold distilled water, and the liquid, containing in solution the sugar and other soluble constituents, after standing upon the pulp for some time, was strained through a piece of fine linen; the pulp left on the linen was washed with distilled water and pressed as much as possible by hand. The pressed and partially-exhausted pulp was returned into a glass beaker and mixed up with a fresh portion of distilled water and treated as before. The process of digestion and washing on linen with distilled water was continued until a drop of the washings on evaporation on a slip of glass left no perceptible residue.

The fibrous insoluble matter left on the linen after drying at  $212^{\circ}$  Fahr., consists principally of cellular or woody fibre, and contains but a small amount of insoluble albuminous compounds, dissoluble pectinous matter, and mineral substances insoluble in water.

4. *Determination of Insoluble Albuminous Substances.*—A portion of the dried crude fibre was burnt with soda-lime, and the amount of nitrogen arrived at was multiplied by  $6\frac{1}{4}$ . The percentage of insoluble albuminous compounds was deduced from the weight of the crude fibre.

5. *Determination of Mineral Substances Insoluble in Water.*—The remainder of the crude dried fibre was reduced to ashes in a platinum capsule, and the amount of ash likewise deduced from the crude fibre.

6. *Determination of Sugar.*—The liquid obtained by digesting the pulped mangold with water, and straining through linen, was evaporated to a thin syrup mixed with washed yeast; this syrup was submitted to the process of fermentation, and the sugar in it converted into alcohol and carbonic acid. As 1 equivalent of sugar yields exactly 2 equivalents of anhydrous alcohol, and 4 equivalents of carbonic acid; the amount either of alcohol or of carbonic acid obtained in the fermentation of a sugary liquid may be used as the basis for calculating the percentage of sugar in such a liquid.

If the fermentation is carried on with due care and in a proper apparatus, the amount of sugar in mangolds and all roots may be determined with great precision by this process.

In the following Table the percentages of water, organic matter, ash, and of nitrogen corresponding to the nitrogenous substances in the roots taken from the 9 different experimental plots are given:—

GENERAL COMPOSITION OF MANGOLDS (Roots) in 1000 parts.

	No. 1.	No. 2.	No. 3.	No. 4.	No. 5.	No. 6.	No. 7.	No. 8.	No. 9.
Water .. .. .	916.50	906.69	894.79	901.34	907.92	900.34	926.50	898.57	897.50
* Organic matter .. .. .	72.83	80.20	93.24	87.68	80.47	85.47	61.65	88.81	90.86
Mineral matter (ash) .. .. .	10.67	13.11	11.97	10.98	11.61	14.19	11.85	12.62	11.64
	1000.00	1000.00	1000.00	1000.00	1000.00	1000.00	1000.00	1000.00	1000.00
* Containing nitrogen .. .. .	1.80	1.95	2.32	1.75	1.92	2.48	1.95	2.60	2.45
Equal to albuminous compounds (flesh-forming matters) .. .. .	11.29	12.18	14.43	10.95	12.01	15.50	12.18	16.24	15.35

N.B. Plot 5 had no salt. In the rest the supply of salt increases with the numbers.



A glance at the preceding Table shows that the proportion of water in the mangolds from the different plots varies from  $89\frac{1}{2}$  to  $92\frac{1}{2}$  per cent., round numbers.

The lowest percentage of water found, that is 89.479, is higher than the average amount of water in a well-matured mangold grown in a warm season and a warm and suitable soil. The highest percentage of water found, that is 92.65 per cent., is as great as that found in spongy or very watery white turnips; in well-matured and sound white turnips the percentage of water seldom exceeds 90 per cent., and in particularly sweet and firm turnips grown on good soils, specially suited for that crop, I have found as little as 89 per cent.

It thus appears that mangolds are sometimes grown in England which, weight for weight, contain less solid feeding than white turnips. The fact is, the mangold-crop does not do well on cold and wet soils, nor in hilly exposed districts, where the summer's temperature is always moderate and frequently so low as to render it unadvisable to venture out in the evening without a top-coat.

Under such circumstances mangolds remain watery and do not ripen properly in the field. This I suspect was the case with the mangolds experimented upon.

In the Table overleaf the composition of the same roots is given in detail.

An inspection of the preceding Table suggests the following observations:—

1. The proportion of sugar in the mangolds from plot No. 7 is unusually small. In this case the large amount of water and comparative large proportion of woody fibre plainly shows the unripe state of the root.

2. This root, notwithstanding its unripe condition, contained quite as much flesh-forming substances and mineral matter as several that were found to be much richer in sugar and contained less water.

There cannot be any doubt that No. 7 was innutritious, and we are presented here with direct evidence of the mistake of estimating the feeding qualities of roots by their percentage of nitrogenous constituents.

3. The smallest amount of nitrogenous substances was found in No. 4, and was associated here with the highest percentage of sugar. Fully one-half of the dry matter in this root consisted of sugar, a constituent which more than any other regulates the relative fattening properties of similar articles of cattle food.

4 With respect to the percentage of sugar in the remaining mangolds, it will be seen that it varied from  $4\frac{1}{2}$  to  $5\frac{1}{2}$  per cent. in round numbers. This is a lower percentage than I have found

DETAILED COMPOSITION OF MANGOLDS (Roots) in 1000 parts.

	No. 1.	No. 2.	No. 3.	No. 4.	No. 5.	No. 6.	No. 7.	No. 8.	No. 9.
Water .. .. .	916.50	906.69	894.79	901.35	907.92	900.34	926.50	898.57	897.50
Sugar .. .. .	44.69	52.46	54.41	56.30	46.64	43.72	23.31	45.66	44.69
* Soluble albuminous compounds .. .. .	10.02	10.05	11.95	9.37	10.08	13.44	10.81	14.12	13.54
† Insoluble albuminous compounds .. .. .	1.27	2.13	2.43	1.58	1.93	2.06	1.37	2.12	1.81
Vegetable fibre and pectinous matters .. .. .	16.85	15.56	24.45	20.43	21.82	26.25	26.16	26.91	30.82
‡ Soluble mineral substances .. .. .	10.14	12.16	10.71	10.15	10.92	12.97	11.85	11.45	11.64
Insoluble mineral substances .. .. .	.53	.95	1.26	.82	.69	1.22		1.17	
	1000.00	1000.00	1000.00	1000.00	1000.00	1000.00	1000.00	1000.00	1000.00
* Containing nitrogen .. .. .	1.60	1.61	1.93	1.50	1.61	2.15	1.73	2.26	2.16
† Containing nitrogen .. .. .	.20	.34	.39	.25	.31	.33	.22	.34	.29
Total nitrogen .. .. .	1.80	1.95	2.32	1.75	1.92	2.48	1.95	2.60	2.45
Equal to albuminous compounds .. .. .	11.29	12.18	14.38	10.95	12.01	15.50	11.68	16.24	15.35
‡ Containing chlorine .. .. .	1.88	2.36	2.68	2.64	2.57	2.85	2.69	2.64	1.82
Equal to chloride of sodium .. .. .	3.09	3.88	4.41	4.35	4.23	4.69	4.43	4.35	2.99

in well-ripened mangolds grown on soils of a character similar to that of the experimental field in good seasons. When grown on deep, light, and warm soils, mangolds are always sweeter than roots from colder and stiffer soils; but as comparatively few exact sugar-determinations in mangolds grown in England have been made as yet, we do not possess the data for determining fairly what is the average amount of sugar in English mangolds. Generally speaking, mangolds cultivated in France, Belgium, and Germany, either as the raw material for the manufacture of sugar, or for feeding purposes, are much richer in sugar than those grown in this country, and this is partly due to the more genial climate of the continent, partly to the fact that our fields are more liberally manured than theirs; for experience has shown that forcing nitrogenous manures, such as guano or sulphate of ammonia, are unfavourable to an abundant production of sugar; and generally speaking heavy crops are poorer in sugar and less nutritious than more moderate and equally well-ripened ones.

5. The proportion of albuminous compounds in the several roots, it will be seen, varies from 7 to  $7\frac{1}{10}$  per cent.; and the variations are more perceptible in the soluble than in the insoluble nitrogenous substances.

6. The percentages of vegetable fibre in the preceding analyses differ greatly in some of the roots. Thus No. 9 contained nearly twice as much as No. 2, although both were equally rich in sugar.

7. In all the roots an appreciable amount of common salt was found. The differences in the relative proportion of salt in the several roots are inconsiderable; for No. 5, not dressed with salt, contained as much chloride of sodium as any other, except No. 6, which contained a trifle more. It does not appear, therefore, that the heavy dressing of salt which had been applied on some plots, increased the percentage of salt.

8. In conclusion, it may be mentioned that no direct connection is perceptible between the amount of salt applied to the different plots and the variations in the composition of the roots, to which attention has been directed.

Mangold-tops occasionally are given to sheep and cattle, and relished by them. Too liberally supplied, they purge, and do more harm than good. Believing analyses of the mangold-tops to be interesting, if not useful, I have incorporated in the last table the results obtained in determining the general composition of the tops from nine different bulbs.

The percentages of water in different mangold-tops, as might have been expected, vary greatly.

In several instances not more than  $6\frac{1}{2}$  to 7 per cent. of the tops was solid matter, and the rest water. It will also be noticed

COMPOSITION OF MANGOLDS TOPS *in 1000 parts.*

	No. 1.	No. 2.	No. 3.	No. 4.	No. 5.	No. 6.	No. 7.	No. 8.	No. 9.
Water .. .. .	934.00	932.00	882.50	921.00	919.00	865.60	914.00	920.00	909.00
* Organic matters .. .. .	46.88	50.49	82.24	58.75	57.34	99.60	64.57	56.81	65.08
† Mineral matter (ash) .. .. .	19.12	17.51	35.26	20.25	23.66	33.80	21.43	23.19	25.92
	1000.00	1000.00	1000.00	1000.00	1000.00	1000.00	1000.00	1000.00	1000.00
* Containing nitrogen .. .. .	1.92	2.43	3.66	2.53	2.53	4.60	2.55	2.25	2.85
Equal to aluminous compounds (desforming matters) .. .. .	11.97	15.18	22.87	15.81	15.81	28.72	15.93	14.06	17.80
† Containing chlorine .. .. .	4.64	5.36	10.27	5.41	6.02	8.16	5.44	6.63	7.01
Equal to chloride of sodium .. .. .	7.64	8.83	16.52	8.91	9.97	13.44	8.95	10.92	11.55

COMPOSITION OF MANGOLD TOPS, DRIED *at 212° Fahr.*

	No. 1.	No. 2.	No. 3.	No. 4.	No. 5.	No. 6.	No. 7.	No. 8.	No. 9.
* Organic matter .. .. .	70.88	74.25	69.99	74.37	70.79	74.67	75.08	71.02	71.52
† Mineral matter (ash) .. .. .	29.12	25.75	30.01	25.63	29.21	25.33	24.92	28.98	28.48
	100.00	100.00	100.00	100.00	100.00	100.00	100.00	100.00	100.00
* Containing nitrogen .. .. .	2.90	3.57	3.11	3.20	3.01	3.44	2.95	2.81	3.13
Equal to aluminous compounds .. .. .	18.12	22.31	19.43	20.01	19.53	21.53	18.50	17.55	19.56
† Containing chlorine .. .. .	7.63	7.88	8.74	6.85	7.43	6.11	6.32	8.28	7.70
Equal to chloride of sodium .. .. .	11.57	12.98	14.06	11.28	12.30	10.07	10.41	13.65	12.69

that of this solid matter a large proportion is mineral matter, which does not contribute much to their feeding properties. On the other hand mangold-leaves, notwithstanding their large proportion of water, are rich in nitrogenous or albuminous compounds, which it is hardly necessary to say give a certain value to the tops.

The differences in the results of the preceding analyses are far less striking, and the analytical figures more comparable with each other, if we take the composition of the tops in a dry state. This has been done in the preceding Table.

We learn from this table that from  $\frac{1}{4}$  to  $\frac{1}{3}$  of the dry matter of mangold-tops consists of mineral substances, amongst which saline constituents preponderate. This very large amount of saline matter goes far to explain the well-known purging properties of mangold-leaves.

Although mangold-tops contain more nitrogenous matter than the bulbs, it cannot be maintained that they are more nutritious than the latter. It is more than probable that the nitrogenous matter occurs in the tops in a less elaborated, and for this reason less assimilable condition than in the roots, and that the tops would not be so fattening as the bulbs, even if they contained less of those saline constituents which have a relaxing effect upon the bowels of sheep or cattle.

The quantities of salt applied to these mangolds varied from 1 to 8 cwts. per acre; but it does not appear that either the composition of the roots or tops on the different plots was much affected by these different quantities of salt used on each plot. Mangold-leaves on No. 5, not dressed with salt, it will be seen, contained as much salt as No. 9, dressed with 8 cwt. per acre.

11, *Salisbury Square, Fleet Street,*  
*July, 1865.*

---

XIX.—*Summary of the Proceedings of the Royal Agricultural Society of England in reference to Agricultural Education.* By S. BENJ. L. DRUCE, Hon. Secretary of the Committee.

At the half-yearly General Meeting of the Society, held on the 9th of December, 1863, Lord Feversham in the chair, Mr. Morton drew attention to the fact that among the ten objects for which the Society was incorporated, one was to take measures for the education of those who depended upon the cultivation of the soil for their support.

“He had been,” he said, “a member of the Society from the time of its formation, but he was not aware that anything had been done by the Society in discharge of its duties in reference to that particular point.” And although he had no doubt that the Society had indirectly promoted the education of the agricultural community by its shows, its discussions, and its Journal; yet with regard to the object (No. 7) in its Charter to which he alluded, the Society had taken no direct steps for the education of the profession; the subject was very briefly discussed, but no resolutions were then passed. At the monthly Council Meeting, however, held on the 2nd of March, 1864, Mr. Holland, M.P., had a notice on the agenda paper for the appointment of an Education Committee, but, in consequence of his being unable to attend, Mr. Acland, M.P., brought the matter before the Council, and the nomination of the Committee was deferred until the 6th of April, when the following—The Earl of Powis, Sir Edward Kerrison, Bart., Sir J. V. B. Johnstone, Bart., M.P., Colonel Kingscote, Mr. Acland, Mr. Barthropp, Mr. Druce, Mr. Holland, M.P., Mr. Wren Hoskyns, Mr. Thompson, M.P., Mr. Owen Wallis, and Professor Wilson, were appointed to consider the measures which ought to be taken “for the improvement of the education of those who depended upon the cultivation of the soil for their support.” On the 20th of the same month (April, 1864), Mr. Holland read a paper on Agricultural Education, with a view, as he said, to open a discussion on the subject. In his lecture he alluded to the rapid advances which all classes, and particularly the middle class, had made in education; and remarked that agriculturists *must* bestir themselves if they wished to hold their own among the rest of their countrymen; he also spoke in the highest terms of the efforts that had been already made by various persons, and particularly by the Rev. Prebendary Brereton, in Devonshire; and after observing that the discussion of that day should in no way interfere with the operations of the Committee appointed to consider the question of education, concluded by stating his views on the subject generally, which were briefly that—1st, following the example set in Devonshire, we ought to do our utmost, not only as a Society, but as members of the agricultural class, to establish a system of public schools throughout the country as opportunity presents itself; 2ndly, that further encouragement ought to be given to the farmer’s son to induce him to reap the advantages to be obtained from this system, showing him that, if he will but exert himself, and bring out the talent that in him lies, he will gain honours and attain a status; and lastly, that provision ought to be made to enable those who have gained such honours

to follow that career up, and to make themselves perfect in their profession by attending institutions where a scientific education is bestowed, or studying practice upon a farm.

Sir E. Kerrison alluded to the new middle-class schools which had been recently formed at Lancing and Hurstpierpoint, and also to another which was then being founded in Suffolk, at which it was proposed to give the boys a good general education for 24*l.* a year. The Rev. Prebendary Brereton gave statistics relating to the Devon County School, at which he stated boys under 13 years were educated for 23*l.* a year, and boys over 13 for 25*l.*

Professor Voelcker and Mr. Coleman agreed in thinking that the utility of a farm in connection with a school had been much overestimated.

All the speakers agreed that the basis of the education of an Englishman, whatever his profession, should be public and liberal, including natural science as well as mathematics.

At the monthly Council Meeting held on the 2nd of November, 1864, Sir E. C. Kerrison, Bart., M.P., President, in the chair, on a motion made by Mr. Holland, M.P., that the Council from time to time appoint public examiners to conduct examinations in practical and scientific agriculture on occasion of any request being made for such examiners and complied with, the expenses to be disbursed by the Society; Mr. Acland moved, and Lord Feversham seconded, the following amendment:—"That it is desirable to obtain further information as to the institutions available for the examination or education of agriculturists before deciding in what way the Council may most effectually take measures for the improvement of the education of those who depend upon the cultivation of the soil for their support;" which amendment was carried by 13 ayes to 6 noes. The following resolution was then proposed by Mr. Acland, seconded by Lord Feversham, and carried unanimously: "That the Committee on Education be instructed to endeavour to obtain such further information, and particularly to inquire into the willingness of existing examining bodies to co-operate with the Society."

At the ensuing monthly Council held on the 7th of December, 1864, Mr. Thompson, M.P., reported that the Committee recommended that authority be given to them to invite examining bodies, such as the Universities of Oxford, Cambridge, and London, the Royal College of Preceptors, the Society of Arts, &c., to appoint one of their members to confer with the Committee. At the Council Meeting held on the 1st of February, 1865, the President in the chair, Mr. Holland, M.P., Chairman

of the Education Committee, stated that the Committee recommended the Council to vote a sum of money to be placed at the disposal of the Committee, to be given in rewards to the successful candidates at the examination, of such kind and to be held at such times and places as should thereafter be determined; and that all candidates for such examination should receive a certificate of nomination from some member of the Society. The Committee reported that the Rev. Professor Rawlinson, the Rev. Dr. Temple, members of the Delegacy for the Local Examination, Oxford; Professor Liveing, one of the Syndics for the Local Examination, Cambridge; Mr. Heywood, M.P., one of the Senate of the University of London; Rev. J. Constable, Royal Agricultural College, Cirencester; Rev. Canon Brereton; Rev. Dr. Jacob Dean, of the College of Preceptors; Mr. Robson, B.A., Secretary of the College of Preceptors, attended the conference on the invitation of the Council. That it appeared that all these bodies were willing to co-operate with the Royal Agricultural Society of England, and that their several examining Boards were disposed to communicate to the Council a report in detail on the attainments of the candidates included in any list forwarded by the Council. A discussion ensued, but finally the Report was adopted, and the names of Earl Fortescue, Lord Walsingham, Mr. Dent, M.P., Mr. Randell, and Mr. Wells, were added to the list of the Committee.

At the monthly Council Meeting held on the 1st of March, in the same year, the Committee again presented a report, which, after a long discussion, was handed back to them for further consideration. It was at this meeting proposed by Col. Challoner, and seconded by Mr. Randell, that instructions should be given to the Committee to consider whether it would not be expedient to establish an examination of candidates as to their practical knowledge of stock and agricultural machinery; which motion was lost by 16 noes to 5 ayes. On the 5th of April, 1865, the Committee again sent in a report to the Council, which report is as follows:—

1. The Committee have revised the Report placed before the Council on the 10th March, and have again taken into consideration the various subjects which were discussed upon that occasion.

2. In consequence of the late period of the year at which this Report has been referred back to them, the Committee cannot recommend any examination in practical agriculture in 1865, and are not prepared to advise the appointment by the Council of a Board of Examiners until a trial has been made of the existing examining bodies.



3. The Committee recommend that a sum not exceeding 100*l.* be given for Society's prizes amongst candidates who have passed the Oxford or Cambridge Senior or Junior Examination.

4. That a sum not exceeding 100*l.* be given for special subjects, enumerated below,\* to candidates at the Oxford and Cambridge Examinations who have passed the Preliminary Examination.

5. That a sum of 100*l.* be left in the hands of the Committee for additional prizes in connection with these examinations, and for expenses attendant thereon.

6. Every candidate shall be recommended by a member of the Royal Agricultural Society of England; and must be a person in some way dependent on the cultivation of the land for his support, or intending to make agriculture his profession.

7. In the choice of special subjects, the Committee being necessarily restricted to those in which candidates are examined at the Oxford and Cambridge Local Examinations, have made their selection with a view to the encouragement of proficiency in such branches of science as are applicable to the study of practical agriculture, and calculated to prepare the mind of the student for the proper reception of that practical education which must ultimately be completed by observation of the working of a farm, and thus enable him to test the value of such theories as may be presented to him.

8. The subjects chosen will be especially useful to machine-makers, manure manufacturers, and others, who, it is hoped, will be attracted to these examinations, though more indirectly dependent upon agriculture for their support than the actual cultivators of the soil.

(Signed) EDWARD HOLLAND, *Chairman.*

To this Report, however, was attached a protest, signed by the Chairman and three other members of the Committee, made for the following reasons:—

1. Because it does not appear to us that the framers of the charter contemplated the Society's dealing with the question of general education.

2. Because we are of opinion that the operations of the Society should be confined to the special object of encouraging efficiency on the part of candidates in practical and scientific agriculture; thereby advancing agriculture as a science, and

---

\* The special subjects referred to in paragraph 4 are,—Mathematics, Mechanics, Chemistry, Zoology, Botany, or Geology.

acting in conformity with its own motto, "Practice with Science."

3. Because it appears to us that the Report recommends a needless expenditure of the Society's funds; as in case no person were permitted to compete for the Society's honours without producing a certificate from one of the existing middle-class examining bodies, testifying that he had passed an examination in the subjects named in the accompanying Report; such certificate, without any distribution of the Society's funds, would be sufficient guarantee that the candidate had acquired the amount of general knowledge requisite for qualifying him to compete for the special honours and rewards offered by the Society.

(Signed)

ED. HOLLAND,  
R. N. F. KINGSCOTE,  
C. RANDELL,  
J. WILSON.

The adoption of the Report having been moved by Lord Walsingham, and seconded by Mr. Thompson, M.P., the following amendment was moved by Mr. Holland, M.P., and seconded by Mr. Lawrence:—

"That this Society is desirous of offering honours and rewards for the purpose of encouraging the special training of young men in the science and practice of agriculture during the interval elapsing between the completion of ordinary education and their entry on their ultimate occupation.

"That for this purpose an examination shall take place in the month of \_\_\_\_\_ for the next three years, of any young persons between the ages of nineteen and twenty-two years, who shall have given one month's previous notice of their desire to offer themselves for examination in practical and scientific agriculture.

"That three examiners shall be annually appointed by the Council to conduct such examination.

"That the distinctions awarded by the Society shall be divided into three classes:—

"1. Any candidate who shall, in the opinion of the examiner, have exhibited the highest qualifications, shall receive the diploma of the Society under its corporate seal.

"2. That any number of candidates, not exceeding six, being the next in order of qualification to those receiving the diploma, shall be presented with a certificate of merit, to be signed by the Chairman on behalf of the Council, and shall be entitled to an exhibition of 20*l.* per annum for three years.

"3. That any number of candidates, not exceeding six, and

being next in succession in order of merit, shall receive a gold medal of the value of 10*l*.

“That the examination in practical agriculture shall comprise all the details of tillage, manuring, feeding, and general management of stock, and the keeping of farm accounts.

“That the examinations in the sciences more immediately connected with agriculture shall comprise the elements of geology, chemistry, botany, mechanics, and vegetable physiology.”

It was stated that this amendment was framed with the hope that the marks of distinction proposed to be conferred, together with the publicity attached to the awards, would have the effect of inducing middle-class schools to devote attention to agricultural education, and to compete with one another in qualifying pupils to become candidates for the Royal Agricultural Society's honours.

A long discussion ensued ; but on the amendment being put, there appeared 10 ayes and 19 noes ; it was therefore lost, and the original Report was afterwards carried by a majority of 18 to 8 ; the names of Mr. Frere and Professor Voelker were now added to the committee.

On the 17th May following the adoption of this Report, Mr. Morton delivered a most able and instructive lecture on the subject of agricultural education, which, as it has already been published *in extenso* in the last number of this Journal, need not here be recapitulated ; suffice it to say that Mr. Morton, without at all disparaging the recent decisions of the Council on this subject, stated his opinion that special agricultural education was intended by the framers of the Society's charter, and was of more value and service to the future farmer than a more general education could possibly be.

During the spring and summer of the past year, after the adoption by the Council of the Report, as above given, the Committee held frequent meetings, and decided that, in consequence of the late period of the year in which the Report was adopted by the Council, no examination could be held in connexion with the Oxford Local Examinations of that year, but that the first trial must be made in connexion with the Cambridge Local Examinations held in December, 1865. On the 16th May they issued the following general prize list, and appropriated a sum not exceeding 130*l*. to prizes, to be awarded in connexion with that examination. The said sum to be apportioned as follows :—

I. To prizes for candidates who obtain certificates, regard being had to their place in the general class-list.

Juniors a sum not exceeding 25*l.* Seniors a sum not exceeding 25*l.*

II. To prizes for candidates who (having passed the Preliminary Examination) are distinguished in any of the following special subjects :—

*Juniors.*

Section 7.—Pure Mathematics.

„ 8.—Mechanics.

„ 9.—Chemistry.

„ 10.\*—(a) Zoology, or (b) Botany.

A sum not exceeding 20*l.*

*Seniors.*

Section E.—Mathematics.

„ F.—Chemistry.

„ G.—1. Zoology, and the elements of Animal Physiology.

2. Botany, and the elements of Vegetable Physiology.

3. Geology, including Physical Geography.†

A sum not exceeding 30*l.*

III. To prizes for candidates who answer papers to be set in mechanics and chemistry, as applied to agriculture, open to juniors and seniors who have passed the Preliminary Examination as above, and also to any young men not exceeding 25 years of age (duly recommended) a sum not exceeding 30*l.*

Thus the Committee carried out Recommendations 3 and 4 of the Report of April 5th, 1865, and by securing the co-operation of the University of Cambridge, were enabled to some extent to meet the wishes of those members who had supported the amendment moved on that occasion by originating special papers on two subjects closely connected with agriculture, which are not only important to the farmer, but afford satisfactory tests of proficiency.

The last Report issued by the Committee on the 6th December last, was as follows :—

The Committee, after the adoption by the Council of the Report placed before them on the 5th April last, at once proceeded to make the intentions of the Society as widely known

\* No student to be examined in more than one of the two divisions (a) and (b).

† No student to be examined in more than one of these three divisions (1), (2), (3).

as possible; and for this purpose sent circular letters to all the Secretaries of the Local Agricultural Societies in England and Wales, drawing their attention to the scheme, and soliciting their assistance. The Committee also sent circular letters to all the schoolmasters whose names were published in the last class-lists of the Oxford and Cambridge Local Examinations; notices were also sent to the principal agricultural newspapers and educational periodicals, and to the local newspapers.

The local Secretaries of the Cambridge Local Examinations were also apprised of the scheme, from whom, as well as from the authorities of the Cambridge University itself, the Committee have received the utmost courtesy and attention. It may be further stated that the Cambridge authorities have consented to take a fee of 10s. instead of 1*l.* from such of the candidates as compete for the Society's extra prizes (List III.) only.

The total number of candidates who entered for the prizes of the Society was 120, drawn from 18 counties of England; of these 83 were under the age of 16, of whom 75 entered for the general Junior Examination; 60 for prizes in pure mathematics; 15 in elementary mechanics; 4 in chemistry; and 1 in botany. There were 27 under the age of 18 who entered for the general Senior Examination, and of these 21 entered for prizes in pure mathematics; 12 in applied mathematics; 2 in chemistry; 2 in zoology; 1 in botany; and 1 in geology. Those only who passed the Preliminary Examination were eligible to obtain a prize in a special subject. In List III., open to candidates not exceeding 25 years of age, 13 entered to compete for one or both of the extra subjects; 6 to compete in mechanics; and 12 in chemistry applied to agriculture. In all these prize-lists many candidates entered in more than one subject. Of the 120 candidates, 104 described themselves as sons of farmers, and others in some way dependent on the cultivation of the land for their support, and the remaining 16 expressed their intention of following agricultural pursuits in after life.

As regards the examination of the candidates for the Society's extra prizes (List III.), the Committee obtained the assistance of Mr. Besant, of St. John's College, Cambridge (Senior Wrangler, 1850), to examine in mechanics applied to agriculture, in conjunction with Mr. Amos, the Society's Consulting Engineer. Mr. Liveing, Professor of Chemistry in the University of Cambridge, and the Society's Consulting Chemist, Professor Voelcker, conducted the examination in chemistry applied to agriculture.

In the following Table the candidates are classed according to their counties, or, rather, according to the counties in which

their last school was situated, their homes being, in some cases, unknown.

County.	Sons of Farmers, <i>bonâ-fide.</i>	Intend to be Farmers, <i>bonâ-fide.</i>	Both Sons of Farmers and intend to be Farmers.
Denbighshire .. .. .	..	..	1
Devon .. .. .	17	2	4
Essex .. .. .	2	..	..
Gloucestershire .. .. .	1	9	..
Lancashire .. .. .	4	..	..
Leicestershire .. .. .	1	..	1
Lincolnshire .. .. .	2	..	..
Middlesex .. .. .	2	1	..
Norfolk .. .. .	6	1	2
Northampton .. .. .	12	..	3
Oxfordshire .. .. .	5	1	..
Staffordshire .. .. .	8	..	1
Suffolk .. .. .	5	..	1
Sussex .. .. .	2	..	..
Wiltshire .. .. .	4	..	1
Yorkshire .. .. .	1	..	..
Total .. .. .	72	14	14

The county from which the greatest number of candidates came is Devonshire, their number being 30, 23 of whom entered for the Cambridge Junior Examination, that is, were under 16 years of age; 6 for the Cambridge Senior Examination, that is, were under 18 years old; and the remaining one is entered for the extra prizes (List III.). Of these 30 candidates, 10 were from the Mansion-house School, Exeter; and 9 (including the one entered in Prize-list III.) from the Devon County School. Northamptonshire sent the next largest number, viz., 16, all of whom came from one school, Abington House, Messrs. Kingstone and Phillips. Of these 16 candidates, 12 were under 16, and 4 under 18. Gloucestershire sent 11 candidates; of these, the greater number, as may be supposed, came from the Royal Agricultural College at Cirencester, and entered for the extra prizes offered by the Society in mechanics and chemistry applied to agriculture. Norfolk and Staffordshire send 10 candidates each, and in both cases 7 are under 16, 3 under 18.

The examination commenced at the various towns appointed by the Cambridge authorities on Monday, the 11th December, and continued during the greater part of the week. The examination of the candidates in the extra subjects (Prize-list III.) took place as simultaneously as could conveniently be arranged at the different towns where the candidates had specified their intentions of being examined. The greater number, however, were examined at Bristol.

The results of the examination having been received from the Cambridge authorities, the Committee met on February the 21st, and, after a long discussion on the merits of the different candidates, agreed on a list of prizes which was submitted to the adjourned Council held that same day, the Duke of Marlborough in the Chair, and was at once approved and adopted.

The names of the several candidates had not been put before the Committee, when they drew up their list and made their Report. That lists in a somewhat modified form in consequence of the insertion of the names of the candidates, is as follows:—

LIST I.—*Prizes to Candidates who obtain Certificates, regard being had to their place in the General Class List.*

SENIORS. 3 in Cambridge First Class.

Name.	School.	Prize.		
		£.	s.	d.
J. Lake .. ..	Alfred Ho. Sc., Bow, Middlesex .. ..	5	0	0
A. Pollard .. ..	Liverpool Institute .. .. ..	5	0	0
A. Shuker .. ..	Brewood Gr. Sc., near Stafford .. ..	5	0	0

5 in Cambridge Second Class.

J. B. Allanson .. ..	Mansion Ho. Sc., Exeter .. .. ..	2	0	0
T. W. Browne .. ..	Brewood Gr. Sc. .. .. ..	2	0	0
S. Churchward .. ..	Prim. Methodist Coll., York .. .. ..	2	0	0
C. J. Langley .. ..	Abington Ho. Sc., Northampton .. ..	2	0	0
W. Waterhouse .. ..	Gr. Sc., Lancaster .. .. ..	2	0	0

JUNIORS. 1 in Cambridge First Class.

*E. A. Shafer .. ..	Clewer Ho. Sc., Windsor .. .. ..	10	0	0
---------------------	----------------------------------	----	---	---

6 in Cambridge Second Class.

R. J. Leeson .. ..	Bracondall, Norwich .. .. ..	5	0	0
G. H. Stuart .. ..	Gr. Sc., March, Cambridge .. .. ..	5	0	0
J. Adams .. ..	Mansion Ho. Sc., Exeter .. .. ..	1	5	0
E. Ashton .. ..	Gr. Sc., Moulton .. .. ..	1	5	0
E. King .. ..	Abington Ho. Sc., Northampton .. ..	1	5	0
A. J. Whitton .. ..	Abington Ho. Sc., Northampton .. ..	1	5	0

LIST II.—*Prizes given to Candidates who, having passed the Preliminary Examination, are distinguished in any of the subjects mentioned in the foregoing Prize List.*

SENIORS.

Name.	School.	Subject.	£.	s.	d.
†S. Churchward	Prim. Method. Coll., York	Pure Mathematics	4	0	0
†C. J. Langley ..	{ Abington Ho. Sc., North- ampton .. .. .. }	Ditto .. .. ..	4	0	0
†S. Churchyard	Prim. Method. Coll., York	Mixed Mathematics	4	0	0
†C. J. Langley ..	{ Abington Ho. Sc., North- ampton .. .. .. }	Ditto .. .. ..	4	0	0

\* Highly Distinguished.

† Those candidates to whose names this mark is prefixed, appear in the special Cambridge list of distinguished candidates.

SENIORS (*continued*).

<i>Name.</i>	<i>School.</i>	<i>Subject.</i>	<i>£.</i>	<i>s.</i>	<i>d.</i>
†F. B. Kingdon ..	R. A. Coll., Cirencester ..	Chemistry .. ..	4	0	0
†A. Pollard ..	Liverpool Institute ..	Ditto .. ..	4	0	0
†F. B. Kingdon ..	.. ..	Botany .. ..	3	0	0
H. T. Bovey ..	{ Montvidere Ho. Sc., Tor- quay .. .. }	Pure Mathematics	1	0	0
T. Pitts .. ..	Ditto .. ..	Ditto .. ..	1	0	0
A. Pollard ..	Liverpool Institute ..	Ditto .. ..	1	0	0

## JUNIORS.

†G. H. Stuart ..	Gr. Sc., March .. ..	Pure Mathematics	4	0	0
†T. Hill .. ..	Gr. Sc., Wolverhampton	Mechanics .. ..	4	0	0
†G. A. Schafer ..	Clewer Ho. Sc. .. ..	Botany .. ..	4	0	0
B. Coaker ..	Mansion Ho. Sc., Exeter	Pure Mathematics	1	0	0
W. Cotton ..	Cowley Sc., near Oxford	Ditto .. ..	1	0	0
T. Hill .. ..	Gr. Sc., Wolverhampton	Ditto .. ..	1	0	0
W. Mortimer ..	Devon County School	Ditto .. ..	1	0	0
E. A. Schafer ..	Clewer Ho. Sc., Windsor	Ditto .. ..	1	0	0
W. H. Warren ..	{ Scholastic Institution, Plymouth .. .. }	Ditto .. ..	1	0	0
W. S. Waymouth	Montvidere Ho. Sc. ..	Ditto .. ..	1	0	0
A. J. Whitton ..	Abington Ho. Sc. .. ..	Ditto .. ..	1	0	0

LIST III.—*Mechanics applied to Agriculture.*

<i>Name.</i>	<i>School.</i>	<i>£.</i>	<i>s.</i>	<i>d.</i>
A. J. Hill .. ..	R. Agr. Coll., Cirencester .. ..	5	0	0
J. S. Krauss .. ..	.. ..	5	0	0
J. Ruffle .. ..	.. ..	1	0	0
J. S. Waldon .. ..	Devon County School .. ..	1	0	0

*Chemistry applied to Agriculture.*

J. S. Krauss .. ..	R. Agr. Coll., Cirencester .. ..	5	0	0
H. Rivington .. ..	.. ..	5	0	0
J. Ruffle .. ..	.. ..	5	0	0
J. A. B. Finza .. ..	.. ..	1	10	0
H. M. Tayler .. ..	.. ..	1	10	0

In all these lists, where prizes of the same value are given to more than one candidate for the same subject, the candidates' names are arranged in alphabetical order, and where the value of the prize does not exceed 2*l.* the prize is to be given in books.

It will be seen from the foregoing list of the names of the successful candidates, that the same candidate in more than one instance obtains more than one prize, in fact Schafer amongst the juniors, and Churchward, Langley, and Pollard, among the seniors, obtain three prizes each. Of the 31 prizemen, it will be interesting to know that 2 are both sons of farmers and declare their intention of being farmers themselves; 21 are the sons of farmers or others connected with the cultivation of the soil, seven intend to be farmers in after life, and one to be an agricultural engineer.



The examination papers set in the two special subjects are appended to this Paper.

Of the 120 candidates one was rejected for copying.

On the whole the examination may be reported to have been a successful one, both as regards the number of candidates, and the way in which the candidates have acquitted themselves.

*Examination Papers set for special Prizes offered for Mechanics and Chemistry applied to Agriculture.*

CAMBRIDGE UNIVERSITY LOCAL EXAMINATIONS.

*Special Examination for Prizes given by the Royal Agricultural Society of England.*

THURSDAY, DEC. 14, 1865. 2 P.M. TO 4 P.M.

MECHANICS.

1. Define the term "centre of gravity," and explain why a heavy body placed on a horizontal plane will not be at rest unless the vertical line through its centre of gravity falls within the figure formed on the horizontal plane by the points or lines of support.

Why is it necessary for a man to lean forwards when carrying a heavy load on his back?

2. Explain the terms "force" and "pressure," and illustrate your explanation by examples. What is meant by the decomposition of a force? Illustrate this by describing the action of the wind in turning a windmill.

3. Define a lever, and describe the different kinds of levers.

State the positions of the power, fulcrum, and weight (or resistance) in the following implements, considered as levers:—1, a crowbar; 2, a shovel; 3, a fork; 4, a scythe; 5, clipping-shears for sheep-shearing; 6, a common hammer when used for drawing out a nail; 7, a chaff-cutter.

4. If two men carry a weight slung from a pole which rests on their shoulders, and if one of the men be stronger than the other, where should the weight be slung?

Would any change be necessary from the circumstance of one man being taller than the other?

A heavy weight lies on the ground, and two ropes of equal lengths are attached to it; two men, of equal size and strength, take hold of the ends of the ropes, and then step backwards in opposite directions, pulling against each other; having given the greatest pulling force which each man can exert, find the greatest height above the ground to which they can raise and at which they can hold up the weight.

5. Explain the nature of friction, and describe its action, 1st, in a man's walking or running; 2nd, in the starting and in the maintaining of the motion of a railway train.

Why does a man who jumps out of a carriage in rapid motion fall

down on reaching the ground? Would he necessarily fall if he were to jump on a very smooth surface?

6. Give instances of the different kinds of wedges. In what way does friction assist the operation of splitting a piece of timber with a wedge?

7. Describe a pulley, and explain the necessity of the sheave in a pulley.

Show that a pulley may be employed to change the direction of a power.

A single moveable pulley is suspended from a beam outside of the window of a loft, the two portions of the rope passing under the pulley being parallel, and the free portion passing over a fixed pulley. A man pulling the free end of the rope, and keeping it horizontal, walks along the floor of the loft, and raises a weight of 200 lbs. through a height of 15 feet; find how far he walks, and the force he exerts. If the weight of the rope be taken into account, state generally how the force exerted by the man will be modified, and whether the rope can be maintained in a horizontal position.

8. Explain the advantage of a wheeled carriage over a sledge. Under what circumstances would a sledge be of greater utility?

Explain also the advantages of high wheels, and describe the utility of a "dished" wheel on a road which is uneven, or in which there are deep ruts.

9. Explain the use of a "fly-wheel" in machinery, showing in general terms that the power of its action depends on both its weight and size.

Having given the rate of rotation and the weight of the tire of the wheel, what would be its tension?

10. A system of pulleys consists of two blocks, the upper one being fixed, and the other moveable; if there are three sheaves in each block, find the power required to lift a weight of 1000 lbs. Show also through what space the power must be exerted in order to raise the weight through 10 feet.

11. Explain the construction and action of an "undershot wheel."

12. Describe, in its simplest form, the construction and action of an ordinary steam-engine.

Describe the construction, action, and exact use of the "governor" of a steam-engine.

---

FRIDAY, DECEMBER 15TH, 1865; 2 P.M. TO 4½ P.M.

#### MECHANICS APPLIED TO AGRICULTURE.

1. A field-gate, 9 feet 6 inches long, is hung by two hooks to a post, which is sunk 3 feet 3 inches into the ground; the bottom hook is 11 inches, and the upper hook 3 feet 7 inches above the ground; the gate weighs 136 lbs., and its centre of gravity is found to be situated 2 feet 8 inches above the ground, and 4 feet from the line of centres of the hooks.

Required the order of lever of the whole combination, position of the points of power, fulcrum and resistance, and the stress in lbs. upon each of those points. Also find the stress in lbs. upon each of the two hooks.

2. A set of "whipple-trees" are so arranged that the "double tree" is 4 feet long, and it requires to be divided in such a manner that it may be suitable for two horses, whose strengths are to each other as 7 is to 5.

Required the position of the hook in the "double tree."

3. The shovel used in some parts of England is formed something like the "ace of spades," and has a long handle, the whole being arranged so that the workman has no occasion to stoop in using it. In these respects the shovel differs from those used in other parts of England, where the cutting edge of such shovels in use is parallel with the ground; and, the handles being short, the workmen have to stoop much in using them.

State your opinion, and the reasons for that opinion, as to which of the two kinds of shovel you consider the best, taking into consideration the various purposes for which shovels are used in the farmer's business.

4. A timber-gin having three horses attached to it is stuck fast in a wood. Each of the three horses is capable of exerting a force equal to 1000 lbs.; but they fail to move the gin. Two of the horses are then removed from the pole, and are hooked by chains to the extreme upper part of the wheels of the gin, one on each side. The horses are now put to work, exerting the same force as before, and are now just enabled to move the gin.

Required the amount of the resistance in lbs. of the gin at that time.

5. There is a common windlass, consisting of a rope, a barrel or axle and handle, placed over a well; the circumference of the rope is 3 inches, the radius of the axle or barrel is 3 inches, the length of the handle is 2 feet, and a power of 50 lbs. is applied to the handle.

Required the weight which would be raised, were there no friction.

6. A threshing-machine is worked by six horses walking in a track 23 feet in diameter. The machinery for giving speed to the "drum," or "beaters," consists of three wheels, *A*, *B*, *C*, which work into and drive three pinions, *E*, *F*, *G*, respectively. The wheel *A* carries 192 teeth, *B* 118 teeth, and *C* 58 teeth; the pinion *E* carries 16 teeth, *F* 13 teeth, and *G* 17 teeth. The wheel *A* makes the same number of revolutions as the horses do, and the pinion *G* is carried by the drum-spindle, rotating 1018 revolutions per minute.

Required the speed at which the horses must travel, in miles per hour, in order that the drum may make the stated number of 1018 revolutions per minute.

7. The drum of a threshing-machine makes 1000 revolutions per minute; its diameter is 22 inches, and the weight of one of its beaters is  $17\frac{1}{2}$  lbs.

Required the force in lbs. necessary to hold the beater in its position on the drum.

8. A waggon and its load weigh together 8960 lbs., the diameter of the "fore wheels" is 4 feet, and of the hinder ones 5 feet, and the whole has to be drawn into a barn over a threshold 3 inches high.

Required the force in lbs. that would be required to draw the fore wheels over, and also the force necessary to draw the hind wheels over the threshold, friction of all kinds being neglected.

9. A waggon 5 feet 6 inches high, weighing  $20\frac{1}{2}$  cwts., is laden with 2 tons of sheaf-corn, the total height being 13 feet from the ground, and the outsides of the tires of the wheels 5 feet apart; the load has shifted, and the centre of gravity is found in a line at 2 feet within the outside of the "near side" wheels, and at a height of 9 feet above the ground.

Required the difference in level of a road or of a hill side when the whole would be in equilibrium and just on the point of upsetting.

10. An endless screw, consisting of a worm-wheel and worm, is applied to an axle or barrel for raising weights, by a rope 3 inches in circumference. The barrel or axle is 6 inches in diameter, the worm-wheel is keyed on the barrel, and has 20 teeth, the worm is single-threaded, and is moved by a handle 20 inches long, to which a power of 50 lbs. is applied.

Required the weight that can be raised by that power, the friction being three-sevenths of the power applied.

11. A cheese-press has a screw 2 inches in diameter, the pitch of which is 1 inch, and the screw is urged to rotate by means of a lever, 5 feet long, with a power equal to 80 lbs. applied to the end of it.

Required the pressure in lbs. on each square inch of the cheese, the diameter of the cheese being 16 inches, and the friction of the press being one-third of the power applied.

12. A non-condensing steam-engine has a cylinder 10 inches in diameter, the length of the stroke is 20 inches, and the number of revolutions of the crank-shaft is 100 per minute. The pressure of the steam in the cylinder is 30 lbs. per square inch, and the resistance caused by friction and back-pressure is 6 lbs. per square inch.

Required the useful effect or force of the engine in horse-power.

13. A steam-boiler, in which the thickness of the plates is three-eighths of an inch, is 4 feet in diameter and the steam-pressure is 50 lbs. per square inch.

Required the strain upon each inch in length, tending to rupture the boiler. Find also the force in lbs. upon a transverse section of 1 inch in length of the boiler, having a tendency to burst it.

14. A beam of Christiana timber, 10 inches deep and 14 inches wide, is laid over a drain 12 feet wide, and found to carry 20,092 lbs. when loaded in the middle.

What load will another beam of similar timber carry, which is 14 inches deep and 10 inches wide, when laid over the 12-foot drain?

FRIDAY, Dec. 15, 1865. 9 A.M. to 11 A.M.

I.—CHEMISTRY APPLIED TO AGRICULTURE.

1. What are the sources of the nitrogen in plants? How is it that the nitrogen which forms the largest part of the atmosphere is not available to plants?

2. Describe the properties of silica. In what parts of plants is it met with, and what purpose does it appear to serve in them?

3. What are the chemical changes which barley undergoes in becoming malt?

4. Explain by reference to the principles of nutrition how the rational use of the following feeding materials is affected by their composition:—linseed-cake, bean-meal, bran, indian corn.

5. State the principal differences between fresh and rotten dung as to (1) composition and (2) efficacy as manure.

6. What is the composition of bones? If I wish to convert 1 cwt. of bone earth into soluble superphosphate, what quantity of sulphuric acid must I employ? State the chemical reaction between these substances and give the calculation for the quantity.

7. Sulphurous acid and chloride of lime are severally used as disinfectants: explain their action.

8. What is the general composition of urine, and what changes do the compounds contained in it severally undergo by keeping?

9. Give an account of the function of the leaves of plants so far as chemical changes in the sap are concerned, and of the influence of light and heat upon this function.

---

FRIDAY, Dec. 15, 1865. 11 A.M. to 1 P.M.

II.—CHEMISTRY APPLIED TO AGRICULTURE.

10. Mention some of the peculiarities of clay land, and explain the principal chemical means of improving it.

11. Describe the advantages which result from deep cultivation, and mention instances in which land should not be ploughed deep.

12. Trace the action of the atmosphere in converting such a mineral as felspar into valuable ingredients of a soil.

13. What are the probable functions of *humus* in the soil?

14. Explain how you can detect whether Peruvian guano is genuine or adulterated.

15. Give a brief description of the mode of analysing a soil, taking the several steps in order.

16. Mention some practical points on which you may obtain definite information from soil-analyses.

17. Can you determine by soil-analyses the relative fertility of different soils? Give reasons.

18. In what states of combination does potash usually occur in soils? How may it be distinguished from soda, and the quantity of it in a mixture of the carbonates be determined?

XX.—*Experiments with Artificial Manure as Top-dressing, used at Wonston Manor Farm, Hants.* By W. J. MORETON POCOCK.

THE experiments which I am about to record will not be open to the objections so often urged against experiments conducted on a small scale, for they each extended over a whole field, and my fields average twenty acres apiece. I left a land undressed in each field, and from this land I cut one-quarter of an acre undressed, for comparison with one-quarter of an acre of the dressed land alongside. These plots were mown separately, carried, thrashed, and weighed separately; and I feel satisfied that the results were accurately obtained. I had many acres dressed with artificial manure for corn, as well as green crop, besides the experimental fields; but these I selected as having been previously managed uniformly, and therefore as less liable to give results that might mislead. I used nitrate of soda, and nitrate of soda, salt, and guano mixed, for wheat, with good effect; I also used 3 cwts. of superphosphate and 3 cwts. of salt with little apparent benefit in some parts of the same field, and great in others. Believing that without straw it is impossible to make manure, and that without manure satisfactory crops, either green or white, cannot be grown, I endeavoured to raise more straw than heretofore on the farm, hoping that the increased corn would repay my outlay, and that the straw would be my profit. I sent a sketch of my plan to my friend Dr. Voelcker for his approval, and his answer—to the effect that he would have suggested the self-same dressings—encouraged me to carry out my intention, in spite of some kindly-meant remonstrances from dependents and neighbours.

My farm is in the midst of the chalk-hills of Hampshire. The soil is poor naturally, though capable of bearing very fair crops when in good condition. Sheep are the mainstay of this district, and without them the land could not be kept in cultivation. The farm is, or rather was, in poor order. The

ANALYSIS OF SURFACE SOIL OF THE EXPERIMENTAL FIELDS.

	No. 1.	No. 2.	No. 3.
Organic matter and water of combination	7·56	8·21	8·07
Oxides of iron and alumina .. .. .	7·90	6·44	12·23
Carbonate of lime .. .. .	32·91	50·83	3·63
Magnesia and alkalies .. .. .	1·11	·85	1·05
Insoluble siliceous matter .. .. .	50·52	33·67	75·02
	100·00	100·00	100·00

rainfall is about 23 inches, and the elevation above the sea some 600 feet. Dr. Voelcker has recently handed to me the preceding analyses of the soils of the three fields referred to.

This is the general composition of the three soils calculated dry.

No. 1 was drilled with barley during the first week in April. Before the drill, with only a good harrowing between, I had sown by Priest and Woolnough's broadcast Manure-drill 2 cwts. of superphosphate (Lawes's mineral), and 1 cwt. of Agricultural salt. This crop followed a very inferior crop of white turnips. Very little difference was apparent between this land and those left unsown with the artificial manures until near harvest, when it came into ear later, and was not ready for the scythe so soon as the rest of the field.

TABLE OF PRODUCE.

	Weight.	Estimated Value.		
$\frac{1}{4}$ of an acre manured as above produced—	lbs.	£.	s.	d.
Good corn .. .. .	372	1	8	0
Tail .. .. .	79	0	3	0
Chaff .. .. .	58	0	0	6
Straw .. .. .	407	0	7	0
Weighing $54\frac{1}{2}$ lbs. per bushel.		1 18 6		
$\frac{1}{4}$ of an acre unmanured produced—		£.	s.	d.
Good corn .. .. .	263	1	0	0
Tail .. .. .	94	0	4	0
Chaff .. .. .	46	0	0	4
Straw .. .. .	332	0	6	0
Weighing $53\frac{1}{4}$ .		1 10 4		

Cost of manure per $\frac{1}{4}$ of acre—	s.	d.
$\frac{1}{2}$ cwt. of Lawes's superphosphate on farm .. .. .	2	9
$\frac{1}{4}$ cwt. agricultural salt .. .. .	0	3
Cost of applying manure per $\frac{1}{4}$ of acre .. .. .	0	3
	<hr/>	
	3	3
	<hr/>	
	s.	d.
Difference in favour of manured plot .. .. .	8	2
Less manure .. .. .	3	3
	<hr/>	
Total net profit per $\frac{1}{4}$ of an acre .. .. .	4	11

No. 2. Drilled with barley in the last week in March: previous to this, 2 cwts. of superphosphate, 2 cwts. of salt, 2 cwts. of

Peruvian guano, was distributed by the broadcast manure-drill before the harrows; the land was in poor order, and I therefore put on an extra dressing. The land was ploughed before winter, and therefore ploughed deeply, which may, in some degree, account for the large amount of carbonate of lime in the surface-soil, as shown in the analysis. Let me remind my Hampshire readers that this, the most deeply-ploughed field, when sown with barley and dressed with artificial manure, produced the best result of the whole of the fields experimented with.

TABLE OF PRODUCE.

	Weight.	Estimated Value.
¼ of an acre manured as above produced—	lbs.	£. s. d.
Good corn .. .. .	473	1 15 0
Tail .. .. .	120	0 7 0
Chaff .. .. .	87	0 1 0
Straw .. .. .	613	0 11 0
Weight per bushel best corn, 54 lbs.		2 14 0
No. 2. Unmanured produce of ¼ of an acre—		£. s. d.
Good corn .. .. .	273	1 0 0
Tail .. .. .	86	0 5 0
Chaff .. .. .	56	0 0 7
Straw .. .. .	375	0 7 6
Weight per bushel 53¼ lbs.		1 13 1
Cost of manure per ¼ of an acre—		s. d.
½ cwt. superphosphate .. .. .		2 9
½ cwt. agricultural salt .. .. .		0 6
½ cwt. Peruvian guano .. .. .		7 0
Application .. .. .		0 3
		10 6
		£. s. d.
Difference in favour of manured plot .. .. .		1 0 11
Deduct cost of manure .. .. .		0 10 6
Total net profit .. .. .		0 10 5

The barley, where no manure was applied, was not ripe so soon as the other by some days, which was remarkable all along for its difference in appearance from the rest of the field.

No. 3. The next experiment with oats contrasts unfavourably with the above results. Perhaps guano in quantity is best applied to a better description of land than mine is. Our climate also tells against its application, I fancy, and the season



of 1864 was unfavourable. I feel certain that the result would have been different had the experiment been carried out in a more northern county. At the same time, having satisfied myself, after some doubts, that the experiment was fairly carried out, I think it only fair to publish the result. I mean, however, to try this again, and if I have a different result to announce I will do so.

No. 3. Canadian oats, drilled in the second week in March: 3 cwt. of Peruvian guano were applied per acre, mixed with 3 cwt. of salt that had been used in the curing of fish. The oats were cut in the last week of July; and all along the result was considered to be so much in favour of the manure that several judges, practical men, put the manured crop at *double* the unmanured portion. The oats unmanured were not fit for the scythe for *one week* after the others were ready.

TABLE OF PRODUCE.

	Weight.	Estimated Value.		
Manured as above $\frac{1}{4}$ acre of the field produced—	lbs.	£.	s.	d.
Good corn .. .. .	439	1	15	6
Tail .. .. .	58	0	3	1
Chaff .. .. .	55	0	0	8
Straw .. .. .	916	0	16	0
		<hr/>		
Weight per bushel 43 lbs.		2	15	3
		<hr/>		
Unmanured $\frac{1}{4}$ of an acre—		£.	s.	d.
Good corn .. .. .	362	1	8	10
Tail .. .. .	68	0	3	9
Chaff .. .. .	39	0	0	6
Straw .. .. .	715	0	12	9
		<hr/>		
Weight per bushel 43 $\frac{3}{4}$ lbs.		2	5	10
		<hr/>		
Cost of manure per $\frac{1}{4}$ of an acre—		s.	d.	
$\frac{3}{4}$ of a cwt. of guano .. .. .		10	0	
$\frac{1}{4}$ of a cwt. of fishery salt .. .. .		1	7	
Application .. .. .		0	3	
		<hr/>		
		11	10	
		<hr/>		
		s.	d.	
Difference in favour of manure .. .. .		9	5	
Loss per $\frac{1}{4}$ acre .. .. .		2	5	
		<hr/>		
		11	10	
		<hr/>		

I have to thank my neighbours, for the very kind interest they took in these experiments, and for superintending the operation of weighing the produce.

On our land, then, it seems that artificial manure is beneficial if properly used, for corn-crops; I may say I have been fully repaid by the quantity of straw I had for use during the last most trying winter, which, when cut up into chaff, enabled me to keep my stock in good condition throughout; it also enabled me to manure more land, so that the object I had in view at the commencement has been fully accomplished.

*Wonston Manor, Hants.*

---

XXI.—*The Cattle-Plague.\** By HOWARD REED.

WHEN the Royal Agricultural Society met last year upon the pleasant heights overlooking Plymouth Sound, no dread of coming calamity disturbed the harmony of the occasion.† The pedigree stock were committed to the railway authorities, with no more than the usual apprehensions for their safety, and after their customary retention were again returned to their pastures to retire with their honours, or be further prepared for subsequent exhibition.

But the propositions of man do not always accord with the dispositions of God.

Had the stock-masters seen the letters passing at this time between the Home Office and the Royal Veterinary College, and connected the information they contained concerning the appearance of a most unwelcome visitor, with records of the past which lay entombed in the British Museum Library, or in musty parish registers, they would have looked with less complacency upon the future. The cloud, then no bigger than a man's hand, has since overspread the heaven of his hope, and cast a gloomy shade over the farm homesteads of Great Britain. Returning from this meeting the exhibitor could scarcely have recrossed the threshold of his home before the Lords in Council issued their first Order, which announced the "recent appearance" of "a contagious or infectious disorder of uncertain nature, prevailing within the metropolis, and in the neighbourhood," and advised measures to be immediately taken "to prevent such disorder from spreading." Within six months from that date anxiety has deepened into despair. Thirty-six out of forty English counties are infected;

---

\* The time has not yet arrived for the treatment of this subject in its entirety. The progress and effects of the disease will be better discussed some time hence. The writer has only ventured upon a sort of interim report, which has been prepared at short notice.

† It is now asserted by Professor Simonds, that during the very week of the show a cow was being treated in Plymouth for rinderpest, though the farrier in attendance did not then know what he had to deal with.

in Scotland, sixteen out of twenty-seven; in Wales, two out of twelve. The depressing totals of the bills of mortality have doubled from month to month, and in the face of so great a calamity Parliament deemed it necessary to suspend its ordinary business that it might defend and arm the country.

The rinderpest was detected in its first appearance towards the end of June in two metropolitan cowhouses by Professor Simonds, and reported to the Home Office on the 10th of July. Having formed a previous acquaintance with this murrain, in its haunts and special breeding grounds,\* Mr. Simonds was well aware of the impending danger, and accordingly sounded an alarm, of which, at first, but faint echoes were heard through the country. This timely proceeding gained for him the title of "Alarmist," with those who were ignorant of domestic events from 1745 to 1757, and unhappily they were many; but the event has proved that his fears were founded on correct knowledge of the subtle and deadly nature of this fever. Before the close of July, Professor Gamgee, in addressing a metropolitan meeting of the troubled cowkeepers, announced that 2000 cows already had perished, though the disease was but a month old. Throughout August the newspapers were pretty fully employed in chronicling its progress through the provinces, for it appeared with a simultaneousness that quite confirmed the views adopted by some superficial advocates of "spontaneous generation." Beyond Middlesex we first heard of it in Surrey, in the Essex Marshes, in Sussex, at Portsmouth and Plymouth, at Aylesbury, in Norfolk, Suffolk, Warwickshire, Kent and North Lancashire, at Leicester, Peterborough and Nottingham, at Edinburgh and Leith. Rayed out from the Metropolitan Market it multiplied its centres of operation, and wrought with a rapidity known only to itself. The veterinary schools set to work to observe and advise. They made *post-mortem* examinations, did their best to establish the identity of the murrain, wherever it appeared, with the rinderpest of Russia, and when they had done so agreed that "to slaughter and to stamp-out" was the only prescription of any avail. Town and country meetings were held in the various districts where the disease appeared, to concert measures of defence. From these sprang Mutual Insurance Associations and Medical Commissions, and other organised operations, the first provincial examples of which were those of Norwich and Aylesbury. Under the pressure of public opinion, medical testimony, and the exigencies of the case, the Privy Council issued no less than five distinct Orders during the month, the last of which empowered

---

\* Mr. Simonds was deputed by the three Agricultural Societies of England Ireland and Scotland to visit Russia and report upon the "Steppe Murrain," which he did in 1856, his Report appearing in this Journal, Vol. xviii., Part ii.

justices to appoint inspectors authorised "to seize and slaughter, or cause to be slaughtered, any animal labouring under such diseases."

But, in spite of this Order, the pest raged with redoubled violence throughout September. The weather was dry, and the atmosphere in a favourable state for the absorption and dispersion of the septic germs. Unfortunately, too, the Order in certain cases increased the mischief it was intended to subdue; for the inspectors being men often singularly unfit for the office, yet unwearied in their efforts to perform the despotic duties attached to it, carried the disease wherever they went, and left it where they did not find it. The fact that men were to submit to the slaughter of their cattle without receiving compensation did much to spread the infection, for where disease appeared the owner felt no compunction about clearing off the greater portion of his stock before hoisting the black flag. Gathering fresh force from every fresh centre, the plague attacked the herds of the West Riding of Yorkshire, cleared 30 of the 200 cowhouses of Edinburgh, increased its hold of Devon, decimated the cattle grazing in the Isle of Ely, leaped upon Derby and Dorset, placed its clammy hand upon Worcestershire, fastened upon the counties of Cumberland, Northumberland and South Wales, and, wherever it had previously gained a vantage ground, improved it. Its ravages amongst the London cowhouses was fearful; it virtually swept and left them tenantless. An instance of no exceptional character may be welcome by way of illustration. The dairy of Mrs. Nicholls consisted of 116 shorthorn cows, which cost 2530*l.*: 100 cows sold at a low figure, realising 536*l.*, and sixteen were carted away and buried, medical advice cost 48*l.* 17*s.*; total loss, 2042*l.*

During the same period the Council consolidated the previous Orders, and prohibited the importation of hides and skins, of sheep, lambs, and all cattle into Ireland, forbade the entrance of cattle into the Metropolitan Market, except for the purposes of being slaughtered, empowered magistrates in Petty Sessions to stop fairs and markets, and published papers containing suggestions on the part of Professor Simonds, and a memorandum on the principles and practice of disinfection by Dr. Thudichum.

At the close of September the Privy Council, finding its efforts to stay the plague unavailing, solicited the Queen to issue a Royal Commission to investigate the origin and nature of the disease, and to frame regulations to check its progress.

Throughout October, during the laborious daily sittings of this Commission,\* the plague continued to extend. By the 14th

---

\* The names of Her Majesty's Commissioners are as follow:—Earl Spencer, G. Lord Cranborne, M.P.; Right Hon. Robert Lowe, M.P.;

of the month it had appeared in twenty-nine counties in England, two in Wales, and sixteen in Scotland. The first Return prepared by the veterinary department of the Privy Council, under the headship of Professor Simonds, showed a gross total of 17,673 animals attacked, of which 848 had recovered, and about 1200 were in a doubtful state; the cases of attack in the second, third, and fourth week numbering respectively 1054, 1729, and 1837. The doctors and the nostrum-mongers were of course busy. Multitudes had a specific, but no one held a cure. The red-hot iron cross with which the cattle were branded on the head in the year 376 seemed, according to Cardinal Baronius, a far more potent remedy than medical science has been able to offer in 1866. The practitioners being ill acquainted with the nature of the disease—and thereby obliged to accept the vague name it now bears—treated it from very various points of view. The results, however, were dismally uniform. Some slight improvement in the rate of recovery was observed, but this has been disputed by those who carefully analysed the returns. Many were the hopes built upon the approach of winter. The cholera bows to a fall of the barometric column. But the chilly autumnal nights destroyed the hope before the winter came. Cold rains and bleak winds imparted a malignant zest to the virus, and the rate of mortality rose correspondingly.

The Report of the Commission, when it appeared in November, brought no relief. It rather increased the alarm, for the evidence on which it was founded confirmed the gloomiest forebodings that had reached the public eye, and pointed out a remedy in slaughter and absolute stoppage of cattle traffic, which the Government, influenced by the milder recommendation of the agricultural section of that body, did not feel warranted to enforce before the meeting of Parliament. They preferred to issue another Order, revoking powers previously given to inspectors, and stimulating local action by conferring more extensive powers on various local authorities. Unhappily this step induced an amount of confusion of which the plague took the most ample advantage; for throughout the months of November, December, and January, our loss doubled every four weeks, and at the close of February it amounted to nearly 12,000 a week.

The following Table (see next page) presents a clear view of the extent of the calamity.

These figures, however, are merely approximate. They represent the facts that came only under the immediate cognisance of

---

Lyon Playfair, C.B.; C. S. Read, M.P.; R. Quain, M.D.; Bence Jones, M.D.; E. A. Parkes, M.D.; Thomas Wormald, President of College of Surgeons; Robert Ceely, Surgeon; Charles Spooner, Principal of Veterinary College, and J. R. McClean, President of Institution of Civil Engineers.

Down to	Total Number Attacked.	Total Number Died.	Total Number Killed.
October 28 ..	17,673	7,912	6,866
November 18 ..	27,432	12,680	8,998
"   25 ..	33,983	16,384	10,061
December 9 ..	47,199	24,513	11,554
"   16 ..	53,386	29,700	12,380
"   30 ..	73,549	41,491	13,931
January 6 ..	82,057	47,192	8,268
"   13 ..	94,256	55,391	10,008
"   20 ..	107,098	63,905	11,831
"   27 ..	120,740	73,750	14,162
February 9 ..	132,183	81,386	17,368
"   17 ..	148,590	92,853	18,247
"   26 ..	166,379	105,497	19,227
March 9 ..	187,059	117,664	26,135

the Veterinary Department of the Privy Council. In hundreds of instances the order to give notice of infection was evaded, and cases occurred of which the inspectors were ignorant. Thousands of animals were, and continued to be slaughtered to be out of the way of attack. Wherever the pest has been announced the district has been immediately cleared of its fat and three-parts fat stock, which have been forced upon a clogged market to fetch what they would. Similarly, as the distance has diminished between the diseased and the healthy, the two-year-old cattle, the yearlings, and the calves, have followed to the same bourne, and left the farmer to wonder by what means the next year's crops of grass and roots are to be consumed. This is a loss of which these Tables give not the slightest indication, and I scarcely know, so far as the intrinsic value of the cattle is concerned, which loss is the greatest, that which appears and that which does not appear.\*

It forms no part of my intention, however, to deal either with the history or the consequences that are likely to attend upon this disease, but to confine myself to the disease itself and its treatment, adding a few words about the local organisations for defence and relief. This undertaking involves great difficulties: the range of inquiry is necessarily extensive, the sources of information are perplexingly numerous—the lights cast from one side and the other conflict and confuse—the ground is broken and to a certain degree untrodden. When so little is known of the object of inquiry, and so much remains to be ascertained, anything like dogmatic assertion will be clearly out of place. I

\* Mr. Herbert estimates that by the end of January upwards of 6,000 store cattle had been thus sacrificed in Lincolnshire alone (see p. 195): whereas the 16th Return of Cattle-Plague Enquiry (up to Feb. 17th) states the total number attacked in that county to be 5,954.

shall simply endeavour to give a clear view of what we already know, for the sake not only of the present inquirer, but also for him who years hence may find ready access to the pages of this Journal, when Orders in Council, Acts of Parliament, and the ephemeral publications of the day, are thrust into a corner and buried beneath the dust.

The great Sydenham, in his celebrated work upon epidemics, advises that the natural history of a new disease should be thoroughly studied and ascertained before any attempt be made to prescribe treatment. This investigation, he says, should be pursued under every possible variety of circumstances until it is classed like the plant, the fossil, and the crystal, or allowed to take the lead of a new line. Before the practical application of this advice, the "plagues," "black-deaths," and "grievous pests" of former times, have either vanished, or assumed a milder form. We entertain but little fear of the Plague now, Small-pox is cheated of its victims by a prophylactic artifice, and Cholera will probably not long retain the secret of its deadly strength.

The same results undoubtedly would have attended the treatment of domesticated animals had those who attend them been possessed of equal advantages and skill. Every effort to substitute for the humble farrier men well trained in the principles of medicine is of more recent date than the formation of the Royal Agricultural Society, and even now, as Mr. Holland's statistics show us, there are only 1018 members of the Royal College in practice in the United Kingdom, whilst the number of those who assume the title of veterinary surgeon, without the right, is 1244, and of those practising as farriers 1109.

It must be confessed that the opportunities afforded to the practitioners for the study of disease are of a very limited character. Except in the case of horses, the poleaxe or the knife are swiftly resorted to when sickness does not yield to a few simple remedies, the observation of morbid appearances being left to the butcher. This is one explanation of the fact that apparently we know no better how to meet the plague now ravaging the country than we did 100 years ago.

Happily, however, the cry for indiscriminate slaughter has not prevented inquiries of a very extensive and important nature being made. The labours of the Medical Committees of London, Edinburgh, and Norwich,\* the experiments that have been

---

\* The following are the gentlemen serving on these several Committees. *London*:—J. B. Sanderson, M.D.; C. Murchison, M.D.; W. Marcet, M.D.; J. S. Bristow, M.D.; Lionel S. Beale, M.D.; George Varnell, M.R.C.V.S.; William Pritchard, M.R.C.V.S.; R. Angus Smith, Ph. D. *Edinburgh*:—Dr. Andrew Wood, Chairman; Professor Dick, V.S.; Dr. Hunter; Dr. Littlejohn, Medical Officer of Health; Professor MacLagen, M.D.; Professor Lyon Playfair; Mr. Romanes, V.S.;

carried on under the observations of Professors Simonds, Spooner, Dick, and Gamgee, as well as to those more private questionings of nature conducted by able men in both branches of the medical profession, have cast much light upon certain paths that will probably lead to the discovery of preventive or curative measures: with the published Reports of their proceedings, and the memoirs and letters that have appeared from many of the private sources referred to, it will be my duty to make the readers of this Journal acquainted.

THE ORIGIN OF THE CATTLE-PLAGUE.—We will first attempt to ascertain the bearings of opinion on this part of the subject.

Professor SIMONDS was, I believe, the first who ventured to affirm that the disorder he was called upon to inspect at Islington, Hackney, and Lambeth, was imported from Russia. He was joined by Professors SPOONER and GAMGEE, who having shown that cows bought at the Metropolitan Market at the same time had introduced the disease to these dairies, seized upon the Revel cargo as the direct means of its communication from Russia to the Metropolitan Market. This explanation, which was generally considered to clear up every doubt as to the origin and nature of the epidemic, is said to have broken down under the analysis of the Commission, though not exactly for the reason assigned by Dr. PLAYFAIR, who, in a treatise on ‘The Cattle-Plague,’ arbitrarily fixes the period of incubation at 8 days (it extends often to 21 days), and then infers that because the cattle were 9 days on the passage, and reached London without visible sign of disease, the disease could not have come in that cargo. Relinquishing this, there is no direct evidence whatever remaining of foreign extract. Where proof is impossible, dogmatism is rampant. Professor SIMONDS asserted that it must have come from Russia. Professor GAMGEE\* publicly announced, “This cattle-plague could no more have spontaneously generated itself in England than the mud in London streets can turn into living creatures.” The veterinary surgeons having been for some time warned to look for its appearance, at once concluded without question that the virus had been imported. There was a general disposition on the part of the public to adopt the same

---

Sir James Simpson, Bart., M.D.; Professor Strangeways, V.S.; J. Wilson, Professor of Agriculture. *Norwich*:—Peter Ede, M.D. (Lond.), M.R.C.P.; Frederick Bateman, M.D.; W. P. Nichols, F.R.C.S.; William Cadge, F.R.C.S.; Thomas Wells, M.R.C.V.S.; William Smith, M.R.C.V.S.

\* ‘Times,’ Sept. 2.—He asserts in his ‘History of the Cattle Plague,’ that “it is entirely *sui generis*, and never originates spontaneously beyond the Russian frontiers,” p. 21. The two German veterinary surgeons deputed to report to their Government on the English plague represent Professor Simonds to have said that though imported in this case, it might have arisen spontaneously from London dairies.



view, which was carefully fostered by the London dairymen, who were anxious about certain unpleasant inquiries into the state of Metropolitan cowhouses. When the Revel story was disposed of, inquiry elicited that Hungarian cattle did introduce the plague to Utrecht, in Holland, last May—that the first beasts found to be afflicted with it in London were newly-bought Dutch cows—and that by this bridge the pest may have passed into England.

Confining my attention solely to the origin of the present outbreak, I do not find it at all impossible to believe that, after all, the Revel cargo did introduce the plague to this country. Possibly, also, it may have come by way of Holland. I should not be at all surprised if the Revel beasts brought the contagion to our cattle, and escaped the consequences of it themselves. The septic germs of disease choose their own time for development. They resemble the seeds of vegetation, which await the arrival of a specific degree of heat, and will not germinate before the minimum be attained. It is so with the miasmata of small-pox, and measles, and scarlatina, which lie dormant for weeks, and months, and years, springing up again under favourable circumstances. Thus the diseases of the mother country are conveyed across the ocean to the colonies, in ships that exhibit clean bills of health. If it be true that cattle passing through a furnace which, let it be remembered, is far less fiery in Russia than in this country, enjoy an immunity ever more, and that cows in calf purchase in the same way an immunity for their progeny, it is not difficult to believe that a cargo rendered thus incombustible could bring fire to our shores without suffering themselves from its consuming effects. Moreover, the body of an animal exposed to the ferment may not be in a state to develop it, but yet coming from a district saturated with contagion may convey it clinging to the hair. Seeing that the rinderpest never dies out in the Steppe country, and that it does die out in other countries to which it occasionally gains access, there is reason in assigning Russia as its natural abode. But it must be remembered that in order to set up a disease two causes are necessary—the existing cause, and the predisposing. It exists permanently in the Steppes, because both these are permanently present. Were both permanently present in England, would it not find a constant abode here?

**SYMPTOMS.**—These divide themselves into *External* and *Internal*.

The *External* symptoms, as stated in the Order in Council of 11th of August, 1865, are as follows:—

“Great depression of the vital powers, frequent shivering, staggering gait, cold extremities, quick and short breathing,

drooping head, reddened eyes, with a discharge from them, and also from the nostrils, of a mucous nature, raw-looking places on the inner side of the lips and roof of the mouth, diarrhœa, or dysenteric purging."

Dr. ANDREW SMART'S minute observations of the phases through which organisms smitten with the plague usually pass, having been gathered from a wide field, are of unusual importance. I extract from his Second Interim Report to the Provost and Magistrates of Edinburgh:—

1. *Period of Incubation.*—All my observations lead me to conclude that it terminates on the seventh day, by the outward manifestations of distinctly recognisable indications. These are:—

2. *The Earliest Recognisable Symptoms.*—They are enumerated as nearly as possible in the order in which they appear. 1. Loss of appetite. This shows itself (1) by an aversion to all sorts of "green food." The next day, or the following, there is (2) indifference to food of any kind. The animal still eats, but languidly; does not lick out the pail, or leaves a portion of the meal, and soon after refuses food altogether. It now ceases to chew the cud, and from this time there is commencing constipation, with progressive diminution of milk. The animal looks depressed, stands much in the same posture, with drooping head and reclining ears. The ears, horns, and other extremities are now sensibly under their natural temperature. The breathing is yet but slightly accelerated, and the expiration perceptibly prolonged, and the pulse rises a few beats in frequency. It is at this period the orifice of the vagina reddens, and the colour deepens as the disease advances. This appearance of the vulva is the most characteristic and reliable mark of the disease at this stage. A faint-red or purple line about the same time appears on the under gum, and along the roots of the teeth. All these symptoms occur within a day or two of the incubation period. The diseased condition of the internal organs after death clearly points to this and the preceding period of the disease as the proper time for successful treatment, before destructive changes have too far advanced.

3. *More advanced Symptoms.*—The breathing is now more accelerated, oppressed, sighing, and laborious. The number of respirations varies generally from 36 to 70 per minute. The pulse is more rapid (from 60 to 110 pulsations per minute), and weaker. There is continued loss of appetite, constipation, and thirst. The superficial membrane of the mouth, especially of the inner side of the under lip, roughens, and a viscid discharge appears in the vagina. A similar eruptive, or roughened appearance, is seen on the membrane of the vagina, where it joins the skin. The milk is scanty, and entirely changed to cream, or there is none at all. All the other symptoms are more decidedly pronounced.

4. *Most advanced symptoms.*—They are those which shortly precede death, and are unattended by any very marked outward signs of pain. The breathing is now slow, very laborious, and moaning or grunting. Pulse slow and small. Where purgatives have not been given, there is great distension of the abdomen, and obstinate constipation. The fluid, and sometimes sanguineous discharges from the bowels, which occur in some cases, are the results generally of the too frequent use of irritant drugs. The superficial membrane of the mouth peels off from the gums and lips, leaving the surface raw; and frequently, but not invariably, there is a viscid discharge from the eyes, nostrils, and vagina.

In pure and uncomplicated examples of rinderpest there is no cough.

The MEDICAL COMMITTEE of the NORFOLK CATTLE-PLAGUE ASSOCIATION note the symptoms of the cattle-plague under three heads,—early, confirmed, advanced. The first and third agree with the above. The second mentions the circulation ranging from 80 to 100, the respiration from 35 to 70, “and an irruption of spots, papules or vesicles on the skin.” They observe that the disease endures from four to six days after it is “confirmed,” and that the period of incubation, when the disease is the result of *infection*, varies from seven to twenty-one days, and of *inoculation* from four to eight days.

To these evidences have been added others. For that which is discovered by thermometric observation we are indebted to the valuable experiments conducted by Professor GAMGEE and his brother, Dr. ARTHUR GAMGEE. On passing a delicate thermometer into the rectum it was found that where incubation had commenced an elevation of temperature will indicate its presence some time before the eye can detect any of those symptoms generally looked for. The normal temperature was found to vary from  $100^{\circ}$  to  $101^{\circ}$  Fahr., and sometimes to rise as high as  $102^{\circ}$ . Putting the test into practice, they were enabled to predict with fatal precision the occurrence of impending attack at a time when the owner of the cattle deemed himself secure. Where the temperature was raised to  $105^{\circ}$ ,  $106^{\circ}$ , and  $107^{\circ}$ , they were certain, as experience proved, of the result. The value of this symptom will be appreciated by all who believe that it is only in the first stage of incubation that this disease can be successfully combated. As the pulse increases the temperature decreases; and before death a sudden drop takes place, often from  $106^{\circ}$  to below  $100^{\circ}$ .

Dr. GANT and others pointed very early to the advantages to be expected from careful systematic examinations with the microscope, and by chemical analysis of the blood, the breath, and excreta of diseased animals during the various stages of the malady. Such observations have been pursued by Drs. Beale and Marcet, at the instance of the Royal Commission. Although their Report is not yet published, we are not without information on these points which can scarcely fail to throw light upon the subject under consideration.

Dr. ARTHUR GAMGEE has pursued a series of experiments, which are quoted by Dr. SMART, and his brother in the ‘Veterinarian.’ An abstract of the results will serve our present purpose. These, as they relate to the *blood*, are as follow:—1. The water of the blood is diminished. 2. The solids of serum diminished. 3. Blood corpuscles increased. 4. Fibrine increased. 5. Proper salts (so far as yet determined) diminished. Examples:

The blood of a healthy calf contained 4.53 parts of fibrine in 1000 parts, and 89.69 parts of corpuscles in 1000 parts.

*The blood of the same animal after the induction of the disease by inoculation.*—The fibrine rose to 4.85 parts per 1000, and the blood corpuscles to 117.7 per 1000. The induced disease in this case was *slight*. The fibrine in a bad case, just before the animal's death, amounted to 9.9 per 1000 parts.

	1. September 17.	2. September 26.	3. November 4.
Calf in perfect health. Immediately after being bled was inoculated with tears of sick cow.		Calf very ill. Pulse 60°, temp. 108°. Does not eat. Great discharge from nose and eyes. Redness of vulva. Diarrhoea.	Calf now in perfect health again. Recovery has been very slow and tedious.
Density of defibrinated blood ..	1050.1	1048.9	1044.6
Water in 1000 parts of blood ..	835.48	820.68	847.75±
Corpuscles .. .. .	89.69	117.70	74.186
Fibrine .. .. .	4.53	4.85	4.83
Solid matters of serum .. ..	70.30	56.77	73.23
Water in 1000 parts of serum ..	922.39	930.82	921.41
Solids .. .. .	77.61	69.18	78.59

The above Table shows the results of three separate analyses of the blood of the same calf—healthy, diseased, and restored. The other analyses exhibit precisely the same changes, though varying in such degree as we are led to expect from the tabulated labours of ANDRAL, GAVARRET, and DELAFOND, who have examined with great care the changes that occur in the blood of domestic animals during the presence of disease\*.

The conclusions arrived at by Dr. GAMGEE would be of more importance were they drawn from a wider field. He has made but eight analyses: it will, therefore, be a matter of interest to see how far his views are confirmed by others who have been at work in the laboratory.

In *milk* he finds that the changes in its constitution are uniform and marked:—1st. The amount of sugar of milk is remarkably diminished. 2nd. The amount of butter is (except

\* Subjoined is the result of the analysis of the blood of 14 healthy neat cattle.

	Fibrin.	Blood Corpuscles.	Solids of Serum.	Water.
Mean .. .. .	3.7	99.7	86.3	810.3
Maximum .. .. .	4.4	117.1	93.6	824.9
Minimum .. .. .	3.0	85.1	82.9	799.0

perhaps at the commencement) enormously increased. 3rd. The salts are slightly increased. 4th. The casein appears to be generally increased.

The same experimenter, making analyses of urine, discovered the colouring matter present in three cases; in one the bile acids—leucine and tyrosine—being nowhere found. In the majority of cases urea, by percentage analysis, was not diminished, and varied from 1.75 to 2.3 per cent.

Dr. SMART remarks upon the difference in the respective densities of healthy and poisoned blood. The temperature in both cases is the same—91° Fahr.; but the specific gravity of corrupted blood is 59°, that of healthy blood 52°. The microscope invariably discovers an excess in the numerical proportion of white corpuscles to the red, as compared with health; while in the case of *milk* it exhibits a consistence exclusively of fatty cells, crowded together and overlying one another.

In a recent number of the 'Homœopathic Review,' Dr. WILSON described certain phenomena which he had remarked by *auscultation* to exist in animals exhibiting none of the characteristic marks of the disease, but in which these characteristic marks were subsequently fully developed. Dr. TRIPE, in his evidence before the Cattle-Plague Commissioners, confirms this observation of Dr. WILSON'S. He says, "By auscultation of the lungs and careful examination of the animal, the disease may be detected in a very early stage. I may state that I have auscultated several cows, and found certain alterations in the breathing sounds in each indicative of approaching congestion of the lungs, before the running from the nose and eyes commenced."—(Question 2729.)

Let us now return to the less obscure evidence of the inroads of disease.

Professor GANGEES'S diagnosis agrees, with few exceptions, with those already quoted. He differs from Dr. Smart, whose experience leads him to consider "a short husky cough" to be often a symptom of pure rinderpest. He also directs particular attention to the striking restlessness of the animal. He observes, too, "that animals may become quite convalescent about the third day, but still the gastric or intestinal lesions may advance; and when least expected, a fortnight or three weeks after marked improvement, alarming symptoms may supervene, severe diarrhœa occur with the return of the other discharges, and death soon follow." The symptoms when cattle-plague is coupled with pleuro-pneumonia Professor Gangee has remarked to be more laboured breathing—greater prostration. The short grunt of lung-disease begins early, and spasmodic action of the nostrils is perceptible. The symptoms where foot-and-mouth-disease is coupled with the cattle-plague are lameness and morbid condi-

tion of the feet, eruption of the teats, and tendency to congestion and inflammation of the udder. Amongst English writers there is a pretty general agreement as to these external symptoms of the plague in cattle.

*In Sheep.*—The symptoms, as observed by the NORWICH COMMITTEE, are dulness and indisposition to eat or ruminate, the circulation and respiration being increased. In the second stage all the visible mucous linings are congested, rumination has ceased, there is a ropy discharge from the mouth and nostrils, with excoriations inside the lips and gums. In the third stage all these symptoms are increased, and accompanied by great prostration of strength and bad breath. After contact with diseased oxen, fourteen days elapse before the fruit of the contact appears; but when inoculated from the ox the disease has been produced in six days. In 1857 Dr. KREUTZER first described the symptoms of the cattle-plague as observed in a sheep which had been inoculated on the 1st October. The period of incubation lasted till the 9th, and was followed by general disturbance, discharge from eyes and nose, prostration, moaning, and diarrhœa. Death ensued on the 19th. Dr. MARESCH, who observed the disease in sheep carefully from 1860 to 1863, states that the period of incubation extends usually from seven to eight days. A violent case terminates on the fourth, fifth, or sixth day; but it is usual for convalescence to set in and be confirmed in ten to fourteen days.

Mr. GAMGEE describes the symptoms in the *buffalo*: “in general the febrile symptoms, discharges from the eyes and nose, erosions on the gums and lips, marked cutaneous eruption on the udders of the females and the rudimentary mammæ of the males, together with diarrhœa, are not severe, nor is the disease deadly.” The crisis is attained about the seventh day, after which the animal usually recovers; but in severe cases death ensues about the fourth or fifth day.

Respecting these external symptoms of the plague in cattle our living writers are generally agreed. In order to identify the present with former attacks, and with the same disease in Russia, it will be necessary to give one or two quotations. Professor SEIFMAN, of Warsaw, observes:—

“The beast eats little, stops its rumination, becomes nervous; the mucous membrane, gums, mouth, &c., throw out pimples; there is a running at the eyes and nose, and this running after a time gives out an offensive smell; an offensive diarrhœa ensues, the beast coughs, becomes thinner, sometimes grinds its teeth, lays down its head at one side, and dies without effort.”

LAYARD, in his Essay ‘On the contagious distemper among Horned Cattle, anno 1757,’ p. 54, says:—

“The first appearance of this infection is a decrease of appetite; a poking out of the neck, implying some difficulty in deglutition; a shaking of the head

as if the ears were tickled; a hanging down of the ears; a dulness of the eyes. After that a stupidity and unwillingness to move, great debility, total loss of appetite, a running at the eyes and nose. . . . A constant diarrhoea, roofs of their mouths and barbs ulcerated. They groan much, are worse in the evening, and mostly lie down.

No one who consults the works of LAYARD and FLEMING can entertain more hesitation about the identity existing between the visitations of 1865 and 1744-57, than they did between that of 1744-57, witnessed by themselves, and that of 1711-14, observed and described by RAMMAZZINI, LANCISI, and LANZONI. It is worthy of remark that all these writers draw particular attention to the *pustular* character of the disease. LAYARD, in a letter to Sir Joseph Banks in 1780, says: "It is an eruptive fever of the variolus kind, and, though the pustules may have been frequently overlooked, yet none ever recovered without more or less eruptions or critical abscesses. . . . Unlike other pestilential, putrid, or malignant fevers, it bears all the characteristic symptoms, progress, crises, and event of the small-pox."

*Internal Symptoms.*—In the first place we will glance at the chief of these manifestations, as observed by the NORFOLK MEDICAL COMMITTEE:—

"In its general appearance the flesh is much darkened in colour, decomposition proceeds rapidly, and a most characteristic smell is evolved from the abdominal viscera. The blood, which is dark, quickly and firmly coagulates. The larynx, trachea, and bronchial tubes, generally free from mucous, occasionally exhibit a few red spots. In *sheep* the lining membrane of the whole respiratory tract is frequently of a gangrenous greenish-black hue. The lungs of *oxen*, generally healthy, exude dark blood when cut. In *sheep* they are always congested and red mottled throughout; in lambs most so. The heart contains clots of black blood in both ventricles. The 1st stomach is always crammed with food, and the mucous membrane beneath its epithelial lining is frequently studded with minute red papillary points. The second stomach is usually healthy. The third sometimes moist, and its epithelium readily peeling or scraping off; sometimes the converse. In the former case the mucous membrane beneath is generally reddened with dark spots pervading a surface of fainter red. The 4th stomach, nearly always empty, the large vessels on its exterior generally full; the surface studded with dull red or bluish spots, or large portions of a deeper red, with here and there spots or patches of a still darker hue, either elevated above the surface or appearing like ecchymoses beneath the mucous membrane, giving the surface a resemblance to plum-pudding.' The epithelium is often gone in spots, leaving depressions which are rather abrasions than ulcerations of the membrane. In *sheep* these stomachs are occasionally found quite healthy, excepting a muddy appearance in the 3rd. This viscus, however, has frequently a dark gangrenous appearance. The small intestines are always empty and usually patched with red, and congested here and there. The duodenum is affected most constantly and to the greatest degree, and not unfrequently shows a papillated condition of the reddened surface. Small sebaceous tumours are often present. Peyer's patches are never found thickened or ulcerated, but are sometimes seen covered with a layer of discoloured and softened mucous membrane. In *sheep* the resemblance in these respects is complete, and the bowels, like the stomachs, are occasionally found pale and nearly healthy throughout. The large intes-

lines are not very noticeably marked, save that the colon, in place of a red blush, is traversed with broad lines of a blackish-green colour, longitudinal and transverse. In oxen the *spleen* usually healthy, in *sheep* soft, and sometimes almost black in colour. In like manner the kidneys of oxen are healthy and of *sheep* are not infrequently soft and pulpy. The udders of milch-cows are empty. The skin frequently shows what appear to be true vesicles, most abundant behind the shoulders, but not confined to these parts, and presenting every appearance of a true cutaneous eruption."

Dr. SMART has made a most valuable contribution to our knowledge of this disease by tabulating the morbid lesions in the organs of more than 100 diseased cows. He has made his inquiry comparative, also, by dissecting pleuro-pneumonia and foot-and-mouth-disease cases, and placing the results obtained from these side by side with those of true uncomplicated cattle-plague. This summary of pathological appearances is here fully given:—

*Invariable but not Characteristic.*—1. The state of the bowel resembles the condition found in the ordinary inflammation of the bowels. 2. The condition of the lining membranes of the bladder and uterus is such as occurs in all congested states of these organs. 3. The central portions of the kidneys present the congestive condition found in the early inflammatory stages of these organs. 4. The heart, liver, and spleen may be regarded as functionally healthy. They are in the condition which results from exhausting disease of any kind, and the lining membranes of the air-passages exhibit the morbid changes which are present in acute bronchial catarrh. 5. The remarkable and unique gangrenous rings or patches, found on the folds of the third stomach, exist in only a portion of all the cases examined: they are therefore neither invariable nor characteristic marks of the disease."

*Invariable and Characteristic.*—1st. The peculiar appearance and diseased condition of the lining membrane of the fourth stomach. It likewise manifests all the morbid changes so distinctive of this disease, in their most advanced and destructive forms. It is therefore the most characteristic lesion. 2nd. The reddened and congested condition of the vulva. 3rd. When eruption or roughening on parts of the superficial membrane of the mouth is found co-existing with the condition of the bowel already described, the pathological group is complete and unequivocal. As regards negative conditions, there exists no true understanding anywhere, and rarely any trace of inflammatory products are found. The reddened colour of the diseased membranes is due to vascular congestion in its extreme form, and not, as frequently alleged, to extravasations."

*Of the Comparative Pathological Appearances, Dr. SMART says:—*

"With the exception of a partial reddening of the lining membrane of the fourth stomach, the pathological appearances in murrain disease bear no other resemblance to those found in rinderpest. In examples of uncomplicated pleuro-pneumonia, the characteristic appearances of both rinderpest and murrain are quite absent."

*Complication.*—Dr. SMART says that two-thirds of the animals dissected (mainly Edinburgh dairy-cows) were affected with pleuro-pneumonia, which he represents as the most dangerous and frequent form of complication of cattle-plague.



*The Condition of the Skin*, in the proportion of one-third, nearly, of the cases treated by Dr. SMART, was such that an eruption appeared generally diffused, but most abundantly on the flanks. The eruption, as seen on the udder, had a vesicular character; and the date of its appearance was probably between the 5th and 7th day. Dr. BRISTOW writes of the eruption accompanying cattle-plague:—"I have never yet seen a vesicle. I have never yet seen a pustule. I have never yet seen that destruction of the surface of the skin which in small-pox leads to pitting." Mr. A. B. SQUIRE, M.B., says, in the letter-press that accompanies his exquisitely-executed coloured photographs of skin-diseases:—"It has been a matter of debate whether the so-called pustules of the disease are really deserving of the name. This question, I think, may be decided by the scabs, since scabs presenting the characters here represented (the size and thickness of a split pea) can, if we may argue from human pathology, originate only in *pustules* of corresponding size." Dr. CHARLES MURCHISON, in his letter to the 'Lancet,' in September, quite confirms Mr. Squire's view by several striking cases.

On that material point of *ulceration*, Dr. SMART affirms:—"The whole mucous lining of the bowels is unduly soft, and its epithelium imperfect. There are no true ulcerations, and in this respect its condition differs broadly from the ulcerated typhoid in man. . . . The mesenteric glands show no lesion of structure."

This view I find to be supported by Mr. POPE, M.R.C.S., of York, whose experience has been scarcely less extensive. Dr. MURCHISON, who is of an opposite opinion, is sustained by Professor RÖLL ('Lehrbuch,' pp. 349-50), Dr. GANT, Professors SIMONDS and GAMGEE. Dr. WM. BUDD argues also energetically in the same direction. Looking at the tendency of Dr. BRAUPELL'S microscopic researches, it would almost appear that what by the naked eye have been taken for pus-globules, are in reality that exuberant growth of cells which is typical of this disease. If so, the typhoid theory founded on the presence of ulceration is somewhat shaken.

Professor SIMONDS, communicating the results of his practical acquaintance with the rinderpest in the Steppes to the Royal Agricultural Society of England, in 1857, says:—"The rumen and reticulum (first and second stomachs) are healthy in most cases. In some few instances the epithelium readily peels from off their inner surfaces, when the vessels beneath are found to be turgid with blood. The rumen invariably contains a fair quantity of ingesta in the state usually met with in healthy animals. The omasum (third) is without structural change, or, at most, resembles the first and second. Its contents are frequently so dry and hard that they can be rubbed to powder between the

fingers. The mucous membrane of the abomasum (fourth) is always highly congested, more especially towards the pylorus." The patches not mentioned. "Peyer's glands are not invariably diseased, but, like other follicular openings of the digestive canal, they are often covered with layers of lymph, beneath which ulceration is occasionally observed. . . . The chief ravages of the disease, as we have met with them, are in the large intestines. The blind end of the colon—the cœcum—was, in one case in particular, ulcerated over several inches of its inner surface. . . . Their deposits of lymph, varying in size from that of a pea to the end of a finger—scabs, as they have been designated—usually stud the large intestines almost throughout their whole extent. . . . The inner surface of the bladder often resembles the mucous membrane of the large intestines, and the larynx is slightly ulcerated. The rest of the organs are generally healthy. . . . The blood in all the vessels is *fluid*, evidently from *loss* of its *fibrine* (completely opposed to Dr. Gamgee's showing, p. 240). It is also darker in colour than ordinary *venous* blood."

This description, though differing in some important particulars from the foregoing, stands as a sufficient identification of the Steppe plague with that which is now running its course in this country. Similarly, by a reference to the records of the Italian visitation in 1711-14, and the English in 1745, preserved in the writings of LANCISI, LAYARD, VICQ D'AZYR, and others, the same connecting-link is found to exist between the *post-mortem* manifestations of the different periods, as that which has been mentioned as existing between those externally visible. These various outbreaks are as similar in character as are those of small-pox in different localities, and under differing circumstances.

*Nature and Character* :—Having thus become acquainted with the symptoms, we are now prepared to consider another set of opinions. Professor GAMGEE says :—

"The cattle plague is a specific, malignant, and highly contagious fever, known to us only as the result of direct or indirect communication from sick to healthy animals. . . . It is a specific *bovine* fever, manifesting all its characteristic features in horned cattle alone, though experience has proved that there are circumstances under which it may be communicated to the buffalo, goat, sheep, deer, gazelle, zebra, and other wild ruminants. . . . It never attacks men, horses, dogs, . . . . The animal poison which is the active agent in the development and propagation of the malady, originates in the system of the ox, is perpetuated in countries where herds of cattle abound, and is not to be found where bovine animals are wanting. . . . The disease spreads from country to country through the trade in cattle. . . . The poison passes through the system of other than animals of the bovine race, but appears to be deprived of much of its force until it returns to members of the ox tribe. The cattle plague is not a local disorder, it is not an affection of any special organ or group of organs. It is a systemic disease—a fever in which the mucous membranes and skin are specially implicated. The cell growth, fatty and molecular disintegrations, disquamation and

discharge of the epithelial and epidermic cells, are typical of this disease. In this way it can only be classed amongst general diseases with fevers of a specific kind, and which originate from a specific cause, run a definite course, manifest a singular periodicity in their progress, and have a marked tendency to destroy life. The pathological process is constant. The temperature of the body first rises. General functional disturbance soon follows, the blood loses its watery parts and soluble albumen, indicating also a large increase in the proportion of blood corpuscles and fibrine to serum. Assimilation is checked. The reservoirs in which the food is prepared for true gastric and intestinal digestion become torpid. The rumen, reticulum, and omasum retain a large quantity of solid food, and their movements are stopped. The fourth stomach ceases to secrete gastric-juice, its epithelium is thrown off, a morbid cellular deposit clogs the gastric glands, and the proper preparation of aliment for intestinal digestion and absorption can no longer occur. The intestine is the seat of inflammation. Its contents indicate the drain of the blood of its soluble albumen and other products, the intestinal epithelium is rapidly ejected, and in some cases many of the glands become clogged with a deposit similar to that which is found in the follicles of the gastric mucous membrane. A free suppuration is nowhere witnessed, but discharges flow from the mucous membranes, and are highly charged with epithelial cells and the specific virus of the disease. The rapidity and completeness of the general functional disturbance is indicated by the albuminous and dark-coloured urine; the deposition and early putrefaction, fetor of the secretions, &c."

As to other features he agrees with the NORFOLK MEDICAL COMMITTEE, who express their opinion thus:—"With regard to the essential nature of the disease, there can be no doubt that it is due to a special poison of great subtlety; one capable of reproducing itself in the living organism; intensely contagious; capable of being disseminated widely by means of the air, and also readily conveyed by the clothes of attendants, the skins, viscera, &c., of the dead animals, or any solid substances which have become infected with it, given off by the exhalations and excretions of the living animals, and moreover capable of being artificially conveyed from animal to animal by means of the discharge both of the living and dead bodies." Not only do they consider that the disease is the result of a specific blood-poison, but that it is an eruptive disease, closely allied in its nature to the exanthemata in man; that it is both infectious and contagious; that it is communicable from ox to ox, from sheep to sheep, and between these two classes of animals by mere association; that it is also inoculable by means of the discharges from bullocks to sheep, from sheep to bullocks, and to each other respectively. That the disease, as seen in sheep is identical in nature with that of bullocks, but is milder in type, and is also modified as to its *post-mortem* appearances.

Dr. ANDREW SMART, deducing the character of the disease from morbid appearances, states:—

"These give it no resemblance to the ulcerated typhoid fever in man. The analogy fails. The morbid appearances are peculiar. In so far as any

resemblance to human disease exists, it points to a condition of the internal lining membrane analogous to that of the skin in acute scarlatina, and the disease might not inaptly be termed an internal or mucous scarlatina. The general congestive but non-inflammatory state of the mucous membranes, the epithelial disquamation from the mucous surface, the increased temperature of the animal in the early stage of the disease of the incubation period and critical days, are facts which all tend to support this view; while the condition of the kidneys and the invariable presence of albumen and blood-cells in the urine lend additional confirmation to it.\*

Dr. WILLIAM BUDD, of Clifton, speaks thus of it\*:—"Definite in character, affecting for the most part only a single species, having a period of incubation, occurring as a rule but once in life, specific in the highest sense of that word, and in its very essence a contagious fever, it is a perfectly typical member of that family of which human typhoid fever and human small-pox are familiar examples. . . . What variola ovina is to human variola, that precisely is this typhoid fever of the ox to human typhoid, not identical in either case; not intercommunicable, essentially different in species, but so nearly related as to admit, on a superficial view of being confounded, each with its counterpart." The common term applied to this malady by the French writers, including REYNAULT, LOUIS, BOULEY, and BOURGUIGNON—*Typhus contagieux*—sufficiently indicates the state of opinion concerning it across the Channel.

Professor SIMONDS, in the Report before referred to, says:—

"It is difficult to speak with certainty of the true nature of the rinderpest, but it is evident that if the morbid matter on which it depends, having entered the system through the medium of the organs of respiration, soon acts upon the blood by converting some of the constituents of that fluid into its own elements, and that, while this process is going on, the animal gives no recognisable indications of being the subject of the malady. This period constitutes the incubative stage of the disease. The blood having thus become contaminated, its vitality impaired, and the poison augmented a thousand-fold within the organism, the brain and nervous systems, as the centres of sensation and motion, have their normal functions necessarily and quickly interfered with, and hence one of the earliest indications of the disease is a spasmodic twitching of the voluntary and other muscles of the body."

Then follows the battle in the body between the power of the poison and the power of the constitution:—

"Ulceration of the mucous membranes, commencing in the follicles, may attend these processes, but it is not a necessary pathological condition of the pest. It is rather to be regarded as a sequence, depending for its existence on the amount of the contamination of the blood, the duration of the diseases, and the diminished strength of the vital forces. In all this we have a great similarity to the pathology of the small-pox, but in that disease the external skin is the principal focus of the malady; while in rinderpest the mucous membranes or internal skin are its chief seat."

---

\* Address read at the British Medical Association at Leamington, August 4th, 65.

Several physicians of the last century have left their views respecting the cattle-plague which then made its appearance. They characterise it as a pustular eruption, allied to small-pox. Dr. MORTIMER describes "scabby eruptions in the groins and axilla, which itch much; for a cow will stand still, hold out her leg, and show signs of great pleasure when a man scratches these pustules or scabs for her."\* Dr. BROCKLESBY remarks: "Frequently we may observe pustules break out on the fifth or sixth day, all over the neck and fore parts."† In 1758, Dr. LAYARD writes thus: "Whoever will compare the appearances, progress, and fatality of the small-pox with what is remarked by authors of authority, as RANAZZINI, LANCISI, and other observers, relative to the contagious distemper amongst the horned cattle, will not be at a loss one moment to determine whether this disease be an eruptive fever, like unto the small-pox, or not."‡ VICQ D'AZYR, a great French authority on epizootics, writing to Layard, said:—"Il me paraît, comme a vous, que c'est toujours la même maladie qui a régné depuis 1711; et qu'elle a des grands rapports avec l'éruption varioleuse."§ In support of these opinions such men recommended and practised inoculation.

For Dr. MURCHISON'S views we must refer to the 'Lancet' of September last, his 'Official Report' not having yet appeared. He there puts forth a series of propositions, upon which he attempts to establish the identity of rinderpest with small-pox. The main points of resemblance he considers to be in the prominent symptoms, the anatomical lesions, the peculiar odour after death, the duration of the fever stage, the extreme contagiousness, and the facility with which the poison is transmitted by fomites. He lays great stress, too, on the pustular eruption of rinderpest, and contends that, as small-pox is the only acute contagious exanthema in man that assumes a pustular form, identity must be more than probable. Beyond this, both diseases can be propagated by inoculation, which can be said of no other human malady than small-pox. It is necessary here to observe that these propositions were advanced as recommendations to the practice of vaccination, which, as Dr. MURCHISON fully admits, has since proved of no avail.

It would be of no service to carry these quotations further. From what we have seen, the disease appears to have no analogue in the morbid affections of the human race. To several of them it presents a singular resemblance, but with none an exact identity. A slight acquaintance with it has led pathologists to adopt a

\* 'Philosophical Transactions,' 1745. Vol. xliii. p. 554.

† Essay on the 'Mortality among the Horned Cattle.' London, 1746, p. 33.

‡ 'Philosophical Transactions,' 1758. Vol. 1, p. 531. § Ibid, 1780.

classification that has been abandoned on more mature consideration. It has been compared to typhoid fever, to diphtheria, to measles, to small-pox, and to scarlatina. Unlike typhoid fever, it has, according to the general bearing of the foregoing authorities, no ulcerated intestinal glands. Unlike diphtheria, it has no true false membranes. Unlike measles and small-pox, it would seem that the eruption is neither so constant nor so marked as to identify it with either. To scarlatina it bears a strong resemblance; but even here the similarity is not so thorough as to warrant its being classed as an equivalent. By those who claim for the cattle-plague an identity with small-pox, it should be borne in mind that the arguments urged to demonstrate the identity of human and ovine variola, are much stronger, and have yet failed to establish the proposition. Those who possess doubts on the subject will do well to consult Dr. BUDD'S valuable little pamphlet on *Ovine Variola*. It appears that sheep do not purchase an immunity from rinderpest by passing through the severities of small-pox, which they should do were the two identical, nor does vaccination protect the sheep from rinderpest. In small-pox the eruption on the skin is principal, that on the mucous membranes subordinate. In rinderpest, on the contrary, it is the eruption on the mucous membranes that is principal, while that on the skin is subordinate. So that, while small-pox may be defined as it generally is defined—as a fever in which the eruption occurs on the skin, rinderpest may, in the same way, be defined as a contagious fever, in which the eruption falls on the mucous membranes. Some people call it therefore intestinal small-pox, but as yet there are invincible difficulties to its being categoried either with small-pox or typhoid fever, notwithstanding that, like both, it is a blood-disease, resulting from the presence of poison absorbed into the system. Were this small-pox, the human subject would be exposed to it. This result is not obtained. It is true that Mr. HANCOCK exhibited what appeared to be a variolous eruption upon his hand, as an example of the special eruption induced by the cattle-plague poison, before a meeting of the Pathological Society; but many others have purposely inoculated themselves with rinderpest virus without any effect, and, supposing themselves protected by previous vaccination, have subsequently produced pustules by re-vaccination. Besides, amongst the non-protected population of Eastern Europe, no case of communication during early or recent attacks is upon record.

A few facts touching the *propagation* of this disease still remain to be disposed of in this section.

The announcement made by the Privy Council (August 3), “That the disease especially belonged to the ox tribe, and that

it has never been known to attack any other domesticated animal," is certainly at variance with our knowledge now, although it was in conformity with the view expressed in 1857 by Professor SIMONDS. We are indebted to Dr. CRISP for having publicly stated that goats readily develop the ferment, and that in this country a zebu, a moufler, a deer, and two species of antelopes have succumbed to it. Mr. BOULEY, of the Alfort Veterinary School, has furnished a description of occurrences at the Jardin d'Acclimisation, Paris,\* which incontestably prove the vague term applied to this epidemic to be a misnomer, for the contagion introduced by two gazelles imported from London spread to 43 animals, zebras, goats, antelopes, stags, Virginian deer, musk-deer, yacks, aurocks, and peccaries, which died of the poison, or were killed. The facts concerning the peccaries must cause additional anxiety on account of the similarity of the visceral anatomy of that animal and the pig.

For some time the reports affecting the liability of sheep were discredited. The wish being father to the thought, the disbelief in this additional and unexpected calamity was very natural. Professor SIMONDS was one of the first, I believe, to recognise the fact that cattle-plague might be transmitted from the ox to the sheep, and back to the ox. The cases in the East of England confirmed his view, which, though much contested, has unhappily been substantiated by many other instances. The medical commissions of Norfolk and Edinburgh, while they confess the sheep to be *less* disposed to receive contagion than oxen, place the fact of liability beyond question; and it will be seen that Professor SIMONDS, in the paper read before the Royal Agricultural Society (Feb. 21), that of 23 flocks in various parts of the country, comprising 3948 sheep, 2265 had died, and this within the last few months. An Order by the Belgian Government, dated 12th October, forbidding the entrance into that kingdom of sheep from Holland, where the pest was then raging, shows them to have been thoroughly aware of the danger. It is a matter for regret—and the circumstance has been observed in Austria as well as England—that there is no mitigation of the disease when the inoculating virus is taken from sheep and passed back to cattle.

Finally, as to the infectious nature of the cattle-plague. It has been said that a pocket-handkerchief once impregnated with the virus of small-pox, and carried round the world, will convey the disease after a lapse of ten years. This testimony applies quite as fully to the virus of rinderpest, which, beyond this astonishing vitality, is swift and subtle in the highest degree.

---

\* 'L'Union Medicale,' Jan. 6, 1866.

Though it seems to depend upon animal life for its development, it by no means does so for its conveyance from place to place. Where the gentle breeze and the running brook will not convey it, all living things become its involuntary carriers. Flies, farm-*vermin*, birds, cats, and dogs, the higher quadrupeds and man, transport it from place to place, either internally or externally. It finds a hiding-place in hay and straw, and in articles of merchandise passes the frontiers of contiguous countries, and crosses the sea from one continent to another.\* Nothing seems to kill it save purging flame or torrid heat.† It is carted into the field with the manure, and, though buried beneath the furrow, is said to retain its malignity for many years.‡ Doubts are also expressed lest it may not pass with the rain-water to the under-drains, and from them to the feeding-troughs of the cattle which these so frequently supply. Scattered upon ground exposed to the sun's rays, it is highly probable that, like other forms of miasmata, the virus of the cattle-plague may be drawn up with the earth-vapour, blown in the cloud, and discharged upon some region distant from the point of ascent. Unless under the impulse of wind, the atmosphere will not convey it more than a few hundred yards. The air about thirty yards from a fever patient is said to be harmless; but Professor SIMONDS extends this distance in the case of cattle-plague to 500 yards; in which case it may be supposed that the virus is too much diluted, or sinks by its own gravity to the ground before it attains the distance from the ejecting source.

It is observable that when this virus escapes from Russia, like that of small-pox, it attacks the denizens of a new soil with fourfold the virulence it does the race which, according to some, gave it birth. Within the region of the Steppes the mortality ranges from 45 to 50 per cent. In Poland, according to the official communication of Brigadier-General MANSFIELD, in 1857, about 50 per cent. When it reaches Hungary the mortality rises to 65 per cent.; while with ourselves and the Dutch it reaches as high as 90 per cent. As it spreads to the north and west, the poison works with greater avidity, slumbering in the heats of summer, and awaking to fresh activity during the rigorous winter. Consul-General WHITE,

\* 'We have just received intelligence of an outbreak of this malignant fever in America.'—'Times,' March 7.

† Dr. Kemp, in his 'Natural History of Creation,' says that a temperature of 120° effectually destroys the virus of continued fever. Rinderpest, however, raged in Egypt in the presence of a greater heat. I regret that I have not been able to consult for this paper Dr. OGILVIE's Report to the Pacha of Egypt on the fierce attack which carried off the cattle of that country.

‡ Dr. VOELCKER, entertaining a high opinion of the disinfecting power of soil, thinks otherwise.



writing to Lord Clarendon from Warsaw, in 1857, attributes the difference to the superior constitutional strength of the aboriginal race of Polish cattle. Without denying this fact, it is necessary to bear in mind that we are led by due observation of small-pox to expect such behaviour, which, as Dr. PLAYFAIR observes, although fatal enough with us, acts as a most malignant pest when it deserts its usual haunts. It is hopefully characteristic of this poison that it requires the presence of certain congenial conditions—perhaps of the climate, perhaps of the animal organism; certainly of the latter, for the deteriorated animals always first fall victims, and then, as the virus strengthens, the rest are carried off. Professor RÖLL has found this to be the case in Austria. He says the cases are sporadic in certain years, and that it only becomes generally diffused in years when contagious diseases among men show a severe type. Without this ray of hope we might well view with dismay the growing demand for foreign cattle, and the vehicular facilities devised for the enlarged proportions of this trade.

CAUSE.—Having already trenched upon this subject in the section accorded to Origin, I intend to deal briefly with it in order to allow the more room for what naturally follows.

It is generally allowed that disease is referable to two causes—existing and predisposing. With the desire to be rather more definite, some authorities acknowledge a third set of causes, which they term exciting. In order to set up a disease, the existing and predisposing causes must be present. The existing tendency to death is ever present in the organism, which is born to die—not so the predisposing. Among the latter may be enumerated hereditary tendency; a plethoric state of body induced by high living and little exercise; a deteriorated state of body induced by low living and impure air; a depressed circulation and susceptible nervous system; previous disease; mechanical and chemical injuries; atmospherical changes and conditions—extreme heat, extreme cold, excessive moisture, excessive dryness, different electrical conditions, variations of the barometer, and paucity of light. Further, the atmosphere, and it may be added the water, contain impurities that have the power of exciting disease: these are, the matter of malaria, inducing ague; contagion, causing various fevers, &c.; and noxious gases.

Dr. BROCKLESBY (1746), who minutely studied the characteristics and causes of the plague that attacks the human organism, compared the zymotic germ of that disease to an exotic, which, being transplanted from its *locus natalis* in other other lands, exists here for a time, and then dies out. It is a question whether we must not adopt the same view; for although

men of considerable reputation are found to believe in spontaneous generation, the weight of authority is undoubtedly against such a supposition. It will, I think, be generally admitted by those who resist the spontaneous theory, that although the virus cannot be generated here, its operations here can be materially facilitated. "Filth," say the EDINBURGH COMMITTEE, "cannot generate the specific poison of rinderpest, but may intensify it." There are other causes which tend to invite attack by throwing down the natural defences of the system. To some of these predisposing causes, already referred to, it is desirable to direct attention.

Those of my readers who read a paper on the '*Precocity of Development*,' which appeared in vol. xii. of the '*Bath and West of England Journal*,' will remember probably to have laid it down with very grave misgivings as to the results of the present system of breeding and feeding. It is true that this system appears to be forced upon us; but where will it end? The cry has been for the animal that will be the first ready for the carriage, the saddle, the dairy, the butcher; and so far the demand has been answered with great skill by the farmer; but at what cost? This writer truthfully observes, that "that which is rapidly produced is wanting in stability." In comparing the wild with the domesticated state he remarks, "domestication not only modifies the condition of development, but it effects important alterations in circumstances under which disease is produced and extended from one generation to another. Defects which in the natural state would render the animal incapable of living, and which, if perpetuated, would end in the extinction of the race, are, under the new conditions, fostered, extended, called 'hereditary.'" He further points to the different results attending the selection of man and nature; and says of the former, "He feeds and moulds according to choice; and to a certain extent the animal organization will admit of it. The tendency of the system is to force the animal by every available means to premature adulthood. By excessive feeding, fat accumulates upon the surface and in the interior of the body, encroaching upon the more important tissues." Deterioration also takes place in the quality of the blood. "Inactivity tends to the diminution of muscle, and impairs the functions of respiration, circulation, and excretion, upon which depend the purifying of the blood, the removal of effete matter, and the proper action of the various vital functions. Tissues are rapidly formed, and are, in consequence, of deficient stability. The animal attains his full growth prematurely," and it seems questionable whether we are correct in regarding it as typical of perfect health. This early maturity in the horse is attained at

the expense of endurance. What is sacrificed for it in horned and other stock? Apart from the deteriorated quality of meat thus produced, this laying on of fat and want of exercise engender muscle wanting in firmness, excess of fatty tissues, defective secretion, loss of tone of the respiratory and circulating organs, fatty disease of liver and heart, predisposition to disease, and want of power to resist its effects." These remarks are quite in accordance with the observations of one of our best pathological anatomists, Dr. GANT, who, two or three winters since, aroused the ire of the prize-winning breeders by laughing to scorn the complaisant manner in which they talked of fat, and valued their cattle for the same reason that a Sandwich Islander values his wives. He made a great many *post-mortem* examinations of the prize animals, and used words of warning concerning the enfeebled vital organs that will recur to most readers. These being the views and facts stirring the minds of thinking men, it becomes our duty to ask, "Is there any predisposing relation between the high-pressure feeding of cattle hitherto prevalent and the propagation of this plague among them?" Time will show, provided only accurate official returns of the plague's comparative diffusion among different breeds be supplied. In this country there is a marked difference in the mortality of the cattle of various districts suffering not only under this, but other disorders. The same treatment in different localities is not productive of the same results. Lord AIRLIE, speaking in the House of Lords (Feb. 20) concerning the percentage of recoveries, shows them to have been 4 per cent. in the metropolitan police district, 12 per cent. in Wales, 20 per cent. in Scotland. In Cambridgeshire, Cheshire, Yorkshire, Kent, to 17th February, there was a proportion of 1 recovery to 7 deaths; while in four Scotch counties the proportion was 1 recovery to 3 deaths. In Yorkshire the recoveries are 17½ per cent., in Cheshire only 7 per cent. Such differences as these render it desirable that the veterinary department of the Privy Council should be permanently charged with the duty of supplying quarterly returns similar to those of the Registrar-General, from which the country has derived such indubitable benefits.

Bearing in mind the close affinity the cattle-plague bears to typhoid fever and small-pox, it is natural to expect to find the same set of predisposing causes at work in one case as in the other. Thus we look for what depraves the vital powers in bad living,\* over-crowding,† filthy steading, exposure to extremes of

---

\* It is generally allowed that typhus can be produced *de novo* by over-crowding, especially when starvation has enfeebled the system. It may further be stated that there never has been a state of unusual poverty but it has been followed by an epidemic and fever.

† Lest the fact should be considered unanswerable that in the metropolis, in

temperature, and the like; and we find them readily enough in the three years' severe drought previous to the autumn of 1865. The scorched pastures, the ill-nourished hay and straw and root-crops, and the defective supply of water, subjected our domesticated animals to privations that must have materially reduced their ability to resist the attacks of disease.

I will only further remark that the whole question of *predisposing causes* is of the deepest concern to farmers. A thorough investigation in this direction would probably explain the apparently spontaneous origin of the plague in some districts and its apparently capricious propagation, and would moreover, perhaps, reconcile the antagonistic views of "contagionists" and "non-contagionists." Above all, such investigations, making known all the circumstances under which the disease is propagated, might be preventive of its diffusion now, and lead to the prevention of any revisitation in future, or at least to its assuming a modified form.

We now come to the practical part of this great subject, TREATMENT, which must be discussed under two heads:—

1. *Curative.* 2. *Preventive.*

"Whatever may be the merits of the English in other sciences, they seem particularly excellent in the art of healing. There is scarcely a disorder incident to humanity against which they are not possessed with a most infallible antidote. The professors of other arts confess the inevitable intricacy of things, talk with doubt, and decide with hesitation; but doubting is entirely unknown in medicine." Thus wrote a well-known author in the last century. Whether intended or not, the pungency of the satire is considerable. Under present circumstances, when the disciple of *Æsculapius* has made way for the knacker, we are fully able to appreciate it.

It cannot be denied that a sensible change is coming over the medical mind. Whatever may be the credulity of their patients, the doctors are becoming sceptical of their own power. They depend less upon the application of a specific antidote than upon throwing an *ægis* around the vital parts, and drawing off and diverting the threatened attack of the enemy, as the *Matadore* plays with and exhausts the bull in the arena. They undoubtedly possess two or three remedies that in some unexplained manner

---

Edinburgh, and in Cheshire, the best kept cows have suffered with the worst, it may be as well to remind the objector that an epidemic will, when it acquires sufficient force, leap beyond the rags and filth that generate it, and carry death and sorrow to the salubrious abodes of the wealthy. In mentioning Cheshire, Mr. Bailey Denton's remarks on the sad state of the shippens there, occurs to me. He describes them (of course with exceptions) as low, close, cramped, and stifling. In these buildings the temperature ranges at the cows' heads at 60°, at their tails at 30°. Of town dairies I need say nothing.

do cure disease. The best example is afforded by Jesuits' bark, which certainly cuts ague short. But the majority of remedies are not thus effectual. The medical practitioner, looking beforehand and perceiving in what way the malady threatens to prove fatal, employs them to excite in the system an action opposite to the fatal tendency. He has made notable advances in pathology and diagnosis, but for the rest trusts mainly to the *vis medicatrix nature*, aided by hygienic means and a few simple drugs. No man of sound education pretends now a days to cure, for example, such infectious disorders as typhus, scarlatina, and small-pox. All that can be done in such cases is to place the patient in those conditions which have been found most conducive to recovery. It is thus that we have banished the black death that used to mow down the populations once tenanted the rush-covered floors of the middle ages.

*Curative.*—The Veterinary School having thrown up the case at once as incurable, the Homœopaths struck in to save the credit of the faculty. A word or two must follow descriptive of their attempts to stay the plague. It will be within the memory of all that a letter detailing the experience of Dutch Homœopathic practitioners appeared from Mr. CAIRD on the 17th October. He reported the recovery under this system of 50 per cent. The force of public opinion secured an opportunity for this school to do its best, which it appears to have done. Under the guidance of a Homœopathic Association, of which the Duke of MARLBOROUGH was chairman, organised attacks were made upon the rinderpest in Norfolk, Cheshire, and Yorkshire. The Norfolk attack—owing, it is stated, to the disregard of instructions on the part of the owners—pretty nearly failed; at least the recoveries did not average more than 16 per cent. The York attack was more successful, the staff of assistants was larger and better qualified. “Since the 9th November,” writes Mr. POPE (M.R.C.S. and surgeon to the York Homœopathic Hospital), “117 animals suffering from cattle-plague in all stages were treated, not together in a sanatorium, but at large in various farm-steadings around York. During the first seven weeks the recoveries were 40 per cent. of those attacked. With improved experience the recoveries at the close of the time rose to 50 per cent.,” making allowance for a few cases of mismanagement. This practitioner states the essentials of his treatment to be—

“the commencement of treatment in an early stage, good nursing, constant attention, scrupulous cleanliness, suitable diet, and a truly homœopathic medicine. With the presence or absence of these the rate of mortality fell or rose. If treatment begins four or five days after the appearance of the characteristic symptoms, it is almost sure to fail. *Good nursing* means assiduous attention, warm clothing, efficient ventilation, &c. *Suitable diet* means the absence of

all food requiring mastication, and the very greatest care to give everything warm and fluid till the first and second stomachs have renewed their functions. The *medicines* used with most advantage are belladonna, in 2 to 5 drop doses of pure tincture, every two, three, or four hours, to subdue the general congestion: rhus toxicolendron, to allay the muscular twitchings; caustic ammonia, to abate the abdominal distension; turpentine, to check hæmaturia; phosphoric acid, mercurius solubilis, and arsenic, to control diarrhœa; mercurius corrosivus, to check dysentery; and arsenic, to rally and buoy the system about the fifth or sixth day."

In connection with this Report it is observable that, up to the 20th December, Yorkshire was officially charged with 8640 cases of rinderpest. Of these, 8 per cent. had been killed, 77 per cent. had died, and 15 per cent. had recovered. On the 21st of February the Association already named published a Report, signed "MARLBOROUGH," in which we find the following figures:—

	Percentage of Recoveries by Homœopathy.			Average Recoveries for the same county. :
Norfolk .. ..	13	.. ..	7	
York .. ..	45	.. ..	17½	
Cheshire .. ..	30	.. ..	7	

During the reign of the poleaxe the valuable and so far successful experiments of this body of gentlemen are postponed.

Dr. TUCKER having called attention to the experience of Professor POLI, of Milan,\* with the bisulphates of soda, potass, and magnesia, "to *neutralise* all blood-poisons," they were tried at first with some success, but latterly nothing has been heard about them. Mr. Little, of Peterborough, and others, who gave them a fair trial, do not report favourably either of them or the other drugs used. Neither have the common remedies applied in typhus cases availed—continuous animal food (beef-tea) and muriatic acid—nor injections of opium, creosote, starch. Sesquichloride of iron, and chalybeate waters of a kind said to be generally used with great success in Poland, have not warranted the opinions formed of them. Dr. CHAPMAN'S application of ice along the vertebral column, so favourably marked in cholera cases at Southampton, has scarcely perhaps received sufficient attention. Under the supposition that it is the duty of the physician to recruit the *blood* of the sickened animal—to re-supply its saline and alkaline conditions, without which the vital power, the animal heat, and all the powers of resistance to the pestilential poison must fail—Dr. TUCKER early recommended a mixture which has been used with some good results, but not as a specific. The elements are—bicarbonate soda, 1 oz.; muriate soda, 1 oz.; chlorate potass, ½ oz.; Rochelle salt, 1 oz.; dissolved in 1 gallon of water, 1 pint administered alternate hours. Hyposulphate of soda has been

\* 2 dr. of bisulphate of soda recovered dogs attacked with glanders.

announced as a neutraliser of the virus of rinderpest; but, if it turns out to be of use, it will rather be as a prophylactic. What is known in Edinburgh and Leith as Mr. BAXTER'S treatment appears to have been successful. At the commencement of the attack solid food was proscribed, and sawdust substituted for straw; a laxative was then given, followed by sweetened ale and whiskey every two hours. Subsequently 10 drops of tincture of belladonna was administered every three hours, and for eight days the sufferer was sustained with fluid aliment. Then Peruvian bark and carbonate of ammonia were employed to complete recovery. I do not remember to have met with any record of any series of experiments made in hot-air baths. Cold water to drink and hot air to breathe will eliminate blood-poisons by perspirations, produce a crisis as a fever, while hot air of high temperature, 240°, kills vermin, their eggs, and all animal poisons, pestilential germs included. This being the case, something might be expected from the Turkish bath. The Hydropathic pack and wet sheet have created some stir. Mr. DAVID CHRISTY, of Patching Hall, Colchester, affords me the most satisfactory evidence concerning this treatment. He says:—

“I had altogether 22 cows on this farm that had the complaint; 15 have recovered and are doing well—a result which appears quite exceptional in these parts. When the disease came into the neighbourhood I commenced and continued sponging the mouths and nostrils with vinegar every morning. The first two treated by my veterinary with sulphate of iron had died. The next I treated with stimulants, and poured large quantities of cold water over it every day: it recovered. At this period I administered arsenicum daily to the whole herd. As they became affected they had arsenicum, belladonna, bryonia, phosphorus, and were packed in wet sheets, with several dry wool sheets over, twice a day, for one and a half to two hours each time. The disease was six weeks with me, which I attribute to my care in isolating the diseased, and in the use of chloride of lime. At my other farm I lost 16, and not one recovered; but I had not then tried the remedies here described. I think it took a more virulent form there than here.”

The vapour bath, as recommended by a Russian authority, was thoroughly tried by Mr. Sweetland, of Hendon. A chamber was prepared, with floor rising to one end. The animal stood with his head at the upper end in the neighbourhood of a supply of fresh air. The unmedicated vapour of boiling water kept the temperature up to 120°, and to the animals themselves this was increased by a covering of three blankets, through which the perspiration poured. The duration of each bath was half an hour; some animals were bathed three times, but out of the eight cases tried no cure resulted. The symptoms were modified and appetite was induced after the bath; but no good permanent results followed. The EDINBURGH COMMITTEE used this bath with success, and with it administered separately doses of oil of turpentine, infusion of coffee, carbonate of ammonia. Professor DEMBENSKI

represents the Polish treatment to consist of a plentiful supply of water, acidulated with sulphuric acid; spirits of wine with tincture of opium three times a day; sulphate of quinine in peppermint water, or a solution of nitric acid; the nose and mouth being washed with vinegar. The MEDICAL COMMISSION OF HOLLAND, considering the malady to be *typhus contagiosus bovum*, recommends the infected cattle to be treated with from 3 to 4 dr. of muriatic acid, mixed with 6 oz. of treacle and decoction of linseed.

The EDINBURGH MEDICAL COMMITTEE, who by the way "*deprecate and protest against indiscriminate slaughter,*" recommend that the disease be treated with a view to cure. In common with the Homœopaths and most of the authorities here named, they depend more upon nursing and diet to sustain the vital powers, while they wage war with the invader, then upon medicinal agents, to repel it. Summarising the highly practical document issued by them, we find that the diseased *animals* should be placed in a warm well-ventilated byre, temperature 70°, and carefully rubbed down and covered with a warm rug; that warm drinks of gruel, bran-tea, or hay-tea, be copiously administered, as the only food suited for the early stage; with cold water to drink *ad libitum*. Stimulant diuretics and diaphoretics to be also administered, to act on the skin and kidneys, to relieve internal congestions, and to eliminate the poison. Dr. Smart's dose, 2 oz. of acetated water of ammonia, 1 oz. of sweet spirits of nitre, and 6 dr. of carbonate of ammonia, in 9 oz. of water, three times daily. The bowels to be relieved by Professor Dick's dose—16 ozs. linseed oil, and a mutchkin of whiskey; or Dr. Smart's dose—2 oz. of sulphur, 1 oz. of nitre, and 1 oz. of powdered ginger, 1 lb. of treacle, and 1 quart of water. These to be repeated till effectual. For diarrhœa Professor Dick's dose—1 quart of lime-water,  $\frac{1}{2}$  oz. of laudanum three times daily, and 6 dr. of carbonate ammonia three times daily. To promote convalescence  $\frac{1}{2}$  oz. of sulphate of iron twice daily, or Dr. Smart's dose, 1 $\frac{1}{2}$  oz. of powdered chinchona. Professor Simonds, who considers the stomachs in no condition to deal with any medicines, would condemn such insoluble medicines, I should suppose, as sulphur, ginger, and powdered chinchona. In his Lecture on the Cattle-Plague, to be found p. 270 *seqq.* of this Journal, it will be seen that he refers to several cases in which total starvation for some days has wrought cures that would not have been likely to have attended treatment. There are cases of groups of affected animals accidentally left in confinement and forgotten which have recovered, and others in which animals reserved for the knacker have recovered before that hard-worked functionary could knock them on the head, and still others in which animals have escaped before



the blow fell, to the woods or elsewhere, and unmolested have come off victors from the internal contest. The treatment that has created the greatest excitement is that which Mr. WORMS found to be effectual amongst his own cattle in Ceylon. It has no pretension to the rank of a specific, but possesses the merit of a sensible and practicable remedy.

The medicine consists of 1 lb. pickling onions, 1 lb. garlic, pulped and mixed with 1 lb. ground ginger; a decoction from  $\frac{3}{4}$  lb. of assafetida, enough water being used to cover, it is poured over the whole mass, which is stirred with 8 quarts of rice-water, and when cool, suffices for 14 full-grown animals, the dose being  $1\frac{1}{8}$  pint for an ox,  $\frac{7}{8}$  for a heifer,  $\frac{5}{8}$  for a calf. Mr. Worms lays special stress upon early application. *The first indications of the change of breath* should be watched, and the medicine should be followed up with nothing more than rice-gruel for several days.

Lord LEIGH honours me with a letter relative to the success of this medicine at Stoneleigh, in which he says that Mr. Worms professes only to be able to detect and arrest the rinderpest in its first stages.

At the end of February, Baron Rothschild's herd at Mentmore being attacked, Mr. Worms commenced his treatment, for some time apparently with success, but the pest returned upon those that were accounted convalescent, and proved terribly malignant.\* On the 16th March there remained of that fine herd of 119 only 66 animals.

Before leaving this section I will further observe that it is generally considered that the salts of soda and magnesia in the form of sulphites (readily soluble in water) if abundantly introduced into the blood, will prove the means of warding off the accession of the disease altogether. Dr. Smart recommends its administration in 2-oz. doses daily to adult animals, and  $1\frac{1}{2}$  to those younger. After a fortnight's treatment, with a rest of 24 hours in the middle, the exhibition of the medicine should be suspended for 24 hours every third day. There are several instances of herds so fortified that have kept at bay the plague which raged around them.

It must not be considered that space has been abused by containing details of treatment which has been superseded by a swifter specific. I cannot but think that we shall fall back upon remedial and curative measures, which, if sought in the right spirit, will never long be denied to the scientific investigator. It is, therefore, desirable to state what has been done, for herein are the clues for future experimenters. In

---

\* See Editor's note to Mr. Simonds' Lecture on the Cattle-Plague, p. 278.

various degrees I think nearly all the remedies named have tended to reduce the death-rate; and as the majority of them point to the sustentation of the powers of the animal while it fights its own battle with the virus, which is left to take its own course, it is probable that future attempts will follow in this direction. Many of the above agents are truly prophylactic (protective), and perhaps should have been placed in that category.

*Preventive Treatment.*—A belief that the curative treatment of the disease, before the results of its development have extended to every organ and function of the frame, may be attempted with a rational hope of success, is not incompatible with a higher dependence on “prevention,” which “is better than cure.” For the pathological and rational method of investigation does not deal unintelligently with the results of the cattle-plague, but begins at the other end, and by tracing it to its source, prevents its propagation, and conserves the animal. Had the physicians of a past age been encouraged to consign their plague-stricken patients to the slayer, we should still look askance at consignments of cotton from Egypt, where the plague-seeds are as numerous as ever. But having placed ourselves in unison with laws formerly violated, the thought of this terrible scourge ceases to trouble us. We have rendered ourselves incombustible: will not the application of similar means confer incombustibility on our cattle? Perhaps not incombustibility, but such resistive power as shall effect a reduction in our losses, render treatment more politic than slaughter, and afford us a safe and feasible expedient in assurance.

Last summer a proposition was made by the French Government for convening the representatives of European Governments at Constantinople to consider the best means of limiting cholera to the land whence it is supposed to issue, and to employ active measures to extinguish it. If this can be done in the case of cholera, it surely can in the case of rinderpest. For if the theory of certain writers be true, that Steppe cattle is the only race able to generate plague-virus, we have but to exterminate that race. For that purpose we would readily sacrifice a few millions of money to secure the noble and laboriously reared herds of Great Britain from such calamities as the present.

The immunity, partial or complete, obtained for human sufferers from small-pox by *inoculation and vaccination* naturally suggested experiments to be made in that direction. Pleuropneumonia, which not only carries off great quantities of cattle, but predisposes all cattle attacked with it to other diseases, certainly receives a check from inoculation. When that complaint was rife in Holland, Dr. WILLEMS, of Hasselt, devoted

himself to the investigation, presented his secret to the Dutch Government, who exposed it to the scrutiny of a Commission, and finally gave it their authorization. It is now very commonly practiced in the colonies; but here not to such an extent as it should be, considering the number of cattle that annually sink of this disorder. Looking back we find that Dr. LAYARD, in 1787, said, "But if the contagious distemper be in the neighbourhood of a herd, or break out so as to endanger the stock, the grazier or farmer may, by inoculating his cattle with proper precautions, at least secure his stock, since he can house them before they fall sick, prepare them, and have due care taken, knowing the course of the distemper." He quotes the encouraging results obtained by CAMPER, in Holland, who, out of 112 inoculated beasts, saved 41; and those of KOOPMAN, who, out of 94, recovered 45. The Russian veterinarians having observed that the oxen which had been cured of the rinderpest could mingle with impunity with the infected herd, conceived the idea of communicating the complaint to sound cattle by means of inoculation, and thereby to shield them from the contagion. The first experiments made in 1853, near Odessa, by Professor JESSEN, were very fatal. In 1854-5, the experiments repeated at the Dorpat Establishment with better-selected virus, and at Kozan, were more successful. They were led to conclude that it was necessary to inoculate several heads of cattle, the one after the other, without having recourse to any other virus than the first inoculated, so that they may thereby obtain virus of the second, third, fourth, fifth, and up to the tenth generation. The virus thus attenuated in its toxical properties answered at length in every experiment, and oxen thus inoculated could mingle with impunity with diseased cattle. At the Veterinary College of Charkow they inoculated 1059 animals with virus of the third generation, 60 animals only sinking under the operation. In 1854 a large number of the cattle of the Steppes were inoculated and not one lost, and all were found to be fortified against subsequent attacks. In 1857 the Grand Duchess Helena founded an institution for inoculation on her property at Karlowka, in Poltava, with such success that only 3 per cent. of the inoculated animals died. Dr. Playfair reminds us that these favourable results are obtained with Steppe cattle; and adds, "before mitigation of the virus appears in the case of other races of cattle it must pass through from thirteen to fifteen generations." Professor JESSEN is of opinion that no cattle should be imported from the Steppes without this safeguard. M. RAUPACH, another experienced inoculist, reporting, in 1864, from Karlowka, says, after stating that in 75 experiments 40 per cent. of recoveries was obtained, "I do not, however, recommend inoculation as a

preventive." On cattle not of the Steppe race, "the disease induced, though sometimes slight, is usually nearly as severe as that arising from natural infection." Much depends on the care taken of the animal during the experiment, on the age and quality of the virus, &c., though "no modification of the disease has been observable in the inoculation with different secretions. . . . Glycerine modifies and then destroys the virus, as in the case of pleuro-pneumonia"—but here further experiments are required. His experience contradicts that of Professor JESSEN relative to the insusceptibility of the produce of animals which have had the rinderpest. With respect to another important point, Professor RAWITSCH, a co-worker with JESSEN, states that, while old lymph is ineffectual, fresh lymph is apt to cause serious loss; and M. SERGEGEW, Director of the Bondarewka Institute, experimented with lymph nine and eleven months old without elevating the animal heat and creating the mouth-eruption, which is the test of success. Attempts have been made to cultivate a virus of modified malignity, but as yet without effect. The results of this practice in Denmark have been very favourable, but in England they have discouraged its adoption. Very little has transpired during the present visitation to give us much hope. Mr. Tollemache has spiritedly tested its value, and obtained about as much comfort as from vaccination. It was thought that the sheep inoculated with the virus might yield a milder lymph, but it is not so.

The danger of spreading the contagion is a great barrier to inoculation being resorted to except in the immediate presence of the pest. The theoretic advantages are—a milder form of disease, simultaneously induced in a herd designedly fortified against it. It does its work in from 8 to 10 days, and there is an end of it.

When Dr. MURCHISON announced his conviction that vaccine matter would do for cattle what it had done for the sufferer by small-pox great interest was excited. If this proved true, it was felt that an incalculable relief had arrived. If the vaccine virus could be employed to remove the constituent of the blood which is acted on by the fiercer ferment of rinderpest, we should have a slight disorder rarely if ever propagating itself by contagion, and in so far vaccination would prove immeasurably superior to anything to be hoped from inoculation. The foundation of this conviction lay in the supposed recognition of identity between small-pox and rinderpest. Besides small-pox, rinderpest is (saving syphilis) the only known disease which can be communicated by inoculation from the sick to the healthy, and great similarity, amounting nearly to identity, was observed in the pathological appearances. "The first thing to be done is to

produce cow-pox in cattle by inoculating them, on the one hand, with vaccine lymph, and on the other, with the matter of human variola; and afterwards to prove whether they be proof against the prevalent plague, or if the course of the disease be thereby modified." Thus advised, graziers and breeders besought the veterinary surgeons and the country doctors to "do their beasts;" and these practitioners inundated the vaccine establishments with applications for lymph, which, never sufficient for the human subject, failed utterly to equal the sudden demand. By hook or by crook, thousands of cattle were vaccinated—much lymph being used that never, under any circumstances, would elicit a responsive pustule—and the result, unhappily, is what Dr. MURCHISON, in the following letter to 'The Times' on the 30th of January, candidly avows it to have been:—

"SIR,—The points of resemblance between cattle-plague and small-pox are so striking that certain observers were led to hope that vaccination might protect cattle from the prevailing disease. The experiment, I believe, has now been fully and fairly tried, and, although the first accounts appear favourable, there is sufficient evidence that vaccination confers no permanent protection from the plague. It is well that this fact should be generally known by publication in 'The Times.' Rigid isolation and the suspension of all movement of living cattle must still be the preventive measures on which we mainly rely. I may further state that neither Mr. Ceely nor I ever maintained that cattle-plague and human small-pox were identical. We merely pointed out that the analogy between the two diseases was sufficiently close to call for the experimental inquiry referred to.

"Yours, &c.,

"CHARLES MURCHISON, M.D."

In Cheshire, vaccination, under the spirited leadership of Mr. Tollemache, was tried in 27,000 cases. I could wish there was space to detail some cases; but the general conclusion that the temporary immunity does not survive the immediate action of the vaccinal virus is all that can be admitted.

OTHER PREVENTIVE AND REMEDIAL EXPEDIENTS.—*Disinfectants*.—Contiguous pages contain so much admirable matter from Dr. VOELCKER and Professor SIMONDS on this subject, that the reader is respectfully referred to them and enjoined to read carefully what is written concerning the burial of cattle and the disinfection of manure.

In consequence of the culpable neglect of such expedients for the prevention of the cattle-plague as *an embargo upon the importation of foreign live stock* into the country, *quarantine, inspection of frontiers, ports, markets, &c.*, the nation is unhappily com-

pelled to resort to another set of expedients in dealing with the enemy that has stolen upon us, such as *isolation*, the *stoppage* of *fairs* and *markets*, and—in the present state of clinical knowledge—*slaughter*.

When the heel can cover the few sceptic germs of the freshly imported cattle-plague, the attempt to stamp them out has usually been attended with success. It was so in France, where 43 victims were made, and in Belgium where 1000 cattle fell in the successful attempt to prevent propagation. The three counties of Middlesex, Essex, and Surrey, rid themselves in three months of the plague in 1348 by decisive measures, while for want of a like course it prevailed for several years in the rest of the island. In 1862 likewise, the farmers taking the matter into their own hands, stamped out small-pox in Wiltshire amongst the sheep. Had the advice of Professors SIMONDS and GAMGEE been heeded, the country would not have furnished the afflictive intelligence which now fills the columns of our daily journals.

Aberdeen furnishes so good an instance of the skilful determined way in which a community can wield these two weapons of isolation and slaughter that it is worthy of being recorded. The county, consisting of 84 parishes, agrees to provide a fund by a voluntary rate of one penny per pound upon the agricultural rental of proprietors and of tenants, which amounts to 4000*l*. Sufferers by disease are indemnified to the extent of two-thirds of their loss when the animals are allowed to die, and three-fourths when slaughtered. A separate committee watches over the interests of each parish, and executes the stringent orders of the central committee to slaughter the single animal when one in a herd is only detected slightly affected, and to watch the rest by paid watchers; and, if the disease spread, to slaughter all animals in contact with the diseased. The committee meets on every new alarm, values the whole stock on the farm, resolves on measures, communicates its resolve to the owners, who if non-compliant forfeit all claim on the funds. It is also responsible for disinfecting and burying, &c. The first Report, published on the 10th January, contains this abstract:—‘The disease has been in this county since July. It has attacked 40 different herds; 93 animals have died of the disease; 143 have been slaughtered and buried; and 226 have been slaughtered on the spot and the meat sold after inspection. Total number, 426; total loss, including that on animals slaughtered and sold, 3875*l*. The loss by the slaughtering policy estimated at about 33 $\frac{1}{5}$  per cent. on the whole value, deducting the returns by sale. At the date of this Report the plague was completely extirpated. But by the 1st February the disease had appeared almost simultaneously in four herds seven miles distant from each other.

Previous outbreaks had been traced to imported cattle; the cause for these was inexplicable, and, after much surmising, the country settled down in the belief, and a very reasonable one, that infected matter scattered in the line of wind had broken the cordons that had been imposed. These outbreaks were quashed, but alarm has since been spread. The experiment reflects immense credit on those who have conducted it.

The more general course of action is illustrated by the Norfolk Association, and in glancing at details kindly furnished by Mr. C. S. REED we shall perceive some of the difficulties as well as the disadvantages attending it. The Association, consisting of farmers and landowners, was formed early in July, for mutual assurance and the regulation of the cattle trade in conformity with Orders in Council. A fund raised by a rate upon the Poor-law assessment (9000*l.*), and supplemented by a very liberal subscription of the landowners (5000*l.*), was applied to the relief of sufferers, to whom was paid two-thirds the value of their cattle. In December, a new rate being required, 8000*l.* was added to the former sum. By the first rule members were prohibited from buying any stock for six weeks, but though nine-tenths of the farmers were members, the unassociated tenth vitiated the rule and inoculated the whole county. The Mayor for 1865 at length closed the market, which was reopened by the Mayor of 1866 for fat stock bound solely to the Metropolitan Market. The effect of this restriction was that the Yarmouth butchers received their supply of cattle from Norwich *viâ* London, the Government not being disposed to close the Metropolitan Market. In fact, by reason of diverse and selfish counsels, the Association gave up the idea of stamping out the disease and turned their attention to treatment.

The difficulties attending local action are well exemplified by a case in South Lincolnshire where the beneficial operation of a Mutual Assurance Society was neutralized by various alterations in the original rules, which had the effect of releasing from obligation those who signed the first constitution. "We are thus placed in a false position," says my informant, "we cannot compel adherence; all is upon honour." It is to be feared that many other associations are placed in the same situation; those who are true to their honourable obligations find themselves without power of legal recovery against those who are not.

Could such energy be imported into the measures now being enforced in England as we are called to witness in Aberdeenshire, there might be some hope for us even now at the eleventh hour. Judging from present appearances, however, we have no reason to be very hopeful. The rate of compensation offered, and the powers given to inspectors, are not such as to bring the farmers

into cordial co-operation with the Government, and unless they do unite in common action, all action will be absolutely futile.

In matters of this sort it will not do for personal effort to be relaxed because the Government has stepped in to assume the command. The strength of the nation can only be put forth by the agency of local authorities, especially in a matter descending into such minute details as this. On their integrity, public spirit, intelligence and energy, the result, under God's providence, must primarily depend. The Imperial sanction is essential not only to enable the sound-minded many in a given district to coerce the ignorant selfish few, but to ensure, in the main, concerted action throughout Great Britain.

Not only in the two cases above referred to, but in Aberdeenshire, the hindrances to efficient action have arisen from mutineers at home. Much perplexity has been found to arise from the irregularity of a county boundary. Many an English homestead is more concerned about the course followed in an adjoining county than in its own—so that in reference to this plague, the question, *Who is my neighbour?* can only be answered in the widest sense. If, in Great Britain, an effectual cordon can be drawn at all, it is only on our island shore, at the water-line; we are all in the same boat—concert and discipline must prevail from stem to stern, and for this we must look to the captain's authority.

Although the results of isolation and slaughter may at the present juncture be regarded with doubt, it is the part of wisdom to ply them with determination. Under half measures and divided councils we shall assuredly suffer grievous loss and irksome restraint, without any countervailing benefit. At the same time the use of disinfectants to neutralize the poison, either when floating in the air or when adhering to solid or liquid substances, must not be neglected. But even here, what slight hope can be entertained of this being thoroughly done? The chemists do not agree as to the value of various agents. Many consider that the virus of rinderpest is killed by flame only. What farmer will undertake to burn all his manure—to take up every pavement—to scrape every wall, post, fence, or hovel partition, and then to drench them with Condy's or some other fluid? Still, though the process is likely to fail by reason of its imperfection, it must not be neglected, nor must it be left to the sufferers themselves to conduct.

From the pursuit of such considerations as these it is impossible to rise without a profound conviction that our strength and hope for the future lie in prevention. Medicine has afforded us no specific defence—isolation in a country densely populated,



interlaced with a network of highways and railroads, and subject to strong winds, is impossible—disinfectants are not to be depended upon, and slaughter is a remedy little better than the plague itself.

In prevention much may and must be done. Now that the channels of communication are such as to allow of cattle being brought from the permanently infected districts of Russia within the period allowed for the incubation of the virus—and the demands of an industrious people will certainly draw large supplies from them—all importations of foreign live stock must be put under stringent rules. Taking care to protect the valuable herds of Great Britain in this way, it will further rest with the agriculturists of this country in the breeding and rearing of cattle to observe those laws of health which will impart to them, if not a direct immunity against future visitations, a strength of constitution that will better resist corrupting influences.

It is now 200 years since the fire of London quenched the plague and placed us in better accord with sanatory law. Probably we may find salutary lessons arise out of the present afflictive discipline. Whatever conclusions we may arrive at concerning errors of management, &c., tending to predispose our herds to infectious disorders, we may certainly agree in this, that the greater is the difficulty in a free country like ours in coping with the cattle-plague when it has burst into flame, the more important it is to extinguish it on its first appearance.

---

## ABSTRACT REPORT OF AGRICULTURAL DISCUSSIONS.



*Meeting of Weekly Council, Wednesday, February 21st.* The DUKE of MARLBOROUGH in the chair. A Lecture was delivered by Professor SIMONDS on

### THE CATTLE-PLAGUE.

The PROFESSOR said that, in making some observations upon the important subject of the cattle-plague, he should endeavour to be as brief as possible, and also to avoid as much as possible going into the discussion of any debateable points. It was extremely difficult, however, to handle a matter of this kind at the present moment, more especially when we reflect that the Society by its charter was bound not to discuss any political matter or question that might be under consideration in Parliament. For that reason he should endeavour to avoid all allusion to what was now taking place in either House upon the subject. He proposed first to make some remarks upon the disease as it had existed here in former times; and then to come down especially to the introduction of the disease on the present occasion, the progress which it had made in this country, and the means which had been adopted from time to time to arrest its progress—those means being, of course, medical means, either curative or preventive.

### HISTORY OF THE DISEASE.

It is not desirable to take up any considerable portion of time by referring at length to the past history of this murrain, further than to say that the first period assigned for its appearance in England was the year 1665; that was about the time when the plague also existed here: but it was an interesting fact in connection with that supposed outbreak that the disease had a prior existence in Western Europe. In the year 1714 a paper was presented to the Privy Council by Dr. Bates, who held a medical appointment to George II., and in that paper was an allusion to this disease. Dr. Bates said:—

“It is affirmed by several now living that there was a mortality among the cattle a little before the last great plague in the year 1665, which was imputed to the want of due care in burying them; and your lordships may know of what importance it was judged by the King of Prussia, the States of Holland, and several other princes and States, by the care they took to publish decrees and placards commanding them to be buried upon pain of death or other severe penalties; and I humbly conceive it would be necessary not only to bury those which shall die, but that such as are already dead may have the same care, as also that they be buried 9 or 10 feet deep at least.”

These observations applied, of course, to the disease of 1714, which Dr. Bates was then engaged in combatting; and they contained quite sufficient evidence to show that the disease existed in Western Europe at about that time. There was also a fair probability that it existed

in 1665; and this was the earliest record, as far as he was aware, of the disease in England, though there were many earlier ones of its existence in Continental Europe.

In 1714-15 the disease seemed to have been imported into this country; but those who chronicled its history had not given any particulars as to the manner in which it was introduced. It is, however, known to have existed not only in Western Europe, but also in Italy, in 1711-12. It made its way in 1714 to Holland, and was thus directly opposite England. There were then no restrictions of sufficient force to prevent persons from introducing animals from the Continent, so that there could be little doubt that we got the disease from the Netherlands on that occasion. It did not prevail in England for any great length of time, and was chiefly confined to the neighbourhood of London. An account was extant of certain regulations or Orders in Council having been issued, which had for their object the destruction of the infected animals, and the payment to individual owners of a certain sum of money: the country sustained some considerable loss—he believed about 5000 animals. The number of bulls and cows lost, as reported by Bates, were in Middlesex, Essex, and Surrey 5418, and of calves 439. During that outbreak, which lasted about six months, measures were adopted by which, to use a now prevalent expression, the disease was “stamped out.”

The next outbreak was in 1745, which extended to 1757. In that case the disease was unquestionably imported from Holland, and had its existence generally in Western Europe. Its introduction had been attributed by one authority to two calves having been brought to Poplar, and by another to some skins imported from Zealand. However that might be, he was of opinion that the disease was introduced by direct infection from animals in some form or other. It was important to notice the time at which it made its appearance in 1745; and, upon looking over an old work by Dr. Theophilus Lobb, he found some excellent remarks respecting it. Dr. Lobb said:—

“There is in the ‘London Gazette’ of Saturday, May 25th, 1745, the following paragraph, viz.:—‘Hambourgh, May 19th, N.S.—The mortality among the horned cattle has now reached within a German mile and a half of the Balliage of Pinneberg contiguous to the territory of Hambourgh, which is of little extent on the side of Danish Holstein. The appearance of this same distemper at Hambourgh gives an alarm lest it should gain further on that side of the country. Proper precautions are used to prevent its spreading and to get the better of it in its beginning, which is attributed to some infected cattle having passed through there. This evil has communicated itself likewise to the Danish islands of Zealand and Fuhmen.’”

Thus it was probably about the middle of the summer of 1745 that the disease was imported into England.

The next outbreak of which there was any record was a partial one, which occurred in 1769, reached its acme in 1770, and extended with little outbreaks here and there in different parts of the country down to 1771. The districts chiefly affected at that time were Hampshire and Banffshire; and it was remarkable that the disease should have appeared simultaneously in two districts so far apart as these. It

would appear from the writings of Dr. Layard, who was consulted by the Government, that the authorities were very much upon the alert, and that Orders in Council were issued, and the provisions of a special Act of Parliament passed in 1745 were enforced, which precautions appear to have been sufficient to stamp out the disease. Certain outbreaks had been described as having taken place in 1779 and 1805; but although Orders in Council were issued in each of these instances for the purpose of suppressing these supposed outbreaks in different parts of England, he was inclined to believe that the disease had no real existence from 1770-71 down to the last outbreak in 1865.

With regard to this outbreak and its origin there was much difference of opinion. A great deal might, however, be said with reference to the disease having come from Russia, from the circumstance that the Royal Commission had failed to show that there was any disease in Western Europe at the time. But be that as it might, it subsequently appeared in Holland, Belgium, and France, having been exported from England; and it was not a little singular, that with the disease in this country about the middle of June—for animals were then sold in the Metropolitan Market which are known to have been tainted—we should have sent the disease from England so early as July. It was hardly necessary to say that the disease still existed in Holland, although it had been stamped out completely in France and Belgium, where the Governments had adopted measures to ensure the slaughtering of all animals subject to the disease or exposed to it.

He would now pass on to make a few remarks on

#### THE PATHOLOGY OF THE DISEASE.

He did so for the purpose of recording his opinion as to the specialty of the disease. Notwithstanding all that had been said with regard to its nature, we had yet to learn a great deal as to the true nature of the cattle-plague; and he thought it had been a judicious course in this country not to give a special name to the affection: for any special name must have been based upon some foundation, true or supposed; and in that case we might have found ourselves tied down and fettered in dealing with the disease and its treatment in a manner from which we were now perfectly free. We in England have been content to adopt the name Rinderpest, employed by the Germans, which we translated the Cattle-Plague.

Various distinguished medical men had held the opinion that the disease was of a typhoid character. They seemed to think they recognised a connection between it and typhus in the human subject; but he believed very few persons entertained that opinion now. Some medical men had also adopted the view of its being variolous, or of the nature of small-pox. That opinion was entertained by Dr. Murchison and others. He thought, however, that sufficient information had been obtained to show that it was not at all of the nature of small-pox. Indeed, some earlier experiments proved that sheep which had been subjected to the cattle-plague and recovered from it were still liable to small-pox. He for one never thought for a moment that there was any connexion between it and small-pox, save and except its being

an eruptive fever. It was, however, important to see whether it should be spoken of as an eruptive fever of a peculiar kind; because the successful treatment of the disease would of course depend upon a knowledge of its pathology.

#### CAUSES OR SOURCES OF DANGER.

There were various other sources of danger besides the direct importation of diseased animals or animals designated infected—that was, animals in whose system the disease might be incubated. When they came to consider that the discharges from the eyes, the nose, and the bowels of cattle all contained morbid matter in immense quantities; and that, if they took a small quantity of the matter, say, on the point of a lancet, and let it become dry there, it would be preserved for several days; and that then, by making an insertion of the lancet so soiled into the organism of the animal, they thereby effectually inoculated that animal, they could at once see what ready means there were of transporting the affection. A man going into a shed and putting his hand on the animal, or treading on the dung in the shed, and going thence to other animals, might carry this morbid matter, and thus be the means of communicating the affection. Animals that came in contact with a diseased animal might be a fruitful source of propagating disease. He thought therefore that, although we might not be able to trace the outbreaks in different parts of the country to the direct importation of diseased animals, we must not suppose that it was not in the ordinary manner a contagious disease. One of the best answers to the statement that it was epizootic was the fact that there were parts of the country altogether free from the disease, although they were adjacent to the great centres of affection.

Again, there was no doubt that the disease had been conveyed by persons to animals in some parts of the country. He might also mention, as an example of another source of danger, the fact that direct proof existed that the skins of certain animals brought to Taunton for the purpose of conversion into leather, had been the means of communicating the disease to living animals. This showed the wisdom of the regulation for burying the animals whole, and covering their bodies with lime.

We had good reason to believe that certain individuals had been guilty of the heinous offence of wilfully transporting the disease from place to place; there had been certain persons in the eastern counties who, for the purpose of buying at a low rate animals that were known to be fit, or nearly fit, for the butcher, had absolutely been the means of transporting diseased cattle to the neighbourhood, so that, by communicating the pest to some of the animals, they might buy the rest at a very diminished price, and thus get a large profit out of them. No language was sufficiently strong to condemn such conduct. It was further evident that other animals, such as cats and dogs, might communicate the disease from one farm to another. Then, the imperfect burying of the animals was a fruitful source of the disease; the holes having frequently been made so shallow that portions of the animals were scratched up by dogs, and taken to other places. In the

county of Hereford, some animals had been buried only just below the surface, by the side of a small stream, which was thus made the vehicle for carrying the disease from farm to farm in its downward course. It was therefore absolutely necessary to pay the utmost attention to the burial of the animals. He also believed that the disease had been communicated from one farm to another through the medium of pigeons. That had been the case particularly in Yorkshire; and as pigeons were not very profitable, the best thing to do in infected districts would be to get rid of such birds: indeed any birds may convey it, but especially those which frequent the homestall and yards. As regarded birds in general, the risk would be greater in the breeding season when the animals were out at pasture. If the sheep became affected, the starlings, which are in the habit of alighting on their backs, would become a source of danger.

#### PREVENTION AND ERADICATION.

With regard to the prevention of the disease, he feared that very little indeed could be done unless the infected animal could be so completely isolated as to prevent the matter coming from them finding its way to other animals. Strict isolation, therefore, was to be advocated before anything else. Much attention had been given to the use of disinfectants and various medicinal agents, some having for their object the fortifying of the animal's system against the influence of the morbid matter, and others for the destruction of that morbid matter within the organism of the animal before the disease could be said to have declared itself. With regard to agents fortifying the system or rendering it secure against attacks, he believed that up to the present time there was no satisfactory evidence. No doubt a vast number of agents had been used, and many of them greatly extolled, by persons who had arrived at the conclusion that because a certain number of animals did not show the disease, security had been afforded.

Among the communications which he had received on this subject was one from a gentleman in Russia, who said he had arrested the plague in that country by getting the animal to drink acidulated water, and that water impregnated with sulphuric acid was found to possess qualities by means of which the disease had been arrested. Well, acidulated water had been lately tried in this country, and in every instance had failed. Another gentleman stated, that he had used sulphuric acid in connection with sulphate of iron. This also had been tried to a considerable extent at his (Professor Simonds) suggestion. For, wishing to put no barrier in the way of prevention or cure, he had departed from the legitimate conclusions and dictates of medical science in regard to this great national question. The remedy had been tried in the county of Hants under various circumstances, and in every instance had failed to give the least security. Sulphate of iron, and even iron itself, had been tried, and that too had entirely failed.

Again, salt had been tried to a greater extent than any other prophylactic, and had also failed in every case to give security. Then there were other agents, termed antiseptics, which were supposed to

act upon the blood. The best of these perhaps were forms of sulphur—sulphites of potash and soda, and hypo-sulphite of soda. These latter had been tried in Kent and Surrey, and also in the Royal Veterinary College, without any beneficial results. He must admit, therefore, that all our means employed as medicinal agents had failed to give protection to animals against this malady.

It is almost useless to go into the question whether security could be given by vaccination; it has already been tested and found to fail; even if the disease had been of a variolous nature, it would not necessarily follow that vaccination would give security. There was a parallel instance in the small-pox in sheep; a disease so destructive that it might be considered to be as fruitful of infection as the cattle-plague among cattle, except that the infection did not extend so rapidly. Vaccination gave no security to sheep against this infection; nay, it could hardly be said that sheep were susceptible to the true vaccine disease. In making this remark, his object was to show that if we had a true variolous disease, it would not follow that we must be protected by vaccination itself.

With reference to disinfectants, a certain amount of advantage might arise from their use when the cattle-plague was in the neighbourhood. At the same time we must ask ourselves what we were really disinfecting. If we were guarding in certain ways against the introduction of noxious matter existing near at hand, and if we had a disinfectant lying outside the door where the animals were kept, so that every person who trod there might have his shoes brought into contact with it from day to day, we might then see a certain advantage to be derived from it. But to hope that any great advantage would arise from the use of disinfectants in sheds where there was no disease would be unreasonable. No doubt disinfectants were valuable in preventing the propagation of the disease when it had established itself on a farm; and he believed that in many cases the ravages by the disease in this country had resulted either from the non-disinfecting of infected premises or else from disinfectants having been not properly employed. The most extraordinary things that could possibly be conceived had been resorted to under the idea that they would disinfect the premises, and used in such a manner that they might as well have been dispensed with altogether. But on this question of disinfectants we were lamentably behind; and, unless something was done to secure thorough disinfection, he anticipated that there would be fresh outbreaks hereafter in different parts of the country, owing to the manure and refuse matter which had come in contact with the animals not having been disinfected. He could not, therefore, too strongly impress upon gentlemen the necessity of paying strict attention to this subject of disinfection.

#### MEANS OF CURE.

We had already observed that various medicinal agents had proved failures. Every means yet tried had failed to cure the disease, and we might have expected that such would be the case when we looked at the nature of the malady, and what had been the experience of Conti-

mental Europe in regard to its treatment. Prussia, the whole of Germany, France, and indeed the entire Continent, might be said to have given up the idea of curing the disease. It was hardly to be expected, therefore, that this country should possess a greater power of arresting its course by curative means, than the countries which had failed on the Continent. Considering the nature of the affection, and the laws which govern its spread, he had been of opinion from the first that it was not to curative means, but to strong preventive measures, that we must look for deliverance. Here he might allude to one curative means in particular that was now occupying the public attention, and which was regarded as so important that it was not unlikely to influence the decision of Parliament itself. The remedy to which he referred was that which had been introduced by Mr. Worms of Ceylon.

#### MR. WORMS' REMEDY.

It should be known to the meeting that Mr. Worms was a gentleman who was highly connected. He possessed a considerable fortune, and had for many years been engaged as a coffee planter in Ceylon. By marriage he was connected with the family of Baron Rothschild. Moved, no doubt, by anxiety to do all he could to arrest the progress of the cattle-disease, which he believed to be identical with a disease he was acquainted with in Ceylon, and having found that the disease existing in Ceylon had yielded to special remedies, Mr. Worms was also inclined to believe that he could arrest the disease by similar means here. The first opportunity he had of trying his remedy was in the case of some animals at Datchet. Those animals belonged to a farmer, and had been seen by a veterinary surgeon, who was inspector of the Windsor district. There were nineteen head which were subjects, as was supposed, of the disease, and these were all put under Mr. Worms' treatment. They were apparently somewhat relieved, and a paragraph appeared in the 'Times' and some other papers to the effect that these nineteen animals had been all cured of the affection. This paragraph came under the notice of Lord Leigh, who, having the misfortune to have the disease on his farm, telegraphed for Mr. Worms, who thereupon went down to Stoneleigh, where he had a certain number of Lord Leigh's animals placed under his treatment. Now, with regard to the nineteen animals which were said to have been cured at Datchet, he might say, without fear of contradiction, that not only had they not been cured, but that Mr. Worms admitted they were all dead. Mr. Worms was inclined to think, however, that their deaths had arisen from some mismanagement, and from his remedy not having been given in sufficient strength. Then, with regard to Lord Leigh's case, if he were correctly informed, one cow in an advanced stage of the disease was placed under the care of Mr. Worms, and that animal was said to have recovered. Twenty-four other cows were subsequently treated by Mr. Worms, and they also were said to have recovered. As to the cow for which a grave had been prepared, and which was spared in order that she might be treated by Mr. Worms, if he were rightly informed, the animal was, at the



time Mr. Worms first saw her, somewhat convalescent. At all events, there was a little abatement of the severity of the symptoms. He could not give this as the result of his own investigation, but he had been told it on pretty good authority. Moreover, he was told last Saturday that the animal so treated by Mr. Worms had afterwards relapsed, though what was the result of that relapse he did not know. With reference to the twenty-four animals that were separated from the rest of Lord Leigh's herd, he was also informed, on the same authority, that up to the time of his receiving the information not one of them had had the disease, that they had been removed from the sphere of its influence to a certain extent, and that the removal had protected them from the disease.

With regard to the third instance in which Mr. Worms' treatment had been tried, namely that of Baron Rothschild, he was thoroughly well acquainted with all the facts of that case. On hearing that there was a certain number of animals on Baron Rothschild's farm which had been affected by the disease, and had recovered in the course of a very short time by the use of Mr. Worms' remedy, he received instructions to go down at once to investigate the facts. When he arrived at the place, he was not so fortunate that day as to see Mr. Worms or the Baron himself; but having examined every individual animal, all he could say was, that of the ten reported cases of convalescence, he believed not one had ever had the disease; there was no evidence at all that any of the animals had been subjects of the disease. He went down again last Saturday, and had an interview with Mr. Worms, when he learned that the whole of the animals had been removed out of danger, and placed in sheds for treatment. Ten animals, which he had seen on the previous Wednesday, and reported as not having had the disease, were still perfectly free from it. Eight other animals, which had been picked out from the herd, as being subjects of the disease, he had carefully examined, and found that four of them were perfectly free from rinderpest. These cases were looked upon as convalescent cases. There was one other case of disease which had been overlooked; so that there were five animals altogether which had undoubtedly been subjects of the plague. One was taken ill on Friday, and at that time it was not a very severe case, and one other which had been taken in from the general herd was then suffering from it. On the Saturday night there were altogether five animals unquestionably affected with the disease. Mr. Worms was at the mansion; he had been there a day or two, and returned to London on Saturday. On Monday, he (Professor Simonds) went down with his colleague, and they reported that the animal which had been taken ill on Friday was dead, and that the other was dying; further, that four only of the animals which had been pointed out as cured of the disease had absolutely contracted the disease. Thus it appeared in these cases there was great reason to doubt whether the cattle-plague was met by this particular remedy; in fact, he was afraid we should find in the course of time that there was no larger number of animals saved by that remedy than by any other means which had hitherto been tried.

## THE DISCUSSION.\*

Col. CHALLONER: Would it not be well to substitute burning for burying, especially as fire is a great purifier?

Professor SIMONDS: Burning was tried in 1714, but it was found so offensive that it could not be carried out.

Sir JOHN JOHNSTONE, M.P., agreed with the Professor that it was to prevention, and not cure, that attention should be directed. Some persons had recommended the frequent washing of the nostrils or the mouth with certain antiseptics.

Professor SIMONDS did not think any advantage could arise from the application of tar, or some cleaner substance of the same kind, to the muzzle of an animal, or from the mere washing of the nostrils, seeing that morbid matter mingled with the atmosphere, and was inhaled with it. No doubt the disease might be said to be contagious; but the infectious matter mingling with the atmosphere affected animals within a certain range; and, considering that with every breath an animal might inhale a certain quantity of morbid matter, he could see no advantage from the application of an antiseptic to the mouth or nostrils.

Lord FAVERSHAM said another thing which had been tried in the North of England was the suspending of camphor bags round the necks of animals; in all the cases with which he was acquainted, the animals had escaped the disease, although it existed perhaps within a mile. Having heard of this remedy some time ago, he had recourse to it himself on two farms, and as yet none of his animals had had the disease, which was actually within half a mile of one of those farms. As regarded iron, the Professor was doubtless aware that the water of the district around Tunbridge Wells was strongly impregnated with that substance. He understood that the plague had not existed within

---

\* Professor Simonds has reported to the Privy Council the results of two subsequent visits to Mentmore on Feb. 22 and March 3.

On or before Feb. 22nd, with a view to limiting the number of cases, the unaffected animals (94 out of 119) "were placed in small lots in 9 different yards distant from each other, temporarily fitted up on the south side of a plantation" (these arrangements were good), and it was determined to try Mr. Worms' remedy on all these animals as a prophylactic agent. At that date Prof. S. reported respecting the 25 taken out for special treatment:—unaffected, 11; affected, but not severely, 5; dead, 5; dying, 4=25. On March 3, Prof. S. reported that the 11 regarded by Mr. Worms as having been enred, but returned by himself as unaffected on Feb. 22, had all been attacked, and nine had died; out of the whole 25 severed for treatment, 20 had died, and numbers 2, 8, 9, 11, and 19 were convalescent.

In the remainder of the herd a fearful havoc had likewise taken place. In one extemporised yard, out of 24 cows 10 were dying, and the remainder were more or less affected. "In the 8 other yards were 35 heifers, all of which were affected, several were dying, and 3 were dead." In sheds were found 5 heifers in a sinking state. In courts lay the bodies of 13 cows and heifers which had been shot, and two more animals were then under sentence of death. None of these animals were destroyed by the orders of the local authority. The general state of these animals was such that in a few days scarcely one of them may be expected to be alive. All treatment had been abandoned for some time, and the animals left to their fate. The disease had unhappily spread to other homesteads on the estate.—P. H. F.

ten miles of the Wells. He should certainly take one or two hints which the Professor had given, and especially that with regard to pigeons, of which he had some on his farm in Yorkshire.

Professor SIMONDS said camphor was not a disinfectant, though it gave out a large quantity of odoriferous matter. It might keep certain things out of woollen clothes, but he did not believe it would have the least effect as regarded the morbid matter of the cattle-plague. The escape of his lordship's cattle he attributed to the prevention of any communication with the infected places in the neighbourhood. He should not attach any importance whatever to the presence of iron in the water at Tunbridge Wells. It was only a parallel instance to the non-communication of the disease in other parts of the country, such as certain parts of Yorkshire and Northumberland.

Lord CATHCART said there was a French system of medical treatment founded on the use of camphor. It consisted, he believed, chiefly in the sticking of a piece of camphor in any part of the human body where a lodgment could be found for it. The author of that system laid it down that the essential principles of camphor and tar were the same, and contended that the best mode of treatment for cattle was the free use of tar and camphor water.

The burning of animals which had died of the disease had been tried at Malton, but the odour was so disgusting that it was necessary to discontinue the practice.

Lord BERNERS said, in some cases the ground was of such a nature that it was almost impossible to dig a grave six feet deep. It would be remembered that when pleuro-pneumonia was first raging in this country it was recommended that animals should be buried. He tried that in two instances in accordance with the recommendation laid down in that room—namely, that there should be six or seven inches of burnt earth, that the animal should be put on it, and covered with a great quantity of sulphuric acid; and there should then be a covering of from eighteen inches to two feet of burnt earth; and, lastly, another covering of common earth. Six months, after he had the place opened, and found one mass of apparently black vegetable earth. This he mixed with other materials as a compost for mangold and swedes, and he found it one of the best adjuncts any one could possibly obtain. Now he wanted to know whether the Professor thought sulphuric acid might be used in such quantities as thoroughly to decompose and disinfect an animal, so that it might be safely used afterwards as manure.

Professor SIMONDS thought the use of sulphuric acid would be a very effectual means of effecting the destruction of animals in pits in certain districts—rocky districts, for example—which did not admit of animals being interred at any great depth without a very considerable amount of labour. Supposing the bodies of animals to have been destroyed by means of sulphuric acid, he did not think any more harm could arise from the subsequent use of the decomposed parts mixed with earth, and so on, for agricultural purposes, than arose from the use of artificial manure. In a national point of view, that was a question of great importance. He feared that thousands of

animals must still be slaughtered, and if such a system were practicable with safety, it would of course be a great advantage.

LORD PERCY thought that Lord Cathcart had spoken of the use of camphor in a manner which was not quite warranted. For hay-fever camphor had been found very beneficial, and it might, perhaps, be useful in some cases to fortify an animal against cattle-disease.

LORD CATHCART did not intend to deny the medical value of camphor, but merely to point out that as regarded the treatment of cattle-disease tar and camphor were the same thing.

DR. CRISP said for the last fourteen years he had seriously studied the diseases of the lower animals; believing that they would never understand the diseases of man unless they commenced with the vegetable kingdom and worked upwards. It was in the lowest forms of organism that they would best read nature. The term rinderpest was a misnomer. The Germans believed that the disease was confined to the ox, but there was, in fact, not a ruminant in existence in which it might not be traced. He knew eight different species of ruminants in this country that had been affected, and it had prevailed in the Zoological Gardens. It was well known that at an early period it was conveyed by two gazelles which went from London to the Jardin d'Acclimatisation at Paris, in consequence of which forty-three different ruminants there were killed, and the disease was thus stamped out. Though Professor Simonds did not like to give the so-called rinderpest a name, thinking that they did not at all know what it really was, he (Dr. Crisp) would call it exanthematous fever—a fever affecting chiefly the lining membrane of the whole of the alimentary canal. There was in some cases an eruption on the skin, but it was one that bore no resemblance to small-pox. Considering that the length of the alimentary canal of an ox was about 150 feet, and that under disease the assimilative process was stopped, he would ask whether it was likely that such things as chalots and onions could have any influence on the progress of the disease.

He had received hundreds of reports with regard to alleged successful treatment. One gentleman in Scotland having had seventy animals attacked, grew desperate, it appeared, and took to drinking. He then left seven animals for some time in a shippin, where they could get nothing but water, and when he returned he found them recovered. If onions had been given to those animals, or if they had been under homœopathic treatment, it would have been said, "Here is a wonderful cure."

Professor Simonds touched very lightly upon dogs. He stated, indeed, that dogs would communicate the disease; but he said not a word about hunting. He (Dr. Crisp) would ask the Professor whether he did not believe that this disease was conveyed to a great extent by hounds running over different parts of the country.

Three members of the House of Commons were reported to have said that in their opinion the disease could not affect sheep. He (Dr. Crisp) believed, on the contrary, that thousands of sheep had been killed by it, and he had placed before the Lords of the Council ten or twelve examples. He had just received two letters giving additional

cases. One was from Mr. Barthropp, of Suffolk, who stated that he had just heard that some sheep had died on the farm of Mr. W. Scott, of Floxne, and that the disease had also shown itself among some sheep at Ixworth. A gentleman at Saffron Walden, on having been asked whether any sheep in his district had been affected with plague, replied "Yes; eighty-six in one lot, and forty in another." On learning from Mr. Barthropp that the plague had prevailed among sheep in Suffolk, he immediately took the train and went down to the farm of Mr. Denny, Battisford. The farmer there had had eighteen oxen, seventeen of which died. He also had 100 hoggets, which were kept so close to the oxen that their noses almost touched, and in a short time he lost thirty-five sheep. He (Dr. Crisp) examined those sheep, and felt certain that they died of the plague,—the fourth stomach was ulcerated, and had the spotted appearance which was so prevalent in the diseased ox; the intestines had that mottled look which could not be mistaken; and the rectum also corresponded with that of the cattle which had died of the disease. He had seen a sheep inoculated from an ox, and an ox from a sheep, and both animals had taken the disease. Surely that was the *experimentum crucis* as regarded that question. He believed that unless great care was taken, sheep would be the means of disseminating the disease to a fearful extent. It was decided in Parliament on the previous night that sheep might be driven along public roads, and he thought that it would be found that in that and other respects the new Act would require great alteration. Without more stringent measures it would be useless in his opinion to attempt to extinguish the cattle-plague.

Mr. FAWCETT (Staffordshire) wished to remark, with reference to Mr. Worms' treatment, that there was no novelty in the use of onions. He could give the names of persons who had used them in a similar form to that in which they were now administered almost for the last fifty years. Mr. Thomas Ewings, who lived near Appleby, in Westmorland, had used onions boiled with butter, and mixed with ginger, for cows after their calving. Neither was the use of asafetida new, the only effect of which would be to relieve spasms for a while. If benefit were derived from Mr. Worms' treatment it arose from carefully observing the breath, and taking the disease in good time.

It was very desirable to take the hay from animals when there appeared to be the slightest danger. When his hoggets were suffering, he noticed that those which discontinued eating recovered, while those that went on eating died. It was the same in milk-fever. If a cow commenced gorging itself within forty-eight hours after calving, it was a thousand to one that she would die. As regarded salt, he would remark that about twenty years ago, in consequence of having read some pamphlets on its beneficial effects, he gave it to a number of calves, and the result was that the whole of them went mad. He began by giving about a tablespoonful with each meal, and the quantity was gradually increased to four or even six spoonful a day. He did not consider salt worth a straw, either as a preventive or as a cure: it might, indeed, purify the blood; but he believed that vegetable matter contained a sufficient quantity of salt for that purpose.

Mr. SEWELL READ, M.P., said : As to cattle having recovered through not being allowed to feed when attacked with the plague, he might say that in his experience the animals were at the first stage of the disease shut up and deprived of all food, except in the shape of mashes, gruel, arrowroot, linseed-tea, and other kinds of nursing food, combined with the best medical treatment; yet they all died. He agreed with Lord Berners, that in rocky districts and the fens, the best course would be to cover animals with sulphuric acid. If in such districts an animal were at once placed in an iron tank and covered with sulphuric acid, that would be much better than an attempt at burial. Manure was such a bulky substance that it was impossible to disinfect it, and he would ask the Professor whether it would not be best to scatter it at once on the land, and plough it in.

Lord CATHCART said he was sure that landlords would all give up hunting if a general wish were expressed to the effect that it should be discontinued. He thought they were greatly indebted to the learned Professor for the clearness and ability with which he had treated this subject; and he would add that the decision which the Professor had shown in this matter, in common with the chiefs of the medical profession, and the forethought which they had evinced in relation to it, did them the utmost credit. He concurred in the opinion that there had been unquestionable instances of cattle-plague attacking sheep. He believed a very important application had been made of the thermometer, by which the disease had been discovered in its earliest stage, when it could be discovered in no other manner. Something had been said about Mr. Worms' treatment. He had heard from a neighbour of his who was for a long time in Ceylon, where Mr. Worms gained his experience, that the remedy in question was there by no means considered a specific. He understood that the plague was to a certain extent raging at Ceylon at the present time, and that cattle were actually dying on Mr. Worms' own farm.

The historical view of the learned Professor was very interesting, but he did not refer to one of the best authorities, namely, Lancisi, an eminent Italian physician of the seventeenth century, who, about 1690, wrote a most admirable work on this subject. He was moreover employed by the Pope to exterminate the disease in his dominions; and the result was that it was got rid of there much more speedily than in the rest of Italy, the means employed being simply the poleaxe and isolation.

The question of burial was one of great importance, especially with reference to the infiltration of wells. In one case with which he was acquainted, 29 dead cows were buried close to a spring which supplied a village with water; and the consequences of such a state of things might be most serious as regarded human health.

The Professor, in giving the history of the cattle-plague at former periods, alluded to an outbreak in Banffshire. From an old record of that outbreak it appeared that it was caused by the landing of some hay from a ship; and that was a very instructive fact.

He wished to say one word on the subject of statistics. Statistics were the anatomy of a nation; and he considered it a national mis-

fortune that this country had not agricultural statistics. At the present time they were generally collected throughout Europe; there were indeed but three exceptions—Spain, Turkey, and England. He hoped that, after what had occurred, there would be no opposition to their collection.

A great deal had been said about disinfectants, and they were much indebted to the Professor for his excellent remarks with regard to them; but he should have been glad if something had been said about Mr. McDougall's compound, which he (Lord Cathcart) had himself used. As to his own farm, he had made a sort of magic circle round it, and so far he had escaped the plague. It was, however, most important to bear in mind the capricious nature of this disease. Many persons have said in conversation, "Oh, I have had the disease, and I shall not have it again." Now, in the North Riding the cattle-plague, after killing a certain number of animals in a particular district, had gone away, and after a time (perhaps two or three months) it had returned and killed almost every head of stock. That had been especially the case in the neighbourhood of Malton.

As regarded railways, it had been shown, on the highest authority, that the conveyance of cattle by trains had caused the spread of the disease. No man could tell what animal was infected, and what animal was not. When there had been droppings on a particular part of a railway in the passage of the train, the animals on an adjacent farm might sniff and smell them, whether solid or liquid, and would any one venture to say that the plague had not been propagated to a great extent in that way.

Some persons said that the cattle plague was a farmers' question; but he (Lord Cathcart) would affirm that it was not a farmers' question so much as a public one. No one had alluded that morning to the importance of milk. Philanthropists and educationists might labour, but if children were deprived of milk, or had not a sufficient quantity of it for the formation of the bones, the constitution was sure to suffer, and the after consequences would be most serious. This consideration made this question not a farmers' question only, but a national one.

There was one other point which it was essential to observe—it was, in fact, the turning point in the discussion—namely, that confidence was a plant of slow growth in the agricultural bosom. They were asked why the disease was not dealt with in this country as it was in Aberdeenshire. The truth was, that stamping out was simply a question of money; and they all knew that money did not flow where there was not confidence. Moreover, they might stamp the disease out, but how were they to prevent it from returning? The only other point with which he would detain them—a point which he desired to impress on agriculturists generally—was the importance of the present. Now, if ever, was the time when something effectual might be done. If they put off action till the grass came, and the cattle had ceased to be tied up, he did not see what could be done. They must determine to work together as one man to get rid of this

plague, and all considerations that interfered with united action ought to be made to give way.

Mr. SPOONER stated that the five outbreaks which had occurred in Hampshire could, for the most part, be traced to bodily contact with stock imported from fairs and markets: though in one instance, near Bishopstoke, this explanation did not apply,—in that case a railway went through the farm. He then adverted to the Bill which has just passed through Parliament, and said it would in his opinion have been better, instead of imposing on juries or individuals the task of ascertaining the value of animals that had long been dead, to have given a fixed sum of 2*l.* for all animals attacked.

The CHAIRMAN said they all felt much obliged to the Professor for his kindness in attending that day and giving such a very excellent lecture. At the same time they could not but feel that he held out unhappily at present very little comfort; but he trusted that in the course of time more light would be thrown upon the manner of treating this disease or preventing its spread. He should be glad if the Professor would state whether he thought the plan which was now being put in force—that of stamping-out the disease by means of slaughter—was likely to prove successful. The head of stock in the country was of course limited, though it might be at present very large; and the future prospects of agriculture, as regarded the breeding of stock, must depend entirely upon whether this experiment was successful or not. He should be glad to know whether the Professor had turned his attention to the question whether it might not be necessary to make a complete cordon, to establish complete quarantine and isolation, in places where the disease had broken out.

Allusion had been made by Lord Cathcart to a French physician who advocated the use of camphor, as if that were a similar remedy to tar. During the prevalence of the plague of 1745, there appeared in the 'Gentleman's Magazine' an article containing a prescription of tar-water for the disease among cattle. Bishop Berkeley also recommended the use of tar-water; and he should be glad if the Professor would state whether, there being antiseptic properties in tar, it was useful in treating cattle-plague.

Professor SIMONDS replied that, as regarded the question whether the disease might arise spontaneously from the atmosphere, he could not for a moment suppose that to be the case. The origin of the disease was distinctly traced to animals that were brought to the Metropolitan Market from a foreign country. He might here add that at the time when the Society was holding its annual show at Plymouth (he was not aware of the fact till afterwards) the disease was actually in that town. One animal that was exhibited, afterwards proved to have been under the influence of the cattle-plague; so that they were in the midst of danger without knowing anything about it. As to the question whether they could get rid of the disease entirely by killing the infected animals without the introduction of cordons, he felt great difficulty in expressing an opinion. In Prussia he was himself told that if he went inside an infected district, as he desired to do, he



must remain till after the plague had disappeared, and for three weeks after the death of the last animal. In some cases the authorities of Germany had gone so far as to tar the roads, and in all cases travellers were compelled to keep outside the circle.

The CHAIRMAN observed that the words of the Prussian regulation were that the place should be as if it were not in existence.

Professor SIMONDS said he was told himself that if he went inside he would be obliged to receive all his food at the end of a pole, and that after receiving it he must place his money in a pan of water. Such restrictions could never be carried out in a country like this; but he did think they must have some very stringent measures in connection with the slaughtering of animals. It was true that they would now have a very great slaughter, and he hoped that that slaughter might exterminate the disease; but he was one of those who thought it would be necessary to establish very stringent regulations, and even perhaps to establish cordons. The meeting would excuse him for not entering more into that question, seeing that it had an important bearing on his position in relation to the Government. As to the range of the disease, he agreed with Dr. Crisp, that sheep, and indeed all ruminants, were in a greater or less degree susceptible; this did not, however, render the name "cattle-plague" inapplicable, for sheep are, properly speaking, cattle; but as regarded sheep they had this security, that they were less susceptible than bullocks, and, therefore, there were not so many doors of attack. This comparative insusceptibility secured a great number of flocks from the disease, and a larger percentage of sheep than of cattle recovered. After careful investigation, however, he was perfectly satisfied that not less than twenty-three flocks in this country had been subjects of the cattle-disease. The total number of sheep attacked in these twenty-three flocks was 3948, and the total number of deaths 2265; so that the number of recoveries was 1683. As to hunting, he quite agreed with Lord Cathcart, that if it were shown that hunting had been a means of propagating the cattle-plague it would be given up. In his observations he had endeavoured to avoid giving any opinions of his own, dealing with facts and facts alone; and he thought that many eminent medical men would have stood in a better position had they not been so ready to put forward their opinions, and he had no facts to show that cattle-plague has been spread by hunting.

With regard to Mr. Worms' treatment, there could be no doubt that the keeping of animals which were in a state of disease, and especially disease like the cattle-plague, from improper food was very desirable; but it must be borne in mind that, generally speaking, there was no appetite, and even if the most tempting morsels were placed before an animal in that condition, it would not partake of them. He did not attribute Mr. Worms' supposed cures to any special remedy; and he must say that he believed that proper nursing, combined with the use of such agents as would support the strength, and not overtax the digestive organs, was better than medical treatment. As to Turkish baths, and everything of that kind, they merely called for the exercise of a function which the animal had not sufficient

strength to exercise, and death was almost certain to take place within a very short time after the experiment.

The ploughing in of manure was a very important question. If the manure could be carted to the land at once, the process would be safe and easy; but then there were many farms and districts where that could not always be done. What would be the result of such an attempt in Buckinghamshire, or on the Middlesex clays, at this moment? Why it would be as much as they could do to cart the manure out of the yard, to say nothing about ploughing it in. On that point he thought the course recommended by Dr. Voelker would be found the best.







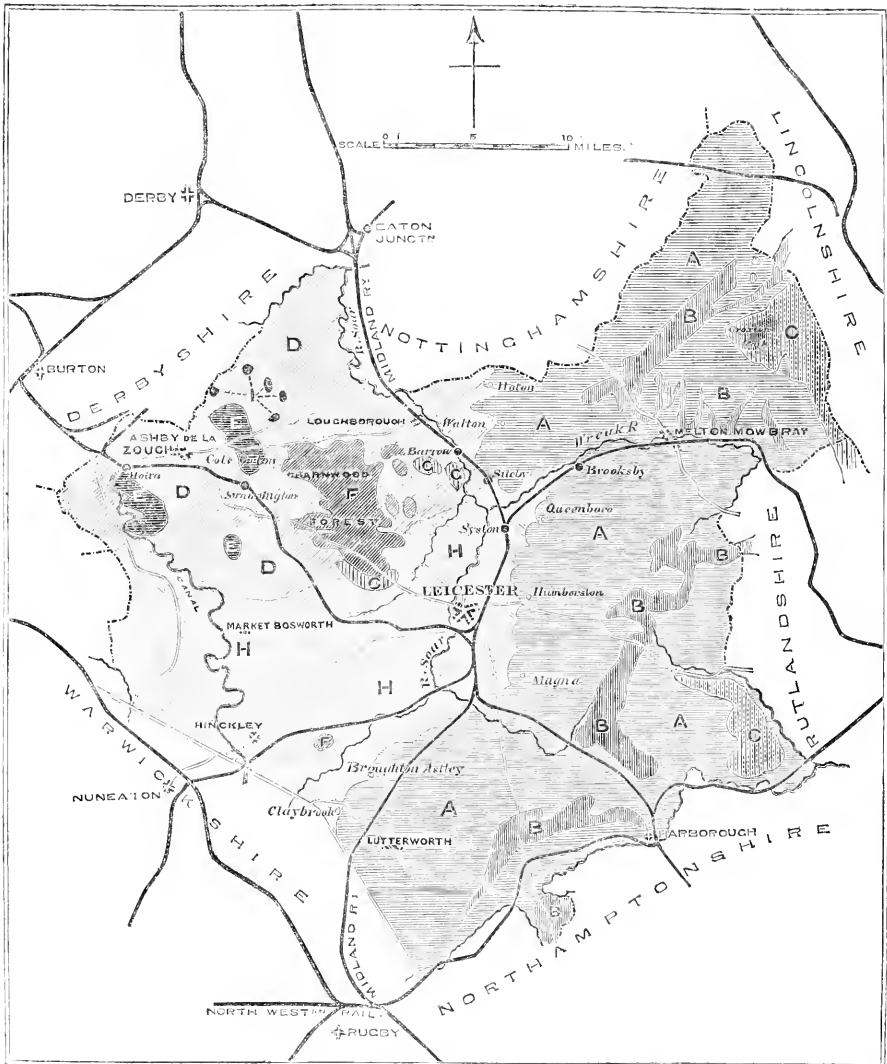

.

---



# MAP OF LEICESTERSHIRE,



- |  |  |   |
|--|--|---|
| <b>A</b>  Blue Marl (Belvoir).               | <b>D</b>  Red Brown Sandstone.        | <b>G</b>  Sienite { (Mount Sorel Stone). |
| <b>B</b>  Marlstone { (Belvoir Castle Hill). | <b>E</b>  Coal Fields.                | <b>H</b>  Red Marl.                      |
| <b>C</b>  Under Oolite. †                    | <b>F</b>  Igneous { (Cambrian Rocks). | <b>I</b>  Metalliferous Limestone.       |

XXII.—*A Report on the Farming of Leicestershire.*

By W. J. MOSCROP.

## PRIZE ESSAY.

LEICESTER, one of the North Midland Counties, is situated nearly in the centre of England. Its greatest length from south to north is about 45 miles, and its greatest breadth from east to west a little over 40 miles. Its mean diameter is about 30 miles, and it contains 522,240 acres.

Its means of internal communication are good; the length of roads has been estimated at 1730 miles, viz., 300 miles turnpike, and 1430 miles of cross roads; and towards the end of the last and beginning of the present century, further facilities were afforded by the formation of various canals.

Its first railway (the Leicester and Swannington) was opened in 1832, and since then the Midland line, with its numerous branches, has so improved the means of transit as, with one or two exceptions, to leave little to be desired.

One connecting link is wanted on the west side between Ashby-de-la-Zouch and Nuneaton, and another on the east side between Market Harbro' and Melton Mowbray. The latter would traverse the heart of the grazing district, and would essentially benefit the graziers and other residents; but, unfortunately, it would also intersect the famous hunting district, and when a proposition was made by Lord Berners and others interested in the welfare of this part of the county, it was met by the determined and successful opposition of the Gentlemen of the Hunt.

Leicestershire is divided into six hundreds, besides the borough of Leicester. The poor-law unions, parishes, and population, according to the census returns of 1861, being as follows, viz. :—

Unions.	Parishes.	Population.
Lutterworth .. .. .	37 .. .. .	15,515
Market Harbro' .. .. .	41 .. .. .	16,034
Billesdon .. .. .	38 .. .. .	7,272
Blaby .. .. .	30 .. .. .	14,171
Hinckley .. .. .	14 .. .. .	16,374
Market Bosworth .. .. .	31 .. .. .	13,428
Ashby-de-la-Zouch .. .. .	29 .. .. .	28,480
Loughboro' .. .. .	24 .. .. .	24,109
Barrow-on-Soar .. .. .	37 .. .. .	19,778
Leicester .. .. .	10 .. .. .	68,190
Melton Mowbray .. .. .	56 .. .. .	20,171
	<hr/> 347	<hr/> 243,522

The inhabited houses at the same date numbered 53,219, uninhabited houses 2704, and houses building 217.

The annual rental of the real property in the county, including land and buildings, as assessed to the Property and Income Tax in 1851, was 1,364,270*l.*; and as assessed to the relief of the poor, 970,375*l.* In 1861 the assessed yearly rental of the county to the Police and County Rates was 849,504*l.*

#### CLIMATE.

Inland situation, moderate rainfall, and absence of bogs and mountains, renders the climate mild and healthful, and the inhabitants frequently attain to great ages. In 1841 there were living in the county five persons each over 100 years old, and in 1851, 13 persons were returned in the census as above 95 years, 65 above 90, and no fewer than 1080 above 80 years of age.

According to Symons's Tables the rainfall as registered at Wigston, in the centre of the county, during a period of ten years, gives an average of 26·39 inches.

#### PHYSICAL FEATURES.

The surface-configuration of the county is beautifully diversified, consisting almost entirely of gently rising hills and retiring vales. The only high-lying land is in Charnwood Forest, where, though the elevation of the hills is inconsiderable, yet they possess a rugged and truly mountainous aspect.

“Bardon Hill,” the highest of the group, rises 853 feet above the sea-level.

Though well watered by numerous rivulets and small streams, the county cannot boast of any large rivers. The Soar, the most important, has its sources on the south side of the county, and flows north through its centre by Leicester and Loughboro' (from the latter forming a natural boundary between Notts and Leicester) to near Sawley, where it joins the Trent.

The drainage-water from the east and north-east of Leicestershire finds its way by the Great Wash and the Humber to the German Ocean; while that from the south-west is by junction with the Severn conveyed to the Atlantic.

#### GEOLOGICAL FEATURES.

The geological deposits of the county comprise the granite and trap rocks of the non-fossiliferous system, the Cambrian rocks of the Silurian, the coal measures of the carboniferous, the sandstones and marls of the triassic, and the lias and oolite of the oolitic series.

The earlier formations, the igneous and Cambrian rocks, are confined to the Charnwood Forest district, where they form a

series of rocky hills, covered in many places with an inferior soil.

The next superior strata are the coal measures, which appear on the surface to the west of the Forest, and form the coal-fields of Moira, Swadlingcote, and Coleorton.

North and south these are succeeded unconformably by the sandstones and marls of the new red sandstone, which occupy a large extent of the surface of the county, running north from the forest district into Notts, and on the south into Warwickshire.

To the east the marls are conformably overlaid by the lias, which extends north and south through the entire length of the county, with a surface-development equal probably to half its area, while at the eastern extremity abutting on Lincolnshire it runs under the oolite, which forms the surface-soil about Croxton Park, Saltby, and Buckminster.

The line of demarcation between the marls and lias may be traced by entering the county from Warwickshire near Nether Claybrook, from whence it runs N.N.E. by Broughton Astley, Magna, Humberston, Queenboro', to Brooksby Railway Station, from whence, crossing the Wreak, it bends west for about four miles, when a little south of Sileby Station it takes a N.N.W. direction by Barrow-upon-Soar, Walton-on-the-Wolds, Prestwold, and Hoton, north of which it clears the county.

By referring to the annexed map it will be seen that this line nearly halves the county, and in our description of its agriculture we propose to take it in these two parts; the soils of the lias forming our First or Eastern Division, those of the marls, &c., our Second or Western.

#### THE LIAS, OR EASTERN DIVISION.

The soil of the greater proportion of this Division is a clay loam, varying from the stiff clay to the friable soil. What is known as the "red land" is a soil derived from the marlstone, which separates the lower from the upper lias, the tops of several of the higher eminences being capped with it. Generally it is a light free working soil, mostly in arable culture, and well adapted for the growth of roots and barley.

The same description applies to the soils on the oolite on the east side of the Division, but their united area comprises only a limited space, and the great features are the tenacious soils of the lias, varying from the impermeable clay to the friable loam, according to the extent to which the clay is covered or mixed with the warp drift.

In Pitt's survey of the county in 1809 he states that "the

best soil is found on the hills, and the coldest and worst in the valleys," but his description will not apply to the present day; for, as a rule, the best and most fertile soils are seen in the valleys and long slopes where the warp-drift lies thick. On the summits of the hills the soil is inferior, but probably the poorest of all is found upon the sides of the steep hills where the drift deposit is only partial, or is wholly wanting, and the surface-soil is derived from the lias.

A large extent of this Division is in grass. Many farms have no land in arable, others have a portion varying from one-sixth to one-third. About the centre, and on towards the north, a small portion of the land (principally in small farms) is devoted to dairying; but the great bulk of it is grazed by fattening cattle and sheep, forming the great meat-producing district of Leicestershire, which contains some of the richest pastures in the county, or perhaps in England.

Nature has done much for these pastures, and although in individual instances she has been well seconded by Art, and these instances are undoubtedly becoming more numerous, yet it must be confessed that to the native excellence, rather than to any extraordinary pains bestowed on their improvement, is Leicestershire indebted for her surpassing fertility, and for the high rental—probably the highest of any county in the kingdom—received by her landowners.

Generally this heavy land lies in the high-backed serpentine ridge—an unmistakable indication of drainage wanted. Some of these furrows are very deep, the fall from the crown of the ridges varying from one to three feet.

Within the last twenty years much land has been drained, some re-drained, and much yet remains that would be greatly improved by draining.

The most prevalent practice has been to run the drains up the furrows, and where put in sufficiently deep, and not *too far apart*, the beneficial results have been great.

The cost of the operation is generally shared between the landlord and tenant; the former giving the pipes, and the latter providing labour to put them in. In some instances the work is performed under the supervision of the owner or his agent; others stipulate a certain depth, insisting on 4 feet, or withholding the tiles; while again some leave it entirely to the discretion of their tenants.

Drains are now rarely put in at a depth less than 3 feet, the general depth being from  $3\frac{1}{2}$  to 4 feet; but there is no question but that a few years ago much light and inefficient drainage was performed, and large sums of money comparatively wasted.

Caird gives an illustration of the occasional evil consequences



arising from the usual mode of conducting the drainage in this county, by stating an instance told to him "where the tenant, getting the tiles gratis, laid in a new drain immediately over the top of one previously put in, the defects of which he thus expected to remedy. The original defect was want of depth, and this was no cure. In despair the man resigned the farm, and his successor on commencing operations discovered first one row of tiles, and then a second beneath it. By going considerably deeper than the lowest he drained the field."

Says Mr. Caird, "How much disappointment and waste of capital might have been saved by the exercise of an intelligent supervision by the landlord at the first in the outlay of his own money."

When draining is required extensively (and there are few estates in this Division which either has not or does not require it) by far the best plan is for the owner to execute the whole work under competent supervision, and charge the tenant a fair percentage on the outlay.

#### SIZE OF FARMS, &C. &C.—FENCES, &C.

The size of the farms ranges from 50 to 800 acres, the sizes most general being from 100 to 300 acres; but there are many small holdings of from 20 to 70 acres.

The small farms are usually tenanted by dairy farmers, who in this district make the famed Stilton cheese.

In many parts of the district the hedges, and in some instances the fields, are thickly studded with timber-trees. Where trees are in moderation in a grazing district, perhaps no great harm can ensue, as their baneful qualities are in some measure balanced by their usefulness in affording shade and shelter in hot weather and in cold, but the extent to which on some estates they prevail renders them a very serious encumbrance, as they occupy much valuable land, and make a poor return for it.

The enclosures generally are of a fair size, varying from 5 to 50 acres, the sizes most common being from 10 to 20 acres, nearly everywhere fenced by huge whitethorn hedges.

The *Leicestershire Ox Fence* is seen in this Division in great luxuriance. It is formed by a double line of plants, and is allowed to attain a height of 10 to 14 feet, being cut and laid once in fifteen years.

When a hedge is cut the ditch is cleaned out, and the "browse" from the cuttings put in it to protect the young shoots, or a "prick mickle" is made on the top of the bank, which answers the purpose more effectually. On the other side, where

the brush is laid, it is usually protected by post and rails until sufficiently grown to hold its own with the cattle.

Of late years wire has been found an efficient substitute for rails for this purpose; but the innovation is by no means relished by the hunting gentlemen, and in many instances, to accommodate them, the farmers take it down during the hunting season.

The instances are very rare where any attempt is made by annual switching or trimming to confine those fences to a given shape or space, but laterally and vertically their extension is unlimited, until the time again comes round for cutting down.

A theorist or stranger from an arable district would at first be likely utterly to condemn these huge hedges, but a little acquaintance with the district and its management would enable him to see that a high fence, and a thick strong fence, is not only necessary, but when cattle are kept in the fields late in autumn and early in spring—if not during the greater part of the winter—it is actually indispensable.

The point worth consideration is, whether by annual trimming they could not laterally be confined to a moderate space, and at the same time trained to a form combining the height, closeness, and strength necessary for the shelter and confinement of the bullocks, and at an expense not exceeding the gain that would result from the space rendered available as pasture. The practice of Lord Berners, Mr. Burbige of Thorpe Arnold, and some others, who yearly trim a portion of their fences, which are excellent, shelter-giving, and bullock-proof, proves that this can be done, but with what economy there are no data to show. The probability is that the balance preponderates little either way; but surely the neat, cultivated, trim aspect which such a practice imparts to the country ought to turn the scale in its favour.

The ordinary fences, though in appearance rugged, are in general very good, the only exceptions being those in which hedge-row timber is abundant. Here, as a rule, they are very bad, and the expense required to maintain them in a state of efficiency is very considerable.

#### FARM MANAGEMENT.

Three different modes of farm management prevail, viz.:—  
1. Grazing; 2. Breeding, rearing, and grazing; and 3. Dairying. A brief detail of the practice of each will be necessary.

*Grazing Farms.*—Generally these comprise the richest and most fertile land in the Division; and although the winter accommodation for cattle is, as a rule, scanty, and indeed many hold-

ings may be found wholly devoid of farm-buildings, yet this description of farm is much sought after, and commands very high rents. Three pounds per acre is freely paid for those of good quality: such will graze and fatten a bullock weighing when fat from 50 to 60 imperial stones, and one sheep over 20 lbs. per quarter per acre during the summer months, and in winter will keep from 1 to  $1\frac{1}{2}$  sheep per acre.

The majority of these holdings have little and many have no land in arable culture, and unquestionably their freedom from the complexity and harassing cares incidental to arable cultivation is one great source of their attractiveness.

But although the details of management are simple, and the manual labour required little, yet skill and acquirements of a high order are essential to ensure successful results.

Much attention is required to properly graze and make the most of those pastures; for, although cattle do best on rather young grass, at least before midsummer, yet bare pastures and rapid fattening are incompatible; on the other hand, satisfactory grazing is rarely accomplished where the bite gets too long, and hence watchful attention and prompt action is required to hit and maintain the golden mean. To meet the extra flush of grass induced by a more than ordinary growing season, extra cattle, at whatever cost, must be purchased; while sales, perhaps at a disadvantage, or a liberal use of cake, must supplement the scarcity that results from a dry, ungenial season.

It is considered a very important point to keep the pastures well in hand *until midsummer*; where this is not attended to a certain waste and deterioration of quality takes place, for, until starved to it, all cattle refuse to graze the rough grass grown before this date.

Once a year, at least, all graziers with any pretence to a knowledge of their business consider it indispensable to graze their pastures bare. Rank, rough, coarse patches of grass will more or less invariably be found at the end of the season in the fattening pastures; and a few years ago the scythe was much used during the summer to keep these smooth; and hence the old saying, "You cannot graze without the scythe." By a few graziers this is yet occasionally done, but the more general practice now is to crop them off during the winter months with Scotch or Welsh runts, termed "gnawers."

The success of this gnawing process, like many others connected with grazing, depends much on judicious attention. A novice in the trade will crowd his cattle and keep them in one field until they shave it bare; and this is certainly the primary object in view; but loss of condition in his cattle is the certain result: while the knowing hand, by judiciously and frequently

changing from field to field, has always a sweet pasture, and by doing a little now and a little then, can attain by the beginning of March the same object as the other; and not only has he his pastures as smooth as a cricket-ground, but finds his "gnawers" actually improved in bodily condition.

One beast for ten acres suffices for this purpose.

To keep the pastures clean and sweet, to utilise the whole of the grass, and have it depastured evenly, the dung of the grazing animals is collected and taken off while fresh, and before it has had time to rot the grass, or act banefully as a stimulant.

An old man or boy with a wheelbarrow gathers it into small heaps, which by carts are conveyed to large ones, and there mixed with a small quantity of soil, ditch-cleanings, or road-scrapings; and the mixture during the autumn is re-spread on the bare or poor parts of the fields. November is considered the best time to put it on; harm ensues from deferring until spring, as cattle stubbornly reject the herbage thus produced.

After midsummer the gathering is supplemented more or less with "knocking;" that is, the dung, after lying a little to harden, is knocked or spread about.

This practice of collecting and knocking the dung on the pastures is practised by all, but most assiduously by the best managers. It is an admirable system, and well worth imitation by the occupiers of grass-land in every nook and corner of the country.\*

The thistles are generally spudded or drawn on all good land, and mown occasionally on that of a poorer description: good managers consider the latter as bad and slovenly practice, and much valuable keep is destroyed by it. The thistles are gone over twice in the season.

With regard to the meadows mown for hay, the practice is to mow a field one year and graze it the next. Some manure with the dung collected from the pastures, others use guano, "grass-manure," or lime and soil; but all these appliances are rather the exception than the rule, and the great majority depend on the year's grazing to restore the fertility impaired by the previous crop of hay—a mistake so obvious as to render argument superfluous.

In some instances the grass is cut by machine, but the more prevalent practice is to mow by hand. Haymaking-machines and rakes are in common use, but there is little that is peculiar in the process as here carried out.

Much of the hay is stacked in the fields, the ricks, or locally

---

\* This practice for many years has been followed on the home farm of H. S. Thompson, Esq., Kirby Hall, Yorkshire, and this is the only instance we know of out of Leicestershire.

“cobs,” being placed in or near to the fields where the grass grew.

The mode of thatching these “cobs” is peculiar, and leads to the inference that straw is more valuable than hay, so sparingly is it often used. The line of thatch scarcely extends half-way from the apex to the eaves, the remainder of the slope being wholly unprotected. Practically, however, little waste results from this; the top being thoroughly consolidated, and all the loose hay carefully pulled and raked off, the rain-water shoots off without penetrating the stack.

This admission applies only to properly built “cobs,” consumed during the first year; when allowed to stand more than one year, the holes apparent in the sides betoken the existence of waste.

The hay is consumed by the cattle in the fields, being spread about daily on the ground. Careful “foddermen” are in request for this; unskilful or careless ones causing very serious waste. But at the best the practice is a bad one, as with the utmost care a certain amount of waste cannot be avoided, and it is one of the many evils resulting from the want of a sufficiency of farm-buildings.

The grazier commences laying in his stock in March, from then buying as occasion offers up to May, by which time he will probably have got his required number. Those bought early get a feed of hay daily on the pastures until the grass affords a full bite.

Early in July the most forward will be fit for the butcher, when drafting out and selling commences, a certain number going weekly until November, when all that are then unfit to go as fat are taken into the stalls, *if there are any*, and are then topped out on hay and cake, commencing with 6 or 7 lbs. of the latter, and finishing with as much as 14 lbs.

A general clearance of fat stock is usually made about the beginning of January.

The sheep stock (yearling wethers) are usually bought in September and October, and on the best lands are run at the rate of  $1\frac{1}{2}$  per acre, coming out prime fat in May, June, and July, being drafted weekly as above described with the cattle.

Many graziers stock partly with lambs during the winter, a little cake or corn being given to them on the grass. In the early part of the season they are as stores run thick, but gradually get more field room as the wethers are sold off, and are fattened and sold in September, October, and November. Some run the lambs as stores all the first year, and fatten out early as two-shear.

Others buy a certain number of cull ewes from the store and

dairy farms, which they put to a Down ram, selling off fat during the ensuing summer both ewe and lamb.

Besides the cattle and sheep, a few young horses are also grazed, the practice being to buy foals in autumn and sell again the autumn following. Others buy yearlings at the same time, and also sell at the same time as those who keep foals. Two colts to a fair-sized field is about the number grazed; from six to twelve, according to the predilection of the occupier, being run on a 300 acre farm.

We are favoured with a communication from a first-class grazier in the Market Harbro' district as to his own practice, a brief quotation from which will further illustrate the management of this class of farm:—

“ This farm consists of 570 acres: 300 acres being rich grazing land, 180 acres useful store land, and 92 acres strong arable land.

“ 80 acres of the store land are used for meadow, 40 acres being mown each alternate year. A portion of the land so mown is manured with the dung collected from the pastures, and mixed with a little soil; lime compost being also occasionally applied.

“ As soon as the hay is carted from the fields, the store stock is turned in for a few days, to pick up any stray piece of grass or hay that may have escaped the scythe or rake, and then they are shut up for an ‘ eddish ’ to fodder, with cake, the fat cattle in the autumn.

“ The best size for a grazing pasture is about 24 acres, which, when fall stocked about the middle of May, carries about 20 head of cattle and 30 sheep; the former weighing from 80 to 100 stones (8 lbs. per stone), the latter from 10 to 12 stones each.

“ It is an advantage to have the sheep partly one and partly two shear, as the latter come out earlier than the other, and a regular draft is maintained the season through.

“ About 250 fat beasts are fed off during the summer, and 40 young beasts are grazed with the store sheep, to be wintered, and fattened the following summer; 30 more are bought in the autumn, making in all 70 head to winter.

“ From March to May, 180 are bought for summer grazing, and in April, May, and June, the 40 young beasts are bought to run on as stores, to winter fatten as above.

“ The stock wintered are taken to the yards at night, but turned out daily for a few hours to the fields.

“ Forward animals generally pay well for 5 lbs. of cake given in June and July; and when eating cake they are best in small fields, not more than 8 together.

“ 20 tons of cake are annually used on the farm, and in the end the best linseed cake is found the cheapest.

“ All the oats grown on the farm are consumed by the sheep and horses.

“ The winter flock of sheep are about three to two acres.

“ The best land has been drained at various depths, and the great benefit derived from drainage is, that in winter the land bears the feet of the stock, which clean up the grass, and the sheep do so much better with a dry lair.

“ The land when wet is ‘ hassocked ’ every year in December, the hassocks being cut with a square-edged spade, turned over, and fitted into the place whence taken out.

“ Thistles have been nearly eradicated by a system of constant spudding whenever they show above the ground.

“None of the stock on the farm is ever allowed to sink. I am inclined to think it would pay even on the *best* grass land to breed and rear much more extensively, as graziers suffer much loss from not being able to obtain cattle kept in a *fit state* for grazing purposes.

“The labour of this farm costs about 540*l.* per annum, being a little under 19*s.* per acre.”

*Breeding and Grazing Farms.*—The essential difference between this class of holding and the grazing farms already described is, that their arable land by supplying straw and roots enables the occupier to a certain extent to breed, rear, and fatten his cattle and sheep.

Generally the grass is of second-rate quality, and where there is much rearing there is seldom much fattening, unless cake or some other auxiliary is liberally used along with the grass.

The practice is necessarily more complex, and in bygone years the net returns have probably not been so satisfactory either to landlord or tenant as those from the better class of pasture devoted wholly to fattening. But the scarcity and consequent high price of store stock, together with the many risks of importing disease where all are bought, are tending somewhat towards a revolution, so that farms with a certain proportion of friable arable soil are regarded much more favourably than formerly, especially if the buildings are suitable, which, however, is rarely the case.

The extent of arable on these farms varies from one-third to one-half, the former being about the proportion in the south and middle of the Division, while, as we approach the north, many farms are found with one-half in arable culture.

The rotation of cropping on the strong soils is a five-course, viz.:—1. Wheat. 2. Barley or oats. 3. Fallow or roots—a crop of tares being sometimes taken before the fallow and consumed by sheep. 4. Barley or wheat. 5. Clover.

In some instances a six-course is adopted, viz.:—1. Oats, the stubble of which is manured and followed, 2, by Beans. 3. Wheat. 4. Fallow or roots, or bastard fallow after tares consumed by sheep. 5. Barley or wheat. 6. Clover.

On the lighter soils the four-course is followed, viz.:—1. Wheat. 2. Roots. 3. Barley. 4. Seeds. Or an extra grain-crop taken makes it a five-course, thus:—1. Oats. 2. Wheat. 3. Roots. 4. Barley. 5. Seeds.

As an illustration of the management current on these farms we give the practice of a tenant who sixteen years ago entered on a farm at that time considered a very poor one; but by drainage, the liberal use of purchased foods, and manures, full crops of all kinds are now grown, and the condition and value of the farm generally is very much improved.

In extent the farm is 450 acres, 100 acres being arable, the remainder grass. The rotation is a five-course one, viz.:—  
 1. Wheat. 2. Roots. 3. Oats. 4. Wheat. 5. Clover and beans.

Farmyard manure is applied to the wheat-stubble, and ploughed in deeply for roots, the plough being seldom used in spring, but  $2\frac{1}{2}$  cwt. Peruvian guano “scuffled in,” and the seed drilled on the stale furrow on the flat. Where mangold is grown double that quantity of guano is applied.

After horse-hoeing, the plants are set out by a man with a hoe, and the bunches singled by an attendant boy; the cost of the operation being 5s. per acre.

Part of the roots are conveyed to the yards for the cattle, and the remainder consumed when grown by fattening sheep.

The root-crop is followed by oats, drilled at the rate of 4 bushels per acre. Ten loads of dung per acre are applied to the oat-stubble, and ploughed in for wheat, guano at the rate of 2 cwt. per acre being sometimes substituted. For beans the wheat-stubble is invariably well dunged, and the bean-crop well horse and hand hoed.

The clover grown is always mown once, and frequently twice, for hay.

This rotation seems a scourging one, but nevertheless, as already stated, no deterioration, but great improvement, has resulted from its adoption; and the tenant says, “I have no hesitation in affirming that my 100 acres *now* produce much more corn than 160 acres which I had in arable fourteen years ago did.”

The wheat, and all other grain-crops, are drilled and hand-hoed; and reaping, which is done by hand, costs from 10s. to 17s. per acre in money, and one gallon of beer per acre.

The oats are mown and tied, at a cost of from 8s. to 12s. per acre.

Thrashing is usually done by hire of portable steam thrashing machines. The contractors—who find, in addition to the machines, two men, one to feed and the other to tend the engine—receive 10d. per quarter for oats, and 1s. per quarter for wheat.

Eighty head of fat cattle are annually sold off the farm, 60 head being purchased in spring, and 20 head reared yearly. Seven milch-cows are kept, each rearing three calves annually. The tenant would breed much more extensively if he had sufficient winter accommodation in his yards for young stock.

During the first winter the calves are fed on hay and straw chaff, crushed oats, cake, or a little meal. The second summer they are run on the store or inferior pastures, the second winter



having straw-chaff, pulped roots, and a little cake in the yards, and the third summer they are grazed on the best feeding land, from which in autumn they are sold fat.

As regards the other cattle bought for fattening, the same system is pursued as that described on the grazing farms, viz., they are sold fat from July to January.

The number of sheep kept average about one and one-third per acre the year round. A breeding flock of ewes are kept, the breed being a strong variety of the Leicester put to Lincoln rams. The produce is sold fat at two-shear. During the first winter the lambs are thinly stocked over the fattening pastures, having daily a little cake or corn. The second summer they are run thick on the store pastures, getting more field room as winter approaches, when occasionally a few are put to roots and fattened off; the remainder, having on the grass an allowance of cake during the winter months, come out fat from May to July.

The ewes are annually drafted, and the culls fattened off on turnips, or sold to the breeders of fat lambs.

Three hundred acres of the farm have been drained, the landlord providing the pipes and the tenant the labour. Much of this is done 3 feet deep, but that done recently has averaged  $\frac{1}{2}$  feet; the system has been to keep to the furrows.

During the present tenancy 100 acres have been sown down to permanent pasture, the poorest of the arable land being selected for this. That which was laid down about the beginning of the tenancy experienced the well-known falling off after the second year, but is now recovering, and, with help, promises to become tolerable pasture. Some other, laid down more recently, has maintained its vigour, and is likely soon to become useful feeding land. This difference is accounted for by the land being in a rich fertile condition, after better management both as regards stocking and manuring. The pastures generally have much improved, chiefly by drainage, secondly by the consumption of large quantities of cake, &c., by the grazing cattle, and lastly, by the attention paid to management in grazing, by cutting hassocks, collecting and knocking the dung, all of which are done well and in due season.

The hedges enclosing the arable fields are cut down low, and annually neatly trimmed, and the land cultivated close up to their roots, while the grass is divided by the huge ox fences before referred to. The height of one on this farm was ascertained by measurement to be  $1\frac{1}{2}$  feet, and the tenant argues that the value of the shelter afforded by them is incalculable.

The farm-buildings are very indifferent, and though doubtless in unison with those of the adjoining farms, are totally out of

keeping with modern requirements and the spirit with which the farm is conducted ; and the tenant would gladly pay a fair percentage on the outlay required for their improvement, but the owner is quite satisfied with the present state of things, and will not move in the matter.

*Store Farms.*—Another mode of management is occasionally met with on some of these farms of second-rate land, viz., the produce is wholly consumed by young growing cattle, which are sold in autumn as stores to the Lincoln and Norfolk dealers, and put to the straw-yard or stall, as age and condition render most suitable.

It has sometimes happened that young cattle sold to Lincolnshire for the winter straw have been repurchased in the spring by the autumn vendor, and after another summer's grass on the same farm again sold to Norfolk for finishing out in the stalls.

Some of the land of this description is held by arable farmers from other districts, who summer their cattle here, and remove them home to consume their straw and roots in winter ; and on many such farms no buildings exist, not even a cottage for the shepherd, and in some of the villages there are shepherds who are paid by the acre, and look over two or three of these farms daily, having a fresh master perhaps on each.

It is believed that those whose practice is "to store" all their land make quite as good or even better profits than others who on the same quality of land attempt to fatten, as no outlay for cake or other feeding stuffs is required ; but such a system must inevitably tend to the impoverishment of the soil, and consequently in the long run, or from a landlord's point of view, cannot be recommended.

*Dairy Farms.*—The third-rate and inferior pastures are chiefly thus used. Those in this Division are situated chiefly about its centre, and on by Melton Mowbray northwards, by Kettleby and Nether Broughton, &c.

Stilton cheese was first made in this district, and it yet forms a chief staple of the dairymen's produce.

This famed delicacy acquired its name by being first sold by Cooper Thornhill, who kept the "Bell Inn" at Stilton on the Great North Road, and who, by the assistance of his relation Mrs. Paulet, the first maker, was enabled to gratify the tastes of his customers at the rate of 2s. 6d. per lb. ; where the cheese was made was of course as long as possible kept a secret, and hence it obtained the name of Stilton.

The process of making is now in the district very generally known, but the receipt may be useful to those who in other parts may wish to try its manufacture.

"To the morning's new milk add the cream of the preceding

evening's milking, together with a sufficiency of rennet. When the curd comes it is not to be broken, but taken out carefully and placed in a sieve to drain gradually. As the whey drains off the curd is gently pressed till it becomes firm and dry, and then placed in a wooden vat, kept dry, and turned frequently. After being taken from the vat it is still kept in the cloth till quite dry and firm, and afterwards brushed repeatedly."\*

Another method is, to "take the milk of seven cows, and the cream of the same number; heat a gallon of water scalding hot, and pour it on three or four handfuls of marigold flowers that have been bruised a little, and then strain into your tub to the milk and put in rennet, but not too much to make it hard; put the curd into a sieve to drain, but do not break it, and as the whey drains off tie it up into a cloth, and let it stand half an hour or more; then pour cold water enough to cover it, and let it stand half an hour more; then put half of it into a vat six inches deep, and break the top of it a little to make it join with the other; then put the other half to it and lay a half-cwt. upon it, and let it stand half an hour, then trun it and put it into a press, and turn it into clean cloths every hour the day it is made; the next morning salt it, and let it lie in salt a day and night; keep it swathed tight till it begins to coat and dry, and keep it covered with a dry cloth a great while."†

The cows kept are principally the short-horn breed, and on some of the best land three acres is sufficient to maintain one cow the year round; while on the poor and inferior soils four and five acres are required to accomplish this.

The general management differs so little from that given in our second division, that to describe it here would be needless repetition.

About Burrow, and from thence north, some of the pastures are in a much neglected and unimproved state, some fields being covered with ant-hills, to the entire exclusion of all good and nutritious herbage. Drainage is much wanted. Thistles and other noxious weeds abound, and the care and attention bestowed on the grass-land in the south of the division is on many farms here totally wanting.

#### THE DUKE OF RUTLAND'S ESTATE

in Leicestershire is situated principally in this division, and through the kindness of his Grace's agent, Mr. Green, I am enabled to give the following account of it, which, considering its great extent—something like one-sixteenth of the whole county, will, I trust, prove interesting.

---

\* White.

† Pitt.

The estate comprises 39,600 acres, of which about one-half is strong loam and clay, of which the Vale of Belvoir, on the lias, forms the chief part, about 5000 acres beyond Leicester being composed of strong marl and gravel. The remaining half is about equally divided between white and red "creach"\* upon the oolite and marlstone formation.

The farms vary from 50 acres to 750 acres; the more general size is from 200 to 400 acres, the portions in grass and arable being about equal.

The arable land is cropped as follows, viz., on the strong soils of the vale a six-field system,—barley, clover, wheat, beans, wheat, fallow.

On the lighter creach the four-field, viz., wheat, turnips, barley, seeds; and on the heavier creach a five-course rotation,—turnips, barley, clover, wheat, oats.

Purchased manures are extensively used for the root-crops, and the straw in winter is consumed by cattle eating linseed-cake, and the clover and root-crops when consumed on the ground are also supplemented with cake or corn.

The corn and turnips are drilled, and several of the tenants use the reaping-machine, and improved modern implements are freely adopted.

Thrashing by steam is the rule, but steam-cultivation is as yet little practised.

The pasture-land is of average quality, a considerable portion of it good, and some very good.

Some years ago fields of grass were occasionally broken up for tillage, the practice being to drain, and then pare and burn. But little in this respect has been done of late years; on the contrary, in several parishes arable-land has been seeded down to grass, and though not to any great extent, yet the tendency has been, and is now, in that direction.

It is the practice more or less to manure the meadow-land, but hay-making is not to a great extent practised, except on those farms where the dairy forms the chief element of profit. But dairying is not a feature of the Belvoir Estate, and the greater part of the pasture-land is used for fattening cattle and sheep, and for rearing store stock.

The greatest improvement that has been effected on the estate within the last thirty years is the effectual underdrainage of nearly the whole of the strong lands. The drains put in range from 3 to 4 feet, and about 24 feet apart.

Generally the tiles have been given by the Duke, and the labour in putting them in done under the supervision of his

---

\* A local name for soil.

agents, and in most cases also at his expense, the tenants being charged a moderate interest *upon the cost of the labour only*; it is but in few instances that interest has been charged on the cost of the tiles.

Much of late years has also been done towards improving the farmhouses and premises, and the farms are few which have not sufficient accommodation in the shape of good buildings.

There is no formal agreement entered into with the tenantry, but the following Memorandum is printed on the backs of the rental receipts given when payments are made:—

“TAKE NOTICE—That the following are the conditions upon which you rent or hold the land and premises in your occupation under his Grace the Duke of Rutland, viz. :—

“1st. That the land is to be managed by you in a good and husbandlike manner, and the buildings, fences, gates, and gate-posts on the premises kept in good repair, the outfall drains and ditches properly scoured, and tunnels made under the gateways when necessary. And that in the event of your vacating the said land and premises by notice from your landlord or otherwise, you will be held liable to pay for any dilapidations occasioned by your fault or neglect in so managing such land, and keeping such buildings, fences, gates, and posts on the premises in good repair, and properly scouring out such outfalls and ditches, and making such tunnels when necessary as aforesaid.

“2nd. That no part of the premises is to be underlet.

“3rd. That no old pasture will be allowed to be converted into tillage without leave in writing.

“4th. That no hay or straw is to be sold off the premises except for his Grace's use, and then manure of equal value must be purchased and used thereon.

“5th. That no trees growing on the premises will be permitted to be lopped, or in anywise injured.

“6th. That on your quitting the premises all the manure will be considered as belonging thereto, and will not be suffered to be removed therefrom, or allowed for.

“7th. That the game and right of sporting over such lands is reserved to his Grace.”

The tenants are further protected by a liberal schedule of allowances as tenant-right for purchased manures, linseed-cake, &c.; and, moreover, it has become an established fact on the Duke's estates that the best security for both landlord and tenant is the mutual confidence existing, and which has for generations existed, between them.

The cottage accommodation on the estate is also very good. The old ones are fast disappearing, but on their ruins new ones, and in increased numbers, arranged with due regard to modern ideas of comfort, are erected. In several parishes this renovating process has been completed, or nearly so.

The greater part of the new cottages contain two rooms on the ground floor, and three bedrooms, and have a hovel, piggery, privy, &c., together with a small attached garden.

There are 155 acres of allotment gardens on the estate for the poor of the several parishes, each occupant having from one-sixth to one-fourth of an acre, exclusive of the garden attached to the cottage.

The rent charged to the labourers for the best houses, including about half a rood of land, is 60s. per annum.

The labourers' wages vary from 12s. to 15s. per week, ordinary men getting from 12s. to 13s. weekly.

In every parish there are a number of "cow cottages." In 1858 there were on the estate—

136 cottagers occupying 5 acres and under.	
141 " " above 5 acres and under 10 acres.	
88 " " " 10 " " 20 "	
49 " " " 20 " " 50 "	
<hr/> 414	

There were under a rental of £8 per annum .. .. .	759 occupiers.
above 8 " and under £10	52 "
" 10 " "	12 40 "
" 12 " "	15 49 "
" 15 " "	20 62 "
" 20 " "	50 115 "
" 50.. .. .	198 "
	<hr/> 1275

#### THE KEYTHORPE ESTATE

is also situated in this division of the county, and for many years its noble owner, Lord Berners, has devoted much of his time to practical agriculture and to the general improvement of this estate. He has always been regarded as a pioneer, and not unfrequently as the originator, of many valuable improvements.

Geologically, a considerable portion of the Keythorpe Estate is situated on the marlstone, a stratum separating the lower from the upper lias. On this, as on the bulk of the land in this locality, thorough drainage is the keystone to all other improvements.

Lord Berners states that his first attempts at improving his estate by drainage were made on the prevalent system, viz., he gave his tenants the tiles, which they at their own discretion put in the soil, his sole stipulation being that the drains should not be less than 3 feet deep. But, after going on so for some years, and spending several thousand pounds, he found the result so totally inadequate to the expense, that he determined to take the management of the drainage into his own hands.

The result of this determination was the inauguration of what is now known as the "Keythorpe System of Drainage," an elaborate account of which was given by the late Mr. Trimmer in the

Royal Agricultural Society's Journal, Series 1, vol. xiv. page 96. Divesting the subject of the scientific nomenclature in which he shrouds it, I purpose to give a brief description of the peculiar arrangement of the surface-strata,—the system of drainage which was devised, on the detection of this peculiarity, for its drainage—its cost and results.

The soil and subsoil of much of the Keythorpe Estate form a species of natural ridge and furrow, or alternating banks of porous and non-porous earth. These banks generally lie in the line of steepest descent, viz., the direction usually chosen by modern drainers (and no doubt wisely chosen where a uniform soil prevails) in which to run their drains.

As already noted, Lord Berners' first attempts at drainage were made in accordance with this, and he put his drains in the furrows (artificial) and in the line of steepest descent. The result, however, was disappointment. Much money and labour were spent, but the land was not efficiently drained. The reason why may be seen by referring to the accompanying sketch of a section of the surface-formation, where 1 represents the surface-

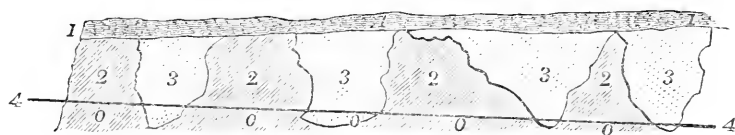

soil or drift, 2, the clay-banks, 3, the furrows of sand, gravel, or other porous soils; 0 represents the pipes put in, say by a modern drainer, with his pre-arranged ideas as to the depth and distance necessary for such a soil, and running his drains straight up the hill.

As shown per sketch at 0, 0, he might possibly commence his first drain in the impervious clay,\* his second might also be there, and, if his luck was good, he *might* hit a porous section with his third, and so on, hit or miss, as chance befell; and once in a porous or non-porous strata, there he must remain, *for they lie in the line of the fall*.

In short, it will be seen that the common system of drainage would be (and as Lord Berners proved it to be) on this peculiar formation a *failure*.

But mark how the Keythorpe system deals with it. The main drain is cut across the lowest part of the field to be drained, and,

\* This clay is so very impervious that a trial-hole in it did not yield water to a drain Lord Berners caused to be made within two feet of it.

says Lord Berners, “*examine well the section presented by this,*” as usually it affords a clue to the position of the porous furrows, and so to the successful drainage of the field.

The drains, instead of being carried in the line of greatest fall, and parallel to the natural banks and furrows, as shown, cross them diagonally, and consequently cut through, connect and drain them, as shown by the line 4—4.

The porosity is determined by trial-holes, so that no drain is put closer or carried further than is absolutely necessary to effect a thorough drainage.

Theoretically, this would seem perfect drainage, *practically* it has proved so; and as these furrows frequently contain very porous soils, the drains are put in at wide intervals, reducing the expense, on the average, to something like half that of ordinary parallel drainage.

Mr. Trimmer quotes the drainage of 398 acres as averaging 2*l.* 15*s.* per acre.

It will, of course, be understood that this system is applicable only where the above-mentioned peculiar surface formation exists; but that in other districts of the county and country it does exist, and that extensively, we have good grounds for believing; and surely the difference of cost between 3*l.* and that of the ordinary price paid for efficient drainage on clay soils—about 6*l.* per acre—offers an incentive for a more diligent search for its whereabouts than seems hitherto to have been made.\*

The day before I visited Keythorpe there had been a heavy fall of rain, but no stagnant water was to be seen on the several hundreds of acres over which I rode, and the land trod firm and sound, with every appearance of effective drainage.

Having no prejudice or bias either way, I feel the more bound to speak to these facts, because subsequently in other parts of the county I heard doubts expressed as to the success of the Keythorpe drainage.†

\* In districts where a doubt may exist whether the Keythorpe system is there applicable, it has struck me lately, when examining a piece of lupines on my farm, that this crop may afford a ready means for finding and gauging any beds of sand in the subsoil. The field I refer to has a chalky subsoil generally, and the crop in general became stunted and yellow shortly after it was sown; but two or three narrow strips that traversed the plot had a dark colour and vigorous growth; this enabled me to predict that bands of sand would there be found, and the spade verified my conjecture. I believe that the varying growth of the lupines in a field would be a *measure* of the extent, and in part of the depth of the sand-bed below, be the intervening ridges chalk or clay.—P. H. FRERE.

† On the day of my visit, after the rain alluded to, Fowler's steam-plough was at work in a field of stiff soil resting on a clay subsoil, and was making very fair work, a circumstance which would have been impracticable on badly drained land.



## THE RESULTS OF DRAINAGE.

The improvements effected by this drainage of the land, both on grass and arable land, has been very great. In some instances, on the grass land, where it has been followed up by top-dressing, and the consumption of cake and other artificial food by the animals depastured thereon, the annual value of second-rate pastures has been nearly doubled.

A field of this description in the vicinity of the Hall, in extent 16 acres, carried and fattened during the late summer 20 bullocks and 22 sheep, the artificial food given in addition being 1 lb. rapeseed and 1 lb. of steamed mixture per head per diem.

The amelioration of the arable is not less marked. The condition of a farm situated near "Robin-a-Tiptoes," which Lord Berners purchased and took in hand a few years ago, may be surmised, when we instance a field of oats purchased from the outgoing tenant, one half of which was so bad as not to be worth thrashing, the other half produced  $2\frac{1}{2}$  qrs. of very inferior grain per acre.

This field was drained and subsoiled, and in the following year, by the aid of artificial manure, produced a very fine crop of swedes and Norfolk Bell turnips, which were consumed on the land by sheep, a crop of oats following which averaged  $11\frac{1}{2}$  qrs. per acre.

The pastures on this farm (Tilton) were in quite as deplorable a condition as the arable, many of them nearly covered with ant-hills, and so wet and soft that the hunters could scarce gallop across them. These likewise were thoroughly drained, the ant-hills cut, carted into heaps, and burnt, a portion of the ashes being taken to the yards, and at last used as litter, making an excellent portable manure to drill for root crops, the remainder being carted and spread over the field. This, followed by judicious grazing with stock eating cake, &c., effected an extraordinary change in the character of the herbage; weedy, worthless plants disappearing, and their places being filled up with a variety of good nutritious grasses. From poor store land it acquired a useful fattening quality, and its value to rent increased 80 per cent. These are facts which need no comment.

Lord Berners' present occupation comprises 850 acres, 450 acres being in grass, the remainder arable. His usual rotation is a four-course one. Autumn cultivation he has practised for 40 years, and on this heavy soil considers it most important, as essentially contributing to the general success of the farming, as well as to the immediate growth of superior root crops.

Steam cultivation, which was adopted in 1861, has afforded

increased facilities for this. Fowler's self-moving engine and anchor were first tried, but owing to the hilly character of many of the fields other tackle has since been purchased, in order to work the stationary engine. Howard's cultivator has also been added, to which, by a cross iron bar, is attached Ashby's rotating harrows, thus—which are most efficient in cleaning the land, or preparing it at one operation for a seed bed.

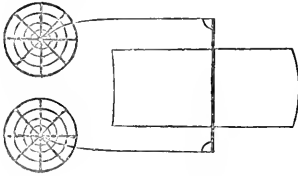

To supply the engine the drainage water is utilised, wells being made in the corners of the fields, or other points where it is likely to stand.

Owing to numerous breakages, the first year's trial of steam cultivation was not encouraging, but experience and a better class of duplicates soon met the difficulty, and the advantages arising from the use of steam in the cultivation of these stiff soils are very great. Economy, as compared with horse labour, better drainage, better and deeper comminution of the soil, facility for cultivating a large acreage in a limited time, better crops, are all attendant results.

Improved modern implements of all descriptions are in use on the farm. The corn is all drilled with Garret's drill and hoed with his horse-hoe. Reaping machines have been used since 1852, and found to economise labour very much, besides gaining time, an important consideration in harvest and hay seasons.

The cost of machine reaping, wear and tear, and interest inclusive, is about 7*s.* 6*d.* per acre, the prices paid for mowing and tying by hand averaging 10*s.* per acre.

Mowing and haymaking machines are in use, as is also the hay-cocking machine, invented by Sir John Tyrrel, of Boreham, Essex; the latter is especially serviceable in showery weather, for drawing the hay together into large cocks with great rapidity.

Some considerable portions of grass land of a second-rate quality have of late years been converted to tillage. The practice is to pare and burn the turf; the first crop being rape and white turnips, which are consumed by sheep on the ground, the second crop, also roots (swedes and mangolds), are again partly consumed on the ground. A stock of fertility is thus laid in, which subsequent judicious management retains, and from which full crops of all descriptions are obtained.

Lord Berners considers this to have been very advantageous to his occupation, as it provides roots and straw for the winter feeding, and accommodation for an increased number of cattle; besides, he finds when he wishes to let the land, that it com-

mands a higher price, being before second or third rate pasture land, whereas it *is now*, and with judicious farming *may* be maintained as fertile arable.

At about the centre of these arable pieces he has erected field-barns (we saw three) for the accommodation of a certain number of cattle, with a cottage of a superior description attached to each; keeping in view the possibility of those pieces being let off as farms, he has so arranged the cottages that some slight additions would convert them into dwelling-houses suitable for small occupiers.

The yards for the cattle are covered, being a series of parallel sheds; the mode of management is peculiar, and, as will be seen, good.

The shed roofs are high, and afford storage room for about 50 acres of corn, which in harvest is stacked or stored under them. A fixed thrashing machine occupies one corner, power being communicated by a portable engine. When the cattle require to be brought into the sheds, a section of the corn is thrashed, the straw being stacked up outside, and this affords room for a given number, and as thrashing proceeds, additional room for more cattle, if wanted, is provided; if not, it is used for storing the straw.

No attempt is made, by the usual mode of post and rail, to subdivide the shed internally, but the feeding racks are constructed so as to serve the purpose of *both racks and division fences*.

The Home farm buildings are plain and substantial, and with no pretence to show, additions having been made from time to time as circumstances required, but on the whole the arrangement is very convenient.

A fixed steam engine supplies power for thrashing, grinding, sawmill, chaff-cutter, pulper, cake-crusher, oat-bruiser, grindstone, &c. The straw is cut into chaff and steamed for food; the chaff-cutter being placed directly over the steaming tubs, the chaff when cut falls into them.

The mixing room is conveniently placed, the pulped roots are delivered into it, the meal store opens into it, the chaff is steamed in it, while it opens into a passage from which the cattle are fed. Feeding arrangements such as these could scarcely be improved on, were the buildings ever so costly or elaborate in style.

Some large parallel sheds adjoin the thrashing barn, capable of storing 150 acres of corn. From these the corn is pitched direct to the thrashing draw, which greatly economises labour. Again, in harvest, the corn, when once in, is quite safe from the serious risk of losses from getting wet before it is thatched, and the cost of thatching is saved.

In wet weather, when outdoor work cannot be done to advantage, *profitable labour*, viz., thrashing under cover, can always be found here.

The dung from the stables, cowhouse, and piggeries is thrown into a covered shed, on which we saw a number of pigs luxuriating, and no doubt turning to good account any stray grain or non-assimilated food that might have escaped the cattle or horses.

The manure from this shed is found extremely valuable, and is carted direct to the land, without being turned over, and if not ploughed in at once, is immediately covered over with earth.\*

The sawmill is conveniently situated, and the feeding appliances are novel, simple, and efficient.

Another extremely valuable contrivance is the utilisation of the waste steam from the engine to heat a floor on which is dried damp corn, green wood, &c., &c. The first cost of this was trifling, and the expense of heating almost *nil*; it is universally applicable wherever there is a steam engine, and would prove a great boon to any farmer who grows corn to any extent.

Separated from the main buildings by a road is the hospital for sick animals, and feeding-pens, with sparred floors, for sheep; to which has been lately added an implement-shed and granary, also a mill house, and shed for a portable steam engine, which drives two pairs of stones and a flour-dressing apparatus, to manufacture the flour for family use, for the labourers, and such of the tenants as choose.

The premises are lighted with gas manufactured thereon—a great convenience and economy; and very interesting it is to see, in the dusk of a winter's evening, the buildings lighted up, and the works progressing as vigorously as in daylight, which but for the gas must have been stopped.

*Sheep.*—A breeding flock of 200 ewes of the pure Leicester breed is kept, one fourth of which are annually put to a Cots-

---

\* Lord Berners puts great stress on covering up the manure when laid in small heaps on the land, and cites an instance where the labourers were overtaken by a thunderstorm while manuring for roots, the ridges being opened and the dung carted on and laid in small heaps. A portion was covered with soil previous to the storm, and the remainder left for a few days exposed, the manure and treatment being in every other respect the same, but the difference in the crops was most astonishing; where the manure was covered the produce was *nearly double*, nor did the difference end with the root crop, for the barley succeeding was also very much better on the covered manure. This scarcely accords with the scientific conclusions of Professor Voelker, who does not anticipate harm from exposing manure if spread on the ground. Lord Berners, however, is far too practical and acute an observer to allow us to have the slightest doubt as to his accuracy, and this is one of the instances where the teachings of science and the facts of practice cannot be easily reconciled.

wold, Down, or Lincoln ram, and the produce fed off for the butcher as shearlings. The other ewes are put to rams of pure breed, "theaves" from the produce being selected to keep up the flock, and the remainder fattened and sold as before, together with the draft ewes and upwards of 100 half-bred shearhogs, which are bought in.

This flock is an excellent specimen of the Bakewell type of sheep, and with symmetrical form combines size and good fleeces of wool.

The Leicester wethers have for some years been successful as prize-takers at the Smithfield Club and provincial shows, and the animals for exhibition this year possess great merit, one extraordinary fine sheep being among them.\*

*Cattle.*—A dairy of 15 cows is kept, their produce reared and fed off, in addition to about 80 Hereford and Shorthorn bullocks and heifers, and also 30 Kerry cows. These, together with the sheep and pigs, are chiefly disposed of in two auction sales, held in December and April. The cattle are fed on pulped roots and steamed chaff, and a cake of home manufacture, composed of Indian corn meal, bean mill, and other compounds, in proportions varying according to their relative cheapness or dearness, as fat or flesh formers.

The mixture is first well boiled, and then turned into a mould to stiffen, and given when a few days old.

*Horses.*—Six well-bred brood mares are kept, and their produce reared for the hunting field and the road.

25 cart-horses, chiefly Suffolk breed, and 2 hacks for the bailiff, are kept at the farm. On an average, 8 of these are employed for estate work.

By the adoption of steam cultivation the farm was enabled to dispense with 15 horses.

*Pigs.*—In these days of low-priced grain, pigs are an important feature of the Keythorpe farming. At the time of our visit a stock of 250 was on hand. Breed, the Suffolk and Yorkshire, and crosses from them,—a very profitable sort, combining fecundity, early maturity, and a great aptitude to fatten.

From the excellent arrangement of the machinery and buildings, the food is prepared and given at a minimum expense, and keeping in view the relative prices of grain and meat, it is extremely probable that this is a good paying branch of the farm.

---

\* The above was written in November, and at the Smithfield Show these sheep carried off all the first prizes in their class; and the gold cup for the best Longwools in the Show was also awarded to them.

## SECOND DIVISION.

IN this half of the county we have soils resting on the igneous rocks, coal measures, and red marls, consisting of many varieties, including clay loam on clay subsoil, marl loams, loams light and heavy on subsoils of sand and gravel; and a light-coloured clay on a retentive subsoil is frequently met with in some parts of the coal district.

Although in some parts clays of very close texture abound, yet generally a larger proportion of friable soils are found here than in our First Division, and consequently arable farming prevails to a much larger extent.

Leaving out the Charnwood Forest district, which demands a separate notice, we may state that one half is under the plough, the other half in permanent grass.

Grazing farms are occasionally met with, but dairying greatly preponderates; and while the pastures on the lias grow the beef and mutton, those on the red marls produce the cheese.

Generally the soils require drainage, and the system pursued has been much the same as that described in Division the First, although in some instances advantage has been taken of the porosity of the subsoil, and the object effected cheaply by drains placed deeply and at wide and irregular intervals. The expense has been met as before described, although there are exceptional instances of the landlord bearing the whole expense, and the tenant paying a percentage on it.

Much drainage has been done, and a good deal is yet required before the district can be said to be thoroughly drained.

The farms generally range from 150 to 300 acres. There are instances of 700 acres; but anything over 300 acres is rather the exception than the rule.

*Management of Arable Land.*—The rotation of crops varies. On the lighter soils a four-course is prevalent, and on those of a heavier and better staple a five and six course; while on some of the poor retentive clays a definite system can scarcely be said to prevail, and the farmer frequently crops not *as he would*, but *as he can*. The following are the rotations most usual, viz. :—

	1.	2.	3.	4.	5.	6.
Four-course ..	Turnips ..	Barley ..	Seeds ..	Wheat ..	..	..
Five-course ..	ditto ..	ditto ..	ditto ..	Oats ..	Wheat ..	..
Six-course	Fallow or turnips ..	ditto ..	ditto ..	Seeds ..	Oats ..	Wheat ..
Six-course	ditto ..	ditto ..	ditto ..	Wheat ..	Beans ..	ditto ..

Speaking generally, there can be no doubt but that within the last twenty years much progress has been made in the manage-

ment of the arable land. Antiquated and obsolete practices, however, yet linger on, but chiefly on the small farms; and as a rule the best management is seen on farms of fair size.

Root-crops are now regularly grown on land where a few years ago their production was thought impossible. This has been brought about by drainage, the introduction of portable manures, and the practice of autumn cultivation.

Some sow turnips on the ridge, some on the flat, and some few yet follow the barbarous system of sowing broadcast.

For autumn ploughing the general practice is with three and four horses tandem, and even in spring and summer culture this absurd custom is very prevalent.

Steam cultivation has as yet only met with a limited adoption. Lord Howe, at Gopsall, is a convert to the system, as is also his immediate neighbour, Mr. Clare, of Twycross. The latter gentleman farms spiritedly; and a brief description of his management will afford some interesting traits.

*Mr. Clare's Farm* is cropped on a four-course rotation, but after wheat two-thirds of the shift are devoted to turnips and mangolds, &c., and one-third to beans or peas; thus affording the means of alternating the fallow crops, and rendering their return on the same land less frequent. The greater portion of the young seeds is manured in the autumn with farmyard manure. This promotes a luxuriant growth of clover, and affords keep for an increased number of sheep, the extra manure from which tells most beneficially on the succeeding wheat-crop. Nor is the manurial benefit derived confined to the large extra amount of sheep-droppings, as the fact is well known that the root of the clover-plant bears a constant ratio to its stem, so that if a large amount of foliage is produced, we may feel satisfied that the root-growth is in exact proportion. Hence the practice is sound, and deserving imitation.

Towards the end of July, 2 tons of quick lime per acre are applied to the seed land, and it is then broken up with the steam cultivator. A sort of bastard fallow is thus made, and root-weeds readily destroyed, when shaken out and exposed to the scorching suns of August and September.

As soon as possible after harvest the stubbles are also broken up by the cultivator, and laid in excellent form to receive the full benefit of the winter's frost.

With a 10-horse power engine and Smith's tackle, 7 acres per day are got over by the men at their regular wages, and as an incentive to industry, 2s. 6d. per acre is paid to them for all they do beyond that quantity.

Two sets of farm-buildings have recently been erected on this

farm. A fixed steam-engine to drive the grinding mill and other machinery is placed at one of them.

A large quantity of grain is ground, and consumed by pigs, a numerous herd of which is kept.

*Dairy Farming* is the great feature of this division of the county. From 20 to 30 cows constitute a fair-sized dairy, although in exceptional instances these numbers are doubled.

To illustrate the management adopted on these farms we give the practice of an occupier near Market Bosworth, in the centre of the dairy district.

In extent this farm is 230 acres, 80 arable, the remainder permanent grass. 32 dairy cows are kept, the breed a coarse variety of Shorthorn; and here, as in the district generally, the quality has of late years been considerably improved by the use of well-bred Shorthorn bulls.

From May to December the cows are depastured in the fields. About the beginning of the latter month they are taken up at night, and turned out to the pasture during the day, their stall-food being a mixture of straw-chaff and pulped roots, seasoned with a little meal; hay or hay-chaff being substituted as they approach the calving season, about the end of February.

Although the failure of the root-crop did much to popularize chaff-cutting and pulping, the practice is yet by no means general, and in this matter this farm may be somewhat exceptional.

The cows calve chiefly in March and April, and are milked up to the second week of December, being dry on an average about three months.

Such calves only are reared as are required to fill the vacancies occasioned by drafting the old or otherwise unsuitable cows, one calf per year for every four cows kept being the usual proportion, the others being sold for veal, and to the grazing farms to rear.

The heifer calves reared have new milk until 14 days old, and are then introduced to porridge of oatmeal or linseed, but some give sweet whey, and others keep to new milk until weaning time. About the beginning of May, if the weather is dry, warm, and otherwise favourable, they are turned to grass; being brought up daily for the space of a month or six weeks for their porridge or other pail food.

On the approach of winter they have a little cake or meal, with hay and straw chaff, given in a shed in the corner of a well-sheltered grass field, to which they have free run; and this, which in some instances is varied with cut or pulped swedes and straw, constitutes their first year's keep.

During the second summer they are grazed on the store land,



and the second winter "done hard," having the run of the pastures, and in the case of a snow-storm a little straw, and if turnips are plentiful a few are given, but this is not the rule.

In July and August of their third summer they are put to the bull. They then receive during the winter the same food as the cows, and have their first calf about the beginning of May, being then a little over three years old.

The cows are drafted according to their suitability for the dairy, some going out after their first calf, while really good milkers are kept to 10 or 12 years of age. They are usually sold to the grazier.

Punctuality in the time of milking is considered an essential point, 5 o'clock A.M. and 5 o'clock P.M. being the usual hours. It is good policy to have a strong staff of milkers; on this farm one man to six cows is allowed.

The staple product of the dairy is whole-milk cheese, two being made per day, both in the morning, the previous evening's milk being added to that of the morning. Some prefer all new milk, and make one cheese in the morning and another at night. A very successful exhibitor at the cheese shows, who follows the former mode, takes great pains to prevent the cream from rising on the evening's milk, and attributes much of his success in the production of a superior article to his care in this respect.

The produce of cheese per cow depends much on the quantity and quality of the food, and varies from 3 to 4½ cwt., 4 cwt. being a rather high average.

From ½ lb. to 1 lb. of whey butter per week per cow is also made, the quantity varying according to the care exercised in making the cheese. By overheating the milk, or careless manipulation of the tender curd, an excessive quantity of butter passes into the whey; and its paucity is a good criterion of careful cheese-making.

The whey is consumed by pigs (though some give it to calves). This, with the butter, is valued at from 30s. to 50s. per cow per annum.

Pig breeding and fattening forms an important branch of dairy farming. The breeds are various, the Tamworth being a favourite. When pork is the object, meal is given along with the whey, and the pigs fatted and sold at 5 months old, weighing about 6 score lbs.

Those designed for bacon are, for the first 3 months after weaning, carried on as stores, their principal food being whey; and they are then fattened off, making from 10 to 14 score lbs.

On the farm referred to, about 24 porkers, averaging 7 score, are bred and fattened per annum.

Sheep are not a leading feature of these dairy districts, but on

every farm a small number, chiefly as adjuncts to the cows, are kept; usually a breeding flock. In some instances the ewes are bought annually and put to the ram in September. During the winter they have the run of the dairy pastures, a little hay being given in the case of a fall of snow. The most forward of the lambs are sold fat, and the remainder as stores; the ewes also being fattened and sold towards the autumn.

Others maintain a permanent flock, selling the wether, and keeping the ewe lambs to fill up vacancies. Sometimes the practice is varied by wintering the lambs, and selling fat as shearlings in the September and October following. On farms where the lambs are sold fat, about 30 ewes to 25 cows is the number kept.

The 80 acres of land on the above farm are cropped on a five-course rotation, viz., roots, barley, seeds, oats, wheat. The soil being very strong, 6 horses are required. The swedes and mangold are sown on the ridge, and white turnips drilled on the flat; for the former the dressing being farmyard and also artificial manure, for the latter one or the other, but seldom both.

The grain crops are all drilled, and either horse or hand hoed.

The reaping-machine is used, and found of much service, economising both time and money.

The oat stubble is broadshared immediately after harvest, and lime at the rate of 2 tons per acre applied and ploughed in for the succeeding crop of wheat.

The clover is mown for hay, as are also some watered meadows; the latter have been annually mown for the last 50 years without any appreciable deterioration, the only restorative applied being the water, which is turned on in November, or sometimes later, if at that time the grass is not eaten close down.

In this and various other districts of the county there is a considerable extent of water-meadow, but they present nothing new or peculiar in their management.

In spring the dung of the animals depastured during the summer and winter is knocked about, but the collection of the fresh dung from the pastures, as noticed in Division I., is rarely practised.

On some of the large farms in this Division the management will bear comparison with that of the best cultivated districts in any part of the country; the tenants being men of capital, who, although a lease for a term is quite the exception, in many instances invest that capital freely in the soil. I may instance Mr. Breedon Everard, who seven years ago left a 300 acre farm of Lord Stamford's, at Groby, when his stock, crop, and claims for tenant-right realised over 7000*l.* That his management was above par, we may safely infer from the fact that Mr. Packe's

Silver Cup, for the best-managed farm in the county, had been awarded to him shortly before. It would perhaps be difficult to instance a tenant at the present time whose investment approached 25*l.* per acre;\* yet that capital is freely sunk in the improvement of their farms by many of the large farmers here, is an undoubted fact, honourable alike to both owner and occupier.

*Grazing Farms.*—The farm and management of Mr. John Spencer of Odston fairly exhibits the most advanced practice on these farms in this Division.

Odston Hall, Mr. Spencer's residence, is situated three miles north of Market Bosworth, and possesses great historic interest as being the property and dwelling of Bradshaw, who presided at the trial of Charles I. The house has been refronted, but the internal arrangements are maintained as originally designed, and the rooms generally are in excellent condition.

The farm and house is the property of Lord Howe, the soil a deep rich loam on a strong marl subsoil, and in extent 400 acres.

210 acres are in permanent grass, and 190 acres in arable, cropped on a six-course rotation, viz., oats, wheat, roots, barley, seeds.

For wheat after oats, the cultivation commences as soon as possible after harvest, by skimming and harrowing the stubble, after which it is left until the braird of the shed-oats and weed-seeds is effected. In some instances lime, at the rate of 3 tons per acre, is applied as a manure for the wheat, and is now spread on the land and ploughed in with a 6-inch furrow. The wheat is drilled 10 inches apart, at the rate of  $1\frac{1}{2}$  to 2 bushels per acre.

A few years ago this application of lime was the general practice, but latterly more portable manures have been, to a great extent, substituted; Mr. Spencer's substitute being  $3\frac{1}{2}$  cwt.  $\frac{1}{4}$ -inch bones, and 5 cwt. salt per acre. Commercially, he considers this change to have been beneficial, his crops being quite as good, while the outlay, calculating the heavy expense of lime cartage, has been less.

In preparing the land for root-crops, Hancock's pulverising plough has, to a considerable extent, been very successfully used. The stubbles are scuffled and cultivated immediately after harvest, the root-weeds picked off, and the annual seeds vegetated; farmyard manure, at the rate of 20 loads per acre, being then spread on, the pulveriser-plough drawn by five horses covers it in, and the spring cultivation confined to harrowing.

---

\* That being nearly the amount invested by Mr. Everard, as related by himself to the writer.

In the absence of farmyard dung, Griffin and Morris's artificial manure, at the rate of 6 cwt. per acre, is sown broadcast, and the seed drilled on the flat at 20 inches apart.

The crops of roots grown by this process are excellent, and, as will be seen, at a minimum expense.

Another plan was tried last year with very encouraging results, viz., the land after the autumn ploughing was ridged, manured with farmyard dung, and the ridges split to cover. In spring the seed was sown on those stale ridges, producing a beautifully even braird of plants, which grew into a very heavy crop of swede turnips.

Mr. Spencer's great aim in root-cultivation is to do all the cleaning and weeding of his stubbles in autumn, confining the spring cultivation to a simple harrow or light dragging; he thus secures the finest tilth with abundant moisture, followed by full and vigorous brairds of plants.

A crop of turnips is frequently got by breaking up in June a portion of the land in two-year seeds. This is accomplished by the pulverising plough, which gives the necessary tilth at one operation; and the seed, with a little of Proctor and Ryland's turnip manure, is drilled on the flat at 18 inches apart. Very fine crops of white turnips are grown in this way, which, consumed by sheep, leave the land in first rate condition for the succeeding grain-crop.

The root-crops are all horse-hoed and hand-hoed, the setting out being performed by men, followed by boys, at a cost of from 6s. to 7s. per acre.

The white turnips are consumed whole by the sheep, but the Swedes are cut with Gardner's Cutter, and along with the roots the sheep have a liberal allowance of cake or corn.

Where the position of the crops will admit, reaping by machine is done, at a cost of about 6s. per acre, binding included. Where the crops are laid, mowing and binding is done for about 8s. per acre.

Ploughing is usually performed by two horses abreast, excepting the deep autumn ploughing for roots, or when the pulveriser is used.

The hours of horse labour are from eight to four o'clock. In summer they are depastured on grass with oats and beans, or Indian corn; and in winter they have bruised oats, at the rate of  $1\frac{1}{2}$  bushel per week, with hay or straw-chaff *ad libitum*.

A portable engine supplies power for thrashing, grinding, chaff-cutting, pulping, &c., the arrangement being both simple and convenient.

The management of the grass-land is conducted in a very masterly style, cake and corn being largely consumed; so that

while a large number of cattle and sheep are fattened, a gradual improvement of the pastures is effected.

The cattle are all bought in annually, between October and May, the number fattened varying from 130 to 150 head. When purchased they are selected according to condition, and divided into three lots; the best and most forward getting a richer description of food, viz., a little more hay cut among the straw chaff, a little more pulped roots among that chaff, and a more liberal allowance of meal or cake. No. 2 are carried forward through the winter or spring months in a good store condition; while lot No. 3 are general scavengers to the whole, being turned out through the day to gnaw the rough pastures, and at night brought into the yards, where they have the offer of any refuse food from the cribs of their more favoured neighbours.

Thus all goes on in order and with economy; everything is utilised, and there is no waste. All the hay and straw is cut into chaff, and all the roots pulped.

Selling commences about Whitsuntide, some of the most forward being then fit for market, and continues up to Christmas, at which time a total clearance is effected.

Three hundred fat sheep are annually sold, the breed a cross between the Leicester and Shropshire Down.

A small flock of breeding ewes are kept, the remainder being bought in as lambs in September and October. A portion of the lambs have the run of the pastures during winter, getting daily, in addition, an allowance of cake or corn; and the whole are fattened off the following summer and autumn on the pastures and turnips.

About 50 acres of grass are annually mown for hay, the whole being irrigated from a stream passing through the farm; the trenches prevent the use of the mowing-machine, but the hay-maker and horse-rake are used.

Great care is taken to properly graze the pasture, and the rough grass left in the fattening enclosures is gnawed off during the winter. The dung is all collected, and treated as described in our First Division.

The primary object in view is to keep as large a head of live stock as is possible; and little of any other grain but wheat is sold in the raw state; but, together with the large quantities of cake purchased, it is converted into, and goes to the market in the shape of, beef and mutton.

The practical result of this is that the increase of stock ensures an increase of manure, and a consequent improvement in the condition of the farm; and let us hope that the late and current high rates of fat stock have also improved the condition of the purse

of the farmer to an extent commensurate with the spirit, skill, and liberality exhibited in his management.

#### CHARNWOOD FOREST.

About the centre of this Division, at the outcrop of the igneous rocks, is situated Charnwood Forest, which may be termed the mountainous district of the county. It contains about 18,000 acres, and lies between Leicester, Loughborough, and Ashby-de-la-Zouch, extending to within four or five miles of each of these towns.

Formerly this large tract was common land, and comparatively waste. Pitt records Bakewell's opinion of it, "that it was actually a loss to those who had exercised the privilege of turning stock upon it, and argued that if one man turned his cow on it in the spring, and another man at the same time turned his cow into a farmer's enclosure, and paid him 1s. 6d. per week for the keep, both being of the same value, and both being driven to the market at Michaelmas, the difference of price would more than repay the expense of the keep; and that in the case of sheep, the difference would even be greater."

An Act of Parliament for its enclosure was obtained in 1808, but the award for its allotment was not signed till 1829. With the exception of some 400 or 500 acres, it has been reclaimed, and fenced, and cultivated.

The soil varies from a light peaty variety to a friable red loam, stones being more or less interspersed with it; and though some of the poorest land in the county may be found here, yet the improvement effected since Pitt's survey has been very great, and the value of the district generally has been increased not less than fourfold.

Owing to the great quantity of stones with which the surface abounded, the expense of drainage and reclamation was very great, varying from 10*l.* to 20*l.* per acre.

The *modus operandi* of reclamation has been to plough, where not too strong, or to turn over with spade and pick. For the latter generally two men work together, "nicking" about a yard in length and 18 inches in width of turf, turning it over, getting out the stones, and then throwing the soil on the top.

Mr. Shield, of One Barrow Lodge, who farms on 21 years' lease, has reclaimed during the last few years upwards of 70 acres, besides improving much that had previously been badly done.

For this purpose he had a huge plough made of oak, banded with iron, to which he attached eight horses. Three, and some-

times four men were required to hold and steady this plough in the ground, and six or eight more with pickaxes and bars followed to get the stones from the furrows, which were 18 inches wide, and 10 inches deep; and when those of a size too large to get out by this means were met with, they were marked, and afterwards broken and removed.

Naturally the soil is springy and wet, and much of the drainage at first put in was too shallow, or has become so from the sinking consequent on the consolidation of the soil and the frequent removal of stones, which are gathered off in each rotation. Stones were extensively used for the first drainage, but where re-drainage has been done tiles have been put in; although much land has been re-drained, there yet remains much requiring it.

The subsoil varies very much; in the same field may be found marl and sand, mixed and separate, a poor yellow clay full of stones, and a sort of moor-sand pan which can hardly be picked through.

The expense of reclamation has been met in various ways; sometimes by the tenant holding long lease, and at others by the owner.

Mr. Perry Herrick, who owns a considerable part of the forest, gave his tenants 10*l.* per acre for reclamation, and then charged them rent at the rate of 20*s.* per acre for such land reclaimed by this money.

After reclamation as above, the land was limed and sown with oats, which usually yielded a fair crop after the lime. The next crop is also oats, and generally better than the preceding. Lime is then applied again, and followed by a good crop of wheat, and the next year it is fallowed; the usual rotation, a 6-course, then follows. About 2 tons per acre of lime is the quantity usually applied.

The above was the practice of Mr. Shield and other good and judicious managers; but there are not wanting many who have cropped as long as any turf was left or corn would grow, so thoroughly impoverishing the soil that it became a costly process to get it into condition again.

The usual 6-course rotation consists of, first, roots; the swedes being sown on the ridge, and the white turnips *broadcast*. Both farmyard manure and artificials are in some instances applied to the swedes, but more generally either one or the other singly. Good crops are obtained, the subsoil being cool, and the higher range of elevation attracting many showers, which do not reach the lower lands.

Part of the roots are consumed on the ground by sheep, and

the remainder drawn off for cattle; but in some instances, more especially on the small holdings, all are drawn home, too often day by day, no provision being made by storing for frost or snow.

Barley is sown after roots, followed by two years seeds, the first year mown, and the second grazed. Oats follow the seeds; and wheat, completing the rotation, succeeds the oats, lime being spread on the oat-stubble and ploughed in. Breaking up seed-land for wheat has been tried, but seldom with success. The farms vary from 50 to 300 acres, the larger ones being very conspicuous by better management.

The harvest, which a few years ago used to be a month later than on the adjoining low-lying lands, is now only a few days behind, a circumstance undoubtedly owing to better drainage and more vigorous management.

The number of horses kept per 100 acres of arable being about four, the winter ploughing is done with three horses, but for fallow culture two is quite sufficient; in some cases, however, a great waste of power ensues from attaching them in line. On the more elevated points of the Forest there are very healthy and thriving plantations of larch, Scotch fir, &c.; towards Bradgate there are some healthy oak woods.

On many of the farms the buildings are insufficient, and nearly all want spouting. Much improvement in this respect has lately been done on Lord Stamford's property, and much is still *being* done on that of Mr. Perry Herrick.

Dairy farming is followed, cheese being made from cows consuming the second year's seeds, and whatever permanent grass there may be.

A flock of Leicester ewes is also part of the stock on the larger farms, and the number of late years has been on the increase, the produce being purchased at a year old at Leicester May Fair by the graziers from the east side of the county.

On the west side of the district some very extensive stone quarries are worked by the firm of Ellis and Everard.

The Bardon Hill quarries yield a close-grained porphyritic stone, famed throughout the county, and far beyond, as a first-rate material for macadamised roads.

When quarried the stone is conveyed down an incline by gravitation to powerful crushing machinery, on a principle similar to Crosskill's bone-mill, which admirably fulfils its purpose. A fixed steam-engine of 35 horse power supplies sufficient power to work two machines capable of properly breaking 170 tons of stones per day.

The Markfield stone is syenite, a species of granite, which



differs from the true sort by the absence of mica. The stones from this are cut to form streets, immense quantities being sent to London for this purpose.

On the average about 150 men are employed at these works, the whole being managed with much skill by the junior partner, Mr. Breedon Everard, whose farm we have noticed.

#### PASTURE LAND.

The farmer's chief interest in this county centres in the pastures, which occupy one-half at least of its entire area.

"Their history," writes the late Mr. Gisborne in 1849, "is singular. A generation with which many of us who are still in green old age have had personal intercourse, saw these upland pastures in the state of ploughed common fields, the enormous ridges having been produced by centuries of upward ploughing." "When enclosed and devoted to pasture, these lands were not sown with artificial grasses, but were left to acquire the turf with which it pleased Nature to clothe them." For forty or fifty years they improved progressively; from that time they have been stationary at least, if not retrogressive. Except a little and generally very imperfect soughing, they received no improvement. Some graziers, to be sure, have diminished the size of their fields by subdividing, and some have increased it by grubbing up fences; and no doubt such spirited men were in this British Bœotia considered to be improving farmers. But "adhuc sub iudice lis est." The real improvements in agriculture passed by these men, or were brought to their doors without exertion on their part.

Furthermore he says: "A few years ago we should have looked for the least improved district of agricultural England from the top of Robin-a-Tiptoes," (a conical hill of considerable eminence near Tilton-on-the-Hill.) "No prospect, in an agricultural point of view, could be more melancholy. Large spongy pasture-fields, so encumbered with vast ant-hillocks that nothing but an accomplished hunter could gallop among them with safety, bounded by rambling fences—land of considerable power and inconsiderable produce. 'I went by the field of the slothful, and lo it was all grown over with thorns, and nettles had covered the face thereof, and the fence thereof was broken down. Then I saw and considered it well; I looked upon it and received instruction.' " \*

This not over-complimentary description of the graziers he attributes to the fact of their enjoying a monopoly in the production of beef,—stall-feeding being then in its swaddling clothes.

---

\* 'Quarterly Review,' No. clxviii, p. 419.

But, doubtless, these remarks were intended to apply retrospectively, for though few will dispute that the improvement in the management of grass has not kept pace with that of the arable, yet those old enough to remember, and perceptive enough to remark, date from 1833-5 the general progressive movement which since then has been in operation throughout the county.

True, we look in vain for that very liberal treatment which has effected results so important on the second-rate lands of some other counties; indeed, to many farms, Gisborne's description of his view from Robin-a-Tiptoes may yet be applied with much justice; yet this does not affect the fact that the little leaven of improvement first apparent about the aforesaid date has been gradually increasing and quietly making its way, so that no doubt it will ultimately "leaven the whole lump."

Drainage, admittedly the greatest of all fertilisers, has in some instances, where followed by top-dressing, increased the value of the grass-land by 50 per cent.

The consumption of cake by the animals grazing thereon has of late years been largely on the increase, its effect being to produce better grass and more of it. The *best graziers*, by waging, as it were, eternal war, have reduced to a minimum thistles and other worthless and noxious plants. So also with ant-hills, the pest of the poor land of the county, and to the hassock (*aira cæspitosa*), the pest of its damp furrows.

The care exercised in the removal of the dung, as already detailed, must complete our catalogue of effected improvements.

But on the other hand, there yet remains much land that loudly calls for drainage. There are thousands of acres of a second-rate quality which liberal and judicious manuring would convert into pastures of fair fattening quality. There are hundreds of acres so covered with ant-hills as to be almost worthless. On some farms hassocks, thistles, &c. are allowed to run riot.

Much is taken from all the meadow-land mown, only a little being returned by few, and nothing by many, the inevitable result of which must be deterioration. In short, though much improvement has during the last thirty years been effected, much, *very much*, yet remains to be done.

If we look back twenty years, we find evidence of much grass-land being converted into tillage; but during the last five or six years little has been broken up. Influenced, doubtless, by the low price of grain, the tide of opinion seems to have turned, and there are several instances where arable has been seeded down to permanent grass.

The Duke of Rutland and some of the principal landowners have declared against breaking up under any circumstances,

while of late years the opinions of others have been much modified.

“A few years ago,” says Mr. Bennet,\* agent for Lord Cardigan, and for other large estates, “I was an advocate for the breaking up of grass-land of second-rate quality, but lately I have let down a peg, and *it is now* third-rate land, and that only in special cases, that I recommend to be broken up.” This may be taken as a fair example of the prevalent opinion on this matter.

There are, however, many instances where some breaking up would be found of great advantage, viz. on those farms where little or none of the land is in arable, a great inconvenience, if cattle are wintered at all.

The beneficial result ensuing from the addition of about one-third of their area of arable would be great. The straw and roots therefrom obtained would enable the occupier to winter his cattle better, in greater numbers, and more cheaply; and, moreover, breeding and rearing (of which every day's experience confirms the importance) might, to a certain extent, be followed.

But it is essential that this breaking up should be accomplished judiciously, and the subsequent cropping based on correct principles. The practice of Lord Berners in this matter, given at page 310, may be safely followed. Injudicious cropping speedily converts what was poor grass into poor arable, and transfers a portion of the landlord's capital into the pocket of the tenant.

#### LIVE STOCK.

*Cattle.*—Many of the rich pastures of Leicestershire are grazed with cattle of first-rate excellence; but the majority of these were bred in other counties, and though there are many breeding flocks and herds throughout the county producing animals of great excellence, yet the mantle of Bakewell and his distinguished contemporaries seems to have been inherited by few of their descendants.

In the grazing districts of our First Division, animals hailing from all parts of the island, and of the most incongruous description, are met with. The Shorthorn, Hereford, Devon, Scot, Welsh Runt, and Kerry cow are all represented, numerically perhaps in the order in which we place them.

In no other branch of rural economy has there been, since Pitt's Report, so radical a change as in the breeds of live stock.

The Longhorn, a creation of Bakewell's and once the rage of

---

\* This gentleman, on some land of his own, has very successfully laid down several fields to permanent grass. His plan being to inoculate with turf from adjoining pastures, over which some good seeds were sown. The writer walked over some land treated in this way, and can vouch for the excellent result.

the day, characterised by Pitt as at that time, 1809, the natural breed of cattle of the county, is now nearly extinct. East of the Soar we are not aware of the existence of a single herd of this breed, but a few specimens may yet be seen on the western boundaries of the county. One herd of great purity and excellence is at Upton, the property of Mr. Chapman, in whose family it has been upwards of a hundred years—the foundation being laid by his grandfather hiring and putting to selected cows Mr. Bakewell's celebrated bull "Twopenny."

Great enthusiasm is exhibited by the patrons of this breed, and assertions confidently made that, besides their great hardihood, they render as good a return for the food consumed as the best animals of the most favoured breeds. As milk-producers they are deficient, although what they do produce is particularly rich in casein. Their utility, however, either for the dairies of the west or the fattening pastures of the east side of the county, is pronounced by the majority as doubtful, and whether they can much longer struggle for a separate existence is at least open to question. The graceful curving horn, white back, and brindled sides, are distinguishing traits of this breed.

With few exceptions, the Shorthorn is the breed kept on the dairy farms. The variety rather coarse, but in some instances of late years the quality has been improved by crossing with well-bred bulls. But, under the ordinary management of the dairy farmer, much improvement in quality is rarely effected: a cow's pail-filling capability rendering her a much greater favourite than mellowness of touch or symmetry of form; while that *beau idéal* animal combining quality, symmetry, and fattening propensity, with great milk-secretion, is rarely found, and as rarely can all her good qualities be transmitted.

The feeding and general management of the cow is given under the heading "Dairy Farm."

Perhaps the only recent changes worth noting in the feeding department are the greater care taken to utilise all the natural produce of the farm, and the greater liberality in the purchase of cake, &c. By the free use of the chaffcutter, pulper, and millstones, a combination is effected which gives an appetising form to foods that separately would be unpalatable.

This unquestionably tends to increase the number of cattle wintered in the county, and though, perhaps, individually the increase may scarce be appreciable, still in the aggregate it may be very considerable.

We instance the farm occupied by Mr. Crawshay, at Slawston, where by the above-mentioned means an increase of live stock has been effected equal to 40 per cent. on that kept by his predecessor on the same farm.

The greater part of this farm is land of *second-rate* quality, comprising 177 acres grass, and 49 acres arable. From January 1, 1865, to January 1, 1866, stock as follows has been fattened and sold, viz., 87 bullocks, 167 sheep, 44 pigs, 3 calves; besides grazing 5 horses and 6 milch-cows. And on January 1, 1866, there remained on the farm 34 store bullocks, 18 yearlings, 6 cows, 5 horses, 43 pigs, and 360 sheep, 148 of the latter being fat.

*Sheep.*—"The sheep stock of the county," says Pitt, "may be arranged into three varieties,—the old Leicester, the new Leicester, and the Forest sheep."

Here also the revolution has been great. Animals with characteristics ascribed to the old Leicesters are now unknown, the Forest breed is totally extinct, while flocks of the Bakewell, or new Leicester, are by no means numerous, and are yearly getting into fewer hands.

Pitt reports a remark of Bakewell to a gentleman who was complaining "that his mutton was so fat that he could not eat it." "Sir," was the rejoinder, "I do not breed sheep for gentlemen, but for the public." But if he had lived in the present age, this reply would not have served him, for now the public, as well as the gentleman, will not eat fat mutton; and it is the desire to gratify the appetite both "keen and critical" of the general consumer that has materially tended to the extinction of the Bakewell type of sheep.

The variety now kept on the fattening pastures of the east, is a cross between the Lincoln ram and Leicester ewe, and *vice versa*; the produce being a large-framed, heavy-woolled, hardy, rent-paying animal, extremely well adapted for the requirements of the district. The cross improves the size, the quantity of wool, and the quality of the mutton, although perhaps the distinguishing feature of the pure-bred Leicester—propensity to fatten at an early age—is somewhat impaired. The greater admixture of lean mutton, however, more than compensates for this by giving a superior value to the carcase.

In some instances the sheep are fattened out at from 16 to 18 months old, then weighing from 20 to 24 lbs. per quarter, having previously clipped from 8 to 12 lbs. of wool; in others they are kept until two-shear, being sold when about 27 months old, weighing from 24 to 28 lbs. per quarter.

In the dairy districts on the west side of the county the Shropshire Down rams are now extensively used for crossing the native breed. When fat lamb is the object, the cross is an excellent one, and even when reared for mutton it is considered an improvement, giving hardihood and quality of mutton, without sensibly depreciating size or the weight of wool.

The pure-bred Leicester is by the common farmer no longer looked on as a profitable sheep, and their value now depends on their utility for upholding the Leicester element, or improving other breeds by crossing. The excellent practice of Lord Berners (see page 312) well exemplifies this.

As time rolls on and the breed gets scarce its value may increase, but the palmy days can hardly return when 500 guineas were repeatedly given for a ram's hire for one year.

Ram breeding for sale and hire is yet to a certain extent followed, Mr. Cresswell of Ravenstone, Mr. S. Spencer of Snarestone, Mr. Bury of Stoke Goldington, &c. &c., being among the most distinguished breeders.

The first-named gentleman has of late years been a successful exhibitor at the Royal Agricultural Society's and other shows. The foundation of his flock was laid in 1790 by the hire of a ram for the season from John Stone of Barrow on Soar, his price being 300 guineas. This was followed up by another hire from T. Stone of Quorn, at 250 guineas, and from Mr. Stubbins at 300 guineas.

The flock since then has at various times been refreshed with outside blood, but the same strain, the Burgess, has been pertinaciously stuck to.

At the present time Mr. Cresswell's flock show no signs of degeneracy, and for pure-bred Leicesters they are of great size, with which they combine quality and a good fleece of wool. At Plymouth, last year, the first prize was awarded to a shearling of his, the sheep being afterwards let for the season, price 50 guineas.

*Horses.*—At the time of Pitt's Survey, Leicestershire was famed for its breed of black horses, but they, as the Longhorn breed of cattle, are almost extinct, and in the course of a few years will become matter for history.

On the north-east and east many horses of a Lincolnshire origin are met with, while the west cannot claim a distinctive breed, or one possessing merit above mediocrity.

The graziers on the east side purchase foals or yearlings, and after grazing for a year, re-sell.

Many of the dairy farmers on the west kept a mare or two for breeding purposes, so that annually they have a colt or two to sell, or it may be to keep on until in their prime, at 6 years old.

The number of horses kept per 100 acres of arable, varies from four on the light to six on some of the clay soils.

The horses usually work about eight hours per day, and the general practice is to work the time out with slight intermission. This practice is perhaps necessary on the dairy farms, where some of the teamsmen are required to assist night and morning

with the milking, but surely on other farms the practice might be improved. The horse, unlike the ox, is not a ruminant, and his small stomach requires frequent replenishing; and eight hours of continuous labour, without any food, is just as hurtful to him as it would be to his driver, who, by the way, while his poor horses, unshaded, are hungering and exposed to the broiling heat of a summer's sun, or shivering in the winter's blast, may be seen quietly ensconced beneath the sheltering shade of the hedge recruiting his exhausted energies with a crust.

We suggest as an improvement on this, the system universal in the northern counties, viz., that the hours of labour be divided, with an hour, clear, in the stable at midday to feed.

By starting at 7 o'clock in the morning, and working until 5 in the afternoon—less one or one and a half hour to feed at noon—much more work would get done, and the animals would be found to endure the labour better than when going eight hours continuously.

In Leicestershire, the great distance of some of the arable land from the homestead might be urged as an objection to this, as much time would be wasted in travelling to and from the stable; but surely nosebags, with a feed of corn and chaff to be given in the field, would obviate this difficulty.

In summer the horses are usually turned into the fields at night to pasture—tares, clover, &c., being grown, and a feed given, morning and evening; but there are instances where they are kept in the yards and soiled on clover or tares.

On some of the lighter soils, two horses working abreast to draw the plough is the practice, but the tandem fashion still prevails, with three, and in winter sometimes four and five horses harnessed one before the other: indeed it is nothing out of the usual course to see three horses in line attached to a pair of harrows, with a man following behind and a boy to drive.

Occasionally in a wet season on clay land, when at plough, such practice may be necessary to avoid poaching the surface soil, but as a rule there can be little necessity for it; and we venture to say that, where deep ploughing is required, three horses abreast with a set of equalising whipple-trees, will with ease to themselves do as much work as four when placed in single file. Besides, as no driver is then required, his wages will be saved.

*Pigs.*—There is little either in the breed or management of the pig that calls for remark. In the dairy districts considerable quantities of pork and bacon are fed, the breed mostly kept being the old Tamworth. In other parts breeds of all varieties are represented, but medium sized animals are preferred, the bacon grown being chiefly for home consumption.

Lord Berners has an excellent breed of pigs, chiefly crosses,

and at Mr. Crawshay's, at Othorpe, we saw some very fine Berkshires.

### WOODS.

Hedgerow-timber excepted, Leicestershire is by no means a woodland county, and the policy must be regarded as sound that has made it so, as the soil generally is good, and well adapted for more profitable purposes.

About the seats of most of the large landed proprietors thriving oak and other hard-wood plantations abound, and when Charnwood Forest was allotted several plantations of Scotch fir and larch were made.

Coppice or underwood is also grown in various districts, and where tolerable care is exercised in its management it is found to pay a net rental of 20s. per acre per annum, independent of the progressively increasing value of the trees which remain for timber.

The coppice is cut at periods varying from twelve to twenty-five years' growth, according to the purpose for which it is wanted.

As a rule, the Leicestershire management of woodland cannot be held forth as exemplary, and the loss from careless management is in some cases much aggravated by the injuries done by rabbits. There are, however, some good examples of good management, among which we may quote some very fine and healthy plantations of Lord Berners. Rides are cut through them in various directions, which are thoroughly drained, and most of them gravelled. The underwood is skilfully managed, being all *cut upwards and close to the ground*; by means of the *clean* upward cut the young shoots become much more numerous, strong, and straight, than when the more common and careless mode of cutting downwards is practised.

On the Duke of Rutland's Belvoir Estate in this county about 1700 acres are woodland. These extensive woods contain all kinds of useful timber, but oak is the principal crop, and in the vicinity of the castle attains to unusual height and beauty. Many trees may there be seen with clear straight stems, ranging from 40 to 60 feet, and thick in proportion; this feature being attained by careful judicious pruning of the side branches. On the marlstone hills overlooking the Vale of Belvoir, and also on the oolite, larch of the best quality is grown.

A few years ago a seven-acre larch plantation grown on the oolite was cut down and sold by auction, realizing 135*l.* per acre. Its age was thirty years, and consequently it paid a rent of 4*l.* 10s. per acre net, it being assumed that the thinnings cleared off all the expenses.



The management of these woods is carried on very systematically, a large staff of men (nearly thirty) being constantly employed, the best workmen having a large share of piecework.

Two nurseries are maintained on the estates, in which all the young trees required for planting are reared.

In the management of the oak-woods the chief aim is to obtain clean, lengthy boles for planking. Iron having to a great extent superseded oak for ship-building, the growth of timber for this purpose is now a secondary consideration.

The younger woods are thinned at periods varying from five to ten years; the thinnings, which are much in demand, are disposed of by several auction sales during the summer months.

In the old woods, wherever an oak-tree with a large spreading top is taken down, the space is at once filled up by replanting; pits at least 2 feet wide and 18 inches deep are made, and oak or ash for maiden poles or trees are planted. These pits are made by task-work, the price varying from 1½*d.* to 4*d.* per score.

On the dry warm soils (especially if hares and rabbits are not abundant) autumn is preferred for planting, while on the clay-soils the pits are dug in the autumn, and, weather permitting, planting commences on the 1st of February.

As a preservative against hares and rabbits, the young trees are brushed over with a mixture of night-soil and lime, or soot and cow-dung, and this is found an efficient protection for one year. In planting single trees or shrubs by the drives, &c., the stem is encircled with rods of elder, which effectually protect them, as rabbits never eat elder.

Good clean-grown planking oak-timber is worth in the county 2*s.* 6*d.* per foot; coarse-graining trees making about 2*s.* per foot, while from the Belvoir woods prime selected trees for special purposes have made 4*s.* per foot.

Prime larch, age from 70 to 80 years, brings from 1*s.* 6*d.* to 1*s.* 8*d.*, but for smaller sizes the price runs from 1*s.* to 1*s.* 4*d.* per foot.

Ash is getting rather scarce in many parts of the county, and the demand and price is gradually increasing, 2*s.* being paid for prime growths, while 1*s.* 8*d.* per foot may be quoted as an average value.

Scotch fir is worth from 1*s.* to 1*s.* 8*d.* per foot, but little of this timber is sold.

#### FARM BUILDINGS.

“The farm-buildings will afford but little instruction to modern inquirers. Stall-feeding is little practised, and I have not met with one modern-built, well-contrived feeding shed.”

Thus wrote Pitt with reference to the condition of the build-

ings of the county in 1809, and though many changes and improvements have since been made, yet it is as true now as then that the student of farm-architecture will find little worth his attention here.

On the estates of the Duke of Rutland, Lords Howe, Berners, Stamford, and others, many substantial commodious buildings have been built, but, nevertheless, homesteads with arrangement and appliances at all consonant to the requirements of modern farming are not numerous, and there are many farms where even the common accommodation is very bad and deficient, and some where it is totally inadequate or altogether wanting. Assuredly this building question is a great blot on the rural economy of Leicestershire.

The consequence of want of buildings is that many cattle are kept in the fields the greater part of the winter, having little shelter except that afforded by the hedges; in wet weather poaching and injuring the pastures, and at all times seriously misappropriating food. Their hay—much of which is stacked in the fields for this purpose—is daily strewn about for them to pick up, and their only lair is the cold, wet, or frozen ground.

The result of this management is a great loss to all; for though, under the circumstances, the landlord is absolved from any great expense in the erection of buildings, he cannot escape from the identity of interest which binds him and the tenant together, and any loss sustained from insufficient accommodation eventually tends to a modification of the rent.

Yards on the covered principle would unquestionably prove a great boon to Leicestershire farmers, especially on the dairy-farms, with their numerous horned cattle requiring shelter, litter, and warmth, yet from their small proportion of arable affording an inadequate supply of straw. The comfort of the animals would be increased, food would go further, and of course be saved, and litter would be economized.

An ox in a covered yard requires about 20 lbs. of straw per day to keep his lair clean and dry. In the open yard more than twice this quantity may be necessary. The manure made under cover is also very superior. There is also a great economy in the haulage. In open yards straw is made the vehicle for the transmission of so many tons of rain-water to the fields. A rainfall of 26 inches—which is about the county average—saturates the litter of 100 square feet of an open cattle-yard with about 6 tons weight of water. Certainly a portion of this evaporates, percolates through the bottom of the yard, or, after washing out of the manure some of its most valuable constituents, escapes by surface-overflow. But enough remains to largely increase the weight and the cost of removal, without adding to its fertilizing

qualities. Under cover the straw is the absorbent only of the excrements of the cattle. The only landowner who seems to have to any extent adopted this system is Lord Berners. At his home farm-buildings he has a large covered dung-court, and we saw three covered cattle-yards on other parts of the estate.

The farm-buildings at Othorpe House, occupied by Mr. Crawshay, on Lord Cardigan's estate, have during the past year been re-arranged, and the yards roofed over, according to plans furnished by the writer, on the principle invented by Mr. Thompson, Kirby Hall, Yorkshire.—See volume i., Second Series, p. 88, of this Journal.

The tenant does not hold a lease, but, nevertheless, he has been at the sole expense of labour attending the alterations and roofing over the yards, the landlord providing the materials.

Mr. Crawshay's experience extends only to the present season, but he writes to me as follows:—"I am perfectly satisfied with my covered yard: 50 head of cattle, and over 50 pigs, are doing remarkably well in it. The labour of attending them is little, food goes farther, and hardly any litter is required in comparison with an open yard."

Of late years new buildings have chiefly been erected in those districts where grass-land has been broken up, the new building generally comprising barn, yard for cattle, and stabling for a team of horses, sometimes with the addition of a cottage, which is very essential, but more frequently this is omitted.

Many of the older farm-houses and buildings are clustered together in villages, being not unfrequently at the extreme outskirts of the farm.\*

#### TENURE OF FARMS.

As a rule, to which there are very few exceptions, the farms are held from year to year. Entries at Michaelmas and Lady Day, but more generally the latter.

A tenant-right custom prevails on most of the large estates, and the payments to the outgoing by the incoming tenant or landlord vary, but the following are the items usually paid for over a large district in the south of the county.

*Michaelmas Entry.*—Outgoing tenant to be paid for the land in bare summer fallow, one year's rent and taxes, the labour in cultivating, the cartage and spreading of farmyard-manure, and the total cost of all purchased manures applied to the fallows.

---

\* A peculiarity in the stable arrangement is to be seen everywhere in Leicestershire, viz., the horses (cart) stand two or three together in a wide stall. The construction is of course much cheaper than when every horse has a separate stall and accidents seldom or never occur.

For land in root-crops.—The crop to be valued and paid for at a consuming price, and the full value of all *purchased* manures applied to the crop to be paid for. Where lime is applied for the crop the total cost is allowed, if applied the previous year two-thirds of the cost is allowed, and one-third if applied two years previous.

For bean, pea, or oat stubbles, prepared for wheat.—The total cost of the ploughing, &c., cartage and spreading farmyard-manures, purchased manures, or lime, if applied for the crop, to be paid.

Clover-leys.—Allowance to be made for herbage if broken up before Michaelmas. The total cost of the ploughing, purchased manures, or lime, to be paid for as above.

Hay, clover, straw, &c., to be paid for at consuming value.

For linseed-cake consumed by cattle in the yards during the last year of the tenancy, one-fourth its cost to be allowed, or if consumed on the grass, one-sixth its cost allowed.

Drainage.—When the landlord finds tiles, and the tenant labour, and only one crop follows before the tenant removes, he is allowed three-fourths of the cost of the labour, and so on, diminishing the allowance by one-fourth for each crop taken. If the tenant finds tiles as well as labour, the term extends to six years, the allowance diminishing one-sixth for every crop taken.

*Lady-day Entry.*—Bare summer fallows.—Allowances the same as at Michaelmas, with the cost of seed and sowing the wheat added.

Root-crops.—When consumed by the incoming tenant, seed and sowing to be added to the cost of the purchased manures as before. The same applies to clover-layer if sown with wheat, and also to the oat, bean, or pea stubbles.

Clover-seeds sown.—The seed-bill and sowing to be paid.

Should any hay or clover remain at Lady-day, the tenant takes it at a consuming price, and also a stack of wheat-straw for thatching; but if more straw than what is necessary for this purpose remain, he is not bound to pay for it.

*Improvements effected and required.*—The Leicestershire Agricultural Society “for the advancement and protection of the agricultural interest in general, for the excitement of enterprise and emulation among the owners and occupiers of land, and for the encouragement of skill, industry, and good conduct, among servants and labourers in husbandry,” was established in 1833. The Leicester Wool Fair, which has proved a great boon, especially to small farmers, was established by Lord Berners at the same time, and competent authorities agree in regarding this as an important era in the history of Leicestershire farming. Fifteen years later, Gisborne, speaking retrospectively, placed it

behind the rest of the world. What it is now we have in the foregoing pages endeavoured fairly to pourtray, and prefer to let the facts adduced speak for themselves.

The improvements effected afford a good index to those yet required. Much is wanted in the matter of farm-buildings, the improvement of old ones, the addition of new, and the adoption of the principle of covered yards. We know that this latter will by many be regarded as a questionable improvement, but since space forbids us arguing the matter, we must leave it to be decided by that great arbiter—Time.

Many a wet, spongy, hassocky, ant-hill-covered pasture calls aloud for drainage, and the removal of those unsightly, unprofitable excrescences, the ant-hills.

Much second-rate upland grass-land demands help in the shape of 40s. or 50s. worth of manure per acre, and those who have studied the accommodating nature of the grass plants will freely endorse the assertion that for such indulgence the returns to the *per contra* side of the balance-sheet will be most satisfactory.

With the inferior or third-rate grass we approach tender ground. Where arable, as subsidiary to grass farms, is not in sufficient quantity, by all means break up—and on many farms this is an improvement imperatively wanted—but when one-third in arable is obtained, we would say, hold. Many are of opinion that poor grass, such as seen on some of the clay-soils of the county, cannot be remuneratively improved, and they would break up indiscriminately. We dissent *in toto* from this view, though the fact that grass will pay, and pay much better for manure applied, than corn at its present selling price, is as yet recognised by a limited number of the agriculturists of the country. Under *ordinary* management, when poor grass is broken up, it speedily degenerates to poor arable—in the present day the least desirable of all land, more especially if, like most of the poor land of Leicestershire, it be of the description which Lord Berners characterizes as “loving land.”

Our advice would be,—Drain, manure, and utilize the turf you have; second and assist, but do not go against, the efforts of Nature, who designed such soils for grass, and, in the long run, will assert her supremacy and prove him a bungler who converts it to tillage.

XXIII.—*On Increasing our Home Production of Poultry.* By  
JOHN ALGERNON CLARKE.

THE amount of our annual poultry-produce remains a secret to the present day. Spackman, in his ‘Analysis of the Occupations of the People,’ lumps this item along with “milk, fruit, and vegetables.” Porter, in his ‘Progress of the Nation,’ values our import of Irish eggs at 100,000*l. per annum*; and McCulloch, in his ‘Statistics of the British Empire,’ affords us the very precise information, that “turkeys, geese, and ducks, are reared in all parts of the country in considerable quantities; but common fowls are by far the most numerous and valuable.” Like many other writers, he assigns large numbers of Dorking fowls to the town of that name, and seems impressed with the fact of their having five claws to a foot; he does not forget the “barbarous” plucking of live Lincolnshire geese; he notes that “ducks are raised in large quantities at Aylesbury;” and reminds us of the time when, “at Christmas, all the stage-coaches from Norfolk and Suffolk to London, excepting the mail, were freighted with turkeys, sometimes to the total exclusion of passengers.” Even the London consumption of poultry is an unknown quantity, for though Dr. Wynter, in his ‘Curiosities of Civilisation,’ enumerates 2,000,000 fowls, 350,000 ducks, 104,000 turkeys, and 100,000 geese, as sold yearly in Leadenhall and Newgate Markets, the list takes no account of the birds which either go direct to the retailers or are sent from the country as presents.

We do know that the demand for birds, for eggs, and feathers, greatly exceeds the home supply; and that, so far from overtaking the appetite of the people, our poultry-keepers permit an ever-increasing importation to confront them in their own markets. Thus the annual import of eggs from the Continent averaged 73,000,000, from 1843 to 1847; it averaged 103,000,000 during the next five years; 147,000,000 for the next five years; and 163,000,000 for the next five years. In 1861, we received from abroad 203,313,360 eggs; in 1863, the number was 266,929,680; while in 1865 it amounted to 364,000,000—that is, about a million eggs per day! But in the 31 days of May, 1866, the import exceeded the astonishing quantity of 56,000,000; and in the first five months of this year, the number was above 196,000,000—more than we received in an entire year before 1861.

The average price fixed at the Custom-house for the computation of the real value of the eggs, was, in 1854, as low as 4*s.* 6*d.* per ten dozen; but owing to the rise in price since that

time, they have been reckoned for the last six years at 6s. per 120, which is also the wholesale price in France. At this figure we must have imported last year no less than 910,000*l.* worth of eggs. This year the value will most likely exceed a million sterling.

With regard to birds, the Board of Trade returns have not noticed them since 1856; but for that, and the previous two years we received in value as follows: 38,876*l.* in 1854, 42,075*l.* in 1855, and 48,230*l.* in 1856. There is good reason for believing that this increase of about 25 per cent. in three years has been maintained, and if so, the importation in 1865 was something like 90,000*l.* Adding this to the 910,000*l.* for eggs, it appears that there was landed on our shores last year a million pounds' worth of produce that we could have raised with the greatest ease in our own country; while every year is telling more and more to our discredit. That sound and searching authority, M. de Lavergne, in his 'Rural Economy of England,' &c., made an approximative estimate of the number and value of our birds, setting down the annual production of the United Kingdom at 800,000*l.*; and if this be anything near the truth, then, allowing for an increase of production in the ten years since Lavergne wrote, we are now actually importing a total of poultry and eggs equalling in value all that we rear and feed and collect at home! Cannot we just double our results, and thus keep in our own hands the sum of over 1,000,000*l.* a-year, which we are at present paying to France, Holland, Belgium, Switzerland, and Italy? Cannot we compete with foreigners under the disadvantage of having to convey their fragile and perishable commodities over long journeys and voyages, with the expense of commission agents at the distant market, and a duty of a penny a dozen levied upon their eggs?

That this branch of rural industry really is capable of immense development in Great Britain and in Ireland, appears from the example of other countries, such as Belgium and France; and is proved, indeed, by what certain of our own poultry districts are already doing. Lavergne takes the poultry produce of France at *ten* times that of the British Isles, or at eight millions sterling, and in the 'Journal d'Agriculture Pratique' for January 5, last year, he brings the annual value of French eggs and fowls up to ten millions sterling. We wonder still more, however, at the figures of M. Pomme, of the Société Impériale d'Acclimatisation, in a paper 'Sur les Races Gallines,' translated in last year's 'Journal of the Bath and West of England Society.' He says, "According to 'The Universal Dictionary of Natural History'—a work of great and legitimate authority—France annually produces 7000 millions of eggs. Estimated at the average value of seven and a-half

cents each, they represent a sum of 525 millions of francs. Allowing each layer to produce 60 eggs a-year, there should be 117 millions of fowls. To this number must be added 10 per cent. for the cocks, hatchers, the sick, &c.—say, in round numbers, 11 millions. From this there results a total of 128 millions devoted to laying and reproduction. It is calculated that the annual production of chickens equals the number of producers—say, 128 millions. At 3 francs each, this amounts to 384 millions of francs; to which add the value of the eggs, 525 millions of francs—that is, 909 millions of francs.” Here is a sum of about 38,000,000*l.*, or nearly a sovereign per head for the entire population of France, given as its annual returns from Poultry! The ‘Universal Dictionary’ may have guessed at its “7000 million” eggs, and the whole calculation may thus be founded on a fallacy; but then Mr. Geyelin, in his ‘Poultry Breeding in a Commercial Point of View,’ published last year, affords us confirmatory evidence from a pamphlet procured in the great fowl region of Houdan: “It is to be desired that our excellent and pure breed of Houdans should be propagated in every other country as much as it is in our own, where the poultry-trade has taken such a development that it forms one of the principal sources of riches. A few exact statistics of this trade in our immediate neighbourhood will give a correct idea of its importance. At the markets of Houdan, Dreux, and Nogent le Roi, there are sold annually upwards of 6,000,000 heads of *fat* poultry, namely,—

	Per Week.	Per Month.	Per Year.
Houdan .. .. .	40,000	160,000	1,920,000
Dreux .. .. .	50,000	200,000	2,400,000
Nogent le Roi .. .. .	35,000	140,000	1,680,000
			<hr/> 6,000,000

This does not include the sale of chickens and poultry [? eggs], which forms a separate trade.” Reckoned at M. Pomme’s price, 3 francs apiece, we have here 18,000,000 francs, or 750,000*l.* worth of table-birds of a single breed, all sold at three neighbouring country markets. Yet these 6,000,000 of fat Houdan fowls just treble in number the 2,000,000 fowls which our Leadenhall and Newgate manage to dispose of. However, Lavergne’s more sober statement of 10,000,000*l.* a-year from the French poultry-yards is sufficiently in advance of the humble achievements of this country, surpassing our estimated production, as it does, by twelve to one. We never had a “good King Henry” who wished “that every peasant could put a fowl into the pot:” it is not everybody with us that loves eggs *à la coque*, eggs *sur le plat*, eggs in *omelettes*, eggs in some savoury



form at almost every meal; it is not every British family that dines three days a week off "the inevitable *poule*," stewed into delicious tenderness in the ever-simmering *pot-à-feu*, or surely the industry of our wives and daughters would never have stood disparaged in a comparison like this.

In the wealthiest kingdom of the world, having innumerable great cities besides the metropolis, in which a luxurious population abounds, and with a vast importation staring us in the face, we cannot say that a want of good markets forbids our feathered stock becoming a greater source of meat-supply. No valid reason has ever been assigned why Surrey and Sussex should enjoy almost a monopoly of London high prices for early chickens, why Buckinghamshire should be the chief hotbed of precocious ducklings, why geese and Christmas turkeys should flock mainly from the eastern counties, why Cork and Waterford should export more poultry than other counties of Ireland. The town and neighbourhood of Aylesbury receive more than 20,000*l.* *per annum* for their milk-white ducks; and a railway witness has stated that the enormous number of 800,000 are annually reared in Buckinghamshire, though Mr. Clare Sewell Read, M.P. (in vol. xvi. of this Journal) supposes half the quantity to be nearer the truth. But these fat birds are no more indigenous or acclimatised to that locality than edge-tools are to Sheffield or gun-barrels to Birmingham; they would bring equal profit to many other districts if it only became the fashion there to breed them. There is nothing peculiar, again, in the cross-bred chickens which come from certain counties earlier, bigger, fatter, and whiter than from elsewhere; and, moreover, our fanciers have provided us with breeds adapted to all differences of soil, climate, and situation. We believe that, what with improved native and imported varieties, we possess the best stock of egg-layers, hatchers, and table-fowls in the world. In no country is the management of our best poultry-yards excelled; and, to bring up the wholesale results to their true national importance, all we require is an extension of the taste for bird-farming throughout the class which earns its living on the land.

For what exclusive advantages, what speciality in system, or peculiar expertness in art, distinguish the great poultry regions of the Continent? The answer is to be found in a Report of Mr. Geyelin, C.E., the projector of the National Poultry Company (Limited), and the designer of the Poultry Home at Bromley. Last year this gentleman made a tour of inspection in France, and an instructive lesson for the readers of this Journal will be a brief epitome of his Report.

In the first place, Mr. Geyelin discovered no monster "galli-

nocultural" establishment, artificially incubating and rearing fowls, keeping 12,000 hens in close quarters, feeding them exclusively on horse-flesh, with a consumption of fifty horses *per diem*, and realising 40,000*l.* a-year for myriads of eggs sent to the Paris market. In short, "M. de Soras," whose rumoured marvels drew visitors from Russia, America, and other countries, is now an exploded hoax. Near Beauvais, there does reside a gentleman who annually raises 5,000 head of fancy poultry, which he disposes of for breeding purposes; but the poultry-breeding of France is universally conducted on the old farm system, with certain peculiarities in method which deserve our notice.

Mr. Geyelin tells us that the system of hatching differs entirely from what he ever saw before, and in some parts of France forms a special trade, carried on by persons called *Coupeurs* or Hatchers. "These hatch for farmers at all times of the year at so much per egg, or purchase the eggs in the market, and sell the chickens as soon as hatched at from threepence to sixpence each, according to the season of the year. The hatching-room is kept dark, and at an even temperature in summer and winter. In this room a number of boxes, 2 feet long, 1 foot wide, and 1 foot 6 inches deep, are arranged along the walls. These boxes are covered in with lattice or wire work, and serve for turkeys to hatch any kind of eggs. Similar boxes, but of smaller dimensions, are provided for breeding fowls. The bed of the boxes is formed of heather, straw, hay, or cocoa-fibre; and the number of eggs for a turkey to hatch is two dozen, and one dozen for hens.

*At any time of the year, turkeys, whether broody or not, are taught to hatch* in the following manner:—Some addled eggs are emptied, filled with plaster of Paris, and placed in a nest; after which a turkey is fetched from the yard and placed on the eggs, and covered over with the lattice: for the first forty-eight hours she will endeavour to get out of her confinement, but soon becomes reconciled to it; when fresh eggs are substituted for the plaster of Paris ones. They will continue to hatch without intermission from three to six months, and even longer; the chickens being withdrawn as soon as hatched, and fresh eggs substituted. After the third day the eggs are examined, and the *clear* eggs withdrawn, which are then sold in the market as new-laid, but as they may be soiled or discoloured from having been sat upon, they clean them with water and silver-sand, to restore their original whiteness. The turkeys are taken off their nest once a day, to feed and to remove the excrements from the nest; but, after a while, they cease self-feeding, when it is necessary to cram them, and give them some water once a day. At one place we observed sixty turkeys hatching at the same time; and we

were informed that during winter and early spring, M. Auché had sometimes upwards of one hundred hatching at the same time, and that each turkey continued hatching for at least three months. At a farm near Lizieux, I saw a turkey that was then sitting, and had been so upwards of six months; and, as I considered it rather cruel, the hatcher, to prove the contrary, took her off the nest and put her in a meadow, and also removed the eggs: the turkey, however, to my surprise, returned immediately to her nest, and called in a most plaintive voice for her eggs; then some eggs were placed in a corner of the box, which she instantly drew under her with her beak, and seemed quite delighted. Moreover, I was informed that it was of great economical advantage to employ turkeys to hatch, as they eat very little, and get fat in their state of confinement, and, therefore, fit for the market any day."

The extraordinary advantages of this singular system appear in its cheapness—the sitting bird covering nearly double the number of eggs that we commonly put under a hen, and at the same time getting fat for market instead of famishing in the process; in the uninterrupted succession of chickens—the hatching being completely independent of a broody condition in hens, which is often delayed or interfered with by wintery weather; in the wide margin for failure in hatching, and the certainty of none but large broods coming off at every three weeks; and in the power to get chickens from the "live hatching-machines" at any season, and thus time them as adults for the high prices of spring and early summer, without any troublesome and expensive provision of relays of pullets of different breeds and ages, which must otherwise be kept for the purpose. Undoubtedly we do need a good method of artificial incubation, for other reasons besides those just mentioned; as, for example, hatching the eggs of fowls that seldom or never sit, which is the case with the best French breeds; for hatching (if we please) the great surplus of eggs which the layers themselves are incapable of covering; and for hatching the eggs of heavy hens which frequently disappoint us by clumsily breaking numbers of eggs in the nest. If we could rear chickens without brooding, scratching, and care-taking mothers, as easily as we can hatch them, our course of action would be very plain—artificial incubation would be advisable everywhere. Not that our sitting-hens should be deprived of their natural three weeks' repose: wise managers, instead of pressing their greed of eggs so far as to damage the constitution of their birds, would set them upon porcelain or other sham eggs. And until artificial nursing has been made feasible in farmyards (it is now only experimental in the establishments of amateurs and at the

Bromley "Home"), chickens hatched by living or other "hatching-machines" must be nursed by hens set in this way, or else other birds must be employed as mothers, after a French system to be presently described. One open field for artificial incubation certainly exists in the hatching of ducks' eggs; ducks being irregular and whimsical about nesting and sitting, and not to be depended on as mothers, while ducklings can be raised well by hand without nestling under feathers, or requiring a protector to lead them.

Something simpler and easier than the French turkey-hatching has been furnished by recently invented, or rather by lately perfected, apparatus. As a curiosity, may be mentioned an ingenious contrivance of M. Manoury, of Mouy, described by Mr. Geyelin. Several trays of eggs are suspended inside a wine-cask lined with plaster of Paris, air being supplied in regulated quantity by vent-holes with vent-pegs in the top; the cask is surrounded by four feet thickness of horse manure; and thus chicks are hatched in much the same way as we force early rhubarb and blanch sea-kale. However, mechanical "Incubators" of different kinds, deriving their temperature from lamps, hot-water, &c., appear to be no further advanced among the French than they are here. The great difficulty is to preserve a steady degree of heat, without slavish attention to the apparatus. At the Jardin des Plantes, in Paris, the manager of the poultry department, M. Vallée, employs an apparatus of his own invention, in which water is heated by a lamp, and the temperature regulated by admitting more or less cold air, through a valve opened or closed by a mercury float. At the Jardin d'Acclimatation, two different plans are in use; one has a lamp and hot water with a valve to regulate the admission of cold air, the adjustment of the valve being effected by a piston, acted upon by the expansion and condensation of air at different temperatures. The other apparatus is merely a zinc box, covered with non-conducting materials; it requires neither lamp, regulator, nor thermometer; the hot water being renewed every twelve hours. All these incubators are declared to work perfectly, and to maintain an even degree of heat in the eggs, provided the room in which the apparatus is placed be kept at one invariable temperature day and night, and independent of all changes of weather—conditions, of course, which cannot be secured except in purposely fitted buildings and with incessant personal care. Mr. Geyelin describes an apparatus (I suppose of his own invention) in which the eggs are laid on a stratum of silver sand in a tin vessel which floats in a tank of hot water, the heat being supplied by a gas burner or oil-lamp below. At Bromley I have seen an incubator, constructed by Mr. Geyelin, which will hold 2000 eggs. The Company have

since improved upon this, and have experimented largely with different apparatus; the results at present not being practical enough for poultry-breeding in ordinary circumstances.

In the latest inventions the "principle" consists in submitting a layer of eggs to a uniform "moist heat" of  $104^{\circ}$  or  $105^{\circ}$ , applying the heat mainly to the top side of the egg, where the germ floats, providing for the access of air, and once a day moving the eggs and lowering the temperature about  $10^{\circ}$  for a quarter of an hour—the contraction and expansion probably effecting a slight ventilation of the interior of the egg through the porous shell. In fact, Nature is followed as closely as possible.

In a little volume, entitled 'Eggs and Poultry as a Source of Wealth,' is a description of an incubator invented by M. Carbonnier, in which a tray full of eggs is placed under a tank of water kept heated by a lamp; but simple as the contrivance is, there appears to be no provision for dispensing with almost continued attention to the lamps and the thermometer. Messrs. Crook, of Carnaby Street, Regent Street, have produced a very successful incubator, in which trays of eggs are placed in compartments heated by hot-water jackets, with a hot-water space immediately above the eggs, while a current of comparatively cool air passes below them. The lamp burns "a highly rectified non-explosive oil," and the burner consists of a brass tube pierced with five minute holes, filled with cotton-thread to draw up the oil. In lighting the lamp a piece of burning paper is held against the tube till the vapour from the oil ascends and is ignited; and this lamp will burn for forty-eight hours with once trimming. The prices range upwards from 50s.

The incubator of Mr. John Brindley, of St. Alkmund's, Derby, is a very compact little apparatus; the heat is obtained by means of a metal boiler, and the cover is of glass, allowing the whole process of hatching to be seen. Another incubator, Minasi's patent, is manufactured by Mr. John Baily, of Mount Street. It is made in two sizes, for 100 or 200 eggs, and besides hatching, provides for the artificial nursing of the chickens till they are three weeks old. The eggs are placed in drawers, which are then raised by "lifts," till the eggs touch the under side of a number of sand-bags, kept heated by a hot-water vessel above; and the temperature of the eggs is regulated by raising or lowering the drawers, as well as by altering the flame of the lamp. When gas is not available a Halliday's naphtha-lamp is used. "Nurseries," or boxes, with "artificial mothers," and a feeding-cage, are arranged on the top of the apparatus, and kept warm by the same hot water that hatches the eggs beneath. The price of the largest size runs as high as 21l.; and the working results are spoken of as generally suc-

cessful. I am not aware how far any of these various machines are adapted for a situation where the day temperature of the surrounding air might be 60°, and the night temperature nearly freezing. For ordinary use the desideratum is an incubator perfectly automatic, or maintaining one invariable degree of heat in the eggs, uninfluenced by external changes of temperature, and this with personal attention necessary only once or twice a day.

After all, the grand difficulty is not in hatching but in rearing the young birds. Does foreign example teach us anything in this matter? Certainly, the French chickens enjoy no balmy climate, congenial soil, or other physical favour that may be denied to tender broods in Britain. "In France, as here," says Mr. Geyelin, "a cold or wet spring is equivalent to a great loss in poultry, and it seems to be admitted everywhere that cold and wet do not agree with poultry; therefore, were it not for some novelties I observed in the rearing, I might well have said that their system is no better than our own; in fact, they show an utter disregard of all sanitary considerations, and I may state that even the best-conducted establishment left room for great improvement in this respect."

¶ The winter and spring chickens are all reared in out-houses; but in mild spring weather and in summer a curious practice is adopted. "In some parts of France, where poultry-breeding is carried on as a trade, they seldom allow a hen to lead the chickens after being hatched, as the hen is more valuable for laying eggs; but they intrust this office either to capons or turkeys, which are said to be far better protectors to the chickens than a hen. They require, however, a certain amount of schooling preparatory to being entrusted with their charge, which consists in this:—When a turkey has been hatching for some months, and shows a disposition to leave off, a glassful of wine is given her in the evening, and a number of chickens are substituted for the eggs; on waking in the morning she kindly takes to them and leads them about, strutting amidst a troop of seventy to one hundred chickens with the dignity of a drum-major. When, however, a troop leader is required that has not been hatching, such as a capon or a turkey, then it is usual to pluck some of their feathers from the breast, and to give them a glass of wine, and whilst in a state of inebriation to place some chickens under them; on getting sober the next morning they feel that some sudden change has come over them, and as the denuded part is kept warm by the chickens, they take kindly to them. . . . I feel in justice bound to say that these artificial living protectors are most efficient to shelter chickens in the day-time, and in the evening they are placed with their charge in a shallow box filled with hay, from which

they do not move till the door of the room is opened next morning. I must not omit to mention that the chickens are not intrusted to the mother or a leader before they are a week old, and then only in fine weather."

Nursing by proxy would be the greatest boon to our poultry-breeders; it is indispensable to the full development of artificial incubation; and there is not so much objection to depriving a hen of her nursing duties as there is to debarring her from sitting. There may be advantages in the French "troop leader" system; but our hope is that we shall be able to dispense with living nurses altogether, and cherish our chickens by means of mechanical "artificial mothers." For these are not novelties of the present day. Parkinson, in his 'Treatise on Live Stock,' published in 1810, quotes a "New method of rearing poultry to advantage; as communicated to the Society for the Encouragement of Arts, &c., by Mrs. Hannah D'Oyley, of Sion Hill, near Northallerton, Yorkshire;" and her plans are exceedingly like those lately introduced by some of our poultry "lights."

This lady says, "In my poultry yard is a small building, similar to a pigeon-cot, for the hens to lay in; with frames covered with net to slide before each nest. The house is dry, light, and well-ventilated; kept free from dirt, by having the nests and walls white-washed two or three times a year, and the floor covered once a week with fresh ashes. When I wish to preserve chickens, I take the opportunity of setting many hens together, confining each to her respective nest; a boy attends morning and evening to let any off that appear restless, and to see that they return to their proper places. When they hatch, the chickens are taken away, and a second lot of eggs allowed for them to sit again, by which means they produce as numerous a brood as before. I put the chickens into long wicker cages, placed against a hot wall at the back of the kitchen fire, with the heat of about 80°. The open-wicker basket is 4 feet long, 2 feet broad, and 14 inches high; with a lid to open, and a wooden sliding bottom similar to that of a bird-cage; the food and water being given in small troughs outside the cage, [the little chicks putting their heads between the inch-interval upright wicker 'spells.']] Within each cage is an artificial mother, for the chickens to run under, made of a board about 15 inches long, by 10 broad, supported by two feet in the front, 4 inches high, and by a board at the back, 2 inches in height, the roof and back being lined with lamb-skins dressed with the wool upon them. They are formed without bottoms, and have a flannel curtain in front and at the ends, for the chickens to run under, which they do apparently by instinct. I find it advisable

to have two or three chickens among them of about a week old, to teach them to peck and eat: if the chickens do not readily run under the artificial mother, for want of some educated ones to teach them, it will be proper to have the curtain in front made of rabbit or hare skin, with the fur side outwards, for the warmth and comfort to attract them; afterwards, they run under the flannel ones. The top of the artificial mother is thickly perforated with holes, for the heated air to escape. When I first attempted to raise poultry in this way, I lost immense numbers, owing to the roofs of the mothers not being sufficiently ventilated. The cages are kept perfectly dry and clean with sand or moss. The above is a proper size for 50 or 60 chickens; but as they increase in size, they, of course, require a larger 'mother.' When they are a week old, and the weather is fine, the boy carries them and their artificial mother to the grass-plot, and nourishes and keeps them warm by placing a long narrow tin vessel, filled with hot water, at the back of the mother, which will retain its heat for three hours, and is then renewed fresh from the steamer. In the evening, the chickens are driven into their cages, and resume their station at the warm wall; this goes on until they are nearly three weeks old and able to go into a small room appropriated to that purpose. The room is furnished with frames similar to the artificial mother, placed round the floor, and with perches conveniently arranged for the chickens to roost upon." The food consisted of coarse barley-meal steamed till quite soft; given alternately with steamed potatoes finely minced; and the boy was "also employed rolling up pellets of dough, made of coarse wheat-flour, which he throws to the chickens to entice them to eat, thereby causing them to grow surprisingly." Mrs. D'Oyley adds that, within two summer months, her hens produced upwards of 500 chickens, 400 of which she reared for the table or market.

Mr. Geyelin is a strong advocate for the "artificial hen." "The functions of a hen towards her chickens," he says, "consist of forming a covering to prevent the natural heat of their unfledged bodies from cooling; also to break into small pieces any food that is too large for them; and lastly, to protect them against danger. The artificial hens do all this, but they perform the duties a good deal better and with less casualties to the chickens. Chickens do neither require artificial heat nor that of their mother; all that is necessary is to provide them with a suitable covering for their bodies until they are full-fledged, to preserve their natural heat. During cold weather, however, their homes must be warmed the same as for full-grown poultry; with a good ventilation without draught, a dry floor, sun-light, and a small run." The frames lined with long fleece, to brood



the chickens like the feathers of a hen, and the floor of dry ashes or sandy soil to keep their feet from cold, have been found to answer well at the Bromley Home; though a good manager who has had some experience with the "mothers" has expressed his opinion to me that they "are not equal to the old hen." At Bromley, now, no chickens are confined except in movable runs, so as to give them fresh ground every day.

I have mentioned the artificial mothers of Minasi's Incubator, which are kept warm by hot water; and there is no doubt that any apparatus for artificial nursing must provide for warming the woolly compartment in which the chicks nestle; just as Mrs. D'Oyley found her hot-water tins needful in chill weather. M. Carbonnier's "nursery" consists of a long glazed box or cage, at one end of which is a zinc vessel for holding water heated to 160° or 180°, and filled once a day in cold weather. Under the bottom of the vessel is a piece of lamb-skin, under which the chickens shelter and warm themselves when disposed. They are kept and fed in this nursery for about a week; and then let out, with the door of the nursery open, for them to run in at pleasure. Messrs. Crook's artificial rearing-apparatus carries out a plan proposed by M. Réaumur in his works upon artificial incubation. It is like a close coop, with a top sloping from front to back; this top is a hot-water casing, with a loose casing of perforated metal, and all lined with lamb-skins; a lamp at the back keeping up the required warmth in cold weather. Owing to the oblique position of the top, the chickens can nestle comfortably; and no warmth is applied to their feet, which would render the birds weak and languid, liable to cramp and taking cold. A wired run should be placed in front of the nursery.

Leaving now these ingenious appliances for converting fertile eggs into full-fledged fowls, as it were by machinery—inventions that will probably be worked by amateurs and "professionals" until they become available in ordinary yards—I return to the subject of French management.

For the first week after being hatched, and in winter for a much longer time, the chickens are fed on barley-meal mixed with milk, stale bread soaked in water, and green food finely chopped. Mr. Geyelin did not find a single instance of poultry being fed upon whole grain. "On inquiring the reason why they fed by meal made into a stiff paste, I was informed that whole grain would be too expensive, produce less eggs, too much fat, and cause more disease when the fowls are fed *ad libitum*, so as to completely fill their crop, which renders the digestion difficult. The food is mostly composed of about one-half bran and one-half buckwheat, barley, or oatmeal, made into a stiff

paste, with which the fowls are fed twice a day, namely, at sunrise and sunset. This diet is given indiscriminately to old and young. In some farms, where the poultry have not the run of meadows, they are provided with a certain amount of animal and vegetable food." At one establishment, all the waste of butchers' shops is obtained at the expense of collecting it; this is boiled, the fat skimmed off, and when coagulated, finely mixed with the waste, and mixed with the meal food. The liquid is utilised by boiling in it cabbage-stalks and other kitchen-garden waste, mixing it with bran, sour poultry-food, &c., and then giving it to pigs, which "thrive admirably on it." Buckwheat is considered preferable to all other grain as a stimulant to egg-laying, and in winter a certain amount is given whole.

"Whilst the rearing is carried on by farmers, the fattening forms quite a special trade, chiefly in the hands of cottagers, who purchase the chickens either from farmers or in the market; moreover, it is the exclusive trade of a few villages in each poultry-breeding district, such as Goussainville, Saint Lubin, La Haye, &c., near Houdan; Villaine and Boce, near La Flèche au Mans; also some hamlets near St. Pierre Divé, Lizieux, Calvados. In these localities, however, the system of fattening differs. The one consists of liquid-cramming with barley-meal and milk, given by means of a funnel introduced into the throat of the fowl three times a day. This process is exceedingly expeditious, as one person can easily cram at the rate of sixty fowls per hour; and the fattening lasts from fourteen days to three weeks, according to the disposition of the chicken to take fat. The selection of the stock requires some judgment, as some chickens are constitutionally too weak, and others have not the frame to receive fat. This system of liquid-cramming is principally adopted in the neighbourhood of Houdan." The use of fat for fattening purposes is deprecated, as it deteriorates the fineness and flavour of the flesh. "In the districts of Le Mans and Normandy, the fattening is performed by dry-cramming, (as described in Mr. Frere's paper on the 'Poultry of France,' in the last Part of the Journal), namely, the meal of barley and buckwheat is made into a stiff paste with milk and water, then formed into pills two inches long and half-an-inch in diameter; these are dipped into water and forced into the throat of the fowl until the crop is filled, twice a day. It is, however, of importance not to cram a fowl until she has digested the previous meal, as otherwise it might produce inflammation and death."

The French fatteners have a notion that fowls feed much quicker without light or ventilation, and without ever removing the excrements, from which cause their places are most offensive and unhealthy. They told Mr. Geyelin, "they were quite sure

that the smell of the excrements stimulated the fattening ;” no wonder, therefore, that distempers have made sad havoc among the poultry-yards of France. In one place which Mr. Geyelin visited, “the cottager had provision made for the excrements to fall through the floor of the pen ; and on pointing out the innovation, he prided himself on his invention, ‘as,’ said he, ‘I can now remove the manure, the feathers of the fowls get less dirty, and the birds have also more air.’”

Difference of opinion exists in various parts of France upon the relative fattening propensities of capons and virgin cocks. “In some localities they pretend that when cocks are not allowed to associate with the opposite sex, they will attain, when fattened, a greater weight, and be much finer as regards flavour of flesh. Others, again, say that when a cock is castrated, it can be kept till a more mature age without deteriorating its quality, and by this attain an extraordinary weight when fattened, besides making himself useful as a troop-leader of chickens.”

The killing and dressing also is a speciality, carried on by men called *Tueurs et Apprêteurs*, the factory system of division of labour being thoroughly applied to the whole of poultry-craft. “They are astonishingly expert in their business, and unless witnessed, as we have done, it would appear incredible that one man can kill and pluck at the rate of one fowl per minute, or sixty per hour. The price paid for this work is about one farthing per head for lean, and one halfpenny for fat poultry. The system of killing differs, however, in this, that whilst in Paris they make a gash in the throat, in the country they stick the poultry in the back of the roof of the beak ; both cause immediate death, but the latter is the cleanest and most desirable process. They deprecate our system of twisting the neck as cruel, discolouring the flesh, and causing early putrefaction of the coagulated blood. When a man kills, he has three baskets near him, into which he drops the feathers, according to the size ; and the reason for plucking the fowls immediately after death is the great saving of time, and the prevention of tearing the skin, which cannot well be avoided when the fowl once gets cold. The lean fowls are immediately emptied of their intestines ; but not so with the fat stock, which contain a large quantity of valuable fat, used in basting, and to give flavour to lean poultry. With chickens, they take care to leave the down on, as an index of their age ; and in all fowls they leave about half-a-dozen feathers in the rump, which gives a very pretty appearance. As soon as the fowl is plucked, and before cold, it is laid on its back on a bench, and wrapped round with a wet linen cloth to mould its shape, and to give the skin a finer appearance. However, they use no flour, as with us, to

give an old hen the appearance of a chicken." The fat poultry is drawn and dressed by cooks, who make an incision under the leg to withdraw the intestines, so that the bird is not disfigured. "The feathers are carefully collected and sorted, and when well dried, sold to dealers. The intestines are boiled, the fat skimmed off, which is sold separate. The intestines are then minced as food for poultry, and the liquid is used for feeding pigs. The combs and kidneys are sold to pastrycooks, the first for decorating, and the latter for flavouring pies. The heads, necks, and feet are sold to hotels, restaurants, &c., for flavouring sauces, or boiled down to make chicken jelly."

Mr. Geyelin refers to the selling of poultry by licensed auctioneers at the wholesale market, La Vallée, in Paris; and describes the country markets, at which enormous quantities of poultry are disposed of. "Every village has its weekly markets, where farmers and their wives bring their produce for sale, in preference to selling it at the farmyard. The police regulations in these markets are strictly enforced. The various products are classified before the market begins. Each person is bound to keep his assigned place, and not allowed even to uncover his goods, and much less to sell, before the bell rings, under a fine of 5 francs. At the ringing of the bell, the bustle to uncover, the rush of buyers, and the chattering, are worth witnessing. The dealers and merchants take up a stand outside the market, where they send all the products they purchase. The seller has a ticket given him, with the purchase-price on it, and is paid on delivery of the goods at the dealer's stand. It seems almost incredible that even in some village markets, within two hours, such a vast amount of business can be transacted with the greatest order and decorum. Some merchants will purchase from 2000 to 3000 lbs. of butter, others 20,000 to 30,000 eggs, or some thousand heads of poultry, &c., all which are taken to their warehouse to be sorted, packed, and perhaps forwarded the same day either to London or Paris. I may add, that the current price for every commodity is fixed and known immediately after the market opens, and depends entirely on the demand and supply."

It seems strange that the antiquated custom of selling poultry at so much apiece or per couple, and eggs at so much a dozen or score, should still be persevered in by ourselves in business-like Britain; for the seller does not know what amount of flesh or of white and yolk he is parting with for a certain price, and the buyer cannot tell how much he is getting for his money. Both birds and eggs ought undoubtedly to be sold by weight; whereas, under the present system, a heavy and a half-fat fowl go at a price irrespective of the cost per pound, and

a Spanish egg counts for no more in making up a dozen than a Hamburg egg of two-thirds the size.

In suggesting that poultry should be made in Great Britain the important and profitable branch of industry that it is in France, we are always met by the affirmation that while very pleasant as a "fancy," cocks and hens will never answer commercially. Stevens, in his 'Book of the Farm,' is quite right in saying that "the usual objection against feeding fowls is that they do not pay. . . . Fowls may be deemed a worthless stock, as they generally are; but they are so only on account of the mode of managing them." Again, in 'Chambers' Information for the People,' we are told that no hens will pay for their food if it is all purchased. And the 'Journal of Horticulture' itself, one of the authorised organs of the poultry world, gives us little better encouragement: the balance-sheets therein published from time to time generally showing a doubtful profit when all the food has been expressly bought for a comparatively few birds. Of course, breeding fancy stock for fancy prices comes under a different category; and so also does poultry-raising and poultry-grazing upon farms where only a small proportion of the food is purchased, and where the housing and attendance are not costly items in the expenditure.

There is reason to believe, however, that poultry production may be carried on in great-scale establishments employing the factory system, with its economy of material, division of labour, convenience of arrangement, facilities of mechanical and other apparatus, and its *maxima* of results from a given outlay. These conditions are not attained by the large poultry-men of France; though, as we have seen, they are far in advance of our ordinary farmers and cottagers.

A professed example of fowl and egg production on a vast scale is given in 'Eggs and Poultry as a Source of Wealth.' "Our correspondent's chicken-farm," it says, "occupies twenty-five acres, with numerous buildings, well ventilated and kept perfectly clean. The yard is divided by wire fences into compartments, containing a given number of fowls classed according to their ages. The number of birds averages ten thousand. . . . Young chickens are obtained by artificial hatching. The incubators are very simple. They consist of boxes like nests placed in rooms heated by steam kept at a regular temperature. The eggs are kept covered up from light. As soon as the chick escapes from its cell it is removed to another room and put under the care of women nurses. All the other work is performed by men. . . . He feeds them principally upon boiled horse-flesh, diminishing the quantity gradually as the time for fattening approaches, and leaving off

altogether during the last three or four weeks, when he fattens them upon potatoes, Indian meal, pollard, and other grain. The flesh is quite white, remarkably firm, and of excellent flavour. If the animal food be continued too long the birds suffer: they contract disease, and the quills of their feathers become charged with blood. . . . The horses are bought when alive, but unfit for service. They are killed on the premises, in slaughter-houses constructed for the purpose. The blood is carefully collected, and sold to chemical manufacturers at a good price. The skin is sold to the tanner. The head and hoofs go to make Prussian blue; the large bones are made into buttons; the small ones are ground for manure. The marrow is bought by perfumers, who sell it for bear's grease. Nothing is lost: economy is so well managed that the flesh costs nothing; the cost of the horse is covered by the sale of the offal. The flesh cut from the bones is cooked in immense boilers, chopped when cold in a sausage-machine. Before being given to the fowls it is seasoned with salt and pepper, which keeps it sweet and wholesome, and contributes to the health of the fowls. Experience has proved that for poultry a vegetable nutriment is insufficient. The reason they do not lay in winter is that they cannot obtain the worms and insects necessary to maintain their health and strength. By giving the birds meat, they can be made to lay nearly all the year round. Next winter I hope to be able to send 40,000 dozen eggs to market. I reckon that every good hen brings me in 15s. a year, deducting failures. They continue laying four years, and at the end of that time, after three weeks' fattening, are fit for market. A very curious fact is, that the hens which are constantly laying never want to sit. . . . The dung produced in my poultry-yard is a very important item of profit; it is much sought after by market-gardeners as one of the best manures known, and its action is favourable to every kind of vegetable."

The whole of this account may be ideal, seeing that no authentication is afforded by name and address; and, indeed, from the fact of another "correspondent" having "obtained a cock and hen from Calais," from the book giving prominence to French breeds, talking about "poulets" and recommending the incubator of M. Carbonnier, and from the entire silence of the title-page as to authorship or authenticity, we should judge this work to be mainly a translation from something very sanguine published in the gallinaceous empire across the Channel. But though smiling at this edition of 'De Soras' over again, we may regard it as illustrating, at any rate, some of the ideas which may be embodied in a large establishment.

I can adduce, however, an example which can be more readily verified, for, in 1864, a friend of mine inspected the "poultry-farming" conducted by Mr. F. H. Schröder (the present Manager of "The National Poultry Company"), at his private residence in Hertfordshire. He found there about 1000 head of poultry of various kinds, fed almost entirely on flesh. The working of the concern was in this way:—All kinds of dead and dying animals, such as cab-horses, cows, donkeys, &c., were boiled down in large coppers; the fat and oil were separated and sent in casks to the London market; hoofs and heads were disposed of to the glue makers; a portion of the bones and horns to the manufacturers of knives, &c., and the coarse bone to the manure companies. The hides and hair also found their market. The flesh fed the poultry; and it was here that the proprietor considered that he was making an *extra profit* over the general run of such establishments. His "experience" communicated to my friend was, that he could keep 3000 hens without cost, and at that time was disposing of the eggs at 2s. 6d. to 3s. per score; while the poultry-manure sold for 4l. or 5l. per ton to the market-gardeners. The liquid from the boilings, with a quantity of grains (which he had to contract for), supplied food for some 60 pigs.

In a letter of the 17th July, 1866, Mr. Schröder informs me that though he knows of no farm keeping 10,000 head of poultry on horseflesh mainly, he has at times had near 1000 head, and has "for very many months together fed principally on flesh." The result is that he is "perfectly satisfied." His birds, he says, "range about anywhere, wherever their own sweet fancy takes them; they can go over about 7 acres;" and fowls of any breed are adopted as long as they are healthy. "We hatch chickens, ducks, turkeys, pheasants, under hens or by incubators, the best way we can; we sell eggs, or chickens, or ducklings, anything we have, as it happens to pay best. We feed on flesh whenever we can get it, in the winter months, say from October to April; we have hardly ever been without it. In the hot weather we don't care about it; but, when I am thoroughly at work on the Company's Poultry-farm, I have no doubt I can preserve meat for summer use. As to the cost of food, attendance, and all expenses, I have myself, for many weeks together at certain times, fed my fowls at no cost whatever—nay, have made a profit out of their feeding itself. That has been when I have been lucky in chance food coming in. At the worst, the cost per head has not exceeded three-fourths of a farthing per head per day. At Bromley the average exceeds that, but then we have all the "nobility" there. Cost of attendance, and all other expenses, is regulated entirely by the manner in which fowls are kept. At

Bromley, in their "polished homes," with every attention, it ranges far over what it does with my gipsy lot, or what it will do on our Company's farm when the birds are penned according to the plan I intend carrying out." Mr. Schröder's principle is that the fowl in its normal condition is a scavenger, therefore it must be fed as cheaply as possible; and horseflesh, &c., is the cheapest article of diet procurable by him. Ordinary farmers, of course, cannot follow this system, because they are unable to get a sufficient supply of such meat; but in their favour is the circumstance that they always have by them much waste grain and vegetable produce, rendering flesh unnecessary.

The most important experiment in poultry production is that of the National Poultry Company (Limited), which (under the management of Mr. Geyelin) commenced operations last year in the "Poultry Home" at Bromley, Kent. The present Manager is Mr. F. H. Schröder, with Mr. William Massey as Deputy-Manager and Resident-Superintendent at Bromley; while in conjunction with the main establishment is Mr. Schröder's Hertfordshire concern, and another small farm (in prospect) near Watford. The Bromley Home (at present only a portion of the premises originally projected) consists of a principal building, sheds, houses, yards, &c., and market-gardens, occupying 6 acres of dry gravelly soil. The main erection is a greenhouse-looking affair of wood and glass, 340 feet long, 20 feet broad, and 12 feet high to the central ridge. The pens are arranged along each side of the long central passage, which has a floor of red tiling with shafts admitting cold air in summer and warm air in chill weather, ventilation being provided for above; and vines, trained up the front of the pens, meet overhead with a pleasant cooling shade of green leaves. The pens are in two tiers, that is, a ground-floor and a story, each occupying 12 feet length of frontage, with a breadth of 3 feet from the wired front to a wall of boards, and outside the boards is a similar range of pens of the same size, having for their outside wall a framework of wood and wire. Thus a cock and six hens have the range of an inner pen 12 feet by 3 feet, completely shut in from the weather, and also of an outer pen of equal size, roofed, but exposed to the open air through wire of about 2-inch mesh. This was thought to be rather close confinement for all but the most inactive breeds of fowls; and therefore there have been lately added to the building open runs, each of about 30 feet square, in which the different pens of birds are permitted to exercise and scratch in turn. Of course the birds can be confined to their inside quarters by means of a sliding trap-door. Water is supplied to them in a porcelain fountain in each inner pen, mounted upon a shelf out of the way of the dirt; and food is given



in small zinc troughs placed in the central passage, the fowls putting their heads between upright spalls 2 inches apart, after the principle followed in model pig-styes. When a hen wants to lay she creeps into a box placed outside her pen in the central passage, and her nest consists of a circular earthenware pan, 12 inches in diameter, and 5 inches deep, containing some dry sandy earth. The perches are circular iron pipes, which can be warmed by water from a boiler in a very cold season. The floor of the inner pens is just the hard ground covered with nearly a foot thickness of dry earth and sand; and it is found that, by sweeping off the birds' droppings every morning, digging over the earth twice a week, and occasionally renewing it, all smell is prevented, perfect cleanliness is secured, and there is the same freedom from "taint" which engenders disease as if the birds moved to a fresh surface of ground instead of having fresh soil brought to them. This dry earth is also the very best dust-bath in which the fowls can busk to clear themselves from vermin. Scrupulous attention, of course, is paid to lime-whiting, and to every detail of cleanliness in the pens and vessels. The outer pen is littered with stable-manure, which provides ample occupation for the birds in scratching and picking.

At one end of this building, which accommodates the brood stock, are the departments for fattening and for hatching; the fattening and sitting pens being like so many little cupboards, in tier above tier, all bottomed with dry earth, while each of the hatching-boxes contains an earthenware nest.

The apparatus for artificial incubation, the department for rabbits, the duck-houses and tanks, the boiling-houses, pig-styes, manure pits, &c., occupy other portions of the premises, together with a water-tower, the Manager's house and office, all which I need not particularly describe. When I was at Bromley, early in last winter, there were about a thousand head of poultry on the premises; and I saw some 300 half-grown and adult young fowls in an open yard about 22 yards square, bounded by a 7-foot high pale-fence, with stable-manure to scratch over, and a roomy house to roost in. All the birds, both in the pens of the "Home" and in the open yards, looked perfectly healthy, and doing well.

The feeding is reduced to a system: the diet consists of green food, a portion of flesh daily, with grain, changed from barley to oats, Indian corn, rice, potatoes, mangold-wurzel, and so on, on different days. A little sharp grit is mingled with the food to assist digestion; and charcoal, camphor, and sulphate of iron are put in the drinking water occasionally, as the birds require medical or stimulating treatment.

Though experiments are being conducted with artificial incubators, the hatching is done chiefly by hens and a considerable share of it by turkeys. Mr. Massey informs me that he has had "many turkeys now (July) sitting over three months, and they appear quite at their ease." The chickens are not confined in the pens of the main building, as at first proposed, but placed in moveable "runs," so as to give them fresh ground frequently; some are reared under hens, some under artificial mothers, and the loss in chickens has been very small. The total number hatched has been (up to July) about 500 at Bromley, and a similar number at the Hertfordshire establishment, while about 1000 pheasants' eggs were then hatching; but the chickens would have been much more numerous if the Company, having a great demand for their choice native and foreign varieties, had not disposed of *all* their early eggs for sitting: in fact, during the spring, the receipts were from 30*l.* to 50*l.* weekly for fancy birds and eggs only. It is too soon yet to say whether or not the Company will make handsome profits; but at present, though the expenses are very heavy, the managers consider that their prospect is exceedingly good. One of their chief branches of business hitherto has been the importation and sale of fancy French breeds (with which the Company have won many prizes at English shows), and a new trade is opening up for their novel poultry fittings and appliances. One point, at any rate, seems to be already established: the brood stock remain healthy, the chickens are not subject to any unusual average of mortality, and the French breeds, quickly acclimatized, give every satisfaction. Mr. Massey tells me that he has "never seen an ailing Houdan in the establishment." At present the Bromley Home is chiefly devoted to the breeding of what may be called "fancy" birds, that is, pure-bred fowls of the most valuable varieties, but the supply of ordinary market birds and eggs on a great scale will be gradually embraced in the growing operations of the Company. This part of their business is already large, though the demand is only local.

Another great undertaking is advertised by The British Poultry-Breeding Company (Limited), whose farm is at Kattern Bourn, Shenley, Herts, about fourteen miles from London. According to the prospectus, the Company proposes to begin with 1000 laying fowls and 2000 breeding hens, from which they expect to sell 150,000 eggs a year, at 1*s.* 6*d.* per dozen! and to rear, with the assistance of artificial hatching, "at the smallest estimate," 100,000 chickens per annum, which will be sold at "an average price of 3*s.* 6*d.* each!" A further sum is looked for from first-class specimens, "say 100 raised in a year, to realize 5*l.* per bird! and the manure and feathers are still further to

increase the receipts." These extravagant hopes may not be realized ; but the Company have leased a "farm" of 16 acres, on which buildings are erected on the plan of Mr. Geyelin, very similar to the Home at Bromley, but on a scale one-third larger and more substantially built. Mr. George Wahab, the Secretary to the Company, informs me that "the building for the breeding stock is 300 feet long by 30 feet wide, divided by a glass-covered way 8 feet wide up the centre, having fifty compartments on each side, 25 at bottom and 25 at top, each 12 feet by 11 feet, with wire runs outside the building. The greatest care has been taken to prevent damp, by drains and by raising the floor with burnt clay, chalk, and earth ; and thorough ventilation is provided by an air-shaft 12 inches in diameter, which runs up the centre of the covered way under the floor, with iron ventilators at every 12 feet. The building is of brick, and roofed with wood and asphalted felt. This building will accommodate at least 1000 breeding fowls. The other building is of the same extent, but will be arranged for hatching and fattening, preparing food, &c. Both the buildings are situated upon a gentle slope toward the south, and there is an abundant supply of pure water. The greater part of the stock will be kept in a confined state, but with plenty of air and ventilation. The Company will be able to rear about 10,000 chickens per annum with the 1000 birds only. It is not intended to use incubators for hatching at present ; turkeys will be used for that purpose. The land will be cropped solely to supply the stock with vegetables, of which their food will principally consist."

Undertakings of this kind will be sources of instruction for farmers in the management of their poultry-yards ; and we can assimilate our arrangements as closely as may be to theirs, studying the protection and comfort, and the most suitable dietary for our birds ; economising food and saving labour by properly arranging our houses and timing the different details of attention. What these arrangements should be in ordinary farm-yards, how the general management should be conducted, which are the best breeds of fowls, &c., for different districts or special purposes, and so on, are topics too large for the limits of the present paper, and may well occupy the pages of a prize essay exclusively devoted to this subject.

My aim has been not to advance anything new to poultry authorities, but simply to introduce the question of extended poultry-production to the notice of the readers of the 'Journal,' by setting forth what other people are doing in this branch of industry, and to urge the feasibility of obtaining profit from feathered stock, not by entering into calculations where figures may be widely at fault, but by citing the example of large classes of persons

who are engaged in the business, and would not do so if it did not pay. Mr. C. Sewell Read tells us of "a little farmer at Bierton, Bucks, who had at one time nearly 2000 ducklings." The author of 'Poultry as a Meat Supply,' speaking of certain parts of Ireland, says: "There, in the vicinity of any cottage, you will see turkeys in scores, nay, in hundreds, picking up a living in the fields, on the hills, on the commons, on the roadsides even. The small farmers rear them in large numbers, they share the children's breakfast of oatmeal or Indian corn, and so profitable are they that the landlord's rent is almost paid by the sums that they realize." And I conclude by repeating that only an extension of the taste for poultry is required in order to make quite common the profits which a few of our countrymen already realize by not "despising small things," but, on the contrary, installing domestic birds in their right position among the live stock of the farm.

*Long Sutton, Lincolnshire, July, 1866.*

---

XXIV.—*Mountain Breeds of Sheep.* By HENRY H. DIXON.

PRIZE ESSAY.

Cheviots—Crosses with Leicester—Blackfaces—"Mules"—Herdwicks—Lonks—North Wales Sheep—Crossing with Cheviots—South Wales Sheep—Exmoors—Dartmoors—Increase of Cross-breeding—Merits of pure races—Their chances of extinction—Where improvement necessary.

SCOTLAND—to which our hill flockmasters naturally turn when they wish to change their breed or try the effects of a cross—has, so to speak, only two breeds of mountain sheep. The tiny "natives" of the West coast and the islands from Islay northwards, with their horns and brown-chestnut face and legs, have been nearly "improved" away; and, except at Earl Cawdor's in Nairnshire, where care and fine feeding can bring the wethers up to 13 lbs. a quarter at four years old, a man must take many a long day's journey to find them. The old breed from Brae Moray, with roan face and legs, hairy wool, and as wild as a roedeer, and whose lambs were always yeaned with a red spot on the shoulder and the tip of the tail, live only in story and the council-chamber canvases of the Highland Society. In short, Cheviots and Blackfaces hold the heights alone from the Ord of Caithness to Hindhope, and there is scarcely a spot, save the peaks of Ben Nevis, where the latter cannot get its living.

It is to the Robsons of Belford, who were flourishing when the century began, that the earliest improvement of Cheviots

is generally allowed to be due. Their tups were all bred on the Cheviot ranges, and 70 or 80 of them would sell and let for about 700*l.*, when they were marshalled each year in the great barn. It was said that there was a cross from Dishley in the flock; but it was, at all events, with sheep of this blood that the late Mr. Reed left Reed-Water, on the south side of the Cheviots, to push his fortunes in Sutherlandshire and drive the Blackface out of the county. We hear of him, as years went on, with 18,000 sheep upon a farm of eighteen miles by eight along the banks of the Helmsdale and the Brora, and handing over 2006 three-year old wethers and 1500 cast ewes one September to a great Hawick salesman.

In the north of Scotland it is all heather, and in the south all grass; but the lower range at which the cotton-grass grows on the hills of Sutherlandshire enables the sheep to tide it better over the winter without the aid of mountain hay. The southern Cheviots are thus brought up more artificially, and it seems a question whether the tups are quite so hardy and so active in following the ewes; but still all the present prizetakers come out of their ranks, and the Northern breeders do not care to meet them in the Highland Society's ring. The most improved type of Cheviots, like Mr. Brydon's (for whose tups between 100 and 200 guineas have been given recently at his biennial Beattock sale), have good Roman-nosed heads, flat crowns covered with hard white hair, and that "cock of the lug and glint of the eye" which tell of mettle that will make them hunt the hill for food, and not hang listlessly round the hay-hecks after a storm. They have also a fine "parkranging neck," rather Leicester-like girth and width between the forelegs, light and clefty bone, and plenty of wool under the belly as well as on the arms and thighs. A good forearm, or "butcher's grip," is as great a point as white legs (though the grey-legged ones are generally good provers) and a black nose; and the horned tups are thought more hardy, though they are often coarser in the coat.

The wether hogs, and, of late years, the ewe hogs in the Border counties, are put on to turnips the first winter, as a safeguard against braxy; and with such treatment they will cut from 4½ lbs. to 5 lbs. of wool. For hill ewes, 3½ lbs. to 4 lbs. is a high average, and three-year old wethers, after four months of turnips, will cut 6 lbs., and kill at 20 lbs. to 22 lbs. a quarter. The cast ewes are sold, when four or five years old, at about 28*s.*—though during the last two years the prime lots have gone much higher—to be put to a Leicester tup, where "a flying stock" is kept; and the "middle" ewe lambs find customers among

those farmers who breed half-breeds and yet have no pure Cheviot flock from which their ewe cast can be replaced.

Lime is the pioneer of the half-bred, which is gradually replacing the Cheviots on the Lowland hill-pastures up to a 600 or 700 feet elevation. There are sound economic reasons for this gradual revolution, of which good feeding in the winter months is the mainspring. A two-shear Cheviot wether, which knows very little about the hill and has been "sent along" on the lower ranges and turnips, will only kill at 18 lbs. per quarter, and the two fleeces may be taken at a guinea. On the other hand, the half-bred shearling, which has a little corn and cake with its turnips, kills at the same weight and leaves one fleece worth 14s., "be the same more or less."\* Hence, as it is the interest of the flock-master to "breed as near the butcher as possible," the half-bred system is making rapid strides on the lower ranges in Roxburghshire and all through Teviotdale, and creeps higher up the hill every year with the increased breadth of turnip husbandry. The ewes must always have seven or eight weeks of turnips before lambing. This plan serves the triple purpose of improving the quality and number of the lambs, securing a heavier ewe-fleece, and leaving the ewes when the lambs are weaned much riper for the butcher. In some of the best arable districts the half-bred ewes are put to the Leicester, but, beyond reaching the same weight six weeks sooner, the produce differs very little from the half-bred.

Except when a flock is crossed from Blackface into Cheviot, which has been done upon the hills at the head of Clyde, the union of the two breeds is rare. Practice has shown that the Cheviot tup should always be used, and that if the cross is taken the other way the lambs are inferior both in shape and bone. The third cross of the Cheviot generally obliterates every trace of Blackface, except, perhaps, in the grey shade of the legs and the kemp, which rancorously persists in lingering among the wool. The severity of the winter of 1859-60 induced some flock-masters on the highest ranges to revert to Blackfaces. Their powers of bearing cold are very superior, and they can thrive where no Cheviot can live. They also eat coarse, wild herbage, which their tenderer rival would disdain, while their superior action and higher spirit enables them to search for it better in the snow. A less amount of food will also suffice them, and some of those who have had both consider that on coarse land five Blackfaces can be kept for four Cheviots, though on good land this proportion would not be maintained.

---

\* These calculations are based on the prices of 1865.

Their slow maturity and the lower value of their wool is always against them. Connoisseurs never consider that "the gravy runs like brandy" from a haunch of Blackface till it is between three and four years old. Where they are put on to good park-pasture they grow wonderfully the first year, and, as far as the eye is a guide, there is no way of distinguishing between them and a good average Cheviot on the platter except by the smaller tail. The light sprittle face was once liked, owing to a notion that it indicated faster feeding and more wool, as well as a quieter disposition. Then the Irish buyers began to fancy a darker face, and thus the dark sprittle came gradually into fashion and is thought to betoken a hardier sheep. A long neck and a short face, with a good broad jaw and forehead, and an eye not too near the root of the horn, are all cardinal points; and good "rotten horns," open at the end, generally denote better thrivers. The horns should also be flat and well apart at the root, not too large, and coming well away from the head. A roundness at the root indicates a tendency in a tup to get soft, bloody horns, which will grow into the head, and get frosted to the flint in cold weather.

Of late years the demand for Blackface dams for breeding "mules" with the Leicester has sent up prices amazingly. Few "butchers' sheep" exceed this cross; they are as soon ready as half-breds, and suit the fat-lamb market as well. The Yorkshire dealers bring Leicester tups to Lanarkshire, and take back ewe lambs, rough ewe hoggs, and cast ewes over the Border, as well as the wether "mule" lambs which are bred there. Farmers about the Askrigg district in Yorkshire are very fond of "mules," and they may also be found on the Berwickshire side of the Lammermoors, as well as in Fife and the Lothians.

Cumberland and Westmoreland, and a very small portion of Lancashire, may be said to monopolise the Herdwicks. Eskdale, Wasdale, Ewesdale, Ennerdale, and Loweswater are their head centres, which meet in peaceful rivalry at the Fell Dales Association. Grasmere, Shap, and Ulverston know them well.

"Secure they graze,  
Around the stones of Dunmail-raise,"

where the last king of Rocky Cumberland set up his mountain throne; and they wander over the slopes of Skiddaw and Saddleback, and the south-west side of Cross Fell. The scattered and primitive "statesmen" of the lake valleys consider them as rivals to the Lonks, and steadily disdain a cross. Once upon a time there was such a difference between the sheep bred "Above and Below Derwent," that they had separate classes on the Fell Dales

day. Gradually, however, the Above Derwent men, by taking pains and not sparing their hay in winter, went up to their rivals' heads, and in the county tongue they "*have now got to be maister.*" There are sometimes as many as forty Fell Dales exhibitors, and some of the largest will bring a hundred sheep with them.

Of their origin we have no very clear account, but there is a local belief that the progenitors of the race escaped from a Spanish ship, which was wrecked near Morecambe Bay. At all events they picked their country well, and have established their name so surely from a perfectly wonderful endurance of short commons, that some of the flocks number between seven and eight hundred ewes. Blackfaces have been tried, but the ewes more especially failed, in consequence of the climate and the scanty nature of the grass; and there is the same tale to tell of the Cheviots. In fact, it has been found impossible to farm against the Herdwicks, which have been improved in some hands into "a thick, foody sheep," with points which a few years ago might have been looked for in vain. At the Royal Agricultural meeting at Carlisle they had a local class to themselves, and all the prizes went into Westmoreland; whereas at Newcastle in '64, the Messrs. Brown and Mr. Edward Nelson represented the two parent counties and shared the prize-list between them.

The latter of these breeders, whose Herdwick prizes number between two and three hundred, and furnish, in fact, a triple card and rosette cornice to every beam in his Battermere parlour, lets about 150 tups each season, at from 2 to 5 guineas. More can be obtained for such tups as "Joe" and "Thousand a Year." The latter was sold for 30*l.*, but 12 guineas is considered a great price.

Each fell preserves the same ear-mark for generations, and the farmer takes to the flock with his farm, and leaves it at a fresh valuation (which very much depends upon whether he has given them hay or not) to his successor. All the marks are registered in a quarto Shepherds' Guide. The star, and the raven which typifies

"Ravencrag black as the storm,"

are among its symbols; red pops on the crown and tail head have their conventional significance, and so have strokes over the fillets; while the ears are cut or keybitted till very little of the original is left.

So marked, they wander away in the mist and snow over the fells (where there is often nothing but "the water deal" to show the boundaries of the different farms), and live there half the year. Still they do not stray very far from their own haunts, and by way of saving trouble and enabling the ewes to make for the



tup, he is generally ruddled. The loss on such perilous rambles is by no means slight, and fifty out of six hundred ewes is not thought a very large percentage. Some are clumsy, or venture in a hard time too far on to the rock edge for a few fresh "pickles," and a sudden blast clicks them off. The farmer can watch them tumbling more than half a mile from the top of Honister Crag, and we have seen three ewes lying dead at its foot together. It is in their ability to tide through a Siberian winter that the real "blue blood" of the Herdwick comes out. Sometimes they are so snowed up on the hill side that it is impossible to get at them, and they can do little more than scratch for a bit of dead bracken. In a storm they are excellent generals, forming themselves into solid squares on the most exposed part of the hill, until it sweeps past, and then trying to trample down the snow by a combined movement.

From the end of July till November is the most cheery time for the flock-master. The nip of winter begins about Martinmas, and it is always the first and often the middle of June before the grass is ready. Hence it is no wonder that Herdwick maturity is a thing of slow growth. On the higher fells the ewes have no lambs until they are three years old or "showing" (to use the Fell Dales term) "more than four broad teeth." They are generally drawn by hundreds, according to their fleece or bone, so as to suit each tup, and are put to as late as possible, so as not to lamb much before May-day, when they are brought off the fell and sent back again with their lambs at the end of three weeks. Except at lambing and tugging times wethers and ewes range together; and the gimmers in the intakes are carefully "clothed up." If 560 lambs can be got from 600 ewes it is a great matter of congratulation. The lambs suck until October 4th, and are then taken to the lower ground, and after receiving their "hogg" title with the butter and tar, are sent away to milder climates for the winter. Arable farmers will take them in at 3s. 6d. per head up till March 25th, but as it is such an especial point to place them out near the sea, prices will run up to five or six shillings. They are stationed all along the coast from St. Bees' rocks, southwards to Ulverston, but still many flock-masters only send their "tops" and "tails," and let the "middles" take their chance on the intakes. The sickness from which the hogs suffer, and for which "a change to the salt water" seems the only cure, is like blackwater in calves, and of all durations from half an hour to two days.

The choice of the cast ewes does not depend so much on age as on selection and the wants of the customer. Many of them go off into the lower enclosed commons about Lorton, Wythop, Embleton, &c., which have been well limed and drained; and the

lambs, of which they have sometimes three crops by a Leicester, will make their 16 lbs. or 17 lbs. a quarter as well-fed shearlings. "What will they say at Cockermonth?" is a question which has long since lost its political meaning, but still it is never out of the dalesman's head, as that little town is their auction mart, both for fat and store sheep, each autumn.

The face and legs of the breed are speckled or rather grey mottled, and become greyer and whiter with age. If the face is grey, it should shade off to white towards the nose to suit the keen Fell Dales critic. Tups have generally two or three curls to their horns, and the absence of horn in a female is not a desirable sign. The horns should be dark and "slape," not too small or too close, and rising well out of the back of the head. A light grey or "hoar-frost nose" betokens constitution, and the nostrils should be wide and strong, and affixed to a long and bold head. The ears should be white and sharp, and stand well up, as any tendency to droop betokens a want of spirit to grapple with hill life. A good eye, a broad forehead with a tuft on it, and a rustiness about the poll, are all solid requirements, as well as wool up to the ears, and good "heckling," which in some tups looks like a lion's mane. It is also one of the flock-master's chief aims to get them as wide as possible between the fore-legs, and with a broad breast placed well forward, as the forequarter is chiefly relied upon both for constitution and the scales. The knees should also be strong and "the bone thin to the fetlock, and then a big white foot to follow." Despite the difficult ground which they have to traverse, the best breeders try to get them well filled in behind the shoulders, and round in the rib, and the less false rib they have the greater their power of bearing hunger. There is a tribe amongst them which has fourteen ribs, and these are preferred whenever they can be got. They should also be straight on the hind-leg and well muttoned down to "the camerals" or hocks, while the tail should be thick at the root, and never want cutting. These are the show points, but the majority of flocks fall very far short of them.

If the wethers are left till they are four or five years old with only mountain fare, they will average about 12 lbs. a quarter and the ewes from 8 lbs to 10 lbs. "The better end" of the former are generally sold out at from 25s. to 30s., whereas a few years since, 1*l.* was quite a "rest-and-be-thankful" price. The fleeces have also moved with the times, and are no longer such a curious compound of coarse grey hair and kemp. They vary very much, according to the severity of the winter, from 1½ lbs. upwards; and Mr. Nelson's Royal Newcastle prize wool averaged 5½ lbs. unwashed from five year old wethers. The fleece, which is coarse and open, is divided into two or three qualities, as the hecklings

and breechings cannot be used with the rest. Kendal is the great mart for it, and 18s. 9d. per stone is thought a good price. Much of it is used for coarse woollens and rugs, and it often returns to its native dales in the shape of full cloth suits for the winter. Clipping day in July is the dalesmen's festival of the year. They discuss the prowess of "the Patterdale dogs" (which Mr. Marshall, M.P., sends over periodically to keep down the foxes) as well as the merits of their tups and their collies, one of which is reputed to have left 102 pups behind her, and they pass the rest of the time with "bits of sangs," and in drinking "Confusion to the Scab" and "Pack Sheets and Ready Money," until the barrel of nut-brown ale is ready for turning at last.

The hill ranges of Yorkshire and Lancashire are believed to be the earliest home of the Lonks. We find them extending north from Clitheroe over the Forest of Bowland towards Lancaster, east by Colne and Skipton as far as Keighley and Ben Rhydding, and south along "the backbone of England," by Pendle Hill, Burnley, Todmorden, and Bacup, almost to Blackstone Edge. The Penistone breed, a shorter and thicker description of Lonk, then hold the hills; and Saddleworth has also a large and plain sheep of its own, with a white face and legs and coarse bone. The Saddleworth is a slower feeder than the common Lonk, with which it is often crossed for the sake of size, and its wool, which is worth as much, is a little closer and shorter in the staple. Derbyshire has also Lonks on most of its hills and peaks, and its flock-masters often go over to "report progress" at the Craven Show.

Where there is a mere copyhold fell-right attached to a Lonk farm, the wether lambs are nearly always sold, but never where a flock-master has a great fell range, as for instance, on the hills behind Bacup. A right of common is attached to many farms, and the flocks go mixed, with nothing but the 'Lonk Book of Marks' as a guide to the owners. The old system of the flock going with the farm has been worked out except in one instance. It very much tended to support purity of breed; as now, if there is a flock of pure Lonks on a farm, the incoming tenant will not give the price for them, and commences forthwith to cross. On the fells from beyond Bowland Forest to Lancaster there are Blackface flocks, but some of the owners have lost on the wool and have accordingly fallen back on the old sort. The Falkirk Blackface ewe drafts still come over Foulscapes and Browsholme on their way from the trysts, and sometimes wait at Birket Moor to gather a little bloom before they proceed to Clitheroe Fair. Lonks in their turn have gone as far as Sutherlandshire and the Grampian ranges between Perthshire and

Argyllshire; and in some instances to Northumberland, as a wool cross. The cast ewes are generally sold at Moiser Fair near Keighley, and four to five thousand of them are dispersed round the neighbourhood among the small farmers, who take one crop of lambs from them by a Leicester tup. This cross knocks out the horn in the gimmers, and makes capital hoggs, which feed to 16 lbs. a quarter at twenty months on good lowland pasture, without any artificial food. Cotswolds and Southdowns have also "hit" pretty well with them, but they have been but seldom tried.

Some maintain that the pure Lonk should be copper coloured on the nose, and have the face and legs of the same hue, but fashion differs from them on this point. A white face is generally eschewed as soft, and any approach to a brindle shade as indicative of cross-breeding. The blending of pure black and white is now generally indorsed in the show ring, more especially if the poll is white, and the white streaks fall over each cheek. Lightness in the forequarter is a characteristic of the Lonk, and, as in the Ayrshire cow, betokens good milking. Their scrags are rather light and their legs long, and the loin too often lacks strength. The lambs shoot their horns with the new year, and the wethers never go beyond one curl. Breeders make much of the horn, and consider its strength a great proof of constitution. It ought to be self-coloured and finer than that of the Blackface, but it should come out low from the head, with the same fine, gentle curl.

For cunning the Lonks are unrivalled. They are, in fact, always working for themselves, with a zeal and sagacity which makes them very bad neighbours. Small farmers buy the wethers from the Moor by 20 or 30 at a time, and if there be one better acre than another in a parish, be it garden or churchyard, the strangers very soon make themselves tenants at will. Hence it is often necessary to "hobble" them in spring time. On the hills they run up walls, like a cat, when they cannot take them "off and on," but a wire fence 5 feet high is too much for their philosophy. A curious anecdote is told about one which wanted to get back from the Ings to the hill. A canal was in the way, and the bridge-gate was strongly barricaded, but the Lonk bided his time till a canal boat sailed past, and then jumping on to its deck, cleared the canal at twice. The story is true enough, and as our informant naively added, "*What possible inducement could a man have to lie about a Lonk?*"

Both ewes and lambs are very hardy, and a little cow near Skipton might once be seen suckling four cades, and as proud of them as if they were calves. Except on the fell tops, the lambing begins about March 20th. Most of the ewes lamb on

the enclosed ground below the hill, and stay there three weeks. They are not especially hardy, and require to be wintered pretty well with hay, if it is a snowy season. Fell life for a certain portion of the year is essential to the Lonks, as the heather gives them bone, and acts as an antidote to foot-rot. The hogs are generally kept down in the lowlands from September to April, and those which are meant for store or Christmas shows are "fed from the post," and scarcely ever see the hill. For lean wethers the quotations range according to quality from 1*l.* to 30*s.*, and for fat from 2*l.* 10*s.* to 3*l.* Mr. Jonathan Peel proved at the last Smithfield Club what sheep fed below the hill could do, as his pen and three prize shearling wethers averaged 215 lbs. each, when they were weighed on October 25th, and their clip on April 4th averaged 11 lbs. The celebrated show sheep "Mountain King," which was bred at Hould Top, and made the Knowlmore flock, was the grandsire of this trio on both sides, and when he was in his hey-day his own fleece weighed 18 lbs. A breeder of many years standing writes to us as follows:—"I never saw my *mountain* flock so full of wool as they are this year. The average will be about 5 lbs., but it is generally 4½ lbs. Those kept on the low lands will of course clip more, about 6 or 7 lbs., and some as high as 8 lbs." These calculations will, however, only apply to a flock which is well looked after on a good fell range. The wool is long in the staple, but rough about the breeching, a point on which the Leicester cross improves it, and it goes principally into the hands of the manufacturers of Rochdale, for blankets and the finest cloths. During 1857-65, prices varied from 18*s.* 9*d.* to 32*s.* the stone of 16 lbs. Three-year-old wethers from the fell, when grazed out on good grass-land, kill to about 18 lbs. per quarter of fine-grained well-mixed mutton, which a Lonk breeder would consider it flat heresy in an epicure to rank after Southdown or Welsh. With fairly good feeding and a fillip from turnips, 5 lbs. to 7 lbs. a quarter more can be reached, but the sort cannot be ranked among very fast feeders.

The North Wales sheep are generally white in the face and legs, and the ewes have scarcely any horn. The flocks number from 50 to 500 ewes, and some of them are still larger. Very little care has been taken to select proper tups; bad ones reign on from year to year, and a *progenies vitiosior* follows in male tail. The hogs are mostly brought to the low grounds in winter, and the older wethers as well, before they go to the butcher or to gentlemen's parks in England to be finished on grass. Among the smaller Welsh farmers they only see turnips or hay occasionally. In fact, they never take very kindly

to turnips, from not having eaten them in their youth, and they would rather starve at a show than touch artificial food. Like the Shetland sheep, they own no covering but the sky. Many of their mountain haunts are little better than large loose heaps of stones with patches of coarse grass in the crevices. Others, on the contrary, have good pasturage, at great heights, from 1500 to 1800 feet, and these are generally overstocked. Some Caernarvonshire sheep-walks are 3469 feet above sea-level, and are let at a rent proportioned to the quality of the pasture, and not as in some parts of Scotland, according to the number of sheep kept. Several of the tenants have rights of commonage for so many head of sheep, but this is not generally to the flock-master's advantage, as it often tempts him to put more sheep on the already overstocked commons, and keeps the poor animals in such a state of starvation, that the winter cuts them off by hundreds.

At four years old the fat wethers do not weigh much above 40 lbs. dead weight, and clip from  $1\frac{1}{2}$  lb. to 2 lbs. of washed wool. The Blackface cross was tried, and brought an increase both in size and wool, without any sacrifice of hardiness; but it was not persisted in, as the wool came coarse, and the mutton rather yellow. The Hon. Colonel Pennant, M.P., and some other improving proprietors in Caernarvonshire, have done a good deal by crossing the Welsh with the Cheviot. The plan has been more generally adopted on the lower grounds; but still on one of the Colonel's mountain farms they have done well at an altitude of 1800 feet. The Penrhyn Castle crosses are bred on the mountain farms, and sent down to be weaned and wintered. They then return to the mountain for three years, and are brought down at their fourth winter and kept on grass, a few turnips, and hay if the weather is very bad, and killed off when they are ready. Sometimes, but very rarely, the cross produces a true type of Welsh sheep. Three crosses of Cheviot has increased the Welsh sheep from 40 lbs. dead weight (*i.e.* carcass without the head or legs from the knee, when the farmers sell by so much per lb.) to about 70 lbs.,\* and has also more than doubled the wool, on which the third cross seems to have no effect. Sheep of this cross were too heavy for the mountain, and the trial of a cross-bred ram sent down the size again. It was also found that the continued use of the Cheviot ram, which improved the texture of the mutton, and gave it more fat, as long as it was confined to two crosses, tended to make it too light in colour. No pure Welsh leg of mutton should exceed  $4\frac{1}{2}$  lbs.; larger ones are doubtful in their origin; and even a voucher

---

\* Fed on hay *and* turnips they have reached 90 lbs.

that they were from the Vale of Conway, and about Aber and its Penmaen Mawr, would not satisfy a man of strictly eclectic appetite. For Welsh wool, pure and simple, the highest quotation has been 15*d.* From 1*d.* to 2*d.* less has been recently made for it, and 1*s.* 8*d.* for the cross-bred. Both are bought by the Yorkshire and Lancashire wool staplers. The Welsh people still knit stockings and comforters as industriously as ever from the old sort; and there are mills in Anglesea and Caernarvonshire where flannels, blankets, and winseys (a sort of tweed) are manufactured principally for home consumption.

Radnorshire, or, as it was once termed from the bench, "that little sheep-walk, which calls itself a county," where pony-fairs are still given out by the clerk in the porch on Sundays, has some very Aztecs of sheep about Cwym-dau-ddwr, or "the dingle of the two rivers," Wye and Elan, near the church of St. Bridget. Their range of hills, with hardly a hut for shelter, extends for 20 miles by the course of the Wye, along the upper part of the county, which in Scottish phrase "marches" with Montgomeryshire, and "the sweet shire of Cardigan." Rhayader is the little town of the hills 20 miles from Radnor, and about six more from Kington. The flocks seldom number above 400 ewes; ram selecting is a refinement not much cultivated; and the gimmers generally "chance it" with the old ewes. Light scrags and big bellies are among their attributes; their sharp or "keen noses" are nearly as white as their faces, and their bleat is as meek as a kid's. Storms and hard fare make sad havoc among the lambs, both in preventing doublets, and starving nearly a fourth of the singles which do come. Foxes have also a goodly portion, and even the ravens and hooded crows will make a sally, drive off the dam, and when they have picked out the lambs' tongues and eyes, they devote their best energies to the flanks. Still, with all their disadvantages of pasture and in-breeding, "the capon-thighed ones," as the jobbers call the Upper Radnorshires, swell out nicely after four years old, when they have left their hills for rich lowland grass.

A sheep-washing day on the Wye is a very picturesque and primitive matter. The flock-masters and their men fling them off a rock, and on they go, through stream and eddy, from hole to hole and stone to stone, till they reach some sure landing-place below. There is also quite a muster from the sheep-farms with scissors, shears, and pitch-pot on shearing and lamb-marking days. The Lord of the Manor's paddock is generally pretty full of estrays, which have a withy round their necks, in token of errantry; and it is each shepherd's duty to go there periodically and claim his sheep by their marks on payment of

so much a week for their food. The wethers are generally kept up to five years old, and are then sent to Welshpool, and more especially to Newtown Fair on October 26th, where the jobbers and farmers have often 8000 to pick over.

What has been said about Upper Radnorshire applies as much to the higher parts of Montgomeryshire and Cardigan, but with this exception, that the Cardigan wethers seldom go to a fair. Many of them are bought for parks, and improve amazingly on the 5 lbs. to 6 lbs. per quarter which they would weigh on their arrival. Once the farmers were glad to sell the draft ewes at all prices, from 3*l.* 10*s.* to 7*l.* a score; but although there is little or no change in their size, the jobbers and the railways have brought them out, and 18*l.* to 20*l.* has been reached for them. Some jobbers will buy their 10,000 from two or three counties, and have no difficulty whatever in placing them out each September and October. Many of them are bought for the lower ground in Montgomeryshire, and others go into Surrey, Bucks, and Berks,—where their fame as sucklers has preceded them,—and breed excellent early lambs by a Leicester or Southdown. A small percentage are killed in driving, and they require some shepherding before they settle down to their new rural life, as they have been known to break all bounds, and to be drowned in the rivers and ditches.

In the lower part of Radnorshire a different style of sheep and sheep-farming prevails. Radnor Forest and Clun Forest, which form the boundary line between Montgomeryshire and Shropshire, have been enclosed. The paring-plough has done its work, and seeds and turnips on the hundred-acre allotments have succeeded heather and ling. The hardy, close-fleeced Shrop has also been a most able adjutant, and lambs by him from the Welsh ewes, and fed on these pastures, are worth from 30*s.* to 35*s.* at seven months. Very good lambs of the sort are also to be found about Knighton, and some of the Clun Foresters near Kerry Pole (which lies in the route of the sale wethers from Knighton to Newtown) fetched 54*s.* as two-shears last year.

The Exmoors are spread over the hill district in the north of Devon and the western part of Somerset, a large portion of which is uncultivated. There are also a few in the south of each county, and they are bred to a small extent in Cornwall. They hold their own on the purely hill districts, but since the Commons Enclosure Act many farmers have crossed them with the Leicester. A larger sheep has been secured, but at the expense of stamina and numbers. These “knotts,” as they are styled, are generally without horns. Ewes of the sort have been partially adopted by some of the Cornwall farmers, and Mr.



Anstey uses the tups as well. Cheviots and Blackfaces have been tried on Exmoor, but they were not popular, either pure or as crosses, and the flock-masters fell steadily back on the old forest flocks, which have never known alloy. Farms in these hilly districts are generally small, and as on the richest lands "the little white ivories" have to yield to cattle, the flocks are not very patriarchal in size. They vary from 300 to 2500, which is Mr. E. Maunder's number; whilst Mr. James Quartly, who has also exhibited and won at the Smithfield Club, owns about 1,000. Still the majority of the flocks seldom exceed 700, and the largest are to be found in Devon. The original Exmoors milk better than the "improved," and old ewes especially, and young ones, if they are kept well at tugging time, are very bountiful with their doublets. There are instances of ewes rearing three lambs well after the first fortnight. The ewes are always brought down to the lower ground to lamb, and get a few turnips and oats, and then come in again from the hills in November to the poorest enclosed lands. They are put to the tup at two years old, and are generally drafted after three crops of lambs, though some old favourites go on far longer. A good tup can be bought at from 5*l.* to 10*l.*, and choice blood has its price in the neighbourhood of the Forest as it has everywhere else. The great points of the breed are a very strong constitution (which will bear being buried in a snow-drift for several days); a fine, curly horn; a broad, square loin; round ribs; a drum-like, and not a square carcase on short legs; and a close-set fleece, with wool well up to the cheeks.

Wether lambs are not sold except from very small flocks, but are generally kept, like the gimmers on the enclosures, with a few turnips the first winter, and then put on the heather hills till they are three or four years old. Dealers buy wethers at the farms and send them by rail to the butchers at Bristol, Salisbury, Southampton, and all along the south-coast towns. Some of the "best Quartlys" will average 29 lbs. per quarter as four-year-olds off the hill. Under very high pressure, they have done wonders of late years; and one of Mr. Tapp's first-prize pen at Smithfield last Christmas reached 42 lbs. per quarter. Its two comrades were not far behind it, and two more from the half-dozen which had been drawn and put forward for show "died well" at 6 lbs. less. This, of course, only applies to very well kept flocks in an exceptional year; but, for their size, there is no sheep go to scale so well. There is no trouble in getting them to feed, as, although they are naturally wild, it needs nothing but good management to make them as tractable as Leicesters. A 10 lb. fleece has been cut off a tup for four years in succession, but such instances are few. Lambs average from

1½ lb. to 2 lbs., and taking the clip of a flock all round, it will be about 5 lbs. washed. Thin light flesh is always guarded against as producing a weak staple of wool, but still the best breeders do not care for too heavy a fleece, on the ground that it indicates a deficiency in fattening qualities.

Dartmoor gives its name to a breed of sheep which are to be found on its 350,000 acres, and from 10 to 15 miles round it. Just as in Cumberland there is no visible distinction between Skiddaw Forest and the adjoining fells, so on Dartmoor no wall or fence separates the Moor from the Forest, though the boundary line is known. The latter, which belongs to the Duchy of Cornwall, is wholly in the parish of Lydford, and amounts to about 80,000 acres. Those who have lands in the neighbouring parishes have rights of pasturage and turbary upon it, and enjoy common rights on the Moor as well. The Moor itself is a sort of tableland of bog, with moss, lichens, and cotton-grass, and broken by peaks or tors, surmounted with granite boulders. A few acres have been broken up for potatoes, hops were planted, but with no success; and good meadow hay is won in its glens and valleys. The herbage does well at certain seasons for ponies and sheep, and carries on older beasts better than young. Many farms round the flanks of the Moor have "new takes," or a right to take in so much of it for the use of their farms; and there is also a right of "ren will," which the tenants can exercise against those who, without any right, put sheep on the commons nearest their farms. These "new takes" are always kept in grass, and hence of the 400 or 500 flocks which bear the Dartmoor name, many never enter the unenclosed Moor at all. The latter is generally let in quarters to tacksmen, who take in sheep and charge so much per score. On the high parts of the Moor there is invariably meat, even in the driest season, but the sheep must be shifted in due time to the slate rock, or they will pine away. The Moor's "May-day" for ewes and lambs is on the 20th, but many flock-masters are afraid, and not without reason, of the scab, and only send in their old wethers, which leave again between Christmas and Lady-day. If they belong to an adjacent farm, they are sometimes put in by day and removed by night. In short, considering their modern mode of life, it is difficult to speak of the Dartmoor as a hill or mountain sheep, except by courtesy, or by virtue of their speckled face, which has given way in many flocks to a sort of very light dun.

The ewes lamb from the middle of February to the middle of March, and very seldom in yards. Their lambs are remarkably hardy—"get up, blow their nose, shake their ears, and suck their

dam before you can look round." In point of nursing, they have every advantage, and it has been noticed that the coarsest ewes milk best. By the end of September, the lambs are always taken off the Moor or "new takes," and when the ear-marking, ruddling, and signing are over, they generally run upon seeds. Some farmers send them to grass and turnips in Cornwall for six months, at 15*l.* to 16*l.* per score. Fewer go to Cornwall than formerly, as its farmers have begun to breed their own in preference to wintering other people's, and keep is dear and difficult to get. About Launceston, Callington, Holsworthy, and Taunton there is no great market for Dartmoor tups, as the Leicesters are much used; but Cornwall takes some (which are sold in rare instances as high as 15*l.*) for the sake of giving lean flesh to the Leicester; and about Barnstaple and Bideford they have been crossed with the Exmoor. They are also to be found near Ivy Bridge and Brent, and over a great part of South Devon.

Horns are thought to indicate hardiness, but flock-masters do not make any especial point either of them or black noses. The legs should be straight in the hock and strong in the bone, and follow suit, as regards colour, with the face. A top-knot is liked, but not too much whisker, and a good strong scrag, "high withers," and a thick tail are essentials. There is no breed in which the handling of the tail has so much to do with the general estimate of the sheep; and there is also a common saying, that "a good tup never dirties his tail," or rather never scours on strong pasture. A tendency to fall off at the rump and a certain flatness of rib are not thought defects, but rather conservative than otherwise of that lean flesh, which is, with wool, the especial glory of the breed. All flock-masters like to have their sheep well-woolled and curly below. They have naturally worked very much of late years for wool, but still they do not care to have too much of it for fear of injuring the weight of meat.

The draft ewes are generally sold before Tavistock Goose Fair at all prices from 36*s.* to 45*s.*, and go into the neighbourhood of Liskeard and elsewhere, to be put to the Leicester. The wether lambs are hardly ever sold, and several of the wethers are wintered on a couple of thousand acres of old grass round Tavistock belonging to his Grace the Duke of Bedford. Some are bought at Michaelmas by farmers in the neighbourhood of Taunton, Exeter, and Tiverton, where they are wintered on turnips and sent off to the London market in the spring, while a few of the oldest are put on turnips, clover eddish, and seeds in Cornwall. They are occasionally sold as twos and threes, but four is the age at which they feed best. With corn, cake, and peas in aid they will make up to 30 lbs. a quarter, but 25 lbs. is nearer the mark.

The large proportion of lean flesh makes their mutton very popular with the miners, who are a great band round Tavistock and earn very good wages. Living so much underground makes them rather fastidious in their appetites, and fat meat is their abomination.

Very little is done with dips; and the first Wednesday after Midsummer is the commencement of shearing time. The wool is always sold in the yolk or grease. Washed wool is one-fourth dearer, but those who tried washing considered that it did not pay and returned to the old system. The lambs are always shorn, and although some of them have been weaned a month before, the average is nearly 4 lbs. Even when it has been shorn as a lamb, a hogg has been known to have an 18-inch staple, but the average of a well-bred lowland flock will not exceed 9 inches. Even after nursing a lamb, the ewes, if they have been well kept, can clip 10lbs.; and between two and four, a good wether will reach as high as 14 lbs. on the Moor, and 2 lbs. more on the farms. An eminent prize-winning flock-master showed us his last year's wool account, which made up 2490 lbs. at 1s. 6d. per lb. from 182 sheep and 109 lambs, and there have been years when he has had it heavier. Tups with very high keep have reached 28 lbs. and 29 lbs. in the yolk, and one cut 25 lbs. in two successive years. The prize fleeces at Plymouth last July weighed 13 lbs. after they were washed, and were from highly-fed tups of fifteen months old.

We have thus sketched out the peculiar merits, points, and management of the seven leading breeds of mountain sheep, and shown in what the increased cross-breeding consists, where and with what view it has been pursued, and why it has failed or been abandoned. On the whole, except to a slight extent in North Wales and on Exmoor, it has only been adopted to breed fat lambs, and wethers "nearer the shambles," and not to correct bad points or enlarge the size of the original breed of the country. Even then the change has only been effected at some sacrifice. The Cumberland and Westmoreland farmers may perhaps be accused of clinging to their own old sort, with the same desperate tenacity that made the shepherds of Ettrick Forest rave, even in their death throes, against the Cheviots, as "puir white-faced shilpit things," which "wanted mair waiting on than ony fine leddy." Still the mere settlement for a time, "beyond which the memory of man runneth not to the contrary," would not suffice to keep any breed of sheep in possession of a district, unless it were found to answer best under the peculiar local conditions of nature as to pasture and climate. Tradition, however deep its taproot may be, has very little chance in this thrusting age, when, in Emerson's words,

“Steam is half an Englishman,” and every breeder is aiming not only to fill the butcher’s eye, but to receive a larger annual cheque from his wool-stapler. The Blackface, the Cheviot, the Lonk, the Exmoor, and the Dartmoor, would always stand on their merits, but the Herdwick would have given way ere this to a breed with a better fleece and bigger frame, if one could have been found to “bear pinching” half so well in such bitter winters and on such scanty fare. The Cheviot cross might do much for South Wales, and enable them to send a very different class of cast ewes and wethers off their hills to be “finished” on the lowlands. Still even in North Wales, where far more spirit and capital have been brought to bear on flocks, there are many mountains on which no cross-bred could live, except it were a union of native and Herdwick. The pure Welsh are undisputed masters of the situation above 2,500 feet, and those legs, which have so long been prized both by “mutton-eating kings” and people, will thrive as of yore, on those rocky cloud-capt heights where nothing else save a goat would climb.

---

XXV.—*Report of the Improvement of Grass-land on Mr. E. Ruck’s Manor Farm, Braydon, Wilts.* By DR. A. VOELCKER and PROFESSOR COLEMAN.

THE improvement of neglected pasture is a subject of the gravest importance under existing circumstances. The arable land no longer affords a return so satisfactory that grass can be left to take care of itself. Stock-farming is not now the necessary evil that it was, but the principal source of revenue; accordingly all that ministers to an increase of animal food must claim our most serious attention, and we feel satisfied that the improvement of our grass-land is the most simple and ready means of developing our resources for stock.

As a rule, farmers entertain very mistaken notions about grass-land, evidently considering that pasture is a state of nature, requiring no sort of cultivation: “only leave it alone and it will be sure to come.” This maxim, though true enough in certain exceptional instances, is utterly inapplicable to the great majority of cases. *Something* will come, no doubt—rubbish of all kinds, and poor innutritious herbage—but if we desire to have a profitable surface we must cultivate our grass-land just as carefully and liberally as though under tillage. A very little consideration will establish this principle on a practical basis. The rent must be paid, whether we grow rushes or fine grass. The outlay in labour is small; so that if the return exceeds the cost of the manures, &c., the speculation must succeed.

That the most unpromising surface may be improved successfully, and rendered thereby capable of supporting an increased quantity and higher quality of stock, we have irresistible evidence in the experience of Mr. Edmund Ruck, at Braydon in Wiltshire, which experience it is our object in the following paper to bring before the public, as an encouraging instance of what may be done by pluck and judgment in a district looked upon as one of the most unproductive in England: naturally so poor and wet that it was a common remark "that Braydon would rot a goose."

We enjoy special opportunities for qualifying ourselves for our task, from the fact that we have repeatedly inspected the farm from the very first, and could form a tolerably correct estimate of the progress made from year to year. Our design is to give a simple statement of what we have seen; and, "since seeing is believing," we recommend any one who doubts, or who, stirred with curiosity, may wish for a closer inspection, to visit the spot, where we feel confident Mr. Ruck will be pleased to see any such person; and here, by remarking the striking contrast offered by adjoining farms and fields, the visitor may still, as it were, compare the present with the past. We write in the hope that others who may occupy grass-land on a strong soil will be induced to start improvement. There are thousands of acres in Braydon and elsewhere very similar in character to the Manor Farm, which still present that starved, drowned appearance for which such soils are noted. Before we enter into details, it may be advisable to give our readers an idea where Braydon is, and what it is.

The traveller by the Great Western Railway, on his way from Swindon to Gloucester, passes through one end of it between Purton and Minety, whilst it stretches away to his right nearly as far as Cricklade. It consists principally of a low-lying tract of very wet tenacious soil, belonging to the Oxford Clay series. Oxford clay, when unmixed with diluvial sands or gravel, generally produces yellowish, dead-looking, very tenacious, wet, and barren soils, difficult and expensive to work, which, in their natural state, exhibit a few scrubby oaks and high straggling fences. The very tone and colouring of the pastures is chilling, owing to the cold blue of the Hardhead which with the Devil's Scabious occupies the ground, to the exclusion of better grasses. Live stock look only half alive, stunted and ill-shapen, and the nature of the premises further indicates a low condition of farming.

Braydon was originally a royal forest, though few of the old trees remain to tell the tale. There are two, however, still standing near Purton, which may have witnessed many a royal meeting.

In the 'Archæologia,' vol. xxxvii. p. 304, Mr. Ackerman gives an interesting account, written in 1857, which states the boundaries of the forest as laid down by the perambulations which took place from time to time until the reign of Charles I., when it was disafforested. From this work we purpose to make a few extracts. We have no authentic information as to the precise period at which the forest was formed. Of its great antiquity we may judge from the fact that it is mentioned in a charter of King Athelstane to the Abbey of Malmesbury under its former name of Orwaldes Wood. To use the words of Mr. Ackerman, "It was possibly an escheat to the Crown in the days of the Anglo-Saxon kings, which history has failed to chronicle. Previous to the Norman Conquest the southern limit included Wooton Bassett, which, as shown by the charter of Eadwig, was 'intra silvam quæ vocatur Bradin.' It seems probable that the southern boundary once extended as far as the high road running from Wooton to Malmesbury, where the sterile soil known as Braden land terminates, and is succeeded by some of the richest pastures in the country. The forest was probably added to by Canute, and also by the Norman kings, who paid little respect to their subjects' lands when the same lay contiguous to their own forests.

Braydon, like many other of the royal forests, may have been reduced in accordance with *Charta di Foresta*, one result of the memorable meeting at Runnymede—"Imprimis all the Forest, made by our Grandfather King Henry, shall be viewed by honest and lawful men. And if he turned any other than his own demesne woods into forests, to the damage of him whose wood it was, it shall be forthwith laid out again and disafforested."

John Britton, F.S.A., in his 'Topographical and Historical Description of the County of Wilts,' describes Braydon Forest as situate on the northern skirts of the county, and probably the most extensive of any of those which lay wholly within its boundaries. It was anciently called *Bredon Wood*. According to Brompton, Athelwold, in the year 905, "put to military execution all Brithendum (that is, all the inhabitants of Braden Forest) as far as Brandenstoke, or, as Higden more rightly expresses it, 'Bradenstoke.' In the reign of Henry IV. Edmund de Langton, Earl of Cambridge and Duke of York, was keeper of this forest, and left it, with his other estates, to his son and heir, Edward, Earl of Rutland. Almost all the trees, of which there were many valuable ones here, are now cut down; and the grounds are either enclosed for cultivation, or lie, as already hinted, in a waste or commonable condition. Whether the application of this tract to agricultural purposes renders it more useful

and productive than it would be if again appropriated to the growth of wood, is extremely questionable; indeed, we have little hesitation in declaring our conviction that it is not, and never will be, until the soil and under-strata shall suffer a more material change than we have yet learned that culture is capable of effecting."

So much for the short-sightedness of human wisdom! Mr. John Britton would be surprised, could he pay Braydon a visit, to find an oasis in the desert, with good roads, land thoroughly drained, the pastures throwing up a carpet of luxuriant and really useful grasses, stock in all directions, healthy, and full of flesh, the evidences of intelligent management everywhere visible; and all this accomplished in three years, leaving, as far as can be ascertained, in the improved value of the land, a handsome profit to the enterprising proprietor.

The present dimensions of Braydon are the same as when it was disafforested in the days of Charles I., the boundaries are recited in an order of the Court of Exchequer, in a suit between the king and certain persons claiming right of common in the forest. Mr. Richard Mullings, of Cirencester, has a copy of this order, from which Mr. Ackerman gives full particulars.

To return from this digression to the subject of our present paper, Mr. Edmund Ruck bought the Manor Farm at Lady-day, 1862. The estate comprised about 300 acres, with considerable manorial rights, and cost 4000*l.*—and this may be regarded as the market value, as it was on offer for a considerable term before Mr. Ruck commenced negotiations for the purchase. Shortly after he obtained possession, we—being then resident at the Agricultural College, near Cirencester—were invited to spend a day in Braydon, Mr. Ruck being anxious to ascertain the condition of the soil, and find out what manures were most likely to prove advantageous. The day was extremely wet, and much rain had recently fallen, so we had an excellent opportunity of seeing the land under the old style of management. We entered the property by a long road, which would be more properly described as a cart-track across high ridges. The oscillation of the vehicle as it rose out of and dropped into these irregularities reminded us of a stormy day afloat; through this we floundered, going on from bad to worse, until at length coming to a standstill, we determined to try our luck, stepping ourselves on terra firma, but we did not then fare much better. The slush and water everywhere were beyond description. One of our first episodes arose from our host slipping up at a gate and falling flat on his back. However, we trudged on through it all, and were rewarded by seeing more water on the land than we ever remember to have witnessed.



If ever an attempt had been made at draining, it had long since become useless, from the filling up of ditches and water-courses; and one of the first operations our worthy host carried out was to divert and deepen a main waterway right through the farm, which became the artery for all future drains. We could not but remember Talpa's description of *his* farm. One point, however, impressed us, viz., that although the soil was very adhesive when trodden, yet there appeared to be sand mixed with the clay. At this visit there was no stock, because nothing for it to eat except a miserable black-looking stack of hay, the produce of a considerable area, full of filth of all kinds, but especially the Restharrow, and the Devil's Scabious, a prickly, tasteless, unfragrant mass, with no proof, no feeding properties. Such was the produce in the unimproved state. Those who have not, like ourselves, had the opportunity of thoroughly examining the land in its original condition, will find it well nigh impossible to conceive what the condition once was.

#### NATURE OF THE SOIL.

Although it is quite true that many barren soils can be rendered productive by skill, industry, and judicious expenditure of money in draining, manuring, &c., it is nevertheless certain that the productiveness of others cannot be materially raised, excepting by means which no landlord or tenant can adopt who has a regard to profit. Where a shallow surface-soil rests on a hard granite, or on a shale stone, or on any hard rock which is not readily attacked by atmospheric agencies, or where the inclination of the strata and the impervious character of the rocks are such that only a thin layer of soil will be retained on the rock, it is impossible with advantage to do much to the land. Cases of this kind are, however, generally so self-evident, that no word of caution is required. But too frequently stony, poor land is not properly farmed, from insufficient capital, and is susceptible of permanent improvement, and will make a good return for a judicious outlay in the first place, and subsequent good management. Many still consider it hopeless to attempt improvement of certain pastures on the Oxford clay. Nothing daunted by such evil borders, Mr. Ruck went to work with characteristic energy, and has attained a large measure of success; his experience is most instructive, and very encouraging for those who have to deal with land that, like the Braydon pastures, may have been condemned as hopelessly barren.

An examination of the soil in several of Mr. Ruck's fields has shown us that the grass-roots penetrate but a short distance into the stiff clay subsoil, which appears to go down a great depth. The layer of mould on the surface does not generally extend be-

yond 4 or 5 inches. Naturally, the soil was either like a soapy cheese or a brickbat.

Submitted to chemical analysis, a fair average sample of the unimproved soil, previously dried in a water-bath at 212° Fahr., yielded the following results in 100 parts:—

*Composition of Oxford clay soil (unimproved pasture at Braydon).*

Surface soil, dried at 212°.			
Organic matter and water of combination	..	..	15·13
Oxides of iron and alumina	..	..	13·05
Lime	..	..	·29
Magnesia	..	..	·26
Potash	..	..	·56
Soda	..	..	·09
Sulphuric acid	..	..	·17
Insoluble silicious matter and loss	..	..	70·45
			100·00

It appears from the above that this soil is free from any constituent inimical to vegetation, and that it does not contain any substance in large excess. There is a considerable proportion of clay; but the sterility of Braydon cannot be due to a preponderance of clay, inasmuch as there are fertile soils into the composition of which clay enters in much larger proportion. Indeed, the soil contains a great deal of fine micaceous sand, and it is owing to this coming in contact with a comparatively small portion of clay that the surface bakes up so much. It is well to bear in mind that fine sand and some clay runs into a closer, heavier, and certainly less productive soil than agricultural clays which are almost free from sand. Many poor, hard soils, classed as clays, which are difficult and very expensive to work, contain scarcely 16 per cent. of true clay, the remainder being sand. Such soils are not much improved by weathering, for they contain but little matter which on exposure to air yields food to plants, but nearly four or five times as much fine sand as clay: hence they are less benefited by cultivation and aëration than even land of almost pure sand, and are best suited for grass after thorough drainage.

The sterility of the pasture land at Braydon appears to be due mainly to two causes, namely, 1st, to want of drainage; 2nd, to the poverty of the clays, or the admixture of a large proportion of fine and all but useless micaceous sand with the clay *proper*. It may be further observed that in this soil most of the "iron" occurs as protoxide, a sure indication of imperfect circulation of air in the soil.

Efficient drainage not only removes the evil of stagnant water, but carries air into the soil, as is evidenced by the alteration from the dull yellowish colour which distinguishes illdrained

clay, to the bright red, or light-brown colour, which is characteristic of well drained and properly aerated soils.

The subsoil of the Braydon pasture-land is very stiff, lighter coloured than the surface, here and there showing streaks of oxide of iron, and containing some flints and silicious pebbles.

An analysis of 100 parts gives of—

Organic matter and water of combination	.. ..	7.43
Oxides of iron and alumina	.. ..	19.28
Lime	.. ..	.40
Magnesia	.. ..	.72
Potash	.. ..	1.39
Soda	.. ..	.14
Phosphoric acid	.. ..	.14
Sulphuric acid	.. ..	.08
Insoluble silicious matter	.. ..	70.45
		<hr/>
		100.00

As we might expect, the subsoil contains much less organic matter than the surface, and more oxide of iron and alumina, though a close resemblance subsists between the two; on the whole, the subsoil contains in large proportions the more valuable constituents which occur in the ashes of plants.

On comparing the chemical composition of the sterile pasture with that of good clayland, its poverty—due to a general deficiency in all the elements of fertility—becomes apparent. Thus the pasture is poor in phosphoric acid and in potash, and contains scarcely any lime—unquestionably the most indispensable ash-constituents of plants. The subsoil is not only much richer in potash, phosphoric acid, and lime, but exhibits an appreciable quantity of phosphoric acid. Still the general resemblance between the surface and subsoil is so great that we cannot doubt that both were originally the same deposit, and that in the course of time the surface has become exhausted in a great measure by bad management. The inspection of the land, at various parts of the fields where trial holes were dug and samples taken, gave both clear indications of the causes of barrenness and of the appropriate means of improving its productiveness. The most superficial observer, walking on the spongy wet pasture at Braydon, would recognise deficient drainage as one of the causes of sterility. We have said that, notwithstanding the miserable appearance of the grass, a close examination of the soil revealed the fact that there was a fair depth of surface-mould, then a not impervious clay—as was evident by the occasional stains of peroxide of iron. Beneath this was found generally a really stiff clay, uniform and innocent of water—apparently impenetrable. The theorists may smile with incredulity, yet such is the fact, for we have proved it; and this is one of the lessons we learnt at Braydon, and a lesson that some of our engineers might con over

with advantage — that there are soils so impervious that the water-table, if one existed, would be on, or only a few inches beneath, the surface. We agree, however, with those who believe that there is no soil so absolutely impervious but that by proper methods of cultivation it may become an absorbent. At Braydon it was quite evident that the only water-table on the undrained land was close to the surface. Consequently, every shower of rain made the land very wet ; and the surface lying flat, in many instances, water remains on during winter, destroying every good grass, and leaving the weeds we have noticed masters of the field.

Drainage was, of course, the first step towards improvement — there was abundance of pipe-clay on the spot, and draining materials might have been made for a comparatively trifling cost ; but our enterprising friend determined to drain by steam and discard pipes altogether, trusting to the permanency of the opening made by the mole of the plough.

Some ten or eleven years before this time, and soon after the Exhibition of 1851, when Mr. Fowler's invention was first exhibited, a drainage-plough had found its way into Braydon, and one occupier more intelligent than his neighbours had a good deal done with manifest advantage, inasmuch as the drains being placed at short intervals well dried the land, and most, if not all, were in good working order at the time when Mr. Ruck entered on his occupation. We much question the wisdom of this proceeding. It is true that the cost was small, not exceeding 1*l.* an acre, and that where the fall is sharp and the outfall frequent, the land appears fairly dry, perhaps sufficiently so for pasture ; but, inasmuch as Braydon subsoils contain a good deal of sand mixed with the clay, it follows that there will always be a risk of sand being washed in and choking up the drains. In flat land the mole-plough would not do at all, as it would be impossible to secure a regular fall. The drains must not have a long draught ; and if from this cause the drains thus made are not doing their work in a satisfactory manner, it will often be found beneficial to cut them in half by taking a main across the middle of the field, and thus giving an easier and more rapid vent to the upper half of a field. These mains should be carefully dug and provided with pipes of a good size, so laid in that each mole-drain is properly let into the main.

Messrs. Eddington, of Chelmsford, the present proprietors of the Steam Drainage Plough, have kindly sent us plans of their machinery, and we can readily believe that in a homogeneous soil, and on grass-land where great depth is not desirable, their pipe-laying machine will prove of great service, and cause a considerable saving over manual labour. One great advantage in the use of the mole-draining apparatus consists in the upheaval and opening

of the soil for a considerable space on either side of the drain—the water is thus enabled to penetrate more readily into the drains; the greatest depth that is practicable is about three feet, more often thirty inches: this may be enough for grass, provided the drains are sufficiently near.

Mr. Ruck made use of his old 12-horse engine to drive the windlass; the distance between the drains being about three yards, and the depth varying from thirty inches to three feet. In this way from four to five acres were got over in a day, at a cost, including interest of money, of not more than 20s. an acre. We have before noticed that the surface of the land is the water-table at Braydon; and it is the fact that after the autumn rains the streams which receive the water are strongly coloured by the manure washed off the surface.

The effect of draining grass-land is often less satisfactory than was expected. Many people imagine that it is only necessary to remove the stagnant water, in order to convert a half-starved pasture into a rich nutritious herbage. Nothing can be more erroneous—for a time, at least, the effect of draining is to render land less productive than before. The water-grasses, which have hitherto given bulk, disappear; the mineral riches of the soil are still locked up, requiring the action of the air to set them free, and there is often a decided falling off, or at any rate no visible improvement. Mr. Ruck, however, took a more sensible view: he determined to stimulate the growth of the better grasses by the application of artificial manures, in small quantities often repeated. The soil was deficient, as our analyses shew, in lime and phosphates. Bones would have produced a permanent alteration, but bones are costly and slow of action—a mixture of Peruvian Guano and superphosphate of lime was therefore used: 3 cwt. per acre, in the proportion of  $1\frac{1}{4}$  cwt. of the former to  $1\frac{3}{4}$  cwt. of the latter, appeared a suitable mixture to produce an immediate effect. This was applied in April, 1862, previous to the draining, distributed through 600 gallons of water, a dilution by which it was conveyed more immediately to the roots of the grasses. The cost of this dressing was 26s. an acre, and the effect was extraordinary. No hay was cut in 1862, but the land was grazed with sheep and cattle eating a mixture of artificial food—that given to the sheep cost 10*d.* a head per week, and gave a return of 1*s.* 5*d.* This was the treatment for the first year. A main artery to receive the drainage of the whole property was cut, and the ditches dug out and deepened. The soil derived from these operations was carefully thrown up into heaps, mixed freely and thoroughly incorporated with quick lime, and allowed to lie for some time, a portion of farm-yard manure was afterwards worked in, and thus a capital compost prepared for application in 1863. The grasses, though improved, were still very coarse, and the Devil's Scabious

and Cammock, though much weakened, were still visible here and there. In 1863 a similar dressing of artificials was applied in the same manner, the crop was mown and fed; some 25 cwt. of hay per acre was the result, and a heavy after-feed. In the autumn a dressing of 10 loads of the compost described above was applied. The drainage was now completed, and the mowing and feeding had tended to fine down the grasses. The change of colour, from a dull brown to a lively green, was most remarkable. The live stock looked healthy and thriving, and altogether the face of the country was altered.

In 1864 the same artificials were again used; and it was intended to feed, and not mow. The grass, however, grew with such rapidity that it was found impossible to eat it down, therefore hay was made, and so excellent was the quality, that a cubic yard weighed, when cut out of the stack, 340 lbs.

In 1865, the last year included in our report, the same artificials were used, and more compost applied; the quality of the produce is now thoroughly good, and the value of the land to rent immensely increased. The improvement in the condition of the herbage after the treatment was so marked, that we were desirous of ascertaining whether the soil rendered more productive by these means showed in its chemical composition any difference from the original state. A sample of the surface-soil of the improved portion was consequently submitted to analysis, which yielded the following results in 100 parts, calculated dry:—

Organic matter and water of combination	.. ..	15·76
Oxides of iron and alumina	.. ..	10·84
Lime	.. ..	·72
Magnesia	.. ..	·50
Potash	.. ..	·61
Soda	.. ..	·04
Phosphoric acid	.. ..	·08
Sulphuric acid	.. ..	·12
Insoluble silicious matter	.. ..	71·33
		<hr/>
		100·00

These results show in lime an increase from ·40 to ·72, indicating the influence of the lime compost. In all other respects the chemical examination gives no clear indication of superiority in composition; so that from a simple inspection of the figures it would be hard, if not impossible, to decide which of the two analyses represents the composition of the improved pasture-land. We are anxious to direct attention to this fact, for there are persons who entertain the mistaken idea that the addition of a small quantity of guano, superphosphate, or similar concentrated manures, which produce a marked change in the quantity and quality of the herbage, can be detected by analysis. With bulky matters, such as lime or marl, which are put on the land in

quantities amounting to several tons, this may be the case; but the application of artificial manures, though plainly perceptible by the effects they produce, is inappreciable by analysis. If we bear in mind that an acre of clay soil 6 inches deep weighs at least 1000 tons, it is evident that the addition of a few hundredweights of phosphatic manure, containing probably not more than 12 or 15 per cent. of phosphoric acid, can but increase the percentage of this constituent in a degree so trifling as to fall short of the variations that must ever be expected to occur in two equally good analyses of the same sample of soil.

#### CHARACTER OF HERBAGE IN ORIGINAL AND IMPROVED STATE.

When we first visited Braydon, in April, 1862, the land was very wet, the herbage wiry, scanty, full of sedges, bent-grass, and a great variety of coarse pasture-weeds. A careful examination of the hay from the unimproved herbage revealed, amongst others, the following plants:—

1. *Alopecurus Pratensis*, Meadow Foxtail.
2. *Poa Annua*, Annual Meadow-grass. This grass, which occurs almost everywhere, is very abundant in wet soils; it is a common weed on waste places, and has very little feeding value.
3. *Poa Pratensis*, Smooth-stalked Meadow-grass.
4. *Briza Media*, Quaking-grass; a grass which is of no use in an agricultural point of view. It frequently indicates poor, stiff, undrained clays, and is very common on the Oxford Clays, Forest Marble, and London Clay. Cattle do not eat this grass, and its culms therefore may be observed late in the season.
5. *Agrostis Stolonifera*, Marsh Bent-grass.
6. *Phleum Pratense*, Timothy Grass; very small specimens.
7. *Lolium Perenne*, Perennial Rye-grass.
8. *Festuca Duriuscula*, Hard Fescue.
9. *Bromus Mollis*, Soft Brome, or "Lop" grass. Hay containing much of this grass is always poor, and its presence indicates an impoverished soil.
10. *Cynosurus Cristatus*, Dog's-tail Grass; a poor pasture-grass.
11. *Centaurea Nigro*, Common black Knap-weed, Hardheads, Horn-knops; very abundant.
12. *Cardus Palustris*, Marsh-plume Thistle; common in wet, clayey pastures.
13. Several species of *Carex*, Sedges, or Carnation Grass.
14. *Juncus Campestris*, and others of the same family. Rushes generally found in poor, wet soils.

15. *Ononis Spinosa*, Cammock, Petty Whin, or Rest-harrow ; common in barren meadows.

16. *Potentilla Anserina*, Silver-weed.

17. *Rumex Acetocella*, Dock.

18. *Medicago Lupulina*, Yellow Clover.

19. A few plants of Red and White Clover.

The above list, which by no means includes everything, may yet afford a fair example of the complex nature of the herbage, and the prevalence of many plants deficient in nutritive properties, and indicative of wet and poor clays. The hay was wiry, prickly, and void of proper fragrance. In the belief that an analysis of such unusually poor stuff might offer some points of interest, a fair average sample was so tested.

1. *General Composition of Poor Hay from Impoverished Pasture at Braydon Manor Farm.*

Water .. .. .	16·00	Calculated Dry.	..
Organic matter soluble in water .. ..	12·68	.. ..	14·35
Mineral matter soluble in water .. ..	3·40	.. ..	4·05
Organic matter insoluble in water .. ..	64·69	.. ..	77·75
Mineral matter insoluble in water .. ..	3·23	.. ..	3·85
	<hr/>		<hr/>
	100·00		100·00

2. *Detailed Composition.*

Water .. .. .	16·00	Calculated Dry.	..
Oil and wax .. .. .	2·87	.. ..	3·42
*Insoluble albuminous compounds .. ..	5·72	.. ..	6·82
Crude woody fibre .. .. .	56·10	.. ..	67·51
†Soluble albuminous compounds .. ..	2·56	.. ..	3·05
Sugar and gum .. .. .	10·12	.. ..	11·30
Soluble mineral matter .. .. .	3·40	.. ..	4·05
Insoluble mineral matter .. .. .	3·23	.. ..	3·85
	<hr/>		<hr/>
	100·00		100·00
*Containing nitrogen .. .. .	·92	.. ..	1·10
†Containing nitrogen .. .. .	·40	.. ..	·48
	<hr/>		<hr/>
	1·32		1·58

The hay from the improved pasture was more succulent and contained more moisture than the poor sample : in order to obtain a fair comparison, the analytical results have been calculated in both cases for hay containing an average proportion—that is, 16 per cent. of water—and also for the perfectly dry substances.

The mere inspection of hay from the undrained impoverished pasture shows a large proportion of thick woody stems, which no cattle, however sharp set, are likely to touch. The analysis points out over 67 per cent. of crude woody fibre, with but a small quantity of soluble and readily digestible constituents ; thus bearing



out fully the evidence as to the poor character of the hay, which its external appearance affords. On the occasion of our last visit, in the autumn of 1865, we were much struck with the wonderful improvement in the character of the grass-land, and found, in place of a small stock of miserably poor hay, a good store of well-made fragrant hay, secured in a hay-barn, of which more anon. Several of the coarser weeds noticed in the herbage of the un-drained impoverished pasture had either entirely disappeared, or else the few specimens still to be seen showed a much weaker growth; instead of rushes we found a fair sprinkling of red, white, and yellow clover, but little carnation-grass. Poor grasses, such as "lop-grass," "dog's-tail," "quaking-grass," and others prevalent on wet clays, had to a great extent made way for more nutritious grasses—such as the better species of Fescue, Poa, and Phleum. On examining the hay, we found few Hardheads in it, no Cammock, and only a few of the prickly weeds which were before so abundant. Apparently the herbage had become more simple in character, and the effect of lime and phosphates was clearly visible in the increased proportion of white, yellow, and red clovers, meadow vetchling, and common birdsfoot trefoil. The hay was soft, sweet to the taste, and highly scented by *Anthoxanthum odoratum*, sweet-smelling vernal grass, and was much relished by stock. A fair average sample submitted to a careful analysis yielded the following results:—

1. *General Composition of Good Hay from Improved Pasture at Braydon Manor Farm.*

Moisture .. .. .	16·00	Calculated Dry.
Organic matter soluble in water .. ..	18·31	21·77
Mineral matter soluble in water .. ..	5·29	6·30
Organic matter insoluble in water .. ..	58·20	69·30
Mineral matter insoluble in water .. ..	2·20	2·63
	<hr/>	<hr/>
	100·00	100·00

2. *Detailed Composition.*

Water .. .. .	16·00	Calculated Dry.
Oil and wax .. .. .	3·41	4·08
*Insoluble albuminous compounds .. ..	7·29	8·65
Crude woody fibre .. .. .	47·50	56·57
†Soluble albuminous compounds .. ..	3·41	4·08
Sugar and gum .. .. .	14·90	17·69
Soluble mineral matter .. .. .	5·29	6·30
Insoluble mineral matter .. .. .	2·20	2·63
	<hr/>	<hr/>
	100·00	100·00

\*Containing nitrogen .. .. . 1·16 .. . 1·39

†Containing nitrogen .. .. . 54 .. . 65

Total nitrogen .. .. . 1·70 .. . 2·04

A comparison of the composition of the improved hay with that from the unimproved pastures offers several points of interest.

1. In the first place it will be seen that the proportion of woody fibre in the good hay is much reduced—that is, in round numbers, from  $47\frac{1}{2}$  to 56 per cent.

2. The amount of soluble (*i. e.* readily digestible) albuminous or flesh-forming material is considerably increased in the good hay.

3. The total amount of albuminous compounds is increased from 8 per cent. to  $10\frac{1}{2}$  per cent., or one-fourth.

4. The difference in the relative proportion of sugar and other soluble matters is very marked—the bad hay containing only 10 per cent., the good hay nearly 15 per cent. of sugar.

5. The proportion of fatty and waxy constituents likewise is larger.

6. Lastly, the increase in the soluble mineral matter shows that the good hay is the more succulent. The later analysis agrees well with that of good meadow-hay, and shows conclusively that the produce of the improved pasture is greatly more nutritious and palatable than that which it bore in its original undrained and impoverished condition.

#### PROFITABLE CHARACTER OF THE OPERATIONS.

However interesting the above facts may be in a scientific point of view, the practical landlord and the enterprising tenant will require to know whether all these improvements were profitable, whether a good interest was secured for the outlay in works of a permanent nature, and a fair profit made on the tenant's capital. Unfortunately for the public, Mr. Ruck has not kept any exact and separate account of expenditure and income for this farm: we have to fall back upon a few particulars—from which, however, much may be gathered. Here is one. The last tenant paid 12s. an acre rent. After three years in Mr. Ruck's hands, and, as far as we can judge, without a very extravagant outlay, the grass-land has become worth fully 30s. an acre. The grass-land is about 150 acres: in 1864, 64 acres of this were mown; of the remainder, 27 acres carried 31 yearling beasts all the summer with corn; 22 acres maintained 25 yearlings. There were, besides, 100 ewes which were folded on the ploughed land at night. After mowing, the aftermath was hurdled off with the ewes eating corn.

The artificial food consists of a well-prepared mixture of several ingredients according to market value, generally barley, wheat, beans, bran, malt-dust, with cotton-seed and linseed cake. The cattle generally received about 4 lbs. a day and the sheep 1 lb. In addition to the horned stock and sheep, a large number of pigs

are fed each winter, generally over 60. The food is mixed up in quantities of 300 gallons at a time, water being laid on to the mixing-tub. Their ordinary mixture of food consists of 1 part of barley, 1 of wheat, 1 of beans, 1 of bran, and 1 of malt-dust; of course, a considerable quantity of straw is used besides what is grown on the 150 acres of arable land.

A word or two as to buildings and roads. The old premises were in keeping with the land. A thatched barn and a cart-hovel, as far as we remember, comprehended the sum total, forming two sides of a small ill-contrived yard. Mr. Ruck has added a large feeding-house and covered hay-barn; the latter joins the barn, and is so arranged that from the entrance of the barn a view is obtained throughout. In the erection of these buildings, he naturally sought to turn to the best account a large amount of second-rate oak timber, logwood, and faggots, derived from the grubbing up of old fences with their hedge-row timber, and therefore for use on the spot. The straw-barn is 80 × 50 ft., the feeding-shed as large; and the two, made entirely of timber, cost 290*l.*, which, considering the amount of accommodation, is very cheap. The covering of the feeding-house is composed chiefly of faggots resting on rough branches laid on the horizontal beams, and covered with thatch: there is a double roof with a gutter down the centre, which is thus arranged:—a large V-shaped wooden trough, with a 6-inch iron gutter at the apex, collects the water from the thatch, and gives it free passage to the iron trough below, whilst it catches and detains any bits of straw, &c., which would otherwise choke the iron piping. The water is collected at the further end of the building into a large reservoir provided with a pump, by the aid of which water is laid on to every feeding-box in the building. The feeding-house is capable of holding 48 beasts in 8 pens, and is equally useful for pigs. The pens on either side are divided by a central gangway containing a tramway for the feeding-barrow—a light ingenious apparatus which holds 40 bushels of chop. It is calculated that the animals can be fed in four minutes. The dimensions of each compartment are 20 × 23 ft. The bearings are 10 ft., the beams consist of Scotch fir poles laid across, carried by plates and posts of oak; round the centre posts are triangular cribs, which are filled daily, and the refuse turned out for litter. The pits are sunk 16 in. deep and well puddled. Besides the ordinary manger-room against the tramway, each pen contains two corner mangers, one on each side of the door; in these the refuse of the other mangers is placed, so that the weaker beasts may have a chance. The covered hay-barn, which is sufficiently large to hold all the hay and much of the straw, is a cheap and ingenious construction. The walls,

18 ft. high to eaves, carry a double roof, with a gutter supported on posts. It is constructed of foreign timber, except the outside uprights, which are strong oak-saplings. The butts of these are let into the ground, and as a matter of durability it may be questioned whether a little more outlay in providing a brick foundation would not have proved in the end more economical. Mr. Ruck has, however, shown how excellent accommodation, sufficiently permanent for the uses of a tenant, may be provided at a very moderate cost; and there can be no doubt that cases do occur, under which on a long lease it will answer the occupier's purpose to provide extra accommodation.

A cheap road has been made by burning the clay; but the thickness of metal is not sufficient to stand against heavy draughts. The surface of the road is 11 ft. wide, with a good fall to the drains on either side, which are 3 ft. deep, a 2-inch pipe being used and filled in to the surface with burnt earth. The thickness of metal does not exceed 5 or 6 inches. The cost of making such a road was only 112*l.* a mile—an extremely low sum; but then, as stated above, such a road is altogether unsuitable for heavy carting.

Before concluding our report we may mention, as a matter of curiosity, that Mr. Ruck has on his land at Braydon a mineral spring, which is held in high estimation by the people in the neighbourhood, and was described to us as possessing wonderful medicinal properties. The water in question has a weak saline taste, which reminds one of a mixture of Epsom and Glauber salts. It certainly possesses aperient properties, and no doubt, like other aperient springs, is useful in certain cases.

On evaporation, this mineral water left a saline residue, in which were found—

	Grains.
Organic matter and water of combination .. ..	7·91
Oxide of iron .. ..	·51
Lime .. ..	51·12
Magnesia .. ..	56·01
Potash .. ..	4·72
Soda .. ..	75·95
Chlorine .. ..	24·88
Sulphuric acid .. ..	194·60
Soluble silica .. ..	·20
Carbonic acid and loss .. ..	30·01
	445·91

By uniting together the preceding constituents obtained by direct determinations into the saline combinations, which may be supposed to occur naturally in the water, its composition may be represented as follows:—

*Composition of Mineral Water at Braydon Manor Farm, Wilts.*

An imperial gallon contains:—	Grains.
Organic matter and combined water .. .. .	7·91
Carbonate of protoxide of iron .. .. .	·74
Carbonate of lime .. .. .	75·55
Sulphate of lime .. .. .	21·43
Sulphate of magnesia .. .. .	168·03
Sulphate of soda .. .. .	124·10
Chloride of sodium .. .. .	41·01
Carbonate of potash .. .. .	6·93
Soluble silica .. .. .	·21
Total saline matter per gallon .. .. .	445·91

It will be seen that the water contains a variety of saline compounds, amongst which the large amount of sulphate of magnesia (Epsom salts) and sulphate of soda (Glauber salts) deserves to be specially noticed, inasmuch as the medicinal effects of the water appear to be mainly due to these salts. The analysis also shows an appreciable amount of carbonate of iron, held in solution by free carbonic acid. This compound of iron imparts a slight steely taste to the water, and no doubt adds to its medicinal virtues.

We could have wished that it had been in our power to give more exact details as to the cost of the management which we have described. Still, we trust sufficient has been adduced to show that grass-land on clay, however poor in its natural state, is capable of improvement, provided the water is removed and generous and judicious management carried out; and we venture to hope that those who may occupy or own land of a similar character will be encouraged from the experience we have detailed to go and do likewise.

---



---

 XXVI.—*On Agricultural Statistics and the Cattle Census.* By

JAMES LEWIS.

THE history of the abortive attempts which have again and again been made to induce successive Governments to set on foot a system of Agricultural Statistics in this country affords conclusive proof that to show the reasonableness and importance of a measure is not enough to insure its adoption. An idea which, at first originated by some ingenious observer, after long years of germination becomes of general acceptance, has yet a most formidable obstacle to overcome before it can receive practical application. Legislation, with us, follows public opinion as a guide, though oftentimes at a long distance behindhand, and very rarely endeavours to initiate a course of action. There is

in the machinery of Government a *vis inertiae* extremely difficult to overcome, and when any pressure is applied to it, its wheels creak and groan in indignant protestation against the disturbing power.

This has been in a remarkable degree verified by the fate of Agricultural Statistics in England.

Twenty-seven years ago the late Mr. G. R. Porter, then the chief of the Statistical Department of the Board of Trade and Secretary of the Statistical Society of London, thus wrote :—

“If throughout the whole range of *material* interests that affect the well-being of a community, there be any one subject of greater importance than another—which, more than any other, exercises an influence over the condition, the progress, and the happiness of all classes of society—without doubt that subject is the adequate supply of food for the people; and yet this is a subject which in our country has never hitherto been considered to any useful or practical end. What should we think of a general who should make no inquiries into the means that existed for the daily feeding of the army committed to his charge? and yet we supinely acquiesce in the apathy which has allowed the English Government to remain in ignorance of those means, with reference to the sustenance of the millions of which the nation is composed. Nay, more: we have allowed jealousies, prejudices, and the undefinable apprehensions of ignorance, to oppose every attempt at inquiry in this direction. The amount of our ignorance upon this most important subject is so great, that to this day the public is without any authentic document from which to know even the quantity of land under cultivation in any county of England.”\*

Mr. Porter subsequently remarks that—

“The importance of accurately knowing the provision made for the sustenance of the people is surely not less than that of knowing the yearly produce of various articles of commerce, which are employed as accessories in manufacturing processes. The condition of the crop of indigo in Bengal is accurately communicated to the merchants in London at the earliest moment when it can be known; and the information thus given has, through its influence upon the market price, an immediate effect in checking or promoting consumption. The like result is known to attend upon the collection of information concerning the growth of hops in this country, the extent of land devoted to the cultivation of that article being known through the records of the Excise Office, which is intrusted with the collection of the hop duty.”

It could not have been otherwise than galling to so eminent a statistician as Mr. Porter to know that his country contrasted unfavourably with others of less political significance in this deficiency of knowledge as to its food produce. In Belgium and Holland, he adds, “every kind of information connected with

---

\* Statistical Society's Journal, vol. ii. p. 291.

agriculture is obtained with the nicest accuracy :” the machinery employed being that of a body of gentlemen, usually proprietors of estates, corresponding with our justices of the peace, who undertake the general superintendence and revision of the returns as sent in to them by the farmers. In France also complete accounts of the agricultural produce are compiled from returns supplied by the mayors and local committees specially appointed for the purpose.

The records of the last quarter of a century show that the want so graphically illustrated by Mr. Porter has again and again prompted representative men of various interests to urge the Government of the day to supply that want; and on several occasions the cup has been raised to the very lips of the expectants only to be instantaneously shattered.

The article from the pen of Mr. Wren Hoskyns which appeared in the sixteenth volume of this Journal sets forth so clearly the advantages and the needfulness of taking stock periodically of the productions of our soil, that I am relieved from the necessity of attempting further to illustrate them in these pages. I assume that in the present day the feeling of the leading agriculturists is that, seeing the limited area of the country and the growing wants of its increasing population, it will soon become indispensable that they should have the fullest and most minute information, to enable them to develop to the utmost the resources under their control, if England is not to become almost entirely dependent on foreign aid for the food of her people. And now that after long years the Government has tardily given an instalment of the information so much desiderated, it may be interesting and useful to record here some of the circumstances relating to the past history of agricultural statistics.

Of the publications of the Board of Agriculture, which was established in England in 1793, and during its brief existence collected and published statements relating to the condition of agriculture in each county, very little is now known. Apparently the process of bringing forth those results was attended with a similar fate to that of those objects in the world of nature whose vital force is extinguished in one single effort; the Board was dissolved a few years after its establishment.

In 1831 an attempt was made by the Norfolk magistracy to collect the statistics of Norfolk, but although the experiment was conducted under favourable circumstances, only 426 persons out of the 680 who were applied to, returned any answer to the request made to them for information.

In 1836 the President of the Board of Trade (Mr. Poulett Thompson), participating in the desire generally felt of possess-

ing accurate information in place of conjecture or computations resting on an unsafe basis, directed a series of questions to be prepared, the answers to which would exhibit the leading facts relating to the productive powers of the soil. It was supposed that in the absence of any specially qualified and paid agents, the resident clergy might be disposed, as a matter of courtesy, very generally to assist the Government by returning answers to the questions; but as very considerable labour and expense would be incurred in printing and sending out the forms of inquiry, it was decided to test the probability of success by an experiment on one county alone. Application was therefore made to the clergymen of the 126 parishes of the county of Bedford, but the result was so unsatisfactory—only 27 of the clergy having made the requisite returns—that the attempt was felt to be hopeless, and was therefore abandoned. A reference to the details of the inquiry, which I have given in the appendix to this paper (p. 416), will show that they embraced a complete account of the quantity of land under cultivation, the extent of different crops, the number of each kind of stock, the produce in butter and cheese, and the average value of labour; and one cannot but regret that so valuable a work was found to be impracticable.

Isolated endeavours by individuals to ascertain the produce raised in their own districts or counties have at various times been made, but private inquiry, relying as it must do very largely upon estimates and approximations, can never yield results satisfactory for purposes of comparison and deduction. All honour, however, to those who have laboured in so good a cause: their efforts, seemingly insignificant though they may have been, undoubtedly are valuable, inasmuch as they serve to direct attention to the defects which a proper organization would obviate.

In 1845 an experiment on a small scale was made for obtaining returns in a specific locality in each division of the United Kingdom. For England, part of Hampshire was selected as the field of inquiry, through the agency of the Boards of Guardians, but the experiment ended in failure. In Scotland, the parish schoolmasters of the county of Mid-Lothian accomplished a satisfactory result; as was the case also in Ireland, where private agency, in the Bailieborough Union, was “entirely successful.”\*

In 1847 the apprehension of an impending famine led to the adoption of a system of agricultural statistics by the Irish executive, which has been steadily maintained, with increasing success, ever since. The constabulary procure the required information

---

\* Report of Select Committee on Agricultural Statistics (1855), p. 4.



from the farmers, and the returns are published under the supervision of the Registrar-General of Ireland.

In the same year (1847) which saw the inauguration of Produce Statistics in the sister island, the Vice-President of the Board of Trade (Mr. Milner Gibson) introduced a Bill into the House of Commons, entitled 'A Bill to make provision for the collection of Agricultural Statistics in England and Wales:' it was proposed that the machinery of the Registrar-General's Department should be employed, and forms were to be sent to all the occupiers of land *exceeding 3 acres* on or before the 1st of June in each year, the returns being classified and the results published by the Registrar-General for the use of the Board of Trade. Penalties were to be imposed for neglect or refusal to supply information. This Bill did not get to a second reading; the importance of the subject was admitted by different speakers, but the Government were not satisfied that sufficient interest was excited to enable them to pass the measure, and it was therefore abandoned.

The Highland Society had previously been in communication with the Board of Trade as to the best means of procedure for Scotland, and it was understood that a measure similar to the English Bill would have been proposed had that Bill not fallen through.

In 1849 Scotland was again in the field. The East Berwickshire Farmers' Club obtained the produce statistics of their county by means of the rural police: "nearly every parish gave the information sought for; and the total expense incurred was not more than 5*l*.\*

In 1852 the Highland Society again pressed the subject of Agricultural Statistics on the notice of the Board of Trade, and an authority was granted to them by the Government, in 1853, to work a scheme which had been prepared by Mr. Hall Maxwell † for collecting statistics in the three counties of Roxburgh, Haddington, and Sutherland, at an estimated cost of 900*l*., the actual outlay being 667*l*. A similar experiment was conducted in England at the same time—in Norfolk and Hants—at a cost of 850*l*.; and it is stated that, "under all the circumstances, the success attained was very remarkable, especially in the case of Norfolk, where, under the able management of Sir John Walsham, the failures were only  $2\frac{3}{4}$  per cent."

---

\* Report of Select Committee on Agricultural Statistics (1855), p. 4.

† Since this paper was written, the demise of Mr. Hall Maxwell has occurred; and in dealing with a subject for which that lamented gentleman felt the strongest interest and laboured so strenuously, it would be unbecoming to omit a tribute of regret for his loss, and of admiration for his life's work. Those who differed from Mr. Maxwell as to the means by which he sought the accomplishment of his design, can have no possible doubt that he had always in view the promotion of the best interests of agriculture.

In 1854 a further and greatly enlarged experiment was undertaken. The area in this instance embraced the whole of Scotland and eleven English and Welsh counties, and the *modus operandi* was the same as in the preceding year—namely, through the Highland Society in Scotland, and the Poor Law Board by means of its inspectors and officers in England. The relative success of the attempt in the two divisions of Great Britain was very much in favour of Scotland, where, “owing in great measure to the indefatigable exertions of Mr. Hall Maxwell,” the extent of failure was less than one-fifth per cent., whilst in England it amounted to about seven per cent.

In 1855 a Select Committee of the House of Lords was appointed to inquire into the best mode of obtaining accurate agricultural statistics from all parts of the United Kingdom; and after examining a number of witnesses representing the agricultural interest, and others, they drew up their Report, embodying their recommendations in certain resolutions, of which the following is an epitome:—

1. Systematic collection of statistics an object of national importance and utility.
2. Returns should be made compulsory under penalty.
3. Machinery: Board of Trade through Poor-Law officers in England and Wales, the Highland Society in Scotland, and the Constabulary in Ireland.
4. Two classes of returns should be annually obtained; the first, comprising returns of live stock and of acreage under each description of crop, to be sent in by the 15th of July; and the second, consisting of estimates of the produce of the harvest, to be made up between the 1st and 30th of November.
5. Power to modify Schedules.
6. The inquiries not to extend below holdings of *two acres* in England and Wales.
7. Parochial rate-books to be accessible to the officers employed in the collection.
8. Strict enforcement of the Act for taking corn-averages.
9. Expenses of collection to be defrayed out of the national exchequer.
10. Government should introduce a Bill into Parliament as early as possible for giving effect to the foregoing recommendations.

From whatever cause, the responsible Ministers took no legislative action on the recommendations of the Committee, and although, thanks to the persistent energy of MR. CAIRD, who for many years stood *in loco parentis* to the subject, agricultural statistics formed an annual topic of discussion within the walls

of Parliament, nothing was done towards the establishment of the much-needed organization to supply the national deficiency.

But a powerful auxiliary had already entered the field in the guise of the International Statistical Congress, which, at its first meeting in Brussels, in 1853, formulated its opinion on the importance of agricultural statistics. At the subsequent meeting of the Congress in Paris, the fact that Great Britain had still no information to offer with regard to its food supply, could not have been otherwise than humiliating to her representatives on that occasion. And when the Congress held its meeting in London, in 1860, the late illustrious Prince Consort, in his capacity of President, was constrained to acknowledge, in the presence of the most distinguished statisticians of Europe, then congregated before him, our unpardonable *lâches* on a question of such vital importance.

During the sittings of the London Congress, both Mr. Caird and the Registrar-General of Ireland (Mr. Donnelly) contributed very valuable papers on agricultural statistics, and after an interesting discussion,\* the Congress unanimously adopted the following propositions:—

1. That it is desirable in every state to determine the quantities of the principal kinds of produce annually.

2. That in the case of agriculture the area of the land under each crop should be annually returned, and a return of the live stock obtained not less frequently than once in every five years, and if possible every year. The quantity of the produce should also be estimated. The means to be employed should vary according to the circumstances of each state; but especial care should be taken to avoid exciting the prejudices or apprehensions of cultivators by unnecessary inquiries.

Mr. Donnelly's testimony with regard to the working of the system in Ireland is most valuable, and ought to be conclusive upon the perfect practicability of obtaining similar information in Great Britain. We quote his words in their entirety, since, if duly weighed and considered, they can hardly fail to remove the prejudices of those who are still in fear that the tax-gatherer or the landlord may be seeking to take advantage of them:—

“I may mention that the information contained in these statistics has been given with the greatest good will. I have now been in London some weeks for the purpose of attending this Congress. I receive daily reports from my office in Dublin, and am informed that up to the present time there has not been a single objection this year made by any man in Ireland to give the required information to the

\* Report of London Session of International Statistical Congress, pp. 314-319.

enumerators; in fact, a degree of confidence has grown up on the subject which is very creditable to the country at large; so that as regards both the acreage under crops, and the number of live stock, the particulars are readily given by the occupiers of land and owners of stock. I believe the great secret of this success is that all parties now feel entire confidence that there will not be any disclosure of individual affairs, the returns being considered by me as strictly confidential, and only published in General Abstracts. I recollect, ten years ago, the same suspicion and reluctance existed in Ireland to give the returns which prevail in some parts of England; but I firmly believe that when the farmers in England are made aware of the fact that nothing is in reality disclosed with regard to individual farms, but that the information they afford is merely used for the purpose of being published in General Abstracts for a whole county, or portions of a county, my conviction is that you will then attain the same degree of satisfaction which I am happy to say we now experience in Ireland. In order, however, to accomplish this, I venture to suggest that it is most important to use every possible means to obtain the concurrence of the landed proprietors and the tenant farmers themselves, not, I would say, by legislation, but by appealing to their good sense, and their own self-interest, because I do, with very great respect, maintain that their self-interest is very much concerned in this matter; how important it must be for them to know, say in the month of September, what is the acreage of the crops in all England, because to a certain extent that knowledge will afford them data from which they may derive very valuable information. With reference to the complaint as to the opposition of the public press, which has been alluded to by a gentleman who addressed us, I must say, that, so far as my own experience is concerned, I have found it to be a powerful and valuable ally in removing prejudices against the collection of these returns; and I have, on all occasions, to express my grateful thanks not only to the farmers, but also to the public press, for their generous assistance. As soon as the returns are published, I send a copy of them to every paper in Ireland, and also to some of the principal papers in England and Scotland, and I have found the friendly co-operation of the press to be of the utmost value, as by it early publicity is given to the returns, and the advantage of them pointed out to the community at large.

“On the point of the collection of the average yield, that is rather a difficult thing to arrive at, because much reluctance will naturally exist in the minds of many farmers to give the yield of their farms, particularly if they have any apprehension that their average rates of produce may become known to those who they think may make an unfriendly use of the information; when, however, they are satisfied that these average rates of produce are published only for large districts, and are not given for individual farms, their objections will be gradually overcome. There are 163 Poor Law Unions in Ireland, and these are subdivided into ‘Electoral Divisions,’ which vary very much in size, containing, perhaps, 4,000, 5,000, or 8,000 acres, or more; the yield of the crops in each electoral division is obtained by consulting

the most intelligent landholders, and procuring their opinion on the point as to what 'one acre with another' will yield, of wheat, oats, barley, rye, potatoes, and various other crops; these rates are then submitted for revision to the Boards of Guardians, which, being generally composed of landed proprietors and tenant farmers, are particularly qualified to give an opinion as to the average yield in the several Poor Law Unions, and the rates of produce so obtained are finally published by counties and provinces. The great point in dealing with inquiries of this nature is to remove every possible ground for supposing that the private circumstances of the farmers are in any way disclosed, or that the information is to be used in the slightest degree to their prejudice. It is by acting on this principle that we have overcome the difficulty which did exist in Ireland, and will, I believe, exist in every country when an attempt is first made to obtain such returns. I also hold that the publicity given to these returns has been productive of much benefit. The cost incurred has been very trifling—about one penny for two of these [referring to some printed returns]—compared with the good effect that the extensive circulation of the information has produced in the minds of the public; and I am happy to say that in this case the Government has permitted me to circulate these returns very extensively, and for 3*l.* 10*s.* I am enabled to distribute 10,000 copies of these abstracts; I send one to every magistrate throughout the country, to each clergyman of every denomination, and to other influential parties; and by this means we have allies in every district. When a small farmer is asked questions as to the acreage under his crops, their yield, or the number of his cattle, not improbably the first thing he would do would be to go to his clergyman, or to some intelligent neighbour, and say, 'I am asked certain questions: shall I answer them?' The reply would be, 'Well, I can see no objection; they can do no harm; there will be no disclosure of your private affairs.' He then gives the required information. By this means we remove the prejudices which exist in the minds of the uneducated classes, and sometimes in those of the educated also; and I believe that for the general success of these statistics we are mainly indebted to the friendly co-operation of the gentry, clergy, and tenant farmers of Ireland, to which I have already alluded."\*

The cost attending the collection and compilation of the Irish Agricultural Statistics is about 3000*l.* a year; it must be remembered, however, that the enumerators, who all belong to the constabulary, receive no extra pay for their services. The time occupied in the collection is from six to eight weeks, and the enumerators visit each farm or holding to ascertain from the occupier or some person connected with the farm the particulars required for the returns. The results are published to show:—

1. The acreage under the principal crops.
2. The estimated produce of the principal crops.

---

\* Int. Stat. Congress Report, p. 315.

3. The estimated yield per acre.
4. The holdings divided into classes according to size.
5. The number and ages of live stock.
6. The value of live stock.
7. The area under arable land, plantations, towns, and water; also the extent not under cultivation.

It may not be amiss to quote here the concluding paragraph of Mr. Donnelly's Report on the Agricultural Statistics of Ireland for 1865, wherein he says :—

“I beg to observe that on no former occasion during the fifteen years in which I have had charge of these statistics, has a more friendly interest been exhibited towards them, or a greater desire shown to learn the results of the enumeration; and I have again the gratification to state that, almost without exception, the enumerators did not experience any difficulty, as the required information has been most readily afforded by the resident landed proprietors and tenant farmers of every class.”

One cannot help feeling that if it be really true that in discontented, unhappy Ireland there is an absence of the blind and ignorant prejudice which has been the *bête noir* of the Government in its dealings with the agriculturists of England, the comparison tells wofully against our boasted superiority.

The general opinion of the Congress was, that whatever objections might be entertained on the first introduction of a comprehensive system of agricultural statistics in Great Britain, on the part of the small tenant farmers, they would soon be as anxious as their more intelligent brethren to avail themselves of its manifest advantages.

Professor Simonds drew the attention of the Congress to a very important matter in connection with the statistics of cattle, and his observations are too significant to be omitted here :—

“Every gentleman will admit the necessity of obtaining, if we can, the return of live stock every year; and not only is it important that the return of live stock should be made every year, but that we should also be enabled, if we could, to ascertain what amount of it was in a fit state to go into the market, and what was the amount of store stock in the possession of every individual. It must be evident to persons here who are acquainted with the subject, that store stock, as we commonly call it, is not fit at once for food; and the quantity of store stock which an individual will be enabled to keep, and raise, ultimately to come into the market as food, will materially depend on the quantity of grass he has, as well as of other produce. But there is one other thing which it strikes me we must guard against in attempting to obtain a return of this kind, and that is, our not having duplicate returns. We know that into this country we have introduced a large quantity of foreign cattle, and a large quantity of sheep

and pigs, as so much food for the people. . We know that, practically, a great number of these animals do not at once find their way to the butcher; that a large number are taken into different parts of the country, where they are fed as store stock, and afterwards they come in as food. We also obtain from Ireland a considerable supply of cattle; and we must, therefore, in the returns of our stock, take care not to confound the quantities that are sent from Ireland with that which we produce in England. It seems also to me that as there would, perhaps, be little or no difficulty in ascertaining these facts, as far as they are applicable to Ireland and the Continent in general, it would be only right for us to take the same care with reference to Scotland, because in some parts of the country store stock is introduced from Scotland, and fed, and not produced within this country. There should be some machinery in operation for the purpose of ascertaining all the imports that have taken place into this country, in order to guard against any duplicate returns, or rather, I should say, false returns, that might be made as to the number of store stock and the fat cattle. . . .

“It is well known that if we look to the Continent of Europe we not only get returns of the quantity of stock in a given country, but we also have returns as to the state of health of that particular stock. . . . At the present time there exists in this country, and has existed for many years, a most destructive epizootic disease, which has raged on the Continent, and also to a considerable extent in Ireland; and we not only do not know anything of the losses which the country sustains in consequence of the prevalence of that disease, but we are at a loss to understand the location of the disease. Now I think every gentleman will admit that this is not such a state of things as ought to be permitted to exist in a country like England. On the contrary, if I turn to France, or Belgium, or Austria, or any part of the Continent of Europe, I find there are returns made from each department of the number of animals affected with any disease, the number of deaths that take place from such affections; and in any measure which might be recommended for general adoption by this country, I think we should not lose sight of this particular part of the question. The losses are sometimes very frightful. We have all heard of the great increase in the price of provisions, in consequence of the scarcity and the increased value of agricultural produce; that meat has risen considerably in price. Every one knows that there have been many causes in operation for that, and among them the great destruction of some of the crops of last year. . . . This has had a considerable influence upon the value of the stock. There is also another cause, and that is the cause I have alluded to, namely, the inroads of epizootic disease among the animals, and the great number that have been destroyed by it. I will only take one instance, which was brought to my knowledge through the kindness of Lord Berners, in his own district of Leicestershire, where the mortality among the sheep has amounted to something like 50 per cent. of young sheep this year, not including the lambs of this year.”\*

---

\* Int. Stat. Congress Report, p. 315.

Professor Simonds also drew attention to the circumstance that *more epizootic diseases have prevailed during the last twenty years than for one hundred years previously*; and he subsequently carried the following proposition:—"That in relation to the causes affecting public health it is exceedingly desirable that means be adopted for ascertaining the extent in fatality of epizootic and other diseases among those animals which are ordinarily used as food, and that it be recommended to be carried into effect by the authorities appointing veterinary surgeons and other officers of a similar kind."

I have endeavoured to link the chief features of interest in connection with the history of the important subject of agricultural statistics into a consecutive chain, so that the readers of this Journal may hereafter have a more convenient reference to the whole matter than is implied in hunting up the different Blue Books and other documents—*disjecta membra*—wherein the particulars now collated lie entombed.

Hitherto I have been dealing with what may be called the period of hope deferred: now I come to the period of fruition, which was heralded by the announcement of the President of the Board of Trade in the House of Commons, in March 1865, as a reply to a question by Mr. Caird, that a sum of money would be asked for during the session to enable him to carry into effect the resolution of the House with regard to agricultural statistics. On the succeeding 12th of June a sum of 10,000*l.* was voted to be applied in obtaining the necessary information. Before the end of that month of June the disease which eventually attained to so terrible a magnitude in Great Britain, made its first appearance in London, and in a short space of time gave proof of its fell malignity. On the 29th of September a Royal Commission was issued for an investigation of the "Origin and Nature of the Contagious or Infectious Disorder now prevailing among the Cattle of Great Britain"; and the Commissioners, after having taken evidence on such points as seemed to them most urgent, wrote by their secretary, on the 24th of October, to the Board of Trade, representing "the importance of obtaining correct information respecting the number of horned cattle and sheep in the country." The reply from the Board of Trade, dated 3rd November, states that "the representation of the Commissioners has received the prompt and anxious consideration of my Lords, and they entirely concur with Her Majesty's Commissioners as to the importance of ascertaining the stock of cattle existing in this country. If such information were obtained it could not fail to be of great utility and interest at the present time to the agriculturists as well as to the public at large. *It appears that this country is almost exceptional in not*



*possessing returns of the number of its cattle.* Unfortunately it is for the chief division of the United Kingdom, England and Wales, that there is an entire absence of information, upon which reliance can be placed, as to the stock of cattle." The Board remarks that the voluntary principle has been successful in Ireland and Scotland, and it is only "in a similar way that the same particulars could at present be collected for England and Wales." The Board further expresses itself as most desirous to promote the inquiry proposed by the Commission, "and will take immediate steps to invite the co-operation of English agriculturists in a work of such manifest interest and importance;" and orders would forthwith be given for the preparation and distribution of such schedules as were necessary for the inquiry. It was expressly stated that "the number of live stock belonging to individual persons will not be divulged."\*

A month elapsed from the date of the foregoing communication; and on the 6th of December, by which time 43,000 cattle had been attacked by rinderpest, the Board of Trade wrote to the Home Office "to move Secretary Sir George Grey to cause the county magistrates of England and Wales, and the corresponding authorities in Scotland, to be informed of the steps about to be taken by the Board of Trade;" and on the 8th of December Sir George Grey addressed a circular letter to the Lords Lieutenant of the several counties asking them to render such assistance as might be necessary.

The preliminary steps having been thus completed, we arrive at the period when action was finally taken, and the *experimentum crucis* fairly entered upon.

It had been decided that the returns of stock should be obtained through the medium of the officers of Inland Revenue, and accordingly the necessary schedules were prepared and distributed to the owners of stock, including cowkeepers and dairymen, in towns. The surveyors of taxes were made the medium of communication with the stock-owners, in whose hands the requisite forms were placed in time for them to return the different kinds of stock in their possession on the 5th of March. The schedules, properly filled up, were directed to be returned by post to the surveyor of taxes for the district; the surveyor had then to collate the returns for the whole of his district and forward the results to the Board of Inland Revenue at Somerset House as quickly as possible; and the Inland Revenue Department had then the duty of getting all the different heads of information complete for counties, in which form the return was prepared for the Board of Trade to lay before Parliament.

---

\* First Report of Cattle Plague Commissioners. Appendix E., p. 180.

It may be remarked here, parenthetically, that, although the whole of the labour of preparing the return had devolved on the Inland Revenue Department, the signature attached to the Report was that of the Head of the Statistical Branch of the Board of Trade.

The Return of Live Stock was made public on the 7th of May, and in view of its special relation to the class constituting the readers of this Journal, I propose to comment briefly on some of its leading features. I am, I think, quite justified in remarking on what is "conspicuous by its absence," namely, those necessary explanatory observations without which the return is in many respects deprived of its full value, inasmuch as the key to the elucidation of many doubtful points is thereby wanting. Nothing is given but the bare figures of the return, which are thrown, as though grudgingly, before the public, like the pieces of a child's puzzle, to be put together by the light of our unaided judgment. We are not told how many schedules were distributed, and how many defaulters there were; the limit of holding, the number of owners, the *modus operandi*, the estimate of stock unreturned, the cost—all matters of interest and importance, as so many beacons to warn us from erroneous inference—upon all these points we must just come to the best conclusion we can, for the officials, who had these items before them in black and white, were uncommunicative. The fact is, the Board of Trade knew nothing, and therefore had nothing to say, whilst the Revenue Department is so accustomed to official reserve in its ordinary transactions that, apparently, it could not shake off its traditions under circumstances wherein publicity was an essential.

This reticence is the more to be wondered at when there is great reason to believe that nothing but credit attaches to the Revenue officers in respect of the cattle returns. In some instances they must have encountered great difficulties in remote districts, where the postal arrangements are so defective that more than a week has been known to elapse in the delivery of a letter. In the Welsh districts varying *patois* in dialects of the Celtic tongue are still the language of the people, and one would especially like to know how such a formidable obstacle as this was overcome.

The mischief is that, in the absence of any reliable statement of the defects of the Cattle Census, everybody is at liberty to assume for himself the existence of such defects as seem to him probable. Hence confused and contradictory conclusions will no doubt be drawn, as they will be based not on the general average defects for the whole kingdom, but on the defects of special localities.

We know, for instance, that the lambs in many counties were not included, as the returns were made before the lambs in back-

ward districts were dropped ; but some indication, less general in its character than “the northern counties of England and Scotland,” ought to have been given of the different counties where this was observed. Lambs were certainly omitted in other than the northern counties, as is within my knowledge.

As to defects arising from neglect or refusal to fill up the returns, that must be left entirely to conjecture in the absence of any guiding principle to reason upon. I have papers before me from independent authorities which convince me that amongst the least intelligent class of farmers, especially in districts remote from the civilizing influence of towns, a jealous distrust of all official-looking forms, which are associated in their minds with increased taxation, and a dislike to revealing their affairs, operated unfavourably against a correct return. More than one case has been mentioned to me in which political dislike towards Mr. Gladstone, on account of that statesman’s policy on the Malt Tax question, was alleged as a cause for declining to make the return. But the general result of my inquiries goes to show that all this distrust and misunderstanding of the object of the returns would soon disappear, and that if another census were taken next year or the year after, a very great improvement in the quality of the returns would be manifest. On the whole, therefore, I think the general result of the experiment cannot be deemed otherwise than highly satisfactory, and that such defects in the system as have been observed admit of easy remedy.

Before proceeding to analyse this return of live stock, I will briefly refer to some of the estimates which have found currency in past years, as to the quantity of live stock in Great Britain, inasmuch as it would seem that rather extravagant notions have been accepted. At several of the county meetings held since the advent of rinderpest, speakers, well informed on agricultural matters, quoted the estimated stock of cattle in Great Britain at seven million head, and, taking the official statement of the Registrar-General of Ireland, that country counted for another  $3\frac{1}{2}$  millions ; so the imaginary wealth of the United Kingdom was set down at a round aggregate of eleven millions of beeves.

How this estimate was arrived at I do not know, but it certainly turns out to be far from correct. In the absence of specific knowledge upon any subject where numbers are concerned, the inquirer naturally endeavours to arrive at some approximation by extending the conclusions deducible from limited observation. This has notably been done in the case of the live stock in the United Kingdom by some of the principal writers on the wealth and resources of the British Empire ; and it cannot be otherwise than interesting to note here the results of a few of those estimates.

Arthur Young in his 'Eastern and Northern Tours' has given two estimates of the number and value of the different descriptions of stock in England, which differ widely in their results; but in the second part of his 'Political Arithmetic' (p. 28) he gives an average of his two former statements as an estimate of the stock of England in 1779. Mr. McCulloch, in his 'Statistical Account of the British Empire' (Edition of 1847, vol. i. p. 499), quotes Young's latter estimate, which he says "is probably nearer the truth than either of the separate estimates on which it is bottomed, though even it can be regarded only as a very rude approximation":—

Cows .. .. .	1,039,754
Fatting beasts .. .. .	758,425
Young cattle .. .. .	1,571,308
<hr/>	
Total .. .. .	3,369,487
Add McCulloch's estimate for oxen employed in hus- bandry at the same period .. .. .	} 150,000
<hr/>	
Estimated total stock of cattle in England and Wales in } 1779 .. .. .	3,519,487
Estimated increase since 1779 .. .. .	1,000,000
<hr/>	
	4,519,487
Add for Scotland the number of cattle as given in the } General Report of Scotland .. .. .	1,100,000
<hr/>	
Total stock of cattle in Great Britain according to } McCulloch (1847) .. .. .	5,619,487
Horned cattle in Ireland (Census of 1841) .. .. .	1,863,116
<hr/>	
Total in United Kingdom .. .. .	7,482,603

So that in round numbers we may take the horned stock of the whole of the United Kingdom, as estimated above, to have been in 1847 about 7,500,000.

At the same date McCulloch estimates the sheep and lambs in

England and Wales at .. .. .	26,148,463
Scotland .. .. .	3,500,000
Ireland (1841) .. .. .	2,106,189
<hr/>	
United Kingdom .. .. .	31,754,652

Or, in round numbers, the total number of sheep in the whole of the United Kingdom in 1847 may be taken as 32,000,000. Some French authors\* have credited us with a much larger number of the ovine race. M. Ternaux, a celebrated breeder and flock-master, reckoned us to possess 45,000,000 sheep, while another authority rated us still higher, as possessing 55,000,000, France having only 30,000,000.

\* Paper by Earl Lovelace 'On French Agriculture,' in Statistical Society's Journal, vol. ii, p. 311.

Of horses, McCulloch estimated there were 1,500,000 in Great Britain, employed for various purposes of pleasure and utility. Earl Lovelace, however, remarks that ponies and exempted horses are omitted from McCulloch's estimate, and thinks it probable we have not less than 2,000,000 horses of all sorts.

But without going into the particulars of the various estimates which have been from time to time made, it will be convenient to bring the different accounts into tabular comparison as far as possible.

LIVE STOCK in ENGLAND and WALES at different periods.

Stock.	Colquhoun* (1812).	McCulloch † (1847).	Poor-Law Board (1854). ‡	Census of 1866.
Horses .. .. .	1,500,000	1,500,000	1,309,010	.. ..
Cattle .. .. .	5,500,000	4,519,487	3,423,165	3,848,435
Sheep .. .. .	25,000,000	26,148,463	18,691,088	16,793,204
Pigs .. .. .	.. ..	.. ..	2,363,724	2,257,903

From this Table we are enabled to see in what degree the recent census supports the estimates of former years; and the result of the comparison, so far as cattle are concerned, is on the whole tolerably satisfactory. Mr. Colquhoun's estimate of cattle in 1812 is the only one of the three which is out of all judgment: and if Mr. McCulloch had not assumed an increase of a million on Arthur Young's estimate (1790), he would have been very near the correct figure. The estimate of the Poor Law Board (1854) was arrived at by assuming that, as they had returns from eleven counties, the remainder might be supposed to possess stock in proportion to their area; and, singularly enough, this presumption, which is certainly not in accordance with subsequent observation, brought out a result which was a very near approximation to the truth. One point seems pretty clearly established, viz., that our stock of cattle is not on the increase, but rather the reverse, though no positive conclusion can be drawn on this point until we have seen how subsequent enumerations tally with the one recently taken. By limiting the returns to the owners of not less than three-acre holdings, a considerable number of cattle have of course been omitted over and above those belonging to recalcitrant owners who declined to send in returns; and it would probably not be unsafe to reckon the actual cattle stock of England and Wales at the present time at about 4,000,000.

We have no means of knowing how far the actual number of horses in England agrees with the estimates of 1812, 1847, and

\* 'Food Supplies of Western Europe,' by Joseph Fisher, p. 251.

† 'Statistical Account of the British Empire,' vol. i.

‡ 'Reports of Poor Law Inspectors on Agricultural Statistics of England, 1854,' page 2.

1854; and the omission of the equine race from the census of live stock is testimony to the provisional and experimental character of that measure. The very great divergence in the estimated number of sheep at the different periods may be partly accounted for if we suppose that the estimates were not all made at the same season of the year. At the recent census the lambs in many counties were omitted altogether, owing to the date at which the returns were made, and therefore it is useless to seek for any reconciliation of the several statements, whilst it would be certainly an unwarrantable conclusion to assume any great decrease in the actual number of sheep without more reliable data to build upon.

The following Table gives a summary view of the results of the Cattle Census for the United Kingdom, and its component divisions:—

TOTAL NUMBER of CATTLE, SHEEP, and PIGS in each DIVISION of the UNITED KINGDOM.

Divisions of the Kingdom.	CATTLE.			Sheep.	Pigs.	Total Stock.
	Cows.	Other Cattle.	Total Cattle.			
England . . . . .	1,277,077	1,993,222	3,270,299	14,993,383	2,053,147	20,316,829
Wales . . . . .	235,908	342,138	578,136	1,799,821	204,756	2,582,713
Scotland . . . . .	370,447	566,954	937,401	5,255,077	219,716	6,412,194
Great Britain. . . . .	1,883,522	2,902,314	4,785,836	22,048,281	2,477,619	29,311,736
Ireland . . . . .	1,386,176	2,107,238	3,493,414	3,688,742	1,299,893	8,482,049
Islands in the British Seas .	16,600	21,100	37,700	57,685	22,887	118,272
United Kingdom . . . . .	3,286,298	5,030,652	8,316,950	25,794,708	3,800,399	37,912,057

According to this statement the entire edible stock of the United Kingdom amounts to about 38 million head: of which 8 million are cattle, 26 million sheep, and 4 million pigs. McCulloch's estimate in 1847 was  $7\frac{1}{2}$  millions cattle, and 32 million sheep; and the reason why he so closely approximates to the truth with respect to the cattle for the whole of the kingdom, while, as I have shown, his numbers for England and Wales were exaggerated, is that he only takes the cattle in Ireland at one-half the number at present returned. For Scotland the following results of different inquiries may be quoted in conjunction with the recent census:—

	McCulloch (1847).	Collected by the Highland Society.		Census of 1866.
		1854.	1855.	
Cattle .. .. .	1,100,000	935,871	974,728	937,401
Sheep .. .. .	3,500,000	4,787,235	5,694,737	5,255,077

And here, again, it is unsafe to draw any general conclusion without strong grounds for an assurance that the above returns are fairly comparable. To an ordinary observer there is no apparent cause for any diminution of stock in the United Kingdom. I am aware it has been held that the tendency towards amalgamation of small holdings must inevitably have the effect of decreasing the horned stock of the country; but this view does not harmonize with the generally received doctrines of the older political economists, and needs the most positive proof in its favour before it can be accepted.

With the view of getting a more accurate idea of the distribution of the different kinds of stock throughout the United Kingdom than is conveyed by the mere absolute numbers, without reference to their relative value when reduced to a common basis, I subjoin a Table in which the proportion of stock to area and also to population in the different divisions is exhibited.

DISTRIBUTION of LIVE STOCK in the UNITED KINGDOM in proportion to AREA and POPULATION.

Divisions of the Kingdom.	Area in Acres.	Population (1861).	Proportion of Stock to every 100 Acres of Area.						Proportion of Stock to every 100 of Population.	
			Cows.	Other Cattle.	Total Cattle.	Sheep.	Pigs.	Total Stock.	Total Cattle.	Total Stock.
England . . . . .	32,221,998	18,779,811	4·0	6·2	10·2	46·5	6·4	63·1	17·4	108·2
Wales . . . . .	5,102,885	1,286,413	4·6	6·7	11·3	35·3	4·0	50·6	44·9	200·7
Scotland . . . . .	19,639,377	3,062,294	1·9	2·9	4·8	26·8	1·1	32·7	30·6	209·4
Great Britain . . . . .	56,964,260	23,128,518	3·3	5·1	8·4	38·7	4·3	51·4	20·7	126·7
Ireland . . . . .	20,815,111	5,798,967	6·7	10·1	16·8	17·7	6·2	40·7	60·2	146·3
Islands in British Seas	226,684	143,447	7·3	9·3	16·6	25·5	10·1	52·2	26·3	82·4
United Kingdom . . . . .	78,006,055	29,070,932	4·2	6·4	10·6	33·1	4·9	48·6	28·6	130·4

We see here that of the several divisions of the realm Ireland possesses the greatest number of cattle, England the greatest number of sheep, our adjacent islands the greatest number of pigs, and England the greatest number of stock of all kinds in proportion to their several areas. Ireland also has more cattle in proportion to her population than any of the other divisions, while Scotland is richest in stock of all kinds in the same regard. The foregoing Table would be more valuable for deduction if the area under cultivation, as distinguished from waste, in each division were accurately known; and here again the want of a complete system of agricultural statistics is evidenced. At present we can only proceed on the broad principle of approximation, which enables us to say that such and such things are facts, and, *cæteris paribus*, certain conclusions follow from those facts; the proviso assumed constituting the point upon which

the conclusions are assailable. So the fact that the islands adjoining our shores contain nearly four times as many cattle in proportion to their area as does Scotland, is one which needs qualifying by the light of more detailed information before we can safely generalise from the greater wealth of the islands in bees.

It is only when we come to smaller subdivisions in which there are general features of uniformity that comparisons are less open to objection. An English or a Scotch county, although it possesses varied features, will yet in its leading characteristics have in most cases a degree of homogeneity which would be wanting in a kingdom made up of a number of such counties.

I have appended to this paper Tables which show the results of the recent Cattle Census for each county in England, Wales, and Scotland. It would be futile to attempt a minute analysis of these Tables within the space now remaining at my disposal. They will no doubt receive careful study from the readers of this Journal, who will be able to deduce from them much that is both important and interesting to agriculturists as well as to the public at large.

I have also referred to the Returns of Stock for certain counties which were obtained through the agency of the Poor-Law Board in 1854, and have tabulated the corresponding results in the two periods of 1854 and 1866 for each of the 11 counties specified in the earlier year:—

COUNTIES.	Returns of Poor-Law Board (1854).			Cattle Census (1866).		
	Cattle.	Sheep.	Pigs.	Cattle.	Sheep. <sup>1</sup>	Pigs.
Hants .. ..	24,871	282,160	42,039	48,688	619,598	79,789
Wilts .. ..	35,241	418,197	27,998	77,724	596,822	61,012
Leicester .. ..	85,764	292,231	21,093	89,115	290,554	23,250
Norfolk .. ..	99,928	841,601	99,773	92,386	596,683	115,876
Suffolk .. ..	46,097	405,944	107,921	55,767	407,929	133,498
Berks .. ..	14,024	144,259	24,888	30,149	327,316	41,265
Worcester .. ..	30,902	165,037	25,657	45,789	204,154	36,686
Brecknock .. ..	32,697	243,543	8,367	29,604	212,515	7,367
Salop' .. ..	85,780	310,199	45,038	107,208	327,612	59,674
Denbigh .. ..	45,574	35,284	19,070	46,695	150,565	26,529
West Riding .. ..	207,333	639,410	68,561	189,341	500,196	72,048

It is plain from the discrepancies between the numbers of different kinds of stock in the two periods in the several counties, that no equitable comparison can be instituted in the absence of such information as would show the peculiar circumstances under which the two returns were made. The investigation of 1854 did not commence until after harvest-time, and many of the schedules were not sent in before the beginning of 1855; whereas the recent census was specifically fixed for a given day—the 5th



of March—and this difference of date will doubtless account for the wide variation in the two results.

This question of date is of the utmost importance in all statistical inquiries, and above all in the case of stock, either live or dead, which fluctuates so largely with the seasons of the year; it is probably from this point being overlooked that “doctors” have so much “disagreed” in their estimates of the cattle stock of this and other countries. If all the counties of England and Scotland were alike in their treatment of live stock, the difference of the date of enumeration would be less important; but as one county breeds stock for the supply of another, which grazes or milks but does not breed, the relative stock of these two counties will depend entirely on the time of year at which their numbers are taken. If this be not the explanation of such a fact, for instance, as that Wiltshire is stated to have had 35,241 cattle, 418,197 sheep, and 27,998 pigs in 1854, whereas that county is returned in 1866 as possessing 77,724 cattle (more than double the first return), 596,822 sheep, and 61,012 pigs, it is difficult to understand what is the cause of the difference. It can hardly be attributed to any great increase in the proportion of returns sent in this year, for in 1854 no less than 87½ per cent. of the schedules were returned with the information supplied either by the occupier or by the enumerator, and it is scarcely likely that a very much higher proportion of farmers made the return on this last occasion. Hampshire, Suffolk, Berks, Worcester, and Salop are all credited with a great increase of cattle; while in Norfolk, the West Riding, and Brecknockshire—counties which showed the highest proportion of complete schedules in 1854—the cattle appear by the Table to have decreased. The numbers of sheep and pigs also differ so widely as to make it clear that the basis of comparison is not uniform. I point out these divergences to show how extremely difficult—nay, how impossible—it is to go beyond the merest statement of fact in dealing with statistics of so imperfect a nature as characterises all our agricultural data up to the present time. Under these circumstances I have no alternative but to let the figures of the recent cattle census speak for themselves, until the Inland Revenue Department shall think fit to enlighten us on those doubtful points which make their return so unsatisfactory for purposes of comparative deduction. If that information be supplied it will convert the Return of Live Stock in 1866 into a valuable point of departure for comparison with subsequent enumerations, but without it the thing will remain *sui generis*, an isolated fragment, useful to a certain degree, but having no legitimate connection with any future return.

In the annexed Tables will be found all the particulars of the Returns of Live Stock as laid before Parliament for each county

of England, Wales, and Scotland, arranged, on the plan of the Registrar-General, in topographical order, which is in every way preferable to the alphabetical plan adopted in the return, which brings into close proximity Cornwall and Cumberland, Derby and Devon, and so on. In addition to the number of the different kinds of stock, I have given the calculated proportion of stock to the acreage of each county, which is taken from the Weekly Return issued by Mr. W. Clode, the superintendent of the Statistical Branch of the Cattle Plague Department; the ratio of stock to population I have calculated specially for present reference. The advantage of such a view of the distribution of cattle will be obvious from this one example:—Cheshire possesses 247,725 head of cattle, sheep, and pigs; Lancashire, the adjoining county, has double that number (470,542) of stock; but in proportion to the area of the two counties Cheshire has almost as many head of stock per acre as Lancashire, whilst it has more than twice as many head of stock in proportion to its population.

I also append Tables showing the number and relative proportions of the different kinds of stock possessed by foreign countries. The population and number of stock are taken from the Board of Trade Return, and the area I have given from the most authentic sources, so as to correspond as nearly as possible with the population. I have not yet had an opportunity of verifying the figures of the return with the official statements of the different countries, and as no clue is given to the date to which the population refers, it is difficult in these days of territorial changes to identify an undated population with any specific area. With regard, for instance, to Russia, the population quoted by the Board of Trade includes the Asiatic dominions, and I have consequently given the area corresponding thereto, but it is by no means certain that the Returns of Stock include the cattle of Asiatic Russia. With this proviso, we may gather from the Table that, ranging the different states in the order of their numerical wealth of horned cattle in proportion to their areas, Holland has the greatest number; then follow Belgium, the German States, Denmark, France, the United Kingdom, Austria, Prussia, Sweden, the United States, and Russia. Of sheep, the United Kingdom heads the list with 33 sheep to every 100 acres of area, France has 27, Prussia 27, Spain and Denmark 19, the German States 15, Holland 13, Austria 11, Belgium 9, Sweden 2, and the United States 1. Of pigs, Belgium has 7, Austria and the German States  $5\frac{1}{2}$ , the United Kingdom 5, France, Prussia, Holland, and Spain 4, Denmark 3, the United States 2. The United States have the largest amount of stock of all kinds in proportion to population, and Belgium the least.

These facts are important as bearing upon a question which

forces itself more and more upon our attention. With advancing civilization the demand for an increased quantity of animal food to enable men to maintain the physical vigour necessary for the arduous battle of life, is everywhere apparent, and the augmented prices of to-day warn us that the supply must be increased, or the cost will be higher in the morrow of the future. Probably no European nation consumes yearly so large a proportion of meat per head of its population as do the artisan and hard-working middle-classes of this island, and it is fortunate that our continental neighbours have appetites which are satisfied with less substantial fare, and so they are able to spare us of their superabundance.

Whether or not our own soil can be made more productive in live stock is a matter worthy the attention of agriculturists of all classes, and it may be safely left in the hands of the Royal Agricultural Society to ponder over the problem and to find its ultimate solution.

With regard to the practical results likely to flow from the attempt now first thoroughly made to get reliable statistics of one branch of agriculture, some have been already developed, and more are in embryo; for it appears from a statement recently made by Sir Stafford Northcote in the House of Commons that in two months hence the result of a cognate inquiry into the statistics of the several kinds of crops, &c., will be made public. We shall then have an approximation to a complete Return of the Agricultural Statistics of the United Kingdom for the present year, and it will be a lasting disgrace to us as a nation if we do not follow up so good a beginning.

We have it on the highest authority that "sweet are the uses of adversity," and no one who has watched the current of public opinion in the last twelve months will doubt that to the calamity which has recently befallen our flocks and herds is due in great measure the present favourable disposition of farmers as a body to contribute for public use information which but a short time ago they had strong objection to divulge. There can be no doubt that it is in the power of the better educated and the more intelligent farmers to do the commonwealth good service now and hereafter by endeavouring to remove the mistaken doubts of the weaker brethren, who see in schedules with many columns only the trap of the Government, or the local Exchequer. Their own example will be most telling, but they may further point out, that if increased taxation were the concealed motive of the Government, it would hardly rely upon a mere voluntary system of returns.

EXAMPLES illustrating the AGRICULTURAL RETURNS which were obtained from the CLERGYMEN of TWENTY-SEVEN PARISHES of the COUNTY of BEDFORD in 1836.

Particulars of Inquiry.	PARISHES.			LITTLE STAUGHTON.
	BUNNAM with MUGGERHANGER.	FLITTON.		
Extent of parish	2589 acres	875 acres	.. .. .	About 1200 acres,
Number of farms in the parish	20 .. .. .	6 .. .. .	.. .. .	7.
Mode of letting	Yearly, not by lease	Generally yearly	.. .. .	Yearly.
Size of farms	5 from 200 to 250 acres 2 from 150 to 200 acres 5 from 100 to 150 acres 1 from 50 to 100 acres 7 under 50 acres	100 to 130 acres	.. .. .	40 to 236 acres.
Nature of the soil	Alluvial	Sandy loam	.. .. .	{ Cold weak clay in one part, cold strong clay in another.
Nature of the subsoil	Variable: silt, and in parts clay	Sand or sandstone	.. .. .	Blue galt.
Depth of the soil	9 to 18 inches	6 to 12 inches	.. .. .	About 6 inches.
State of drainage	Generally good	Generally good	.. .. .	{ About one-third with wood and tiles.
Extent under plough	1785 acres	500 acres	.. .. .	800 acres.
Usual course of crops	The 4-course	Generally 4-course	.. .. .	The 4-course.
Pasture-land	250 acres	200 acres	.. .. .	About 370 acres.
Meadow-land	424 acres	50 acres	.. .. .	None.
Wood or coppice:—				
Extent	20 acres wood 10 acres plantation 100 acres fences	1 acre	.. .. .	About 10 acres.
Kinds of trees	Oak, ash, elm, and fir	Whitethorns and alders	.. .. .	Elm and oak.
Plantations recently made:—				
Extent	None	None	.. .. .	36 acres.
Kinds of trees	.. .. .	.. .. .	.. .. .	Fir, elm, oak, &c.
Extent of marsh, waste, or other land not specified	140 acres garden	50 acres bog and marsh	.. .. .	Gravel-pits 2 acres.

Average annual quantity of hay :—

From artificial grasses .. .. .	200 tons ..	.. .. .	200 tons ..	.. .. .	40 tons.
From common grasses .. .. .	150 tons ..	.. .. .	.. .. .	.. .. .	.. .. .
	50 tons ..	.. .. .	.. .. .	.. .. .	.. .. .
	Meadow highland clover	.. .. .	.. .. .	.. .. .	80 tons.
Produce in 1835 :—					
Wheat planted .. .. .	400 acres..	.. .. .	150 acres..	.. .. .	226 acres.
"   quantity produced .. .. .	10,000 bushels	.. .. .	3750 bushels	.. .. .	4520 bushels.
Barley planted .. .. .	300 acres..	.. .. .	100 acres..	.. .. .	150 acres.
"   quantity produced .. .. .	12,000 bushels	.. .. .	3600 bushels	.. .. .	4800 bushels.
Oats planted .. .. .	50 acres ..	.. .. .	40 acres ..	.. .. .	95 acres.
"   quantity produced .. .. .	1750 bushels	.. .. .	1600 bushels	.. .. .	4000 bushels.
Rye planted .. .. .	None .. ..	.. .. .	2 acres ..	.. .. .	None.
"   quantity produced .. .. .	.. .. .	.. .. .	80 bushels	.. .. .	.. .. .
Beans planted .. .. .	50 acres ..	.. .. .	40 acres ..	.. .. .	120 acres.
"   quantity produced .. .. .	1500 bushels	.. .. .	1000 bushels	.. .. .	3360 bushels.
Peas planted .. .. .	30 acres ..	.. .. .	10 acres ..	.. .. .	30 acres.
"   quantity produced .. .. .	750 bushels	.. .. .	200 bushels	.. .. .	840 bushels.
Other grain planted .. .. .	None .. ..	.. .. .	.. .. .	.. .. .	None.
"   quantity produced .. .. .	.. .. .	.. .. .	.. .. .	.. .. .	.. .. .

Quantity of seed used per acre :—

Wheat .. .. .	3 bushels	.. .. .	3½ bushels	.. .. .	3 bushels.
Barley .. .. .	5 bushels	.. .. .	2½ bushels	.. .. .	4 bushels.
Oats .. .. .	6 bushels	.. .. .	5 bushels	.. .. .	6 bushels.
Rye .. .. .	.. .. .	.. .. .	.. .. .	.. .. .	.. .. .
Beans .. .. .	4 bushels	.. .. .	.. .. .	.. .. .	.. .. .
Peas .. .. .	4 to 5 bushels	.. .. .	3 bushels	.. .. .	4 bushels.
Other grain .. .. .	Tares 3 bushels	.. .. .	3 bushels	.. .. .	4 bushels.

Average annual produce per acre :—

Wheat .. .. .	25 bushels	.. .. .	28 bushels	.. .. .	20 bushels.
Barley .. .. .	40 bushels	.. .. .	32 bushels	.. .. .	32 bushels.
Oats .. .. .	35 bushels	.. .. .	40 to 48 bushels	.. .. .	40 bushels.
Rye .. .. .	.. .. .	.. .. .	.. .. .	.. .. .	.. .. .
Beans .. .. .	30 bushels	.. .. .	24 bushels	.. .. .	28 bushels.
Peas .. .. .	25 bushels	.. .. .	16 bushels	.. .. .	28 bushels.
Other grain .. .. .	.. .. .	.. .. .	.. .. .	.. .. .	.. .. .

EXAMPLES illustrating the AGRICULTURAL RETURNS which were obtained from the CLERGYMEN of TWENTY-SEVEN PARISHES, &c.—*continued*.

Particulars of Inquiry.	PARISHES.			LITTLE STAGHTON.
	BLUNHAM with MEGGERHANGER.	ELITON.		
Potatoes planted in 1835 .. .. .	10 acres .. .. .	16 acres .. .. .	.. .. .	None.
„ quantity produced .. .. .	1500 bushels .. .. .	1600 bushels .. .. .	.. .. .	.. .. .
Land under fallow in 1835 .. .. .	.. .. .	95 acres .. .. .	.. .. .	180 acres.
„ planted with turnips, whether fed or drawn off .. .. .	250 acres fed off .. .. .	65 acres fed off .. .. .	.. .. .	10 acres drawn off.
Land planted with tares as a green crop .. .. .	100 acres .. .. .	30 acres .. .. .	.. .. .	40 acres.
Tares planted for seed in 1835 .. .. .	20 acres .. .. .	7 acres .. .. .	.. .. .	15 acres.
„ quantity produced .. .. .	200 bushels .. .. .	105 bushels .. .. .	.. .. .	360 bushels.
Clover and artificial grasses cut for seed in 1835 .. .. .	50 acres clover .. .. .	16 to 20 acres .. .. .	.. .. .	70 acres.
Quantity of seed produced .. .. .	20 sacks .. .. .	112 to 140 bushels .. .. .	.. .. .	210 bushels.
Number of horses for agricultural purposes for other purposes .. .. .	80 .. .. .	30 .. .. .	.. .. .	About 45.
Number of working oxen .. .. .	46 .. .. .	10 .. .. .	.. .. .	None.
Number of grazing cattle (other than milch cows) .. .. .	None .. .. .	None .. .. .	.. .. .	None.
Number of milch cows .. .. .	20 .. .. .	About 20 .. .. .	.. .. .	None.
Number of calves bred in the year :—	116 .. .. .	40 .. .. .	.. .. .	About 50.
For rearing .. .. .	50 .. .. .	20 .. .. .	.. .. .	About 30.
For meat .. .. .	60 .. .. .	.. .. .	.. .. .	.. .. .



TABLE I.—LIVE STOCK ENUMERATED 5th MARCH, 1866, in the several COUNTIES of ENGLAND and WALES.

COUNTIES.	Live Stock enumerated 5th March, 1866.										Total Stock.
	CATTLE.			SHEEP.			Pigs.	Total Sheep.	Total Cattle.	Under 1 Year of Age.	
	Cows.	Under 2 Years of Age and Upwards.	Total other Cattle.	Under 1 Year of Age.	1 Year of Age and Upwards.	Total Sheep.					
ENGLAND.											
I. Metropolitan Police District .. .. .	22,084	7,783	7,920	15,703	37,787	21,692	107,405	129,097	34,089	200,973	
II. 1. Surrey ( <i>extra-metrop.</i> ) .. .. .	8,096	7,480	6,461	13,941	22,037	26,661	95,267	121,928	23,618	167,583	
2. Kent ( <i>extra-metrop.</i> ) .. .. .	18,425	15,702	16,708	32,410	50,835	176,271	532,785	709,056	66,763	826,654	
3. Sussex .. .. .	26,130	23,090	25,450	48,540	74,070	136,061	348,995	485,056	42,642	602,368	
4. Hampshire .. .. .	29,923	12,035	10,730	22,765	48,688	187,653	431,945	619,598	79,789	748,075	
5. Berkshire .. .. .	13,100	9,262	7,787	17,049	30,149	91,158	236,158	327,316	41,265	398,730	
III. 6. Middlesex ( <i>see Metrop.</i> ) .. .. .	..	..	..	..	..	..	..	..	..	..	
7. Hertfordshire ( <i>extra-met.</i> ) .. .. .	7,235	7,221	6,374	13,595	20,830	52,898	153,960	206,858	32,194	259,882	
8. Buckinghamshire .. .. .	23,473	15,790	12,577	28,367	51,840	63,964	199,051	263,015	39,266	354,121	
9. Oxfordshire .. .. .	14,479	15,181	12,475	27,656	42,135	100,970	232,334	333,304	42,372	417,811	
10. Northamptonshire .. .. .	18,378	22,540	33,344	55,884	74,262	119,075	316,762	435,837	38,366	548,465	
11. Huntingdonshire .. .. .	4,313	6,728	6,626	13,354	17,667	28,420	89,401	117,821	26,602	162,090	
12. Bedfordshire .. .. .	7,784	9,177	8,552	17,720	25,513	47,093	133,157	180,250	36,796	242,559	
13. Cambridgeshire .. .. .	9,174	12,204	10,353	22,557	31,731	58,563	196,473	255,036	58,225	344,992	
IV. 14. Essex ( <i>extra-metrop.</i> ) .. .. .	14,796	15,049	20,891	35,940	50,736	88,550	284,579	373,129	98,948	522,813	
15. Suffolk .. .. .	17,694	18,932	19,141	38,073	55,767	104,724	303,205	407,929	133,498	597,194	
16. Norfolk .. .. .	24,516	28,774	39,096	67,870	92,886	191,566	405,117	596,683	115,876	804,945	
V. 17. Wiltshire .. .. .	44,760	18,201	14,763	32,964	77,724	184,816	412,006	596,822	61,012	735,558	
18. Dorsetshire .. .. .	42,398	13,759	13,845	27,604	70,002	157,313	335,310	492,623	38,676	601,301	
19. Devonshire .. .. .	58,513	64,972	60,592	125,564	184,077	235,324	533,802	769,126	94,475	1,047,678	
20. Cornwall .. .. .	38,700	52,243	42,709	94,952	133,652	100,771	199,278	300,049	63,920	437,621	
21. Somersetshire .. .. .	84,262	44,128	45,157	89,285	173,547	175,920	461,055	636,975	75,469	885,991	
VI. 22. Gloucestershire .. .. .	34,774	29,926	32,131	62,051	96,831	98,976	277,397	356,373	50,333	504,137	
23. Herefordshire .. .. .	19,988	26,060	19,136	45,196	65,184	72,563	184,633	257,196	25,260	347,640	
24. Shropshire .. .. .	42,846	33,118	31,244	64,362	107,208	100,259	227,353	327,612	59,674	494,494	



25. Staffordshire	..	..	60,050	26,072	21,176	47,248	107,298	67,773	164,163	231,936	47,967	387,201
26. Worcestershire	..	..	20,818	12,565	12,406	24,971	45,789	50,379	153,775	204,154	36,686	286,629
27. Warwickshire	..	..	26,235	20,168	20,846	41,014	67,249	92,151	193,727	285,878	36,613	389,740
VII.												
28. Leicestershire	..	..	29,336	27,340	32,439	59,779	89,115	86,625	203,929	290,554	23,250	402,919
29. Rutlandshire	..	..	2,321	4,011	5,319	9,330	11,651	19,587	56,168	75,755	3,754	91,160
30. Lincolnshire	..	..	38,938	61,750	68,606	130,356	169,294	325,243	762,961	1,088,204	91,522	1,349,020
31. Nottinghamshire	..	..	19,925	25,252	21,988	47,240	67,165	73,025	172,507	245,532	29,083	341,780
32. Derbyshire	..	..	58,335	32,133	22,727	54,860	113,195	55,850	120,272	176,122	31,452	320,769
VIII.												
33. Cheshire	..	..	57,176	22,161	13,707	35,868	93,044	18,865	78,124	96,989	57,632	247,725
34. Lancashire	..	..	106,952	64,240	31,360	95,600	202,552	65,866	151,749	217,615	50,375	470,542
IX.												
35. West Riding	..	..	83,271	64,822	41,248	106,070	189,341	136,758	363,438	500,196	72,018	761,585
36. East Riding ( <i>with York</i> )	..	..	18,536	25,213	21,060	46,273	64,809	179,037	237,816	416,853	52,589	534,251
37. North Riding	..	..	39,270	46,758	33,205	79,963	119,233	153,811	308,227	462,038	53,472	634,743
X.												
38. Durham	..	..	16,695	19,672	15,955	35,627	52,322	57,742	88,954	146,936	14,140	213,158
39. Northumberland	..	..	17,970	27,080	32,781	60,461	78,431	237,739	397,748	635,487	24,621	738,539
40. Cumberland	..	..	38,403	44,035	26,787	70,822	109,225	171,917	224,074	396,021	40,742	545,988
41. Westmoreland	..	..	21,005	23,871	10,452	34,323	55,328	59,346	165,318	224,664	7,413	287,405
WALES.												
XI.												
42. Monmouthshire	..	..	13,452	12,432	10,851	23,283	36,735	31,340	99,818	131,158	13,152	181,045
43. South Wales:—												
Glamorganshire	..	..	18,820	13,670	13,421	27,091	45,911	38,616	138,868	177,484	14,335	237,730
Carmarthenshire	..	..	40,567	24,711	18,828	43,539	84,106	32,368	77,927	110,295	19,339	213,740
Pembrokeshire	..	..	27,049	24,725	17,068	41,793	68,842	18,926	45,486	64,412	21,739	154,993
Cardiganshire	..	..	20,492	15,682	11,210	26,892	47,384	28,636	79,910	108,546	16,708	172,638
Breconshire	..	..	11,777	10,666	7,161	17,827	29,604	43,893	168,622	212,515	7,367	249,486
Radnorshire	..	..	8,376	12,499	7,110	19,630	28,006	42,602	138,774	181,376	5,346	214,728
44. North Wales:—												
Montgomeryshire	..	..	20,933	21,253	16,342	37,695	58,628	53,590	166,651	220,241	20,863	299,732
Flintshire	..	..	9,951	5,631	3,801	9,432	19,383	6,574	28,532	35,106	14,860	69,349
Denbighshire	..	..	19,620	15,846	11,229	27,075	46,694	26,084	124,481	150,565	20,529	223,789
Merionethshire	..	..	13,004	12,070	8,269	20,339	33,343	49,951	185,137	235,091	7,503	276,137
Carnarvonshire	..	..	19,198	14,460	10,414	24,874	44,072	29,547	109,770	139,317	18,940	202,329
Anglesey	..	..	12,759	13,991	8,077	22,668	35,427	10,061	23,651	33,715	17,875	87,917

TABLE II.—LIVE STOCK enumerated 5th March, 1866, in the several COUNTIES of SCOTLAND.

COUNTIES.	Live Stock enumerated 5th March, 1866.									
	Cattle.				Sheep.			Figs.	Total Stock.	
	Cows.	Other Cattle.		Total Cattle.	Under 1 Year of Age.	1 Year of Age and Upwards.	Total Sheep.			
		Under 2 Years of Age.	2 Years of Age and Upwards.					Total other Cattle.		
I. 1. Wigtown .. ..	14,980	11,390	9,333	20,723	35,703	44,107	74,562	118,669	10,273	164,645
2. Kirkcudbright .. ..	10,717	12,404	11,537	23,941	34,658	92,753	178,714	271,467	10,289	316,414
3. Dumfries .. ..	15,861	17,273	11,330	28,503	44,364	127,728	243,758	371,486	18,612	434,462
4. Roxburgh .. ..	4,722	6,589	4,773	11,362	16,084	101,241	209,296	310,537	6,094	332,715
II. 5. Selkirk .. ..	816	769	442	1,211	2,027	21,228	79,657	100,885	663	103,575
6. Peebles .. ..	2,426	2,144	1,400	3,544	5,970	37,269	88,562	125,831	1,220	133,021
7. Berwick .. ..	3,989	6,030	5,173	11,203	15,192	87,549	105,739	193,288	8,344	216,824
8. Haddington .. ..	2,091	2,660	4,908	7,568	9,659	31,938	59,476	91,414	7,646	108,719
9. Edinburgh .. ..	5,999	3,723	3,291	7,014	13,013	41,128	72,351	113,479	9,609	136,101
10. Linlithgow .. ..	3,354	2,692	1,983	4,675	8,029	12,756	10,314	23,070	3,166	34,265
III. 11. Lanark .. ..	30,372	17,388	8,446	25,834	56,206	61,443	98,571	160,014	8,992	225,212
12. Ayr .. ..	42,011	22,253	11,280	33,533	75,544	89,234	173,739	262,973	13,502	332,019
13. Renfrew .. ..	12,566	5,752	3,195	8,947	21,513	10,069	16,434	26,503	2,354	50,370



TABLE III.—PROPORTIONATE NUMBERS OF STOCK TO AREA AND POPULATION OF THE SEVERAL COUNTIES OF ENGLAND AND WALES.

COUNTIES.	Area in Acres.	Population (1861).	Proportion of Stock to every 100 Acres of Area.					Proportion of Stock to every 100 of Population.		
			Cows.	Other Cattle.	Total Cattle.	Sheep.	Pigs.	Total Stock.	Cattle.	Total Stock.
ENGLAND.										
I. Metropolitan Police District .. .. .	440,469	3,222,717	5.0	3.6	8.6	29.3	7.7	45.6	1.2	6.2
II. 1. Surrey ( <i>extra-metrop.</i> )	377,790	141,364	2.1	3.7	5.8	32.3	6.3	44.4	15.6	118.5
2. Kent ( <i>extra-metrop.</i> ) ..	974,764	509,455	1.9	3.3	5.2	72.7	6.8	84.7	10.0	162.3
3. Sussex .. .. .	936,911	363,735	2.8	5.2	8.0	51.8	4.6	64.4	20.5	165.6
4. Hampshire .. .. .	1,070,216	481,815	2.4	4.5	7.7	57.9	7.5	69.9	10.1	155.3
5. Berkshire .. .. .	451,210	170,256	2.9	3.8	6.7	72.5	9.1	88.3	17.1	226.2
III. 6. Middlesex ( <i>see Metrop.</i> )	..	..	..	..	..	..	..	..	..	..
7. Hertfordshire ( <i>ex-met.</i> )	356,625	154,653	2.0	3.8	5.8	58.0	9.0	72.8	13.5	168.0
8. Buckinghamshire ..	466,932	167,993	5.0	6.1	11.1	56.3	8.4	75.8	30.9	210.8
9. Oxfordshire .. .. .	472,717	170,944	3.1	5.8	8.9	70.5	9.0	88.4	24.7	244.4
10. Northamptonshire ..	630,358	227,704	2.9	8.9	11.8	69.1	6.1	87.0	32.6	240.9
11. Huntingdonshire ..	229,544	64,250	1.9	5.8	7.7	51.3	11.6	70.6	27.5	252.3
12. Bedfordshire .. .. .	235,582	135,287	2.6	6.0	8.6	61.0	12.4	82.0	18.9	179.3
13. Cambridgeshire .. ..	525,182	176,016	1.7	4.3	6.0	48.6	11.1	65.7	18.0	196.0
IV. 14. Essex ( <i>extra-metrop.</i> ) ..	1,000,389	321,407	1.5	3.6	5.1	37.3	9.9	52.3	15.8	162.7
15. Suffolk .. .. .	947,681	337,070	1.9	4.0	5.9	43.0	14.1	63.0	16.6	177.2
16. Norfolk .. .. .	1,354,301	434,798	1.8	5.0	6.8	44.1	8.6	59.5	21.3	185.1
V. 17. Wiltshire .. .. .	865,092	249,311	5.2	3.8	9.0	69.0	7.1	85.1	25.3	295.0
18. Dorsetshire .. .. .	632,025	188,789	6.7	4.4	11.1	77.9	6.1	95.1	37.1	318.5
19. Devonshire .. .. .	1,657,180	584,373	3.5	7.6	11.1	46.4	5.7	63.2	31.5	179.3
20. Cornwall .. .. .	873,600	369,390	4.4	10.9	15.3	34.3	7.3	56.9	36.2	134.7
21. Somersetshire .. .. .	1,047,220	444,873	8.0	8.5	16.5	60.8	7.2	84.5	39.0	199.2
VI. 22. Gloucestershire .. .. .	805,102	485,770	4.3	7.7	12.0	44.3	6.3	62.6	20.0	103.8
23. Herefordshire .. .. .	534,823	123,712	3.7	8.5	12.2	48.1	4.7	65.0	52.7	281.0
24. Shropshire .. .. .	826,055	240,959	5.2	7.8	13.0	39.7	7.2	59.9	44.5	205.2

25. Staffordshire .. .. .	728,468	746,943	8.2	6.5	14.7	31.8	6.6	53.1	14.4	51.8
26. Worcestershire .. .. .	472,165	307,397	4.4	5.3	9.7	43.2	7.8	60.7	14.9	93.2
27. Warwickshire .. .. .	563,946	561,855	4.6	7.3	11.9	50.7	69.1	69.1	12.0	69.4
VII.										
28. Leicestershire .. .. .	514,164	237,412	5.7	11.6	17.3	56.5	4.5	78.3	37.5	169.7
29. Rutlandshire .. .. .	95,805	21,861	2.4	9.7	12.1	79.1	3.9	95.1	53.3	417.0
30. Lincolnshire .. .. .	1,775,457	412,246	2.2	7.3	9.5	61.3	5.2	76.0	41.1	327.2
31. Nottinghamshire .. .. .	526,076	293,867	3.8	9.0	12.8	46.7	5.5	65.0	22.9	116.3
32. Derbyshire .. .. .	659,803	339,327	8.9	8.3	17.2	26.7	4.8	48.7	33.4	91.5
VIII.										
33. Cheshire .. .. .	707,078	505,428	8.1	5.1	13.2	13.7	8.2	35.1	18.4	49.0
34. Lancashire .. .. .	1,219,221	2,429,440	8.8	7.8	16.6	17.8	4.1	38.5	8.3	19.4
IX.										
35. West Riding .. .. .	1,709,307	1,507,796	4.9	6.2	11.1	29.3	4.2	44.6	12.6	50.5
36. East Riding ( <i>with York</i> ) .. .. .	771,139	280,660	2.4	6.0	8.4	54.1	6.8	69.3	23.1	190.4
37. North Riding .. .. .	1,350,121	245,154	2.9	5.9	8.8	34.2	4.0	47.0	48.6	258.9
X.										
38. Durham .. .. .	622,476	508,666	2.7	5.7	8.4	23.6	2.3	34.3	10.3	41.9
39. Northumberland .. .. .	1,249,299	343,925	1.4	4.9	6.3	50.9	2.0	59.2	22.9	215.3
40. Cumberland .. .. .	1,001,273	205,276	3.8	7.1	10.9	39.6	4.1	54.6	53.2	266.0
41. Westmoreland .. .. .	485,432	60,817	4.3	7.1	11.4	46.3	1.5	59.2	91.0	472.6
XI.										
42. Monmouthshire .. .. .	368,399	174,633	3.7	6.3	10.0	35.6	3.6	49.2	21.0	103.7
43. South Wales :—										
Glamorganshire .. .. .	547,494	317,752	3.4	5.0	8.4	32.4	2.6	43.4	14.5	74.8
Carmarthenshire .. .. .	606,331	111,796	6.7	7.2	13.9	18.2	3.2	35.3	75.3	191.2
Pembrokeshire .. .. .	401,691	96,278	6.7	10.4	17.1	16.0	5.4	38.5	71.5	161.0
Cardiganshire .. .. .	443,387	72,245	4.6	6.1	10.7	24.5	3.8	39.0	65.6	239.0
Brecknockshire .. .. .	460,158	61,637	2.5	3.9	6.4	46.2	1.6	54.2	48.1	404.8
Radnorshire .. .. .	272,128	25,382	3.1	7.2	10.3	66.7	2.0	79.0	110.3	846.0
44. North Wales :—										
Montgomeryshire .. .. .	483,323	66,919	4.3	7.8	12.1	45.6	4.3	62.0	87.6	447.9
Flutshire .. .. .	184,905	69,737	5.4	5.1	10.5	19.0	8.0	37.5	27.8	99.5
Denbighshire .. .. .	386,052	100,778	5.1	7.0	12.1	39.0	6.9	58.0	46.3	222.1
Merionethshire .. .. .	385,291	38,963	3.4	5.3	8.7	61.0	2.0	71.7	85.6	708.7
Carnarvonshire .. .. .	370,273	95,694	5.2	6.7	11.9	37.6	5.1	54.6	46.1	211.4
Anglesey .. .. .	193,453	54,609	6.6	11.7	18.3	17.4	9.2	44.9	64.9	159.3

## WALES.

TABLE IV.—PROPORTIONATE NUMBER OF STOCK TO AREA AND POPULATION OF THE SEVERAL COUNTIES OF SCOTLAND.

COUNTIES.	Area in Acres.	Population (1861).	Proportion of Stock to every 100 Acres of Area.						Proportion of Stock to every 100 of Population.	
			Cows.	Other Cattle.	Total Cattle.	Sheep.	Pigs.	Total Stock.	Cattle.	Total Stock.
I. 1. Wigtown .. .. .	327,906	42,095	4.6	6.3	10.9	36.2	3.1	50.2	84.8	391.1
2. Kirkcubright .. .. .	610,343	42,495	1.8	3.9	5.7	44.5	1.7	51.9	81.6	744.6
3. Dumfries .. .. .	702,953	75,878	2.3	4.0	6.3	52.8	2.6	61.7	58.5	572.6
4. Roxburgh .. .. .	428,494	54,119	1.1	2.7	3.8	72.5	1.4	77.7	29.7	614.8
II. 5. Selkirk .. .. .	166,524	10,449	.5	.7	1.2	60.6	.4	62.2	19.4	991.2
6. Peebles .. .. .	227,869	11,408	1.1	1.5	2.6	55.2	.5	58.3	52.0	1158.7
7. Berwick .. .. .	302,951	36,613	1.3	3.7	5.0	63.8	2.8	71.6	41.5	592.2
8. Haddington .. .. .	179,142	37,634	1.2	4.2	5.4	51.0	4.3	60.7	25.7	288.9
9. Edinburgh .. .. .	234,925	273,997	2.5	3.0	5.5	48.3	4.1	57.9	47.5	496.7
10. Linlithgow .. .. .	81,113	38,645	4.1	5.8	9.9	28.4	3.9	42.2	20.8	88.7
III. 11. Lanark .. .. .	568,867	631,566	5.3	4.6	9.9	28.1	1.6	39.6	8.9	35.7
12. Ayr .. .. .	735,262	198,971	5.7	4.6	10.3	35.8	1.8	47.9	38.0	176.9
13. Renfrew .. .. .	158,268	177,561	7.9	5.7	13.6	16.7	1.5	31.8	12.1	28.4
IV. 14. Bute .. .. .	109,375	16,331	3.4	4.2	7.6	31.4	1.1	40.1	50.5	268.3
15. Argyll .. .. .	2,083,126	79,734	1.1	1.7	2.8	33.6	.3	36.7	72.5	958.5
16. Dumbarton .. .. .	204,800	52,034	2.5	2.7	5.2	26.1	.6	31.9	20.3	125.2
17. Stirling .. .. .	295,875	91,926	2.7	4.5	7.2	29.2	1.2	37.6	23.3	121.3

V. 18. Clackmannan	.. ..	29,440	21,450	2.8	4.3	7.1	32.2	4.3	43.6	9.8	59.8
19. Kinross	.. ..	49,812	7,977	1.9	6.2	8.1	45.1	2.6	55.8	50.5	348.1
20. Fife	.. ..	328,427	154,770	2.3	6.0	8.3	28.5	4.3	41.1	17.6	87.3
21. Perth	.. ..	1,814,063	133,500	1.2	2.4	3.6	27.3	1.0	31.9	49.6	433.4
22. Forfar	.. ..	568,750	204,425	1.7	3.3	5.0	27.5	2.6	35.1	14.0	97.9
VI.											
23. Kincardine	.. ..	252,250	34,466	2.7	5.8	8.5	16.3	1.9	26.7	62.5	195.5
24. Aberdeen	.. ..	1,260,625	221,569	3.5	7.1	10.6	8.7	1.2	20.5	60.2	116.2
25. Banff	.. ..	439,219	59,215	2.9	5.4	8.3	12.6	1.4	22.3	61.7	165.7
26. Elgin	.. ..	340,000	42,695	2.0	4.0	6.0	20.3	1.7	28.0	47.8	223.1
27. Nairn	.. ..	137,500	10,065	1.1	2.7	3.8	14.4	1.0	19.2	52.0	263.3
VII.											
28. Inverness	.. ..	2,723,501	88,888	.7	.9	1.6	19.2	.2	21.0	51.0	643.4
29. Ross and Cromarty	.. ..	2,016,375	81,406	.8	1.0	1.8	14.6	.4	16.8	44.3	415.6
VIII.											
30. Sutherland	.. ..	1,207,188	25,246	.4	.5	.9	13.6	.1	14.6	44.6	700.2
31. Caithness	.. ..	455,708	41,111	1.6	2.8	4.4	18.1	.7	23.2	48.6	257.1
32. Orkney	.. ..	598,726	64,065	3.0	4.2	7.2	12.8	1.2	21.2	69.2	198.6
33. Shetland	.. ..										

TABLE V.—NUMBER OF LIVE STOCK in the undermentioned STATES according to the latest Returns, as given by the Board of Trade.

COUNTRIES.	Date of Returns of Live Stock.	Live Stock.						Total Stock.
		Cattle.		Total Cattle.	Sheep.	Pigs.		
		Cows.	Other Cattle.					
Russia .. .. .	1859-63	..	..	25,444,000	45,130,800	10,097,000	80,671,800	
United States .. .. .	1860	8,728,862	8,182,613	16,911,475	23,317,756	32,555,267	72,784,498	
France .. .. .	1862	5,781,465	8,415,895	14,197,360	33,281,592	5,246,403	52,725,355	
Austria .. .. .	1863	6,353,086	7,904,030	14,257,116	16,964,236	8,151,608	39,372,960	
United Kingdom .. .. .	1865-66	3,286,298	5,030,652	8,316,950	25,795,708	3,802,399	37,915,057	
Spain .. .. .	1865	..	..	2,904,598	22,054,967	4,264,817	29,224,382	
Prussia .. .. .	1862	3,282,703	2,251,797	5,634,500	17,428,017	2,709,709	25,772,226	
German States* .. .. .	1857-64	..	..	8,036,528	7,909,424	2,951,901	18,897,853	
Sweden .. .. .	1860	1,112,944	803,714	1,916,658	1,644,156	457,981	4,018,795	
Denmark Proper .. .. .	1861	756,834	361,940	1,118,774	1,751,950	300,928	3,171,652	
Holland .. .. .	1864	943,214	390,673	1,333,887	930,136	294,636	2,558,659	
Belgium .. .. .	1856	..	..	1,257,649	583,485	458,418	2,299,552	

\* Comprising Sleswig, Holstein, Hanover, Saxony, Wurtemberg, Baden, Hesse, Nassau, Meeklenburg-Schwerin, Oldenburg, and Bavaria.



TABLE VI.—PROPORTIONATE NUMBER OF STOCK TO AREA AND POPULATION OF THE UNMENTIONED STATES.

COUNTRIES.	Area in Acres.	Population according to latest Returns.	Proportion of Stock to every 100 Acres of Area.						Proportion of Stock to every 100 of Population.	
			Cows.	Other Cattle.	Total Cattle.	Sheep.	Pigs.	Total Stock.	Cattle.	Total Stock.
Russia .. .. .	4,973,364,000	74,139,394	..	..	·5	·9	·2	1·6	34·3	108·8
United States .. .. .	1,643,245,000	31,445,080	·5	·5	1·0	1·4	2·0	4·4	53·8	231·5
France .. .. .	122,039,000	37,386,313	4·7	6·9	11·6	27·3	4·3	43·2	38·0	141·0
Austria .. .. .	149,666,000	36,267,648	4·2	5·3	9·5	11·3	5·5	26·3	39·3	108·6
United Kingdom .. .. .	78,006,000	29,070,932	4·2	6·4	10·6	33·1	4·9	48·6	28·6	130·4
Spain .. .. .	114,083,000	15,658,531	..	..	2·5	19·3	3·7	25·5	18·6	186·6
Prussia .. .. .	65,148,000	18,491,220	5·2	3·5	8·7	26·7	4·2	39·6	30·5	139·4
German States .. .. .	53,911,000	15,186,495	..	..	14·9	14·7	5·5	35·1	52·9	124·4
Sweden .. .. .	89,829,000	3,859,728	1·2	·9	2·1	1·8	·5	4·4	49·6	104·1
Denmark Proper .. .. .	9,275,500	1,662,734	8·2	3·9	12·1	18·9	3·2	34·2	67·2	190·8
Holland .. .. .	6,979,200	3,618,459	13·5	5·6	19·1	13·3	4·2	36·6	36·8	70·7
Belgium .. .. .	6,627,500	4,529,461	..	..	19·0	8·8	6·9	34·7	22·1	50·8

*Note.*—This Table is calculated on the Returns supplied by the Board of Trade in conjunction with the area of the different States corresponding with the stated population as nearly as can be ascertained from authentic sources.

XXVII.—*The Improvement of Waste Lands connected with Mines.*  
By WILLIAM LITTLE.

PRIZE ESSAY.

THE improvement of waste lands wherever situated is a subject of great importance to us, seeing that we are so dependant on other countries for the food of our people, but the improvement of such lands in a mining district, which frequently forms one of the great centres of our population, cannot easily be over-estimated, as in such localities a great demand exists for every article of rural produce.

Waste lands are very commonly taken as signifying lands in a state of nature, heath or moorland, but I presume that the term as given in the subject of this essay is intended to embrace, not only moorland, but more particularly portions of land cut up and rendered waste by mining operations of any kind. The reclamation or improvement of moorland around mines would differ little, if at all, from the reclamation of such land in any district other than a mining one, unless that the nearness to limestone and coal, or similar advantages, gave the impetus and the facility for the cheap application of lime or other manures. But the greater area of the surface of our mineral fields is already under the plough; for if in the first instance a good deal of mineral wealth was obtained from beneath a heath-clad surface, as mining operations are carried out to any great extent, the heather for the most part falls before the plough, unless the situation on account of elevation and climate is unfavourable for cultivation. A large portion, however, of the mineral fields of Great Britain are favourably situated in these respects, but from the working of the mines and the manufactures which they give rise to, considerable portions of the surface in their immediate vicinity are rendered waste, unoccupied, and unproductive.

A brief sketch of a mining district will serve to show how the surface is cut up, and no small portions of land rendered waste. There are the pits, conspicuous by their tall chimneys, engine-houses, and huge boilers; the large unsightly pit-heaps; the working and the worked-out brickyards, with blast furnaces, coke-ovens, and heaps of slag and other *débris* lying here and there upon the surface. There is the network of railways or waggonways and canals for the carriage of minerals, some of them in use and others abandoned, crossing and re-crossing each other, cutting up the fields in all forms, and frequently into small irregular patches. There are also the straggling rows of almost innumerable cottages for the miners, and clusters of villages, often apparently built without any regard to comfort, order, or beauty.

The unsightly pit-heaps referred to frequently cover an area of from two to three acres, and in some instances considerably more. The deposit of these heaps has in the majority of cases been made in the most convenient place for getting the stones and shale drawn from the mines off the land, regardless either of the permanent loss of the land on which they lie or of the inconvenience of the corners formed by them in the fields. The worked-out brickyard too is often of a similar extent to the pit-heap, with the soil and subsoil taken out to a depth of from 6 to 10 feet. Besides the portions of land cut up into patches by the crossing and re-crossing of railways, or rendered waste by other peculiarities of the mine and its accompanying works, there is often a large area of land considerably damaged by pit-falls or the subsidence of the surface consequent on the working out of the minerals beneath. This falling of the surface deranges the strata; and it not unfrequently happens that well-drained land in good condition is rendered next to a morass or bog by the subsidence of the main body of the field, while the upper end of it, which probably has not fallen in a corresponding degree, drains its water on to the surface instead of keeping the former subterranean track.

#### THE IMPROVEMENT OF THE WASTE LANDS SPOKEN OF.

Since the locomotive steam-engine supplanted the waggon-horse, the owners of mines and other works have been able to dispose of the stones and other refuse in another way than by laying them down to occupy available land. The carriage of these to a suitable place of deposit is not now such an insurmountable obstacle as was the case when every waggon was drawn by the sinews and muscles of the horse. In coal-mines the stones and shale cannot be all stowed away in the workings beneath, and a single pit in one night generally draws a considerable quantity, but emptied into waggons as they are, the locomotive glides easily and swiftly away with them before the regular throug of the pit commences. The worked-out brickyard will readily suggest itself as a place of deposit, and if a branch line can be laid to it conveniently for the engine it will make a good one. An old brickyard in connection with three of the pits on the Lambton collieries was filled up in this way. It covered an area of upwards of three acres. After being finished a portion of it was set apart as building sites, and during the last summer (1865) 40 comfortable and substantially-built cottages were erected for the miners. The sites for the cottages were allowed to get properly consolidated before the buildings were commenced. As dwellings for the workmen, they are much above the average for neatness and comfort.

There are four apartments in each house, besides a pantry, backyard, and other conveniences, and the situation of these dwellings is dry, open, and healthy. The remaining portion of the former brickyard is soiled over with road-scrappings and other accumulations of soil, and set apart as gardens for a few of the men. This particular case is stated, as it came more directly under my notice than many other similar improvements which have been, and are being, made on the same estate.

When the old brickyards and other excavated portions are filled up with the refuse from the mines, a place of deposit has to be elsewhere selected, and sometimes a low and wet piece of land, difficult to drain for the want of a proper outfall, is fixed upon. The land is either naturally of little value, or, as is frequently the case, rendered so by a pit-fall. The first operation is to lay a branch line of railway off the main line to the place selected, and thereafter to cut out a bed for the emptying of the first waggons. The surface is broken and taken off to a depth of about  $2\frac{1}{2}$  feet, and in the first instance laid to an off side. The tipping or emptying of waggons commences, and, as in embankments or moundings in a railway, they advance over the deposit as it reaches the desired height. So soon as the place first cut for deposit is about to be filled up, a fresh portion of the natural surface is again broken, but it is now wheeled up on to the top of the rubbish heap, which is gradually covered over as it advances to a depth about equal to what is excavated. About  $2\frac{1}{2}$  feet may by some be considered a deeper soil than is necessary, but I think not, when the deep-growing habits of some of our cultivated plants and the general deep cultivation now practised by steam-power and otherwise are considered. It is folly to do a work of such importance imperfectly at first, for unless we take off sufficient earth to make a good depth of soil before we deposit our rubbish heap, the opportunity is irrecoverably lost. The depth of the rubbish deposit itself is regulated by the adjoining land, and the formation of any unnatural knoll is avoided. In the centre or more hollow part the depth may be 12 feet or more, while around the edges or borders it may be only 2 or 3 feet, running out to nothing, so as to be in keeping with the other portion of the field, although at first it is better to keep it slightly elevated to allow something for consolidation. A drain can be put in at the lower end of the rubbish deposit, or of the natural declivity of the ground, which will carry off the water should it rise in the rubbish heap so as to sour or injure the rest of the field.

I have had to do with a portion of land of about six acres which was improved in this way on the Lambton estate, the property of the Earl of Durham. The work was finished during

the summer of 1865, and the place has been a deposit for refuse from the mines for the last four years. At the commencement the work proceeded in a stripe down one side to the lower end, then included all to be taken in, and came gradually up to the place whence the start was made. We worked and cropped this newly-made land every year up to the workmen, but as a good part of a clay subsoil was intermixed with the soil, we did not raise large crops at first. Tares suited best to begin with; turnips in 1864 were a failure, but wheat in 1865 was a crop considerably above the average in the district.

The cost of such an improvement as I have tried to describe is about the average purchase value of really good arable land. Independent of the tipping of the waggons the expense will be little short of 100*l.* per imperial acre, and may in some instances exceed that sum. Work of this description is for the most part let to a contractor by the piece, at 5*d.* or 6*d.* per cubic yard for breaking up the natural surface and wheeling it on to the top of the deposit. It is without doubt one of the most expensive improvements, but a deposit is got for a large quantity of refuse from the mines and other works, and comparatively worthless land is permanently improved, requiring no drainage, whereas when the large heaps of rubbish are laid down upon the surface the land is for the most part permanently lost. It would be well, not only for the owners of land, but for the public, were such a plan as the above more generally followed. The area of our British soil covered by accumulations of refuse, especially in mining districts, is by no means small.

On the Lambton estate, where mining operations are carried on by the proprietor to a great extent, a great many portions of waste land, old waggonways included, have been permanently improved in the manner which I have here described. These improved portions have in some instances added to the available acreage of the farm, and in others they have afforded building sites for workmen's houses as well as garden plots.

Within the last three years upwards of 200 houses of a superior description have been erected for the workmen, the greater part of them upon portions of lands comparatively waste, unoccupied and unproductive, but otherwise unobjectionable as building sites.

Damage from pit-falls is generally repaired by draining the land anew; but such peculiarities sometimes present themselves that this does not meet the exigencies of the case. One instance came lately under my observation where the course of a brook was damaged by a pit-fall; the land had fallen so considerably to the lower side of the brook as to induce it to leave its former track and flow over some good tillage land. The

course could not easily be made deeper, but an embankment was raised by making a deep cutting alongside of the brook, but at a distance where there would be little chance of the water filtering through, and by forming a proper weir with the earth taken from this cutting, an effectual cure was made of the evil. The place whence this earth had been taken was filled up with slag and other refuse and thereafter properly covered with soil.

Grass-land is generally found more profitable in the *immediate* neighbourhood of mines than land under tillage. It is less damaged by trespass and withstands the bad effects of smoke better than any other crop I know. A case, however, came under my observation where several acres of land were rendered totally useless by the smoke, &c., from a row of coke-ovens. The damage was cured by erecting two large chimneys, one at each end of the row, and turning the smoke into them instead of allowing each oven to emit its own. A flue is carried along the top of the ovens, which from the centre of the row conveys the smoke into its appropriate chimney, where it is carried sufficiently high to disseminate itself, and consequently does little injury. Moreover, it is considered that by this method a good part of the smoke is consumed as it travels over the top of the burning ovens. The result, however, is that several acres of the adjoining grass-land, instead of remaining like a desert, are now covered with good herbage affording keep for cattle.

#### FARMING IN CONNECTION WITH MINES.

Farming in connection with mines has both its advantages and disadvantages; if the farm is situated in a mining district, but not in direct connection with mines, the advantages preponderate. The throng and bustle of a mining neighbourhood is for the most part confined to certain spots or centres, and fewer shafts than formerly are now necessary, as the underground engines, assisted by the Shetland and Welsh ponies, can draw the minerals underground for very long distances, so that even in a mining and populous district large open fields and well-cultivated farms are not wanting. My remarks, however, will be confined to farming in connection with mines.

The farm in connection with the mine is often looked upon as an indispensable adjunct, but only as a kind of necessary evil. To many proprietors and lessees of mines it is a source of great loss, whereas, if properly managed, it would add its quota to the general income. The reason is that the mining department absorbs the principal share of attention. The charge of the farm, as well as the mines, is frequently entrusted to a mining engineer.

There is almost always a bailiff or farm-manager; but as he has to work to instructions from one who knows comparatively little of the management of land, and who considers it a secondary matter with which to occupy his time and attention, things are often gone about in the wrong way. The bailiff's general instructions are often to the following effect: "You must get on with the farm-work as well as you can; but you must in the first place attend to the wants of the pits—they must be kept going." The horses above bank are often kept for the double purpose of working the land and doing the work required about the mines, and in the case of breakage of machinery and other emergencies they are taken off the farm, and the work must wait for a more convenient season; but as there is also a proper season for every crop, the golden opportunity is often lost, and poor crops and poor returns are the result. Farming will as little bear to be treated as secondary in importance, or to be put under secondary management, as any trade or calling.

One of the designs of this essay is to suggest "improved farm-management, so as to meet the peculiar wants of men and animals connected with the mines." In my opinion one of the principal causes why farming in connection with mines fails to be profitable, is that it partakes too much of the class system; that is to say, one object is too much kept in view, and the others deemed secondary or altogether lost sight of. That object in many instances is to provide as large a supply as possible of food for the numerous horses required above and below ground; the consequence is that the old grass land, as well as the seeds or artificial grass, are generally cut for hay year after year, and as in many instances few or no sheep and cattle are kept, the only manure that the old grass land gets is a slight dressing of either horse-manure or coal-ashes, so that the herbage grows poor in quality and gradually less in quantity. The other crops are often similarly treated, and give the same poor result. Summer fallowing is too much practised in a mining neighbourhood, and on some farms in connection with mines. The value of turnips as the cleaning crop in the rotation, and in a manner the sheet-anchor of all the others, is not appreciated, as roots are not absolutely required on a farm specially kept for the necessities of mines.

I would, therefore, suggest at the outset that a proportion of sheep and cattle should be kept and root-crops grown. Our modern system of husbandry, as practised on the most generally approved plan, will in the end be found to answer even the requirements of mines better than close adherence to the attainment of the immediate objects peculiar to this class of farms. The objects for which the farms are kept will, no doubt, often

necessitate some deviation from ordinary and independent farm-practice; but bad effects thence arising should be counteracted from other sources. If the straw is in great part taken off the farm, a corresponding outlay should be made in purchasing manures, and facilities for this frequently present themselves; for instance, the waggons which carry the minerals to the nearest town or seaport can be loaded with manure on their return journey. Even on farms where all the straw and green crops are consumed at home an extra outlay has to be made to maintain the fertility of the land, and there is always a much greater need for this where no sheep and cattle are kept. A large quantity of the droppings of the underground horses is lost in the workings of the mine; only about one-half of the excrements of the animals comes to bank, and with this there is always a slight admixture of small coal, which makes it somewhat cankerous; from the absence of litter, it requires either to be ploughed into the land at once, or mixed with other long manure on the farm.

On the mining farms with which I am connected it is found that the keeping of a moderate stock of sheep and cattle does not diminish but considerably increases the supply of food for the horses used in the mines. By depasturing and cutting our old grass land every alternate year, and by growing turnips on the arable land, the crops of both natural and artificial grasses are doubled, the quality being at the same time greatly improved. Such an increase of produce as I have spoken of will not be obtained on the first year of trial, but by degrees it will. It will be seen that this system, too, meets in some degree the wants of the men as well as the animals connected with the mines, for larger grain crops and good beef and mutton are produced, in addition to horse-food and other articles of produce required by the mines.

It will also be found more profitable to keep a full complement of horses for the proper working of the land, in addition to those required above bank by the mines. In cases of emergency they will be taken off the land; but if the work is in a forward state the loss will be the less felt, and rather than have the farm neglected it will be found profitable to hire the assistance of a few horses for a limited period. On the Lambton colliery farms the steam-plough has been used for the last four years, and has, besides reducing the number of horses kept for farm purposes, enabled the occasional drafting of them off to the pits to be almost unfelt; so that besides the ordinary and general advantages of steam-ploughing, there are in its use in the cultivation of land connected with mines special advantages which cannot be over-estimated.



Having mentioned the Lambton estate, I should be doing it very great injustice did I convey the idea that the short-comings in the management of mining farms spoken of existed there. On the contrary, the mining farms there will bear a comparison with the best-managed farms in this country. They are and have been for a long time under the able management of a veteran improver and patron of agriculture.

Milk is an article greatly in demand in a populous mining neighbourhood; but the keeping of cows is not found to be so serviceable an auxiliary to the production of horse-food as the sheep and bullock feeding. Cows are heavy consumers of hay and other produce, and their manure is not of the highest value. Besides, dairy-farming requires the constant superintendence of the principal, and the management of mining-farms is generally entrusted to servants, who, however dutiful they may be, have not the same interest in keeping all the machinery in motion as the small farmer and his wife have. It is, however, the duty of owners of mines to encourage dairy-farming, though they may not be able to practise it themselves.

I cannot see how farming could be carried on more for the benefit of the miners than by the system I have just advocated. To cater any further for their wants would perhaps lead to the much-condemned truck system. The best plan is to pay the men full current value for their labour in cash, and allow them to buy agricultural as well as other produce in the cheapest or any market they please. I see no way to give them any more direct interest or privilege in land other than the general public (except in providing them with gardens), unless it be by giving them the advantage of the "Limited Liability Act" and sell them shares not only in the mines but in the mining-farms as well. I have heard of this experiment being tried, but I cannot speak either of its success or failure. Time will prove its expediency or otherwise.

#### THE ASSIGNMENT OF ALLOTMENTS FOR MINERS.

The garden is the proper farm for the miner or other labourer, and by cultivating it with his own hands he is improved not only physically but morally. In the mining districts of the north of England the miners have generally a house and garden provided for them by their employers; but the allotment system, properly so called, viz., letting a piece of land at a fixed rental, does not obtain amongst any class of miners so far as I am aware. The gardens to which I have alluded, if they do not lie close to the house, are within as easy distances as circumstances will admit of. No money rental is paid for them, but along with the cottages they form a part of the stipulation for the miner's labour. The

average size of the gardens is from a sixth to a fifth of an imperial acre, and by the steadier portion of the men they are well managed, but by a good many they are totally neglected. The land, instead of being of secondary quality, is often above the average of the district. In several instances which have come under my own observation fields have been taken from tenant-farmers, who paid upwards of 2*l.* per imperial acre, and set apart as gardens for the miners. The plots are laid out like allotments, and frequently, by the men, called by that name. The appearance of these gardens, however, is often very uninviting. A great many of them are never planted, and they clothe themselves with weeds, which run to seed and blow over the others. They are frequently made grazing ground, and several old asses and worn-out ponies belonging to the miners may be seen tethered to the uncultivated plots to eat the spontaneous crop of weeds. Other plots again are taken up as playgrounds for games of quoits and pigeon-shooting matches, the favourite sports of the miners of the north. This is no exceptional state of matters—it presents itself in the majority of the mining districts of the north of England.

One very obvious reason for such neglect of the gardens is that, as a class, the miners are so unsettled and migratory in their habits. It is no unusual thing for 300 or 400 families to draft themselves off from one colliery at the annual term, and for as many fresh ones to come to occupy their places—not to take into account the large number of casuals who come and go all the year round. These families form no attachment either to their gardens or the neighbourhood, and it is much against their behaviour and general morality, for before either the clergyman or missionary becomes properly acquainted with them, they have made their exit to another mine, perhaps ten or twenty miles distant. Another reason for the neglect of the garden-plots is that the land becomes potato-sick to some extent, from the want of a proper rotation of cropping being followed. Many of the men have also a difficulty in getting manure for their gardens. Those who are improvident in their habits are careless about collecting manure until it is wanted, and because they have none and cannot afford to buy it the garden is either planted too late or not planted at all. Those, however, who look a little way before them have no difficulty in collecting sufficient manure by keeping a pig, by collecting droppings on the highways, and by forming compost-heaps of vegetable and other matter. If they leave at the term they sell their manure to their successor or other parties; but these generally are the men who remain.

Whether the allotment system, properly so called, would work well amongst miners I am not prepared to say; but when they neglect to cultivate what they have in a manner rent-free, it seems like an argument against the plan. There appears at least some

impracticability of successfully carrying out the allotment system amongst the mining classes. They differ from the workman of the manufacturer, who rents a house of his own, and who when he leaves one master can go to another without changing his residence; his allotment, which he finds it profitable to rent and cultivate, improves his health, gives force and elasticity to his mind, and tends to make him a better parent, a better servant, and a better subject of the realm. His allotment creates an attachment to the place in which he resides, and instead of being a sort of wanderer he becomes a citizen. But, on the other hand, the owners of mines have generally to build houses for their men in order to carry on the works successfully; but as the latter feel no security of tenure beyond a year, and when they leave one master they have to remove from the locality, they will not take much interest in an allotment. Unless men have either the hope or the prospect of remaining for some years upon a place, the allotment system would not work well. It would work equally well amongst miners as other labourers were they not peculiarly situated, and if they had cottages of their own it would tend greatly to their social elevation.

I think, however, that, taking the miners, as a class, and the circumstances in which they are placed into consideration, free or accommodation gardens form a good substitute for the allotment proper, especially if encouragement is given to the men to cultivate them properly. One of the best means of doing this is to organise a local horticultural society. On one of the collieries in the locality where I reside a society of this kind has of late years been established, and the good which it has been the means of doing has exceeded the expectations of its most sanguine promoters. It has given rise to a spirit of rivalry and emulation amongst the men in the cultivation of their gardens, the uncultivated plots are fast disappearing, and an air of comfort and neatness is connected with their dwellings. The men frequent the beershop much less than formerly, and are more contented. The annual show is looked forward to with much interest by the miners. It is held at a beautiful and romantic old castle, and as no intoxicating drink is allowed upon the grounds, the utmost order and harmony prevail. Innocent games are indulged in upon the green turf, and the presence of the masters and a sprinkling of the aristocracy gives a sort of *éclat* to the whole proceedings.

It is found that from a sixth to a fourth part of an acre is quite sufficient for any workman and his family to cultivate, the former being about the average allowance.

*Picketree, Chester-le-Street.*

---

XXVIII.—*The Supply of Meat to Large Towns.*

By ROBERT HERBERT.

THE comparative ease with which the metropolis was supplied with meat during the brief period when the movement of live stock per road and railway was prohibited on account of the cattle plague, has led many persons to assume that we are about to commence a new system; that live-cattle markets have become unnecessary, and that henceforth it will be far more advantageous for all parties concerned for London to be supplied with dead meat rather than live stock. So many important interests are involved in this question, that it becomes necessary to enter into a few details in order to see whether such suggestions can be carried out, and what might be their influence upon the price of meat, which exhibits a more rapid increase than does the consumption.

The statistical returns issued by order of the House of Commons inform us that in the United Kingdom there are 8,316,960 oxen and cows, 25,794,708 sheep, and 3,800,399 pigs in the hands of breeders, feeders, and graziers. If we assume the general accuracy both of these figures and of earlier estimates, it follows that the supply of beef has been kept up remarkably well during the last twenty years, but that the number of sheep and pigs has fallen off considerably. If the supply of sheep has declined, about which I have no doubt whatever, the present dearness of butchers' meat may be readily accounted for, and its cause is too deep seated to be affected much by even increased importations of foreign stock.

If attention be directed to the ease with which London was supplied during the time of the cattle plague, it must not be overlooked that Ireland, and Holland, and other parts of the Continent, forwarded large numbers of *live cattle* by water. Again, the movement of sheep, lambs, and pigs was not interfered with; so that the experiment, if such it was, has not as yet been fairly and fully tried. High prices were, indeed, realised for dead meat in Newgate and Leadenhall markets in March and April, but they were not of long continuance, and were followed by a severe check, owing to the pressure of supply, so that the returns to the owners of meat were much less than could have been obtained in local markets, where, at one time, prices were from 25 to 30 per cent. higher than in 1865.

Let us suppose that the Metropolitan market for the sale of live stock was abolished. The live stock imported from the Continent would, of course, be slaughtered in abattoirs erected near the place of landing—say at Blackwall. The supplies from Ireland would, in all probability, be disposed of and slaughtered at Derby, from

whence they would be transferred to London per railway. In that case, the carcasses of the foreign beasts, sheep, lambs, and pigs, though far inferior in quality to our best breeds, would have an undue advantage over our own country-killed meat, simply because they would make their appearance in the butchers' shops in a more saleable condition. Those who are not practically acquainted with the general bearings of the trade may feel disposed to doubt these assertions; but it is a fact that both beef and mutton killed in Scotland, Yorkshire, &c., invariably produces 2*d.* per 8*lbs.* less money in the metropolis than meat of a similar quality slaughtered in London. The difference, in other words, amounts to about 20*s.* per carcase for beef, and 2*s.* for mutton.

But, it may be asked, if the advantages attendant on the transmission of live animals rather than dead meat are great, how is it that so much dead meat is forwarded from time to time to Newgate and Leadenhall? This question is easily disposed of. At certain periods of the year the fleece can be much better disposed of in the country than in London—say, by from 2*d.* to 3*d.* per lb. This difference naturally induces the flock-masters to commence shearing early in spring, before the shorn sheep can well travel to market. They have very little difficulty in selling their wool for cash, except during periods of commercial depression; and for special qualities very high rates have frequently been realised. Rough fat, too, at times sells well in the country, from its being required by local tallow-melters. These advantages as to price, however, are of a temporary character, and, with the exception of wool, country prices are, as a whole, lower than those in London in the general run of years. Hence hides, skin, and fat would be forwarded to the metropolis at a heavy cost to the owners, who, in addition, would have to pay commission on sales. We will leave out of the question the lower portions of the animals, such as head, heart, fat, &c., because they must of necessity be consumed on the spot, and because they would barely pay the cost of carriage and commission.

But let us see the wide difference between the cost of sending live animals and dead meat to London from a distance. A bullock can be transmitted per railway and steamboat over 200 miles for 20*s.*; to that sum must be added about 4*s.* 6*d.* for commission and charges. To transmit four quarters of beef, the hide, and rough fat to the metropolis, the same distance—assuming that the animal weighed about 100 stones—would cost nearly 4*l.*, exclusive of the expenses of slaughtering and the payment for commission, viz., 1*d.* per 8 lbs. No doubt agents would be despatched to the provinces by some of the large London houses

to purchase hides, skins, fat, &c., so as to some extent to relieve the graziers; but the amount of business done would wholly depend upon the prices offered by local tanners and tallow-melters. The quotation for rough or internal fat, in the metropolis, is 2s. 2d. per 8 lbs. Obviously, after deducting the expense of carriage, &c., say for 200 miles and upwards, the grazier would not receive back more than 1s. 2d. per 8 lbs., instead of the full value, which he would be allowed when the animal was disposed of alive.

It may be well here to explain the great difference frequently, nay, almost invariably, observed between the prices realised for live stock and dead meat in London. In Newgate and Leadenhall beef sells at from 6d. to 8d.; mutton, 11d. to 1s. 2d.; lamb, 10d. to 1s. 4d.; veal, 8d. to 1s.; and pork 2d. per 8 lbs. beneath the quotations for live stock in the great metropolitan cattle-market. The wide difference in mutton may be thus explained. The lowest price for mutton refers to shorn sheep at the commencement of each season. After that period the value of the offal—in which, of course, the skin is included—increases until the full growth of wool has been obtained. If we assume a bullock to weigh, when dead, 100 stones, and if we take the difference at the lowest figure, 6d. per 8 lbs., we find that the sum to set against the offal is 2l. 10s., without taking into account charges and profits.

The attempt recently made to sell live stock by public auction in the cattle-market has, as yet, been otherwise than successful. This may have arisen from the amount of suspicion existing amongst the butchers as to the *bonâ fide* character of the biddings. It is well known that jobbers travel the country to buy up fat stock for transmission to London, many of them sending forward as many as 200 beasts in one week. These dealings are, of course, attended with great risk, according as trade is active or dull. A jobber may, perhaps, feel disposed to offer his stock by public sale; but the butchers have no guarantee that the beasts have in reality changed hands after having passed the hammer. In support of the system of sales by auction, an attack has, we perceive, been made upon the honour and integrity of the cattle-salesmen in London. This is to be regretted, because the charge of unfair dealing has been made without any real foundation. Their charges, at all events, are moderate. The toll paid per head for beasts is 3½d.; the charge for driving, tying, and commission added to this makes up about 4s. 6d. per head. The cost for conveyance by railway has further to be taken into account; but the grazier is in a position to have his beasts sold, all charges included, for about 20s. per head on the average. The amount is trifling in comparison with the great

advantage derived from the present system. On the day immediately following sales the owners of the stock receive a cheque for the whole of the stock disposed of, through the medium of London bankers, who charge for the transmission of the money 6*d.* per head for beasts, 1*d.* for sheep, and 4*d.* for calves. These amounts are, we understand, against the salesmen, who, in numerous instances, have to give long credit to the butchers. Without credit the butchers of the metropolis could scarcely exist as a body, and immense sums are frequently owing to the salesmen, upon whom the whole risk of loss devolves.

For some time past a Committee of the House of Commons has been sitting to inquire into the general working of the trade in live animals and dead meat; but neither the evidence taken nor the conclusions arrived at by the Committee are as yet before the public. Nearly the whole of the butchers who were examined contended that it would be impossible for their trade to be carried on in warm weather without the aid of a live-cattle market.

No doubt, at all periods of the year, there is a fair competition between those who consign live stock and dead meat to the metropolis for sale, and but for this we should have had prices far higher than they now are, and a considerable derangement in the trade generally. Evidence to the effect that the number of stock in the United Kingdom has sensibly diminished of late years was not well received, simply because it was impossible to prove the assertion from statistical details. But I do not hesitate to endorse that opinion. Prior to the passing of the revised tariff London was abundantly supplied with live stock and dead meat. We were not then dependent upon the foreigner for even a portion of our supply of animal food. The demand was fully met, and beef seldom ranged higher in the cattle-market than 4*s.* 4*d.* and mutton 4*s.* 6*d.* per 8 lbs. Of course we must make due allowance for the large increase in the population and the impulse given to consumption in large towns by the great development of our commerce. Such new demands, however, have been well met by large importations from abroad; and yet we have both beef and mutton now worth 6*s.* per 8 lbs., which could not have been the case if our supply had kept pace with our wants.

Comparisons have been frequently made between the London markets and the system adopted for the supply of Paris with meat, to the advantage of the latter. It has been assumed that the demand has been chiefly met by slaughtermen in the provinces, and that the abattoirs have furnished only about one-third of the consumption. The very reverse, however, has been the case, as we shall show from some statistical details furnished by the authorities expressly for this Paper. From them we find that, by an ordinance of the police, oxen and sheep are

not admissible into the market in Paris for sale. This restriction makes the actual quantity of stock disposed of appear to be very small when compared with Smithfield Market. The statistics of sales run thus:—

*Animals brought to and sold in the Markets of the Interior of Paris.*

Years.	Bulls.	Cows.	Calves.	Pigs.
1865 .. .. .	5863	27,910	211,217	182,994
First Quarter, 1866	1190	6,136	40,102	45,236
Total ..	7053	34,046	251,319	228,230

The above statement shows a much larger number of bulls, cows, calves, and pigs disposed of than in London, although the total head of stock falls considerably short of our own, owing to the exclusion of oxen and sheep from the markets. The next return to which I will call attention furnishes the number of animals slaughtered in the abattoirs of Paris in 1865. It is as follows:—

*Number of Animals slaughtered in the Paris Abattoirs.*

	Oxen and Bulls.	Cows.	Calves.	Sheep, Goats, &c.	Pigs.
1865 ..	146,738 ..	61,007 ..	207,663 ..	1,200,452 ..	131,772

The actual weight of the above supplies was, including 10,968,365 kilogrammes of pork and fat, 108,646,057 kilogrammes, or, reduced to English, about 108,000 tons. In 1864 the deliveries were:—

	Kilos.
Oxen, cows, calves, sheep, goats .. ..	96,213,497
Meat of pigs .. .. .	10,894,418
Total .. .. .	107,107,915

We now come to the consideration of the quantity of meat forwarded from the country in the two past years. The return for 1865 is as follows:—

*Meat brought from the Country.*

	Kilos.
Meat of ox, cow, calf, sheep, and goat ..	18,195,657
Pork and fat .. .. .	6,923,514
Total .. .. .	25,119,171

In 1864 the supplies were:—

	Kilos.
Meat of ox, cow, calf, sheep, and goats ..	17,268,014
Pork and fat .. .. .	7,092,486
Total .. .. .	24,361,504



The actual consumption in Paris, therefore, in 1864, was, in round numbers, 132,000 tons; but in 1865 it increased to 134,000 tons, and of these supplies only one-fifth came up as meat from the provinces.

It would be very difficult to ascertain the exact consumption of meat in London, both from the want of similar statistics to refer to, and because a portion of the stock disposed of in the metropolitan cattle-market is purchased by country butchers, who, moreover, frequently buy large quantities of dead meat in Newgate and Leadenhall. The charge in the Paris abattoirs for slaughtering stock is 2 francs per 100 kilogrammes, equal to 16s. per ton English weight. In addition to the above sum, there are levied octroi duties upon live stock entering Paris, as well as upon all meat delivered from the abattoirs. Those duties are: oxen and bulls from the departments, 53 francs; cows, 35 francs; calves, 11 francs; sheep and goats, 4 francs; and pigs, 14 francs per head. Entrance into the city is 10 francs 55 centimes per head; whilst the sum levied in the abattoirs, exclusive, of course, of slaughtering, is 8 francs 85 centimes per 100 kilogrammes, besides the decime, or one-tenth, in addition—charges such as would never be tolerated in this country.

During the last three years meat has risen seriously in price throughout France, and much higher rates are anticipated, as the production of live animals does not keep pace with the demand, to meet which, additional markets and slaughter-houses are nearly completed within the barriers. The quantity of country-killed meat disposed of in Paris is, as will be seen, small compared with the total consumption. Such, indeed, is the case in London, and no legislative or other interference could possibly change the present system. Those who imagine that it would be an easy thing to work a beneficial change, forget that meat is a perishable article and very expensive to move. Moreover it should be remembered that the consumers in London would, in the event of the live-stock market being abolished, be compelled to pay much higher prices for meat to cover the expenses of carriage, &c., and that we must have competition in the trade, or we should have a great amount of dissatisfaction amongst the great consuming classes.

XXIX.—*On Clovers.* By JAMES BUCKMAN, F.L.S., F.G.S., &c.  
Professor of Geology and Rural Economy.

THE Clover crop is so valuable, either for soiling and green food, or as supplementary to meadow hay, with a yet more nutritious herbage, it forms so harmonious a contrast with the cereal and other grass crops, it so frequently excites apprehensions of failure, and thus prompts us to look around for remedies, or for new and hardier species or varieties, that no apology need be offered for a few notes of experiments and observations on this tribe of plants, selected with special reference to the interests of the English farmer.

The leading characteristic of the genus is the trifoliate leaf, each leaf being composed of three leaflets; hence the Greeks called it *τριφυλλον*: the Latins *trifolium*, from *tres*, three, and *folium*, a leaf: the French, *trèfle*: and the English, *trefoil* or *clover*. Moreover it has a rounded, or *capitate*, head of flowers. In England we confine the term trefoil to the genus *Trifolium* as thus described, while other fodder forms of the *Papilionaceæ* are distinguished as clover allies; the French, however, use the term *trèfle* for the medics, saintfoin, and others.

As regards the species, our Native Floras describe somewhere about twenty. Beck, in his ‘United States Botany,’ has described seven species, the three following of which are stated to be “introduced.”

*Trifolium pratense*, “Red Clover, introduced from Europe.”

*Trifolium Pennsylvanicum*, “Buffalo Clover, resembles *T. medium* of Linnæus, introduced.”

*Trifolium agrarium*, “Golden Clover, introduced from Europe.”

I have referred to these names in order to direct attention to some practical observations connected with them, which bear upon our own agriculture.

Firstly. With regard to the American “red clover,” as I have seen it brought into New York for soiling purposes, and noticed it elsewhere in the States, it is a much larger and coarser plant than any we cultivate in England; this is doubtless due to a longer and warmer summer. Seed from this source, more especially if used in the colder parts of England, will be likely to cause disappointment, and I believe that much of the so-called clover sickness is due to want of attention in the selection of seed.

The wilder clover, as introduced in the meadows by the early European settlers, is usually the small hairy plant that we meet with at home, figured in English Botany, pl. 1770, and greatly different from *Trifolium pratense* of Sinclair, which is larger and quite smooth, and described by him under the head of *Trifolium pratense perenne*.

Secondly. The *Trifolium Pennsylvanicum*, gathered by me in the woods on the banks of the Hudson, is the true *T. medium*. Don remarks of it, "very like *T. medium* or *T. pratense*," which suggests that after all it may be but a variety of the latter. It is, as with us, of a large and handsome form.

Thirdly. The *Trifolium agrarium*, *Golden Clover*. This I take to be a cultivated form of the *T. pratense*, but I do not know it.

Our small native list of clovers seems very insignificant by the side of Don's descriptive list of one hundred and sixty-six species. This list, however, I think, is greatly made up of varieties, into which the different species seem to have a great aptitude for running, a point of considerable importance, as showing that it is within the cultivator's power to produce new and doubtless valuable forms as the result of care and attention.

But again, few as are our native forms, so many of them are insignificant in a farming point of view, that I shall only direct especial attention to the following:—

LIST OF AGRICULTURAL CLOVERS.

SECTION 1.—Flowers Rose-red or Purple.

No.	Botanical Name.	Trivial Name.	Duration.
1	<i>Trifolium pratense</i> .. ..	Broad Clover .. ..	Biennial.
2	<i>Trifolium pratense</i> , var. <i>perenne</i>	{ Perennial Clover or Cow-grass .. .. }	Perennial.
3	<i>Trifolium pratense</i> , var. <i>medium</i>	{ Zigzag Clover or Marl-grass .. .. }	Biennial or Perennial.
4	<i>Trifolium incarnatum</i> .. ..	Carnation Clover .. ..	Annual.

SECTION 2.—Flowers Pink.

5	<i>Trifolium hybridum</i> .. ..	Alsike Clover .. ..	Biennial.
6	<i>Trifolium striatum</i> .. ..	Soft-knotted Trefoil	Biennial.
7	<i>Trifolium fragiferum</i> .. ..	{ Strawberry-headed Trefoil .. .. }	Perennial.

SECTION 3.—Flowers White.

8	<i>Trifolium repens</i> .. ..	Dutch Clover .. ..	Perennial.
---	-------------------------------	--------------------	------------

SECTION 4.—Flowers Yellow.

9	<i>Trifolium filiforme</i> .. ..	{ Small-flowered or Suckling Clover .. }	Annual.
10	<i>Trifolium procumbens</i> .. ..	Hop Trefoil .. ..	Annual.

1. The *Trifolium pratense* of the meadow is met with in most parts of England, and seems to flourish in the drier pastures if not too often mown, for the scythe not only robs it of manure, but hinders the growth of fresh seed. In this case the plant is soon renewed by dressings of any kind of compost provided lime be present in sufficient quantity, a mixture of road dirt—

the scrapings from a road whose material has been mountain or even oolitic limestone, worked up with road-side parings, hedge-refuse, &c., answers best.

This clover, to the cultivated forms of which the names of Broad-leaved Clover, Annual Clover, and Red Clover are indifferently applied, differs greatly from the wild examples; principally, however, in the larger growth, rounded *hollow* stems (this latter is caused by the pith not quite filling up the centre), and by the general smoothness—absence of pubescence—of its different parts.

This hollowness of stem has given rise to some absurd theories. It is well known that sheep put into a fresh clover-field in a hungry (“leary”\*) state are liable to become “blasted,” and this effect is sometimes attributed to the wind in the stalks of common clover! It is, however, a sufficient answer to the assertion to state, that the clover at an early stage of its growth, before the hollowness of the stem is established, is much more dangerous than when the wood is hard and the stem most hollow. So much, however, do some of our west country farmers think that this condition is brought on by the introduction of wind into the stomach, that they often attribute it to the animals being driven against the wind; and it is quite true that the driving starving sheep in the face of a cold, easterly wind to some early clover, may greatly aggravate the mischief that may ensue, but from a very different cause from that generally supposed.

*Trifolium pratense*, Broad-leaved or Red Clover, both when wild and when cultivated, is, perhaps, as protean in form as any plant the farmer has to deal with. Some are more permanent than others; all are more or less hardy, and all more or less productive, and these differences have a high significance. However, it seldom happens that any particular type can be obtained pure, though the value of the seed varies just in proportion as it is so; for if you have in a field three sorts of clover, one of which flowers a fortnight before the other, one of which has a tendency to vigorous growth while the other is stunted, the more prolific will take possession of the soil, and overpower its rivals; while it may incline to become an annual, and so, after awhile, leave the ground to the dominion of weeds.

There are, then, three desiderata with regard to clover.

1st. A good sort or sorts.

2nd. Pure seed of the sort.

3rd. Seed from a known and suitable climate.

---

\* “Lear (1.), to learn.—*North*.

(2.) Hollow, empty. The lear ribs, the hollow under the rib.—*Var. dial*.

(3.) Pasture for sheep.—*Chesh*. Stubble land is generally called leers.”—Hallewell’s ‘Dictionary of Provincial and Archaic Words.’

1st. THE SORT OF CLOVER.—If we go into any large clover-field we shall find some indications of the following forms:—

*a. Trifolium pratense* (No. 1), Common Red Clover, Broad-leaved Clover.—Head of pink flowers somewhat compact, leaves more or less broad. Plant smooth in proportion to its size (the small wild specimens being usually very hairy); stem purple.

*b. Trifolium pratense*, var. *pallidum*, Pale-flowered Clover.—Head of very light pink flowers, large and full, nearly double the size of *a*, more or less hairy; stem green.

*c. Trifolium pratense*, var. *album*, White Clover.—Flowers white, herbage a very light green; in other respects much the same as the last.

*d. Trifolium pratense*, var. *perenne* (No 2), Perennial Red Clover.—Flowers less compact than the others, the whole plant having stems inclining to dark purple; leaves narrower, and always ovate.

*e. Trifolium pratense*, var. *perenne*, sub-var. *pallidum*, Pale Perennial Clover.—A larger plant than the parent form, due, like *b*, either to meadow or arable cultivation.

*f. Trifolium pratense*, var. *perenne*, sub-var. *album*, White Perennial Clover.—Not common, but still, like *c*, an albino form, which is a prevalent variation in purple-coloured plants. It is, perhaps, more delicate in constitution than the others.

Now all these forms of clover are usually much mixed, and unless the seed be very good, as regards purity of sort (which must not be confounded with purity or cleanness of sample), they may be made out in any large patch of clover. My own observations on six different fields, three of which professed to be seeded with broad-leaved clover and three with perennial clover, are expressed in the following Table:—

Table of Proportionals of different Clovers in Crops.

		Proportionals of Varieties.					
		<i>a.</i>	<i>b.</i>	<i>c.</i>	<i>d.</i>	<i>e.</i>	<i>f.</i>
1.	Broad-leaved Clover .. ..	65	10	3	16	4	2
2.	Ditto .. ..	5	80	5	5	4	1
3.	Ditto .. ..	4	95	1	..	..	..
4.	Perennial Clover .. ..	20	10	..	65	6	..
5.	Ditto .. ..	16	4	..	75	3	2
6.	Ditto .. ..	5	10	..	24	60	1

1. A very impure sample, nearly a fourth perennial.
2. Better, but far from good.
3. A fine field of Broad Clover.
4. More than a fourth Broad Clover.
5. Still impure.
6. Less like *perenne* than either; aspect almost that of Broad-leaved Clover.

These observations were made in June, principally in Dorset, Berks, and Gloucestershire.

2. *T. pratense*, var. *perenne*, Cow-grass; and 3. *T. pratense*, var. *medium*,\* Zigzag, or Marl-grass.

The latter clover is distinguished from the others by a peculiar angular bend from each joint. Its flowers are of a bright purple, in larger heads than those of the common meadow clover. I venture to mark this as a variety of *T. pratense*, not only from a review of its history, but as the result of direct experiment. Sinclair says of his *T. pratense perenne*,—"When examining the rich grazing lands in Lincolnshire, I found this plant to be more prevalent than any other species of clover. In clayey districts, and in soils of a peaty nature, this species of clover was more conspicuous than in the alluvial soils. The natural appearance of this plant in these celebrated pastures is such as to recommend it strongly for cultivation. It being strictly perennial, and the root only slightly creeping, it may be used for the alternate husbandry, for which the *T. medium* is inadmissible on account of its creeping roots, constituting what in arable land is termed *twitch*."

The creeping habit here referred to is common to the *T. medium* and *T. pratense perenne*, and in this respect these two forms agree with the *T. Pennsylvanicum*, which is further described as follows:—

"Stem much branched, flexuous; leaflets ovate-elliptic, obtuse, quite entire; stipulas awned; heads ovate, cylindrical, solitary, dense."

But besides this, I find from experiment that seed of the wild *T. medium* becomes indifferently *T. pratense*, *T. pratense perenne*, and therefore regard the three forms as only varieties.

While at the Agricultural College I experimented largely upon the different clovers, and having gathered seeds of *T. medium* from a sand district, its usual wild habitat, planted them in some stiff land on the Forest Marble. Without detailing the intermediate steps, suffice it to state that I was enabled to produce all the three forms under discussion from this seed, and have, therefore, now no hesitation in pronouncing these three forms to be mere varieties of the common Broad-leaved or Red Clover.

This is not a mere botanical distinction, but has its importance in an agricultural point of view: there can be no doubt that the sand form was originally obtained because the ordinary clover had begun to fail, and it was found often to meet the difficulty, but this in turn has become merged into further

---

\* This plant will be found well figured in 'Science and Practice in Farm Cultivation,' by the author.

varieties, the leading characteristics being almost worn out, so that now the difficulty is to get a true sort. *Trifolium medium* is no longer sold, and is difficult to get, but the so-named *T. pratense perenne* is still sold. It is, however, a curious fact that the same seed will not behave alike in different soils, and hence we hear constant threats of action at law for supposed supply of wrong sorts.

4. *The Trifolium incarnatum*, Carnation Clover, is hardly a native plant, although it is one now commonly cultivated. It is quick in growth, of a hardy constitution, and yields a large crop of herbage for sheep feed in a most difficult part of the year, namely the end of April or the beginning of May. In its wild state it is a small and exceedingly hairy plant, by cultivation it becomes larger in all its parts, and highly succulent.

It is sown broadcast on the corn stubbles, with only such slight preparation as scarifying, when it soon comes up, and after the young plants have escaped the rigours of winter it begins to grow with such rapidity as to be ready for feed all of a sudden; this presents a difficulty, to remedy which the French profess to have a tardy variety (*Trefle incarnat. tardif*). Having grown this side by side with the ordinary market form I decidedly conclude that if there be any difference it is not sufficient to be of practical importance. I prefer, therefore, to sow a limited portion of this trefoil for early feed, and to depend upon vetches for a succession.

The best soil for this plant is sandy loam. On land of this kind I had a crop nearly a foot high and well covering the ground by the 1st of May, and that in a comparatively backward season.

5. *Trifolium hybridum*, Alsike Clover. This, too, is an exotic plant, but now too well known to need description. Well grown, it is a large and most useful plant, and has been recommended for soils reputed to be clover sick, and I have occasionally met with good crops when ordinary broad clover has failed, but have never observed it to possess that truly perennial character which some people claim for it. Our seed supply is mostly obtained from the Continent, and it is very difficult to obtain it at all pure; one example I got, named "Pure Alsike Clover," contained as many as 100,000 weed seeds in a pint, being quite enough to ensure a sufficient crop of weeds to smother the clover effectually, and this is doubtless a frequent source of failure in this crop.

6. *Trifolium striatum*, Soft-knotted trefoil, is a wild British plant which has lately been introduced to cultivation by Mr. Waldon. I was favoured with some seed from the Messrs. Sutton in June of this year, and I have now plants as

much as six inches in height; it, however, is so small in all its parts that with my present limited knowledge of its growth under cultivation I can scarcely pronounce in its favour. It may interest those who have any superstitious regard for a "four-leaved clover" to learn that in a small plot of this species I could obtain at least a dozen leaves of this kind.

7. *Trifolium fragiferum*, Strawberry-headed trefoil, is here noted from the similarity of its herbage to that of the White Dutch clover. Its pink flowers and expanding head of calyces, which are red, and of the form of a strawberry, sufficiently distinguish the two, and this is of importance, since this species is indicative of cold clay land, while the *T. repens* delights in lighter soil.

8. *Trifolium repens*, White Dutch Clover, grown on light soils. This is sometimes called White Suckling clover, a name probably due to the fact that ewes or early lambs do remarkably well upon it. If intended for hay it should always be mixed with the hop trefoil, *Medicago lupulina*, as it is otherwise apt to be short, and to root in the ground, a habit which enables it soon to recover the close biting by sheep; the more it is fed the more perennial is its habit.

9, 10. The *Trifolium filiforme* and *T. procumbens* are two common forms of the smaller yellow-flowered clovers. The first was formerly called Suckling clover, and was recommended for cultivation for young calves, but the small quantity of herbage it yields is much against its use.

The *Hop Clover* is here inserted in order to point out that though it is the true hop clover of the botanist, it is not the hop trefoil of the farmer, which belongs to the medics. It gets the name of hop clover from the peculiar aspect, like a bunch of hops, of the withered head of flowers which remains even until the seed is ripened. This plant was formerly cultivated, but its scanty and innutritious herbage soon brought it into disfavour, and caused it to be superseded by the *Medicago lupulina*, whose leaves are so much like those of the *T. procumbens* as to have caused the transference of its name. There can be no doubt but that this medic is a most important addition to our list of plants of this family, for although it can scarcely be recommended for self use, yet in combination with red clover, or rye grass, or saintfoin, it is of great value. I this year made a crop of hay from a mixture of broad-leaved clover and medicago, which is calculated at about  $2\frac{1}{2}$  tons per acre, and had a patch in which it was mixed with saintfoin yielding as good a cut.



## ON CLOVER SICKNESS.

For some years we have heard a great deal of land being incapable of growing clover, or, as it is usually expressed, being "clover sick," and it must be confessed that in some districts there is an increased difficulty in growing clover. I am disposed to attribute this difficulty to the fact that much of our seed is derived from warmer climates, and perhaps from richer soil, but principally to the mode of cultivation commonly adopted; the barley, sown at the same time, forcing it in the first year into a weak and spindled young plant. The effect is much the same as that pointed out by our Dorsetshire Burns as the result of allowing no playground for children.

The children will soon have noo pleice  
 Vor to play in, an' if they do grow,  
 They will have a thin musheroom face,  
 Wi' their bodies so sumple as dough.  
 But a man is a meäde ov a child,  
 An' his limbs do grow worksome by play,  
 An' if the young child's little body's a spoild,  
 Why the man's wull the sooner decay.

Now if this be so where so many years follow as a corrective to the cramping system, can it be wondered that the second half of the history of the plant should be affected by the smothering and drawing up of the first half.

The mischief is augmented in the second year by the growth of weeds, not only in those native to the soil, but those too often sown with the seed.

Some years since I instituted a series of inquiries into this matter, and then found that samples of clover seed as received from different seedsmen were shamefully dirty. Like other inspectors of nuisances I received no small amount of ill-will for my pains, but I have sufficient reward in the fact that for the last five years I have not met with such dirty samples as I then exposed, although within this year I have examined as many as fifty specimens, obtained from both "large and small" seedsmen, and have others in hand.

For some years at Cirencester we kept up plots of different clovers, and found that when drilled and kept clear of weeds, the annual red clover would keep a good plant for three or four years, and that by digging and sowing again, a good crop could be got, and once we could point to beds of perennial clover that had been kept up for as much as seven years in good condition. Indeed I consider the common to be as nearly perennial as almost any perennial plants. But if it be attacked by weeds and parasites it will with difficulty be grown at all.

But the soil and mode of cultivation is a common cause of the so-called clover sickness. On the oolites of the Cothswolds, on which we have perhaps 4 inches of soil and then the solid rock, we constantly hear of this complaint; indeed on the College farm of oolitic sand, all the land was said to be clover sick, and so long as the plough was not allowed to go deeper than 4 inches, it undoubtedly was so. But when the impression gained ground that these 4 inches had been worked out, it was determined to use the steam-plough for our roots, to the depth of 12 inches, then followed the barley to be succeeded by clover, and the crop referred to of  $2\frac{1}{2}$  tons of hay to the acre was attributed to this method of cultivation. I have now the same promise in another field with the same treatment, and begin to think that deep cultivation for roots is a present cure for clover sickness, and therefore, so far from waiting the prescribed eight years for another crop of clover, I have pursued my own course independently of my predecessor, in each instance eliciting the remark, "Who would have thought it?"

I look then upon the subject of clover sickness as one dependent upon the following precautions:—

1st. A judicious change and choice of seed.

We inquire as to the soil whence we get our seed barley and wheat, but whoever asks this with regard to clover?

2nd. The rejection, as a rule, of foreign seed, more especially if from a warmer country.

3rd. Clovers should be self-sown to be perfect, but if sown with grain we should at all events take care to sow clean seeds in clean land; weeds, added to the hindrance by corn, will be too much for any plant grown in the same way, so that we might call land sick of any crop if similarly treated.

4th. Deeper cultivation, if only to the extent of three or four inches, for if we go deeper we have fresh capital to draw upon; indeed, deep cultivation may be regarded as the renovator of the soil for the present generation.

Much of the food-producing matter of the soil to the ordinary depth of common ploughing has of late been flushed into the sea. It is to be hoped that satisfactory means of stopping this waste will be discovered and promptly acted upon, but meanwhile, the steam-plough may obviate immediate deficiencies.

*Bradford Abbas,  
Sherborne.*

---

XXX.—*General Cattle Mutual Insurance Fund.\**

By W. FARR, F.R.S.

1. *Six thousand* head of cattle die weekly of disease, according to some computations, in the United Kingdom during ordinary years ; and, at intervals, diseases, like epidemics among men, break out with violence and destroy two or three times that number. † These diseases are called “plagues” or “epizootics.” ‡ Some of them are propagated by contagion, and others are produced by soil, bad food, bad water, seasons, dirt, and close sheds, which also render epizootics fatal.

2. It is a peculiarity of cattle plagues, either in the form of Rinderpest, Pleuropneumonia, or Anthrax (Foot-and-mouth disease), that while the whole stock of the country, as far as we know, appears to be susceptible, they single out and sweep away the cattle on particular spots and leave others unscathed. It is in such cases a loss to the whole community ; but when the loss falls first upon wealthy owners, it is annoying but not ruinous. The poor man’s cow, the dairyman’s stock, and the farmer’s herds, are, however, usually the victims, and the destruction of a large portion of their capital is often the ruin of individuals.

3. The community at large suffers in the loss of animal food by some classes, and its increased price to others. By virtue of a well-known economical law, when the supply of a necessary of life falls off, the demand remaining the same, prices rise, and the consumer within certain limits pays the same amount of money or more for a diminished amount of the commodities brought to market. § The competition of buyers renders this result inevitable. Thus if one in twenty-one of the cattle are destroyed, the owners of the residual twenty will in the end probably get as much for the produce of twenty as they get in the ordinary state of the market for the produce of twenty-one. A rise of 5 per cent. in the price will suffice to produce this

\* The following Paper is that referred to by Dr. Farr in his Lecture on the same subject (see Report of Discussions). It was framed as an alternative to the scheme for voluntary Insurance which he then brought forward.—P. II. F.

† The ordinary cattle stock by enumeration is about 8,600,000 ; and at a mortality of 5 per cent. per annum the deaths would be 430,000 a year ; at 4 per cent., 344,000—that is, between 8000 and 6000 a week. In Great Britain, at the same rates, the weekly deaths are 4000 or 5000 a week.

‡ *Epidemic* is derived from the Greek *epi*, upon, and *demos*, the people ; epizootic comes from *epi*, upon, and *zoon* (*ζῷον*), an animal. Smallpox is now a contagious disease, and is always found in London ; it is sometimes fatal to four or five people, at other times to eighty or a hundred a week. In the latter case it is said to be epidemic. So Rinderpest is always found in Southern Russia ; when it is active and diffusive, killing many beasts, it is epizootic.

§ See ‘Tooke on Prices.’

effect. This principle is interfered with for a time by the desire of small holders of stock to realize the value of perishable commodities exposed to extraordinary risks, and by the artificial disturbance of the markets.\* There can be no doubt that since the panic of the cattle plague began, the consumers have been mulcted of much larger sums than the producers have lost as a body by the destruction of stock. The retail prices of beef and mutton, milk, butter, cheese, and other articles of animal produce, have risen to an extent which there are no exact means of determining: and if the dealers have hitherto got the largest share of the profit, that will no longer be the case should the supply be really diminished. The owners of live stock in England, as well as in Ireland and abroad, will in that case ultimately get increased prices; but the unfortunate farmers who lose their stock—and any one may be in this predicament—will realize none of the advantages of high prices, as they will have little or nothing to sell.† The profits will all go into the pockets of their competitors.

Every owner of stock is in this case exposed to the risk of excessive losses; and yet we may reasonably hope that the general loss will be limited. It is a case for which insurance appears to be the natural remedy. It is not, therefore, surprising that insurance prevails in Germany and has been suggested at many county meetings, has been actually resorted to in many places, and has been urged on the Government by Professor Gamgee‡ and by such able men as Sir James Kay Shuttleworth.

4. Insurance of everything except live stock is practised more extensively in England, perhaps, than in any other country; and it is applied every day successfully to goods, ships, furniture, houses and men. But it is by no means so easy a matter to establish a system of insurance in the face of a plague, as some persons who have not reflected upon the subject imagine. And, after all, insurance does not prevent losses; it only diminishes their ill effects to individuals by distributing the pressure until it becomes so light as to be scarcely felt by the multitudes insured, who are repaid by augmented prices and by the security they all enjoy from the dread of overwhelming misfortune.

5. For the sake of illustration, let us assume that there are

\* See an excellent memorandum on the Price of Cattle during the Plagues of the last Century, by Mr. T. G. Baring, M.P.

† In Cheshire 42,922 cattle had been killed or died of Rinderpest up to 21st of April, 1866. In Forfarshire, 9452 died out of 37,501. During the same period only 169 died in Devon of plague out of 184,203; in Kirkcudbright, 34 out of 34,692; in Peebles, 5 out of 5975.

‡ See his evidence in First Report of Cattle Plague Commission. See also note at the end of Third Report of Cattle Plague Commission, p. xvi.

10,000,000 head of cattle in the United Kingdom: and that, at 10*l.* per head, they are worth 100,000,000*l.* Now let each owner pay 1*l.* a head, or 10,000,000*l.*, into a mutual insurance fund: then it is evident that, if 1,000,000 die in a year of plague, the fund can pay 10*l.* a head to the owners of the 1,000,000 cattle. Assume that the 10,000,000 cattle belong to 500,000 owners, and that the whole of the losses fall upon *one-tenth of their number*: then each of the 50,000 will receive, on an average, 200*l.* of compensation, to which *each* of the 450,000 other owners who sustain no loss of stock will contribute 20*l.* But this he may recoup in great part by the increased value of the produce of his own intact stock.\* Whatever expense each fortunate owner incurs in insurance will be shared in variable proportions by the whole population of consumers. I have taken this extreme case to make the principle clear; but it is not probable that in value the total loss of stock will amount to anything like the above sum.†

Eight shillings and sixpence a head on the cattle of Great Britain, 4*s.* 7*d.* a head on the cattle of the United Kingdom, will pay at the rate of 10*l.* a head the whole of the reported losses by Rinderpest. And 3½*d.* a week on all, 6*d.* a head on the cattle of Great Britain, would pay at the same rate the loss of 11,873 beasts, the number dying and killed in the week ending Feb. 17th, when the mortality was highest.‡ This seems to show the possibility of meeting the losses of cattle out of a mutual fund to which the owners of stock have all contributed, and on which, in the event of loss they should have an equal claim.

The claim on the State for compensation cannot be sustained without admitting claims to compensation for other commercial losses, such as losses by the late tempestuous weather, by fires, by the explosions of mines, by the cotton famine, and by trading companies.§ And the tenant has no equitable claim on his

\* See prices of cattle at Ballinasloe Fair: Customs Valuation in 1864 and 1865; also wholesale prices of meat at pp. 470, 471; and prices of milk, cheese, and butter during the winter.

† The greater part of the paper was written in January.

‡ The price of a quart of milk is now 5*d.* in London; it was 3*d.* in the neighbourhood. In 'Morton's Farmer's Almanac' for 1866, p. 8, the average annual yield of a cow is set down at 540 gallons—the wholesale price at 8*d.* a gallon; giving 360 shillings a-year, or nearly *seven* shillings a-week.

§ The author appears here tacitly to adopt a view respecting existing payments which is prevalent among every class of the community, except that which owns stock and occupies land; if it be erroneous, such error should hardly be passed over unnoticed in this Journal.

Those who watched carefully the speeches and proceedings of genuine agriculturists in the autumn of 1865 and the spring of 1866 will, I think, bear out the following statements:—

1. It was agreed by them that, whatever might be the abstract right or wrong

landlord; for, as the landlord has no claim to any share in extraordinary profits, he cannot be expected to insure the tenant against extraordinary losses. Much less has the grazier any commercial claim on other owners of property. Many London butchers have realized probably a penny on every pound of meat they have sold since the panic set in, and if the legislature should make butchers—as some other tradespeople do—take out a licence, they would have no just ground of complaint.

### 1. NATURE AND DIFFICULTIES OF CATTLE INSURANCE.

The premium to insure a given sum payable on the death of an animal, if it happen during a given time, varies with the rate of mortality in the class to which the animal belongs. Thus, if 5 oxen in 10,000 die in a week, then a premium of 50*l.* in the aggregate, or 5*l.* on each 1000 head of oxen—less than five farthings a head—will insure 10*l.* on each death happening in the week: double the sum, or 100*l.*—that is, 10*l.* for each 1000—will insure 20*l.* on each death: as 5, by hypothesis, die, there are (5 × 20 =) 100*l.* to be divided equally among the owners. For double the time the premium is double. To provide compensation for the value lost, the premium is then fixed so as to be proportional (1) to the value of the animal, (2) to the term of insurance, and (3) to the mortality.\*

The *Term of Insurance* is arbitrary, and may be one month or more; in the insurance of human life it is never less than a year.

The *Value of Cattle* varies with age, breed, condition, and a variety of circumstances. Excluding calves, it ranges say from 5*l.* to 35*l.*; and to insure cattle of various values, in proportion to their value, there must be some means of identification. Otherwise the larger sum may be claimed by mistake, or fraud, for the death of an inferior animal. Some of the local Insurance Societies have not been afraid to encounter this difficulty.

By insuring to the full value the owner may cease to have any

of the matter, it was not expedient to urge on the State any claim for pecuniary aid.

2. A tax on cattle would have been resorted to, but that the proposal broke down utterly when it was discussed by men of practical experience.

3. Recourse was had to a county rate, because, of all existing machinery, that appeared most to affect the landed interest, and least the commercial classes.

4. The money was required *not* to compensate a farmer for his losses, but to pay him for cattle taken out of his control to be slaughtered for the public good.

From these premises it would follow that we should not pay for mere losses, and that a farmer would have no claim for payment whose stock are not killed, at least as soon as the Rinderpest manifests itself in them. In this, as in the case of the cotton famine, there was no machinery available which would raise local taxes exclusively from one class.—P. H. Frere.

\* See p. 467.

interest in the life of the beast or in arresting epizootics; but this is met by restricting the insurance in amount to a definite proportion of the value.

The Societies have again often, by insuring the life of the animals against Rinderpest alone, rendered it necessary to prove after death that the animal has died of that disease. This is plain enough in certain cases, but in other cases it is attended with insuperable difficulties. It involves expense, loss of time, examination by skilled veterinarians, whose decision after all must always be open to dispute, as the diagnosis is in some cases impossible, and in others exceedingly difficult.

If this refinement were attempted in the insurance of human life the whole fabric would fall to pieces. The insurant would never be sure of his money, the offices would be defrauded, and endless disputes and litigation would arise. Besides, if the principle of insurance is good, it is as good against other diseases, such as Pneumonia and Foot-and-mouth disease, as it is against Rinderpest. Even losses by common diseases fall irregularly: a farmer may lose no cattle for months, or years, and then lose great numbers in a short time. In cattle insurance the large experience which we have in life insurance should be turned to account, and the insured sum should be payable on proof of *death by disease* within the stipulated time.

Local Insurance Societies have to encounter another difficulty, which they can only partially surmount by selection. The insurants have a variety of options which they instinctively exercise against the Societies. The mortality in animals attacked by Rinderpest is about 85 per cent.: to insure 10*l.* the net premium should be 8*l.* 10*s.* Again, the reported mortality among the cattle on farms in which Rinderpest had appeared, had been by late returns (up to January) about 39 per cent.: to insure 10*l.*, therefore, the net premium on such cattle at the date of invasion should be 3*l.* 18*s.* per head. But, taking all the cattle of Great Britain, a premium of 8*s.* 6*d.* a head on existing stock would pay 10*l.* a head on all the reported deaths by Rinderpest up to May 26th.

It is evident that, under a voluntary system of insurance, at any reasonable premium, the owners of the cattle on the farms attacked, and of the thousands of farms and places around, would rush to the Insurance Society, while the majority of owners in the distance would stand aloof, and only resort to the Society when the danger was imminent.

Hence the ruin of all local Societies in districts largely infected is inevitable. Under the circumstances, effectual insurance on a small scale on the voluntary principle is impossible.

## II. CATTLE INSURANCE IS DESIRABLE.

That the insurance of cattle is as desirable as the insurance of houses, goods, furniture, and ships, it is unnecessary to go into any argument to prove. Insurance is open to abuse, and let us suppose that on this ground fire and marine insurances are abolished, and how many persons will every month be ruined! Into what a state of alarm many of the persons now insured will be thrown by the approach or even the mention of a fire. The large Companies, whose

“ventures are not in one bottom trusted,  
Nor to one place,”

remain at ease as they insure their own ships; while of the merchant with a solitary ship, the “mind is tossing on the ocean.” The winds, the sands, and the “holy edifice of stone” itself, remind him that he is “even now worth this, and now worth nothing.” But the farmer’s nerves are no stronger than the merchant’s; and the loss of property in animals who share some of that essence which is called life, undoubtedly shakes the mind more than the destruction of inanimate structures. Hence panic in all quarters: the farmer hears of the ruin of his neighbour, and sees in imagination all his own cattle drooping and dying: for in the presence of a great indefinite danger the mind is bewildered; and, dreading the loss of all, a man does not resort to available means for saving any.

In the cities of the Continent, cholera a few months ago excited inconceivable terror: in England we waited, *counted the deaths*, and fell back upon past experience. None of the English insurance offices shut their doors: all was known and was calculated beforehand. English coolness here had fair play. But of the Cattle-Plague we have little definite knowledge, save that it kills 85 per cent of the animals it attacks, and that its activity is increasing every week.\* It is invading new districts. Not only the farmer, but every Englishman is disturbed at the prospect of the “Roast Beef of Old England” vanishing. Measures to reassure, rather than to stimulate, the public mind are required; and one of these measures is unquestionably a system of general cattle insurance. It would at once inspire confidence, and give time for the operation of hygienic measures.

I cannot agree with those who think that the tendency of insurance up to seven-tenths of the value of stock would slacken the zeal of the owners, either in seeking for remedies or in

---

\* Written in January, but is still applicable, as we are open to other attacks of Rinderpest and of epizootics of other kinds.



employing precautions against attack. It would rather have a contrary tendency, and promote that steady coolness which is indispensable to success in encountering danger, and which has stood our race in good stead of old.

M. About, in one of his clever French pamphlets, has the following remark\* :—“ J’ai remarqué que l’assurance attirait surtout les hommes calmes, froidement bons, dévoués par raison plutôt que par coup de tête, assez sages pour envisager sans trouble la plus pénible nécessité de la vie. Elle nous est arrivée d’Angleterre ; elle réussit surtout dans nos villes laborieuses, peuplées d’hommes sans passions, réguliers, tranquillement actifs.”†

Insurance is not only a consequence but a primary cause of this state of mind ; it is the mother of confidence.

### III. GENERAL INSURANCE IS PRACTICABLE.

I have shown that local Cattle Insurance against death by a single disease on the voluntary principle is impracticable in time of plague, and it is difficult at other times inasmuch as the options are so numerous against the insurer.

If it were practicable it would be immediately taken in hand as a commercial speculation ; but in this age of companies, no great substantial office has come forward in the city of London to speculate on this field. Yet they know well that the field is large, and that the farmers in infected districts would receive them with open arms. They conceive that cattle insurance, on the voluntary principle, is impracticable.

I will now endeavour to prove that *General Cattle Insurance* on some simple principle is practicable ; and that the difficulties can all be fairly overcome. This can be best done by the outline of a system for its accomplishment.

1. I begin by laying down this principle, that the system, to be effective and equitable, must be strictly of the nature of self-supporting *Mutual Insurance*. The owners of insured cattle alone must be called upon for contributions, and the amounts paid must be restricted to the sums which those contributions will provide. Thus all eleemosynary claims, all charitable gifts, any guarantee from the Exchequer, are out of the question in this matter of business based on the economic principle of service in exchange for service of equivalent value.

---

\* ‘L’Assurance.’ Par M. Edmond About.

† “ I have remarked that Insurance has special attractions for those who are calm, coldly good, the followers of reason rather than impulse, philosophers enough to look steadily in the face the most painful exigence in life. Insurance comes to us from England, and prospers most in our industrial towns peopled with men devoid of passion, regular, quietly active.”

Charity is an excellent thing, but its admixture with calculation is as fatal as it is corrupting.\*

The reasons against a state guarantee are stated with irresistible force by the late Chancellor of the Exchequer in his letter to Sir J. D. Lloyd.†

2. *Insurable Value.*—The owner of cattle destroyed by plague suffers not only by the loss of their value but by the interruption of his business: as a feeder of stock, he has grass, turnips and mangold which run to waste; as a milkman he loses his customers; as a breeder he sees the labour of years destroyed. The full market price of his stock does not compensate him for his loss. It would, on these grounds, be desirable to ensure to the full value; but that is unsafe and impracticable.

It is not lawful to effect an insurance on a life in which the person insuring has no pecuniary interest; and the abuse of ship

\* By this it is not implied that charity has not scope for exercise in a calamity such as plague. I know no men who deserve more sympathy than such cattle owners of Cheshire and Forfarshire as have obeyed the law, and done their best to stay the progress of this disease.

† Mr. Gladstone wrote as follows—

“The reasons which first offer themselves to my mind . . . are of the following character:

“1. The difficulty, and not the difficulty only, but the impossibility, of preventing carelessness, waste, and fraud of every kind, from the first moment it should become known that the ultimate responsibility (beyond a fixed limit, which would at once be found a very, very narrow one) lay with the public purse.

“2. The fact that in a number of cases particular districts and landlords have already made their own arrangements, which must have been acted upon. Were Government to move into the field, these good examples would be neutralised, and those who have met their own losses would be called as taxpayers to assist in meeting the losses of other people too.

“3. If it shall appear, as is probable, that it is to prevention rather than cure or compensation that we must chiefly look, under Providence, for the mitigation of the calamity, nothing could be so unfortunate as a measure like a state guarantee, which, by relaxing vigilance and the ingenuity of self-interest, would tend to take the minds of men off a subject obviously of the greatest moment, and, as clearly, not yet sounded to the bottom. This objection does not apply to plans of a voluntary nature, where every man would be checked by his neighbours, and each scheme would have its proper adjustments.

“4. If the cattle plague should not extend itself on a large scale, and so the losses of a severe character should be confined to a small fraction of the farming class, there seems an obvious impropriety in relieving landlords, neighbours, and rateable property from the duty of assisting, so far as assistance is necessary, those on whom the blow has fallen. And the precedent would be an evil one.

“5. But if, on the other hand, the disease should extend very widely, the result must inevitably be felt in a much augmented price of meat. The consumer would then, probably, taking the country all over, pay the same or a larger aggregate amount of money for a greatly diminished quantity. All those who were not smitten in their own cattle would thus profit largely by the disease as producers, while as consumers they would only suffer in common with the community at large. How, then, could the community be asked to pay twice, first for their meat in extra price, and secondly, for the cattle lost; while landlords and cultivators of the soil would probably, as a class, have their loss (as in a bad corn year) counterbalanced by a corresponding or greater benefit?”

insurance arises from the practice of insurance at full value. It is usual to insure moveables up to a given proportion of the value; and that would suffice in the case of cattle, of which the value daily fluctuates. Seven-tenths of the value may be taken as the maximum *insurable value*; all the mutual insurers would on this scale retain a large interest in the lives of stock; and, as they pay for each other's losses, each would be interested in general fair dealing.

3. Insurance is inapplicable to things of small value. It is not worth the expense. Thus it is not worth the while to insure calves or any beast worth less than 5*l.*; there are, moreover, difficulties of weekly changes of value or of identification in the case of small, obscure, cheap animals.

4. If the insurance is confined to cattle of the value of 10*l.* and upwards per head, the work may proceed in this fashion.

Every owner is called upon to pay *a florin* for every head of such cattle in his possession on a given day, and at such intervals through the year following as may be required to meet the exigencies of the case, such calls being publicly announced beforehand.

For this premium he gets a policy of insurance entitling him to 7*l.* on proof of the death by disease of any insured beast. It is here assumed, as in the case of slaughter for Rinderpest, that there is no salvage, for which, however, special provision can be easily made when the insurance is on seven-tenths of the value.

The collection of the premiums, the custody of the money, and the payment of the farmer for losses, on terms to be strictly enforced and watched, would be the essence of this business.

If the insurance is for an invariable sum, and is restricted to cattle above a given value, it would be only necessary that the owner should send in a certificate affirming the death of an animal insured; the fact being corroborated by two of his co-insurers and by a policeman or some other officer after view of the dead body.

Under this simple form of insurance, if the mortality of the cattle insured did not exceed 5 per cent. per annum, about two shillings or a florin a quarter would pay the insurance; if it were 10 per cent. per annum—and it is not likely to exceed this rate—a florin every six weeks would pay the insurance and probably all its attendant expenses.

It may be here mentioned that the duty on a dog of any description is 12*s.* a year; any whelp or young dog under six months of age being exempt. For a horse or a mule exceeding 13 hands in height, kept for riding or for drawing any carriage chargeable with duty, the owner pays 2*l.* a year. For other horses the charge is 10*s.* 6*d.* each. For ponies the charge is

10s. 6*d.* or 5s. 3*d.* each, according to the purpose for which the pony is kept. I shall subsequently endeavour to show that the premium of insurance would not exceed the horse duty; and there would be this difference, that the payer of the premium would get for it a policy in exchange.

In certain cases it would be desirable to insure cattle at seven-tenths of *their actual value*; this may be undertaken, but under such a system the means of identification must be secured, and it must be done by individual policies—or policies covering herds of nearly equal value—arranged in books like checks, which could be transferred with the animals. Where salvage is allowed, as it would except in deaths from Rinderpest, seven-tenths of profit to go to fund; three-tenths to insurant.\*

It will be found that the mortality of cattle varies with age; differs in milch-cows and bullocks; is not the same in good and in bad hygienic conditions. When adequate data are collected these elements should all be taken into account, in the mean time they would be recorded for future use.

#### IV. ADMINISTRATION OF THE MUTUAL INSURANCE FUND.

The Insurance business would be partly of a professional but chiefly of a financial character; and it might be administered either by a special department or by an extension of some of the great existing departments, such as that of the Post Office, or the Inland Revenue,† which have officers distributed at pretty equal intervals over the kingdom.

It is probable that the *Postmaster-General* would not be willing to undertake the business. But as it is only necessary for my purpose to give an outline of a plan, leaving the Government and the Legislature to select the machinery, I will assume that the Cattle Insurance Fund is administered on the same principle as Government Annuities, and the National system of Life Insurance: the National Debt Commissioners being the bankers; the Postmaster-General the responsible Administrator.

#### V. OUTLINE PLAN OF CATTLE INSURANCE.

The system, being general, can only be established by an Act of Parliament. It would be made perfectly intelligible to the

---

\* Salvage is the sum that can be realised by the sale of the hide and dead carcase of the diseased beast.

† The Inland Revenue Department has, since this was written, enumerated with its accustomed ability the live-stock of Great Britain; and the Cattle Statistical Department has been constituted under Colonel Harness, with Mr. W. Clode as superintendent.

whole country by the discussions in both Houses of Parliament and in the newspapers.

Immediately upon the passing of the Act, the Postmaster-General will by advertisement call upon all owners of stock to send their names and addresses to the nearest post-office, where they would be thrown into a list to be completed by further inquiry.

The Postmaster-General will then send a circular form to all owners,\* with the request that they will give a complete list of cattle in their sheds or on the grounds in their occupation: distinguishing breeds and ages of bulls, oxen, steers, cows, and heifers, with their estimate of their respective value on that day. Where owners neglect to fill up the forms or to pay the premiums, they must pay the extra expense incurred. Small owners would be missed in large number; but the omission would be on their part, and they would get no compensation for losses unless they were insured. In the end they would come in to secure the advantages, which would be greater to them than to larger owners.

After verification by a qualified officer, the list of cattle to be insured would be returned to the owner for his inspection: he would then certify to its accuracy [in the presence of a magistrate or public officer?], return it, and give notice of his having sent the stipulated amount (say 2*s.* a head) of premium to the appointed office. Beasts sick at the date of contract, either to be excluded, or to be charged additional premiums.

Upon paying the premium, the owner would get a policy entitling him to a specific sum for every head of insured cattle that dies before the next instalment of his premium becomes due; the insurance to be renewed periodically upon the payment of the premiums to be fixed by the administrating office: of which public announcement would be made through the usual channels.

Immediate notice, under penalty, to be given of the attack of any cattle, insured or not, by any serious disease; and, if it were deemed necessary, arrangements would be made for inspection by the existing inspectors, or others specially appointed.

The claims for death to be sent in immediately, certified by the owner and two co-insurers, or by two other satisfactory referees. The body to be open to inspection upon this being required by the office. The sum insured to be paid within one month of the proof of death. Arrangements to be made for the compensation of owners whose cattle were killed by public order or with the written sanction of the authorities or their inspectors.

---

\* The person in whose legal custody the cattle are, to be considered the owner. Cattle grazing on other men's grounds to be specially dealt with.

Anything sanctioned by the authorities for suppressing disease to be facilitated in every way by the administration of the fund; and the inspectors under proper arrangements to be called in for advice.

The operations of the fund in each county to be reported on periodically, and the Report for each county to be sent to the Justices, or other authorities, for any observations or suggestions which they may have to make.

The premiums, if charged per head, would on this plan *vary with the mortality*; that is, they would be payable by equal instalments of say 2s. a head, collected at *longer or shorter intervals* of time, so as to meet the losses.\* The same principle might be applied if the premium were rated upon the value.

Insurants might have the option of paying variable premiums at quarterly or fixed intervals of time.

If the premiums are collected in advance, the profits accruing on their investment would go towards the expenses, which would be rigorously provided out of the fund.

This measure might be tried for a single year, and re-enacted annually with any suggested improvements: the plan would have a fair trial, and perhaps have answered its immediate purpose, in the course of three years. Any surplus in the fund might be distributed as in other Mutual Insurance Societies, by way of bonus amongst the members.

The information thus collected and laid before Parliament would aid in the investigation of the causes of cattle mortality, and would thus complete the inquiry which the Royal Commission has commenced.

There can be no doubt that the severity of these causes of mortality can be greatly diminished by judicious hygienic measures; and that the saving of stock would pay the expenses incurred.

The fund for *England, Scotland, and Ireland* to be separately administered; each country thus insuring its own stock.

If the general scheme be not adopted the scheme is applicable to counties by the intervention of the county treasurers, the police, the cattle inspectors, and the collectors of county rates. The committees of magistrates might select a Joint Managing Committee, all subject to the approval of the Secretary of State.

Arrangements might be made with existing local Insurance Societies, and their ablest officers might be engaged. Contributors to this fund to be entitled to such an addition to the

---

\* The premiums would not in ordinary times be called for oftener than every other month, and in times of Rinderpest not oftener than monthly.

sum allowed as compensation for cattle slaughtered by authority as would make up the full sum insured.

To avoid tediousness, I do not enter into a multitude of administrative details, on which the success of the measure depends.

(I.) PROBLEMS IN CATTLE INSURANCE.

Allowing nothing for expenses, or profits of speculation, or interest,—What premium ( $p$ ) should be paid to insure a cow of the value of ( $s$ ) pounds sterling, for any unit of time during which ( $d$ ) of such cows will die out of ( $c$ ) living at the beginning of the time?

The aggregate of the premiums payable for ( $c$ ) cows will be  $p c$ ; and the aggregate of the payments for the cows dying will be  $d s$  by hypothesis. By the conditions of the question  $p c = s d$ .

$$\therefore p = \frac{d}{c} s = \mu s$$

It will be convenient to write  $\frac{d}{c} = \mu =$  the probability of dying within the time.

If  $p$  is the premium for a week, then two premiums will be required for two weeks, fifty-two for fifty-two weeks, and  $n$  for  $n$  weeks.

*Examples.*

(1.) If 5000 cattle die in a week out of 10,000,000 head, then to insure an animal worth 15*l.* the weekly premium is

$$p = \frac{5000s}{10,000,000} = \cdot0005 \times 15 = \text{£}0075$$

or a little more than  $1\frac{3}{4}d$ .

(2.) If the probability that cows attacked by Rinderpest will die of that disease is correctly expressed by  $\mu = \cdot85$ , then  $p = \mu \times s = \cdot85 \times 15 = 12\cdot75*l.*$  at least is required to insure 15*l.* on the death by Rinderpest of a cow attacked with the decisive symptoms.

*Note.*—The mean duration of the disease appears to be about ten days, and the premium is consequently 8·925*l.* for a week of seven days.

(3.) If among the 200,000 cattle on farms that suffer from Rinderpest, 7000 will die weekly, the premium to insure a cow on such farms, worth 15*l.* will be half a guinea a week :

$$p = \mu s = \frac{7 \times 15}{200} = \cdot035 \times 15 = \cdot525$$

Thus the premium ranges from 7 farthings to 10*s.* 6*d.*, and to 8*l.* 18*s.* 6*d.* a week.

Hence the power of selecting cases against an office on the voluntary principle in time of plague is enormous.

## DURATION OF DISEASE.

$$\begin{aligned} \text{Average numbers sick} &= S \\ \text{Attacks of sickness in a week} &= A \\ \text{Duration of disease in weeks} &= \frac{S}{A} = \frac{13083}{9243} = 1.42 \text{ weeks} = 9.94 \text{ days.} \end{aligned}$$

## (2.) DISTINCTIVE CHARACTERS OF CATTLE, AS AFFECTING THEIR INSURANCE.

1. Cattle are slaughtered for food at various ages, and are probably not kept on an average four years.

2. Their lives are further shortened by diseases of various kinds. In this respect they resemble human beings, but epidemics are not so fatal as epizootics. In the present day cattle drink generally from the water of ponds into which their dung and urine drop, or are washed from fields and roads—the precise conditions which render cholera and dysentery so fatal in India.

3. They are exposed to emanations from each other in crowded sheds and yards, at fairs, in railway trucks, and in ships.\* They are fed in unnatural conditions.

4. Their mortality from all causes is not known; but judging from analogy it must be highest in calves, lowest in yearlings, and after the second year increase year by year as age advances. The mortality under attacks of disease is probably governed by similar laws.

5. The value of cattle varies much, according to age, sex, and breed; the state of the market and of the season; or according as they are fat or lean, in milk or dry, in calf or barren. Some of these changes are very rapid. A fattening ox in the last stage will cost about 10s. per week for keep, and the increase in value ought to be proportionate. These changes have to be taken into account by an office insuring cattle; it is necessary to take measures that on the whole will make the office the worst market to which the owner can carry his animal—that is, to insure for less than the minimum value.

6. Cattle are not so easily identified as men: and they are transferred from owner to owner, from breeding district to feeding district, from the cowhouse and stall to the market.

7. Short-term insurances alone are applicable: they should not run for more than a year nor less than 3 months.

8. The policies on registration to be transferable on indorsement with the animals. This registration of sales and prices may be in other respects useful.

---

\* They are hurried to the railway station in the heat of the day; left there to chill till midnight; whirled along through the chill dank air of autumn nights—a modern and most prolific source of disease.—P. H. F.



FORM OF CERTIFICATE ENCLOSING CLAIM.

I hereby certify that the following head of cattle, insured in the Mutual Insurance Fund through the *Postmaster-General*, died of disease at the dates annexed.

Description.	Cause of Death.	Date of Death.
Bull .. .. .		
Ox .. .. .		

The above is a true statement,

JOHN JONES, Owner.

(Address.)

I have seen the dead bodies of the above cattle, which, I believe, are insured by the *Postmaster-General*, and died of disease by natural causes.

EDWARD EVANS,

(an Insurant of Cattle in the Mutual Insurance Fund).

(Address.)

Similar certificate to be signed by the other witness, whose certificate is required.

FORM A. (*Where Insurance is on office value.*)

CATTLE in the Sheds and on Farms in the occupation of \_\_\_\_\_, in the Parish of \_\_\_\_\_.

No.	Description.	Age.	Value estimated by Owner.	Insured Value.	Remarks.
		Years.	£.	£.	
1	Cow (Shorthorn), white	2	18	12	
2	Ox (Hereford), red ..	4	30	21	
3	Cow (Devon), red ..	6	15	10	
4	Ditto .. .. .	3	13	9	

*Note.*—The office value would be taken at the lowest estimated value of the beast in health during the term of insurance. Thus, if a cow when first in milk is worth 22*l.*, and out of milk 18*l.*, the latter sum will be the office value, which would be the limit of insurable value.

Policy to run in this sort of form :—

No. . . . . Date, August (October) 1, 1866. Term of policy *one year*; expires August (October) 1, 1867.

The *Postmaster-General* has received from *John Jones*, of the parish of *Bradley*, the premiums for each head of the annexed list of cattle.

And he hereby undertakes to pay the said owner the insured value on

proof of the death by disease of any of the said cattle before the next premium becomes due, of which liability notice will be given. This policy continues in force so long as the premiums or instalments are regularly paid within fourteen days of their falling due.

Head of Cattle.	Description.	Premium Paid.	Insured Value.
	Rate.		£
1	Here follows a list of—Bulls ..	6 per cent.	18
6	Oxen ..	„	84
14	Cows ..	„	140
2	Steers ..	„	14
2	Heifers ..	„	20
25	Ordinary premium .. .. .	16 11 0	276
	Discount .. .. .	0 16 6	
	Premium Discounted .. .. .	£ 15 14 6	

*Note.*—The above premium may be paid in *monthly* instalments of 1*l.* 7*s.* 8*d.* each, due on the first of every month, from August 1, 1866, to July 1, 1867. A discount of 5 per cent. allowed for present payment.

AVERAGE PRICES OF IMPORTED CATTLE, SHEEP, and SWINE, as given by the Inspector-General of Imports.

	1864.		1865.	
	November.	December.	November.	December.
	£ s. d.	£ s. d.	£ s. d.	£ s. d.
Oxen and Bulls:—				
From Portugal and Spain ..	16 0 0	16 10 0	17 0 0	17 0 0
„ other countries .. ..	15 0 0	18 10 0	17 8 0	19 0 0
Cows .. .. .	16 0 0	16 0 0	14 6 8	16 0 0
Calves .. .. .	4 19 6	5 0 0	4 0 0	4 15 0
Sheep:—				
From Hanse Towns .. ..	1 14 0	1 10 0	1 0 0	0 19 0
„ Holland .. .. .	1 15 0	2 0 0	2 11 0	2 11 0
Lambs .. .. .	0 17 0	1 5 0	0 15 0	0 15 0
Swine and Pigs .. .. .	2 5 0	2 6 0	3 0 0	3 0 0

RISE in the PRICE of CATTLE at BALLINASLOE FAIR.  
(Thom's Almanac, 1866.)

OXEN.

	1st Class.	2nd Class.	3rd Class.	4th Class.
	£ s. d.	£ s. d.	£ s. d.	£ s. d.
1864 .. ..	20 10 0	17 0 0	12 15 0	7 12 6
1865 .. ..	22 10 0	18 10 0	13 10 0	9 0 0
Excess in 1865 .. ..	2 0 0	1 10 0	0 15 0	1 7 6

## HEIFERS.

	1st Class.			2nd Class.			3rd Class.			4th Class.		
	£	s.	d.	£	s.	d.	£	s.	d.	£	s.	d.
1864 .. ..	20	10	0	15	10	0	11	0	0	7	10	0
1865 .. ..	22	10	0	17	0	0	12	10	0	8	10	0
Excess in 1865 .. ..	2	0	0	1	10	0	1	10	0	1	0	0

The average rise in the price of the four classes of oxen was 1*l.* 8*s.*; the average price in 1864 having been 14*l.* 9*s.* 5*d.*, and in 1865 15*l.* 17*s.* 6*d.*, or 10 per cent. rise.

A premium of 7*s.* would insure 7*l.* on the death of a beast among cattle whose mortality did not exceed 5 per cent.; the rise in the price of 1*l.* 8*s.* would insure the same sum amongst cattle whose mortality was 20 per cent.

AVERAGE PRICES of MEAT per lb. at Leadenhall and Newgate Markets  
(by the Carcase).

Years.	BEEF.			MUTTON.		
	Range of Prices.		Mean.	Range of Prices.		Mean.
	<i>d.</i>	<i>d.</i>	<i>d.</i>	<i>d.</i>	<i>d.</i>	<i>d.</i>
1850	3·125	— 4·875	4·000	3·875	— 5·500	4·688
1851	3·125	— 5·000	4·063	3·750	— 5·750	4·750
1852	3·250	— 5·000	4·125	4·000	— 5·750	4·875
1853	4·000	— 5·750	4·875	4·750	— 7·000	5·875
1854	4·500	— 6·500	5·500	4·750	— 7·000	5·875
Mean of 5 years, 1850-54	3·600	— 5·425	4·513	4·225	— 6·200	5·213
1855	4·750	— 6·625	5·687	4·750	— 6·750	5·750
1856	4·250	— 6·500	5·375	4·750	— 6·750	5·750
1857	4·250	— 6·500	5·375	4·750	— 7·000	5·875
1858	4·250	— 6·250	5·250	4·500	— 6·750	5·625
1859	4·500	— 6·500	5·500	4·750	— 7·000	5·875
Mean of 5 years, 1855-59	4·400	— 6·475	5·438	4·700	— 6·850	5·775
1860	4·000	— 6·625	5·313	5·000	— 7·125	6·065
1861	4·000	— 6·500	5·250	5·000	— 7·250	6·125
1862	4·000	— 6·250	5·125	5·000	— 6·750	5·875
1863	4·250	— 6·250	5·250	4·750	— 7·000	5·875
1864	4·500	— 6·500	5·500	5·375	— 7·000	6·187
Mean of 5 years, 1860-64	4·150	— 6·425	5·288	5·025	— 7·025	6·025
Mean of 15 years, 1850-64	4·050	— 6·108	5·079	4·650	— 6·692	5·671
1865	4·500	— 7·000	5·750	5·875	— 8·250	7·062
Half-year ending June 30,	4·625	— 6·875	5·750	5·500	— 8·125	6·813
1866 .. .. .						

XXXI.—*Field Experiments on Clover-Seeds.* By DR. AUGUSTUS  
VOELCKER.

IN accordance with the instructions of the Chemical Committee, I have been engaged for some years past in setting on foot a number of field experiments. The results of some of them have already appeared in the Journal, and others I hope to publish from time to time.

The subject of the present communication is a short report on field experiments on clover, that were made in the years 1864 and 1865.

These years were very dry, and consequently unfavourable for field experiments with artificial manures. The unusually dry spring of 1864, more particularly, was unsuited to experiments on clover-seeds.

In the beginning of the spring of that year I sent the manures designed for use to a number of intelligent men, personally known to me, and for the greater part former pupils of mine. They were willing and competent to carry out my instructions with every possible care.

It was my intention to have tested in the field, under as great a variety of conditions, as regards soil and situation, as it was possible for me to secure, the effects which nitrate of soda, or salts of potash, or ammonia, are capable of producing on a crop of clover-seeds.

Unfortunately the season entirely spoiled most of the experiments, and all the reports, except one, sent to me at the close of the season contained only accounts of more or less complete failures.

It is useless to record in detail all the failures that have been reported to me, both in 1864 and 1865. There are few matters so disappointing to a farmer as having an experiment entirely spoiled by an adverse season, on which more than ordinary care, pains, and expense have been bestowed. Such disappointments, however, are inseparable from experimental farming, and, therefore, every one who wishes to engage in it with heart and soul must be quite prepared to experience many failures through no fault of his own, and to realise but few successful and satisfactory results.

In most field experiments with artificial manures, the chief, if not sole object, of the experimenter is to ascertain which kind of manure, or what combination of fertilizing matters, produces the greatest money-return for the outlay in manure. With this

object in view, the farmer selects for his trials two, three, or more fertilizers, which are either recommended to him by manure merchants, or by their general reputation. Practical experiments of that kind, continued for a number of years and tried upon a variety of crops, no doubt teach many a useful lesson. I do not, therefore, like to say a single word which might appear to disparage such attempts made by the farmer to gain experience in his own way; nay, I have a strong conviction that it is better for a man to arrange and observe field-trials, though they may not be conceived in the most philosophical manner, or carried out with the greatest precision, than to abstain altogether from manifesting an interest in this matter. At the same time, however, it is a fact that purely practical experiments, professedly made with no other object in view but to test the money-value of certain manures, frequently do not elicit the information which is sought for, but rather lead to misconceptions. At the best such experiments are rarely of any value to others differently situated as regards climate or soil, and they certainly do not furnish serviceable facts in building up agriculture as a practical science, which should ever be the aim of the scientific agriculturist.

If it be borne in mind that the main purpose for which the experiments described in the following pages were instituted, was not to find out the most beneficial artificial manure for a crop of seeds, surprise will not be felt at my excluding from my scheme guano and other complex manures, more likely to give a good economical result than several of the simple saline matters which were actually tried.

The final aim of all field-trials with manures is to obtain a maximum produce at the least expense, without injuring the land. This most desirable practical advantage, however, is rarely if ever secured at once by direct manuring experiments; generally speaking, the way leading to its final realization has to be prepared by many preliminary trials, which do not appear to have any direct relation to the final object, but nevertheless must be regarded as important and indispensable steps towards its attainment.

As long as we do not know what are the separate effects which salts of potash, or of soda, or of ammonia are capable of producing when applied to our different crops under the great variety of conditions in which they may be grown, it is not likely that the most profitable use will be made of those complex artificial manures which are now so largely manufactured in England or imported from abroad, and are recommended by dealers in manures more or less confidently for special purposes.

For this reason I endeavoured to devise a manuring scheme which should recommend itself by simplicity, and include as far as possible conditions essential to success. After a good deal of deliberation I selected the following substances for field-trials on clover-seeds:—

1. Nitrate of soda.
2. Sulphate of ammonia.
3. Soluble phosphate, in the shape of dissolved bone-ash or mineral superphosphate.
4. Common salt (chloride of sodium).
5. Muriate of potash (chloride of potassium).
6. Sulphate of potash.
7. Sulphate of lime.
8. Mineral superphosphate and nitrate of soda mixed together in equal proportions.
9. Mineral superphosphate and muriate of potash mixed together in equal proportions.

Perhaps it may not be amiss for me to say a few words in explanation of the choice which I was led to make.

In the first place I was particularly anxious to ascertain what the effects of potash would be on crops which, like a clover-crop, remove from the soil a large proportion of this important element of nutrition. During the last three years I have tried upon a variety of crops both sulphate and muriate of potash, as well as foreign crude potash salts, which at present can be procured in England at a reasonable price. Hitherto the results have not been very conclusive, or rather, I should say, in most cases my experience of salts of potash does not warrant me to recommend with much confidence the artificial supply of potash to the generality of soils even when it is intended to grow plants which are known to require much potash for coming into perfection. The want of success may be due to a variety of causes. It may be due to the lateness of the season at which the potash manures were applied; and a better effect might have been produced had these salts been applied to the land in autumn instead of in the spring. Again, it is more than probable that most soils in a fair agricultural condition neither require nor are benefited in the least by the exclusive artificial supply of potash. It certainly is a fact that many soils contain abundance of available potash, and on such soils salts of potash are not likely to produce any effect even when applied to crops which remove more potash from the land than others. The state of combination, as well as the more or less concentrated condition in which

potash is applied, unquestionably must affect the result, and we therefore require experience of the use of such compounds, especially those which, either on account of their excessive or deficient solubility, may prove to be inefficacious or hurtful to vegetation. Again, it appeared to me probable that although the exclusive use of potash might not be marked by any very striking results, in conjunction with soluble phosphate of lime it might produce a more beneficial effect and enhance the utility of the latter. We know from experience that the exclusive application of ammoniacal salts to the land does not produce nearly so good an effect on many crops as their combination with superphosphate, and the supposition that a mixture of phosphatic and potash manures would have a similarly beneficial effect, therefore appears not unreasonable.

Considerations of that kind determined me to suggest the application of potash in the form of two salts, widely differing from each other as regards their solubility in water. The first, chloride of potassium, or muriate of potassium, as it is commonly called, is a highly soluble and deliquescent salt; which, moreover, is the cheapest form in which potash can be purchased. The second, sulphate of potash, is a salt characterised by its slow solubility in cold water. Bearing in mind that simultaneously with potash we present to the growing plant chlorine in one of these salts and sulphuric acid in the other, and that chlorine, as well as sulphuric acid, are normal and essential ash-constituents of plants, I desired, if possible, to eliminate in separate trials the share in the manuring effects which the acid constituents of the two potash salts used in the experiments might have. To this end I recommended separate trials with chloride of sodium, and with sulphate of lime. In chloride of sodium we possess a readily soluble salt, which compares well in this respect with chloride of potassium, whilst the chlorine is united with soda, of which we know that it does not produce any distinct fertilizing effect upon vegetation. In order to eliminate the share of sulphuric acid in the total manuring effect of sulphate of potash, I might have suggested sulphate of soda for trial, but my choice fell upon sulphate of lime, because in one of the experiments soluble phosphate of lime was to be used, which compound can only be practically used in conjunction with sulphate of lime, inasmuch as the preparation of soluble phosphate of lime is necessarily accompanied by the production of much sulphate of lime. The experiment with sulphate of lime thus answers the twofold purpose of eliminating the share of sulphuric acid in the total effect of sulphate of potash, and that of sulphuric acid (used in

combination with lime) in the total effect which superphosphate of lime may be supposed to produce.

Sulphate of ammonia favours in most marked degree the growth of cereals, and as clover is commonly sown together with Italian rye-grass, I was desirous to ascertain, by experiment, whether the probable effects of potash on clover were at all comparable with the well-known effects which sulphate of ammonia produces on cereals, and for this reason recommended a separate trial with that salt.

The manurial properties of nitrates in many respects resemble those of ammonia salts. Although this is true in a general way, some leguminous crops, for instance beans, are decidedly stimulated in their growth by nitrate of soda, whilst ammoniacal salts, in most seasons, either produce no effect on them, or sometimes exert an injurious influence. There are grounds for believing that nitrate of soda in some cases may be usefully applied to clover, hence a trial with this salt was suggested.

I freely discuss the circumstances which led me to adopt the preceding manuring scheme, because I anticipate valuable hints for future experiments from similar discussions by others, whose remarks will be gladly received by me at all times.

With regard to the size of the experimental plots, I suggested that each should be one-twentieth of an acre, but I am now inclined to think a somewhat larger area would have been better. My chief reason for my recommendation was to enable the experimenter conveniently to cut down and weigh the whole produce in one day.

Believing that the effects of potash-salts would be most perceptible on light sandy soils, I got the majority of the experiments tried on such soils; but I regret to say, both in 1864 and 1865, the clover-seeds on the light land farms turned out more or less complete failures. It affords me, therefore, particular pleasure to be able to put on record at least one successful series of experiments, which were carefully carried out by my friend Mr. Jacob Wilson, of Woodhorn Manor, Morpeth.

The field selected for the experiments was thoroughly drained 4 feet deep in the year 1857, and otherwise in a good state of cultivation. It grew a heavy crop of wheat in 1863, upon which mixed clover and rye-grass were sown by a broadcast drill, and horse-hoed in by Garrett's horse-hoe. The whole field was one of 24 acres, and had a gentle slope towards the south-east. From a part where the plant was most regular, half an acre was measured out, and divided into ten equal plots of one-twentieth of an acre each.



The ten plots were treated as follows, as regards manure:—

Plots.	Name of Manure.	Quantity of Manure per Plot.	Rate per Acre.		
			Tons.	cwts.	lbs.
1	Nitrate of Soda .. .. .	22½ lbs.	0	4	0
2	Sulphate of Ammonia .. .. .	22½ „	0	4	0
3	Dissolved Bone-ash (soluble phosphate)	22½ „	0	4	0
4	Common Salt .. .. .	22½ „	0	4	0
5	Unmanured .. .. .	.. .. .	..	..	..
6	Muriate of Potash .. .. .	22½ „	0	4	0
7	Sulphate of Potash .. .. .	22½ „	0	4	0
8	Sulphate of Lime .. .. .	1 cwt.	1	0	0
9	{ Dissolved Bone-ash .. .. .	22½ lbs.	0	4	0
	{ Nitrate of Soda .. .. .	22½ „	0	4	0
10	{ Dissolved Bone-ash .. .. .	22½ „	0	4	0
	{ Muriate of Potash .. .. .	22½ „	0	4	0

The artificial manures were applied on the 23rd of April, and the clover was cut on July 6th, 1864, and the produce from each plot carefully weighed, when the results contained in the subjoined table were obtained.

TABLE showing the Produce of Clover-seeds (mixed Clover and Rye-grass) in lbs. on Experimental Plots of  $\frac{1}{20}$  of an Acre each, made at Woodhorn Manor, Morpeth, in 1864, and Produce calculated per Acre.

Plots.	Manure used.	Weight of Clover per Plot.	Weight of Clover per Acre.		
			Tons.	cwts.	lbs.
		lbs.			
1	Nitrate of Soda .. .. .	901½	8	0	110
2	Sulphate of Ammonia .. .. .	1009	9	0	20
3	Dissolved Bone-ash .. .. .	711½	6	7	1
4	Common Salt .. .. .	603¾	5	7	91
5	Unmanured .. .. .	805	7	3	84
6	Muriate of Potash .. .. .	711½	6	7	1
7	Sulphate of Potash .. .. .	744	6	12	96
8	Sulphate of Lime .. .. .	794	7	1	88
9	Dissolved Bone-ash and Nitrate of Soda	1084	9	6	8
10	Dissolved Bone-ash and Muriate of Potash	1133	10	2	36

The preceding figures, in the accuracy of which every confidence can be placed, are curious in many respects. They show, amongst other things:—

1. That neither muriate nor sulphate of potash gave an increase; on the contrary, both forms in which potash was used appear to have diminished, to some extent, the produce.

2. That the unmanured plot (No. 5) gave about the same produce as that to which sulphate of lime was applied.

3. That mineral superphosphate, or dissolved bone-ash, has had a less beneficial effect than sulphate of lime.

4. That common salt diminished the produce to a considerable extent.

5. That nitrate of soda alone, and still more so sulphate of ammonia, produced a very considerable increase in the grass-crop.

6. That the addition of soluble phosphate of lime (mineral superphosphate) to nitrate of soda had a very beneficial effect.

7. That the highest produce was obtained on Plot 10, on which mineral superphosphate and muriate of potash had been used. The produce of 10 tons  $2\frac{1}{4}$  cwts. per acre is large. It is remarkable that whilst Plot 3, manured with mineral superphosphate, and Plot 6, manured with muriate of potash, gave precisely the same produce, which was somewhat less than that on the unmanured part of the field, the mixture of both manures on Plot 10 gave the largest weight of mixed clover and grass per acre of any of the 10 experimental plots.

It must be confessed that some of the facts brought out in these experiments are opposed to what we know of the efficacy of fertilizers such as superphosphate and gypsum, and I do not believe for a moment that the latter is superior to the former as a manure for "seeds."

It is well known that very soluble manures, such as muriate of potash or even common salt, occasionally have rather an injurious than beneficial effect on vegetation; but it is difficult to understand why two manures, which each separately gave no increase at all, but rather diminished the crop, should, when mixed together, produce such a beneficial result as in Plot 10.

It is much to be regretted that we have in these experiments only one plot left unmanured. This is a great defect, for it leaves us altogether in the dark with regard to the natural variations in the productive powers of different portions of the same experimental field. In future experiments I will take care to have left three plots unmanured: one on each side of the manured plots, and one right in the midst of them. Many of the anomalies which so much perplex the experimenting farmer, I am convinced are due either to inequalities in the plant, or to essential differences in the staple, or agricultural condition of the several experimental plots. We may do our best to select in a field half-an-acre or an acre of what appears to be a perfectly uniform piece of clover-seeds, and yet the actual weighings of the produce will frequently show that we have failed to pick out two plots precisely on an equality as to plant. We should, therefore, have at least two unmanured portions, and I believe three will be

better than two. A third unmanured portion, left in the middle of the several manured plots, will do much towards manifesting the natural variations in the trial-ground, and greatly diminish the chances of error.

The soil of the field on which the preceding experiments were tried was a strong loam resting on clayey subsoil, and adapted for the growth of seeds; for it will be seen that, notwithstanding the dryness of the season, the crop on the unmanured portion of the field was by no means a bad one.

The latter part of the summer of 1864, it will be remembered, in many places was much drier than the earlier part. It was intended to weigh the aftermath as well as the first cuttings on each plot; but it was such a complete failure as not to be worth cutting.

Mr. Wilson kindly furnished me with the following notes which he took on the field during the progress of the experiments.

During May and June Plot 1 (nitrate of soda), 9 (superphosphate and nitrate of soda), and 10 (superphosphate and muriate of potash), were decidedly above the rest, especially Plot 1.

Plot 1.—The rye-grass was very luxuriant, having come away early, and with it a considerable portion of shaken wheat from the previous crop; clover was about an average mixture.

Plot 2 (sulphate of ammonia). Rye-grass and shaken wheat very gross; clover an average plant.

Plot 3 (mineral superphosphate).—A most perfect and clean crop of clover, with a very small mixture of rye-grass, which appeared weakly, none of it coming away till late in the season.

Plot 4 (common salt). Very little clover, and rye-grass very puny and weak.

Plot 5 (left unmanured).—Crop very similar to that on Plot 4.

Plot 6 (muriate of potash).—A very fair mixture of clover and rye-grass; the crop, on the whole, quite an average for the year. Amongst the clovers there was a good deal of white clover, and there was also a good deal of shaken wheat.

Plot 7 (sulphate of potash).—Crop very similar to that on the preceding plot, showing a good deal of white clover and shaken wheat; plant somewhat more regular than on Plot 6.

Plot 8 (sulphate of lime).—Clover better than on Plot 7; rye-grass superior, the general crop slightly heavier.

Plot 9 (mineral superphosphate and nitrate of soda).—A fair crop of clover, with an enormously gross mixture of rye-grass, shaken wheat, and a great many *thistles*, which were scarcely visible in the other plots; the rye-grass and wheat were of an immense height.

Plot 10 (mineral superphosphate and muriate of potash).—A very regular mixture of clover (especially red) and rye-grass; an extremely clean crop, and by far the best of the ten plots.

Mr. Wilson writes further to me:—"Owing to the extremely dry season, the aftermath was a complete failure and not worth cutting, as previously mentioned. As far, however, as I could notice—and I was particular on this point—the relative proportions of each plot in the second crop were quite in harmony with those in the first crop; and I have no doubt if they had been severally weighed, such would have been found the case."

These observations are interesting and practically useful. They show unmistakably that nitrogenous manures, and more especially sulphate of ammonia, produce a great increase in mixed "*seeds*," but that the increase is obtained at the expense of the clover. On the other hand, we have here a clear proof of the remarkable effect of phosphatic manures on a mixed herbage, in which they greatly promote the development of clovers and leguminous plants, and keep in check the cereals. It will be noticed that whereas on Plot 2 the rye-grass grew very gross and kept the clover in check, on Plot 3, manured with mineral superphosphate, the clover-crop is described as very clean, with a very small mixture of rye-grass, which, moreover, appeared weakly, and only made some progress late in the season.

Purely phosphatic manures, even when applied to the land in the most available form, it thus appears do not produce an increase in the bulk or weight of seeds, but, by promoting specially the growth of clover, they improve the quality of the crop. This agrees well with Mr. Lawes's experience as regards the special effects of different manuring agents on the mixed herbage in permanent pastures, and also with the general agricultural experience of many Cheshire farmers, who find that, after the application of bones or of superphosphate to worn-out pastures, clover—especially white—will spring up without being sown afresh, though scarcely any was visible for years past.

In the next place, I have to record another series of experiments which were tried in 1864, at Burcott Lodge, by my friend Mr. Robert Vallentine.

The experimental field was rather light, and had not been in clover for many years—at least, not for twelve or sixteen years. The crop (red clover) was quite heavy and uniform throughout the field, and no difficulty was experienced in selecting for experiments a part evenly covered with clover. This part was divided in 6 equal plots of 1-20th acre each, which received on the 27th of April the top-dressings stated in the following Table; the

clover cut down in the middle of June, and made into hay. The produce from the several plots was ready to be stacked on the 20th of June, and the weighings of the hay were made that evening, within the space of three hours.

TABLE showing the Weight of Clover-hay of each Experimental Plot of  $\frac{1}{20}$  of an Acre, and Hay calculated per Acre, in Clover Experiments made at Burcott Lodge, Leighton-Buzzard, in 1864.

Plots.	Top-dressings.	Rate	Hay per Plot	Clover-hay		
		per Acre.	of $\frac{1}{20}$ of an Acre.	per Acre.		
		cwts.	lbs.	Tons.	cwts.	lbs.
1	Nitrate of Soda .. .. .	3	304	2	14	32
2	{ Nitrate of Soda .. .. . Superphosphate .. .. .	{ $1\frac{1}{2}$ 4 }	306	2	24	72
3	Common Salt .. .. .	6	270	2	8	24
4	Common Salt .. .. .	3	280	2	10	0
5	Unmanured .. .. .	..	286	2	11	8
6	Unmanured .. .. .	..	284	2	10	80

It will be seen that the weights of clover-hay on the two plots left unmanured were almost exactly the same, and that the crop, considering the kind of land on which it was grown, and the dry season, was very good indeed.

It will also be noticed that the smaller dose of salt somewhat diminished the weight of clover-hay, and that the larger dose had a still more adverse effect. We may learn, if I am not mistaken, from the diminution of the clover-hay by salt, that it is not desirable in average seasons to delay the application to the land of even very soluble saline matters until the end of April. Should the end of April or early part of May be wet, the dilute salt-solution distributed through a large mass of soil is likely to be beneficial, but otherwise it will do more harm than good to the crops to which it is applied. On the whole, therefore, my experience leads me to think it advisable to apply saline top-dressings earlier in spring than they are generally made. Probably the beginning of March may be the best time in the majority of seasons.

Neither nitrate of soda nor the mixture of nitrate of soda with superphosphate had any decided effect on the produce in clover-hay.

The large crop on the unmanured plots, moreover, shows plainly that the particular field on which the experiments were tried was in a high agricultural condition, in which it did not require manure of any kind. It was, therefore, not well adapted for experimental purposes, at least in the season in which the

experiments were tried. Had more rain fallen in the spring months of 1864, it is quite possible that several of the top-dressings, more especially the mixture applied to Plot 2, would have shown a much better result.

We may learn from the preceding experiments how exceptional may be the results obtained by an occasional experiment, however carefully conducted, and consequently the great utility of systematic field experiments continued on the same land year after year. Indeed, I do not conceive that great progress will be made in the rational and economical application of manures until separate institutions, like that called into existence by Mr. Lawes, are established in various parts of this country. Few men interested in agricultural pursuits are aware of the immense amount of work and its practical value which has proceeded from Rothamsted, and how greatly landed proprietors and tenant farmers are indebted to Mr. Lawes for setting aside entirely for scientific purposes a number of acres, on which for the last twenty-five years most important agricultural experiments have been carried on from year to year. I have visited most of the agricultural laboratories recently established on the continent in connection with experimental fields or experimental stations (*Versuchs Stationen*, as they are called), and know that much laborious and useful work is carried on in these establishments. Without disparagement to any of them, however, I may be allowed to say that the Rothamsted experimental fields and laboratories are models to all similar establishments, and that England may well be proud of Rothamsted and the valuable chemico-agricultural work that has already been carried out there by Mr. Lawes and his able coadjutor Dr. Gilbert.

#### *Clover Experiments in 1865.*

Mr. Jacob Wilson, of Woodhorn Manor, kindly undertook to carry on the clover experiments on which I have reported for another season. The same top-dressings which were used in 1864 were applied again in 1865, on May 8th, to 10 plots of clover-seeds in precisely the same quantities as before.

In 1864 the crop was reaped on the 6th of July, when it did not appear to make any further progress; in 1865 it was left 12 days longer on the ground, as it was all the while in a growing condition. The results obtained are incorporated in the following Table:—

TABLE showing the Manures employed and Green Produce from 10 Plots of Clover-seeds, Second Year's growth, at Woodhorn Manor, Morpeth, and Produce calculated per Acre.

Plots.	Manures.	Quantity per $\frac{1}{20}$ of an Acre.	Produce per $\frac{1}{20}$ of an Acre.	Produce per Acre.
			lbs.	Tons. cwts. lbs.
1	Nitrate of Soda .. .. .	22 $\frac{1}{2}$ lbs.	899 $\frac{1}{4}$	8 0 65
2	Sulphate of Ammonia .. ..	22 $\frac{1}{2}$ „	1039 $\frac{1}{2}$	9 5 70
3	Mineral Superphosphate (dis- solved Bone-ash) .. .. }	22 $\frac{1}{2}$ „	924	8 5 0
4	Common Salt .. .. .	22 $\frac{1}{2}$ „	726	6 9 72
5	Left unmanured .. .. .	..	635 $\frac{1}{4}$	5 13 49
6	Muriate of Potash .. .. .	22 $\frac{1}{2}$ „	767 $\frac{1}{4}$	6 17 1
7	Sulphate of Potash .. .. .	22 $\frac{1}{2}$ „	709 $\frac{1}{2}$	6 6 78
8	Sulphate of Lime .. .. .	1 cwt.	577 $\frac{1}{2}$	5 3 14
9	{ Mineral Superphosphate .. and Nitrate of Soda .. .. .	{ 22 $\frac{1}{2}$ lbs. 22 $\frac{1}{2}$ „ }	1056	9 8 64
10	{ Mineral Superphosphate .. and Muriate of potash .. .. .	{ 22 $\frac{1}{2}$ „ 22 $\frac{1}{2}$ „ }	668 $\frac{1}{4}$	5 19 37

On looking over the preceding results, the small produce on Plot 10 must create considerable surprise. In the preceding year the heaviest crop was reaped from this plot, and the result in 1865 is the more remarkable. Mineral superphosphate alone applied to Plot 3 gave nearly 2 tons and 6 cwts. more per acre than the same quantity of superphosphate and muriate of potash added to it. There is, however, generally a good reason to be found for such striking anomalies as this.

In the case before us the anomalous result obtained on Plot 10 is entirely attributed by Mr. Wilson to a bed of coltsfoot, which sprung up at one end of the plot. The effect of the top-dressing was very marked at the other end, where the crop to all appearances was very heavy. It is much to be regretted that the failure occurred just on Plot 10, for there is strong presumptive evidence that muriate of potash is most usefully applied to clover in conjunction with superphosphate. Indeed the experience of the previous year seems to afford a substantial evidence for the correctness of this view.

The effect produced by muriate of potash, it will be seen, was slightly better than that of sulphate of potash. In either case, however, the increase over the unmanured plot is not sufficiently great to repay for the outlay. It will, moreover, be seen that chloride of sodium (common salt) gave nearly as great an increase as muriate of potash, and slightly more clover than sulphate of potash.

Nitrate of soda, and, in a still higher degree, sulphate of ammonia, produced heavy crops, but of the mixed clover and rye-grass the latter predominated, and the grass was coarse, as

it always is when nitrogenous manures are applied to it in considerable quantities.

The most favourable result, it will be noticed, was obtained by the mixture of nitrate of soda and superphosphate on Plot 9.

In comparing the weights of green clover-seeds in 1865 with those obtained in the preceding year, it appears that, excepting the anomalous result on Plot 10, the general experience gained in 1865 accords well with that of the preceding year. The comparison, however, brings out some differences, which appear to me to involve points of practical interest.

In the first place, the unmanured Plot 5, as might have been expected, produced a good deal less seeds in the second than in the first year.

In accordance with the experience of the preceding year, sulphate of lime (gypsum) had no beneficial effect, the actual weighings, indeed, showed a slight diminution in both years on the plots to which it was applied. It is possible that the employment of so large a dose of gypsum as 1 ton per acre may have had some share in depressing the produce; but more likely that the differences in the unmanured plots and Plot 8 (gypsum) are not greater than those which would have been exhibited on two separate unmanured portions of the same field.

At all events the experience with gypsum in both years proves that on the soil of the experimental field it had no beneficial effect. I mention this specially because gypsum is frequently recommended as a manure for clover, and because this is not a solitary instance in which I have failed to get the least indication of its favourable action on clover-seeds.

In the next place I would direct attention to the much better effect which superphosphate produced in the second year than in the first. This I believe is attributable to the greater rainfall in 1865, especially in the early part of summer.

The greater rainfall in 1865 unquestionably explains likewise the differences in the effects produced by common salt and by muriate and sulphate of potash in 1864 and 1865. In the former unusually dry year all three salts actually proved injurious to seeds, whilst in the latter they produced a marked increase, showing plainly the necessity for soluble saline matters becoming much diluted by the rainfall and thoroughly diffused in the soil, before they can exert a beneficial influence on vegetation.

*Clover Experiments made in 1865 at Bourton Grange, Much-Wenlock, by Mr. Charles Selby Bigge.*

Another series of experiments with the same top-dressings as were used by Mr. Wilson, were made on one year's clover-seeds by my friend Mr. Charles Selby Bigge. The soil of the experimental field was a sandy loam, with a fair admixture of clay.



It was well drained and in good state of cultivation. On analysis it furnished the following results:—

*Composition of Experimental Clover-field at Bourton Grange, Wenlock, Shropshire.*

	Soil dried at 212° Fahr.				
	Organic matter and	combined water	..	..	..
Organic matter and	combined water	..	..	..	4.06
Oxides of iron	..	..	..	..	3.02
Alumina	..	..	..	..	6.19
Carbonate of lime	..	..	..	..	1.31
Magnesia	..	..	..	..	1.06
Potash	..	..	..	..	.54
Soda	..	..	..	..	.07
Sulphuric acid	..	..	..	..	.08
Phosphoric acid	..	..	..	..	.07
Insoluble siliceous matter	..	..	..	..	83.60
100.00					

The soil, it will be seen, is poor in phosphoric acid, and contains only a moderate proportion of potash and soda. It is naturally rather a poor soil, and not particularly well adapted for the growth of clover.

The various top-dressings were sown on April 5, 1865, and the plots were mown June 20. Unfortunately, owing to a mistake, the produce was left on the ground three days before weighing, during which time probably more than half the amount of moisture in the green clover-seeds evaporated. However, as the plots were all mown at the same time, and the grass left for the same length before the weighing, the results contained in the subjoined Table are nevertheless reliable and comparable with each other:—

TABLE showing the Manures employed and Produce obtained from Experimental Clover-plots at Bourton Grange, and Produce calculated per Acre.

Plots.	Manures.	Quantity	Produce	Produce per Acre.	
		per $\frac{1}{20}$ of an Acre.	per $\frac{1}{20}$ of an Acre.	Tons.	cwts. lbs.
1	Nitrate of Soda .. ..	22 $\frac{1}{2}$	212	1	17 96
2	Sulphate of Ammonia .. ..	22 $\frac{1}{2}$	227	2	0 40
3	Mineral Superphosphate .. ..	22 $\frac{1}{2}$	132	1	3 64
4	Common Salt .. ..	22 $\frac{1}{2}$	123	1	1 108
5	Left Unmanured .. ..	..	93	0	16 68
6	Muriate of Potash .. ..	22 $\frac{1}{2}$	102	0	18 24
7	Sulphate of Potash .. ..	45	124	1	2 16
8	Sulphate of Lime .. ..	1 cwt.	85	0	14 32
9	Mineral Superphosphate and Nitrate of Soda .. ..	22 $\frac{1}{2}$	235	2	1 108
		22 $\frac{1}{2}$			
10	Mineral Superphosphate and Muriate of Potash .. ..	22 $\frac{1}{2}$	151	1	6 108
		22 $\frac{1}{2}$			

Soon after the application of the top-dressings rain fell, but, it appears, not in sufficient quantity to diffuse properly through the soil some of the very soluble saline top-dressings. In consequence of this a good many of the young seeds on Plots 1, 2, 4, 5, 9, and 10 were killed or checked in their growth. Plot 4 (common salt), Plot 2 (sulphate of ammonia), and Plot 6 (muriate of potash), more particularly showed the marks of injury caused by too concentrated saline solutions.

The plots top-dressed with nitrate of soda and with nitrate of soda and superphosphate soon recovered, as did also, though less rapidly, Plots 2 and 10, and from that time throughout the whole period of growth these 4 plots were visibly much superior to the rest.

In the first stage of growth the seeds on the unmanured plot looked very much more healthy than on the two adjoining plots, 4 and 6, dressed with common salt and muriate of potash respectively.

Common salt turned the young plants yellow, as did also muriate of potash: it took some time before the herbage presented again a healthy appearance. It was noticed particularly that muriate of potash affected injuriously the young clover-seeds; most indeed were killed by it, and the produce on Plot 6 everywhere contained but a small proportion of clover. In applying muriate of potash to the land, it should always be previously mixed with at least three or four times its bulk of fine dry ashes or sand, and never be sown except in rainy weather. Though much more soluble than common salt, muriate of potash may be applied to the land quite early in spring, or even in autumn, with much less risk of loss than common salt. The latter we know readily passes into drainage-water, whilst chloride of potassium, in passing in solution through a soil, leaves its potash behind for the benefit of the crop.

The Bourton Grange experiments agree perfectly in almost every particular with those that were tried with the same top-dressing and in the same year at Woodhorn Manor Farm. The comparison of the two series of experiments will show that in neither had gypsum a beneficial effect, and that in both superphosphate increased materially the quantity of the clover-hay, and, I may add, its quality as well, for it promotes in a striking manner the growth of clover. It will also be seen that, whilst muriate of potash used by itself had a less beneficial effect than common salt, which did not much good, the mixture of superphosphate with muriate of potash had a very good effect both on the quality and quantity of the produce. Again, it will be observed that both at Woodhorn Manor and Bourton Grange the heaviest crops were reaped on the plots manured with a mixture of nitrate of soda and superphosphate. Other points of agree-

ment may be noticed, to which I need not allude. It certainly is satisfactory to have two perfectly independent experiments confirming each other in almost every particular.

*Experiments in Permanent Pasture.*

In connection with these clover-experiments I give, in conclusion, a short account of experiments on permanent pasture which Mr. Bigge tried for me, at Bourton Grange, with the same top-dressings as were employed in the preceding experiments.

The field on which the trials were made was laid down in permanent grass in the spring of 1864. This soil resembles closely in its physical and chemical characters that on which the preceding clover-experiment was tried.

A fair average sample, dried previously at 212°, on analysis gave the following results:—

*Composition of Soil (Permanent Pasture) at Bourton Grange, Wenlock.*

Organic matter and water of combination .. ..	5.55
Oxides of iron .. .. .	2.51
Alumina .. .. .	6.77
Carbonate of lime .. .. .	1.62
Magnesia .. .. .	1.15
Potash .. .. .	.54
Soda .. .. .	.15
Sulphuric acid .. .. .	.07
Phosphoric acid .. .. .	.17
Insoluble siliceous matter .. .. .	81.47

---

100.00

This soil, like that from the clover-field, is poor in lime, and contains only a moderate amount of available potash; it is, however, richer in phosphoric acid, and contains more clay than the clover-soil, and, chemically speaking, is superior to the latter in fertilizing properties.

An even piece of the permanent grass-field was set aside for experiments, and half an acre divided into 10 plots, of 1-20th acre each, which, as regards manure, were treated exactly as the 10 plots in the preceding experiments. The top-dressings were sown on the 7th of April, 1865, and the plots mown June 5th, and weighed two days afterwards.

Before giving the results of the weighings, it may not be uninteresting to the reader to glance at the following notes, which were taken in the field on April 19th and May 3rd, 1865.

*Notes on the Appearance of 10 Experimental Plots of Permanent Grass, April 19th, 1865.*

Plot 1 (nitrate of soda).—Growth very rapid, plant strong and healthy, colour much darker green than rest of the field. Young seeds look burnt, and some killed.

Plot 2 (sulphate of ammonia).—Very little difference between this plot and No. 1. Growth rapid, and very thick and coarse; colour dark green. Young seeds in some places killed.

Plot 3 (superphosphate).—No apparent change.

Plot 4 (common salt).—Plant looks yellow and weak; a good many young seeds apparently killed.

Plot 5 (unmanured plot).—Thin growth; but young seeds looking much healthier than in all the preceding plots.

Plot 6 (muriate of potash).—The young seeds appear to be all killed, and the plant looks generally unhealthy.

Plot 7 (sulphate of potash).—Apparently little or no change.

Plot 8 (sulphate of lime).—Plant looks rather thinner, and not quite so well as in the rest of the field.

Plot 9 (superphosphate and nitrate of soda).—This plot looks well; colour rich, growth very thick.

Plot 10 (superphosphate and muriate of potash).—Thick growth and looking well, with the exception of the young seeds, which are rather yellow.

*May 3rd, 1865.*—The Plots 1, 2, 9, and 10, much superior in appearance to the others. The clover-seeds, which suffered at first more or less in all the plots dressed with saline fertilizers, have now nearly recovered, with the exception of No. 6 (muriate of potash), in which the clover appears to be quite killed.

I may add that, in conformity with previous experience, the plots manured with nitrate of soda and with sulphate of ammonia showed a larger proportion of luxuriantly-growing true grasses than the plots not dressed with nitrogenous manures; and that in Plot 10 the propriety of applying simultaneously soluble phosphate of lime and potash to grass-land was suggested at once by the generally healthy appearance of the herbage, and the luxuriant growth of clovers and of a number of leguminous plants.

The results of the weighings of the produce are given in the subjoined Table (see following page).

It will be seen that here again the mixture of nitrate of soda and superphosphate gave the largest increase, and that nitrate of soda alone produced about the same increase as sulphate of ammonia.

Sulphate of lime, or gypsum, seems to have answered rather better on permanent grasses than on clover-seeds. However, neither that nor superphosphate raised the produce to any considerable extent. The same was the case with common salt, sulphate of potash, and muriate of potash, each applied separately.

The fact that a mixture of superphosphate and muriate of potash often gives a large increase in grass-crops, whereas either

manure applied alone has little effect, is again strikingly brought out in the experiments on permanent grasses.

TABLE showing Manures used and Produce from Plots of  $\frac{1}{25}$  of an Acre each of Permanent Pasture, and Produce calculated per Acre.

Plots.	Manures.	Quantity	Produce	Produce per Acre.		
		per $\frac{1}{25}$ of an Acre.	per $\frac{1}{25}$ of an Acre.	Tons.	cwts.	lbs.
1	Nitrate of Soda .. ..	lbs. $22\frac{1}{7}$	428	3	16	48
2	Sulphate of Ammonia .. ..	$22\frac{1}{2}$	425	3	15	100
3	Mineral Superphosphate ..	$22\frac{1}{2}$	272	2	8	64
4	Common Salt .. ..	$22\frac{1}{2}$	273	2	8	84
5	Unmanured .. ..	..	229	2	0	100
6	Muriate of Potash .. ..	$22\frac{1}{2}$	237	2	2	36
7	Sulphate of Potash .. ..	45	262	2	6	88
8	Sulphate of Lime .. ..	1 cwt.	301	2	13	84
9	{ Mineral Superphosphate .. and Nitrate of Soda .. ..	lbs. $22\frac{1}{2}$ $22\frac{1}{2}$	468	4	3	64
10			390	3	9	72

The whole tenor of the preceding experiments tends to prove the impolicy of applying to clover-seeds exclusively phosphatic manures or simple saline fertilizing agents, such as common salt, salts of potash, nitrate of soda, or sulphate of ammonia. The two last-mentioned salts, it is true, produce a large increase in weight, but in mixed "seeds," this increase is realised at the expense of the clover-plant. On the other hand, the experiments teach us that mixed manures, containing phosphates and alkaline nitrates, or phosphates and salts of potash, promote the growth of clover-seeds on land not particularly well suited to them.

I am inclined to think that a mixture of soluble phosphate, of nitrate of soda, and of muriate of potash, would have given a larger increase than the highest obtained in my experiments. On good clay soils, which generally abound in potash, the artificial supply of potash probably may be omitted altogether in a clover-manure, and nitrate of soda be substituted for potash-salts.

Where good farmyard manure can be obtained at a reasonable price, I have no hesitation in saying I believe it will be found the most efficacious and economical manure both for seeds and permanent pasture. Even at 12s. 6d. or 15s. per ton, I am inclined to think that first-rate dung will be found a cheaper manure than any mixture of artificials, however skilfully prepared it may be. But as in some places it is not possible to

obtain a sufficient amount of ordinary dung at any price, and as it may be wished to give the seeds a dressing, I would suggest for trial the following mixtures, the components of which may be purchased at an outlay of about 2*l.* per acre:—

<i>For clover-seeds on light land:—</i>	Per Acre.	
	£.	s. d.
2 cwt. of superphosphate, costing .. .. .	0	12 0
1½ cwt. of Peruvian guano, costing .. .. .	1	0 0
1 cwt. of muriate of potash, or instead, 2 cwt. of crude German potash-salts, costing .. .. .		8s. to 10s.
Total cost, 2 <i>l.</i> to 2 <i>l.</i> 2s.		

*For seeds on heavy land* I would suggest a trial with—

	£.	s.	d.
2 cwt. of superphosphate, costing .. .. .	0	12	0
2 cwt. of nitrate of soda, costing .. .. .	1	8	0
Total cost, 2 <i>l.</i>			

*For permanent pasture*, I believe the following mixture will be found both efficacious and economical:—

	s.	d.
1 cwt. of superphosphate, costing .. .. .	6	0
2 cwt. of bone-dust, costing .. .. .	14	0
1 cwt. of Peruvian guano, costing .. .. .	13	0
1 cwt. of muriate of potash, or instead of it, 2 cwt. of crude German potash-salts, costing .. .. .		8s. to 10s.
Total cost, 2 <i>l.</i> 1s. to 2 <i>l.</i> 3s.		

If the land is in a poor condition, one-half more, or even double the quantity, of the preceding materials should be used; for on exhausted pastures it appears to be better to give at once a good dose of manure, whether natural or artificial, than to fritter away money in the purchase of small and altogether inadequate supplies.

Before sowing, the artificial manuring mixtures should be diluted with as large a bulk of ashes as possible. With every bushel of the artificials at least 3 bushels of red ashes or burnt clay should be incorporated. If wood-ashes can be obtained at a reasonable price, they will form an excellent addition to a clover-manure. Coal-ashes are but a poor substitute for wood-ashes or burnt clay; however, in the absence of a better material, they may be used for diluting the artificials. In conclusion, I would suggest that the manures be applied to the land not later than the middle of February.

*Laboratory, 11, Salisbury Square, Fleet Street, E.C.,  
July, 1866.*

XXXII.—*Statistics of Live Stock for Consumption in the Metropolis.* By ROBERT HERBERT.

THE heavy losses sustained by disease in most parts of England, the restrictive measures taken by the Government and local authorities to prevent contagion, and the non-arrival of our usual supplies from Holland—in which country the rinderpest has been somewhat prevalent—produced great fluctuations in the value of beasts during the first six months of the present year. Prices fluctuated so rapidly that, at one period, it was difficult to put a market price upon particular breeds. On the whole, however, the Norfolk “season” has passed off well. The general quality of the stock received from the eastern counties has been remarkably good, and they carried a full average quantity of internal fat. As yet the stock from Lincolnshire, Leicestershire, and Northamptonshire has been in good condition; but a falling off is apprehended at the end of the “season,” owing to the large numbers of half-fat beasts disposed of during the early part of the year. Some remarkably fine beasts have arrived in London from France, Austria, and Prussia, and have made first-class prices, 5s. to, in some instances, 5s. 4d. per 8 lbs. The supply from Scotland has not been to say large, but the quality was first-rate. From their superior condition, Scots were at one time worth 6s. 4d. per 8 lbs.

The supplies of sheep have been rather extensive, nevertheless the demand for all breeds has ruled active at extreme rates. With very few exceptions, the various breeds were free from disease.

The demand for lambs was not very active; nevertheless, Downs have produced fully 10s. per 8 lbs. June closed at 6s. 8d. to 8s. per 8 lbs. The supply was not equal to that of the last two years.

Calves, from the small number imported, have realised extravagantly high figures. Of late, however, the quotations have declined considerably, as the imports have been largely on the increase.

Pigs have been in fair and steady demand.

When a free entry is permitted from Holland, we may anticipate a very large influx from that country. The supplies ready for shipment are represented as very large and of improved quality. We are not likely to import either beasts or sheep for *grazing* purposes, past experience having shown that much danger is to be apprehended from contamination. Besides, foreign stock cannot be successfully grazed in any part of the United Kingdom. We therefore anticipate the arrival of an increased quantity of foreign meat fit for general consumption.

The great abundance of grass in our pastures has brought forward native stock with some rapidity; whilst the prospect of a

large growth of turnips, swedes, &c., for winter use is calculated to lighten the feeder's expenses in the purchase of hay and straw.

The total supplies of stock exhibited and disposed of during the first six months were as follows:—

*Total Supplies of Stock exhibited.*

	Beasts.	Cows.	Sheep and Lambs.	Calves.	Pigs.
1861 .. ..	109,812	3005	604,650	6,560	15,952
1862 .. ..	116,735	3054	631,672	8,259	17,407
1863 .. ..	120,045	3005	628,072	10,449	16,435
1864 .. ..	131,694	3014	622,330	9,935	17,679
1865 .. ..	130,977	3086	614,766	12,189	16,028
1866 .. ..	107,816	1220	677,560	6,721	12,953

The falling off in beasts of 23,161 in 1866, as compared with 1865, has been in part compensated by an increase of 62,784 head of sheep.

The eastern counties furnished 31,188 beasts against 54,460 head last year—a deficiency of 23,272 head. We believe, however, that those districts sent far greater supplies of dead meat than usual for Newgate and Leadenhall markets. More than average arrivals of beasts have been reported from Devonshire, Leicestershire, and Northamptonshire; but from other parts of England, as well as from Scotland, the numbers have declined. Ireland, however, has shipped steadily to this country, as will be perceived from the annexed comparison:—

*District Bullock Arrivals.*

	Northern Districts.	Eastern Districts.	Other parts of England.	Scotland.	Ireland.
1860 .. ..	4,000	68,520	21,420	5,033	1477
1864 .. ..	..	62,170	19,980	9,918	2740
1865 .. ..	1,000	54,460	17,570	11,797	2517
1866 .. ..	5,290	31,188	12,680	8,800	3000

The average prices of beef and mutton in the great Metropolitan market, since 1860, have been:—

*Average Prices of Beef and Mutton.*

BEEF.—Per 8 lbs. to sink the Offal.

	1860.	1861.	1862.	1863.	1864.	1865.	1866.
	<i>s. d.</i>	<i>s. d.</i>	<i>s. d.</i>	<i>s. d.</i>	<i>s. d.</i>	<i>s. d.</i>	<i>s. d.</i>
Inferior ..	3 6	3 4	3 0	3 4	3 6	3 8	3 10
Middling ..	4 6	4 4	4 0	4 4	4 6	4 8	4 10
Prime ...	5 6	5 0	4 8	5 0	5 0	5 2	5 10



MUTTON.—Per 8 lbs. to sink the Oflal.

	1860.	1861.	1862.	1863.	1864.	1865.	1866.
Inferior ..	s. d. 3 10	s. d. 3 8	s. d. 3 6	s. d. 3 10	s. d. 3 8	s. d. 4 4	s. d. 4 0
Middling ..	5 2	5 0	4 6	4 8	4 6	4 10	5 4
Prime .. ..	6 2	5 10	5 4	5 6	5 2	5 10	6 0

The above figures show that since 1862 the prices of beef and mutton—the meat most in favour with the middle and upper classes—have gradually hardened, and have now reached a point which must reduce the consumption.

The total number of foreign stock imported into London in the six months was 244,985 head, derived from the undermentioned ports:—

*Imports in the First Six Months.*

From	Beasts.	Sheep.	Lambs.	Calves.	Pigs.
Aalborg .. ..	175	14	..	..	34
Aarhums .. ..	1,133	14	..	..	10
Antwerp .. ..	454	64,968	1751	927	711
Boulogne .. ..	3,791	18,794	..	68	1304
Bremen .. ..	3,144	1,118	2392	67	131
Cádiz .. ..	739	..	..	..	..
Caen .. ..	170	8	..	11	..
Calais .. ..	29	504	3	175	636
Christiana .. ..	6	..	..	..	..
Corunna .. ..	358	..	..	..	..
Delfzyl .. ..	452	29	..	1	..
Dieppe .. ..	1,595	2,413	..	295	6
Dordt .. ..	47	116	..	..	..
Dunkirk .. ..	48	650	43	113	60
Gerstlemunde ..	4,884	6,032	..	5	20
Gothenburg .. ..	2,232	149	..	80	240
Hamburg .. ..	8,721	42,899	..	231	2,958
Harlingen .. ..	5,399	1,112	..	140	246
Havre .. ..	53	..	..	..	..
Oporto .. ..	691	..	..	..	..
Ostend .. ..	219	6,132	42	805	53
Rotterdam .. ..	11,853	30,682	621	4562	4258
Stettin .. ..	..	..	4	..	..
Stockholm .. ..	..	..	..	..	35
Vigo .. ..	150	..	..	..	..
Total .. ..	46,343	175,624	4836	7480	10,702

## Imports at Corresponding Periods.

	Beasts.	Sheep and Lambs.	Calves.	Pigs.
1860 .. ..	17,193	76,415	7,965	2,492
1861 .. ..	22,045	46,674	6,187	4,309
1862 .. ..	11,462	49,332	9,459	883
1863 .. ..	16,701	91,206	11,445	1,229
1864 .. ..	29,460	85,920	10,392	14,212
1865 .. ..	40,921	122,579	9,993	32,582

Newgate and Leadenhall have been heavily supplied with meat, in which a good business has been passing, at irregular quotations. The range in the value of beef has been from 3s. 6d. to 5s. 2d.; mutton, 4s. to 6s.; lamb, 5s. 6d. to 8s. 6d.; veal, 4s. to 6s. 2d.; pork, 4s. to 5s. 8d.; per 8 lbs. by the carcase.

Owing to the immense arrivals of wool from our colonies and the high value of money in the discount market, the wool trade has been in a very depressed state, and the quotations have declined 1½d. to 3d. per lb. The fall would, no doubt, have been much greater had not buyers from France taken about 75,000 bales of Australian at public auction. The great increase in the duties on woollen goods in America is calculated to keep down the value of wool in the United Kingdom, more especially as our imports from various quarters are increasing every year. The supply of Australian wool now in warehouse for the August sales is very little short of 100,000 bales. Annexed are the current prices of English wool in London:—

	Per Pack of 240 lbs.	
	£. s.	£. s.
Fleeces:—		
Southdown hoggetts .. ..	16 10	to 17 10
Half-bred hoggetts .. ..	18 0	to 19 0
Kent fleeces .. ..	17 0	to 19 0
Southdown ewes and wethers .. ..	16 0	to 17 0
Leicester ditto .. ..	17 0	to 19 0
Sorts:—		
Clothing and picklock .. ..	19 10	to 20 10
Prime and picklock .. ..	18 0	to 19 0
Choice .. ..	17 0	to 17 10
Super .. ..	16 0	to 16 10
Combing:—		
Wether matching .. ..	20 0	to 21 0
Picklock .. ..	17 10	to 18 10
Common .. ..	15 10	to 16 0
Hop matching .. ..	21 0	to 18 10
Picklock matching .. ..	17 10	to 18 10
Super ditto .. ..	15 10	to 16 0

*Imports of Wool in Five Months.*

	1864.	1865.	1866.
	lbs.	lbs.	lbs.
Colonial .. .. .	38,697,550	47,929,777	55,344,235
Foreign .. .. .	12,880,006	13,746,640	13,369,797
Total .. .. .	51,577,556	61,676,417	70,714,032

*Exports of Wool in Five Months.*

	1864.	1865.	1866.
	lbs.	lbs.	lbs.
English .. .. .	2,812,637	2,848,031	2,626,371
Colonial .. .. .	12,356,099	21,283,840	17,440,969
Foreign .. .. .	3,012,000	4,474,926	2,121,696
Total .. .. .	18,180,736	28,606,797	22,189,036

4, *Argyle Square, St. Pancras.*

## ABSTRACT REPORT OF AGRICULTURAL DISCUSSIONS.



*Meeting of Weekly Council, Wednesday, March 21st, 1866. Mr. W. WELLS, in the Chair.*

### THE PRESENT STATE OF THE CATTLE PLAGUE AND THE PRACTICAL WORKING OF THE "CATTLE DISEASES PREVENTION ACT, 1866."

Earl CATHCART said: There is a great difference between a call to duty and a mere volunteer performance. In the present instance, I have been asked to treat upon this matter by the Journal Committee, and I gave my consent because I considered that they were the best judges of my qualifications for the task, and I was glad of the opportunity to show my appreciation of the Society, and my regard for many of its members. For these reasons, then, I undertook the duty. The first thing I found, however, was a lion in my path, and that lion was the Charter of the Society, which directs that no politics should be talked here. Well, as I have no strong political predilections, and there are no party interests involved in the question, the lion, at all events, need not be dreaded by me.

Of course, I must ask your indulgence at the outset, because the ground is so foiled and crossed that it is difficult to hit the true scent, and still more difficult, when found, to run that scent to an end. There are some people who have said in their haste that this is a class question; but I contend that it is not so in any respect whatever; because, first of all, our great object is not of political or party character; it is simply a regard for the welfare of the country, and we all know that the welfare of the country depends upon the sum of the prosperity of every class in the country, and our mission is to soften down hard lines. Now, this is a question of rents, trades depending upon rents, and employment depending upon trade; and there is the action and re-action always going on, which make one class dependent upon the prosperity of another. Again, we must bear in mind that the English are a carnivorous people. Cæsar himself, when he spoke of the British, said, "*Lacte et carne vivant*" (On flesh and milk they live); and that is about true to the present day. But we must remember that millions in this country live from hand to mouth, and that the immediate effect of home slaughter is to deprive the poor in towns of the offal which they largely consume. There are numbers of people who never taste flesh meat at all, and not uncommonly a Sunday dinner is a pennyworth of sheep's brains.

Another important question which arises here is that of the supply of milk. Now, the supply of milk has always been short in this country (and that supply is materially shortened at the present moment), the English labourer having upon an average only one-fourth

of what his fellow-labourer gets in Scotland and in Ireland. Again, we have to consider the enormous infantine death-rate in this country, the dearth of milk preventing its being used in the nourishment of children, and causing the substitution for it of a nasty sugar-sop. That supplemented by the demon Opium, which is but too largely used, the natural result, as you read in the register of deaths, is physical debility from the birth. And you will observe in the streets, in hospitals, in gaols, in lunatic asylums, persons with enlarged bones and swollen glands, all suggesting the effects of deficient nutrition.

Further, we have sent cattle diseases to America and Australia, and let us not fail to turn an anxious glance towards Ireland, that poor, torn, distracted sister-country. These and a hundred other considerations dispose us to concur with the writer in 1747 who said, in regard to the cattle-plague question of that day, "Whatever concerns the good of mankind ought to be the object of every man's care and protection." The plague nearly concerns us all, and especially the indigent.

There are two or three further introductory considerations before we come to the two main questions set apart for discussion this day. The first of these is that we in this country are a law-loving people, and it cannot be right for public companies, or for any in high position, to say that they will evade the law. Nothing has more struck me during the progress of this cattle plague in the midst of an infected district than the great obedience which the poor have paid to the necessarily most severe and restrictive orders. There are now, as there were throughout the last visitation, and there will be throughout this, those who continually cry, "Peace, peace!" when there is no peace. There is also great danger from the single-thread-of-inquiry people. I will explain what I mean in this way. Those who are accustomed to study human nature in courts of law are aware how numerous the people are who seize a single thread of an inquiry, and depend upon that single thread until it snaps. Whereas, if we desire to take a strong pull at any question, we grasp all the threads, and twist them together into a very cable of proof.

The first of the two questions appointed for to-day's discussion is the present aspect of the cattle plague. A little cloud rose out of the sea, small like a man's hand, but the signs of the times were not read. Nevertheless, there was the still small warning voice of the veterinary surgeons, who, as Mr. Barron observes in his report on the cattle plague in Belgium presented to the English Parliament, were consistent from the first. Authority waited for public opinion, and public opinion waited for authority, and hence our present position. Then, at the outset, we stumbled over the want of agricultural statistics—that is, the national stock-taking, or, rather, the most important part of the national stock-taking.

It is a singular fact that has been proved, that whilst there is an objection to agricultural statistics amongst the farmers of England, there is none whatever amongst the farmers of Scotland. What makes the difference between the two countries, separated only by the Tweed? I can suggest no other consideration than this, that at one time tithes

in England were collected in kind, whereas in Scotland there has always been a rent-charge: that is the only distinction which I can draw between the two. But such is the feeling at this moment, that if the Government would strike whilst the iron is hot—if they would call in the assistance of the Board of Trade and Mr. Graham, I believe they could easily contrive a bill upon the subject that would be heartily welcomed by the whole agricultural community.

There are three authorities whom I have consulted as to the amount of horned stock in this country. There is, first, Mr. Maclean at one extreme—the greater; there is next Mr. Morton—justly a great authority—as the least extreme; and then there is M. Lavergne as the mean. I shall take M. Lavergne's calculation as to the horned cattle of Great Britain, which amounts to about 6,000,000 in round numbers. It appears from the Government returns that by means of the plague we have got through (lost) 210,000 head. But from my own personal observation I know that the Government returns do not adequately represent the actual losses. There are under-statements. There are panic slaughters which are not returned. There are also great losses for breeding purposes. Quantities of unripe meat are brought into the market, as I have seen myself; and taking all these things together, I say that it is not an over-estimate to double the 210,000, and so put down 420,000 as the total losses we have already sustained. In other words, something like one-fiftieth of the whole of the stock in the country. You will observe that I am speaking of Great Britain, not England alone. I do not think that it is over the mark; yet, in cases of defence, it is always better to "weigh the enemy mightier than he seems."

"How great a matter a little fire kindleth!" How much of the fruit of the labour since 1775 of the Bakewells, the Collinses, the Booths, and Townleys! This loss would be bad enough even if the incidence were equal, but the blow has fallen with a crushing weight upon certain districts. Cheshire, for example, most heavily punished by the great plague in the last century, is said now to have lost from one-half to two-thirds of its horned stock. Next comes the question, and this is the all-important question, Where is the disease to end? If the sapling produces such bitter fruit, what may we expect from the tree? Then, as to the probable continuance of the plague, there are some twenty-two thousand places where the plague has been, and those plague-spots are dotted pretty nearly all over the fair face of Britain. Infected hay conveyed infection after four months' exposure to air. That fact I take from the German report. Dung laid out in the autumn, and frozen in the winter, conveyed infection in the spring. Clothes or sacks laid upon cattle also conveyed infection. There have been numerous bad and insufficient burials, with the probability of the bones being dug up or exhumed.

All that Bolingbroke, or Arnold, or Kingsley could say on the advantage of the study of history to men of action, may be summed up in a single phrase, "Dead men open living men's eyes." Let us now turn for a brief space to that long-neglected voice from the grave—the 'Gentleman's Magazine,' from 1745 to 1757. In February,

1746, the second year of the great plague, Dr. Broklesby wrote: "One beast goes—all sooner or later go. (The plague) will probably abate in a short time. . . . As an exotic plant, it will flourish, dwindle, and die." On the 12th of March an Order in Council says: "If not timely prevented, it (the plague) will end in the destruction of all cattle." In 1747, the third year of the great plague, the Council say the same thing, and complain of the apathy of the local authorities, and again it is said that the disease has lived through all the seasons. In 1748, the fourth year of the great plague, the disease had broken out afresh in several places—that is to say, it had returned to several places. In 1749, the fifth year of the great plague, it is "all over England." In December of that year the Council say: "It rages with a malignity and violence little short of the first outbreak." In 1750, the sixth year of the great plague, in the month of November, it is recorded that the justices have great difficulty in enforcing the orders. They have also great difficulty from gentlemen who hope all things, who fear all things, and who believe all things. How curious is the tendency of history to repeat itself! "Grass is rotting on the ground for want of mouths to eat it. No one will buy hay: there are no rents; stalls are fouled," and then comes this observation, "'Tis a great pity they had not killed each beast." In 1751, the seventh year of the great plague, the disease showed itself in Yorkshire, Westmoreland, Lancashire, Wilts, Monmouthshire, Gloucestershire, Dorset, Bristol, and again in London, as well as in other places. In 1752, the eighth year of the great plague, the cattle are being shot by order of Quarter Sessions, and paid for out of the county stock (or rate); and so on to the very end. And at the very end is this curious and suggestive record: "A never-failing remedy has been discovered by E. Venables Vernon, Esq."

We have also further important evidence in Mr. Barron's most valuable and suggestive report on the cattle plague in Holland and Belgium, to which I have already alluded. From that we learn that the disease in Holland was imported from England in the month of July, that it came from the Metropolitan Market, that they left the matter too much to the local authorities, that they sent tainted cattle to market, and that the disease spread far and wide. Holland thus became completely overrun, whilst the population was impatient of restrictions, and even resisted them by force. Tainted meat, or meat repulsive to the eye, was openly sold. The country was in a deplorable condition; the disease is not likely to be rooted out for years to come, and the land has gone down to one-half its value—that is, half its rental value, I presume.

Contrast with this what has been done in the neighbouring country of Belgium. The Belgians at once closed their frontier, and stamped out the disease with signal success. They said the only way is to kill the disease in the germ. They took an inventory of stock—a thing which we ought to have done. They had recourse to the system of home slaughter. All imports of ruminants were forbidden. The thing is stifled in the germ. The Minister stimulates his subordinates. He says: "In such a calamity as this every one must do his

duty, and do it with devotion; and, above all, we depend upon the zeal of the local authorities, and their sense of the grave responsibility which weighs upon them." Then Mr. Barron says that they had fresh outbreaks from markets in spite of all their inspections, but they were stamped out; and in this work the authorities had active and zealous agents in their veterinary corps. Then the disease broke out among sheep, of which they lost 112. But the courage of the Minister saved the country. Professors Gangee and Simonds, Mr. Barron says, were derided at first; but the teaching of events is irresistible. As far as our own experience is concerned, we must remember that it is as narrow as history is boundless. The experience of nations and of ages has recorded facts for our guidance; and the knowledge of the future depends upon our knowledge of the past. Take all that has been said on this subject together, and in connection with the present state of Britain, and say, is there any early prospect of a cessation of this grievous visitation?

We now come to the subject of sheep, which there is a great and natural desire to purchase just now. Disinfecting the fleece will not disinfect the live sheep. Professor Seifman's experience in the centre of Europe is, that in contact sheep do not invariably take the disease; but that they are most clearly liable to it, and that 20 per cent. usually recover. It is important to observe that a writer in 1747 says that the disease is propagated in the wool of sheep. I believe there is now a decided opinion, arrived at tardily, that sheep are liable to infection, and that there have been cases all over England and Scotland. It is curious to observe, however, that the two great authorities in Edinburgh—the Cattle Plague Committee and the Farmers' Club—are divided on the subject; and in the House of Commons an opinion was expressed in favour of it one night, and an opinion against it on another night.

Dr. CRISP: What is the medical opinion?

Amongst medical men, however, there is, I believe, no difference of opinion, and Professor Simonds has assured me that he has no doubt whatever that sheep are liable to the plague. This is a very important matter indeed, because the transit of sheep must immediately be considered, and the present is the lambing season, and changes of tenancy are going on, when farms have to be re-stocked.

#### THE PRACTICAL WORKING OF THE CATTLE DISEASES ACT.

That is the second question in to-day's discussion. The proverb welcomes it—"Better late than never." It may be convenient, perhaps, to take the various points suggested by the Act in their natural order, and afterwards consider the effects of the Act as shown by the Government returns; premising, however, these considerations. The Act must be supplemented by further imperial and local measures. At the same time it must be borne in mind that the cord must not be stretched too tightly: stretch it too tightly and it will break. And here I would say a word or two respecting Mr. Hunt and his bill. That measure is not now before Parliament, so that it is not a lion in my path; but I may be allowed to express my regret that



the offspring was not as fortunate as its parent was energetic. We must further bear in mind that, henceforth, there will be almost daily and hourly necessities for interference of one kind and another by legislation and other means. To come to the Act, however; the first point is that which relates to the local authority. All through the great plague of 1747-57 there were complaints of apathy and laxity. The next subject is that of joint committees: committees were formed during the great plague. In Poland we find, from parliamentary record, that farming gentlemen were associated there with the departmental authorities with very great advantage.

We come now to inspectors. The inspectors have been too much decried here, although they are the hinge upon which the Act turns; they are upheld in Belgium, and ought to be encouraged and educated to their work here. The police too should be utilized. Then with regard to certificates and licences, there appears to be an unwholesome belief in them, and they tend to be about as valuable as American greenbacks. In a great jurisdiction, within a thousand miles of where I live, a circular has been issued upon this subject, which shows that the disease has actually been spread in consequence of the laxity with which licences and certificates have been granted. In 1749 the evidence in the 'Gentleman's Magazine' shows that certificates completely broke down; and in May of the year 1750 it became necessary to impose a fine of 20*l.* upon justices, clergymen, and others who issued wrongful certificates. My own opinion is, and I have the concurrence of some of the most experienced and able justices—that licences ought to be issued in Petty Sessions by two justices: it is the most disagreeable of duties that one can be exposed to in his own house, when friends and neighbours come for certificates; and I believe that the best and most able justices in the country would prefer that these licences and certificates should, if possible, be granted in Petty Sessions.

We come now to consider the next point, which is slaughter; and here again I must be permitted to refer to the evidence contained in the 'Gentleman's Magazine.' In October, 1745, they said that the disease was incurable. Again it was said, "Kill diseased beasts immediately: it is the only means of preservation." In November they say, "Killing out is generally approved of;" and I observe that the same arguments were used then as now about knocking human patients on the head, and there were even better arguments than are now used to show that the disease is not infectious or contagious. The commission for Middlesex say: "If any person refuses to have his sick cows killed and buried, in hopes they may recover or other pretence, they are not to have the allowance." In 1747, the third year of the great plague, experience shows that nothing can contribute so effectually to prevent the spreading of the disease as killing the cattle when the disease first appears upon them, before it begins to be infectious and communicates itself to the rest of the herd—so it is an absolute necessity. In 1750, the sixth year of the great plague, it is observed that cattle were not killed soon enough to be useful, which means, for the killing to be useful. Then Virgil and Columella are quoted upon

the desirableness of killing diseased beasts; and I take it that from Virgil down to Professor Simonds all the great authorities have held pretty much the same view upon that point. In the same year there is a record that in Quarter Sessions in Cheshire it was observed that such as began to kill as soon as the distemper appeared lost very few, and they speak of the wretched, tragic condition of those who had put faith in medicines and letting the disease take its course. In the records of the same Quarter Sessions there are instances of success in slaughtering out, in many counties and places. Then it is said about killing: "Regard the sound: to save one or two you risk many." "If the farmer at Elton had killed his cattle, Cheshire might have been saved 6000 then dead." Next I find this question: "Do you think there is no cure?" The answer is "None. Everything has been tried in vain; some remedies appeared at first to answer, but on further trial they failed. My own cattle I would kill at once rather than endanger the sound, and foul my premises and fodder." To the question what right Government had to order killing? the answer is: "The maxim of law that a man may not do with his own that which will hurt another's." In the year 1752, the eighth year of the great plague, the disease, as appears by orders in Sessions, was in Somersetshire, where twenty cattle were shot by order of the Clerk of the Peace in the month of May. These were appraised and paid for out of the county stock. There were other slaughters and payments of a like nature ordered.

We come now to consider the subject of convalescents. Public opinion at first was alive to slaughtering out, but hardly to the slaughtering of convalescents. The old writers at the time of the great plague say, doctoring leads to the spread of the disease. Lancisi, a great Italian writer upon this subject, says that cures spread the disease. So that it would seem that animals which have "suffered many things from many physicians" generally die in the long run.

#### COMPENSATION.

I come next to the important question of compensation. If there is to be curing of diseased animals, then compensation will break down; because the very object of compensation is that diseased animals should be slaughtered as soon as they are attacked. But if they are to be doctored and are then killed, compensation is clearly paid for nothing. This was well pointed out in the 'Times' of yesterday. I repeat, then, that the object of compensation is that slaughter should take place at once, and that if a system of nursing is adopted compensation must utterly break down. During the great plague compensation was called by its right name, premium; that is a better name than compensation; for the fact is, that it was a bonus on killing for the good of society. One-half the value was then paid, and compensation broke down because the money came from the Treasury, and there was no local interest or power of observation to prevent frauds. Forty shillings was then the value of half a cow. Afterwards they came to the county stock, or rate, and it is presumed that the payments from the county stock having been made with greater local knowledge,

frauds were thereby prevented. This brings me to the next point, namely, checks against fraud. Publicity is, in my judgment, everything, the very soul of justice. Then there should be weekly accounts, and in healthy districts by all means let them have a previous inventory of the cattle; thus there would be no disputes as to value afterwards. I believe that if we had done that in the first instance we should have saved ourselves a great deal of trouble. I have seen a doctrine set forth, that the interest of the ratepayer, because he pays rates, is greater than that of the veterinary inspector. Now, I hold, that in emergencies we should place confidence in responsible persons who are devoted to their duties, and as the inspector is liable to dismissal if he does not properly discharge his duty, that he has a greater pecuniary interest than any ratepayer, because where the ratepayer pays 1*l.* of rates the inspector receives perhaps 50*l.* or 100*l.* of salary. In this country it is true policy to have the best men you can get as inspectors, and to educate them well for the discharge of their duties, for their services will be required for some time at least, and if you want a man to respect himself, and do his duty, you must first show him respect.

#### DISINFECTION.

A very important matter comes next for our consideration, and that is the subject of disinfection. I think we are greatly indebted to the Commission for the exceedingly useful suggestions they have published on this head. We should remember that a very little leaven leaveneth a great mass, and that the disinfection of premises is a difficult matter, requiring some special knowledge. Previous to our meeting to-day I ventured to say something to our friends here about carbolic acid: but I was informed that there was nothing to be said about disinfectants, for there is only one, namely, chloride of lime. I am sure, however, that great good might be done by the use of carbolic, and I would suggest that it should be kept in the different police-stations, as has been done in the North-Riding of Yorkshire, since the smaller occupiers will not get it for themselves.

The country is very much indebted to Mr. Crookes, F.R.S., for his investigations, which are confirmed by the experience of Poland, as to the danger to be apprehended from hides and skins, which should be viewed with as much suspicion as live-stock themselves. This danger from hides and skins weighs heavily upon particular classes, and Mr. Crookes would do good and patriotic service if he would point out how hides and skins may be made safe, and at the same time fit for the processes of tanning.

I pass on now to notice the movement of stock in connection with fairs and markets. In the third year of the great plague the disease spread from the London market, and throughout that period it was always returning and breaking out again in places where it had been before. But no doubt there must be for breeding and market purposes and for the stocking of farms some regulated movement of live-stock. The county-rate is the next point, relative to which all I have to say is, that during the great plague a precedent was established for the

payment of compensation out of what is called the county stock or rate.

#### WEEKLY RETURNS.

Let us now contemplate the attacks as shown by the Government return—in other words, the results of the practical working of the Act, so far as we can gather them from the Government veterinary reports. I find that in the week ending February 17, the disease appeared to have reached its climax. The attacks in that week were in round numbers something like 13,000; in the next week, ending February 24, they had fallen to 10,000; in the following week, ending March 3, there was a further fall to 7,310; and in the week ending March 10, which is the last return I have, they were 6518. But here there is rather a fallacy, because back cases are not recorded; taking the back cases, however, the numbers would be for the four weeks respectively 18,000, 11,000, 9,000, and 7,000.

But I think we should have a more sensitive and satisfactory test perhaps in the number of fresh centres as showing the working of the Act. In the first of the four weeks I have referred to, these were 995; in the second week, 712; in the third week, 602; and in the fourth week, ending the 10th of March, 581. Again, there were killed of diseased animals 864 in the first week; 1,641 in the second week, 4,674 in the third week, and 5,587 in the last week. All the English counties appear to have carried out the law more or less effectually, but undoubtedly there are four Scotch counties that have been altogether slack, as you may gather from the returns. After all the exceptional stringency, there is still perhaps ground for disappointment as to the past, and warning as to the future. Sanguine persons who do not regard the past expected far more; as usual, they did not make due allowance for the various disturbing influences which so clog all human affairs. If it be considered that the means employed were so exceptionally stringent that they can never be had recourse to again, there is ground for disappointment that during the last week the disease should have extended to 581 new centres; in that, I repeat, there is ground for both disappointment and warning. In Poland the German newspapers publish favourable articles in order to influence the markets, and in England too often the wish as to the stoppage of the cattle plague has been the "father of the thought."

We will now turn for a moment to the consideration of the milder type argument. From the evidence contained in the 'Gentleman's Magazine' I gather that the disease was most severe in frost and in winter, and there is nothing whatever to show in the whole of the records of the great plague that the disease was in any degree of a milder type in the twelfth year of the plague than it was in the first. They were obliged to have recourse to slaughter at last as at first, and cures were just as unusual. I proceed now to notice the last point in the Act, namely the movement of stock. When the railways are opened, as undoubtedly they must be opened to a certain extent, great precautions will be necessary. Without due care they may be the means of propagating the infection, and inspection is of

little use or security where the disease is latent. Precautions are now taken with regard to the conveyance of lucifer matches, gunpowder, and other combustibles on railways, and companies must treat cattle pretty much as they do other articles which are liable to conflagration. Something has been said about the Government taking upon itself the cleansing of railway trucks; but the province of Government probably would be not to undertake any such duties, but to see that the railway companies do their own work effectually in that respect.

#### DEAD MEAT MARKETS.

We come now to an important subject—the subject of dead-meat markets. That system undoubtedly might be much extended, and in cool weather there appears to be little difficulty in driving the butcher to the ox. There is also little practical difficulty, as I have seen from observation, in slaughtering on farms, and there is little danger in slaughtering there. There are in England 68,000 butchers and meat salesmen who have no doubt been greatly inconvenienced; and I fear that, for some reason or other, there is very little sympathy between the butchers and the farmers. Now, the state of Newgate Market is most interesting to farmers, and it is equally interesting to the public. The state of that market is, as I can testify from personal observation, having spent a night there, a disgrace to our civilization. Ten million pounds of meat per week now come into that market, that being double the quantity that was sent before the plague. This is interesting to the public. All are interested, from those who eat the dishes made from the gouged ears of lambs which I saw, or the fat from a cow-calf's udder, to the poor man's dinner of cooked bullock's liver. Conceive this place at 4 o'clock in the morning, flaring with gaslights—a great beehive of a place, like a number of Wardour-streets rolled together, jammed up with meat of all kinds instead of furniture; sawdust scattered about in all directions, sides of beef walking in on four legs, that is, carried in by two men. This market is positively jammed with meat and men, and baskets and vans.

The proper idea of a great meat market for the metropolis is that of a wide covered space, with spacious span roofs, the lightest possible pillars, convenient side-walks for pedestrians, and a tramway for the conveyance of the meat. There were at Newgate Market, on the night to which I allude, large quantities of clearly unripe meat, and some meat which looked very nasty and flabby. But the great crying evil of the present system of slaughtering in the country is that the poor are deprived of the offal on which so many live. The offal is often sold at a loss of one-third. Small quantities of it are brought up to London in baskets, and arranged in such a manner as to be absolutely disgusting. When I speak of offal, I allude to hearts, livers, and pluck.

The next question is, whether veal ought not to be given up. And here I am reminded of a saying which is of universal application in all the relations of life, namely, that “where the carcass is, there will the eagles be gathered together”—that is to say, there is a

tendency, in cases of calamity, to make capital out of it. The railway companies are said to charge three times as much for carcasses as for live beasts, although a truck will carry twice as many of the former as of the latter. In favour of the poor, therefore, there should be some provisions for the convenient carriage of offal by means of some kind of travelling larder. On the occasion of my visit to Newgate Market, the meat generally appeared to be in fair condition. Dead meat comes from abroad; and Mr. Barron says that the 112 Belgian sheep suspected of having the plague were sent to England as mutton. Let us hope that due care will be taken, and that we shall not hear of death in the pot. There is a curious record in the 'Gentleman's Magazine,' that during the great plague the experiment of feeding on diseased meat was tried in Flanders, on some condemned soldiers, and that they ate of it with impunity.

SIR WALTER STIRLING: That is the case now in this country, is it not?

DR. CRISP: Yes. I myself have positively eaten plenty of it: and there is not the slightest harm in it.

Earl CATHCART: But perhaps it is a slow poison.

We will now go on to the live-meat market at Islington. That is a magnificent market. You see there Spanish cattle with long horns, and white and black Dutch and French cattle; and Monday last witnessed the unparalleled fact that the market was nearly as full as it was prior to the breaking out of the plague, nearly every one of the animals being a foreigner. It is a strange circumstance, and well worthy of note, that on Monday there were 4160 foreign cattle in the market, or very nearly as many beasts as there were previous to the stoppage of the movement of English stock.

There is one thing which should be observed as affecting agriculturists, and that is the cruelty of sending clipped sheep up to market in March and April. There they were, standing in the cold morning air, shivering dreadfully. It is curious to observe that, within eight years, the foreign imports have risen from three hundred a-week to twelve or thirteen thousand.

We are now brought to what, at a previous meeting, I ventured to say is the great turning-point in all these discussions, that turning-point lying in the word *confidence*. Now, the six millions of cattle, twenty-five millions of sheep, and three millions of pigs in Great Britain, all liable to our imported infectious disease, are surely worth caring for. They are the food of the people. I for one freely admit all the difficulties of legislating and of administering the law in relation to this matter. What I mean by confidence is this: We want imperial authorities to see the danger, and to see us safely through it. We want a compound Hercules for the British angean stable. We don't want any limited liability: we want a responsible Government committee—a board constituted with due regard to a division of labour, with the check and spur of fixed responsibility. It is not enough to have two or three right hon. gentlemen who may chance to gather together. This responsible board or committee—and this is an important point, if you look back to past history—

must be "instant in season and out of season," must "reprove, rebuke, and exhort with all long-suffering." Their orders must be plain and clear. The records in the 'Gentleman's Magazine' show that in 1745 and 1747 there were great complaints relative to the obscurity of the orders that were issued at that period. The people could not understand them, and consequently they were not obeyed. In all these measures we must carry the people with us. We want a sensitive, receptive, central government, and an active local administration, working together rapidly, and hand-in-hand. The duty of the central authority should be interference—partly dictatorial, partly suggestive—the object being to benefit us by their superior information and their command of skill and talent, to complement local exertion, to give confidence and protection against undue competition, to intervene so as to give effect to the general wishes—in short, to carry out the maxim of law laid down by Lord Coke: "Persons"—I would say counties and boroughs—"may not do with their own that which may injure another's"—that is, you must use your own so as not to hurt your neighbour. I would wish the central Government to bear in mind that energy and self-dependence may be impaired by the absence of help; that much must be left to local knowledge and local interest, and to direct interest in the result; that a little competition and emulation may be better than the strictest conformity; and that on the other hand, now, as during the great plague, Quarter-Sessional Orders, when they are very diverse, create distress, and local authorities cannot prevent a laxity in one county which is dangerous to others. Now on this point we have the example of Aberdeenshire and Kincardineshire. In Aberdeenshire they kill out, and have killed out, at a voluntary expense; in Kincardineshire they are nursing. The local authority cannot impose quarantine on imports, and other general and necessary restrictions. The disease must be fought in every district; and there is no safety while it smoulders or lurks in any corner of the island. In fact, one county acting independently is just like Mrs. Partington sweeping out the Atlantic Ocean with her mop.

I should like to say a word or two on the subject of sympathy, and speak "a word in season to them that are weary." I can say for myself, as a landowner, acting as a justice and living in the country, that it is absolutely depressing to one's feelings to live in the midst of such misery. I myself have not suffered much; but on coming out of church on Sunday afternoon, I have heard guns going off in various directions, every shot representing the death of a miserable cow. Well, then, as to the farmers, this visitation will entirely break down many of them. They were words of true pathos which a farmer addressed to me—and he was a fine manly fellow, who had done many a kindly action—"This will take the kick out of my gallop for many a long year." Then as to the labourers—I mean the flower of the agricultural labourers, men who have saved a little money, and who, having got a little property themselves, know how to appreciate their masters' losses. These are the people who are suffering most; and they are well entitled to our sympathy. The labourers to whom I

allude were the owners of cows. They have lost, perhaps in a day, the fruit of the savings of years : they have lost that which was perhaps essential to the future well-being of the children around them : they have sustained a loss from which they may never recover. The most pathetic ballad in the English or in any other language—such at least it is said to be, on good authority—whether in ancient or in modern times, is the ballad written by Lady Ann Lindsay, “Auld Robin Gray.” When she had described all the miseries that she thought could be inflicted on poor people, she turned round to her young sister, and asked what additional aggravation there could be : upon which the sister called out to “steal the cow.” Here then we have, as we often have, a reality far more pathetic than any tale of fiction.

Gentlemen, I am very much obliged to you for having, as Shakspeare says, “lent me your ears,” for a long time ; but, before concluding, I have a word or two to say on the subject of divinity. It is in evidence that on one morning early in August last one or two hundred cattle that were known to be diseased were sent out of the Metropolitan Market simply because there was no one who had the moral courage or the authority to prevent such a state of things. Then I say that the strong man Samson, when he caught three hundred foxes, tied firebrands to their tails, and sent them through the corn-fields, did not adopt a more certain way than this to spread disaster. And I believe it to be a manly, an English, and a Christian sentiment to say that, when we had each of us the consciousness of having done our very best, or at all events having tried to do our very best, to stop the plague, then was the time when we might most properly approach the heavenly throne, to ask the aid of Him who is the great All-giver.

Sir E. KERRISON, M.P., said : What he had been fortunate enough to hear of the noble lord's remarks was exceedingly interesting to him, as it must indeed have been to every one present. It must be satisfactory to those who had throughout argued in favour of isolation, and of the traffic being in a great degree suspended, to see what the result of those measures had been between the 17th of February and the present moment. At the former period 13,000 cattle were attacked in a week, and with back cases the number was 18,000 ; whereas, by the last accounts, they found that 7000 instead of 13,000 was the number of animals that fell victims to the plague within the week. Although there were 508 new centres of infection, it should be remembered that there were 900 in February. At the present time, therefore, there was a very great diminution in the number of fresh centres. The question would soon be settled when the suspension of railway traffic should cease. The day appointed was, he believed, the 25th of March ; but he understood that the period would be prolonged until fresh Orders in Council were sent out. He hoped the experience of those who assisted in suspending the traffic would induce the authorities to continue the suspension for some time longer. It was of immense importance—if the traffic were stayed, and if the Act which was now being taken in hand by the Privy Council to put a stop to fairs and markets likewise came into effect—it was of immense importance that



the licences under which the movement of cattle took place should be simplified. He agreed that licences should generally be granted not privately, but publicly by two justices, or by those who now formed the local committees in counties. Although he had not very great faith in certificates, yet he would have certificates granted only through the agency either of the officers or of the committees themselves sitting in the local district; and, in all cases in which it was necessary to remove cattle, he would have three days' notice given of a licence having been granted. On the other hand, while he would make it somewhat more difficult to obtain the licences, and have a uniform plan throughout the country, he should like to see the system simplified, to meet the actual state of matters. Supposing railway transit to be for a certain time discontinued, and fairs and markets shut up for a lengthened period, instead of each divisional licence extending over the division and no further, (so that a person moving cattle twenty miles might be obliged to have no less than three different justices' certificates,) the Privy Council might every week send to the Quarter Sessions, as the local central authority, a list of all the places in their county which have been for one month free from infection. The justices might then issue licences to those districts which were free from infection, enabling farmers and others to move their stock through the several districts which were declared by the Privy Council not to be infected, and that without the necessity of referring to another justice for a fresh licence. Although this would add to the difficulties of the farmer in his present position, some such stringent order should be issued; for it was perfectly well known to those who had watched the effects of the cattle plague, that after the disease had disappeared from a district it had re-appeared from one market or fair, owing to the congregation of animals at the spot.

Allusion had been made to the supply of the Metropolitan Market almost entirely by foreign stock. No doubt that was vastly for the benefit of the consumer; but it was no less a further burden as it were upon the agricultural interest, who were unable to transmit their cattle because they were not near a seaport, whilst the foreigner could come in and compete with them. But as the agricultural interest had borne their burden with a patience and endurance beyond all praise, so he felt satisfied that they would support even further restrictive measures, if likely to stay the cattle plague. With regard to the question of the Dead-meat Market, he trusted that the graphic account which Lord Cathcart had given them of the state of things in Newgate Market would have the effect of stirring up those who ought long ago to have provided a proper place. He trusted that not two or three gentlemen, but some one department of the Government would take up this matter, and that such orders would be issued as would apply to all England—that they would be enabled to go to one department of the Government and receive from them such orders as might fairly guide them.

Sir W. STIRLING wished to join in thanking Lord Cathcart for his very useful and interesting remarks. He was inclined to ask the question how it was that so much apathy existed on the subject in the Royal Agricultural Society—a society to which the whole world was

looking for information and advice. In alluding to the subsidence or diminution of the plague in Holland, Belgium, and France, the hon. baronet who had just sat down observed that he believed it was through the exercise of despotic authority in these countries, and especially in France, that the authorities had been enabled to grapple with this gigantic evil, and to deal with it more effectually than had been done in this country. No doubt difficulties of an unparalleled nature had presented themselves, and allowance must therefore be made for the authorities; but the conclusion to which he had come was, that there ought to be an Agricultural Board in the Government, to which the country might look. In the meantime, what was there to prevent the Royal Agricultural Society of England from occupying that position? They had large means at their disposal, and what availed those means if at such a crisis as this they were not employed in collecting all the information that could be obtained on the matter?

The SECRETARY (Mr. Hall Dare) begged to state that the Council of the Society had for months been in communication with the Government. In December last, a deputation from them waited upon the Government, and laid before them a set of resolutions, to which they had agreed; and again in February a deputation visited Downing-street with another set of resolutions. These resolutions had had the effect of inducing the Government to alter their Bill, to meet the views of the Council of the Royal Agricultural Society.

Mr. HUTTON, of Gainsborough, said: As he followed Lord Cathcart through his interesting lecture, it struck him as a melancholy reflection that, with all the labour, research, and industry which his lordship had bestowed upon the question, he was able to give them no kind of hope of being placed in a better position. To him, who lived in a district in which the plague was raging, in his own herd, and in those of his friends and neighbours and tenants, this appeared a melancholy state of things. He did not wonder that it had had a depressing influence upon people living in the country. As to the stamping-out of the plague, he believed that to be altogether out of the question; it had broken out in so many places notwithstanding all that had been done. The justices had been most active and energetic in carrying out the law, the farmers themselves had given every possible assistance, and yet the disease had increased in his neighbourhood in a fearful manner. He confessed that he could not see what was to be the end of it. He hoped that some few might be cured, and probably some few would be cured, but it was certain that no specific had yet been discovered. In his neighbourhood, and indeed in Lincolnshire generally, the large farmers, of whom there were a great number, had in many cases suffered infinitely more than the cottagers. He knew one case in which every head of cattle belonging to a farmer was swept away by the disease, whilst the cows of the cottagers—and several of them kept cows—had almost entirely escaped. These cottagers' cows had been running about in the lanes and fields, while the farmer's cows had been kept well fed and well housed. He was, therefore, inclined to think that it was best to separate beasts, turn them into the fields, and expose them to the weather rather than keep

them in sheds. He was sorry to state that even the sheep in his neighbourhood had been unquestionably attacked within the last fortnight.

With regard to the inspectors, there was a very great difference between them. The difficulty was to get a good inspector. He knew a case in which an inspector had done infinite harm—a case in which there had been collusion, and beasts had been sold and sent to market which ought to have been shot. He was afraid that in some cases bribes and improper practices had been resorted to. But they could not help themselves. They did not know where to get good inspectors. In his neighbourhood, indeed, they were fortunate in that respect, for they had a very good one. Having a valuable herd of shorthorns, he had taken the greatest possible care in using disinfectants, and had done all he could to keep people from going to see his animals; yet, notwithstanding all the care he could exercise, his herd had got the pest; whilst he knew cases in which farmers who had been entirely careless about the treatment of their beasts had never been visited with the scourge at all.

Dr. CRISP complained that the Act had not been properly carried out; and said he believed that for every hour, nay, every minute, a diseased animal was permitted to live, another animal was sacrificed. Unless infinitely more stringent measures than those now in operation were adopted, they would never get rid of the disease. As to the inspectors, there were indeed 900 of them, but of these only 250 were members of the Veterinary College. The cause of this was that in this country the Veterinary College was a mere club, maintained by private members, and that there was no national institution of that kind. There ought to be an Agricultural Board and an Agricultural University. If matters had been managed in a different way when the plague first broke out, they would have been able to meet it, and the agricultural interest would not be in its present wretched condition.

The CHAIRMAN said he should like to put a question to Dr. Voelcker before the meeting separated. In his part of the world (Northamptonshire), salt had been resorted to as a means of preserving hides. He should like to know whether it acted as a disinfectant.

Dr. VOELCKER was inclined to think that quick-lime would be much more efficient.

The CHAIRMAN: But that destroys the hides.

Dr. VOELCKER thought it was a question whether the brine was sufficiently strong to destroy the plague-poison. That was the great difficulty which he found, not only with respect to salt, but also with regard to carbolic acid; and he was anxious to recommend great caution in the use of both. There was no question that *strong* salt brine was capable of destroying certain organized matters, whilst a dilute solution would preserve them. He had himself great fears that the use of carbolic acid might actually tend to spread the disease, if it were employed in a diluted condition. No doubt, carbolic acid—say one part in fifty—would destroy organized animal matters; but

when applied, as must be the case, in a highly-diluted form to a large heap of farm-yard manure, it was very questionable whether it would destroy the cattle-poison, and whether, indeed, it would not rather tend to preserve it. He believed that a solution of carbolic acid of proper strength might be most usefully employed for destroying the poison in hides, and, at the same time, preserving the skin, so that it would not be unfit for the purposes of the tanner. The preserving qualities of carbolic acid were remarkably great.

Mr. FRERE wished to ask Professor Coleman what was the strength of the carbolic acid recommended as a wash for adult sheep?

Professor COLEMAN: One part in sixty of crude carbolic mixed with soft-soap.

Mr. FRERE said he had used carbolic acid to dip live animals in; and from his experience, he believed that for the purpose of disinfection the mixture ought to be still stronger than that recommended by Professor Voeleker, viz., one in fifty. He spoke from his experience of its use as a dip for sheep, used to destroy the insects upon them and their eggs.

Professor COLEMAN: For insects, you want it stronger. They are difficult to destroy; and for them, no doubt, you require one in forty.

The Rev. Prebendary BRERETON thought that the time had come when the Royal Agricultural Society might, through some special agency, impress on the owners of cattle the importance of the measures which they were urging on the Government. He could corroborate some of the statements just made as to the manner in which the present Act was being carried out. Being on the coast of Norfolk recently, he heard of a cargo being sent up from Lynn. He knew some of the villages from which they came, and in one of those villages a case of cattle plague had actually just broken out. A notion was entertained that animals might be cured by the administration of chloroform. Attempts to effect such cures had been made, but had failed. Moreover, the delay in burying them after they were killed was so great that in one case, where three labouring men were engaged in the work of burial, the stench arising from their clothes was described as awful. Here, then, they had the first case of a disease breaking out in that neighbourhood; and the cattle were driven twelve or fourteen miles by road, to be exported from Lynn, and sent to the London market. If there were any merit at all in the present legislation, he thought they had a strong case there, but it had gone for nothing. He lived in North Devon, where the disease was approaching. The farmers in his neighbourhood had shown a lively apprehension of the danger, and a desire to do everything that was proper in the matter, and he felt sure that they would appreciate any specific information coming from a central authority and guiding them as to what steps they ought to take; but he regretted to say that he was not aware of there being such a close communication between that Society and the general body of agriculturists in the kingdom as one would wish to see. He hoped the Council of the

Society would consider whether they should not appoint a special vigilance committee to enforce on cattle-owners the truth, which had been recognised without a dissentient voice by all the authorities in the country, that at the present moment they had nothing to rely upon but the destruction of the infected animals, and that the more promptly and completely that was done the better.

---

*Meeting of Weekly Council, Wednesday, April 18th, 1866.* LORD BERNERS, in the Chair. A Lecture was delivered by Dr. VOELCKER ON

THE CONDITIONS TO BE OBSERVED IN CARRYING OUT AGRICULTURAL EXPERIMENTS IN THE FIELD.

Professor VOELCKER said: My lord and gentlemen—To perform a really instructive experiment in the field, in a rational manner, is a far more difficult matter than many people seem to be aware of. Indeed, if we review the published accounts of many experiments, it cannot but strike us that most of them were undertaken without any definite object. They have been performed by men not qualified for the task; the conditions necessary to be observed as influencing the final result have been altogether overlooked; and, as I have said, the whole trial seems to have been made at random. It is for this reason that, in accordance with the recommendation of the Chemical Committee, I have put together a few thoughts with respect to some of the conditions which it is expedient that all who try their hands at field experiments should observe.

Field experiments are usually undertaken with a twofold object: either they are what are called purely practical experiments, or they relate more especially to the theory of agriculture, to some point in dispute, or some theoretical question not directly affecting the profits of the farmer. The object of instituting practical experiments in the field, or those commonly so called, is to ascertain in a more or less direct manner what system of culture or what kind of fertilizers produce the best economical results on a farm. To ascertain how the largest crop of wheat, or barley, or roots, or hay, can be grown with the least outlay of money. Theoretical questions, although they have a close connection with profitable farming, do not much concern the experimenter who makes a trial in the field for the avowed purpose of simply ascertaining what system of culture will pay best in his peculiar circumstances. Experiments which are made solely for the purpose of ascertaining which kind of fertilizers will give the best economical result are not without their value, though it be but a low one; the lesson is almost confined to the individual experimenter, and even he can only derive benefit from his own experience if he have sufficient intelligence rightly to interpret results. The agricultural public at large cannot gain much benefit from isolated field experiments, in the account of which no reference is made to the conditions under which the experiments proved a failure or a success. Indeed, if the individual experience of the experimenting agriculturists of the

new school be relied upon as a guide to successful farming, practical mistakes must necessarily follow, and bad farming will be perpetuated quite as much by such proceedings as if the rule of thumb of a by-gone generation were regarded as the road to advancement in agriculture.

Empirical knowledge in agriculture is by no means to be despised; but such knowledge, though of value to the individual, is of no value to those who are differently situated. On the other hand, scientific, or, as they are sometimes called, theoretical experiments in the field, have for their object to establish agricultural truths or principles which may be a general guide to the practical man in his operations on the farm. In all scientific experiments the ultimate object is to promote the progress of agriculture as a practical science. The scientific experimenter is not necessarily interested in the purely economical result of a field trial; direct profit is not their aim, but rather the establishment of general principles which may be applied by the practical farmer. It is for the farmer to keep these general principles in view, and to determine for himself what practical bearing such principles have on the cultivation of his crops in a particular locality. This distinction between purely practical field experiments and systematic or theoretical experiments should be steadily kept in view. The latter appear to me the most important. It is, therefore, to the latter kind of experiments—systematic experiments—that my future remarks will especially apply.

The first question that forces itself on our attention is, Should experiments in the field be performed on a large or small scale? A good deal may be said in favour of experiments on a large scale; but, on the whole, I am inclined to think it is not necessary to set aside many acres for purely experimental purposes, and that many of the most instructive and valuable field experiments may be performed within a narrow space. The extent of the area must be determined, in a great measure, by the nature of the crop. Thus crops which we can plant in drills, and which may be kept under better control than others, may be confined to a smaller area than grass crops. In the case of roots, I think the twentieth part of an acre is a useful size. For corn crops I would recommend a quarter of an acre; as also for experiments on grasses, both artificial grasses and permanent pastures.

If we make experimental plots too large, there is very great difficulty in performing agricultural operations under precisely the same circumstances. All who are acquainted with practical farming must know what a difference of results often arises from a difference of one or two days in time. I have seen a difference of more than six tons of turnips, which could be attributed to no other cause than the fact that between the sowing of one plot and of another in the same field, manured precisely alike and under the same mechanical conditions, two days elapsed. Now we know perfectly well that when seed has a chance of springing up and passing successfully through the first stages, we obtain, other circumstances being equal, a better crop than when the ground, or rather the seed-bed, becomes dry, and three weeks

perhaps intervene before the plant has a fair chance of making a start. Three weeks tell very much on crops which, like our root crops, have but a short time for growth. But as it is impossible to cultivate a whole field precisely alike, to secure the same conditions throughout a large area, it is, I believe, on the whole, best to confine field trials on arable land to plots amounting to the twentieth part of an acre.

The next circumstance which greatly influences the success of field trials is the kind of soil selected. The field itself should, if possible, be level; it should be uniform in quality, and not too shallow; it should be perfectly drained, and in good physical condition. For general experimental purposes, perhaps it is best to have soil which is neither very light nor very heavy; no great preponderance, whether of clay, or of organic matter, such as peat, or of sand should occur. Experiments for particular soils constitute in themselves a particular class of trials; but if we wish to ascertain what is the general effect of certain manuring constituents, such as ammonia, or phosphate of lime, or potash, it is not desirable to have a soil in which one or other of the chief constituents greatly preponderates. Under all circumstances, the physical condition of the soil, the nature of the subsoil and its depth, as well as the depth of the surface soil, should be carefully recorded, and the chemical condition of both should also be ascertained. Moreover, the *agricultural* condition of the experimental field should be perfectly well known. The neglect of this point produces a great deal of confusion, and renders the account of many of the recorded field experiments altogether unintelligible. We should ascertain how the field has been cultivated in previous years, when it was last manured, what was the weight of corn, or roots, or hay, which it yielded during the whole of the last rotation, also what is the average yield in good seasons as well as in bad ones. Further, we should know whether natural manure, such as farmyard manure, lime, and compost manure, or whether artificial manures, such as guano, superphosphate, or bone dust, have produced a particularly marked effect. Information on all these points often throws much light on the agricultural as well as on the chemical condition of the land, and affords useful indications as to the mode in which field trials should be arranged by the intelligent experimentalist.

In order to illustrate how the neglect of these agricultural conditions often entirely spoils the experiments, and tends to waste of time and waste of money in the purchase of artificial or natural manures, I shall mention some experiments which I had tried in 1864 on some clover land. The experimental field was divided into six portions. Two parts were left unmanured. The four others were manured as follows:—The first plot received nitrate of soda alone at the rate of 3 cwt. per acre; the second  $1\frac{1}{2}$  cwt. of nitrate of soda, and 4 cwt. of superphosphate of lime, of known composition; the third 6 cwt. of salt per acre; and the fourth 3 cwt. Now, the two unmanured plots yielded the following per acre:—The first, 2 tons 11 cwt. 80lbs. of green hay; the second, 2 tons 11 cwt. 8lbs. The plot manured with nitrate of soda alone, at the rate of 3 cwt. per acre, yielded 2 tons 14 cwt. 32lbs.; the next plot, manured with nitrate of soda and superphosphate,

yielded almost precisely the same quantity, the exact amount being 2 tons 14 cwt. 72lbs. In all these four trials the produce was almost the same. The application of 6 cwt. of salt per acre slightly reduced the yield of clover hay, viz. to 2 tons 8 cwt. 24lbs. ; and 3 cwt. of salt gave 2 tons 10 cwt. The manure was applied in the month of February, and the crop was weighed on the 20th of June, just when it was about ready for stacking. Now, it is evident from the result of these field experiments, that the land in that case was in such high condition that no further application of manure produced, or probably could produce, any result. The agricultural condition of the soil was at the highest pitch of excellence. We know that if we ourselves have filled our stomachs, no amount of additional food will do us any good; and so it is with fields. This is only one instance showing how necessary it is to take account of the agricultural condition of experimental fields.

Let me give you another illustration showing how the character of the soil will influence the final result. Some years ago I published in our 'Journal' the result of some field-trials of salt upon mangolds. The effect in that case was by no means beneficial, indeed, the heavier dressings of salt reduced the crop by several tons. In the following year similar experiments were tried on light soils; and by the application of salt I obtained an increase varying from two to nearly six tons of mangolds per acre, the larger quantity of salt producing the greater increase. The result of the trials on the light soil was in fact diametrically opposed to the result of the trials on the heavy clay land; this being another proof how necessary it is to take into account the character of the land under trial.

Again, we know by experience how different the effect of nitrate of soda is on different soils. On some land nitrate of soda should, I believe, never be used, simply because such land is too poor in the mineral constituents which, we must take it as an established truth, are essential to the very existence of every kind of agricultural produce. If these minerals are very sparingly distributed in the soil, by applying nitrate of soda we exhaust the soil too much; and though the result may not appear unsatisfactory in the wheat and barley crops, yet in the succeeding crops the injury of such an application will at once become apparent. Let me further illustrate the modifying influence of the soil by the effect of bone as applied to land. There are soils in which bone produces no effect, for the simple reason that phosphatic constituents are disseminated so widely through the soil that no further importation of phosphate of lime can possibly produce any benefit.

In the next place, regard should be had to the time and mode of applying manures for experimental purposes. Some field trials ought to be commenced in autumn; others ought to be reserved for the spring months. The experiments on grass-land should, if I am not mistaken, be begun in autumn; for on grass-land it is desirable to try the effects of manures that are abiding in their action, that become soluble in the soil gradually, and are not rendered available so soon as other manures. If we can get the soil to perform this office, we



shall save what we have to pay the manufacturer who prepares manures, which should produce an immediate effect for the benefit of root crops—mangolds, swedes, or turnips. Manures which are used as top-dressings may be used on wheat-land in autumn with quite as much benefit as in spring, provided the land is sufficiently retentive to absorb ammonia, potash, or other valuable fertilizing constituents; for nitrates, it is of considerable practical importance to observe, are not absorbed by the soil. They pass, as we know from experiments which were performed by Professor Way (whom I am happy to see present on this occasion), into the drainage water; and this is one reason why we obtain contradictory results with the same manuring matters when they have been used at different periods of the year.

Then, with respect to the mode of applying manures, we should be very careful to secure a uniform distribution, especially of concentrated manures, such as guano or superphosphate of lime. This can only be done by an admixture of some indifferent substance; such as dry soil, or sharp sand, or common burnt clay; or, in the absence of these, sifted coal ashes. For experimental purposes all concentrated manures should be mixed with three times their bulk of some diluent or other. On grass land my own experience leads me to recommend the use of the manure-distributor, which may be also adopted with great advantage for corn crops. A far more uniform distribution is thus secured than can possibly be attained by hand. On the other hand, for root crops, it may be desirable in most instances to ridge up the land, apply the manure by hand, and then split the drill again, so as to cover up the manure.

A third condition which it is essential to take into account is the composition of fertilizers. The composition of manures used in field-trials should be perfectly well known, and their application to the land should be made by careful weight.

In the next place I would observe that the experiment should be arranged in as simple a manner as possible. The great fault of most field trials is that too much is attempted. There are so many disturbing elements in complicated trials, that in most instances it is impossible to say what fertilizer produces the beneficial effect, or to what cause the failure has to be referred. We should endeavour as much as possible to eliminate disturbing elements. With this object in view, I suggested in the last number of the *Journal* a series of field experiments which may perhaps appear to some practical agriculturists to be too simple. Allow me to refer briefly to some of them. In the case of one series of experiments which I suggest to the farmer, I am anxious to ascertain the effect which the artificial supply of potash is capable of producing. Now, in order to apply potash in an economical form, we must necessarily take with it some other fertilizing matter. Perhaps the cheapest form in which potash can be applied to the land is that of the recently-discovered salts of potash, which are now imported in considerable quantities from Germany; not, however, so much for agricultural purposes as for the purpose of converting nitrate of soda into nitrate of potash.

In these potash salts we obtain a great deal of common salt together with the potash. In order, therefore, to understand the effect of the potash it is necessary to eliminate the effect of the salt, and if we neglect to do this we shall be led into mistakes which may be very serious in practice. I cannot better illustrate this than by referring to the results which I obtained last year in some field experiments with salts of potash, which were fortunately tried in conjunction with common salt. The experiments to which I allude were tried on mangolds. "No manure" produced 13 tons per acre of clean roots: potash salts, at the rate of 1 cwt. per acre, produced 15 tons. It would appear that the potash here produced an increase of 2 tons. But side by side with that I tried also common salt: 2 cwt. of common salt produced nearly 17 tons; so that it would appear that common salt alone produced a better effect than potash and salt. I will give you another result. Potash manure applied at the rate of 4 cwt. per acre produced 21 tons of mangolds: common salt at the rate of 8 cwt. per acre produced almost the same quantity. Now this leaves the result altogether doubtful. We do not know whether the increase was due to the effect of the potash. I may observe that during the last four years I have tried on no less than six different farms experiments with crude potash salts; and if you asked me plainly the question—"Does potash produce any beneficial effect on farm produce?" I should be at a loss to answer either in the affirmative or the negative. I cannot say I have as yet obtained a decided result. Each year there has been brought to light some accidental circumstance which had been overlooked. Indeed we have to learn how to perform field experiments.

I have already advised that experiments should be as simple as possible. In the next place care should be taken to reserve two or three plots on which no manure is to be applied. This is necessary in order to ascertain the limits of the natural variations in the productive powers of different parts of the same field. These limits are in some fields sufficiently wide to spoil altogether the final result of an experiment; and indeed it would be well to ascertain them by a previous trial, in order that we may except certain fields altogether from our experiments.

Again, regard should be had to the physical requirements of particular crops. It is vain to try experiments on plants which, on account of their habit of growth, will never succeed in a temperate climate like that of England. It is vain, for example, to try experiments on Indian corn in Scotland, or on mangolds in the colder parts of the world generally.

Again we are to regard the physical requirements of newly introduced crops, such as lupines—a most useful crop, but it can only grow well in a warm soil. This is the reason why it succeeds so well on even the poor sands. Again I may remark that, perhaps, the failures of field trials made for the express purpose of ascertaining the cause of the failures of clover, or the clover disease, have quite as much to do with the physical as with the chemical conditions of the soil.

In the next place notice must be taken of the season, whether wet or dry, early or late, cold or warm. I might easily show, if it were requisite, that in dry seasons many of the most valuable fertilizers remain inactive; or indeed at times produce rather an injurious than a beneficial effect. Guano may be instanced; whereas in such seasons inferior artificials produce the better result.

Furthermore, we should never forget to note the progress of the experiments. During the growth of our experimental plants, frequent observations as to the appearance of the crop should be taken, and any peculiarities should be at once noted down on paper, and not trusted to memory. The appearance and colour of the leaves, the relation of the bulb to the leaf in our root crops, the healthy or diseased condition of our corn crops, and many other similar conditions, should be carefully observed.

Moreover, in systematic experiments the effect of certain applications should be noticed, not only on one crop but in some cases for at least two crops, and in most instances throughout the whole rotation for four or five years. It is well known to practical farmers that superphosphate of lime, which produces a good effect on our root crops, also produces in many cases a most decidedly beneficial effect upon the succeeding barley, producing a finer sample of barley—good malting barley; while similar land not so dressed bore a bad sample. The effect of bones, likewise, as everybody knows, must be observed for a number of years: for generally they only come into action in the second year, and the action continues for a number of years, sometimes eight or ten years, according to the character of the soil, which regulates the rate at which they decompose.

Once more, all field experiments should be made with a definite object in view, be it to clear up some disputed point, or to put to practical test some theoretical notion. Further, it is essential to observe that much self-denial and conscientiousness, as well as care and attention, are primary requisites on the part of the experimenter who engages in field trials, for this simple reason—that, notwithstanding all the care that can be bestowed upon them, unforeseen circumstances may altogether spoil the result. The field experimenter, indeed, must be a man who does not hesitate, if necessary, to throw the result of three or four years' labour into the waste-paper basket, before he makes any appearance before the public; and I am sure that the neglect of this primary requisite has done much practical mischief, for we have always to bear in mind that an experiment incautiously performed, or wrongly interpreted, is calculated to do quite as much mischief as good; and it is for this reason that I strongly impress upon all who engage in field experiments that they should, as I said just now, have a definite object in view and be ready to make sacrifices for its attainment. They should bring to bear upon their trials a perfectly unbiassed and intelligent mind; and they should have the pluck to throw overboard all the experiments of which nothing can be made, such as we sometimes find recorded in our agricultural publications. Lastly, in order to be truly valuable, field trials should be continued for a succession of years, and, if possible, on a variety

of soils, so that from a great number of experiments we may eliminate the disturbing influences which the variations in soils necessarily produce on the general result. Now, I have mentioned some of the conditions, and I might, had time permitted, have named a good many more, which it appears to me to be most essential to keep in view in performing trials in the field; and I would conclude by inviting the co-operation of the practical farmer, for it is impossible that the scientific agriculturist or the chemist can himself perform trials in the field without the co-operation of the farmer. If the farmer should take up this matter of field trials in a right spirit, I have no doubt that much useful information might, in the course of time, result from the united labours of the practical farmer and the scientific agriculturist. We do not want, at the present time, what is called purely practical field experiments—experiments which, as I have already remarked, have only an individual value, at the best. It is systematic experiments that are calculated to establish those general scientific truths which require afterwards to be introduced under all the modifying influences that are known only to individual farmers who are differently situated in different parts of the country; it is experiments which establish general principles that we require much more urgently than what are commonly called practical experiments, which have for their avowed object simply the profit of the farmer.

Mr. HOLLAND, M.P., suggested that as an ordinary farmer could not, as a rule, afford to give up a quantity of land for the purpose of experiment, he might ascertain the nature of his field in the first instance, and then when sowing his crop devote a broad band through the middle of the crop to the object of experiment. If he attended to all the instructions which had been given, the result would, he presumed, be pretty much the same as if he were to set apart a piece of land expressly for experimental purposes. Perhaps one end of the field might vary from the other end of the field, so that the experiment might have its variations, still, with a little care, and communication with scientific men, as opportunity offered, a great deal of good might be effected, and yet little expense be incurred in the appropriation of land to this purpose. Was there any objection to an arrangement of that kind? for he fancied that that was the only way in which the Society could get the common farmer to work with them.

Professor VOELCKER: No doubt there are certain experiments which might be carried out usefully by the ordinary farmer; but there are a great many others which cannot be carried out by him. Indeed it is almost necessary that some plan should be arranged similar to that which had been adopted on Mr. Lawes' experimental farm. We stand at present very much in need of what in Germany are called experimental stations, or experimental farms, which differ from experimental farms as they are known in this country. For systematic experiments a few acres of ground, perhaps not more than ten, would suffice; and in conjunction with those experimental acres there should be a laboratory, so that the manures might be analyzed and the produce examined there; and even the collecting of the crops should be performed by assistants accustomed to carefully measuring and weighing, and

thoroughly trained in carrying out precise experiments in a more accurate manner than could reasonably be expected from the ordinary farmer.

Mr. HOLLAND happened to belong to a club consisting of persons connected with agriculture, and the president of which was a scientific man. They met once a year, and at that meeting the members reported to that scientific gentleman all that they had done under his directions in the course of the year. The President then set out a fresh task for the following year. Their operations were widely scattered, inasmuch as the members lived in different parts of the country; and he believed that the reports of that club were of great value to practical science. One reason for that, however, was that the members always reported to the same individual. The club to which he referred was the Club of the Agricultural College at Cirencester, and the President was his friend Dr. Voelcker.

Colonel LE COUTEUR (Jersey) observed that Professor Voelcker, when speaking of what was necessary to obtain a good result with potash, had not quite cleared up that point. He mentioned that from the application of salt, and again of potash and salt, the results were so nearly alike they could scarcely be called results. What did the learned Professor recommend should be mixed with potash, in order to obtain a better result?

Dr. VOELCKER said that, in the particular experiment he had referred to, salt alone produced as great an effect on the mangold crop as potash combined with salt. In reality, therefore, no practical result was obtained.

Colonel LE COUTEUR: You have no other ingredient to mix with the potash to produce the result you hoped for?

Professor VOELCKER answered in the negative.

Mr. HOLLAND: Could lupines be grown in heavy clay, well drained and steam-ploughed?

Professor VOELCKER was afraid not.

Mr. FRERE (Editor of the 'Journal') remarked that his friend the late Professor Henslow of Cambridge had been most anxious that the systematic conduct of experiments in agriculture should be established through the agency of the Royal Agricultural Society; that it would be a great satisfaction to himself if this meeting could lay the foundation for accomplishing that object. He was not inclined to differ from Dr. Voelcker with regard to the area for field experiments, but thought with him, that, on the whole, the plots should be small. At all events, there should not be more than a day's work included in the experiment; but that would often extend to an area of six or eight acres, so far as the process of sowing was concerned. Further, the ploughing ought also to be effected in one day, for, during a recent dry season, he found a most marked difference in a field of mangold drilled just before the period of drought arrived, a part of which had been ploughed one day before the remainder. Again, in experiments with roots, it was necessary to guard against irregular planting and the effects of insects; to meet this difficulty it would be well to try experiments as far as possible on those particular plants which

would bear transplanting well, such as cabbage and kohlrabi, rather than the white turnip. The number of plants might be determined; and if any were destroyed by accident, provided they began in good time, the gaps could be filled up, and the full number maintained.

Then, as to the soil, the Professor had advocated a medium one; and certainly this would commonly be desirable, if the experiments were to be a general guide: but he did not believe in the general applicability of any particular line of action in agriculture. With respect to potash, on clay soils there would probably be a superabundance of potash available or locked up, and perhaps in medium soils an adequate amount. If they wanted to see whether potash could produce such an effect as to encourage the farmer generally to give it a trial, it must be applied on soil that was decidedly deficient in potash—that was, on sand. In the experiments with potash which he was about to try this year, he was most hopeful of seeing a decidedly good result upon a burning sand, on which he meant to sow kohlrabi early. Until the present time the only green crop which he could successfully grow on it had been colesced or rape, the sowing of which he must postpone until the middle of July, otherwise even that plant would not stand the summer heats. White turnips it would be vain to sow, but he fancied that kohlrabi might stand the drought and heat even there; and that he was more likely to get a satisfactory result from the use of potash on that soil than from other similar trials or experiments on the more medium soils.

The Professor had stated that they might mix concentrated manures with sand, and also with ashes. He would remind the Professor that if the ashes were off a good clay, they themselves were of a manurial nature, and not mere make-weight or bulk, as sand would be.

In the excellent paper which Professor Voelcker had published in the recent number of the 'Journal,' he had suggested the use of potash *in addition to farmyard manure*. But what farmers holding poor land wanted was a manure that would do *instead* of farmyard dung—a complete substitute for farmyard manure, if possible. That being so, it must contain phosphate, and on light soils probably potash also; and they would require to see the effect produced by potash in conjunction with phosphate and nitrogen, quite as much in contrast with farmyard manure as with plots to which no addition had been made except that of common salt.

They were bound, he thought, in a scientific point of view, to make these experiments with potash, whatever might be the result. They had been taunted with forcing their lands with nitrogen, and overlooking or neglecting the mineral resources of the soil. Now, he took it that the most important mineral was phosphate; and certainly, so far as his own county (Cambridge) was concerned, it could not be taxed with overlooking that. The next mineral in importance was potash; and up to this time they had not purchased it, although, as far as they were able, they provided it from home stores. German potash manures might be bought of two kinds—the finer at 8*l.* 10*s.*, and the coarser at 3*l.* 10*s.* He himself had

purchased a ton of the dearer, and applied it in various ways. No time was to be lost if potash was to be applied this season. If it were applied late in the year, it "backened" the plant; and whatever its intrinsic virtues might be, if applied late, or in the dry season, it diminished instead of increasing the produce.

Earl CATHCART desired a word or two with regard to the application of potash to dyspeptic land that he himself had experimented upon. There was no part of the Society's Journal that he read with greater pleasure than that which contained the contributions of Professor Voelcker; and the result of reading one of those papers last year was that he ordered a quantity of potash from Glasgow. He had forgotten what price he paid for it; but it was necessary to bear in mind that, compared with salt, potash was a very expensive thing. When he was going to apply the potash to the land, his bailiff seemed to have entertained the idea that it was to be applied to the land as you apply it to the human subject—to correct the sourness of the land; and he rather expected that there would be a sort of "fizzing," like seidlitz powders, going on! But the object was to try an experiment, and he applied a reasonable quantity. The land was not measured, and he could not say that the effect on grass land was at all satisfactory—indeed, he could not see that there was much difference. He also put down wood-ashes, which were analogous to potash; and wherever that was done, the effect produced was very marked. Potash, then, being an expensive article, if salt would produce anything like an equal effect, it was certainly preferable on commercial grounds. But by far the most marked result was the effect of marl upon marl. That was going back to the system which existed in this country prior to the Roman period; for when the Romans came here, they found a number of marl pits, from which the ancient Britons were in the habit of obtaining marl for the culture of the land. The effect of marl upon marl was very marked; and he should like to know whether that was owing to the silica, to the lime in the marl, or to what other cause. He should further wish to be informed what made so material a difference between potash and wood-ashes. For between the two there was undoubtedly a most material difference; and if he could procure a large quantity of wood-ashes at a reasonable price, he should consider it the most valuable manure he could have.

Then there were also bones—about the most advantageous artificial manure they could use upon marl. They were debarred from the use of them during the present year, on account of the dread of extending the cattle plague, and they knew that the benefit remained, for the land, when once it had been thoroughly boned with a large quantity, never went back. It was an interesting fact, however, that they were not indebted to science in any way whatever for the application of bones in the first instance, but to fox-hounds. It happened in Yorkshire that the grass outside a kennel was observed to grow most luxuriantly on the spot where the bones of the flesh on which the hounds were fed, were thrown. These bones being gathered up, broken in pieces by hammers, and scattered over grass-land, were

found to produce a like result. So that the value of bones as a fertilizer was made known, not by science, but the much decried fox-hunting.

PROFESSOR VOELCKER, replying to the inquiries of Lord Cathcart, said that wood-ashes contained many other good things in addition to potash itself. Amongst these were phosphate of lime in considerable quantity, carbonate of lime, and sulphate of lime. Indeed, the application of wood-ashes might be said to amount to a dressing of potash, a dressing of bones, a dressing of gypsum, and a dressing of marl, and this must surely account for the greater benefit which wood-ashes produced in comparison with potash alone. He would rather buy wood-ashes, therefore, by all means, than potash; for potash contained only one of those constituents. There was a good deal of potash in wood-ashes, and although the wood-ashes might have been washed, they still formed silica of potash. With regard to the marl question, he should like to know whether the soil, although resting on marl, in reality contained lime.

LORD CATHCART: The soil was very thin. It was nearly on the marl, being within a few inches only.

PROFESSOR VOELCKER had found in the Cotswold district soils on which the calcareous gravel cropped up within an inch and a-half of the surface, that the soil which rested upon it had scarcely a particle of lime, or certainly not one-half per cent.; and in such cases the application of road-scrapings to the land had been attended with considerable effect. It was possible, therefore, that in many localities where marl abounded all around, the surface soil nevertheless still stood in need of lime.

LORD CATHCART: Had it any effect on the mechanical condition of the land?

PROFESSOR VOELCKER thought not. The quantity of potash which could be used on the land in the shape of wood-ashes was from economical considerations so small, that it would not produce any marked effect in neutralizing the acids, or what was called the sour humours of the land. And here he called to mind a practice which was followed in Hampshire, of putting chalk upon chalk. Chalk was in the land, visible to the eye, and the lower chalk was put upon the surface chalk! Here the reason of success was not the same as in the application of marl upon marl. The lower chalk contained phosphates, the upper chalk contained none, or only mere traces of phosphates. Hence the application of chalk from the lower pits would introduce a new element of fertility which was not present in the upper chalk. Professor Way would bear him out in what he had said on this subject, for the Professor had himself examined the upper and lower chalks, and had drawn attention to the difference in this respect.

PROFESSOR WAY said there was no doubt that Dr. Voelcker was quite correct. There were two conditions. In fact, the explanation dealt with two different sets of circumstances: the one, where the upper soil had no lime, or not sufficient lime present in it; the other where something new was introduced besides the chalk. Some years ago a



case of the sort came under his notice on Archdeacon Huxtable's land in Dorsetshire. There he found them putting chalk on the upper soil; and, as the subsoil was chalk, he felt somewhat surprised at the proceeding. There were only four or five inches of soil. It was grass-land that had not been ploughed for a long time, and when it was examined it was found to be entirely destitute of lime, and that the application of a top-dressing of lime was absolutely necessary. This often occurred, and it accounted for the value of marl upon marl. There was another case, that of the silica beds in the chalk formation. At Farnham, in Surrey, where peculiar silica beds occurred, there were quarries that were called "marl quarries," and for miles around people went to them for the "marl," which they found to be very useful on their wheat lands. The late Mr. Payne, a valued member of this Society, being surprised by its peculiarity and lightness, had it examined, when it was discovered not to be marl at all. In fact there was no marl whatever in it; but it was a peculiarly soluble silica, exceedingly useful on chalk-lands, or lands on which there was no deficiency of chalk.

The general subject which Dr. Voelcker had so ably brought forward was no doubt of the first importance to the Royal Agricultural Society. Probably Dr. Voelcker had more in his mind than he thought right to say to them on that occasion; and he (Professor Way), as having preceded him in the office he held, might say that he quite agreed with him that experiments, to be of any use, must be conducted in the most systematic manner, and that experiments which were not made with a definite object and under a definite system were most injurious and mischievous. They were calculated indeed to mislead. They formed a confused mass, from which those who were acquainted with the subject could draw no inference, whilst those who were not acquainted with it were very likely to be misled. They could not expect farmers in their ordinary occupations to draw the distinctions which were necessary. The farmer saw certain experiments producing certain results, and expected to get similar results from pursuing a similar course on all soils and under all circumstances.

The best thing to be done, therefore, was to establish experimental stations, as was done in Germany. That was the only perfect and feasible system of getting at what was really wanted, namely, abstract truth for practical application. In all things we began with abstract truth, and made it subservient to practical application subsequently. In connection with this point, reference had been made by Mr. Frere to the late Professor Henslow. He (Professor Way) might add, that the late Prince Consort was exceedingly anxious to see such experimental stations in this country, and had once told him that he thought the Royal Agricultural Society might initiate the system. There was no doubt that in that way truth would be more easily gained, more certain and useful information obtained, and when obtained retained, and the principles acquired might be directed to general use. He could not speak too highly of Mr. Lawes's experiments, and although they could not expect many persons to carry on

experiments on a like scale, they could nevertheless obtain similar results by means of combined experiments. The money spent on individual experiments would do more good by being concentrated on such farms as Dr. Voelcker had spoken of. Perhaps two or three established in different parts of the country might be sufficient in the first instance, and they should report to head-quarters. In the absence of that kind of experimental farming it was probable that Dr. Voelcker might, as he himself proposed, get a great deal of information; but the experiments should be conducted strictly in accordance with his suggestions; they should be reported to him, with full liberty to do what he liked with them, to publish or expunge them, to form his opinion respecting them, and to act accordingly. It was not desirable, however, that a great number of persons should engage in the experiments, but those who did so should go heartily into them, and take every care that they were conducted properly, for if conducted carelessly they would be worse than useless.

Mr. HOLLAND thoroughly agreed in the remarks made by Professor Way, and, in proposing a vote of thanks to Dr. Voelcker, said he was quite sure the meeting felt more than obliged to him for having not only lectured to them, but, he hoped, laid the foundation of some system such as had been proposed by Professor Way, through which *bonâ fide* scientific and practical experiments might be carried on throughout the country, and reported to him. He thought Dr. Voelcker should draw up and send out forms specifying the manner in which the experiments should be carried out in accordance with the dictates of his experience, so that these, being conducted on different soils and in different places, might enable him afterwards to draw up a comprehensive report for the country at large.

---

*Meeting of Weekly Council, Wednesday, May 30th, Mr. H. S. THOMPSON in the chair. Mr. HERBERT read a paper on*

#### THE SUPPLY OF MEAT TO LARGE TOWNS.

Mr. HERBERT said: The long-agitated question whether it is possible to furnish the Metropolis with adequate supplies of meat for consumption without the aid of a live-stock market, evidently requires a solution at the hands of practical men; and it has been argued that there would not be the slightest difficulty in providing for the wants of nearly 3,000,000 of people by means of slaughter in the provinces; and, further, that many of the difficulties which surround the live-meat question would be got rid of. There are so many interests involved in the question before us, that I purpose entering into a few details bearing upon a matter which affects the interests of the consuming classes. In the first place, let us see whether it is possible, at all periods of the year, to furnish the Metropolis with, say, 1,500,000 additional carcasses of sheep, and 250,000 additional carcasses of beasts, irrespective of lambs, calves, and pigs, in a wholesome and saleable condition? The numbers I have here quoted represent

the average supplies of live stock annually disposed of in the great Metropolitan Cattle Market.

It is well known that the graziers themselves have little or no accommodation on their respective farms for slaughtering cattle, so that it would be found necessary to erect in the neighbourhood of large towns abattoirs of no small dimension to prepare the meat for transmission per railway. If we take the Norfolk season, we should find that about 12,000 beasts would be killed at Norwich during the first six months of the year. Colchester and other towns would require abattoirs for a portion of the Essex breeds; whilst during the last six months the slaughtering of stock would be chiefly carried on near Lincoln, Peterborough, &c. The difficulties in this respect would not be great; but we have to consider two important points—the conveyance of the meat to London, and the cost of carriage. Nay, more, we must not forget to consider how and upon what terms the offal is to be disposed of in localities where, possibly, little demand for it exists. It is well known, notwithstanding the amount of competition between the various companies, that the charges for the conveyance of dead meat to London exceed those for live-stock by nearly or quite two-thirds. During the period that the movement of live stock to London was prohibited, those charges, which of course entered into the retail price, were severely felt by the consumers. There would, of course, be no difficulty for the great lines in carrying any quantity of meat; but who does not know that country-killed meat invariably sells at lower rates than that slaughtered in the metropolis, if they be of equally good quality. Other objections might be easily urged against the proposed system. Naturally, the grazier would have imposed upon him a great additional amount of trouble. He would have to trust much to the honesty of those to whom he might intrust his stock; he would require separate accounts of the weight of each carcase, and the price at which the offal was disposed of. Again, he would have to run the risk of violent fluctuations in the value of meat in the dead markets, and of absolute losses from the carcasses arriving in the metropolis in warm weather in bad condition. But how is the offal to be disposed of? Additional tanneries, soap-works, and boiling-houses would be necessary in the vicinity of large towns, and the organization of the works required would be highly expensive. Admitting that a portion of the offal may be used on the spot for local purposes—what is to become of the remainder? Agents would be despatched from the metropolis to purchase rough fat, hides, skins, &c., but, owing to the heavy railway charges, they could only offer low prices for them.

But it may be said that the proposed system has long worked well in Scotland, Yorkshire, and the west of England, from whence we have long drawn very large quantities of dead meat for consumption in the metropolis. It must, however, be understood that the offal in Scotland, Yorkshire, and the west of England is readily used up. Most of the wool and hides produced in Scotland are there converted into use; whilst in the west of England, nearly the whole of the

supplies of pork are converted into bacon, hams, and lard for London consumption. Nay, more, the immense importations of pigs into Bristol from Ireland are slaughtered for the same purpose.

With all these objections before us, it is possible, if facilities are afforded, to supply London from distant localities with an adequate supply of meat in cold weather, or say during six months of the year. During the rest of the season, a live-meat market would be indispensably necessary, or we should have an amount of loss which would far exceed that sustained by the cattle plague.

Earl CATHCART felt very much indebted to Mr. Herbert for his observations, and thought it must be satisfactory to the meeting to have had the discussion opened by a man of such practical knowledge, one who had written so much on the subject. It appeared to him that the real question raised by Mr. Herbert was as between live and dead meat markets. They ought not to lose sight of the fact that, long before the cattle plague was thought of, the idea was entertained that, in consequence of the introduction of steam and railway conveyance, great alterations would take place in the dead-meat markets of large towns. One important point which they had to consider was the great increase of the population, in conjunction with the limited area of this country, and the consequent necessity for very considerable importations from abroad. There were about twenty millions of people in England and Wales; and the number of cattle within those limits, according to the last Cattle Census, was under four millions. Therefore, if the cattle in this country were divided amongst the population, there would be about one-fifth of an ox, or beast, for each person; so that, if we were dependent for meat upon England and Wales alone, that number of beasts would not hold out for a month. Hence, our great reliance was upon large imports from abroad—a state of things which must tend very much to increase the dead-meat markets, because it would be unsafe, owing to the existence of the cattle plague on the Continent, to have foreign beasts travelling through the country on our railways without a system of quarantine; and, rather than have quarantine, abattoirs would be established at the ports of debarkation, where the foreign cattle might be slaughtered and sent to London as dead meat.

Mr. Herbert had spoken of offal, and he had himself witnessed the difficulty in large meat markets of transporting offal. It was packed in baskets, and sent in a most disgusting state; but he saw no reason why travelling larders should not be constructed, in which the offal might be hung up and be supplied with a free circulation of air, so that it might arrive at its destination in fair condition. Something had been said about railway charges; and he really thought it an unjust proceeding to make capital out of what was a public calamity, by charging higher rates for the carriage of dead meat than for live. He was willing, however, to attribute this to the possible circumstance that new arrangements had not yet got into working order, and he presumed that the tariff for the conveyance of dead meat would be in proportion to that for live, when the thing had been more fully developed. With reference to the statement that

country-killed meat did not look so well as that which was slaughtered in London, he would observe that the "look" was not everything. "The proof of the pudding was in the eating;" and he questioned much whether the London polished meat—that was to say, meat that was polished up with warm water, grease, and other stuff, just as an old apple-woman at a stall polished her fruit every morning—was really as good as the country meat. But there was no doubt that the system of polishing, and other niceties and refinements which were so well understood in London, would also become familiar in the country, as soon as it was discovered that it was worth while to resort to it.

In alluding to the difficulty there was in regulating prices, Mr. Herbert had left out of account the service which the telegraph might render. It was hardly possible to overrate the importance of its agency in reference to this matter, and a practical man had informed him that they were perpetually telegraphing from Newgate Market with regard to the supply of dead meat. A telegram was sent down, say, to Aberdeen; and the cattle, which were there ready for slaughtering, were at once despatched and sent off by railway. There was a curious circumstance connected with the London market and the subject of offal. It was that beef-fat was regularly sent on its travels into other lands, and when it came back it was not in its original shape, but as tallow.

Mr. HERBERT remarked that it was purchased in London by the Dutch; and being carried into Holland, it was there converted into butter and tallow, and in that form was returned to London.

Earl CATHCART said that was an agreeable piece of information to impart to the consumers of butter. Moreover, if they knew how the "roast beef of old England" was poured into Newgate Market, he did not think they would relish it as they did now. Mr. Herbert had referred to the subject of competition; and he believed that all authorities were agreed that a central metropolitan market must be established, because of the necessity for having the means of regulating prices. If there were many meat markets, prices might greatly vary, and the competition which was essential for the regulation of the prices of meat be reduced. All authorities, then, were pretty well agreed as to the necessity for having a central metropolitan market for dead meat; but he spoke with all deference in the hearing of Mr. Herbert, who, of course, possessed better information than he could be expected to have. Here he would refer to the report of the Commission of Inquiry which sat in the year 1850, on the subject of meat-markets in the City of London; and he thought the evidence he was about to quote from that report was of particular importance, because it was given at a period when a cattle plague panic was not even dreamt of. They said that the supply to the City of London was more in summer and less in winter; and that the number of carcasses sent to Newgate Market in 1849, according to Mr. Giblett's estimate, supposed by the Commissioners to be under the mark, was of beasts 12,000, sheep 5,250, calves 800, and pigs 400. In hot weather, they said the dead-meat sales fell off, and those of the live

increased. That would always be the case, and it was an additional reason why abattoirs or slaughter-houses should be established within tolerable distances of town for the summer supply; for at that season it could not be safe to depend altogether upon distant counties, though it might on the home counties. The Commissioners further stated that they had been informed by the trade that the farmer would be induced by steam carriage to learn to slaughter, pack, and consign. Again, they also said that forty years previously there were only 13 salesmen in Newgate Market, and that in 1849 they had increased to 200. This showed the great development of the meat trade in consequence of the use of steam carriage. Formerly, it appeared, the home counties only could send dead meat into the London market; but in 1849 much of it came from Scotland, as it did now; and they added a fact which he was not acquainted with before reading their report, and it increased his sense of the inadequacy of Newgate Market—that the area of that market was only 2 roods 45 perches.

When one considered the enormous quantity of dead meat that was sent into Newgate Market, all packed and piled up, it was scarcely possible to conceive the scene of confusion presented there. Vans and carts were crammed into a street only 16 feet in width, where one could not pass another, and there they were unpacked in the midst of crowds of purchasers. The Commissioners in their report likewise referred to the disgusting manner in which the men carried the meat on their shoulders in contact with their heads and faces, and the dirty handling to which the carcasses were subjected. They spoke besides of the quantity of meat which was spoiled for want of air and space to hang it in.

Then there was an interesting article with regard to the probable extension and rapid rise of the dead-meat traffic, which appeared in one of the numbers of the 'Quarterly Review' in the year 1854, to which he would direct attention, as the information it contained had struck him with great force. That article was founded very much upon the report of the Commission already referred to. At that time it stated there were 36,487 tons of dead meat annually pitched into London; that the Eastern Counties Railway supplied 10,398 tons, and the Great Western 13,152 tons, and that the Eastern Counties in one Christmas week sent to Newgate Market 1000 tons of dead meat. It went on to state that the annual value of the meat consumed in London was upwards of 14,000,000*l.* sterling; and reference was made to the importance of making railway arrangements for the transport of dead meat, so as not to injure it.

He would next pass on to notice the report of the Committee of the House of Commons, which sat in 1856. That report contained much interesting evidence with respect to the metropolitan meat market, which he had not had time to go into thoroughly; but he would just take a brief glance at it. Amongst other things, it mentioned the single road leading to Newgate Market, that only one carriage could pass at a time, and the complete blocking up of the approaches by vans and carts. It then proceeded to say that steam had given a

remarkable impulse to the trade in dead meat both in England and Scotland, and that all salesmen agreed that the trade in dead meat would increase and become the principal source of supply. This, it would be observed, was in the year 1856; and of course before the cattle plague was thought of. In the next place, the report dwelt upon the importance of establishing a central market for the metropolis, of giving facilities in such a central market for the disposal of the offal among the poor people who required it, and also the essential importance of competition to regulate the price of meat. The committee also said there was no evidence to lead them to the conclusion that a dead-meat market, if properly managed, would create anything like unwholesomeness in its vicinity.

There was always something to be learned from our neighbours across the Channel, and he should like to quote the opinion of one of the most acute, clear-headed, and sharp-eyed Englishmen that had ever travelled: he meant Sir Edmund Head. In 1852, Sir Edmund published an interesting and popular book, with the title of 'A Faggot of French Sticks.' In one of the chapters, the author described a visit which he had made to the *abattoirs* and pig-slaughtering establishments in Paris, and a conversation which he held with the *chef* of the latter, in the course of which the *chef* stated the principle by which pig-killing was regulated. "Sir," said he, "in Paris no one has a right to kill a pig!" And that, it appeared, was the principle upon which the whole thing hinged. The killing was all done at the Government establishments. The Paris *abattoirs* were established by the Emperor Napoleon the First. There were five of them for cattle, outside the walls. They were built like cavalry barracks, and the dimensions of one of them were 389 yards in length by 150 yards in breadth. Arrangements existed for the immediate preparation of the blood for the purposes of commerce, and for disposing of the entrails. There were also a triperery and melting houses, and even when the weather was exceedingly hot there were no noxious smells. All the arrangements for treating the cattle were of a most merciful kind. There was no barking of dogs, no hallooing of men, no feverish excitement. An abundant supply of water for slushing was provided. There was no pawing with hot hands, and no bad meat was allowed to be sent away for sausages. Then the author, moralising upon all this, exclaimed, How different was this to the manner in which they dealt with the roast beef of Old England in Newgate Market! If Sir Edmund had been with him (Lord Cathcart) on a recent occasion when he spent a whole night in Newgate Market, he fancied he would have used language still more forcible and emphatic.

Another remarkable circumstance, which Sir Edmund Head did not refer to, but which was mentioned in the 'Journal of the Statistical Society,' was that the introduction of horse-flesh into Paris having been forbidden, a large contraband trade in it sprang up, which increased to such an extent that the authorities were at length obliged to legalise the introduction of horse-flesh for consumption as human

food. Another important fact was this: that by the operation of the octroi duty the consumption of meat in Paris was correctly ascertained. This, however, could not be done in London where there were no similar means for arriving at such knowledge. The information derived from this source in Paris showed that great fluctuations were experienced in the rate of consumption of meat in different years, which was to be traced probably to fluctuations in the general trade of the country, and in the command which the people possessed over the necessaries of life and matters of that kind. But whatever might be the cause, there was no doubt that the consumption of meat in the large towns of France was subject to extreme variations. It appeared from the 'Journal of the Statistical Society' that the consumption in Paris during the year 1847 was 150lbs. of meat per head of the population, exclusive of game and poultry; in 1848 it was  $87\frac{3}{4}$ lbs.; in 1849 it was 146lbs.: and in 1850 it was 158lbs. These figures exhibited a very considerable fluctuation in the consumption of animal food; but if the mass consumed were taken, instead of the rate per head of the population, the fluctuation would appear to be still greater.

Most members of Parliament, he presumed, had received a copy of an interesting pamphlet relating to city improvements. By the map which was appended to that pamphlet, it would be seen that the new arrangements for the proposed metropolitan dead-meat market at Smithfield were as convenient as they could well be made. There would still, however, be the blockading difficulty. Nevertheless, it was so important to have a central market, that whatever the difficulties and drawbacks, they would be of much less consequence than the evil attendant upon having several markets distributed over the town. On this point he spoke with great reserve in the presence of Mr. Holland, who was at that time engaged in conducting an important inquiry into this very subject, which would doubtless conduce much to improvements. He hoped, however, that the parties would hurry on as fast as they could the completion of the metropolitan meat market; and if they did not at present feel inclined to do that, then he would recommend them to follow his example and spend a night in Newgate Market, which he thought might act as a spur to their languid energies, and prompt them to use a little more expedition in the matter. In drawing these remarks to a close, he would only further refer to the important recommendation contained in the concluding portion of the third and last report of the Cattle Plague Commissioners. From all he had observed, he was convinced that that recommendation was perfectly right: it was one to which, therefore, he gave his hearty concurrence. They said that now was the time to carry out the changes which were required in the supply of meat to large towns; when great alterations might be made without being attended by anticipated inconveniences; and it might be considered whether slaughterhouses should not be transferred from towns to suburban points on lines of railway, to the ultimate benefit of both customer and butcher. Then they ended by saying that the cattle



plague, though in itself a great calamity, had undoubtedly put a stop to much that was cruel and pernicious; and they hoped, as all hoped, that that happy state of things might be lasting.

Mr. FRERE: A large Norfolk grazier has informed me that in the spring he could only make 4s. 2*d.* per stone of meat which was brought up to London dead, while meat of the same quality in the London live-meat market would readily have made 6s. per stone. Did the difference of value arise from the nature of the case or from our state of transition? I am under the impression that farmers are not likely to slaughter on their own farms, but that abattoirs would be established in the environs of London, and animals would at all events travel to the railway stations on their own legs.

Mr. HOLLAND, M.P., adverting to the fact alluded to by Mr. Frere, namely, the variation of price as between one kind of meat and another, expressed his belief that it depended on the change of system. No doubt, however, in course of time—when the dead-meat market had been thoroughly established, and when, as the noble Earl who had just spoken anticipated, a system of communication by telegraph had been established, all these questions would be set right. He should have liked very much to enter into several points involved in the subject; but, as the noble Earl had remarked, a committee, of which he (Mr. Holland) was a member, was at that moment prosecuting its inquiries. It was a committee to consider the trade in animals—not only foreign, but home animals also—the question of quarantine, the mode in which animals were brought into this country, and the mode of their transit from place to place; and he regretted that they had not in Parliament the valuable assistance of their chairman (Mr. Thompson) on that committee. It would very inconvenient and contrary to rule for a member of a parliamentary committee to make use of the evidence taken by that committee, before the inquiry was closed and the report made; and he therefore felt his mouth to be closed on the subject. He could only say that he believed the results of the inquiry would be most valuable—that people would be astonished to see with what facilities a change might be made as regarded the feelings of a large population from one system to another; the new system being, too, far more efficient, far more effectual, far more valuable, far more healthy, and far more civilised than the old one.

Sir J. JOHNSTONE, M.P., fully believed that telegraphy would settle many difficulties connected with the meat market. As an illustration of the working of that system, he might mention that a day or two ago an epicure went at 5 o'clock to Charles' (the fishmonger's) to secure a fresh salmon. The fishmonger told him he had come at a happy moment, for he had just received a telegram from Worcester, stating that a salmon which had just been caught left Worcester by the 2 o'clock train. The result was that a fine salmon arrived in time for the epicure's dinner.

The CHAIRMAN, in summing up the discussion, said Lord Cathcart had alluded to the charges made by railway companies for the conveyance of dead-meat since the breaking-out of the cattle plague.

A great deal of what had been said in the way of complaint on that subject was perhaps due to a want of consideration of the difference between a wholesale trade and a retail one. They might rest assured that their northern brethren very well understood their own interest, and that if the farmers and cattle-dealers of Aberdeenshire and the districts around were satisfied with the existing traffic by railway, both as regarded the charges made for conveyance and the state of the meat when it reached its destination, there could be no great reason for complaint. It might fairly be assumed, he thought, that after a time the charges for the conveyance of dead-meat would not be such as to prevent the trade from being properly carried on. At present a man compared the charge for conveying a live animal with the charge for conveying a dead animal. He forgot that when animals were conveyed alive there were eight or ten in the same truck; whereas, under the existing state of things, the railway company had to convey one carcase, or it might be a quarter of a carcase. It would be impossible for the company to provide carrying-power for so small a quantity, sent to a station as it were hap-hazard, or to charge at the same rate for such a quantity as when a whole truck was hired and filled. If it should be found necessary in order to supply the wants of the country that dead meat should be conveyed on a largely increased scale, the charges would no doubt be adjusted to the altered state of things. Farmers would soon find out how to obtain the benefit of wholesale charges.

He, for one, felt much obliged to the gentlemen who had taken part in the discussion. Lord Cathcart seemed to have collected a great deal of information on several points which might be usefully discussed; and no doubt both his lordship's remarks and those of Mr. Herbert would be published in the Society's 'Journal.'

A vote of thanks was accorded to Mr. Herbert, and the meeting then separated.

---

*Meeting of Weekly Council, Wednesday, June 13th.* Mr. HUTTON in the Chair. Dr. Wm. FARR, M.D., F.R.S., Chief Superintendent of the Statistical branch of the Registrar-General's Department, delivered a lecture on Cattle Statistics and Cattle Insurance.

#### INSURANCE OF LIVE STOCK.

Dr. FARR said: England is not so much celebrated for its cereal crops as for its fine stock of cattle. The bulls, oxen, cows in calf, and heifers, always please the people at the shows of the Royal Agricultural Society. Although the English farmer is little given to sentiment, he does take a just pride in the herd which he has bred or chosen with care, and feels their untimely death much more acutely than he would a deficiency of crop or the destruction of grain of equivalent value. There is another source of anxiety in cattle—while agricultural stock is insured against fire, the live stock of the kingdom, in the hands of at least half a million owners, and worth upwards of 140 million pounds sterling, is, for reasons which I will shortly

explain, nearly all uninsured against destruction by disease. If a rick is burnt down, its value is recovered from the insurance office; and farmers are not terrified even if surrounded by incendiary fires. Far otherwise is it when their live stock is in danger. They have then no such resource. And where perhaps their whole capital—a large portion of which may be in cattle—is invested on the farm, murrain is ruin. The landlord, too, when the live stock of his tenant is swept away, is often pretty much in the situation of a man who has let on lease a house uninsured and burnt down by accident.

The news that the “hundreds of military cordons” which Professor Simonds told this society guarded the “western side of the German States” had been broken through, that rinderpest reached England in June last, that it was spreading and destroying whole herds of cattle in several counties, necessarily excited the liveliest alarm, which went on increasing, until in January it was loudly proclaimed by high authorities that the whole of the cattle of the kingdom was about to perish. The consternation continued, and was felt in both Houses of Parliament.

The first thing that was required under these circumstances appeared to me to be some measure to stop panic, to inspire confidence, to give time for the adoption of judicious measures for combating the plague, and to protect the stockowner from ruin by spreading the loss equally over all the owners of property in cattle. This could be done evidently by a system of insurance. Upon looking carefully into the subject, I found, however, that no adequate data existed for determining the mortality of cattle either in ordinary or epizootic seasons. In England we had no account of the numbers of cattle in the country, nor could I find any trace of an attempt in England to determine the rates of mortality at different ages on a large scale from pleuro-pneumonia, anthrax, (foot-and-mouth disease), or any of the other common or epizootic diseases. Upon the fullest consideration I came to the conclusion that neither local societies nor commercial companies could encounter the difficulties of the crisis; and that the only resource to be thought of, in the presence of the plague, was a system of national insurance. This notion gave rise to the paper which I shall have the honour to submit to the society.\*

We have to-day in our hands for the first time an enumeration of the live stock of the United Kingdom. The Statistical Office of the Privy Council supplies useful weekly returns; the reports of the Royal Commission have thrown a flood of light on this remarkable plague; such measures are in operation for its extinction as have been recommended by the first authorities; and, finally, the attacks of rinderpest are every week subsiding. So that now it may appear possible to institute, under certain conditions, a system of voluntary, and therefore partial, insurance. I have sketched in outline a system of this kind, taking into account the existing organization in the counties for the slaughter of cattle.

To bring the subject fairly before you, I must remind you that by

---

\* See p. 455.

the cattle plague return, week ending May 26, the disease has been reported, since its first appearance, in 25,968 farms, sheds, or other places, in which 438,681 cattle were found; it would hence appear that the average herd contains nearly 17 head of cattle (16,893); and on the improbable assumption that small and large herds are equally liable to attack, and applying this proportion to the 4,785,836 head enumerated in Great Britain, it might be inferred that the island contains at least 283,301 separate herds. On this assumption, out of 283,301 herds, 25,968 suffered more or less from plague; 257,333 sustained no reported loss. These numbers are in the proportion of 10 to 1; out of eleven herds 10 have escaped, and 1 has been attacked; eleven of these herds contain 186 beasts; and of the 17 beasts in the herd infected, 9 were attacked; of them 5 died, 3 were killed under the disease, and 1 recovered: 8 were unattacked, but 2 of the 8 were "slaughtered healthy" by way of precaution; thus leaving 6 alive unattacked, which, with the 1 recovering, gives 7 survivors out of the original herd of 17. Such would be the average case.

Let us assume that the 11 farms form a parish under one landlord. Then a farmer might lose the whole of his stock by pleuro-pneumonia, or by rinderpest; and what, if uninsured, is his situation? He might appeal, after the loss, to the pity of his 10 neighbours, who, if he had lost 90*l.* worth of stock, might replace it by giving him out of their charity 9*l.* apiece.\* Or he can appeal to his landlord. How different would be his position if he and his neighbours had paid 10*s.* a-head before the loss into an insurance fund on which each member had a just and equal claim! He would get his 90*l.* as a matter of right, on business principles.

I should mention that probably more than double the number of owners, assumed above, made returns of cattle, sheep, and pigs to the Inland Revenue surveyors; and that, as small herds were less liable to attack than large herds, it is possible that the average herd may not exceed ten.

Taking the head of cattle in Great Britain at 4,929,645 in ordinary times, it appears that rather more than 4 in 100 have died or have been killed on account of rinderpest. The proportion was 1 in 23. Of those treated to the end, 79 per cent. died, 21 recovered; and it may be inferred that if none of the cattle attacked had been killed, the loss then would have been 3.945 per cent., or very nearly 1 in 25 of all the cattle existing. It is certain that all the cases of rinderpest have not been reported in the small herds; and, upon the other hand, undoubtedly many deaths from other diseases figured in the returns, as the diagnosis of the disease was at first difficult. The returns give the nearest approximation we can get to the loss by rinderpest. The returned loss of cattle is 200,905; or, allowing for animals attacked and unaccounted for, about 210,000. At 10*l.* a-head,

---

\* Formerly, before fire insurance was invented, it was the established practice to make almost every fire a case for an appeal *ad misericordiam*. Collections were made in the churches, of which our parochial archives, we are told, contain abundant proof. The appeals for relief became so frequent as to give rise to serious complaint.—(J. Brown, 'J. S. Society,' 1857.)

this would make the total loss 2,100,000*l.*, which has fallen with cruel inequality on the heads of cattle-owners. [Dr. Farr next quoted several remarkable instances of losses.] This loss has occurred in 11 months among 4,929,645 head of stock, which at 10*l.* a-head are worth 49,296,450*l.*

It has been computed, upon very imperfect data, that a fourth part of the cattle are slaughtered or die every year, that is, that their mean lifetime is four years; and applying these proportions, about 1,232,417 head of cattle are killed every year. The mortality by disease in common years is guessed at 4 or 5 per cent. including calves; and, allowing for that, we have this account for the year ending May 1866:—

Estimated numbers of home cattle killed for market	1,022,411
Killed by common diseases .. .. .	200,000
Killed by rinderpest .. .. .	210,000
	<hr/>
Total .. .. .	1,432,411

In the ordinary course, upon this assumption, the cattle stock of the country has been reduced by about 210,000 head, to be made up by importation. These estimates, as you are well aware, are conjectural, because, while our commercial statistics have been attended to for centuries, statistics of the great agricultural interest have been entirely neglected, to our now great confusion. The statements must, however, be true within certain limits, and suffice to show the magnitude of this great question of cattle insurance, to which I invite your attention. Remark one fact, that the loss of cattle in ordinary years is large, on the lowest computation. The loss of farm stock by fire does not probably exceed 1*l.* 10*s.* per 1,000*l.* annually, and it is insured at the rate of 2*l.* 10*s.* per 1,000*l.* If the loss of cattle by disease in ordinary is 4 per cent., the loss by disease must be 40*l.* on every 1000*l.* of stock; and in the time of rinderpest 80*l.* a-year, or 8 per cent. The cattle being of a delicate organization necessarily encounter greater danger from hundreds of causes than that to which agricultural stock is exposed from fire; and as the loss is unequally distributed, insurance is indispensably required in this matter, as well as in the other, for the security alike of landlord and tenant.

It is right to add that, in addition to the direct loss of cattle which a certain number of owners have sustained, the whole of the cattle-owners of the country have been subjected to restrictions and interferences with the movement, sale, and propagation of stock that can scarcely be estimated at a lower figure than the 2,100,000*l.* of direct loss. It will be one of the advantages of insurance that some of the most vexatious of the restrictions may, on calm consideration, be safely remitted. The owners who have lost stock, when cattle can be insured, will be able to obtain advances of money which under present circumstances no capitalists will make.

#### LIVE STOCK INSURANCE ON THE VOLUNTARY PRINCIPLE.

To establish a society on this principle, the following course may be pursued.

1. The noblemen and gentlemen interested in agriculture to subscribe to a guarantee fund, on the plan that was adopted at the Great Exhibition. And in a matter of this importance the Government to subscribe an equivalent amount; engaging at the same time to advance money for preliminary expenses at a moderate rate of interest. The Guarantee Fund only to make advances on loan, and the subscriptions to be called for in instalments only in case of necessity.

2. It may be convenient to commence operations in London through a committee of management, to be nominated by the Royal Agricultural Society of England. Similar committees may be constituted in Scotland by the Highland and Agricultural Society of Scotland; in Ireland by the Royal Agricultural Improvement Society. Insurance is as much required in Ireland as in England, and I conceive that it is equally urgent in the present state of the cattle stock.

3. An appeal, to be forthwith addressed, through the Statistical Department of the Privy Council, to all the principal stock-owners of the kingdom, requesting their concurrence in a system of strictly mutual insurance, to be upheld by the payment of adequate premiums. It would not be necessary at first to address the numerous and less intelligent small owners, as they would come in spontaneously when the system was fully established. The remaining stock-owners would then be requested to send in classified lists of their stock and of its value in prepared forms to the Statistical Department, where they would be duly classified in counties.

4. It is probable that a shilling a month would insure 10*l.* on a healthy beast exposed to ordinary risks; and, under good arrangements, in any counties afflicted with future plagues of rinderpest and pneumonia, the premium would not exceed two shillings a month, and that only for a limited term. Power should be taken to adjust the rate periodically, so as to meet the reigning risk. There would thus be one common rate of premium, but the risk on milch-cows in towns, and in infected and unhealthy districts, would be met by equitable additions to the ordinary premium.

5. Stocks might be classed according to insurable value and risk, so as to insure a specified sum per head on each class.

6. The general terms of insurance being submitted to owners who had sent in returns, they would then be asked to insure their stock by the agents of the society, and would obtain policies of insurance upon payment of the first premium. An account would be opened with each owner in a ledger.

7. The common premium to be at the rate of 1*s.* a month, which may be commuted into a single annual payment of 11*s.* down on 10*l.* beasts, and so on in proportion to insurable value. No calf and no beast worth less than 5*l.* to be insured. The insurance policy might be transferred by endorsement, on the sale of cattle being registered in the insurant's account. Horses and sheep may also be insured on terms agreed upon.

8. The premiums, after providing a reserve fund for times of plague, to be adjusted on the experience of the society, and to be calculated from that experience by an actuary, so as to meet equitably the various risks on different animals at different ages.

9. The payments of premiums and the payments on policies may be made through the Post Office, allowing a percentage for expense; and, where it was necessary, special collectors might be employed.

10. All payments on policies to be made on the authority of a specially-appointed officer in every county, acting under the inspection of a committee.

11. The accounts would be duly audited and published annually, with a digest of the returns, and a report by the actuary. The authentic facts thus elicited would throw light on the causes of cattle diseases—would show us why, for instance, the mortality from cattle-plague was 34 per cent. in Cheshire, 18 in Cambridgeshire, 14 in Flintshire, 6 in Yorkshire, .09 in Devonshire. The causes being known, might often be removed.

12. All cattle imported should pay adequate premiums, and, if healthy, receive policies covering a term of one month or more: the premium to be collected by the officers of her Majesty's customs, and paid into the account of the society at the Bank of England. The losses on such policies to be recoverable on the proof of death by disease supervening in England, precisely as in the case of beasts of home origin.

13. No person losing cattle uninsured to receive compensation under any circumstances from any public rate.

14. Landlords, for their own protection, as they do now in the case of houses, might insist on the insertion of stock insurance clauses in leases and covenants.

15. Under these encouragements, it is probable that half the live stock of the United Kingdom would be ultimately insured, and then the sum insured would be nearly equal to the 77,000,000*l.* of insured agricultural stock, which, I am told, is not half the whole value of such stock in the country. If a large portion of live stock is insured the annual premium will amount to two or three millions, which will sufficiently pay all losses and expenses.

As in the case of dead stock, live stock insurance would work its way gradually; and recurring plagues, from which we can never hope to be entirely exempt, will convince the most sceptical of its utility. Fires, it is well known, are the advertisements of the fire insurance offices. Whatever profits accrue should be divided annually among the insurants, on the mutual principle. Unless the owners of a million head of cattle gave in their adhesion, it would not be prudent to commence operations. The alternative would then be to leave things as they are, or to ask for the insurance of all the country, on a plan which I lay upon the table and place at the disposal of the 'Journal' of the Royal Agricultural Society.

Dr. CRISP inquired what diseases Dr. Farr proposed to include in his system of insurance?

Dr. FARR: All diseases. It would be perfectly absurd to insure against any one particular disease. It would as completely break down, as if it were attempted to insure against any special disease in the human subject. Diseases could not be distinguished with sufficient accuracy to carry on business on that principle. It was difficult

enough now to secure a sum payable on a man's death; and if the payment at death were regulated by pneumonia, consumption, or other affections, much more easily distinguishable in men than in cows, it would be found to be utterly impracticable. That was one reason why all the local offices had broken down during the height of the cattle plague.

Dr. CRISP: If Dr. Farr had submitted to the meeting statistics connected with human mortality, he should not presume to differ from him; but unfortunately, his data were necessarily so imperfect that it was impossible to draw anything like positive or even proximate conclusions from them. The loss of cattle in this country, Dr. Farr estimated at 210,000; but if he doubled that number he would be nearer the mark, for a vast number of cattle had been affected by the plague that were not included in these returns. In his neighbourhood (Chelsea) a cowkeeper had twenty cows. One was seized with the rinderpest; and the others exhibiting symptoms, the man had them killed whilst they were in tolerably good condition, and sent them to market. These cows, therefore, were not included in the returns. Another man, in the country—and he could mention numerous instances of the sort—had a number of young beasts, lean and not fit for the knife; but because a neighbour had the rinderpest on his farm he at once sent them to market, and sold them at an immense sacrifice. In this way thousands and tens of thousands of animals had been killed throughout the country. True, it might be answered that they were used for food; but it should be borne in mind that they had not one-quarter of the amount of flesh upon them that they would have had in case they had been kept.

As to Dr. Farr's scheme of insurance, he believed it to be utterly impracticable, and that it would only be adding one more to the vast number of clubs which already existed in this country, where, indeed, there was nothing but clubism. In his opinion, the only good and useful plan would be for the Government to take the matter in hand, and, if deemed practicable, establish a national insurance, without entrusting the duty to companies or voluntary associations. That, at all events, was his impression; for he did not think that Dr. Farr was quite correct in his estimate that one-half the owners of cattle would join an insurance company. If they looked at Norfolk, Cheshire, and other counties, where insurance societies had been established, they would find that not a fourth of the owners of cattle had joined those institutions; and he judged from experience, therefore, that the scheme proposed was really impracticable. There was yet another difficulty. Dr. Farr said he would include all diseases. But to whom were they to look in this country for a definition of disease? What occurred a night or two ago in the House of Commons with special reference to this subject? Sir Jervoise Jervoise asked Mr. Bruce, the Minister of Education, if any means could be taken to arrest that direful disease which had decimated so many of the London dairies—pleuro-pneumonia; and the answer this elicited from the Minister was, that pleuro-pneumonia was not like the cattle plague, but was a chronic disease that had no relation to the cattle plague: therefore, we could take no



steps, as we did with regard to the cattle plague. He (Dr. Crisp) had had a great deal to do with cases of pleuro-pneumonia. He had examined many animals in all stages of the disease, and after they had died of it; and he had no hesitation in saying that pleuro-pneumonia was as acute a disease as the cattle plague itself; and that might be a chronic disease, for he had seen a vast number of animals linger on for eight or nine weeks and then die; and although the average duration of the attack in rinderpest might be seven days, in very numerous cases of pleuro-pneumonia the disease was so acute that death took place in a shorter time than that. This he had repeatedly witnessed; and yet in the House of Commons they had the Minister of Education saying that pleuro-pneumonia was a chronic disease.

In short, he saw nothing but difficulty in the plan proposed by Dr. Farr. He repeated that it was utterly impracticable, and that the Government ought to take the matter entirely into its own hands. The first step was, in his judgment, to establish a good veterinary college in England, Scotland, and Ireland. This was a most important item, and Dr. Farr must know that nine-tenths of the men who acted as cattle doctors—he did not blame them, however: it was the fault of the Government—had no proper education, and were incompetent to give certificates. That state of things must be remedied. There must first be a good college of veterinary surgeons established, and then some plan might be hit upon that would be carried out efficiently and properly.

But now came the most important thing in connection with the matter. According to the returns, in the course of the seven weeks ending the 6th of June, about 18,000 cattle died, whilst about 2,000 recovered. The “stamping-out” system was avowedly in operation, yet nearly 2,000 head of cattle had recovered! How did they recover? Most of them were probably treated medicinally, and during five or six weeks everything around them was subjected to infection. Yet this was called the “stamping-out” system, and the cattle plague was to be got rid of in this way! Although Dr. Farr had prognosticated that the rinderpest would subside this month, there was no evidence, if one looked at its history and progress, to show that the disease had the slightest resemblance to any epidemic with which we were acquainted, or that it would die out. The fact was that the most stringent measures must be adopted; and, looking at the plan suggested by Dr. Farr, he came to the conclusion that it could never be carried out, and that they must look to the Government alone. Dr. Farr had mentioned the case of a man who had 20 cows killed, and received the value of only 2. Now, in his opinion, it was a most monstrous thing that an inspector should be permitted to enter a man's premises, order 20 cows to be killed, and that the owner should receive the value of 2 only.

Dr. FARR said he had stated that there were 4 killed, not 20.

Dr. CRISP nevertheless looked upon such a system as a most dishonest one.

Mr. TORR said the inspector had nothing to do with the matter,

because remuneration for the loss of the animals was a question that was decided by the magistrates and local committees in the various counties, who had full power to assess at any sum, within the limit of the Act of Parliament, that they might think proper. That Act had, however, come into operation at a late period, so that many persons could not be compensated for their losses; and, generally speaking, the compensation granted under the Act had throughout the country been rather niggardly, and ought to have been larger. The "stamping-out" system had no doubt lost much of its effect owing to its not having been rigidly carried out. Cases of cure ought never to have been heard of after the passing of the Act which the farmers themselves had requested the Government to introduce. For it was not the absolute cure that constituted the saving, but it was the keeping of diseased cattle in the neighbourhood that caused the loss. Hence the "stamping-out" system having only been carried out partially had not produced its just and proper effect. Moreover, it was to be lamented that that system had not been adopted and put in force sooner; and further, that in many counties the Act of Parliament, which was based upon sound principles, had been evaded more or less by the very persons who had been most noisy in demanding legislation upon the subject.

With reference to the question of insurance, without saying anything for or against the plan of Dr. Farr or any other, as far as his experience went, it led him to conclusions entirely adverse to the voluntary principle. What happened last year might occur again; and the results proved that nothing founded upon the voluntary principle had the slightest chance of success. If it had not hitherto, there was no reason why it should hereafter. He had received letters on this subject from farmers in Silesia, where the cattle plague made its appearance periodically every few years, and it was really astonishing how small a sum, in the shape of a head-tax, paid into a Government Fund, was sufficient to meet the losses. He took it, that the loss would not require the payment of an insurance of 10s. a-piece. They might as well insure the moon as to ask the farmers to do that. What ought to be done was to have a head-tax on every animal in the first instance, so small in amount that no man could object to it, and then let the remuneration come from the public. All counties where there was much cattle would pay the head-tax. Counties where there was not much cattle would have no tax to pay, but the community at large would be called upon to pay the compensation, and that was not now done. The head-tax to begin with, then, should in his opinion be a small one. All systems of insurance that only included a portion of the stock of a county must be wrong in principle; and if the system were voluntary, one man would insure and another would not.

Previous to the breaking out of the rinderpest there were three or four large companies for mutual insurance of diseased cattle in operation, and every one of them had broken down; and for this reason: one man said, "I take good care of my stock, and my neighbour does not. Do you think I am such a fool as to go to an insurance company when he

will get all the premiums? For if you go to the National Insurance Company, you will see the same men receiving claims as insurers every year." In the first instance, then, he thought that the head-tax to be placed upon all cattle should be as low as a shilling, or sixpence twice a year, an amount at which no one could reasonably grumble ["On the birth?"] No; on possession at the time, say at Lady-day and Michaelmas. On many grazing farms, cattle were put on in the spring and taken off in the autumn. It would be well, therefore, to take it twice a year.

He had made this suggestion to Lord Spencer, who expressed himself as favourable to it. Supposing he had 300 head of cattle at Michaelmas, what was a shilling a-head to pay upon them? Just 15*l.*, a mere bagatelle. As to the premiums to be paid on foreign cattle, that, he might be permitted to say, was quite foreign to the subject. The only way to act was this: He would insure them by insuring their lives, and taking care that they did not come out of the slaughter-house.

It was a difficult question to decide upon; but he was entirely opposed to voluntary insurance, which would be partial in its operation. The system would leave the farmer entirely to the tender mercy of his neighbours, who would not insure, and thus there would be no real insurance at all.

Once more he must express his regret that the "stamping-out" system had not had a fair trial, though he admitted that many districts were much indebted to it.

MR. ALBERT PELL wished to say a few words with regard to Dr. Farr's proposal, for establishing a system of voluntary insurance.

DR. FARR: The plan which he had submitted to the Government was for the establishment of a compulsory or universal system of insurance. That which he had laid before the meeting was founded on the voluntary principle.

MR. PELL might be allowed to remind them, on this point, of the old proverb, which really had much weight in it, that "it is well to be off with the old love before we are on with the new;" and at this moment they were enjoying the benefits of a very wide and valuable system of compulsory insurance. The scheme, according to which the rinderpest had been dealt with by Parliament and the Government, was simply that of a compulsory insurance; the valuation premium not being ascertained until the animal was sick or dead, which was the best time for valuing it. That, in his mind, was a valuable plan to adhere to in such an emergency, and he should be very sorry indeed to relinquish in any way the existing method by which compensation was recovered in cases of loss, for another system based upon the principle of voluntary insurance. Whether in the course of time, when they had got rid of the plague, and things had returned to their normal condition, it would be advisable to form a general or larger insurance company, was a matter that required a great deal of consideration before deciding upon. Taking Dr. Farr's own figures, he should not himself, speaking from his own experience,

be inclined to take shares in any insurance company that offered him, at a cost of 11s. a year, compensation for any cattle that he might lose under ordinary circumstances; and for this reason—that his own returns of percentage loss of cattle showed that, out of 160 head of beasts his average loss at no time exceeded 60*l.* a year; and of late years, though a great many of his beasts were young animals, yet, by the exercise of care and attention, he had been enabled materially to reduce that percentage. He found that there were certain disorders to which animals were subjected, and by dealing with these promptly, his average loss was now diminished from ten beasts a year to five only.

He did not know how the existence of a system of general insurance would act on his own mind; but he feared that in such case it was human nature to be exceedingly careless, and that men would be deterred from applying their minds to the prevention and cure of disease.

So far as the rinderpest insurance was concerned, they had it now distinctly under the Act of Parliament. It was a safe insurance. It had operated well; and he should be very sorry indeed to see any scheme of voluntary insurance, which should set aside the vantage ground on which they now stood, substituted for it. Perhaps he might be allowed to make a remark upon one point to which Dr. Farr had referred, and that was the distressing subject of a guarantee fund. To him that would be most objectionable. Dr. Farr suggested that the noblemen and gentlemen of the county should furnish a guarantee fund. But this he (Mr. Pell) thought would put them in an invidious position. Such assumptions should not be mixed up with positive facts deduced from mathematical reasoning. It was not fair to mix up the two. Many gentlemen would resent with spirit a proposal which might brand them as curmudgeons if they did not lend their aid. Another effect of such a scheme would be that from a fear of public opinion others might come forward, and give beyond what there was any just claim upon them for. In December last a very large meeting was held at Northampton, and the idea of the guarantee fund was eagerly seized upon by the great body of persons in the room, and in the end they came to this: Let those who don't choose to give go home and keep their money in their pockets. The result was that a nobleman who was present said that if that was to be the shape the thing was to assume he would have nothing more to do with it. He thought, therefore, that the mixture of a guarantee fund, with the raising of money on mathematical considerations, was a very bad one. On the whole, he should be sorry to see the plan of Dr. Farr adopted to the loss of the vantage ground they now occupied under the action of the Government measures.

Mr. FINLAY DUN was surprised to hear Dr. Farr speak of rinderpest as if it were an epidemic disease; he should be sorry if that remark led any one to suppose that it might from time to time spring up spontaneously.

Dr. FARR said he had not intended to convey that idea.

Mr. FINLAY DUN. That the disease depended on contagion was the

fundamental fact on which were based the arrangements which were made by the legislature for slaughtering, and which had been carried out with tolerable efficiency throughout the country, for the purpose of stamping out the disease. While the number of cases that occurred weekly was now reduced below a thousand, it was important to bear in mind that only fifty-one weeks ago there were hardly any cases at all in this country, and that there should therefore be no relaxation whatever in the pains and care bestowed in endeavouring to thrust out the disease. He was sorry to hear Dr. Crisp's observations, charging with inefficiency the class of gentlemen who had in so many instances been called upon to cope with the cattle disease—he meant, of course, the veterinary surgeons.

Dr. CRISP: Pardon me; it was of the non-veterinary surgeons that I spoke, not the veterinary surgeons, who, I believe, deserve the utmost praise.

Mr. FRERE wished to say a word by way of explanation on one point connected with the discussions on cattle plague. At the earliest meeting of the Society at which the subject was considered, Mr. Spooner called attention to a plan for giving compensation for animals which died of rinderpest. He (Mr. Frere) had reason to believe that that gentleman desired that his scheme should only apply to the case of animals which were lost before an Act of Parliament was passed authorising compensation, but he was not so reported; neither was he so understood at the time, or care would have been taken that in the 'Journal' of the Society it should appear that he referred only to such losses. Such losses would, he trusted, still be kept in view, and a desire manifested to give largely and liberally from private sources what might be necessary to supplement the national grants in the case of those who had not the benefit of the law of the land.

Major THOMPSON thought it was only during this summer that the subject under consideration could be handled with any chance of success. The plague might possibly soon leave this country; and then their chances of forming a national insurance company would fall to the ground. There would perhaps never again be so good an opportunity of carrying out such a project. On the importance of forming a society of that kind he need not dilate. He should like to know how a man who had lost a large portion of his stock by the cattle plague could be expected to invest the last remnants of his money, if he had any left, in the repurchase of fresh animals, unless he could insure his new stock, so as to be secure against fresh losses of the same kind. They all knew that farmers could not cultivate the land without stock. They must have stock to convert their straw and green crops into manure, for they could not grow corn without manure; and therefore he thought it was abundantly evident that an insurance office was much needed. There were some 26,000 farmers who had lost stock. Generally speaking, farmers invested a large portion of their capital in their occupations. There was no such seductive speculation as farming: there was always something to be done on the farm, and the tenant was always laying out his money. But if a farmer who had lost his animals could not purchase fresh

stock, he must leave the farm, and leave in it a great deal of his capital; and, considering that no less than 26,000 farmers were affected by the cattle plague, it was surely desirable to endeavour to avert that evil.

There were, he admitted, a great many difficulties connected with insurance; but he believed that, if the grand object were kept steadily in view, they would vanish. Dr. Farr would help them over the difficulties with regard to rates. He (Major Thompson) did not think the rates need be as high as some had supposed. As to fraud, he had great faith in the British farmer. He had seen a great deal of the farmers of this country; and he did not believe there was much cause for apprehension on that point. Moreover, generally speaking, if an animal were worth 20*l.*, the amount for which it was insured would be only 15*l.*; what temptation, then, was there to fraud? The office only allowed three-fourths of the value, or 11*l.* 5*s.*; and if to this there was added one-fourth of the salvage, the amount received would still be only a little over 12*l.* Let him instance his own case. He happened to be an owner of dairy stock—the most risky stock of all. He had to claim for 44 cows; and the amount which he claimed per head was 8*l.* 15*s.*, the cows having originally cost him, on the average, 22*l.* 10*s.* He felt perfectly certain that if the office had allowed him to kill his animals before they were attacked, which they would not do, his claim would have been considerably less.

When a disease like the rinderpest occurred, you could not expect to get more than 8*l.* per head from an insurance office; and the animals might be sold at a higher price than that. If they were sold for 8*l.* a-head, and you only claimed at the insurance office for half the number, the claim would be under 4*l.*: it would be 3*l.* 15*s.*, or one-fourth of the 15*l.* office value. In short, the claim would bear only a very small proportion to the value of the animal.

It was impossible to enter fully into the question of insurance at a meeting like that; but he felt sure that it would pay if the thing were done on a sufficiently large scale. He had always been opposed to small offices, on the ground that the expenses were too large in proportion to the amount of business done. When there was only a small breadth of country covered, there was great danger of the liabilities being too heavy to be borne; whereas, by taking in the whole country, the healthy parts as well as those affected contributed, and the premiums in one district made up for the casualties in another. Like Mr. Pell, he should be very sorry to see the Government arrangements done away with for the present, for the result would then be that if he were to buy a number of animals, and they were ordered to be slaughtered, he could look neither to the Government nor to an insurance office for compensation. No man would be willing to place himself in that position. There were in the United Kingdom 3,286,000 cows, the value of which, at 15*l.* per head, was 50,000,000*l.*, and, notwithstanding what had been said about the reluctance of farmers generally to insure, he felt quite sure that the owners of cows would almost all insure. If insurance answered in the case of cows, he was quite sure it would answer in the case of every other

kind of live stock in the healthy grazing districts, and on farms generally, and it would also answer with horses and sheep. As to Dr. Crisp's proposal that a veterinary college should be formed, where students might be educated in the art of curing diseases, he was afraid that before that object could be carried out the farmers might lose all their stock. No opportunity should be lost of forming a great national insurance office, which was required not merely for cattle disease, but for lung complaints and many other epidemics from which farmers were constantly suffering loss.

Mr. W. CLODE said the question whether insurance should be voluntary or compulsory did not affect the principle advocated by Dr. Farr, namely, the importance of a system of insurance. There were matters of detail which would, of course, have to be well considered; but these did not affect the principle involved in the discussion. Before, however, any general system was established, they must have some groundwork on which a good scheme of insurance might be based. They were lamentably ignorant of the diseases to which cattle were ordinarily subject. They knew that pleuro-pneumonia and other diseases constantly existed, but they did not know to what extent; and if a proper system of recording the diseases of animals prevailed, it would bring to light some important facts, and, at the same time, establish a basis for a good and safe system of insurance. The science of vital statistics, as applied even to human life, was of comparatively modern origin; but, thanks to Dr. Farr, our knowledge of this subject had been widely extended. There was nothing authentic, however, with respect to liability to loss incurred by live stock; and it was not creditable to this country that it should remain in such a state of ignorance on the subject. If this Society would, as a matter of public policy, advocate the collection and publication of cattle statistics, it might thereby lay the groundwork for a satisfactory system of insurance; and he believed that all our noted agriculturists and veterinary professors were in favour of these measures.

Professor SIMONDS could tell them most lamentable facts connected with the prevalence of ordinary diseases. While the records of these cases were scattered all over the country, they made no impression on the public mind; but if they were collected together and published periodically in a well-digested form, they would become a most valuable addition to the stock of information possessed by agriculturists.

Sir GEORGE JENKINSON said this was a subject on which he had bestowed considerable attention, in consequence of an insurance society having been established in the county to which he belonged, namely, Gloucestershire. A gentleman with whom he had acted, and who was well known in that room, Mr. E. Holland, had collected a number of statistics which tended to show that no insurance company could ever stand against a panic or an epidemic. Although the principle which Dr. Farr had advocated was a very sound one, especially as regarded human life, it was very difficult of application to the case of cattle. They all knew that farmers were, as a body, very lethargic. When a panic arose they might be very willing, and

even anxious, to insure immediately, but he believed that after the cattle disease had died away the proportion of tenant-farmers who would insure their stock would be scarcely one in a hundred, and therefore any great and sudden pressure which might come upon any insurance society would probably overwhelm it. The strength of insurance societies lay in the constant support they received, and in the fact that the healthy made up for the unhealthy; and if farmers insured under a panic, and ceased to insure after it, a society for the insurance of live stock could not prosper. One great obstacle he considered would arise from changes of stock, the animals being changed to such an extent by sales that identification would be a matter of extreme difficulty.

It was, however, very important that this subject should be well ventilated, and that the opinions both for and against insurance should be fully stated; for it was only in that way that a good system could be formed from the different theories that were propounded.

Major THOMPSON observed that identification might be secured by branding the horns.

The CHAIRMAN said there was no proposition before the meeting with respect to the question introduced by Dr. Farr, but he must say that the manner in which that gentleman had treated it showed how deeply and carefully he had studied it. The subject was most difficult, and he for one would not venture to urge the Council of the Royal Agricultural Society to adopt Dr. Farr's plan. It was far from being perfect at present, and would require a great deal more consideration before it would be in a fit state for adoption by the Council. He had, however, great pleasure in proposing a vote of thanks to Dr. Farr for his paper.

Mr. TORR, in seconding the resolution, deprecated the notion that the Council in fixing the subject for discussion contemplated any immediate steps with a view to the establishment of a general insurance system, adding that something might possibly be done when the rinderpest was gone.

The motion having been put and carried—

Dr. FARR, after returning thanks, reminded the meeting that he had submitted two plans, one of which, if adopted, would have to be carried out by the Government. He concurred in a great deal of what had been said about the difficulty of carrying out the voluntary principle in relation to insurance. As regarded a compulsory system, whereas Mr. Torr said he would take 1s. at first, he (Dr. Farr) would take 2s., and power to come again should more be required. As under the present system the Government only had the right to order the slaughter of animals, farmers could only look to the Government for compensation. He believed that the power extended only to October next.

Professor SIMONDS: Only to August.

Dr. FARR continued: Of course there would be application for its further extension. If the Government ordered animals affected with rinderpest to be killed, the Government must pay for them; but if animals died naturally from pleuro-pneumonia or other diseases of similar character, the owners could not expect the rest of the com-



munity to bear the loss, any more than they could expect them to pay their premiums for insurance against fire. Not long ago, farmers instead of insuring against fire had begging collections to save them from losses arising from that cause: but now they were insured to the extent of 70,000,000*l.*, and he felt sure that if they found that it was their interest to insure their live stock they would do it in time. But they must be educated on the subject of insurance by means of discussions of that kind. Everybody knew that farmers were, as a body, as acute as any men in the world, and they must in time see what was their own interest in this matter. He put his paper before them for consideration, and he asked them to take into account the facts there presented. He fully concurred with Mr. Clode that the Royal Agricultural Society might, without committing itself to any scheme, ask the Government to obtain a complete return of all the diseases of cattle in different parts of the country.

---

*Meeting of Weekly Council, Wednesday, June 20th.* LORD FEVERSHAM  
in the Chair.

SHEEP *versus* CATTLE.

Mr. TORR said: In introducing this question to the notice of the Society, allow me to observe that I take for my motto the old Dutch proverb, "The sheep wears a golden foot," and that it is not my intention to read what may be termed "a paper" respecting it, inasmuch as I entertain strong objections to everything in the shape of paper farming. I shall merely start some points generally in favour of sheep *versus* cattle (if you like to call it so) for your consideration and discussion. I will not go into any description of the different breeds of sheep, nor draw any invidious comparison between the Leicester and the Lincoln, the Southdown, the Shropshire, and the Improved Oxford, believing, as I do, that an intelligent farmer should know what suits his own mode of farming and occupation best. It is extremely difficult to distinguish the various improved breeds, and far more than even the breeders themselves can do, to determine where one tribe ends and another begins. I therefore disclaim any prejudice in favour of a real good pure-bred Leicester, of substance and constitution, though he seems to have done great service wherever he has gone amongst the long-wools of the nation: whilst, as far as I have seen, no admixture has done aught but harm to this Bakewell breed itself. It is my sacred resolve, therefore, to keep the Aylesbury flock pure, as it has been now for something like eighty years.

These preliminaries being settled, I think that at the present moment, when that awful scourge, the cattle plague, has denuded of their stock many districts of the kingdom, the consideration how that stock is to be replaced is of paramount importance. Cattle are of slow growth. Say you want a three-year-old, you must wait four years, and then the supply will be limited, so many females having been swept off the homesteads.

I, however, hold an opinion, confirmed by practical experience, that on all second-rate grass lands sheep have been and can be made far more profitable than cattle; and in the improved state of such lands by draining, &c., sheep can now flourish and do well, where in former times it would have been folly to have placed them. There is not a greater improvement in farming than an allowance of oilcake to grazing sheep. I have used oilcake largely, both for cattle and sheep on first-rate land, and sold bullocks last year under four years old at 45*l.* each from grass. Mind you, the land was worth over 100*l.* per acre, and the beasts had 8 lbs. of oilcake per day, and they paid well for their summer grazing. This system only applies, perhaps, to feeding off the cattle or sheep more quickly, and on real good pastures; on second-rate land young steers are urazed, without the oilcake, mixed with sheep. Now it is here that a vast improvement may be made, simply by increasing the number of sheep and lessening the number of cattle—thus, say, instead of having one steer on two acres, and two sheep per acre, we put one steer on four acres, and four to six sheep per acre, and give the sheep oilcake. This opens a large field, and in all tolerably dry districts it can be done to greater profit, as will eventually be found, than the absurd process of breaking up grass land because it does not improve. Why, how can it do so if farmers won't do anything to it? This I know too well is often the case in my own immediate neighbourhood. The next, and perhaps a greater necessity is that of keeping sheep on the cold, strong lands of England—supposing such lands have been well drained, without which it is useless to suggest any improvement of the sort. The drains on grass land need more expense, because they should be as deep, and more close, even than on tillage, which has advantages as to percolation and atmospheric influence from cultivation, especially with the use of the steam plough.

When the water is thoroughly taken out of grass land, and you dress with almost anything, say common wheat-chaff, cut straw, lime and salt, or, better still, a few crushed and rotten bones, and put on plenty of sheep, with oilcake, the change is magical, (as I could show you on many a score of acres in my own occupation,) this management befitting almost all the second and third rate grass land. I aver that now is the golden opportunity for putting this great—I may say national—experiment in practice; fewer cattle and more sheep, and larger remuneration for the tenant.

I have not had very great experience myself in keeping a large number of sheep on cold clay lands, because that is not the character of my farms—I am in a much better position in respect of sheep. I shall, therefore, refer to the practice of Mr. Charles Randall, who carries it out better than anyone I know; and I shall speak of his experience in detail, and tell you exactly how things are done on the estate of the Duc d'Anmale, at Chadbury, near Worcester. 1st. Where the land is exclusively in grass. 2nd. Where there is some arable land, or where some of the grass land may be broken up. And I shall assume that it is strong land, because there is no need to tell people how to grow food for sheep upon light land.

As to the first, I believe there is no mode of sheep farming practicable but to buy in ewes, sell off the lambs, fat as many as can be made so, the rest as stores, then feed off as many of the ewes as are too old, or otherwise unfitted, to breed again. Lambs cannot be wintered with any certainty of success upon grass land, more especially where that grass land has been thickly stocked with sheep during the previous summer. Assuming, then, that this is to be the sort of sheep management adopted, the question is how to keep the greatest number in the most profitable manner—or, in other words, how to make the most money per acre by them. Three-fourths of the land should be kept entirely free from stock from the end of October, by which time the rams will be taken from the ewes, until the lambing begins. On the other fourth the ewes will be wintered, hurdling it over as a green crop, at the rate of about one quarter of an acre per day to 100 ewes, and giving with it sufficient hay, cut into chaff, to keep them in condition. When near to lambing,  $\frac{1}{2}$  lb. of oilcake per day should be given to each; or, if the grass land is poor, this may be done throughout the winter with benefit both to the land and sheep. The land upon which the ewes have been thus wintered should then be mown. As the ewes drop their lambs, turn them into the fresh pastures, continuing the daily  $\frac{1}{2}$  lb. of cake with a little hay-chaff. When about a month old, the lambs will try to join the ewes at the troughs, and then a small piece of the field should be hurdled off, and a little oilcake and chaff placed in low troughs, the lambs having access to them by means of a "lamb-gate"—viz., a hurdle with upright revolving bars, 9 inches apart. As the lambs take to the cake, the allowance to the ewes must be reduced, so that the  $\frac{1}{2}$  lb. per ewe will not be exceeded for ewe and lamb together. In this way one-third more ewes and lambs may be kept upon the same land than could be maintained in good condition without assistance. A larger proportion of the lambs will be ready early for the butcher, making the best price; and such as do not get fit to kill will pay for their cake by being strong, healthy stores. Every grazier knows that such lambs will go on and thrive with little risk or loss; while he equally well knows that little stunted scouring lambs are dear at any price. The ewes will be in forward condition, and may soon go to the butcher, making room for a new lot; and the land will, by this consumption of cake, gradually and certainly become capable of keeping a greater stock.

The chief objection to this kind of sheep farming is, the having to buy in annually fresh ewes; for, be it remembered, they are not sold for their good qualities—they are either old or ill-formed, have lost a quarter, or are otherwise bad sucklers.

To obviate this objection I will adopt the second proposition: If there is no arable land, break up some of the grass land—the worst—breed and feed off the wethers at a year old and the draft ewes, keeping on the ewe lambs for stock. The management of the ewes and lambs will still be much the same up to the middle of June, after which time the lambs must depend upon the produce of the

arable land. They cannot be made to do well after they are weaned upon the pastures where they have been kept with the ewes.

Assuming, then, the worst—that the land in tillage is clay, the crops to be grown upon half of it (the other half alternately being wheat) will be mangolds, cabbages, kohlrabi and vetches. These crops may with certainty be grown upon clay land, where it is always difficult, and sometimes quite impossible, to grow swedes or turnips. In the northern portion of the kingdom, where the climate is more favourable to the latter crops than to mangold, these would be substituted. At present we leave the men of the “far north” to take care of themselves, as they are well able to do. The vetches will be useful to put the yearling ewes upon, and the old ones when their lambs are weaned, and should be eaten through iron hurdles. While this crop is being got through, the pastures will get fresh, the best of them to feed off the draft ewes, the others to carry the stock ewes till tupp'd. Of kohlrabi a few acres should be grown and stored as mangolds, *i. e.*, with their roots and crowns left on, and covered with soil only, and kept until a fortnight before the ewes begin to lamb. These pulped and mixed with chaff will greatly improve the milk, and should be continued after the ewes have yeaned, until an abundance of grass makes them no longer necessary. Early cabbages, planted in October upon wheat stubble, well mashed, will be ready when the lambs are weaned, and with them must be given some hay-chaff, and to the wether lambs  $\frac{1}{2}$  lb. of cake; some cut mangold of the previous year (for these may be kept till July) may also be added, and will make the cabbages last out as long as may be necessary. The late York and drumhead cabbages will succeed the early ones, and carry on the lambs until it is time to plough up the land for wheat and put the lambs to mangolds. This should be done in yards; the roots being pulped and mixed with wheat-chaff, and wheat-straw cut into chaff. If a little hay can be spared to mix therewith so much the better, but it is not essential. It is quite necessary, however, that feeding sheep should have cake or corn (the former the better), and hay-chaff mixed with it. Malt coombs and bran are useful additions, where they can be bought at 5*l.* per ton. In this way all the wheat-straw that is not required for cutting in chaff will be converted into good manure, and in order to economise the straw it is well to cover the yards one foot, and the shedding two feet thick, with burnt soil. It will very rarely happen upon a farm such as we are assuming that clay cannot be found to burn. There is usually plenty of such raw material to be obtained from road-sides, hedge and ditch banks, borders, &c. The portion of this with which the open yard is bottomed will absorb the urine, and improve the quality, while it increases the quantity, of the dung-heap, and that which goes *dry*, as it should do, into the shed, must be turned as often as required until it becomes so saturated with dung and urine that turning no longer provides dry bedding for the sheep. It is desirable, then, where practicable, to cover these ashes over with fresh ones, but this cannot always be done. Carting upon that sort of land in winter is a

question of frost or no frost ; but it is not material beyond the saving of straw. If fresh ashes cannot be obtained, straw must be used upon the old ones. When the feeding is over, they are useful, mixed with superphosphate, to apply by the drill to the green crops.

It must not be supposed that the sheds necessary for this purpose are expensive erections. A thatched roof upon posts five feet high, the spaces between the posts on the north side being filled in with two rows of wattled hurdles, one on each side of the posts, and rammed between with straw, is all that is required.

Such is the practicable experience of Mr. Randall with a large flock of sheep on a very cold clay soil, a soil that is a good deal below the average of land which may be termed sheep land. Of course, I need hardly say he has not a large number of cattle ; but he has a considerable lot of sheep—sometimes from 600 to 800 feeding sheep.

Here let me put on what I call the crowning point of wool, now the staple, not only in a mill but on a farm. Sheep, as it were, standing still, grow wool ; and at anything like late prices of this article, and under a certain zone of latitude, it is doubtful whether a wether could not be more than self-supporting, by yielding annually his fleece, and thus pay a profit for two succeeding summers. This I advance not against early return and maturity, but to illustrate my views as to the advantages of sheep under favourable circumstances. To take another point, a friend of mine, who has had 18 sheep of me during the past 18 years, and has engaged the 19th ram to put on his old time-honoured Lincoln flock, realized at the April fair of Lincoln 5*l.* each for 200 hoggets, barring a “tenner” returned for luck. Well, now you have here, say three hoggets, making 15*l.*, *versus* a very good year-and-a-half-old steer, or, in many counties, a two years old. Just, for one moment, see the great disparity in value. Referring to use of artificials ; these hoggets, of course, had all they liked, and a little more, in their feeding-troughs : my bullocks had not quite their fill. Still, I freely admit, the profit is on the Improved Lincolns, and not on the Shorthorns, or any of the other cattle tribes.

I was going to say something about the soil on which wool grows best. On my own farm I find that I can grow better wool on some portions of it than on others. In the south of Lincolnshire, about Spilsby, wool grows in a most extraordinary manner ; if you go further north, say as far as Fifeshire, or further south than the English Channel, the quality of the wool falls off. It then becomes hair or moss. The valuable fine lustre wool is pretty nearly confined to a few degrees of latitude, not only in England, but nearly all over the world. So that the space being limited, there is little or no danger of wool ever glutting the market any more. The present unjust warfare, however, is against its price ; but on this I will not dwell. Wool will ever bear a great value ; and even if 800 sheep be kept where 600 were kept formerly, there are 800 men, and far more, perhaps, in comparison with the 600, who now wear a good broad-cloth coat instead of miserable fustian ; and so it will continue to be. And let me add to this requirement of the outer man, that the inner

man tends to a mutton chop against a dear piece of roast beef, for reasons that the Inland Revenue could explain.

Now, to reply to objections before I hear them. The foremost of these will be, no doubt, "What will you do with your straw?" This does not apply to the cold lands of England, but to that large portion where it has ever been considered that a man farms best by having most cattle to consume the straw and convert it into manure, and by being, generally speaking, a large sheep farmer as well. Take the east of England as an illustration. But to the question—"What will you do with your straw? I cannot tell you *in toto*, but I can show you in part; and as many men are of many parts, I hope other men will try to find out more than I have done. I keep all my cart-horses on straw, or preciously near so, as fodder; and they are in the stable or fold-yards 365 days in the year. A tremendous lot of straw can most advantageously be got quit of in this way. I have at present about 60 horses consuming 1 peck of crushed corn or sprouted barley, and 2 lb. of oilcake daily. I have no sick horses—not one per cent. They live too long, and won't die; so I kill them for the kennels at Brockleby. I am no horse dealer, and know less than nothing of that crafty craft; but I do know that one of the big blots of bad farming is the turning out of cart-horses on grass lands. Not even steam cultivation or aught else can remedy the harm occasioned by this folly or mismanagement.

Next, as I have said—and, perhaps, to many it is a new saying—cart all your chaff from the thrashing-machine on your grass lands at any time, and in any quantity, as may be convenient; and the early worm will ever be conveniently hard by, to help to fertilize. Further, in case of a repletion of straw, I believe a large quantity might be cut into chaff, and placed between the ridges of turnips planted at the ordinary width of twenty-seven inches apart, where it would act as an absorbent of all urine, &c., on sheep farms where no grass land can be had.

Mr. DENT, M.P.: When the sheep are eating it off?

Mr. TORR: Yes, on light lands, between the ridges of turnips. I have some done in this way, though not to a great extent. But you may apply an immense quantity of chaff to grass lands, and that with wonderfully good effects. At all events, in a good farm, some big stacks of old straw may thus be well disposed of. Some may think this a wild suggestion, who have never been bothered with too much chaff. Only don't burn it, and give your neighbours the benefit of the smoke. Surely, many will criticise these conceits, as they may be called, and say, "Why not sell the straw?" Near to a town this may do; but the landlord has a clear right to see that, although "straw is only straw," a poor farm is not made yet poorer by waste. Too great advances cannot be made to the root crops, either on the lightest or heaviest soils, care being taken that all the produce, or as near as may be, is returned to those soils. Hence I have ever argued that this is the best mode of *placing* manures.

To conclude: What I maintain is, that all farming should hold sacred the indestructibility of matter. The world weighs now, as

philosophers tell us, to an ounce what it did when Adam was a farmer. A cigar smoked, if all could be again collected, would be the exact weight of the pennyworth of tobacco. If these broad principles had been kept in view in ancient times, when Carthage was the granary of Rome, and its marshes afforded food for man, instead of pestilence, I venture to assert that they would never have been exhausted. I therefore refer to these principles in this my conservative attempt to prove that Britain may help herself even under the present direful dispensation of Providence.

MR. FRERE: In speaking of lamb gates, Mr. Torr mentioned revolving side bars; I would suggest that a revolving top bar would be found serviceable, particularly with ram lambs. As to the general subject before us, I profess to be a sheep farmer with a dry soil and climate; it has been my study to increase my stock; and my flock is now, I believe, nearly half as large again as that which in old times it was imagined that the farm could possibly carry, for I keep 15 score breeding ewes, whereas my right of sheep-walk has been restricted to 11 score, as the outside number that could fairly be "*levant and couchant*" on the farm.

To accomplish this object I grow more root crops, and pay special attention to autumn cultivation; take out the manure in winter for roots, and sow the earlier green crops on the wintered surface soil. The bulk of my farm (managed on the four-course) is so ordered that two long shifts, one of seeds, the other of roots, are always side by side. Of the increased root crop nearly one third is drawn and consumed on the sound dry layer close by. With an increased stock of sheep, and especially lambs, one obstacle is always encountered—the evil that arises from over-stocking.

And here, if I may digress for a moment, it would be to caution those who thought that they could substitute a large for a small stock of poultry with advantage, forgetting the evil of the land becoming tainted.

In order to keep a larger number of sheep, I naturally have recourse to a larger consumption of straw as well as of corn. My barley straw produces the best straw chaff; that which is cut by steam-power (with Maynard's cutter) being best adapted to sheep, as being shorter and softer to the touch. Instead of growing 100 acres of wheat and 100 acres of barley, I grow 140 acres of barley and 60 of wheat. Thus I have only 60 acres of wheat to sow in the autumn; and horse labour, which under the old system would have been appropriated in the autumn to the wheat-crop, is now used in preparing for the earlier root crops, early rape, mangold, and kohl-rabi.

Thus I had 40 acres not broken up in the autumn for wheat. Upon that clean lair from one-fourth to one-third of the root crop would be fed, even perhaps by younger sheep, during October, November, and December. At the end of December it was stirred by a cultivator to as small a depth as might be, and worked fine before the main winter frosts came. It should be in that state during the month of January probably, while the manure was being carted on for the mangold in the time of frost, and after it had been thus exposed to frost,

it would be ploughed an inch or two more deep; and then it should lie again for three or four weeks, to get quite fine before the time for barley sowing arrived. In that way I have succeeded in obtaining two pieces of as fine barley as I have ever seen in my neighbourhood. Of the 140 acres of barley, the straw of 100 will probably be consumed by the animals, chiefly sheep—it certainly was so last year. Our stock of straw was so short that we were compelled to thrash the barley rather fast, to meet the requirements of the sheep.

The chief drawback which I find is, that on the drier part of my land the straw manure has a special value for the turnip crop as a source of moisture. In a very dry year white turnips, when they were put in with straw manure in July, were able to stand drought, while those which had had artificial manure, though they came up well, died off. This difference I am inclined to attribute to the very fair supply of water which was gradually drawn up from below after the ploughing in of from 8 to 10 tons of straw manure, three-fourths of which is composed of water. But straw manure is also required for the growth of wheat on light lands. The one element in the straw required on light lands, which we do not seem able thus far to replace satisfactorily, is potash. So far as my experience has gone I have not found potash in any artificial form which would serve as a substitute for the potash in yard-made straw manure.

I have thus endeavoured faintly to trace the modifications made in my farm management so far as they bear on the subjects before us. Of course, a decrease in the number of bullocks in the yard is a natural if not a necessary consequence of the increase of the sheep stock, and of the consumption of straw as food. The drawbacks connected with the change of system are that I still want straw manure for my wheat crop and turnip crop on my light land; if the soil were more of a clay I should be more independent.

Sir GEORGE JENKINSON: Don't you think that yard-made straw manure is most essential on heavy land?

Mr. FRERE said, according to his experience, it was not. His farm bailiff used to think that without straw manure he could not grow mangold on stiff land; but one or two years' trial of artificial manure so satisfied him that after that, he said, he did not care to have farm-yard manure for that crop.

Mr. DENT said there could be no doubt that in a large portion of the Wolds of Lincolnshire and Yorkshire the idea prevailed that farmers could not properly dispose of their straw unless they had plenty of cattle to convert it into manure. Nor could it be doubted that, owing to the losses recently sustained, there would in many cases be great difficulty in procuring bullocks to make the straw into manure. There had, indeed, been great difficulty even in the last winter. Then came the question how far they could make good straw-manure with sheep. He was inclined to think that in many of the districts where large quantities of turnips were grown, ewes had, as a rule, had far too many turnips and far too little straw. His own experience of his flock of sheep was, that the fewer turnips the ewes had, after being removed from the tup, the healthier they were, and the better they did



altogether; and the same remark applied to the lambs. The desirableness of keeping breeding ewes in a yard, and turning them out for a portion of the day, giving them pulped roots mixed with straw and dry meat, was, he should imagine, tested to some extent last winter; and, for his own part, he thought that would lead to a solution of the difficulty of keeping a breeding flock on strong land where there was very little grass. On his farm he had never found any superfluity of straw, while at times he could certainly have used more than he had with advantage. As regarded cart-horses, he never thought of turning them out to grass, and he believed that that was one of the greatest mistakes a farmer could make, as nothing scarcely did grass-land so much harm. There were constant battles and arguments with farmers on that subject. They said that tares were very expensive to grow, but he did not himself believe that. His plan was very much the same as that which Mr. Torr had spoken of; he gave chopped straw all the winter, open straw as long as he had any, and at this time of year plenty of tares and an allowance of corn and chopped dry meat.

Sir George JENKINSON remarked that that plan could not be carried out with young horses.

Mr. TORR: Yes, it is just the same thing.

Mr. DENT continued: He was speaking only of farm-horses. He had always considered sheep and bullocks far preferable to horses as stock. To have hoggets carrying on their back fleeces which could be got rid of at the end of the year was far better than having horses from which no profit could be got until they were three or four years old. As regarded Mr. Torr's idea of using chaff on grass lands, he had seen a little of that tried with very good results. Almost anything, in fact, that was put on grass lands would do good. But he did not himself see any great objection to allowing straw to be sold, provided the landlord saw that compensation was made in the manure that was purchased. He thought that on the class of farms where there was a superfluity of straw, and the landlord might be satisfied that there was a sufficient quantity of good linseed-cake or good artificial manure bought to replace the straw, the sale of straw was not so objectionable as some landlords and some land-agents had seemed to think, especially in the neighbourhood of towns, where straw fetched a high price.

What was read by Mr. Torr respecting Mr. Randall's management of sheep was very valuable; and he (Mr. Dent) was surprised that, after the system was placed before the members of the Society by Mr. Randall himself, it was not carried further by the strong land farmers than it had been hitherto. He would throw out a suggestion whether they might not keep an increased quantity of both cattle and sheep, by keeping cattle in the summer in yards, and so freeing the grass lands for the ewes and lambs. As to the difficulty of keeping lambs on grass lands in winter, he would remark that he had seen some lambs in that position and receiving cotton-cake, and, though there had been very few losses when he left the country, the result did not appear to him satisfactory. The

animals had a poor, weakly, and unhealthy look; and his experience was that the system was not satisfactory, either as regarded the produce of wool or the growth of the sheep. In conclusion, he would remark that Mr. Torr's lecture was a very suggestive one, from which a great deal might be learnt.

Sir George JENKINSON would like to know why Mr. Frere did not recommend straw manure for clay land. His experience was that, although you might possibly grow—he had done so himself—as good a crop of mangold with artificial manures, such as superphosphates and guano mixed in proper quantities, yet on very stiff clay straw manure opened out the clay and tended to make it more friable in future years. Straw manure opened the pores, so to speak, more than artificial manures, especially if the crop were fed off, on the clay. He held a very strong opinion against the advisability of feeding off grass with sheep on strong land, believing that, by trampling down, the animals caused great loss. That brought him to another question. He would ask Mr. Dent what kind of grass land it was, on which he had observed that lambs did not winter well? For if Mr. Dent's principle applied universally, and if his own experience and that of others who farmed clay land were to be relied upon, it followed that they could not keep lambs anywhere. His (Sir G. Jenkinson's) experience in keeping lambs on clay land last winter was, that in feeding off his root crops he lost a tremendous proportion. Lord Ducie's steward told him that his own experience was similar, and said that he regarded it as nothing less than madness to attempt to keep lambs on clay lands during such a winter as the last. It seemed, therefore, he repeated, that they could not keep lambs anywhere.

Mr. DENT: Yes, you can keep them in yards.

Sir G. JENKINSON: There, again, they come to the question of straw, including the sale of straw; and he considered that if tenants were allowed to sell straw, the means of keeping winter stock in the yard were thereby diminished. He would ask Mr. Dent to state what evil he had found to arise from wintering lambs on dry grass land, giving them corn and chaff? His experience, though he did not wish to put it against Mr. Dent's, was that that was the best way of wintering lambs. He had tried it in yards, he had tried it on the ploughed land, and the result of his experience, which came through his pocket, was that the safest way of wintering sheep was to winter them on dry grass lands, with chaff and corn, not giving the ewes any roots at all till after the yearning time.

Mr. WELLS said he had lately changed his farm. Five or six years ago he lived in Kent: he now had a farm in Huntingdonshire, and nothing was clearer to his mind than that in some districts it was not possible to have a breeding flock, while in others it answered. In Kent he kept a breeding flock in opposition to the opinions of his bailiff, but the result was not satisfactory. He now thought he could see his way to the carrying out the experiment of keeping a breeding flock successfully. His neighbours kept excellent flocks of large Lincoln sheep, and he hoped to do the same. He mentioned

this simply to support Mr. Randall's principle, that on some clay soils it was fighting against nature to force a breeding flock, and he should recommend no one to try it.

Mr. STRATFORD observed that the question under consideration was very closely connected with the influence of climate. He recollected a period when Lord Ducie had one of the best breeding flocks in the kingdom, but it soon showed a remarkable deterioration. In Cambridgeshire Mr. Frere had not half the amount of water that fell to the lot of Lord Ducie and most of the West of England farmers, who were compelled to keep their sheep to a great extent in yards. Mr. Randall might be said to farm in the midland district, and in considering cases like his it was desirable to keep in view the differences of climate and moisture.

The CHAIRMAN had great pleasure in moving a vote of thanks to Mr. Torr for his kindness in coming forward and delivering so interesting and important a lecture. He should like to make a few remarks, but would not trespass upon their time at any length, especially as the subject turned chiefly upon heavy lands, of which he had not had much experience. He found that it was extremely advantageous to keep up a good breeding flock of sheep. In fact, he had two different kinds—Southdowns and Leicesters, and he found both useful—the latter for wool, and the former for mutton. He concurred in the observation of Mr. Torr, that the best way to keep them forward for early maturity and in good condition was to feed them abundantly upon oilcake when in the fields; and he could not agree with Mr. Dent in the advisability of keeping cattle in yards during the summer; it was far more conducive to the health of the animals to turn them out to grass, and more in accordance with nature. Indeed, he believed that it was greatly owing to the two last seasons being very dry ones that the cattle disease had prevailed so extensively, although he admitted, at the same time, that it might have been materially checked in some parts of the country, if due precautions had been taken in the first instance. It was a remarkable fact that the high breeds of cattle—the “pedigree” breeds as they were termed—had been entirely free from the pestilence. He could answer for his own, for the Duke of Devonshire's, and for many others; and he should be extremely sorry, whilst agreeing that sheep were of the utmost importance to cultivate, improve, and increase in quantity, if in consequence of such an increase the cattle of the country were to be sensibly diminished. He knew perfectly well that sheep did improve the land, and were more profitable to the farmer: at the same time, it was of great importance to maintain our best herds of cattle, and he believed that the more farmers had the opportunity of crossing their cows with the best-bred bulls, the better and more profitable they would find it to be, and the more conducive to the continued fertility of the land. The meeting was greatly indebted to Mr. Torr; and he had much pleasure in proposing a vote of thanks to that gentleman for his lecture.

Mr. DENT seconded the motion, and explained that he had not recommended the indiscriminate sale of straw on farms. With regard

to keeping lambs upon grass lands, he had tried the plan two winters—once during nearly the whole winter, and another time up to the month of December—and he found an evident deterioration, and that the animals were not nearly so good as the wether lambs, which had been put upon turnips. Perhaps they had not quite such good keep; but, even with a fair allowance of corn and cake on the grass land, they did not do so well as the wethers. He came to the conclusion, therefore, that there was nothing like putting them on rape and turnips as soon as he could; for they not only began well, but continued well throughout the summer. As to keeping up breeding stock where there was a short supply of straw, they might grow tares and green crops for the feeding of beasts.

Mr. FRERE explained that he did not undervalue straw manure, but could more easily dispense with it on strong than on light land.

Mr. TORR, in acknowledging the compliment, said he had studiously avoided making any reference to the absence of rinderpest from large herds like his own, conceiving that it was not right to speak in terms of exultation on such a subject, because they could not be regarded as totally exempt from attack. The only reasonable ground which he could discover for their escape thus far was, that the shorthorn breeders of England had carefully abstained from dealing in cattle during the existence of the plague. For his own part, indeed, he had not purchased a single animal since the month of August last. The breeders had shut up all their bulls, and as their herds were extremely valuable, perhaps they had spent more money in the adoption of measures for their protection. He entirely agreed in the observations of Mr. Dent, with respect to keeping cattle in yards during a portion of the summer. Instead of taking them in as he used to do in the middle of November or even December, nearly all his steers were in his yards in September. They were not now turned out, as was formerly the practice in the winter, for days, and shut up at nights, but remained in the fold-yard until the middle of May. Thus the store-cattle were placed under a better system of management during four months more at least in the year. Twenty-five years ago he had seen the whole of the North-Riding of Yorkshire covered with cattle throughout the entire winter; but of late years that practice had gradually given way, and it was undoubtedly a very considerable improvement. With regard to horses, he was of opinion that all horses ought to be in fold-yards; not exactly in stables, but in yards, with one-third or two-sevenths of the surface covered in, and without a thoroughfare through them; he found that by the use of cut straw and tares he could make famous manure with a lot of young horses. Moreover, they were far better there than galloping about the fields. His cart-horses, in yards, supplied with cut straw and tares, did remarkably well. A good many years ago he kept his cart-horses almost entirely on sprouted barley, and with sprouted barley and oil-cake he found he could do without cut hay. The great object was to get muscle in a horse, and for that purpose sprouted barley was the best thing in the summer months, when they had not too many tares. In the winter, however, it was rather difficult to get

the barley to sprout. A word or two as to the use of oil-cake. His practice was for one boy to attend to four horses. Each boy was supplied with 8 lbs. of cake per day, dissolved in five or six buckets of water, and every feed of chaff given to the horse was saturated with the mixture. The result was that the animal ate his straw with a keener relish, and colic, as it was termed—which in reality meant obstruction of the bowels—was thereby effectually prevented. In winter a few turnips were very good. As to the question of sheep *versus* cattle, he might state that last year he wintered over 3000 sheep as against 300 cattle, and his experience was that for every 2*l.* he got from the cattle he realised 5*l.* by the sheep. The fact was that sheep were always returning money, no matter what the time of year.

LONDON:  
PRINTED BY WILLIAM CLOWES AND SONS, STAMFORD STREET,  
AND CHARING CROSS,

# Royal Agricultural Society of England.

1866.

## President.

THE RIGHT HONOURABLE LORD TREDEGAR.

## Trustees.

ACLAND, SIR THOMAS DYKE, Bart., *Killerton Park, Exeter, Devonshire.*  
BERNERS, Lord, *Keythorpe Hall, Leicester.*  
BRAMSTON, THOMAS WILLIAM, *Skreens, Chelmsford, Essex.*  
CHALLONER, Colonel, *Portnall Park, Staines, Middlesex.*  
FEVERSHAM, Lord, *Helmsley, York.*  
MARLBOROUGH, Duke of, *Blenheim Park, Oxford.*  
PORTMAN, Lord, *Bryanston, Blandford, Dorset.*  
POWIS, Earl of, *Powis Castle, Welshpool, Montgomeryshire.*  
RUTLAND, Duke of, *Belvoir Castle, Grantham, Lincolnshire.*  
SHELLEY, SIR JOHN VILLIERS, Bart., *Maresfield Park, Sussex.*  
SPEAKER, THE RT. HON. THE, *Ossington, Newark-on-Trent, Notts.*  
THOMPSON, HARRY STEPHEN, *Kirby Hall, York.*

## Vice-Presidents.

BARKER, THOMAS RAYMOND, *Hanbledon, Henley-on-Thames, Oxfordshire.*  
CHICHESTER, Earl of, *Stammer Park, Lewes, Sussex.*  
DOWNSHIRE, Marquis of, *East Hampstead Park, Bracknell, Berkshire.*  
EGMONT, Earl of, *Cowdray Park, Petworth, Sussex.*  
EVERSLEY, Viscount, *Heckfield Place, Winchfield, Hants.*  
EXETER, Marquis of, *Burleigh House, Stamford, Lincolnshire.*  
HILL, Viscount, *Hawkstone Park, Salop.*  
HOBBS, W. FISHER, *Boated Lodge, Colchester, Essex.*  
HOOD, Major-Gen. the Hon. A. NELSON, *Cumberland Lodge, Windsor, Berkshire.*  
JOHNSTONE, SIR JOHN V. B., Bart., M.P., *Hackness Hall, Scarborough, Yorkshire.*  
MILES, SIR WILLIAM, Bart., *Leigh Court, Bristol, Somersetshire.*  
WALSINGHAM, Lord, *Merton Hall, Thetford, Norfolk.*

## Other Members of Council.

ACLAND, THOMAS DYKE, M.P., *Spydoncote, Exeter, Devonshire.*  
AMOS, CHARLES EDWARDS, 5, *Cedars Road, Clapham Common, Surrey.*  
ARKWRIGHT, J. HUNGERFORD, *Hampton Court, Leominster, Herefordshire.*  
BARNETT, CHARLES, *Stratton Park, Biggleswade, Bedfordshire.*  
BARTHROPP, NATHANIEL GEORGE, *Hacheston, Wickham Market, Suffolk.*  
BOWLY, EDWARD, *Siddington House, Cirencester.*  
BURGESS WILLIAM, *Brentwood, Essex.*  
CANTRELL, CHARLES S., *Riding Court, Datchet, Bucks.*  
CATHCART, Earl, *Thornton-le-Street, Thirsk, Yorkshire.*  
CHESHAM, Lord, *Latimer, Chesham, Bucks.*

- CLAYDEN, JOHN, *Littlebury, Saffron Walden, Essex.*  
 CLIVE, GEORGE, M.P., *Perrystone, Ross, Herefordshire.*  
 DENT, J. D., M.P., *Rilston Hall, Wetherby, Yorkshire.*  
 DRUCE, JOSEPH, *Eggham, Oxford.*  
 FORTESCUE, EARL, *Castle Hill, Southamilton, Devonshire.*  
 GIBBS, B. T. BRANDRETH, *Halfmoon Street, Piccadilly, London, W.*  
 HAMOND, ANTHONY, *Westacre Hall, Brandon, Norfolk.*  
 HOLLAND, EDWARD, M.P., *Dumbleton Hall, Evesham, Worcestershire.*  
 HOSKYNs, CHANDOS WREN, *Harewood, Ross, Herefordshire.*  
 HUDSON, JOHN, *Castleacre Lodge, Brandon, Norfolk.*  
 HUTTON, WILLIAM, *Gate Barton, Gainsboro', Yorkshire.*  
 JONAS, SAMUEL, *Chrishall Grange, Saffron Walden, Essex.*  
 KERRISON, SIR EDWARD C., Bart., M.P., *Brome Hall, Scole, Norfolk.*  
 KINGSCOTE, Colonel, M.P., *Kingscote, Woolton-under-Edge, Gloucestershire.*  
 LAWES, JOHN BENNET, *Roilamsted, St. Albans, Herts.*  
 LAWRENCE, CHARLES, *Cirencester, Gloucestershire.*  
 LOPES, SIR MASSEY, Bart., M.P., *Maristor, Roborough, Devon.*  
 MACDONALD, SIR ARCHIBALD KEPPEL, Bart., *Woolner Lodge, Liphook, Hants.*  
 MILWARD, RICHARD, *Thurgarton Priory, Southwell, Notts.*  
 PAIN, THOMAS, *Ufford Cottage, Salisbury, Wilts.*  
 POPE, EDWARD, *Great Toller, Maiden Newton, Dorset.*  
 RANDELL, CHARLES, *Chadbury, Evesham, Worcestershire.*  
 RIDLEY, SIR MATTHEW WHITE, Bart., M.P., *Blagdon, Cranlington, Northumberland.*  
 RIGDEN, WILLIAM, *Hove, Brighton, Sussex.*  
 SANDAY, WILLIAM, *Holmepierrepond, Notts.*  
 SHREWSBURY AND TALBOT, Earl of, *Ingestre Hall, Staffordshire.*  
 SHUTTLEWORTH, JOSEPH, *Hartsholme Hall, Lincoln.*  
 SMITH, ROBERT, *Emmett's Grange, Southamilton, Devon.*  
 TOER, WILLIAM, *Aylesby Manor, Great Grimsby, Lincolnshire.*  
 TOWNELEY, Lieut.-Colonel CHARLES, *Towneley Park, Blackburn, Lancashire.*  
 TREDEGAR, Lord, *Tredegar, Newport, Monmouthshire.*  
 TURNER, GEORGE, *Beacon Downes, Exeter, Devonshire.*  
 VERNON, Hon. AUGUSTUS H., *Sudbury, Derby.*  
 WALLIS, OWEN, *Ocerstone Grange, Northampton.*  
 WELLS, WILLIAM, *Holmeewood, Peterborough, Northamptonshire.*  
 WESTERN, SIR THOMAS B., Bart., M.P., *Felix Hall, Kelvedon, Essex.*  
 WILSON, HENRY, *Stowlangtoft Hall, Bury-St.-Edmunds, Suffolk.*  
 WILSON, JACOB, *Manor House, Woodhorn, Morpeth, Northumberland.*  
 WILSON, Professor, *Icer, Uxbridge, Bucks.*  
 WYNN, SIR WATKIN WILLIAMS, Bart., M.P., *Rhuabon, Denbighshire.*

### Secretary.

H. HALL DARE, 12, *Hamover Square, London, W.*

*Editor*—P. H. FRERE, *Dungate, Cambridge.*

*Consulting-Chemist*—Dr. AUGUSTUS VOELCKER, 11, *Salisbury Square, E.C.*

*Veterinary-Inspector*—JAMES BEART SIMONDS, *Royal Veterinary College, N.W.*

*Consulting Engineer*—JAMES EASTON, or C. E. AMOS, *Grove, Southwark, S.E.*

*Seedsmen*—THOMAS GIBBS and Co., *Corner of Halfmoon Street, Piccadilly, W.*

*Publisher*—JOHN MURRAY, 50, *Albemarle Street, W.*

*Bankers*—THE LONDON AND WESTMINSTER BANK, *St. James's Square Branch, S.W.*



## STANDING COMMITTEES FOR 1866.

*Finance Committee.*

HOOD, Maj.-Gen. the Hon. A. NELSON, Chairman.	HOBS, WM. FISHER. RANDELL, CHARLES. TORR, WILLIAM.
BARNETT, CHARLES.	
BRAMSTON, T. W.	

*House Committee.*

THE PRESIDENT.	CHALLONER, Colonel.
CHAIRMAN of Finance Committee.	GIBBS, B. T. BRANDRETH.
CHESHAM, Lord.	HOBS, WM. FISHER.
BRAMSTON, T. W.	

*Journal Committee.*

THOMPSON, H. S., Chairman.	MACDONALD, SIR A. K., Bt.
CATHCART, Earl.	ACLAND, T. DYKE, M.P.
FORTESQUE, Earl.	HOLLAND, ED., M.P.
SPEAKER, The Rt. Hon. the	HOSKYNs, C. WREN.
SHELLEY, Sir J. V., Bt.	MILWARD, RICHARD.
JOHNSTONE, Sir J. V. B., Bt., M.P.	WALLIS, OWEN.
KERRISON, Sir E. C., Bt., M.P.	

*Chemical Committee.*

CATHCART, Earl.	HOLLAND, ED., M.P.
VERNON, Hon. A. H.	HOSKYNs, C. WREN.
JOHNSTONE, Sir J. V. B., Bt., M.P.	HUNTABLE, Ven. Archdeacon.
KERRISON, Sir E. C., Bt., M.P.	LAWES, J. B.
LOPES, Sir MASSEY, Bt., M.P.	THOMPSON, H. S.
ARKWRIGHT, J. H.	WELLS, WILLIAM.
DENT, J. D., M.P.	WILSON, JACOB.

*Veterinary Committee.*

HOOD, Maj.-Gen. the Hon. A. NELSON.	PAIN, THOS.
JOHNSTONE, Sir J. V. B., Bt., M.P.	SIMONDS, Professor.
BARKER, THOS. RAYMOND.	SPOONER, Professor.
CHALLONER, Colonel.	THOMPSON, H. S.
DENT, J. D., M.P.	VARNELL, Professor.
GIBBS, B. T. BRANDRETH.	WELLS, WILLIAM.
HOBS, WM. FISHER.	WILSON, JACOB.

*Stock-Prizes Committee.*

FEVERSHAM, Lord.	JONAS, SAMUEL.
WALSINGHAM, Lord.	MILWARD, RICHARD.
HOOD, Maj.-Gen. the Hon. A. NELSON.	PAIN, THOMAS.
BARNETT, CHARLES.	POPE, EDWARD.
BARTHOLOP, NATHANIEL G.	RANDELL, CHAS.
CLAYDEN, JOHN.	RIGDEN, WM.
DENT, J. D., M.P.	SMITH, ROBERT.
DRUCE, JOSEPH.	SIMONDS, Professor.
GIBBS, B. T. BRANDRETH.	TORR, WILLIAM.
HOBS, WM. FISHER.	TURNER, GEORGE.
HOLLAND, ED., M.P.	WALLIS, OWEN.
HUDSON, JOHN.	

**Implement Committee.**

CATHCART, Earl.	HAMOND, ANTHONY.
CHESHAM, Lord.	HOBBS, WM. FISHER.
HOOD, Maj.-Gen. the Hon. A. NELSON.	HOLLAND, ED., M.P.
VERNON, Hon. A. H.	HOSKYNs, C. WREN.
KERRISON, Sir E. C., Bt., M.P.	RANDELL, CHARLES.
MACDONALD, Sir A. K., Bt.	SANDAY, WILLIAM.
MILES, Sir WM., Bt.	SHUTTLEWORTH, JOSEPH.
AMOS, C. E.	THOMPSON, H. S.
ARKWRIGHT, J. H.	TORR, WILLIAM.
BARNETT, CHARLES.	WALLIS, OWEN.
CANTRELL, CHAS. S.	WILSON, Professor.
CHALLONER, Colonel.	WILSON, JACOB.
GIBBS, B. T. BRANDRETH.	

**General Bury Committee.**

Sir E. C. KERRISON, Bt., M.P., Chairman.	DENT, J. D., M.P.
POWIS, Earl of.	GIBBS, B. T. BRANDRETH.
CHESHAM, Lord.	GREENE, E., M.P.
FEVERSHAM, Lord.	HOBBS, WM. FISHER.
PORTMAN, Lord.	HOLLAND, E., M.P.
TREDEGAR, Lord.	HOSKYNs, C. WREN.
HOOD, Maj.-Gen. the Hon. A. NELSON.	JONAS, SAMUEL.
VERNON, Hon. A. H.	MILWARD, RICHARD.
BARNETT, CHARLES.	PAIN, THOMAS.
BARTHOOP, N. G.	RANDELL, CHARLES.
BOWLY, EDWARD.	SHUTTLEWORTH, JOSEPH.
BURY, The Mayor of.	THOMPSON, H. S.
BRAMSTON, T. W.	TORR, WILLIAM.
CANTRELL, CHARLES S.	WILSON, HENRY.
CHALLONER, Colonel.	WILSON, Major.
CLAYDEN, JOHN.	

**Education Committee.**

HOLLAND, E., M.P., Chairman.	FRERE, P. H.
FORTESCUE, Earl.	HOSKYNs, C. WREN.
POWIS, Earl of.	KINGSCOTE, Colonel, M.P.
WALSINGHAM, Lord.	RANDELL, CHARLES.
JOHNSTONE, Sir J. V. B., M.P.	THOMPSON, H. S.
KERRISON, Sir E. C., Bt., M.P.	WALLIS, OWEN.
ACLAND, T. DYKE, M.P.	WELLS, WILLIAM.
BARTHOOP, N. G.	WILSON, Professor.
DENT, J. D., M.P.	VOELCKER, Professor.
DRUCE, JOSEPH.	

**Show-Yards Contracts Committee.**

RANDELL, CHARLES, Chairman.	HOBBS, W. FISHER.
CATHCART, Earl.	SANDAY, WILLIAM.
HOOD, Maj.-Gen. the Hon. A. NELSON.	SHUTTLEWORTH, JOSEPH.
VERNON, Hon. A. H.	THOMPSON, H. S.
AMOS, C. E.	TORR, WILLIAM.
GIBBS, B. T. BRANDRETH.	

**Cattle Plague Committee.**

TREDEGAR, Lord.  
FEVERSHAM, Lord.  
WALSINGHAM, Lord.  
HOOD, Maj.-Gen. Hon. A. NELSON.  
VERNON, Hon. A. H.  
ACLAND, T. DYKE, M.P.  
BARTHOOPP, N. G.  
GIBBS, B. T. BRANDRETH.

HOLLAND, E., M.P.  
KINGSCOTE, Colonel, M.P.  
PAIS, THOMAS.  
RANDELL, CHARLES.  
SANDAY, WILLIAM.  
SIMONDS, Professor.  
THOMPSON, H. S.

\* \* The PRESIDENT, TRUSTEES, and VICE-PRESIDENTS are Members *ex officio*  
of all Committees.

## MEMORANDA.

**ADDRESS OF LETTERS.**—The Society's office being situated in the postal district designated by the letter **W**, members, in their correspondence with the Secretary, are requested to subjoin that letter to the usual address.

**GENERAL MEETING** in London, May 22, 1866, at Twelve o'clock.

**GENERAL MEETING** in London, in December, 1866.

**MEETING** at Bury St. Edmunds, in 1866.

**MONTHLY COUNCIL** (for transaction of business), at 12 o'clock on the first Wednesday in every month, excepting January, September, and October: open only to Members of Council and Governors of the Society.

**WEEKLY COUNCIL** (for practical communications), at 12 o'clock on all Wednesdays in February, March, April, May, June, July, and November, excepting the first Wednesday in each of those months, and during adjournment: open to all Members of the Society, who are particularly invited by the Council to avail themselves of this privilege.

**ADJOURNMENTS.**—The Council adjourn over Passion and Easter weeks, when those weeks do not include the first Wednesday of the month: from the first Wednesday in August to the first Wednesday in November; and from the first Wednesday in December to the first Wednesday in February.

**DISEASES of Cattle, Sheep, and Pigs.**—Members have the privilege of applying to the Veterinary Committee of the Society; and of sending animals to the Royal Veterinary College, on the same terms as if they were subscribers to the College.—(A statement of these privileges will be found in the present Appendix.)

**CHEMICAL ANALYSIS.**—The privileges of Chemical Analysis enjoyed by Members of the Society will be found stated in the Appendix of the present volume.

**LOCAL CHEQUES.**—Members are particularly requested not to forward Country Cheques for payment in London; but London Cheques, or Post-office Orders on Vere-street (payable to H. HALL DARE), in lieu of them. All Cheques are required to bear upon them a penny draft or receipt stamp, which must be cancelled in each case by the initials of the drawer. They may also conveniently transmit their Subscriptions to the Society, by requesting their Country Bankers to pay (through their London Agents) the amount at the Society's Office (No. 12, Hanover Square, London), between the hours of ten and four, when official receipts, signed by the Secretary, will be given for such payments.

**NEW MEMBERS.**—Every candidate for admission into the Society must be proposed by a Member; the proposer to specify in writing the full name, usual place of residence, and post-town, of the candidate, either at a Council meeting, or by letter addressed to the Secretary.

**PACKETS BY POST.**—Packets not exceeding two feet in length, width, or depth, consisting of written or printed matter (but not containing letters sealed or open), if sent without envelopes, or enclosed in envelopes open at each end, may be forwarded by the inland post, if stamped, at the following rates:—

For a packet not exceeding	4 ounces (or quarter of a pound)	. . .	1 penny
" " "	8 " (or half a pound)	. . .	2 pence.
" " "	16 " (or one pound)	. . .	4 "
" " "	24 " (or one pound and a half)	. . .	6 "
" " "	32 " (or two pounds)	. . .	8 "

[And so on in the proportion of 8 ounces for each additional 2*l*.]

\* \* Members may obtain on application to the Secretary copies of an Abstract of the Charter and Bye-Laws, of a Statement of the General Objects, &c., of the Society, of Chemical and Veterinary Privileges, and of other printed papers connected with special departments of the Society's business.

## Royal Agricultural Society of England.

---

### GENERAL MEETING,

12, HANOVER SQUARE, WEDNESDAY, DECEMBER 13, 1865.

---

#### REPORT OF THE COUNCIL.

SINCE the last general meeting, 1 governor and 43 members have died; the names of 5 members have been removed from the list by retirement or otherwise, 3 governors and 129 new members have been elected; so that the Society now consists of

78 Life Governors,  
84 Annual Governors,  
1,394 Life Members,  
4,261 Annual Members; and  
16 Honorary Members; making a total of  
5,833; being an increase of 81 names.

Mr. George Clive, M.P. of Perrystone Court, Ross, Herefordshire, has been elected a member of Council to fill the vacancy caused by the resignation of the Right Hon. Lord Leigh.

The finances of the Society are in a satisfactory condition, as is shown by the balance sheet to the 30th of June, which has been already published in the JOURNAL. In consequence of the large expenses attendant on the Plymouth Show, and the sum devoted to the purchase of show-yard plant, the Council has been compelled to sell out 2,000*l.* of the funded property, which now stands at 19,027*l.* 19*s.* 6*d.* in the New Three per Cents.

The plans and specifications for the show-yard works have been prepared by the Society's surveyor, and the Council trust that a considerable saving will be effected in the future annual cost of the buildings required at the Country Meetings. They have purchased from the former contractor a large portion of the

plant—consisting of portable buildings, turnstiles, exits, &c.—which was annually hired; and which it is calculated will last for some years. The acquisition of these has necessarily thrown a heavy charge on the funds of the Society this year.

The Governors of the Royal Veterinary College, in their Annual Report of the progress made at that Institution in the application of the veterinary art, and the treatment of the diseases of cattle, sheep, and pigs, state that the number of pupils qualified to act as practitioners in carrying out these objects of the Society continues to increase; but they regret that the members of the Society do not avail themselves more extensively of their privilege of sending diseased animals in a live or dead state to the College; thus furnishing means for the acquisition of a larger amount of practical experience by the pupils.

A special circular was prepared by the Veterinary Committee and forwarded to every member of the Society, drawing attention to the distinctive symptoms of the Cattle Plague, in order to assist the members in distinguishing between it and the Pleuropneumonia and the mouth and foot disease. The circular also set out the precautions which the Committee at that time recommended to the attention of agriculturists.

The Plymouth Meeting has been one of the largest in point of receipts ever held by the Society, although a General Election was going on throughout the country at the time. The Prince and Princess of Wales were pleased to honour the Society by a visit to the Showyard on Wednesday the 19th July, which added considerably to its success. Their Royal Highnesses were pleased to express to the President their satisfaction with the whole of the arrangements made for their reception and entertainment. The attractions of the Show were further increased by the presence of the French Fleet, of an Austrian man-of-war, and of the ships of the Channel Squadron, and the Society had the satisfaction of receiving as visitors a large number of the foreign officers and sailors. Although the receipts for admission of visitors to the Showyard amounted to 6270*l.*, the outlay required for so extensive an assemblage of implements and cattle, and for the elaborate and highly satisfactory trial of implements on the occasion, has proved so great that the excess of expenditure over receipts on account of the Meeting amounts to about 750*l.* The General Meeting of the Members on leaving Ply-

mouth conveyed to the Mayors of Plymouth and Devonport, and to the local Committee, and others, who had zealously co-operated with the Council in promoting the success of the Meeting, an expression of their best acknowledgments for their kind exertions.

The Council have the satisfaction of reporting that 120 Candidates from 18 counties have been entered for their prizes in connection with the Cambridge Local Examinations which take place during the present month. Of these candidates 83 are under the age of 16, of whom 75 are entered for the General Junior Examination, 60 for prizes in pure Mathematics, 15 in Elementary Mechanics, 4 in Chemistry, and 1 in Botany. There are 27 under the age of 18 who have entered for the general Senior Examination, and of these 21 are entered for the prizes in pure Mathematics, 12 in applied Mathematics, 2 in Chemistry, 2 in Zoology, 1 in Botany and 1 in Geology. Those only who have passed the Preliminary Examination are eligible to obtain a prize in a special subject. In the list open to candidates not exceeding 25 years of age, 13 have entered to compete for one or both of the extra subjects, 6 compete in Mechanics, and 12 in Chemistry applied to Agriculture. Many candidates have entered in more than one subject, 104 describe themselves as the sons of Farmers or others in some way dependent on the cultivation of the soil for their support, and the remaining 16 express themselves as intending to follow agricultural pursuits in after life.

The Council have obtained the assistance of Mr. Besant, of St. John's College, Cambridge (Senior Wrangler 1850), to examine in Mechanics applied to Agriculture, in conjunction with Mr. Amos, the Society's consulting engineer. Mr. Liveing, professor of Chemistry in the University of Cambridge, and the Society's consulting chemist, Professor Voelcker, will conduct the examination in Chemistry applied to Agriculture.

The Council having considered the subject of the Cattle Plague, came to a series of resolutions as to the means they considered most likely to arrest its progress, and a deputation attended by appointment upon Earl Granville, the President of the Council, and the Secretary of State for the Home Department, to lay these recommendations before them.

In consequence of the prevalence of the Cattle Plague the Council in conformity with the wishes of the local authorities

of Bury St. Edmunds have resolved that the Meeting, which was to have been held at that town in 1866, should be postponed to 1867.

Professor Voelcker has delivered lectures before the members of the Society on "Irrigation" and "Disinfectants."

The Council have from time to time been favoured with various communications from Her Majesty's Secretary of State for Foreign Affairs, and from the Lord President of the Council, the substance of which has been made public in the published Proceedings of the Meetings at which they were read.

By Order of the Council,

H. HALL DARE,

Secretary.







# SOCIETY OF ENGLAND.

xiii

FROM 1ST JULY TO 31ST DECEMBER, 1865.

CR.

	£.	s.	d.	£.	s.	d.	£.	s.	d.
By Expenditure:—									
Establishment—									
Official Salaries, Wages, &c. ..	342	6	0						
House Expenses, Rent, Taxes, &c. ..	452	4	11						
				794	10	11			
Journal:—									
Printing .. .. .	689	11	0						
Delivery and Advertising .. ..	160	12	4						
Stitching .. .. (2 Parts)	156	7	4						
Prize Essays .. .. .	120	0	0						
Other Contributions .. .. .	68	12	6						
Editor's Salary .. .. .	250	0	0						
				1,445	3	2			
Chemical:—									
Consulting Chemist's Salary .. (3 Quarters)				225	0	0			
Veterinary:—									
Annual Grant to Royal Veterinary College .. .. .	200	0	0						
Printing and Postage of Circular on Cattle Plague .. .. .	53	3	2						
				253	3	2			
Postage and Carriage .. .. .				26	11	8			
Advertisements .. .. .				19	15	9			
Education .. .. .				17	19	5			
Purchase of Show-Yard Materials .. .. .				634	2	0			
Surveyor at Plymouth .. .. .				45	0	0			
Sundries .. .. .				10	0	0			
							3,471	6	1
By Country Meetings:—									
Plymouth .. .. .				8,294	0	5			
Bury St. Edmunds .. .. .				234	16	7			
							8,528	17	0
By Balance in hand, Dec. 31, 1865:—									
Bankers .. .. .				360	6	10			
Secretary .. .. .				30	1	11			
							390	8	9
							£12,390	11	10

31ST DECEMBER, 1865.

## ASSETS.

	£.	s.	d.
By Cash in hand .. .. .	390	8	9
By New 3 per cent. Stock 19,027 <i>l.</i> 19 <i>s.</i> 6 <i>d.</i> cost .. .. .	18,142	12	7
By Books and Furniture in Society's House .. .. .	2,000	0	0
By Show-Yard Plant .. .. .	2,000	0	0
By Bury St. Edmunds Meeting .. .. .	227	6	7

*Mem.*—The above Assets are exclusive of the amount recoverable in respect of arrears of Subscription to 31st December, 1865, which at that date amounted to 984*l.*

£22,760 7 11

Examined, audited, and found correct, this 29th day of January, 1866.  
 (Signed) WILLIAM COPELAND ASTBURY, } Auditors on the  
 WILLIAM COHEN, } part of the Society.

COUNTRY MEETING ACCOUNT, PLYMOUTH, 1865.

RECEIPTS.

	£.	s.	d.
Subscription from Plymouth	2,000	0	0
Admissions to Show Yard	6,270	15	0
Sale of Catalogues	333	9	0
Implement Exhibitors' Payments for Sheedling	819	3	0
Non-Members' Fees for entry of Implements	44	10	0
Fees for entry of Live-Stock	314	10	0
Fees for Horse Boxes	86	0	0
Fees for Horse Cows	2	0	0
Fees for entry of Wool and Butier	1	0	0
Fines for non-Exhibition of Live-Stock	25	0	0
Extra lines in Implement Catalogue	37	10	0
	<u>9,553</u>	<u>17</u>	<u>0</u>
By Balance	712	14	11

£10,696 11 11

EXPENDITURE.

Show and Trial Yards, hire of Hurdles, Turnstiles, &c.	3,537	10	6
New Shed Plates, repairing old ditto, Notice Boards, &c.	95	7	11
Carriage of Society's Plant	30	15	0
Judges; Implements, 1867; Stock, 330 <i>l.</i> ; Wool, 20 <i>l.</i> ; Butter, 10 <i>l.</i>	576	0	0
Consulting-Engineer's Assistants	101	12	11
Veterinary-Inspectors and Assistant, and Inspectors of Shearing.	82	18	0
Police: Metropolitan, 143 <i>l.</i> 8 <i>s.</i> 8 <i>d.</i> ; Devon County, 57 <i>l.</i> 10 <i>s.</i> 7 <i>d.</i>	200	19	3
Clerks and Assistants: Secretary, 23 <i>l.</i> 2 <i>s.</i> ; Hon. Director, 41 <i>l.</i> 1 <i>s.</i> 10 <i>d.</i> ;	102	11	10
Bankers, 297 8 <i>s.</i>	53	10	6
Assistant Steward of Implements, 25 <i>l.</i> 10 <i>s.</i> 6 <i>d.</i> ; Steward of Forage, 25 <i>l.</i>	69	0	8
Foremen of Departments	213	13	6
Yardmen, 170 <i>l.</i> 5 <i>s.</i> ; Labourers and Fieldmen, 25 <i>l.</i> 8 <i>s.</i> 5 <i>d.</i> ; Grooms, 15 <i>l.</i>	98	3	6
Index-Clerks and Money-takers, 69 <i>l.</i> 6 <i>s.</i> ; Money-changers, Door-keepers, &c.	213	7	0
25 <i>l.</i> 17 <i>s.</i> 6 <i>d.</i>	107	4	0
Loans for Stewards, Implement Judges, Inspectors, Engineers, &c.	52	10	0
Refreshments for ditto	9	10	0
Luncheon for Prince and Princess of Wales, &c.	9	10	0
Dinner Tickets	291	19	0
Catalogues: Implements, 227 <i>l.</i> 6 <i>s.</i> ; Awards, 7 <i>l.</i> 10 <i>s.</i> ; Stock, 65 <i>l.</i> 17 <i>s.</i> ;	181	10	8
Printing—Price-sheets, Certificates, Admission-orders, Tickets, Railway	284	18	6
Papers, Parchment Labels, Circulars, Programmes, Notices, &c.	101	1	3
Advertising—Newspapers, 185 <i>l.</i> 11 <i>s.</i> ; Railways and Posters, 49 <i>l.</i> 7 <i>s.</i> 6 <i>d.</i>	457	10	0
Postage and Carriage, 83 <i>l.</i> 15 <i>s.</i> 3 <i>d.</i> ; Stationery, 20 <i>l.</i> 6 <i>s.</i>	20	2	0
Hay, 130 <i>l.</i> ; Straw, 150 <i>l.</i> ; Green Food, 177 <i>l.</i> 10 <i>s.</i>	100	0	0
Planning Show-Yard, 15 <i>l.</i> ; Surveyor, 2 <i>l.</i> 2 <i>s.</i>	295	13	8
Roads and Approaches	6	9	6
Horse Hire, 276 <i>l.</i> 9 <i>s.</i> 8 <i>d.</i> ; Conveyances, 197 4 <i>s.</i>	19	7	6
Hire of Steam Engines, 17 5 <i>s.</i> ; Hire of Mower, 5 <i>l.</i> 4 <i>s.</i> 6 <i>d.</i>	16	2	0
Fire Engine Men, 10 <i>l.</i> 18 <i>s.</i> 6 <i>d.</i> ; Water Supply, 2 <i>l.</i> 9 <i>s.</i>	11	2	4
Hire of Tent, 10 <i>l.</i> ; Hire of Chairs, 6 <i>l.</i> 2 <i>s.</i>	9	7	4
Tarred Lane, Twine, Rope, &c., 6 <i>l.</i> 11 <i>s.</i> 4 <i>d.</i> ; Boxes and Baskets, 3 <i>l.</i> 2 <i>s.</i> ;	12	5	7
Brooms, Rakes, &c. 1 <i>l.</i> 4 <i>d.</i>	10	10	0
Shed, hung, Ashes, &c., 7 <i>l.</i> 5 <i>s.</i> ; Seeds, 2 <i>l.</i> 2 <i>s.</i> 4 <i>d.</i>	3,225	8	0
Petty Payments	2	10	0
Official Staff	7		
Rosettes	7		
Prizes—Implements, 436 <i>l.</i> ; Stock, 2775 <i>l.</i> ; Medals, 14 <i>l.</i> 8 <i>s.</i>			

£10,696 11 11

## Members' Privileges of Chemical Analysis.

THE Council have fixed the following rates of Charge for Analyses to be made by the Consulting Chemist for the *bonâ-fide* use of Members of the Society; who (to avoid all unnecessary correspondence) are particularly requested, when applying to him, to mention the kind of analysis they require, and to quote its number in the subjoined schedule. The charge for analysis, together with the carriage of the specimens, must be paid to him by members at the time of their application.

No. 1.—An opinion of the genuineness of Peruvian guano, bone-dust, or oil-cake (each sample) .. .. .	5s.
„ 2.—An analysis of guano; showing the proportion of moisture, organic matter, sand, phosphate of lime, alkaline salts, and ammonia .. .. .	10s.
„ 3.—An estimate of the value (relatively to the average of samples in the market) of sulphate and muriate of ammonia, and of the nitrates of potash and soda .. .. .	10s.
4.—An analysis of superphosphate of lime for soluble phosphates only .. .. .	10s.
„ 5.—An analysis of superphosphate of lime, showing the proportions of moisture, organic matter, sand, soluble and insoluble phosphates, sulphate of lime, and ammonia ..	£1.
„ 6.—An analysis (sufficient for the determination of its agricultural value) of any ordinary artificial manure .. .. .	£1.
„ 7.—Limestone:—the proportion of lime, 7s. 6d.; the proportion of magnesia, 10s.; the proportion of lime and magnesia .. .. .	15s.
„ 8.—Limestone or marls, including carbonate, phosphate, and sulphate of lime, and magnesia with sand and clay ..	£1.
„ 9.—Partial analysis of a soil, including determinations of clay, sand, organic matter, and carbonate of lime .. .. .	£1.
„ 10.—Complete analysis of a soil .. .. .	£3.
„ 11.—An analysis of oil-cake, or other substance used for feeding purposes; showing the proportion of moisture, oil, mineral matter, albuminous matter, and woody fibre; as well as of starch, gum, and sugar, in the aggregate ..	£1.
„ 12.—Analyses of any vegetable product .. .. .	£1.
„ 13.—Analyses of animal products, refuse substances used for manure, &c. .. .. . from 10s. to 30s.	
„ 14.—Determination of the “hardness” of a sample of water before and after boiling .. .. .	10s.
„ 15.—Analysis of water of land drainage, and of water used for irrigation .. .. .	£2.
„ 16.—Determination of nitric acid in a sample of water .. .. .	£1.

N.B.—*The above Scale of Charges is not applicable to the case of persons commercially engaged in the Manufacture or Sale of any Substance sent for Analysis.*

The Address of the Consulting Chemist of the Society is, Dr. AUGUSTUS VOELCKER, 11, Salisbury Square, London. E.C., to which he requests that all letters and parcels (postage and carriage paid) should be directed.

## Members' Veterinary Privileges.

### I.—SERIOUS OR EXTENSIVE DISEASES.

No. 1. Any Member of the Society who may desire professional attendance and special advice in cases of serious or extensive disease among his cattle, sheep, or pigs, and will address a letter to the Secretary, will, by return of post, receive a reply stating whether it be considered necessary that Professor Simonds, the Society's Veterinary Inspector, should visit the place where the disease prevails.

No. 2. The remuneration of the Inspector will be 2*l.* 2*s.* each day as a professional fee, and 1*l.* 1*s.* each day for personal expenses; and he will also be allowed to charge the cost of travelling to and from the locality where his services may have been required. The fees will be paid by the Society, but the travelling expenses will be a charge against the applicant. This charge may, however, be reduced or remitted altogether at the discretion of the Council, on such step being recommended to them by the Veterinary Committee.

No. 3. The Inspector, on his return from visiting the diseased stock, will report to the Committee, in writing, the results of his observations and proceedings, which Report will be laid before the Council.

No. 4. When contingencies arise to prevent a personal discharge of the duties confided to the Inspector, he may, subject to the approval of the Committee, name some competent professional person to act in his stead, who shall receive the same rates of remuneration.

### II.—ORDINARY OR OTHER CASES OF DISEASE.

Members may obtain the attendance of the Veterinary Inspector on any case of disease by paying the cost of his visit, which will be at the following rate, viz., 2*l.* 2*s.* per diem, and travelling expenses.

### III.—CONSULTATIONS WITHOUT VISIT.

Personal consultation with Veterinary Inspector .. .. .	5 <i>s.</i>
Consultation by letter .. .. .	5 <i>s.</i>
Consultation necessitating the writing of three or more letters.	10 <i>s.</i>
Post-mortem examination, and report thereon .. .. .	10 <i>s.</i>

A return of the number of applications during each half-year being required from the Veterinary Inspector.

### IV.—ADMISSION OF DISEASED ANIMALS TO THE VETERINARY COLLEGE; INVESTIGATIONS, LECTURES, AND REPORTS.

No. 1. All Members of the Society have the privilege of sending cattle, sheep, and pigs to the Infirmary of the Royal Veterinary College, on the same terms as if they were Members of the College; viz., by paying for the keep and treatment of cattle 10*s.* 6*d.* per week each animal, and for sheep and pigs "a small proportionate charge to be fixed by the Principal according to circumstances."

No. 2. The College has also undertaken to investigate such particular classes of disease, or special subjects connected with the application of the Veterinary art to cattle, sheep, and pigs, as may be directed by the Council.

No. 3. In addition to the increased number of lectures now given by Professor Simonds—the Lecturer on Cattle Pathology—to the pupils in the Royal Veterinary College, he will also deliver such lectures before the Members of the Society, at their house in Hanover Square, as the Council shall decide.

No. 4. The Royal Veterinary College will from time to time furnish to the Council a detailed Report of the cases of cattle, sheep, and pigs treated in the Infirmary.

# Royal Agricultural Society of England.

1866.

---

## President.

HARRY STEPHEN THOMPSON.

## Trustees.

ACLAND, Sir THOMAS DYKE, Bart., *Killerton Park, Exeter, Devonshire.*  
BERNERS, Lord, *Keythorpe Hall, Leicester.*  
BRAMSTON, THOMAS WILLIAM, *Skreens, Chelmsford, Essex.*  
CHALLONER, Colonel, *Portnall Park, Staines, Middlesex.*  
FEVERSHAM, Lord, *Helmsley, York.*  
MARLBOROUGH, Duke of, *Blenheim Park, Oxford.*  
PORTMAN, Lord, *Bryanston, Blandford, Dorset.*  
POWIS, Earl of, *Powis Castle, Welshpool, Montgomeryshire.*  
RUTLAND, Duke of, K.G., *Belvoir Castle, Grantham, Lincolnshire.*  
SHELLEY, Sir JOHN VILLIERS, Bart., *Maresfield Park, Sussex.*  
SPEAKER, The Rt. Hon. the, *Ossington, Newark-on-Trent, Notts.*  
THOMPSON, HARRY STEPHEN, *Kirby Hall, York.*

## Vice-Presidents.

CHICHESTER, Earl of, *Stanmer Park, Lewes, Sussex.*  
DOWNSHIRE, Marquis of, *East Hampstead Park, Bracknell, Berkshire.*  
EGMONT, Earl of, *Cowdray Park, Petworth, Sussex.*  
EVERSLEY, Viscount, *Heckfield Place, Winchfield, Hants.*  
EXETER, Marquis of, *Burleigh House, Stamford, Lincolnshire.*  
HILL, Viscount, *Hawkstone Park, Salop.*  
HOBBS, W. FISHER, *Boxted Lodge, Colechester, Essex.*  
HOOD, Major-Gen. the Hon. A. NELSON, *Cumberland Lodge, Windsor, Berkshire.*  
JOHNSTONE, Sir JOHN V. B., Bart., M.P., *Hackness Hall, Scarborough, Yorkshire.*  
MILES, Sir WILLIAM, Bart., *Leigh Court, Bristol, Somersetshire.*  
WALSINGHAM, Lord, *Merton Hall, Thetford, Norfolk.*

## Other Members of Council.

ACLAND, THOMAS DYKE, M.P., *Sprydoncote, Exeter, Devonshire.*  
AMOS, CHARLES EDWARDS, 5, *Cedars Road, Clapham Common, Surrey.*  
BARNETT, CHARLES, *Stratton Park, Biggleswade, Bedfordshire.*  
BARTHROPP, NATHANIEL GEORGE, *Hacheston, Wickham Market, Suffolk.*  
BOWLY, EDWARD, *Siddington House, Cirencester.*  
BURGESS WILLIAM, *Brentwood, Essex.*  
CANTRELL, CHARLES S., *Riding Court, Datchet, Bucks.*  
CATHCART, Earl, *Thornton-le-Street, Thirsk, Yorkshire.*  
CHESHAM, Lord, *Latimer, Chesham, Bucks.*

- CLAYDEN, JOHN, *Littlebury, Saffron Walden, Essex.*  
 CLIVE, GEORGE, M.P., *Perrystone, Ross, Herefordshire.*  
 DENT, J. D., M.P., *Ribston Hall, Wetherby, Yorkshire.*  
 DRUCE, JOSEPH, *Eynsham, Oxford.*  
 GIBBS, B. T. BRANDRETH, *Halfmoon Street, Piccadilly, London, W.*  
 HOLLAND, EDWARD, M.P., *Dumbleton Hall, Eresham, Gloucestershire.*  
 HORNSBY, RICHARD, *Spittle Gate, Grantham, Lincolnshire.*  
 HOSKYN, CHANDOS WREN, *Harewood, Ross, Herefordshire.*  
 HUDSON, JOHN, *Castleacre Lodge, Brandon, Norfolk.*  
 HUTTON, WILLIAM, *Gate Burton, Gainsboro', Lincolnshire.*  
 JONAS, SAMUEL, *Chrishall Grange, Saffron Walden, Essex.*  
 KERKISON, SIR EDWARD C., Bart., M.P., *Brome Hall, Scole, Suffolk.*  
 KINGSCOTE, Colonel, M.P., *Kingscote, Wootton-under-Edge, Gloucestershire.*  
 LAWES, JOHN BENNET, *Rothamsted, St. Albans, Herts.*  
 LAWRENCE, CHARLES, *Cirencester, Gloucestershire.*  
 LOPES, SIR MASSEY, Bart., M.P., *Maristow, Roborough, Devon.*  
 MACDONALD, SIR ARCHIBALD KEPPEL, Bart., *Woolmer Lodge, Liphook, Hants.*  
 MILWARD, RICHARD, *Thurgarton Priory, Southwell, Notts.*  
 PAIN, THOMAS, *Ugford Cottage, Salisbury, Wilts.*  
 POPE, EDWARD, *Great Toller, Maiden Newton, Dorset.*  
 RANDELL, CHARLES, *Chadbury, Eresham, Worcestershire.*  
 READ, CLARE SEWELL, M.P. *Honingham Thorpe, Norwich.*  
 RICHMOND, Duke of, K.G., *Goodwood, Chichester, Sussex.*  
 RIDLEY, SIR MATTHEW WHITE, Bart., M.P., *Blagdon, Cramlington, Northumberland.*  
 RIGDEN, WILLIAM, *Hove, Brighton, Sussex.*  
 SANDAY, WILLIAM, *Holmepierrepoint, Notts.*  
 SHREWSBURY AND TALBOT, Earl of, *Ingestre Hall, Staffordshire.*  
 SHUTTLEWORTH, JOSEPH, *Hartsholme Hall, Lincoln.*  
 SMITH, ROBERT, *Emmett's Grange, Southmolton, Devon.*  
 TORR, WILLIAM, *Aylesby Manor, Great Grimsby, Lincolnshire.*  
 TREDEGAR, Lord, *Tredegar, Newport, Monmouthshire.*  
 TURNER, GEORGE, *Beacon Downes, Exeter, Devonshire.*  
 VERNON, Lord, *Sudbury Hall, Derby.*  
 WALLIS, OWEN, *Overstone Grange, Northampton.*  
 WELLS, WILLIAM, *Holmewood, Peterborough, Northamptonshire.*  
 WESTERN, SIR THOMAS B., Bart., M.P., *Felix Hall, Kelvedon, Essex.*  
 WILSON, JACOB, *Woodhorn Manor, Morpeth, Northumberland.*  
 WILSON, Professor, *Iver, Uxbridge, Bucks.*  
 WYNN, SIR WATKIN WILLIAMS, Bart., M.P., *Rhuabon, Denbighshire.*

### Secretary.

H. HALL DARE, 12, *Hanover Square, London, W.*

*Editor*—P. H. FRERE, *Dungate, Cambridge.*

*Consulting-Chemist*—Dr. AUGUSTUS VOELCKER, 11, *Salisbury Square, E.C.*

*Veterinary-Inspector*—JAMES BEART SIMONDS, *Royal Veterinary College, N.W.*

*Consulting Engineer*—JAMES EASTON, or C. E. AMOS, *Grove, Southwark, S.E.*

*Seedsmen*—THOMAS GIBBS and Co., *Corner of Halfmoon Street, Piccadilly, W.*

*Publisher*—JOHN MURRAY, 50, *Albemarle Street, W.*

*Bankers*—THE LONDON AND WESTMINSTER BANK, *St. James's Square Branch, S.W.*



**STANDING COMMITTEES FOR 1866.****Finance Committee.**

HOOD, Maj.-Gen. the Hon. A. NELSON, Chairman.	HOBBS, WM. FISHER.
BARNETT, CHARLES.	RANDELL, CHARLES.
BRAMSTON, T. W.	TORR, WILLIAM.

**House Committee.**

THE PRESIDENT.	CHALLONER, Colonel.
CHAIRMAN of Finance Committee.	GIBBS, B. T. BRANDRETH.
CHESHAM, Lord.	HOBBS, WM. FISHER.
BRAMSTON, T. W.	

**Journal Committee.**

THOMPSON, H. S., Chairman.	MACDONALD, Sir A. K., Bt.
CATHCART, Earl, Vice-Chairman.	ACLAND, T. DYKE, M.P.
SPEAKER, The Rt. Hon. the.	HOLLAND, ED., M.P.
SHELLEY, Sir J. V., Bt.	HOSKYNS, C. WREN.
JOHNSTONE, Sir J. V. B., Bt., M.P.	MILWARD, RICHARD.
KERRISON, Sir E. C., Bt., M.P.	WALLIS, OWEN.

**Chemical Committee.**

LAWES, J. B., Chairman.	HOLLAND, ED., M.P.
CATHCART, Earl.	HOSKYNS, C. WREN.
VERNON, Lord.	HUXTABLE, Ven. Archdeacon.
JOHNSTONE, Sir J. V. B., Bt., M.P.	THOMPSON, H. S.
KERRISON, Sir E. C., Bt., M.P.	WELLS, WILLIAM.
LOPES, Sir MASSEY, Bt., M.P.	WILSON, JACOB.
DENT, J. D., M.P.	

**Veterinary Committee.**

HOOD, Maj.-Gen. the Hon. A. NELSON.	SIMONDS, Professor.
JOHNSTONE, Sir J. V. B., Bt., M.P.	SPOONER, Professor.
CHALLONER, Colonel.	THOMPSON, H. S.
DENT, J. D., M.P.	VARNELL, Professor.
GIBBS, B. T. BRANDRETH.	WELLS, WILLIAM.
HOBBS, WM. FISHER.	WILSON, JACOB.
PAIN, THOS.	

**Stock-Prizes Committee.**

FEVERSHAM, Lord.	JONAS, SAMUEL.
WALSINGHAM, Lord.	MILWARD, RICHARD.
HOOD, Maj.-Gen. the Hon. A. NELSON.	PAIN, THOMAS.
BARNETT, CHARLES.	POPE, EDWARD.
BARTHROPP, NATHANIEL G.	RANDELL, CHAS.
CLAYDEN, JOHN.	RIGDEN, WM.
DENT, J. D., M.P.	SMITH, ROBERT.
DRUCE, JOSEPH.	SIMONDS, Professor.
GIBBS, B. T. BRANDRETH.	TORR, WILLIAM.
HOBBS, WM. FISHER.	TURNER, GEORGE.
HOLLAND, ED., M.P.	WALLIS, OWEN.
HUDSON, JOHN.	

**Implement Committee.**

CATHCART, Earl.	HOBBS, WM. FISHER.
CHESHAM, Lord.	HOLLAND, ED., M.P.
VERNON, Lord.	HOSKYNs, C. WREN.
HOOD, Maj.-Gen. the Hon. A. NELSON.	RANDELL, CHARLES.
KERRISON, Sir E. C., Bt., M.P.	SANDAY, WILLIAM.
MACDONALD, Sir A. K., Bt.	SHUTTLEWORTH, JOSEPH.
MILES, Sir Wm., Bt.	THOMPSON, H. S.
AMOS, C. E.	TORR, WILLIAM.
BARNETT, CHARLES.	WALLIS, OWEN.
CANTRELL, CHAS. S.	WILSON, Professor.
CHALLONER, Colonel.	WILSON, JACOB.
GIBBS, B. T. BRANDRETH.	

**General Bury Committee.**

Lord TREDEGAR, Chairman.	CLAYDEN, JOHN.
POWIS, Earl of.	DENT, J. D., M.P.
CHESHAM, Lord.	GIBBS, B. T. BRANDRETH.
FEVERSHAM, Lord.	GREENE, E., M.P.
PORTMAN, Lord.	HOBBS, WM. FISHER.
VERNON, Lord.	HOLLAND, E., M.P.
HOOD, Maj.-Gen. the Hon. A. NELSON.	HOSKYNs, C. WREN.
Sir E. C. KERRISON, Bt., M.P.	JONAS, SAMUEL.
BARNETT, CHARLES.	MILWARD, RICHARD.
BARTHOOPP, N. G.	PAIN, THOMAS.
BOWLY, EDWARD.	RANDELL, CHARLES.
BURY, The Mayor of.	SHUTTLEWORTH, JOSEPH.
BRAMSTON, T. W.	THOMPSON, H. S.
CANTRELL, CHARLES S.	TORR, WILLIAM.
CHALLONER, Colonel.	WILSON, Major.

**Education Committee.**

POWIS, Earl of.	DRUCE, JOSEPH.
WALSINGHAM, Lord.	FREERE, P. H.
JOHNSTONE, Sir J. V. B., M.P.	HOSKYNs, C. WREN.
KERRISON, Sir E. C., Bt., M.P.	THOMPSON, H. S.
ACLAND, T. DYKE, M.P.	WALLIS, OWEN.
BARTHOOPP, N. G.	WELLS, WILLIAM.
CLAYDEN, JOHN.	WILSON, Professor.
DENT, J. D., M.P.	VOELCKER, Professor.

**Show-Hards Contracts Committee.**

RANDELL, CHARLES, Chairman.	HOBBS, W. FISHER.
CATHCART, Earl.	SANDAY, WILLIAM.
VERNON, Lord.	SHUTTLEWORTH, JOSEPH.
HOOD, Maj.-Gen. the Hon. A. NELSON.	THOMPSON, H. S.
AMOS, C. E.	TORR, WILLIAM.
GIBBS, B. T. BRANDRETH.	

**Cattle Plague Committee.**

FEVERSHAM, Lord.	HOLLAND, E., M.P.
TREDEGAR, Lord.	KINGSCOTE, Colonel, M.P.
VERNON, Lord.	PAIN, THOMAS.
WALSINGHAM, Lord.	RANDELL, CHARLES.
HOOD, Maj.-Gen. Hon. A. NELSON.	SANDAY, WILLIAM.
ACLAND, T. DYKE, M.P.	SIMONDS, Professor.
BARTHOOPP, N. G.	THOMPSON, H. S.
GIBBS, B. T. BRANDRETH.	

\* \* \* The PRESIDENT, TRUSTEES, and VICE-PRESIDENTS are Members *ex officio* of all Committees.

## MEMORANDA.\*

**ADDRESS OF LETTERS.**—The Society's office being situated in the postal district designated by the letter **W**, members, in their correspondence with the Secretary, are requested to subjoin that letter to the usual address.

**GENERAL MEETING** in London, in December, 1866.

**MEETING** at Bury St. Edmunds, in 1867.

**MONTHLY COUNCIL** (for transaction of business), at 12 o'clock on the first Wednesday in every month, excepting January, September, and October: open only to Members of Council and Governors of the Society.

**WEEKLY COUNCIL** (for practical communications), at 12 o'clock on all Wednesdays in February, March, April, May, June, July, and November, excepting the first Wednesday in each of those months, and during adjournment: open to all Members of the Society, who are particularly invited by the Council to avail themselves of this privilege.

**ADJOURNMENTS.**—The Council adjourn over Passion and Easter weeks, when those weeks do not include the first Wednesday of the month: from the first Wednesday in August to the first Wednesday in November; and from the first Wednesday in December to the first Wednesday in February.

**DISEASES of Cattle, Sheep, and Pigs.**—Members have the privilege of applying to the Veterinary Committee of the Society; and of sending animals to the Royal Veterinary College, on the same terms as if they were subscribers to the College.—(A statement of these privileges will be found in the present Appendix.)

**CHEMICAL ANALYSIS.**—The privileges of Chemical Analysis enjoyed by Members of the Society will be found stated in the Appendix of the present volume.

**SUBSCRIPTIONS.**—Members are requested to forward their Subscriptions by Cheques, or Post-office Orders on Vere-street, W., payable to H. HALL DARE. All Cheques are required to bear upon them a penny draft or receipt stamp, which must be cancelled in each case by the initials of the drawer. They may also conveniently transmit their Subscriptions to the Society, by requesting their Country Bankers to pay (through their London Agents) the amount at the Society's Office (No. 12, Hanover Square, London), between the hours of ten and four, when official receipts, signed by the Secretary, will be given for such payments.

**NEW MEMBERS.**—Every candidate for admission into the Society must be proposed by a Member; the proposer to specify in writing the full name, usual place of residence, and post-town, of the candidate, either at a Council meeting, or by letter addressed to the Secretary.

**PACKETS BY POST.**—Packets not exceeding two feet in length, or one foot in width, or depth, consisting of written or printed matter (but not containing letters sealed or open), if sent without envelopes, or enclosed in envelopes open at each end, may be forwarded by the inland post, if stamped, at the following rates:—

For a packet not exceeding	4 ounces (or quarter of a pound)	. . .	1 penny
" "	8 " (or half a pound)	. . .	2 pence.
" "	16 " (or one pound)	. . .	4 "
" "	24 " (or one pound and a half)	. . .	6 "
" "	32 " (or two pounds)	. . .	8 "

[And so on in the proportion of 8 ounces for each additional 2*l*.]

\* \* Members may obtain on application to the Secretary copies of an Abstract of the Charter and Bye-Laws, of a Statement of the General Objects, &c., of the Society, of Chemical and Veterinary Privileges, and of other printed papers connected with special departments of the Society's business.

## Royal Agricultural Society of England.

---

### GENERAL MEETING,

12, HANOVER SQUARE, TUESDAY, MAY 22, 1866.

---

#### REPORT OF THE COUNCIL.

THE Council have to report that, since last December, the Society has lost by deaths and resignations 1 Governor and 308 Members ; while 1 Life Governor and 57 Members have, during the same period, been enrolled on its List, which is now constituted as follows :—

79 Life Governors,  
84 Annual Governors,  
1395 Life Members,  
4049 Annual Members, and  
15 Honorary Members,

making a total of 5622.

The Half-yearly Statement of Accounts to the 31st December, 1865, has been examined and approved by the Auditors and Accountants of the Society, and, together with the Balance-sheet for the whole year 1865, and a statement of the Country Meeting Account for Plymouth, has been published in the last number of the 'Journal.' The funded capital stands at 19,027*l.* 19*s.* 6*d.* in the New Three per Cents., and the cash balance in the hands of the bankers on the 1st inst. was 1424*l.* 1*s.* 9*d.*

Since the last General Meeting, the Council, impressed with the necessity of continuing their exertions in promoting measures calculated to arrest the progress of the Cattle Plague, resolved itself into a Standing Committee ; and, on the 12th of February, had an interview with Earl Russell, and submitted to him the following Resolutions, which had been agreed to by the Council :—

Resolved—That the Cattle Plague has increased and is in-

creasing to an alarming extent. That the measures hitherto adopted have been wholly ineffectual to prevent its progress.

That no method of dealing with the Cattle Plague, at the present time, will be of any avail unless it provides for:—

1st. The immediate slaughter and burial, at least 6 feet deep, of all cattle suffering from the disease; making compensation to the owners in such mode and to such extent as shall be considered advisable.

2nd. The rigid surveillance of all infected farms, and the immediate slaughter of all animals which, from time to time, shall show the slightest symptoms of disease.

3rd. The thorough disinfection of all infected premises, and a prohibition to remove therefrom all manure, litter, hay, or straw, for a period to be fixed; and then only subject to certain specific regulations.

4th. That the Government be requested to bring before Parliament a Bill to direct and empower the Justices in Quarter or Special Sessions to assemble immediately to carry out the above Resolutions; and in such Bill to make provision for charging the necessary expenses on the County Rate, and also for assimilating the action of Counties and Boroughs.

5th. That simultaneously with the destruction of diseased Cattle, the transit of all animals, whether by road or rail, be entirely prohibited, with such exceptions only as may be absolutely necessary.

6th. That during the existence of the Cattle Plague, all imported Cattle, Sheep, or Swine shall be slaughtered forthwith at the port where they are landed; and their hides, skins, and offal disinfected there.

The Council, as such Committee, have since up to the present time held several meetings for considering this subject, and have forwarded communications to the Privy Council with the following recommendation, pointing out the extreme importance of establishing *permanent* means for and compelling the slaughter of all foreign fat stock at the place of disembarkation; and also by an efficient system of quarantine applied to store animals; and by stringent restrictions upon the purchasers of stock after they are liberated from such quarantine, to protect the public as far as possible from the risk of infection caused by the importation of foreign cattle; and further, that no exception be

made as regards the Metropolitan Market. The Council have since recommended :—

1. “That in the opinion of the Council it is highly desirable that the provisions of the Cattle Diseases Prevention Act, authorising the compulsory slaughter of animals suffering from the Rinderpest, and the awarding of compensation to their owners, should be extended for a period of at least six months.”

2. “That the attention of the Government be called to the complaints that are made that the Orders in Council are in some districts very inefficiently carried out.”

To which the following reply was received :—

“Copy of an Order in Council, dated 9th instant, continuing until the 30th proximo the provisions of the Act, 29th Vic., cap. 2, which relates to the slaughter of diseased animals :—

“At the Court at Windsor, the 9th day of May, 1866 ; present, the Queen’s Most Excellent Majesty in Council.

“Whereas by an Act passed in the present session of Parliament, intituled ‘An Act to amend the law relating to contagious or infectious diseases in cattle and other animals,’ it is, amongst other things, enacted, that it shall be lawful for Her Majesty, by Order in Council, from time to time to continue, or to renew, if expired, all or any of the provisions, in the first part of that Act contained, for such time as shall be specified in such Order.

“And whereas it is provided in the eleventh section of the said Act, which section is in the first part thereof, that Part I. of the said Act shall continue in force until the fifteenth day of April, one thousand eight hundred and sixty-six, and no longer, unless continued or renewed by Order of Her Majesty in Council.

“And whereas it is provided in the twelfth, thirteenth, fourteenth, fifteenth, and sixteenth sections of the first part of the said Act as follows :—

#### SLAUGHTER OF DISEASED ANIMALS.

“12. Every Local Authority shall cause all animals affected with the Cattle Plague within its district to be slaughtered, and shall, by way of compensation for every animal so slaughtered, pay to the owner thereof such sum not exceeding twenty pounds, and not exceeding one half of the value of the animal imme-

diately before it was affected with the Cattle Plague, as to such Local Authority may seem fit.

“‘13. Every Local Authority shall cause every animal that has died of Cattle Plague, or has been slaughtered in consequence of being affected with Cattle Plague within its district, to be buried as soon as possible in its skin in some proper place, and to be covered with a sufficient quantity of quicklime or other disinfectant, and with no less than six feet of earth.

“‘14. Every Local Authority shall, within its district, cause the yard, shed, stable, field, or other premises in which any animal affected with Cattle Plague has been kept while affected by the disease, or has died or been slaughtered, to be thoroughly cleansed and disinfected, and all hay, straw, litter, dung, or other articles that have been used in or about any such animal to be burnt or otherwise destroyed; and no fresh animal shall be admitted into any yard, shed, stable, field, or other premises in which any animal affected with Cattle Plague has been kept while affected by the disease, or has died or been slaughtered, until the expiration of thirty days after the cleansing and disinfecting of such premises in pursuance of this Act; and every Local Authority shall direct the disinfecting the clothes of, and the use of due precautions by Inspectors, Cattle Overseers, and others in contact with animals affected by the Cattle Plague, with a view to prevent the spreading of contagion.

“‘15. A Local Authority may, if he thinks fit, cause to be slaughtered any animal that has been in the same shed or stable, or in the same herd or flock, or in contact with any animal affected with Cattle Plague within its district; and the owner of any animal so slaughtered may either dispose of the carcass on his own account, with a license from some officer appointed in that behalf by a Local Authority, or may require the Local Authority to dispose of the same, in which case such Local Authority shall pay to the owner thereof, by way of compensation, such sum, not exceeding twenty-five pounds, as may equal three-fourths of the value of the animal slaughtered. Provided always, that the Lords of Her Majesty's Most Honourable Privy Council, or any two or more of them, may reserve animals (ordered to be slaughtered as aforesaid) for the purpose of experimental treatment.

“‘16. The Local Authority may require the value of any animal

slaughtered under this Act, to be ascertained by Officers of the Local Authority or by arbitration, and generally may impose conditions as to evidence of the slaughter and value of the animals slaughtered: Provided that no compensation shall in any case be paid in respect of any animal found affected with Cattle Plague in a market or on a highway, or in respect of any animal which has been moved or otherwise dealt with in contravention of this Act, or any Order of a Local Authority made in pursuance thereof.

“And whereas by an Order of Her Majesty in Council, bearing date the ninth day of April, one thousand eight hundred and sixty-six, the provisions of the above recited sections of the first part of the said Act were continued in force beyond the said fifteenth day of April, one thousand eight hundred and sixty-six, and until the tenth day of May, one thousand eight hundred and sixty-six; and whereas it is considered expedient that the same be further continued:

“Now, therefore, Her Majesty, in exercise of the power vested in Her by the said Act, and by and with the advice of Her Privy Council, is pleased to order, and it is hereby ordered, that the said recited provisions contained in the twelfth, thirteenth, fourteenth, fifteenth, and sixteenth sections of the first part of the said Act shall continue in force on and after the said tenth day of May, one thousand eight hundred and sixty-six, until the thirtieth day of June, one thousand eight hundred and sixty-six.

“ARTHUR HELPS.”

The application of steam to the cultivation of the soil has received the careful consideration of the Council, and they consider that the time has now arrived when an attempt should be made to arrive at the results which have been obtained by its use on different soils and in different localities. With this object they have appointed a Central Committee, composed of members of the Council from every district in England to conduct a complete inquiry. Inspection Committees will visit such farms as the Central Committee may select for inspection. To assist them in their investigations, paid Secretaries will be attached to each Inspection Committee. A sum of 500*l.* has been voted for the purpose of carrying out this investigation.

The proceedings of the Education Committee with regard to



the prizes offered in connexion with the last Cambridge Local Examination are detailed at full length in the last number of the 'Journal;' and the Committee are following out similar plans to those therein detailed with regard to the ensuing Oxford Local Examinations. The Council have also authorised the Education Committee to offer prizes in connexion with the Cambridge Local Examinations for 1866.

The Country Meeting at Bury St. Edmunds having been postponed to 1867, in consequence of the prevalence of the Cattle Plague, a meeting will be held in the neighbourhood of London, merely *pro forma*, in accordance with the provisions of the Royal Charter, and will be duly advertised.

Papers have been read at the weekly meetings of the Society by the Right Honourable Earl Cathcart and by Professor Simonds on the Cattle Plague, and by Dr. Voelcker on Agricultural Experiments in the Field.

The Council have been favoured with various communications from Her Majesty's Secretary of State for Foreign Affairs, and these have from time to time been published in the agricultural papers reporting the Proceedings of the Council.

By Order of the Council,

H. HALL DARE,

Secretary.

## DR. HALF-YEARLY CASH ACCOUNT

	£. s. d.	£. s. d.
To Balance in hand, 1st January, 1866 :—		
Bankers .. .. .	360 6 10	
Secretary .. .. .	30 1 11	
		390 8 9
To Income, viz.:—		
Dividends on Stock .. .. .	280 13 3	
Subscriptions :—	£. s. d.	
Life Governor .. .. .	50 0 0	
Governors' Annual .. .. .	385 0 0	
Members' Life-Compositions .. .. .	140 0 0	
Members' Annual .. .. .	2695 14 0	
	3270 14 0	
Journal :—		
Sir C. Domville's prize for a )		
Suburban Farm .. .. . }	25 0 0	
Advertisements .. .. .	35 16 0	
	60 16 0	
Sale of Wool-case .. .. .	15 0 0	
		3627 3 3
To Country Meetings :—		
Plymouth .. .. .	3 13 0	
Bury St. Edmunds .. .. .	44 1 0	
		47 14 0
		£4065 6 0

## BALANCE-SHEET,

To Capital:	LIABILITIES.	£. s. d.
Surplus, 31st December, 1865 .. .. .		22,760 7 11
Surplus of Income over the Expenditure during the Half-year, viz :—		
Income .. .. .	3627 3 3	
Expenditure .. .. .	2327 5 9	
		1,299 17 6
		24,060 5 5
To Plymouth Meeting :—		
Balance of Receipts and Expenditure during the Half-year, the latter exceeding the former by .. .. . }	66 7 0	
		£23,993 18 5

(Signed)

A. N. HOOD, *Chairman of Finance Committee.*QUILTER, BALL, & Co., *Accountants.*

# SOCIETY OF ENGLAND.

xxix

FROM 1ST JANUARY TO 30TH JUNE, 1866.

CR.

	£.	s.	d.	£.	s.	d.	£.	s.	d.
By Expenditure:—									
Establishment—									
Official Salaries and Wages, &c.	342	6	0						
House Expenses, Rent, Taxes, &c.	283	0	3						
				625	6	3			
Journal:—									
Printing .. .. .	474	9	0						
Delivery and Advertising .. .. .	120	17	1						
Prize Essays (including 25 <i>l.</i> Sir C. Domville's Prize) .. .. .	45	0	0						
Other Contributions .. .. .	135	8	0						
Editor's Salary .. .. .	250	0	0						
				1025	14	1			
Chemical:—									
Grant for Investigations, 1865 ..	200	0	0						
Consulting Chemist's Salary ..	150	0	0						
				350	0	0			
Veterinary:—									
Grant to R. V. College, half year .. .. .				100	0	0			
Advertising .. .. .				25	17	9			
Postage and Carriage .. .. .				33	14	7			
Battersea Prize Cheque not previously presented				10	0	0			
Education .. .. .				138	18	1			
Steam Cultivation .. .. .				10	11	0			
Subscriptions returned (paid in error) .. .. .				7	4	0			
							2327	5	9
By Country Meetings:—									
Plymouth .. .. .				70	0	0			
Bury St. Edmunds .. .. .				14	14	0			
							84	14	0
By Balance in hand June 30th, 1866:—									
Bankers .. .. .				1627	0	11			
Secretary .. .. .				26	5	4			
							1653	6	3
							£4065	6	0

30TH JUNE, 1866.

ASSETS.				£.	s.	d.
By Cash in hand .. .. .				1,653	6	3
By New 3 per cent. Stock, 19,027 <i>l.</i> 19 <i>s.</i> 6 <i>d.</i> cost .. .. .				18,142	12	7
By Books and Furniture in Society's House .. .. .				2,000	0	0
By Show Yard Plant .. .. .				2,000	0	0
By Bury St. Edmund's Meeting, Preliminary Expenses .. .. .				197	19	7
 <i>Mem.</i> —The above Assets are exclusive of the amount recoverable in respect of Subscriptions in arrear 30th June, 1866, which at that date amounted to 697 <i>l.</i>						
				£23,993	18	5

Examined, audited, and found correct, this 19th day of July, 1866.

(Signed)	W. COPELAND ASTBURY. HENRY CORBET. WILLIAM COHEN.	}	<i>Auditors on the part of the Society.</i>
----------	---	---	---

PRIZES OFFERED IN CONNECTION WITH THE CAMBRIDGE LOCAL EXAMINATION, DECEMBER, 1866.

THE Council of the Royal Agricultural Society of England have determined upon offering the following prizes in connection with the Cambridge Local Examination to be held in December, 1866.

The Council offer 1 Senior Scholarship of 50*l.*, and 4 Junior Scholarships of 20*l.* to be competed for at the ensuing Cambridge Local Examinations in December, 1866, limited to sons of tenant-farmers, or of owners, if not exceeding 500 acres, occupying their own land, on the following conditions:—

That the Senior Scholarship shall only be given on condition that the scholar spend a year with a practical agriculturist, to be approved by the Education Committee, or at one of the Agricultural Colleges, such as Cirencester, Glasnevin, or the Agricultural Department at Edinburgh, and that the money shall not be paid until a testimonial as to good conduct and industry be produced, at the end of the year of scholarship, from the body or person under whom the scholar has studied.

That the Junior Scholarships shall only be given upon condition that the scholars spend a year at a school to be approved by the Education Committee, and that the money shall not be paid until a testimonial as to good conduct and industry be produced, at the end of the year of scholarship, from the person under whom the scholars have studied.

These Scholarships will be awarded according to the order in which the Candidates stand at the Cambridge Local Examinations.

They also offer the following Prizes in connection with the same examination to candidates duly recommended:—

- I. To candidates who answer special papers to be set in Mechanics and Chemistry as applied to Agriculture. Open to Seniors and Juniors who have passed the Preliminary Examination, and also to any young men not exceeding 25 years of age (duly recommended).

Mechanics applied to Agriculture	..	..	..	£10
Chemistry applied to Agriculture	..	..	..	.. 10

- II. To Candidates who obtain certificates, regard being had to their place in the General Class List—*Seniors*, a first prize of £5  
*Juniors*, a first prize of .. .. . 5

- III. To Candidates who (having passed the Preliminary Examination) are distinguished in any of the following special subjects:—

Seniors.

Section E.	{ Pure Mathematics, a first prize of .. .. .	£5
	{ Applied Mathematics, a first prize of .. .. .	5
Section F.	Chemistry, a first prize of .. .. .	5
Section G.	1. Zoology, and the Elements of Animal Physiology, a first prize of .. .. .	5
	2. Botany, and the Elements of Vegetable Physiology, a first prize of .. .. .	5
	3. Geology, including Physical Geography, a first prize of .. .. .	5
No student will be examined in more than one of these three divisions (1) (2) (3).		

Juniors.

Section 7.	Pure Mathematics, a first prize of .. .. .	£5
Section 8.	Mechanics, a first prize of .. .. .	5
Section 9.	Chemistry, a first prize of .. .. .	5
Section 10.	{ (a) Zoology, a first prize of .. .. .	5
	{ (b) Botany, a first prize of .. .. .	5

No student will be examined in more than one of the two divisions (a) and (b).

A sum of 30*l.* will be given away in secondary prizes of not less than 2*l.* each according to the discretion of the Committee.

Every Candidate shall be recommended by a member of the Royal Agricultural Society of England, must be a person in some way dependent on the cultivation of the land for his support, or intending to make agriculture his profession, and will have to fill up a *special form of application* as well as that which he is obliged to fill up for the University. These forms may be obtained from the Hon. Secretary Education Committee, 12, Hanover Square, London, W., where they must be returned by November 1.

No fee is required by the Royal Agricultural Society.

The Examinations will commence on Monday, 17th December, 1866, and will probably be held at the following places: (the gentlemen whose addresses are given kindly act as Local Secretaries for their respective neighbourhoods.)

Barnstaple: S. FEATHERSTONE, Esq., Union Terrace School.

Brighton: BARCLAY PHILLIPS, Esq., 75, Lansdowne Place.

Bristol: Rev. E. J. GREGORY, 2, Belgrave Place, Clifton.

Cambridge: R. POTTS, Esq., Parker's Piece.

Exeter: Mr. W. ROBERTS, Broadgate.

Faversham: F. W. MONK, Esq., Kent Association of Institutes.

Gravesend: A. H. GUTTERIDGE, Esq., Proprietary School.

Hastings: MESSRS. PORTER and STEWARD, West Hill House.

King's Lynn: Rev. T. WHITE, Grammar School.

Leeds: BARNETT BLAKE, Esq., Mechanic's Institution.

London : T. BODLEY, Esq., 49, Upper Harley Street, W.  
Lutterworth : Rev. W. BERRY, Ullesthorpe House.  
Northampton : Rev. R. P. LIGHTFOOT, Preston Deanery.  
Norwich : Rev. HINDS HOWELL, Drayton Rectory.  
Plymouth : HAMILTON WHITEFORD, Esq., Courtenay Street.  
Sheffield : Rev. S. EARNSHAW.  
Southampton : Rev. A. SELLS, Polygon House.  
Teignmouth : J. KEMPE, Esq., Church Hill House.  
Torquay : E. COCKREM, Esq., Directory Office, 10, Strand.  
Wakefield ; JAMES FOWLER, Esq., M.R.C.S., South Parade.  
West Buckland : J. H. THOMPSON, Esq., Southmolton.  
Windsor : W. H. HARRIS, Esq., 4, Osborne Villas.  
Wolverhampton : W. C. UMBERS. Esq., 2, Chronicle Buildings,  
Market Street.

## Essays and Reports.

---

### AWARD FOR 1865.

---

#### CLASS I.

The Prize of 50*l.* was awarded to Mr. R. VALLENTINE, of Burcott Lodge, Leighton Buzzard, for his Essay on Middle Class Education.

---

### AWARDS FOR 1866.

---

#### CLASS I.

The Prize of 50*l.* was awarded to Mr. W. J. MOSCROP, Aske, Richmond, Yorkshire, for his Essay on the Farming of Leicestershire.

#### CLASS II.

The Prize of 50*l.* was awarded to Mr. CLEMENT CADLE, Land Agent, Gloucester, for his Essay on the Farming of Worcestershire.

#### CLASS III.

The competing Essays were not considered worthy of a prize.

#### CLASS IV.

The Prize of 20*l.* was awarded to Mr. H. H. DIXON, 10, Kensington Square, W., for his Essay on the Mountain Breeds of Sheep.

#### CLASS VI.

The Prize of 15*l.* was awarded to Mr. W. LITTLE, of Picktree, Chester-le-Street, Co. Durham, for his Essay on the Improvement of Waste Lands connected with Mines.

#### CLASS VII.

The Prize of 25*l.* was awarded to Mr. K. BRIDGMAN, 69, Giles' Street, Norwich, for his Essay on the Use to a Farmer of a Magnifying Glass.

**Essays and Reports.—PRIZES FOR 1867.**—All Prizes of the Royal Agricultural Society of England are open to general competition. Competitors will be expected to consider and discuss the heads enumerated.

---

**I. FARMING OF HUNTINGDONSHIRE.**

TWENTY-FIVE SOVEREIGNS will be given for the best Report on the Farming of Huntingdonshire.

The leading geological features and the character of the soil should be briefly described. Reference should be made to any older records of the state of agriculture in the county.

The live stock kept; the state and management of the pasture-land; the management of arable land; the influence of steam cultivation; the changes effected in the fens by drainage; the state of farm-buildings, woods, &c., to be discussed; characteristic farms to be described; improvements, lately made or still required, to be stated.

**II. FARMING OF WESTMORLAND.**

TWENTY-FIVE SOVEREIGNS will be given for the best Report on the Farming of Westmorland.

The subject to be generally treated as for Prize I.; but with special reference to peculiarities arising from the influence of mountains, climate, mines, lakes, &c., &c.

**III. FARMING CUSTOMS AND COVENANTS.**

THIRTY SOVEREIGNS will be given for the best Essay on Farming Customs and Covenants existing in England.

**IV. PLOUGHING IN GREEN CROPS.**

FIFTEEN SOVEREIGNS will be given for the best Essay on the Result of Ploughing in Green Crops for Manure, and the crops best adapted for the purpose.

**V. LOANS FOR ESTATE IMPROVEMENTS.**

TWENTY-FIVE SOVEREIGNS will be given for the best Essay on Land Drainage and Improvement by Loans from Government or Public Companies.

Their origin, progress, range of operations, terms, influence, defects (if any) should be discussed.



**VI. DRAINAGE OF GRASS LANDS.**

TEN SOVEREIGNS will be given for the best Essay on the Drainage of Grass as distinguished from Arable Land.

**VII. FARM POULTRY.**

TEN SOVEREIGNS will be given for the best Essay to point out how far the Rearing and Management of Poultry on an ordinary farm are capable of improvement and profitable extension.

**VIII. DISEASE IN SHEEP.**

FIFTEEN SOVEREIGNS will be given for an Essay on the best Treatment of Affections of the Bladder amongst fattening Sheep and Lambs.

**IX. LABOURERS' DWELLINGS.**

TWENTY SOVEREIGNS will be given for the best Essay on the Latest Improvements in the Construction of Dwellings for the Labouring Classes.

**X. HEREFORD CATTLE.**

TWENTY-FIVE SOVEREIGNS will be given for the best Short History of the Rise and Progress of Herefords.

**XI. ANY OTHER AGRICULTURAL SUBJECT.**

TEN SOVEREIGNS will be given for the best Essay on any other Agricultural Subject.

---

*Reports or Essays competing for the Prizes must be sent to the Secretary of the Society, at 12, Hanover Square, London, on or before March 1st, 1867. Contributors of Papers are requested to retain Copies of their Communications, as the Society cannot be responsible for their return.*

---

RULES OF COMPETITION FOR PRIZE ESSAYS.

---

1. All information contained in Prize Essays shall be founded on experience or observation, and not on simple reference to books or other sources. Competitors are requested to use foolscap or large letter paper, and not to write on both sides of the leaf.

2. Drawings, specimens, or models, drawn or constructed to a stated scale, shall accompany writings requiring them.

3. All competitors shall enclose their names and addresses in a sealed cover, on which only their motto, the subject of their Essay, and the number of that subject in the Prize List of the Society, shall be written.\*

4. The President or Chairman of the Council for the time being shall open the cover on which the motto designating the Essay to which the Prize has been awarded is written, and shall declare the name of the author.

5. The Chairman of the Journal Committee shall alone be empowered to open the motto-paper of any Essay not obtaining the Prize, that he may think likely to be useful for the Society's objects; with a view of consulting the writer confidentially as to his willingness to place such Essay at the disposal of the Journal Committee.

6. The copyright of all Essays gaining Prizes shall belong to the Society, who shall accordingly have the power to publish the whole or any part of such Essays; and the other Essays will be returned on the application of the writers; but the Society do not make themselves responsible for their loss.

7. The Society are not bound to award a prize unless they consider one of the Essays deserving of it.

8. In all reports of experiments the expenses shall be accurately detailed.

9. The imperial weights and measures only are those by which calculations are to be made.

10. No prize shall be given for any Essay which has been already in print.

11. Prizes may be taken in money or plate, at the option of the successful candidate.

12. All Essays must be addressed to the Secretary, at the house of the Society, on or before the 1st of March, 1867.

---

\* Competitors are requested to write their motto on the enclosed paper on which their names are written, as well as on the outside of the envelope.

## Members' Privileges of Chemical Analysis.

THE Council have fixed the following rates of Charge for Analyses to be made by the Consulting Chemist for the *bonâ-fide* use of Members of the Society; who (to avoid all unnecessary correspondence) are particularly requested, when applying to him, to mention the kind of analysis they require, and to quote its number in the subjoined schedule. The charge for analysis, together with the carriage of the specimens, must be paid to him by members at the time of their application.

No. 1.—An opinion of the genuineness of Peruvian guano, bone-dust, or oil-cake (each sample) .. .. .	5s.
„ 2.—An analysis of guano; showing the proportion of moisture, organic matter, sand, phosphate of lime, alkaline salts, and ammonia .. .. .	10s.
„ 3.—An estimate of the value (relatively to the average of samples in the market) of sulphate and muriate of ammonia, and of the nitrates of potash and soda .. .. .	10s.
4.—An analysis of superphosphate of lime for soluble phosphates only .. .. .	10s.
„ 5.—An analysis of superphosphate of lime, showing the proportions of moisture, organic matter, sand, soluble and insoluble phosphates, sulphate of lime, and ammonia ..	£1.
„ 6.—An analysis (sufficient for the determination of its agricultural value) of any ordinary artificial manure .. .. .	£1.
„ 7.—Limestone:—the proportion of lime, 7s. 6 <i>l.</i> ; the proportion of magnesia, 10s.; the proportion of lime and magnesia .. .. .	15s.
„ 8.—Limestone or marls, including carbonate, phosphate, and sulphate of lime, and magnesia with sand and clay ..	£1.
„ 9.—Partial analysis of a soil, including determinations of clay, sand, organic matter, and carbonate of lime .. .. .	£1.
„ 10.—Complete analysis of a soil .. .. .	£3.
„ 11.—An analysis of oil-cake, or other substance used for feeding purposes; showing the proportion of moisture, oil, mineral matter, albuminous matter, and woody fibre; as well as of starch, gum, and sugar, in the aggregate ..	£1.
„ 12.—Analyses of any vegetable product .. .. .	£1.
„ 13.—Analyses of animal products, refuse substances used for manure, &c. .. .. .	from 10s. to 30s.
„ 14.—Determination of the “hardness” of a sample of water before and after boiling .. .. .	10s.
„ 15.—Analysis of water of land drainage, and of water used for irrigation .. .. .	£2.
„ 16.—Determination of nitric acid in a sample of water .. .. .	£1.

N.B.—*The above Scale of Charges is not applicable to the case of persons commercially engaged in the Manufacture or Sale of any Substance sent for Analysis.*

The Address of the Consulting Chemist of the Society is, Dr. AUGUSTUS VOELCKER, 11, Salisbury Square, London, E.C., to which he requests that all letters and parcels (postage and carriage paid) should be directed.

## Members' Veterinary Privileges.

### I.—SERIOUS OR EXTENSIVE DISEASES.

No. 1. Any Member of the Society who may desire professional attendance and special advice in cases of serious or extensive disease among his cattle, sheep, or pigs, and will address a letter to the Secretary, will, by return of post, receive a reply stating whether it be considered necessary that Professor Simonds, the Society's Veterinary Inspector, should visit the place where the disease prevails.

No. 2. The remuneration of the Inspector will be 2*l.* 2*s.* each day as a professional fee, and 1*l.* 1*s.* each day for personal expenses; and he will also be allowed to charge the cost of travelling to and from the locality where his services may have been required. The fees will be paid by the Society, but the travelling expenses will be a charge against the applicant. This charge may, however, be reduced or remitted altogether at the discretion of the Council, on such step being recommended to them by the Veterinary Committee.

No. 3. The Inspector, on his return from visiting the diseased stock, will report to the Committee, in writing, the results of his observations and proceedings, which Report will be laid before the Council.

No. 4. When contingencies arise to prevent a personal discharge of the duties confided to the Inspector, he may, subject to the approval of the Committee, name some competent professional person to act in his stead, who shall receive the same rates of remuneration.

### II.—ORDINARY OR OTHER CASES OF DISEASE.

Members may obtain the attendance of the Veterinary Inspector on any case of disease by paying the cost of his visit, which will be at the following rate, viz., 2*l.* 2*s.* per diem, and travelling expenses.

### III.—CONSULTATIONS WITHOUT VISIT.

Personal consultation with Veterinary Inspector .. .. .	5 <i>s.</i>
Consultation by letter .. .. .	5 <i>s.</i>
Consultation necessitating the writing of three or more letters.	10 <i>s.</i>
Post-mortem examination, and report thereon .. .. .	10 <i>s.</i>

A return of the number of applications during each half-year being required from the Veterinary Inspector.

### IV.—ADMISSION OF DISEASED ANIMALS TO THE VETERINARY COLLEGE; INVESTIGATIONS, LECTURES, AND REPORTS.

No. 1. All Members of the Society have the privilege of sending cattle, sheep, and pigs to the Infirmary of the Royal Veterinary College, on the same terms as if they were Members of the College; viz., by paying for the keep and treatment of cattle 10*s.* 6*d.* per week each animal, and for sheep and pigs "a small proportionate charge to be fixed by the Principal according to circumstances."

No. 2. The College has also undertaken to investigate such particular classes of disease, or special subjects connected with the application of the Veterinary art to cattle, sheep, and pigs, as may be directed by the Council.

No. 3. In addition to the increased number of lectures now given by Professor Simonds—the Lecturer on Cattle Pathology—to the pupils in the Royal Veterinary College, he will also deliver such lectures before the Members of the Society, at their house in Hanover Square, as the Council shall decide.

No. 4. The Royal Veterinary College will from time to time furnish to the Council a detailed Report of the cases of cattle, sheep, and pigs treated in the Infirmary.

23











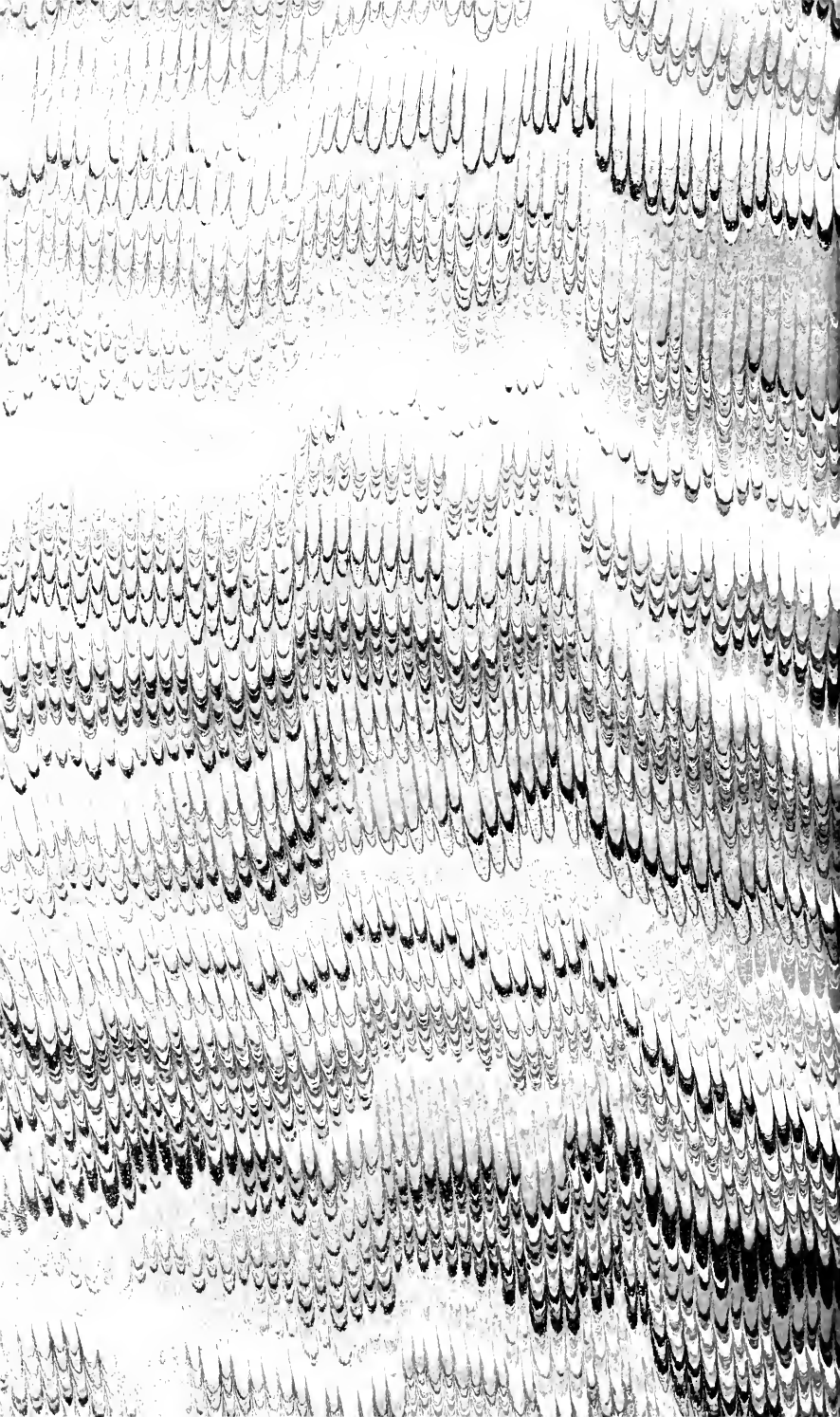



3 5185 00257 6575

