

ROY 6480

262.4

Library of the Museum
OF
COMPARATIVE ZOÖLOGY,
AT HARVARD COLLEGE, CAMBRIDGE, MASS.

The gift of the *Royal Microscop-
ical Society*

No. 6994
Sept. 17, 1891 - Jan 12, 1892



JOURNAL
OF THE
ROYAL
MICROSCOPICAL SOCIETY;

CONTAINING ITS TRANSACTIONS AND PROCEEDINGS,

AND A SUMMARY OF CURRENT RESEARCHES RELATING TO
ZOOLOGY AND BOTANY
(principally Invertebrata and Cryptogamia),
MICROSCOPY, &c.

Edited by

F. JEFFREY BELL, M.A.,

*One of the Secretaries of the Society
and Professor of Comparative Anatomy and Zoology in King's College ;*

WITH THE ASSISTANCE OF THE PUBLICATION COMMITTEE AND

A. W. BENNETT, M.A., B.Sc., F.L.S.,

Lecturer on Botany at St. Thomas's Hospital,

R. G. HEBB, M.A., M.D. (Cantab.), AND

J. ARTHUR THOMSON, M.A.,

Lecturer on Zoology in the School of Medicine,

Edinburgh,

FELLOWS OF THE SOCIETY.

FOR THE YEAR

1891.

Part 2.



PUBLISHED FOR THE SOCIETY BY
WILLIAMS & NORGATE,
Sm LONDON AND EDINBURGH.



The Journal is issued on the third Wednesday of
February, April, June, August, October, and December.

1891. Part 4.

AUGUST.

{ To Non-Fellows,
Price 5s.

6994.

JOURNAL
OF THE
ROYAL
MICROSCOPICAL SOCIETY;

CONTAINING ITS TRANSACTIONS AND PROCEEDINGS,

AND A SUMMARY OF CURRENT RESEARCHES RELATING TO

ZOOLOGY AND BOTANY

(principally Invertebrata and Cryptogamia),

MICROSCOPY, &c.

Edited by

F. JEFFREY BELL, M.A.,

One of the Secretaries of the Society

and Professor of Comparative Anatomy and Zoology in King's College;

WITH THE ASSISTANCE OF THE PUBLICATION COMMITTEE AND

A. W. BENNETT, M.A., B.Sc., F.L.S.,

Lecturer on Botany at St. Thomas's Hospital,

R. G. HEBB, M.A., M.D. (Cantab.), AND

J. ARTHUR THOMSON, M.A.,

Lecturer on Zoology in the School of Medicine,

Edinburgh,

FELLOWS OF THE SOCIETY.



WILLIAMS & NORGATE,

57 LONDON AND EDINBURGH.

CONTENTS.

TRANSACTIONS OF THE SOCIETY—

	PAGE
VII.—ON THE STRUCTURE OF CERTAIN DIATOM-VALVES AS SHOWN BY SECTIONS OF CHARGED SPECIMENS. By C. Haughton Gill, F.C.S., F.R.M.S. (Plate VIII.)	441
VIII.—A NEW ILLUMINATING APPARATUS. By E. M. Nelson, F.R.M.S. (Figs. 51 and 52)	443

SUMMARY OF CURRENT RESEARCHES.

ZOOLOGY.

A. VERTEBRATA:—Embryology, Histology, and General.

a. Embryology.

FOL, M.H.— <i>Fecundation</i>	447
KLEBS, E.— <i>Comparative Anatomy of Placenta</i>	448
HENRICIUS, G.— <i>Placenta of the Cat</i>	448
WENCKEBACH, K. F.— <i>Gastrulation in Lacerta agilis</i>	449
MITSUKURI, K.— <i>Fetal Membranes in Chelonia</i>	449
WATERS, B. H.— <i>Primitive Segmentation of Vertebrate Brain</i>	449

b. Histology.

SCHÄFER, E. A.— <i>Structure of Amœboid Protoplasm</i>	450
MACALLUM, A. B.— <i>Morphology and Physiology of the Cell</i>	450
GÖPPERT, E.— <i>Indirect Fragmentation</i>	451
MÜLLER, H. F.— <i>History of Blood-corpuscles</i>	451
LWOFF, B.— <i>Origin of the Fibrillæ in Connective Tissue</i>	451

c. General.

PARKER, T. JEFFERY— <i>Elementary Biology</i>	451
SCHIMKEWITSCH, W.— <i>Classification of Animal Kingdom</i>	452

B. INVERTEBRATA.

KOROTNEFF, A.— <i>Zoological Paradoxes</i>	453
HERDMAN, W. A.— <i>Biological Results of Cruise of the 'Argo'</i>	454

Mollusca.

b. Pteropoda.

KNIPOWITSCH, N.— <i>Development of Clione limacina</i>	454
--	-----

c. Gastropoda.

CONKTON, E. G.— <i>Embryology of Crepidula and Urosalpinx</i>	454
WILLEM, V.— <i>Eyes of Pulmonata Basommatophora</i>	455

d. Lamellibranchiata.

LATTER, O. H.— <i>Anodon and Unio</i>	455
---	-----

Molluscoida.

a. Tunicata.

HERDMAN, W. A.— <i>Ecteinascidia and other Clavelinidæ</i>	456
GARSTANG, W.— <i>Tunicata of Plymouth</i>	456

b. Bryozoa.

DAVENPORT, C. B.— <i>Budding in Bryozoa</i>	456
HARMER, S. F.— <i>Regeneration of Lost Parts in Bryozoa</i>	457
" " <i>Origin of Embryos in Ovicells of Cyclostomatous Polyzoa</i>	457
OKA, A.— <i>Freshwater Polyzoa</i>	457

Arthropoda.

JAWOROWSKI, A.— <i>Extremities of Embryo of Arachnids and Insects</i>	458
---	-----

	PAGE
a. Insecta.	
COSTE, F. H. PERRY— <i>Chemistry of Insect Colours</i>	458
HENKING, H.— <i>Early Stages of Development in Eggs of Insects</i>	461
PACKARD, A. S.— <i>Insects injurious to Forest and Shade Trees</i>	461
COBB, N. A., & A. SIDNEY OLLIFF— <i>Insect-larva eating Rust on Wheat and Flax</i>	461
BATAILLON, E.— <i>Role of Nucleus in Formation of Muscular Reticulum in Larva of Phrygane</i>	461
KNATZ, L.— <i>Absence of Wings in the Females of many Lepidoptera</i>	462
FRIESE, H.— <i>Natural History of Solitary Bees</i>	462
β. Myriopoda.	
HERBST, C.— <i>Anatomy of Scutigera</i>	463
δ. Arachnida.	
KISHINOUE, KAMAKICHI— <i>Development of Araneina</i>	463
BIGULA, A.— <i>Mid-gut of Galeodidae</i>	463
McCOOK'S (H. C.) <i>American Spiders</i>	464
KARPELLES, L.— <i>External Characters of Mites</i>	465
SICHER, E.— <i>Embryology of Mites</i>	466
PACKARD, A. S.— <i>Brain of Limulus Polyphemus</i>	466
ε. Crustacea.	
BOUVIER, E. L.— <i>Arterial System of Crustacea</i>	466
WELDON, W. F. R.— <i>Renal Organs of Decapod Crustacea</i>	467
CANU, G.— <i>Female Reproductive Organs of Decapoda</i>	467
VIALANES, H.— <i>Compound Eye of Macrura</i>	468
HERRICK, F. H.— <i>Development of American Lobster</i>	468
LEBEDINSKY, J.— <i>Development of Daphnia from the Summer-egg</i>	469
Vermes.	
a. Annelida.	
JOURDAN, E.— <i>Innervation of Proboscis of Glycera</i>	469
BENHAM, W. B.— <i>Nephridium of Lumbricus and its Blood-supply</i>	470
RANDOLPH, H.— <i>Regeneration of Tail in Lumbricus</i>	470
BEDDARD, F. E.— <i>New Earthworm</i>	471
" " <i>Libyodrilus</i>	471
BÜRGER, O.— <i>Embryology of Nephelis</i>	471
β. Nemathelminthes.	
BÜRGER, O.— <i>Nectonema agile</i>	472
COBB, N. A.— <i>Anticomma</i>	472
γ. Platyhelminthes.	
GOTI, SEITARO— <i>Diplozoon nipponicum</i>	472
WOODWORTH, W. M.— <i>Structure of Phagocata gracilis</i>	473
HARMER, S. F.— <i>Rhynchodesmus terrestris</i>	473
DENDY, A.— <i>Victorian Land Planarians</i>	474
SAINT-REMY, G.— <i>Genital Organs of Tristomidæ</i>	474
BELL, F. JEFFREY— <i>Tristomum histiophori</i>	475
HASWELL, W. A.— <i>Remarkable Flat-worm parasitic in Golden Frog</i>	475
LOMINSKY— <i>Symbiosis of Echinococcus and Coccidia</i>	475
δ. Incertæ Sedis.	
MORGAN, T. H.— <i>Anatomy and Transformation of Tornaria</i>	475
Echinodermata.	
FIELD, G. W.— <i>Embryology of Asterias vulgaris</i>	476
BROOKS, W. K.— <i>Early Stages of Echinoderms</i>	477
PERRIER, E.— <i>Starfishes collected by the 'Hirondelle'</i>	477
LUDWIG, H.— <i>Classification of Holothurians</i>	477
HARTLAUB, C.— <i>Comatulids of Indian Archipelago</i>	479
BELL, F. JEFFREY— <i>British Species of Asterias</i>	479
Cœlenterata.	
CARLGREN, O.— <i>Protanthea—a new Actinian</i>	479
" " <i>Bolocera</i>	479
KOCH, G. V.— <i>Relation of Septa of Parent to those of Bud in Blastotrochus</i>	480

	PAGE
FAUROT, L.— <i>Cerianthus membranaceus</i>	480
BELL, F. JEFFREY— <i>Antipatharia</i>	480
HICKSON, S. J.— <i>Ampullæ of Millepora Murrayi</i>	480
" <i>Male Gonangia of Distichopora and Allopore</i>	481
BROOKS, W. K., & E. G. CONKLIN— <i>Structure and Development of Gonophores</i>	481
SLOAN, A. D.— <i>Halistemma in British Waters</i>	481
M'MURRICH, J. PLAYFAIR— <i>Development of Cyanea arctica</i>	481
BIGELOW, R. P.— <i>Physiology of 'Portuguese Man-of-War'</i>	482
SPENCER, W. BALDWIN— <i>New Family of Hydroida</i>	482
NUSSBAUM, M.— <i>Trembley's Experiments with Hydra</i>	483

Protozoa.

DANTEC, LE— <i>Intracellular Digestion in Protozoa</i>	483
ISCHIKAWA, C.— <i>Conjugation in Noctiluca</i>	484
PFEIFFER, L.— <i>Pathogenic Protozoa</i>	484

BOTANY.

A. GENERAL, including the Anatomy and Physiology of the Phanerogamia.

a. Anatomy.

GRAVIS, A.— <i>Anatomy of Plants</i>	485
WIESNER'S (J.) <i>Anatomy and Organography</i>	485

(1) Cell-structure and Protoplasm.

STEINBRINCK, C.— <i>Hygroscopic Swelling and Shrinking of Vegetable Membranes</i>	485
---	-----

(2) Other Cell-contents (including Secretions).

MER, E.— <i>Distribution of Starch at different periods of the year in woody plants</i>	485
BUSCALIONI, L.— <i>Structure of Starch-grains in Maize</i>	486
HARTLEY, W. N.— <i>Spectrum of Chlorophyll</i>	486
LINOSLER, G.— <i>Aspergillin—a Vegetable Hæmatin</i>	486

(3) Structure of Tissues.

SCHUMANN, P.— <i>Variations in the Anatomical Structure of the same Species</i>	487
SCHUPPAN, P.— <i>Wood of Conifers</i>	487
KNY, L.— <i>Abnormal Structure of Annual Rings</i>	487
MÜLLER, C.— <i>"Sanio's Bands" in the Coniferæ</i>	488
GIBSON— <i>Suberin and Bark-cells</i>	488
SELIWANOW, T.— <i>Reactions of Lignin</i>	488
DEVAUX, H.— <i>Hypertrophy of Lenticels</i>	488
LESAGE, P.— <i>Development of the Root</i>	489
" " <i>Differentiation of the Phloem in the Root</i>	489
HÉRAIL, J.— <i>Medullary Phloem in the Root</i>	489
BORDET— <i>Anatomical Researches on Carex</i>	489
LEONHARD, M.— <i>Structure of Apocynaceæ</i>	489

(4) Structure of Organs.

NOLL, F.— <i>Influence of External Factors on the Formation and Form of Organs</i>	490
CANDOLLE, C. DE— <i>Epiphyllous Inflorescences</i>	490
MORENOS, D. LEVI— <i>Variations in the Flower</i>	490
FOERSTE, A. F.— <i>Formation of Flower-buds of Spring-blossoming Plants</i>	490
DUCHARTRE, P.— <i>Inferior Ovaries</i>	491
HALSTED, B. D., & D. G. FAIRCHILD— <i>Influence of Moisture on Dehiscent Fruits</i>	491
HUTH, E.— <i>Geocarpous, Amphicarpous, and Heterocarpous Fruits</i>	491
DEVAUX, H.— <i>Porosity of the Fruit of Cucurbitaceæ</i>	491
BRANDZA, M.— <i>Development of the Integument of the Seed</i>	491
D'ARBAUMONT, J.— <i>Integuments of the Seed of Cruciferæ</i>	492
SAUVAGEAU, C.— <i>Stem of Zostera</i>	492
ROSENPLENTER, B.— <i>Spiral Phyllotaxis</i>	493
WEISSE, A.— <i>Leaf-spirals in the Coniferæ</i>	493
LOTHELIER, A.— <i>Influence of Light on the production of Spines</i>	493
BUCHENAU, F.— <i>Bulbs and Tubers in the Juncaceæ</i>	493
DEVAUX, H.— <i>Growth of Root-hairs</i>	493
KUNTZE, G.— <i>Anatomy of the Malvaceæ</i>	494

β. Physiology.

(1) Reproduction and Germination.		PAGE
MOEBIUS, M.— <i>Results of continual Non-sexual Propagation</i>		494
HILL, E. G.— <i>Cross-fertilization and Self-fertilization</i>		494
KÖRNICKE— <i>Autogenetic and Heterogenetic Fertilization</i>		494
BEKETOW, A.— <i>Proterandry in the Umbelliferae</i>		495
BOTTINI, A.— <i>Reproduction of Hydromystria</i>		495
VRIES, H. DE— <i>Duration of the Life of certain Seeds</i>		495
MORRIS, D.— <i>Germination of the Sugar-cane</i>		495
BOWERS, H.— <i>Germination of Hydrastis Canadensis</i>		495
(2) Nutrition and Growth (including Movements of Fluids).		
CHATIN, A.— <i>Biology of Parasites</i>		495
VÖCHTING, H.— <i>Assimilation of Leaves</i>		496
ATWATER, W. O., & C. D. WOODS— <i>Absorption of Atmospheric Nitrogen by Plants</i> ..		496
FRUNET, A.— <i>Perforation of Potatoes by the Rhizome of Grasses</i>		496
(3) Irritability.		
ARCANGELI, G.— <i>Compass-plants</i>		496
(4) Chemical Changes (including Respiration and Fermentation).		
STICH, C.— <i>Respiration of Plants</i>		497
DEVAUX, H.— <i>Respiration in the interior of massive tissues</i>		497
PEYRON, J.— <i>Composition of the internal Atmosphere of Plants</i>		497
MONTEVERDE, N.— <i>Influence of the Carbohydrates on the Formation of Asparagin</i> ..		497
LESAGE, P.— <i>Influence of Saltness on the Formation of Starch in Vegetable Organs</i> <i>containing Chlorophyll</i>		498
VILLIERS, A.— <i>Transformation of Starch into Dextrin by the Butyric Ferment</i> ..		498
NICKEL, E.— <i>Tannins and Trioxybenzols</i>		498
γ. General.		
REGEL, R.— <i>Influence of External Factors on the Odour of Flowers</i>		498
LUDWIG, F.— <i>Relationship between Plants and Snails</i>		499
FRÜH, J.— <i>Constitution and Formation of Peat</i>		499

B. CRYPTOGAMIA.**Cryptogamia Vascularia.**

DANGEARD, P.— <i>Tmesipteris</i>	499
CAMPBELL, D. H.— <i>Archegone of Ferns</i>	500
VELENOVSKY, J.— <i>Rhizome of Ferns</i>	500
CAMPBELL, D. H.— <i>Apical Growth of Osmunda and Botrychium</i>	500
POIRAULT, G.— <i>Structure of Ophioglossaceæ</i>	500
NEWBERRY, J. S.— <i>Sphenophyllum</i>	500

Muscineæ.

BASTIT, E.— <i>Influence of the hygrometric state of the air on the position and function</i> <i>of the leaves of Mosses</i>	501
KRUCH, O.— <i>Sexual Organs and Impregnation in Riella</i>	501

Characeæ.

ZACHARIAS, E.— <i>Growth of the Cell-wall in Chara foetida</i>	501
--	-----

Algæ.

HARVEY-GIBSON, R. J.— <i>Cystocarps and Antherids of Catenella Opuntia</i>	502
BARTON, E. S.— <i>Galls on a Sea-weed</i>	502
DEBRAY, F.— <i>Structure and Development of Chylocladiæ</i>	502
WEST, W.— <i>Conjugation of the Zygnemaceæ</i>	502
DANGEARD, P. A., & E. DE WILDEMAN— <i>Clamp-organs of the Conjugatæ</i>	502
GAY, F.— <i>Mode of Attachment of Cladophora</i>	503
HARIOT, P.— <i>Pleiocarpous Species of Trentepohlia</i>	503
DE-TONI'S <i>Sylloge Algarum</i>	503

Fungi.

ELFYNG, F.— <i>Influence of Light on the Growth of Fungi</i>	504
COOKE, M. C.— <i>Dispersion and Germination of the Spores of Fungi</i>	504
BOURQUELOT, E.— <i>Carbohydrates in Fungi</i>	504

	PAGE
DANGEARD, P. A.— <i>Endotrophic Mycorrhiza</i>	504
WEYRE, A. DE— <i>Chatostylum</i>	504
LAMBOTTE, E.— <i>Mycele and Protospores of Sphærotheca Castagnei v. humilis and of Pleospora herbarum v. Galii aparinis</i>	505
WORONIN, M.—“ <i>Taumel-getreide</i> ”	505
LAGERHEIM, G. v.— <i>Musk-fungus</i>	505
VIALA, P.— <i>New Vine-disease</i>	505
MINKS, A.— <i>Atichia</i>	505
CRAMER, C.— <i>Chlorodictyon foliosum and Ramalina reticulata</i>	505
WILLEY, H.— <i>Arthonia</i>	505
ATKINSON, G. F.— <i>Black-rust of Cotton</i>	505
BRESSADOLA, I.— <i>New Genus of Tuberculariæ</i>	506
ROZE, E.— <i>Urocystis Viola and Ustilago antherarum</i>	506
TUBEUF, C. v.— <i>Gymnosporangium</i>	506
HALSTED, B. D.— <i>New Anthracnose of Pepper</i>	506
THAXTER, R.— <i>Sigmoideomyces, a new Genus of Hyphomycetes</i>	506
FISCHER, E., F. COHN, & J. SCHROETER— <i>Sclerote-forming Fungi</i>	507
ELLS, J. B., & B. EVERHART— <i>Sclerotoid Coprinus</i>	507
MASSE, G.— <i>Mycodendron, a new Genus of Hymenomyces</i>	507

Protophyta.

a. Schizophycæ.

HARIOT, P.— <i>Polycoccus</i>	508
MACCHIATI, L.— <i>Movement and Reproduction of Diatoms</i>	508
SCHMIDT'S <i>Atlas der Diatomaceen-Kunde</i>	508

ß. Schizomycetes.

LEUBUSCHER, G.— <i>Influence of the Digestive Secretions on Bacteria</i>	509
BUCHNER— <i>Presence of Bacteria in normal Vegetable Tissue</i>	509
SANARELLI, G.— <i>Bacillus hydrophilus fuscus</i>	509
LAURENT— <i>Variability of the Red Bacillus of Kiel Water</i>	510
EPPINGER, H.— <i>Pseudotuberculosis produced by a pathogenic Cladotrix</i>	511
AMANN, J.— <i>Effect of the Koch Treatment on the Tubercle Bacilli in Sputum</i>	511
FREUDENREICH, E. DE— <i>Spongy Cheese</i>	511
CANESTRINI, G.— <i>New Bacillus in Bees</i>	512
FRAENKEL & PFEIFFER'S <i>Microphotographic Atlas of Bacteriology</i>	512
KIANOWSKY, R.— <i>Anti-bacterial Properties of the Gastric Juice</i>	512
BORET, V.— <i>New Bacillus from the Small Intestine</i>	512
OKADA— <i>Pathogenic Bacillus obtained from Floor-dust</i>	513
BAUMGARTEN'S (P.) <i>Report on Micro-organisms</i>	513
GIUNTI, M.— <i>Action of Light on Acetic Fermentation</i>	513
PANZINI, S.— <i>Bacteria in Sputum</i>	513
WOODHEAD, G. S.— <i>Bacteria and their Products</i>	514
BIBLIOGRAPHY	514

MICROSCOPY.

a. Instruments, Accessories, &c.

(1) Stands.

BAKER'S <i>Student's Microscope</i> (Fig. 53)	516
CZAPSKI, S.— <i>Zeiss's Crystullographic and Petrographical Microscopes</i> (Figs. 54 & 55)	516

(2) Eye-pieces and Objectives.

KLÖNNE & MÜLLER'S <i>New Objective Changer</i>	519
--	-----

(3) Illuminating and other Apparatus.

BRUNNÉE, R.— <i>On a new arrangement in Microscopes for the rapid change from parallel to convergent light</i> (Figs. 56 and 57)	519
SCHIEFFERDECKER, P.— <i>Kochs-Wolz Improved Microscope Lamp</i> (Figs. 58 and 59)	520
PFEFFER, W.— <i>New Hot Stage and Accessories</i> (Figs. 60-63)	521
" " <i>Water Thermostat</i> (Fig. 64)	524

(4) Photomicrography.

BAKER'S <i>Photomicrographic Apparatus</i> (Fig. 65)	525
--	-----

(6) Miscellaneous.

	PAGE
CURTICE, COOPER— <i>A Method of Drawing Microscopic Objects by the Use of Coordinates</i>	527
CARL ZEISS-STIFTUNG in Jena	528
DEATH of Mr. Mayall	529
The late Mr. Tuffen West, F.R.M.S.	529
Joseph Leidy	532

β. Technique.

(1) Collecting Objects, including Culture Processes.

BUJWID, O.— <i>Preparing Tuberculin</i>	534
GESSARD— <i>Preparing Pepton-agar for studying Pyocyanin</i>	534
FOWLER, G. R.— <i>Simple Method for sterilizing Catgut</i>	538

(2) Preparing Objects.

THOMAS, M. B.— <i>Dehydrating Apparatus (Fig. 66)</i>	535
OBREGIA, A.— <i>Method for fixing Preparations treated by Sublimite or Silver (Golgi's Method)</i>	536
HAUG, R.— <i>Decalcification of Bone</i>	537
HOYER, H.— <i>Demonstrating Mucin in Tissues</i>	538
GRANDIS, V.— <i>Preparing and Examining Glandular Epithelium of Insects</i>	538
RITTER, R.— <i>Preparing and Staining the Ova of Chironomus</i>	539
CROSA, F.— <i>Preserving Larvæ of Lepidoptera with their Colour</i>	539
OKA, A.— <i>Method of observing Pectinatella gelatinosa</i>	539
APÁTHY, S.— <i>Demonstrating Tactile Papillæ of Hirudo medicinalis</i>	540
CAMERANO, L.— <i>Examining Ova of Gordius</i>	540
COBB, N. A.— <i>Study of Nematodes</i>	540
WOODWORTH, W. M.— <i>Mode of Studying Phagocata</i>	541
PERRY, S. H.— <i>Study of Rhizopods</i>	541
HUMPHREY, J. E.— <i>Demonstration of Cilia of Zoospores</i>	541

(3) Cutting, including Imbedding and Microtomes.

GAGE, S. H., & G. S. HOPKINS— <i>Preparation and Imbedding of the Embryo Chick (Figs. 67 and 68)</i>	541
WEBSTER, J. C.— <i>An improved Method of preparing large Sections of Tissues for Microscopic Examination</i>	544
BESSEY, C. E.— <i>Sections of Staminate Cone of Scotch Pine</i>	546

(4) Staining and Injecting.

STEVENSON, A. F., & D. BRUCE— <i>New Method of Injecting Fluids into the peritoneal cavity of animals</i>	547
VALENTE, G., & G. D'ABUNDO— <i>Demonstrating the Cerebral Vessels of Mammalia</i>	547
HAUG, R.— <i>Three useful Staining Solutions</i>	547
DOGIEL, A. S.— <i>Fixation of the Stain in Methylene-blue Preparations</i>	548
HAUG, R.— <i>Hints on Preparation of Tumours injected during life with anilin pigments</i>	548
CIAGLIŃSKI, A.— <i>Preparing and Staining Sections of Spinal Cord</i>	549
HÖNIGGER, J.— <i>Manipulating and Staining old and over-hardened Brains</i>	550
NONIEWICZ, E.— <i>Staining Bacilli of Glanders</i>	550
EVANS, J. FENTON— <i>Staining Pathogenic Fungus of Malaria</i>	551
VINASSA, C.— <i>Characteristics of some Anilin Dyes</i>	551

(5) Mounting, &c.

PFEIFFER, F.— <i>Mounting Botanical Preparations in Venetian Turpentine</i>	551
---	-----

(6) Miscellaneous.

PILLSBURY, J. H.— <i>An Inexpensive Reagent Block (Fig. 69)</i>	552
BELZUG, E.— <i>Microscopic Diagnosis of Citric Acid in Plants</i>	553
ERSTEIN, W., & A. NICOLAÏER— <i>Artificial Preparation of the Sphæroliths of Uric Acid Salts</i>	553

PROCEEDINGS OF THE SOCIETY	554
------------------------------------	-----

APERTURE TABLE.

Numerical Aperture. ($n \sin u = a.$)	Corresponding Angle ($2u$) for			Limit of Resolving Power, in Lines to an Inch.			Illuminating Power. (a^2 .)	Penetrating Power ($\frac{1}{a}$)
	Air ($n = 1.00$.)	Water ($n = 1.33$.)	Homogeneous Immersion ($n = 1.52$.)	White Light. ($\lambda = 0.5269 \mu$, Line E.)	Monochromatic (Blue) Light. ($\lambda = 0.4861 \mu$, Line F.)	Photography. ($\lambda = 0.4000 \mu$, Near Line h.)		
1.52	180° 0'	146,543	158,845	193,037	2.310	.658
1.51	166° 51'	145,579	157,800	191,767	2.280	.662
1.50	161° 23'	144,615	156,755	190,497	2.250	.667
1.49	157° 12'	143,651	155,710	189,227	2.220	.671
1.48	153° 39'	142,687	154,665	187,957	2.190	.676
1.47	150° 32'	141,723	153,620	186,687	2.161	.680
1.46	147° 42'	140,759	152,575	185,417	2.132	.685
1.45	145° 6'	139,795	151,530	184,147	2.103	.690
1.44	142° 39'	138,830	150,485	182,877	2.074	.694
1.43	140° 22'	137,866	149,440	181,607	2.045	.694
1.42	138° 12'	136,902	148,395	180,337	2.016	.709
1.41	136° 8'	135,938	147,350	179,067	1.988	.709
1.40	134° 10'	134,974	146,305	177,797	1.960	.714
1.39	132° 16'	134,010	145,260	176,527	1.932	.719
1.38	130° 26'	133,046	144,215	175,257	1.904	.725
1.37	128° 40'	132,082	143,170	173,987	1.877	.729
1.36	126° 58'	131,118	142,125	172,717	1.850	.735
1.35	125° 18'	130,154	141,080	171,447	1.823	.741
1.34	123° 40'	129,189	140,035	170,177	1.796	.746
1.33	..	180° 0'	122° 6'	128,225	138,989	168,907	1.769	.752
1.32	..	165° 56'	120° 33'	127,261	137,944	167,637	1.742	.758
1.30	..	155° 38'	117° 35'	125,333	135,854	165,097	1.690	.769
1.28	..	148° 42'	114° 44'	123,405	133,764	162,557	1.638	.781
1.26	..	142° 39'	111° 59'	121,477	131,674	160,017	1.588	.794
1.24	..	137° 36'	109° 20'	119,548	129,584	157,477	1.538	.806
1.22	..	133° 4'	106° 45'	117,620	127,494	154,937	1.488	.820
1.20	..	128° 55'	104° 15'	115,692	125,404	152,397	1.440	.833
1.18	..	125° 3'	101° 50'	113,764	123,314	149,857	1.392	.847
1.16	..	121° 26'	99° 29'	111,835	121,224	147,317	1.346	.862
1.14	..	118° 0'	97° 11'	109,907	119,134	144,777	1.300	.877
1.12	..	114° 44'	94° 55'	107,979	117,044	142,237	1.254	.893
1.10	..	111° 36'	92° 43'	106,051	114,954	139,698	1.210	.909
1.08	..	108° 36'	90° 34'	104,123	112,864	137,158	1.166	.926
1.06	..	105° 42'	88° 27'	102,195	110,774	134,618	1.124	.943
1.04	..	102° 53'	86° 21'	100,266	108,684	132,078	1.082	.962
1.02	..	100° 10'	84° 18'	98,338	106,593	129,538	1.040	.980
1.00	180° 0'	97° 31'	82° 17'	96,410	104,503	126,998	1.000	1.000
0.98	157° 2'	94° 56'	80° 17'	94,482	102,413	124,458	.960	1.020
0.96	147° 29'	92° 24'	78° 20'	92,554	100,323	121,918	.922	1.042
0.94	140° 6'	89° 56'	76° 24'	90,625	98,233	119,378	.884	1.064
0.92	133° 51'	87° 32'	74° 30'	88,697	96,143	116,838	.846	1.087
0.90	128° 19'	85° 10'	72° 36'	86,769	94,053	114,298	.810	1.111
0.88	123° 17'	82° 51'	70° 44'	84,841	91,963	111,758	.774	1.136
0.86	118° 38'	80° 34'	68° 54'	82,913	89,873	109,218	.740	1.163
0.84	114° 17'	78° 20'	67° 6'	80,984	87,783	106,678	.706	1.190
0.82	110° 10'	76° 8'	65° 18'	79,056	85,693	104,138	.672	1.220
0.80	106° 16'	73° 58'	63° 31'	77,128	83,603	101,598	.640	1.250
0.78	102° 31'	71° 49'	61° 45'	75,200	81,513	99,058	.608	1.282
0.76	98° 56'	69° 42'	60° 0'	73,272	79,423	96,518	.578	1.316
0.74	95° 28'	67° 37'	58° 16'	71,343	77,333	93,979	.548	1.351
0.72	92° 6'	65° 32'	56° 32'	69,415	75,242	91,439	.518	1.389
0.70	88° 51'	63° 31'	54° 50'	67,487	73,152	88,899	.490	1.429
0.68	85° 41'	61° 30'	53° 9'	65,559	71,062	86,359	.462	1.471
0.66	82° 36'	59° 30'	51° 28'	63,631	68,972	83,819	.436	1.515
0.64	79° 36'	57° 31'	49° 48'	61,702	66,882	81,279	.410	1.562
0.62	76° 38'	55° 34'	48° 9'	59,774	64,792	78,739	.384	1.613
0.60	73° 44'	53° 38'	46° 30'	57,846	62,702	76,199	.360	1.667
0.58	70° 54'	51° 42'	44° 51'	55,918	60,612	73,659	.336	1.724
0.56	68° 6'	49° 48'	43° 14'	53,990	58,522	71,119	.314	1.786
0.54	65° 22'	47° 54'	41° 37'	52,061	56,432	68,579	.292	1.852
0.52	62° 40'	46° 2'	40° 0'	50,133	54,342	66,039	.270	1.923
0.50	60° 0'	44° 10'	38° 24'	48,205	52,252	63,499	.250	2.000
0.45	53° 30'	39° 33'	34° 27'	43,385	47,026	57,149	.203	2.222
0.40	47° 9'	35° 0'	30° 31'	38,564	41,801	50,799	.160	2.500
0.35	40° 58'	30° 30'	26° 38'	33,744	36,576	44,449	.123	2.857
0.30	34° 56'	26° 4'	22° 46'	28,923	31,351	38,099	.090	3.333
0.25	28° 58'	21° 40'	18° 56'	24,103	26,126	31,749	.063	4.000
0.20	23° 4'	17° 18'	15° 7'	19,282	20,901	25,400	.040	5.000
0.15	17° 14'	12° 58'	11° 19'	14,462	15,676	19,050	.023	6.667
0.10	11° 29'	8° 38'	7° 34'	9,641	10,450	12,700	.010	10.000
0.05	5° 44'	4° 18'	3° 46'	4,821	5,252	6,350	.003	20.000

COMPARISON OF THE FAHRENHEIT AND CENTIGRADE THERMOMETERS.

Fahr.	Centigr.	Fahr.	Centigr.	Fahr.	Centigr.	Fahr.	Centigr.	Fahr.	Centigr.
212	100	158	70	104	40	50	10	- 4	- 20
210·2	99	156·2	69	102·2	39	48·2	9	- 5·8	- 21
210	98·89	156	68·89	102	38·89	48	8·89	- 6	- 21·11
208·4	98	154·4	68	100·4	38	46·4	8	- 7·6	- 22
208	97·78	154	67·78	100	37·78	46	7·78	- 8	- 22·22
206·6	97	152·6	67	98·6	37	44·6	7	- 9·4	- 23
206	96·67	152	66·67	98	36·67	44	6·67	- 10	- 23·33
204·8	96	150·8	66	96·8	36	42·8	6	- 11·2	- 24
204	95·56	150	65·56	96	35·56	42	5·56	- 12	- 24·44
203	95	149	65	95	35	41	5	- 13	- 25
202	94·44	148	64·44	94	34·44	40	4·44	- 14	- 25·56
201·2	94	147·2	64	93·2	34	39·2	4	- 14·8	- 26
200	93·33	146	63·33	92	33·33	38	3·33	- 16	- 26·67
199·4	93	145·4	63	91·4	33	37·4	3	- 16·6	- 27
198	92·22	144	62·22	90	32·22	36	2·22	- 18	- 27·78
197·6	92	143·6	62	89·6	32	35·6	2	- 18·4	- 28
196	91·11	142	61·11	88	31·11	34	1·11	- 20	- 28·89
195·8	91	141·8	61	87·8	31	33·8	1	- 20·2	- 29
194	90	140	60	86	30	32	0	- 22	- 30
192·2	89	138·2	59	84·2	29	30·2	- 1	- 23·8	- 31
192	88·89	138	58·89	84	28·89	30	- 1·11	- 24	- 31·11
190·4	88	136·4	58	82·4	28	28·4	- 2	- 25·6	- 32
190	87·78	136	57·78	82	27·78	28	- 2·22	- 26	- 32·22
188·6	87	134·6	57	80·6	27	26·6	- 3	- 27·4	- 33
188	86·67	134	56·67	80	26·67	26	- 3·33	- 28	- 33·33
186·8	86	132·8	56	78·8	26	24·8	- 4	- 29·2	- 34
186	85·56	132	55·56	78	25·56	24	- 4·44	- 30	- 34·44
185	85	131	55	77	25	23	- 5	- 31	- 35
184	84·44	130	54·44	76	24·44	22	- 5·56	- 32	- 35·56
183·2	84	129·2	54	75·2	24	21·2	- 6	- 32·8	- 36
182	83·33	128	53·33	74	23·33	20	- 6·67	- 34	- 36·67
181·4	83	127·4	53	73·4	23	19·4	- 7	- 34·6	- 37
180	82·22	126	52·22	72	22·22	18	- 7·78	- 36	- 37·78
179·6	82	125·6	52	71·6	22	17·6	- 8	- 36·4	- 38
178	81·11	124	51·11	70	21·11	16	- 8·89	- 38	- 38·89
177·8	81	123·8	51	69·8	21	15·8	- 9	- 38·2	- 39
176	80	122	50	68·2	20	14	- 10	- 40	- 40
174·2	79	120·2	49	66	19	12·2	- 11	- 41·80	- 41
174	78·89	120	48·89	66·4	18·89	12	- 11·11	- 42	- 41·11
172·4	78	118·4	48	64	18	10·4	- 12	- 43·60	- 42
172	77·78	118	47·78	64·6	17·78	10	- 12·22	- 44	- 42·22
170·6	77	116·6	47	62	17	8·6	- 13	- 45·40	- 43
170	76·67	116	46·67	62·8	16·67	8	- 13·33	- 46	- 43·33
168·8	76	114·8	46	60	16	6·8	- 14	- 47·20	- 44
168	75·56	114	45·56	60	15·56	6	- 14·44	- 48	- 44·44
167	75	113	45	59	15	5	- 15	- 49	- 45
166	74·44	112	44·44	58	14·44	4	- 15·56	- 50	- 45·56
165·2	74	111·2	44	57·2	14	3·2	- 16	- 50·80	- 46
164	73·33	110	43·33	56	13·33	2	- 16·67	- 52	- 46·67
163·4	73	109·4	43	55·4	13	1·4	- 17	- 52·60	- 47
162	72·22	108	42·22	54	12·22	0	- 17·78	- 54	- 47·78
161·6	72	107·6	42	53·6	12	- 0·4	- 18	- 54·40	- 48
160	71·11	106	41·11	52	11·11	- 2	- 18·89	- 56	- 48·89
159·8	71	105·8	41	51·8	11	- 2·2	- 19	- 56·20	- 49
								- 58	- 50

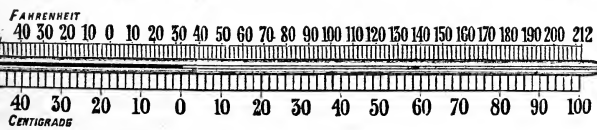

LANTERN READINGS.**OPTICAL LANTERNS.****DISSOLVING VIEWS.****SLIDES & LANTERNS ON HIRE & SALE.**

Scientific, Literary, Historical, Biographical, and many other subjects beautifully illustrated for the Lantern, with Readings to correspond. Lists gratis from

E. MARSHALL,

78, QUEEN VICTORIA STREET, LONDON, E.C.

C. REICHERT,

Vienna, VIII. Bennogasse 26,

MANUFACTURER OF

== **FIRST-CLASS** ==**MICROSCOPES AND OBJECTIVES,**
NEW SEMIAPOCHROMATICS.

Catalogues and Price Lists in English, French, Italian, and German.

ROYAL MICROSCOPICAL SOCIETY.

MEETINGS FOR 1891, at 8 p.m.

Wednesday, JANUARY 21	Wednesday, MAY 20
(Annual Meeting for Election of Officers and Council.)	„ JUNE 17
„ FEBRUARY 18	„ OCTOBER 21
„ MARCH 18	„ NOVEMBER 18
„ APRIL 15	„ DECEMBER 16

Fellows intending to exhibit any Instruments, Objects, &c., or to bring forward any Communication at the Ordinary Meetings, will much facilitate the arrangement of the business thereat if they will inform the Secretaries of their intention two clear days at least before the Meeting.

Authors of Papers printed in the Transactions are entitled to 20 copies of their communications *gratis*. Extra copies can be had at the price of 10s. 6d. per half-sheet of 8 pages, or less, including cover, for a minimum number of 50 copies, and 6s. per 100 plates, if plain. Prepayment by P.O.O. is requested.

JOURNAL
OF THE
ROYAL MICROSCOPICAL SOCIETY.

AUGUST 1891.

TRANSACTIONS OF THE SOCIETY.

VII.—*On the Structure of certain Diatom-valves as shown by sections of charged specimens.*

By C. HAUGHTON GILL, F.C.S., F.R.M.S.

(Read 15th April, 1891.)

PLATE VIII.

IN a paper which I had the honour to read before this Society on the 19th of March, 1890, it was demonstrated that the "striae, dots," &c., of very various forms of diatoms were cavities of some kind, inasmuch as they could be filled with opaque foreign matter, e. g. platinum or the sulphides of mercury or silver. I added, "Whether these lacunæ are complete perforations through the silicious test or mere pits or depressions on the inner or outer surface of the valve, or more or less flask-formed cavities communicating by one or more canals with the inner or outer surface, or with both, cannot at present be resolved with any degree of certainty in the case of those diatoms which have the finer markings."

Since writing the above I have found among my slides a few fragments of charged diatoms so tilted as to give a clear edge view of the fractured shell. Some of these I have photographed, and they seem to me to show clearly that the lacunæ in these cases at any rate extend from face to face and are not mere surface depressions.

Photograph No. 1, taken from a specimen of *Cocconema lanceolatum*, gives, at the points inclosed by the bracket, a picture of a broken edge which is not quite straight, and therefore not in sharp focus everywhere at once. It shows the mercurous sulphide filling the pores or lacunæ and extending, apparently, from face to face of the shell. The same thing is seen in optical section only and confused by interference lines in the other margin of the valve as photographed.

When examining the original slide (and others which I have not photographed) by help of a good 3 mm. apochromatic objective N.A. 1.4, and careful adjustment of the light, I think that I can detect the presence of a limiting film of silica, on the outer face at least, corresponding to the cell-cappings of the coccinodiscs.

Photo No. 2 shows the same things in the case of the more finely dotted *Stauroneis phœnicenteron*.

Photo No. 3 is taken from a valve of *Pleurosigma Balticum*. In this case, as the structure is so very minute, and as I have not been able to find even a second specimen presenting the same aspect to view, I bring forward an isolated example for what it is worth. As however the picture it gives is entirely in accordance with what we should expect to see, judging from analogy with the coarser forms cited and illustrated above, and about which no doubt can exist, I consider it is a substantially true representation, and that in this *Pleurosigma* at any rate the dots represent cavities which extend from face to face of the shell.

The question as to whether these pores are absolutely complete perforations through and through the walls of the valve or have any sort of operculum or capping on either or on both faces, as is the case with the large discoid diatoms, is one which can hardly be decided by optical means. But the way in which various precipitates are retained in the pores in resistance to violent agitation with water, leads me to incline strongly to the opinion that such "cappings" exist. Moreover, in the case of one large and coarsely marked form of *Epithemia* the "secondary markings," i. e. the perforations of the cappings, are plainly visible in an imperfectly charged specimen of which I now exhibit a photograph (No. 4).

I must apologize for again trespassing on your attention with such a threadbare subject as diatom markings, but plead that it is done in the hope of finally laying to rest a subject of controversy which has engaged a most disproportionate amount of attention.

There is indeed still one aspect in which the subject may even yet be regarded as of serious interest. So long as the structure of these much studied organisms remains in doubt, so long must a great feeling of uncertainty prevail as to the value to be attached to the interpretation of appearances presented by other minute structures under the Microscope.

Now, if by any means we attain to a feeling of comparative certainty as to the truthfulness of the visual impressions received from the Microscope in any one case of minute structure, we *pro tanto* increase our confidence in the reality of the things pictured to us in those cases where none but purely optical means are available in making out the subject under examination. This method of filling the pores of diatoms has rendered it certain that the conclusion previously arrived at by observers like Messrs. Flögel, Weiss, Van Heurck, H. L. Smith, Cox, Nelson, Morland, and others, viz. that the dots, &c., on diatoms were perforations or depressions, and not beads, was substantially correct, and that therefore the microscopic images on which they founded their opinions were at any rate approximately true images. Hence we derive the comforting assurance that we need not receive with utter distrust the conclusions arrived at by the study of microscopic images, even in those cases where the close approximation of minute structures must lead to the production of endless diffraction spectra.

VIII.—*A New Illuminating Apparatus.*

By E. M. NELSON, F.R.M.S.

(Read 20th May, 1891.)

IN the direction of monochromatic light very little has been done. This may be attributed to the unsatisfactory results already obtained. Who, for instance, has seen a critical image with monochromatic light? Many have witnessed attempts, and some of us have ourselves tried experiments. There has been one universal verdict to all these efforts—viz. that of dismal failure. The experiments have taken two forms: first, that of obtaining monochromatic blue light by interposing absorption media, the other by prism dispersion.

The first may be dismissed in a word: so far as is known there does not exist a medium that will only pass a blue ray. Ammonio-sulphate of copper passes any amount of red light, blue glass does the same. The examination with a spectroscope of the light which has passed through any of these absorbing media immediately dispels the idea that it is monochromatic. Before proceeding I may say that the best results in this direction were obtained by using two thicknesses of pot cobalt glass supplied by Messrs. Powell and Lealand. The spectrum through these curiously agrees with that through Rainey's light-modifier, which was composed of three different tints of glass; an account of which will be found in the Transactions.* For monochromatic light in the strict sense we are thrown back on prism dispersion. Instruments on this plan have been made, notably by Zeiss on a Hartnack model. The Zeiss monochromatic apparatus is probably very suitable for obtaining a spectrum, but in its design the requirements of the Microscope are absolutely ignored. It consists of a slit; a low-angled achromatic lens having the slit at its principal focus; two prisms; and another low-angled achromatic lens very similar to the first. The rays diverging from the slit are parallelized by the first lens, and after passing through the prisms are received by the second lens and by it brought to a focus. With this apparatus the use of a substage condenser is impossible because it yields convergent rays.

It must be borne in mind that none of Abbe's condensers will focus parallel rays; much less therefore will they focus convergent. If it is used, as intended, without any additional apparatus the cone from the low-angled condensing lens is too narrow to be of any service. As therefore this apparatus will work neither with nor without a condenser, it becomes mere lumber in the microscopist's cabinet. I never heard of one that had been used after its first trial. The apparatus I am exhibiting this evening is, as may be seen, only a makeshift; but I claim that it has for its end the requirements of the modern Microscope.

* Trans. Micr. Soc. London, N.S. ii. (1854) pp. 23-4.

It is composed of a base-board, on which slides a piece of wood holding an adjustable slit. Screw adjustment to the slit is quite unnecessary, as clear definition of the lines in a spectrum is not what

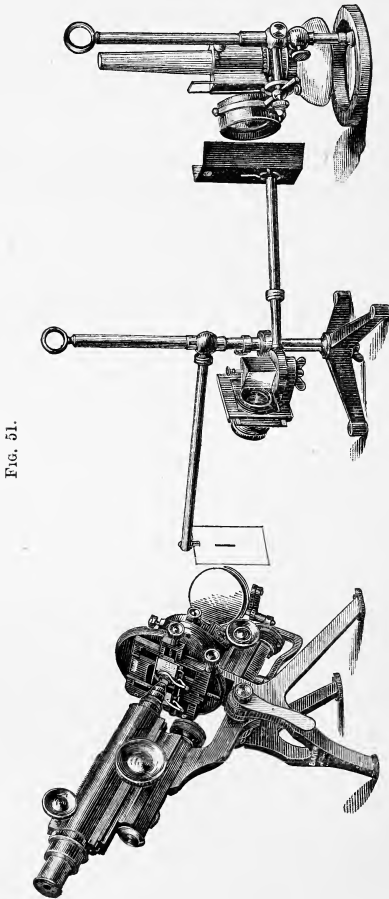

FIG. 51.

NELSON'S APPARATUS FOR OBTAINING MONOCHROMATIC LIGHT.

we have in view. On the same piece of wood that carries the slit another piece of wood slides which carries the prism. This piece of wood rotates on its axis; connected to this is another piece of wood which rotates round the prism as a centre. This holds a photographic lens known as a Wray 5×4 R.R., working at $f/5.6$. Lastly there is a card on a movable stand. The method of use is as follows. A strong beam of light is condensed on to the slit S, fig. 52, which is kept about $1/12$ in. open, by means of one of my new bull's-eyes, B to which an additional lens has been added. From the slit the light passes to a dense flint prism P which by means of its rotating holder is set at minimum deviation.

The Wray photographic lens R, which is eminently suitable for this purpose, both on account of its being corrected for rays high up the spectrum and also on account of its large aperture, is rotated

FIG. 52.

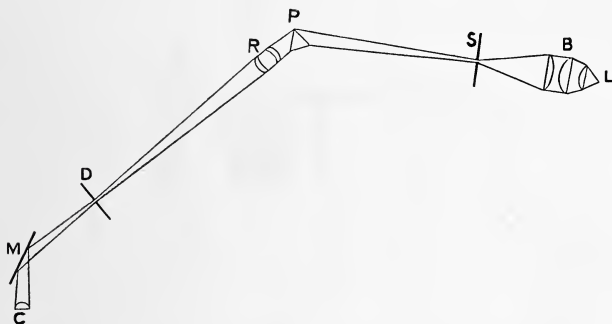

round the prism until the refracted beam falls directly on it. The prism and this lens, which is attached to the same fitting, are now both moved to a distance from the slit equal to twice the focal length of the lens, the image of the slit, i. e. the spectrum, being focused on the card D, which is placed at a similar distance from the lens, and on the other side of it. The card is then moved so that the kind of light required may pass through an aperture in it to M the mirror of the Microscope. The apparatus has also been made in metal (see fig. 5), attached to a firm bull's-eye stand; another form is also made in wood, suitable for direct illumination without a mirror. The condensing system is not absolutely necessary; by placing the edge of the lamp-flame close to the slit a good light can be obtained, but the light is more intense when the condenser is used. We then proceed with the manipulation of the Microscope in the usual way, the slit

in the card being treated exactly as if it were the lamp-flame. By a slight rotation of the Wray lens any colour of the spectrum is made to fall on the aperture in the card, and by this means the required colour for the illumination of the Microscope is obtained. For resolving purposes the blue-green will probably be found the most suitable.

The next question is—What do we gain by this apparatus? In the first place, with regard to resolving power with blue-green light, it practically adds $\cdot 1$ to the N.A. of the objective: thus a D.D. of $\cdot 8$ becomes a lens of $\cdot 9$ N.A., and that too without incurring any increase of spherical aberration. Secondly, as there can be no secondary spectrum, an ordinary achromatic lens performs as well as an apochromatic. For photomicrographic work it will be useful in taking the place of the coloured screens which are so necessary when isochromatic plates are used. For purposes of resolution, however, I do not think that it will prove of any assistance to photomicrography, Mr. Comber having pointed out that the plate itself is a monochromatic light-selector.

SUMMARY

OF CURRENT RESEARCHES RELATING TO

ZOOLOGY AND BOTANY

(principally Invertebrata and Cryptogamia),

MICROSCOPY, &c.,

INCLUDING ORIGINAL COMMUNICATIONS FROM FELLOWS AND OTHERS.*

ZOOLOGY.

A. VERTEBRATA:—Embryology, Histology, and General.

a. Embryology.†

Fecundation.‡—M. H. Fol gives an account of his observations on the egg of the sea-urchin. The spermatozoon, five minutes after fecundation, is still conical; a small corpuscle, the spermocentre, is detached from its tip. The spermatoc pronucleus then swells and approaches the ovarian pronucleus, its spermocentre being always in front. The ovarian pronucleus has an ovocentre which is placed on the side opposite to that which gives rise to the polar globules. The spermocentre becomes placed on the polar side of the ovarian pronucleus, and is afterwards applied to its lateral surface. There are now two prolonged phases, the “solar,” and the “aureolar”; at the end of the first of these the spermocentre and ovocentre are divided in the form of halteres, which are not placed in the same plane. These halteres become set parallel to one another, and are situated in a plane which will be that of the aureole. In the next phase the spermocentre and ovocentre become divided and the halves, passing in opposite directions along a fourth of the circumference of the combined nucleus, arrive at a point which is at right angles to their first position. This M. Fol calls the “marche du quadrille.”

At the moment when the demi-spermocentres are on the point of touching the demi-ovocentres, the aureole rapidly disappears and true asters become apparent; these are composed of perfectly distinct fibrils, which can be isolated and are different from the simple protoplasmic radiations visible till then. The demi-centres unite and fuse to form the first astrocentres.

* The Society are not intended to be denoted by the editorial “we,” and they do not hold themselves responsible for the views of the authors of the papers noted, nor for any claim to novelty or otherwise made by them. The object of this part of the Journal is to present a summary of the papers *as actually published*, and to describe and illustrate Instruments, Apparatus, &c., which are either new or have not been previously described in this country.

† This section includes not only papers relating to Embryology properly so called, but also those dealing with Evolution, Development, and Reproduction, and allied subjects.

‡ Comptes Rendus, cxii. (1891) pp. 877-9 (10 figs.).

The author concludes that fecundation consists not only in the addition of two demi-centres arising from individuals of different sexes, but in the union of two demi-spermocentres with two halves of oocentres to form the two first astrocentres. All the succeeding astrocentres are derived in equal parts from the mother and the father.

Comparative Anatomy of Placenta.*—Prof. E. Klebs has endeavoured to throw light on some unsolved problems by a study of the placenta in the white rat. From the distribution and appearance of the arteries and veins seen on a cross section of the gravid uterus, he argues that in the vascular layer of the maternal placenta there must be a slow circulation at relatively high pressure. The blood-stream finds its main outflow in the so-called peri-placenta. As the result of abundant nutrition, the maternal epithelium, the connective matrix, and the endothelium of the widened vessels are all hypertrophied. In the layer of the "monster-cells," as Minot calls them, the endothelial proliferation closes the openings of the vessels, but this closing membrane is not impervious. It allows red blood-corpuscles to pass into the numerous clefts between the monster-cells, and these corpuscles are found in the space between maternal and foetal epithelium, and also between the serous membrane and the extension of monster-cells on the lateral regions of the placenta. During life there must be some way of securing that the blood in the important inter-epithelial space flows off. Klebs believes that this is secured by the layer of smooth muscle-fibres covering the internal surface of the vascular part of the maternal placenta, and he ventures to speak of a "placental heart." He compares the placenta in the rat with that in the rabbit, and with that in man; all the three may be called vascular, for it is to elements of the vascular system that the chorionic villi become apposed; but the details of vascular arrangement are different. The placenta may be called *plexiformis* in the rabbit, *cavernosa* in man, *per appositionem* in the rat.

Placenta of the Cat.†—Prof. G. Henricius has corroborated by an investigation of the placenta of the cat some of the observations which he previously made in regard to that of the dog. Where the fetal ectoderm or chorionic epithelium begins to come into connection with the uterine mucosa, the superficial epithelium of the latter has disappeared. At this early stage the glandular cells are already much modified; they give origin to material which passes through the superficial layer of connective tissue into the uterine cavity. Before or during the firmer fixing of the embryo there is a complete or almost complete closure of the uterine glands. The chorionic villi certainly do not penetrate at first into the glands, but enter the superficial connective tissue. As they penetrate deeper they are seen to be surrounded by a syncytium, a kind of decidua due to a modification of the connective tissue. Neither glandular epithelium nor foetal epithelium takes part in forming the syncytium. Most of it subsequently disappears, probably absorbed by the foetus. In the neighbourhood of the villi, the glandular cells undergo disruption, and perhaps help in the nutrition. Moreover, red blood-corpuscles seem to pass through the walls of the vessels, and

* Arch. f. Mikr. Anat., xxxvi. (1891) pp. 335-56 (1 pl.).

† Op. cit., xxxvii. (1891) pp. 357-74 (2 pls.).

through the glandular epithelium, to the chorionic epithelium close to which they accumulate. At a later stage, the tissue between the more numerous villi is much reduced; the villi are separated by thin strands each with a capillary close to which the chorionic epithelium lies. The villi eventually insinuate themselves into the glandular spaces, and their epithelial cells are modified for the absorption of the "uterine milk"—the secretion and débris of the glands. Outside the strict placenta, red blood-corpuscles have accumulated around the chorionic epithelium, by which they are absorbed and probably utilized.

Gastrulation in *Lacerta agilis*.*—Dr. K. F. Wenckebach finds that the bilaminate stage of the germinal disc of *Lacerta* is due to cleavage and not to invagination. Gastrulation is effected by the invagination of the upper layer; only a small part of the enteric wall is formed from the archenteron; the notochord is formed in its dorsal wall, and with this is developed the gastric mesoderm; the peristomial mesoderm is developed from the whole circumference of the blastopore. The formation of the notochord and gastric mesoderm is continued towards the cranium in the lower layer. The author points out the resemblance between the gastrulation of the Reptilian egg and that of the Mammalia. While the egg of *Amphioxus* may be called the primary holoblastic egg, that of Amphibians is secondary, and that of Mammals tertiary. The recent work of L. Will on the development of the Gecko would make it, if taken in combination with the author's observations on the Lizard, possible to derive the gastrula of Mammals from that of Amphibians even without the assistance given by *Ichthyophis* and *Echidna*.

Fœtal Membranes in Chelonia.†—Prof. K. Mitsukuri has published in detail and with illustrations an account of his studies on the fœtal membranes of Chelonia, the preliminary notice of which has already been reported.‡ It will be remembered that he called attention to the presence of a rudimentary placenta, and he now makes some suggestions as to the phylogeny of the fœtal membranes in Vertebrates. He strongly inclines to the view that the amnion was originally developed by mechanical causes; there are, in the Chelonia, two reasons why the headfold, when produced, should sink into the yolk below. The yolk is very large and liquid, so that a slight weight is sufficient to sink any structure into it, and there is no space for the headfold to grow in any other direction than downwards. It is the dorsal part of the proamnion that primarily consisted of epiblast only.

Primitive Segmentation of Vertebrate Brain.§—Mr. B. H. Waters has made a study of the brain of *Gadus morrhua*, from which he concludes that the neuromeres appear at a late period in the ontogeny and soon degenerate; this disproves the view that they are formed mechanically, and strengthens that of their phylogenetic importance. The olfactory pits develop early in connection with the first pair of nerves which arise from the fore-brain. This fore-brain contains three neuromeres; from the first the roots of the olfactory nerve arise; and at a point somewhat above the second the optic diverticula are formed. The

* Anat. Anzeig., vi. (1891) pp. 57-61, 72-7 (15 figs.).

† Journ. College of Science, Imp. Univ. Japan, iv. (1891) pp. 1-53 (10 pls.).

‡ See *ante*, p. 22.

§ Zool. Anzeig., xiv. (1891) pp. 141-4.

mid-brain is composed of two well-marked neuromeres. Evidence of the origin of the third and fourth nerves from the two neuromeres of the mid-brain is unsatisfactory.

B. Histology.

Structure of Amœboid Protoplasm.*—Prof. E. A. Schäfer has succeeded, by the instantaneous application of a jet of steam to the surface of the cover-glass, in immediately killing blood-cells. The most striking point is the contrast between the protoplasm of the body of the cell and that of the pseudopodia. For while the former exhibits, according to focus, either a finely punctated or a reticular aspect and stains decidedly with hæmatoxylin, the pseudopodia exhibit not a trace of structure, and remain almost entirely unstained. We may conclude, therefore, that protoplasm is composed of two parts, which are morphologically distinct; one exhibits a reticular arrangement and has an affinity for hæmatoxylin, while the other has no structural arrangement, and is chemically different. These bodies may be called spongioplasm and hyaloplasm; the former is the firmer, though not, perhaps, actually solid, and is, in all probability, highly extensile and elastic; the latter flows, and it is by its movement that the movements of cells are produced, and it is the more active of the two. Hyaloplasm is probably the essential part of protoplasm, but we not yet know how its flowing is brought about.

If the structure of protoplasm be compared with that of striated muscle, there may be seen to be many points of coincidence. In the latter the substance of the sarcous element stains while the homogeneous substance of the clear intervals remains unstained. The changes which occur in contraction are so like those which occur in the protoplasm of an amœboid cell, that it is hardly possible to believe that the resemblance is merely accidental. It becomes clear, moreover, that neither the protrusion nor the withdrawal of pseudopodia are signs of a resting condition; both are produced by a flowing of the hyaloplasm.

As to ciliary motion, Prof. Schäfer suggests that, if we suppose a cilium to be a hollow curved extension of a cell, occupied by hyaloplasm, and invested by a delicate elastic membrane, it follows that if there be a rhythmic flowing of hyaloplasm from the body of the cell into and out of the cilium, there must be an alternate flexion and extension of the process. If the membrane be thickened more on one side than another, or if the line of lessened extensibility passed in a cork-screw fashion, the spiral direction of certain cilia may be explained.

Morphology and Physiology of the Cell.†—Dr. A. B. Macallum offers some contributions to our knowledge of the cell. He commences with a discussion of the nature of structures observed within epithelial cells of the alimentary canal. He classifies them thus:—1, Parasites; 2, Remains of broken-down cells and nuclei swallowed by the healthy adjoining cells; 3, Material swallowed by the epithelial cell from food passing over its free surface; 4, Plasmosomata migrated or extruded from the nucleus (in the glandular cells of the pancreas only). He

* Proc. Roy. Soc. Lond., xlix. (1891) pp. 193-8.

† Trans. Canadian Inst., i. (1891) pp. 247-78 (2 pls.).

describes some intracellular parasites from the intestines of the spotted newt and the lake lizard (*Necturus*). Next are described some chromatophagous and other intracellular parasites in the intestine of *Necturus lateralis*. There is a critical study of observations on certain structures in the pancreatic cells of Amphibia, and certain more purely physiological deductions.

Indirect Fragmentation.*—Dr. E. Göppert finds in the lymphatic cortical sheath of the liver of *Salamandra* and *Triton* distinct evidence of nuclear division by a process of indirect fragmentation similar to that described by Arnold. At first the nucleus exhibits a distinct mesh-work of chromatin; a perforation appears, around which the chromatin forms a ring; the ring becomes divided into two to eight fragments generally different from one another in form and size, but still disposed in a circle; during the whole process the nucleus remains surrounded by its membrane; no associated cell-division was observed.

History of Blood-corpuses.†—Herr H. F. Müller has studied this both in cold-blooded and warm-blooded Vertebrates. He finds that the leucocytes and the erythrocytes originate from similar mother-cells. These mother-cells exhibit indirect division, and their daughter-cells undergo various modifications:—(1) Some become erythrocytes; (2) others are subject to further karyokinesis, but eventually form erythrocytes; (3) others form mononuclear resting leucocytes which grow into resting mother-cells ready to divide; (4) others seem to become the ordinary polymorphic leucocytes. Karyokinesis prevails in the formation of both erythrocytes and leucocytes, but the occurrence of other modes of division must be admitted.

Origin of the Fibrillæ in Connective Tissue.‡—Herr B. Lwoff has investigated the connective tissue in various parts of sheep embryos. He agrees with Schwann and Boll in concluding that from each cell a portion of the fibril-bundle is formed, and with Rollett in maintaining that the fibrils appear on the surface of the cells. But he has furthermore observed that the formative cells are disposed in long rows and are connected by their processes, and that the fibrils are formed superficially along these rows. The formation of the fibrils proceeds from the surface inwards; from each row of cells arises a fibril-bundle, in the middle of which are the remains of the formative cells. In origin these connective tissue fibrils are comparable to those of muscle and to those on the cortex of hairs and feathers.

γ. General.

Elementary Biology.§—Prof. T. Jeffery Parker, formerly one of the Associate Editors of this Journal, has published what is certainly a very readable and will probably be found a very useful introduction to the study of Biology. The author hopes that his work may also be useful “to that large class of workers whose services to English science often receive but scant recognition—I mean amateur microscopists.”

* Arch. f. Mikr. Anat., xxxvii. (1891) pp. 375-91 (1 pl.).

† SB. K. Akad. Wiss. Wien, xcviii. (1889) pp. 219-94 (5 pls.).

‡ T. c., pp. 184-210 (2 pls.).

§ ‘Lessons in Elementary Biology,’ London, 1891, 8vo, 408 pp. and 89 figs.

Prof. Parker has kept before himself the wise principle that biology as a branch of a liberal education should familiarize the student not so much with the facts as with the ideas of science; this aspect of his subject he has treated in a way quite novel in a text-book, but in one which seems to be excellent.

Another characteristic of the book is the large space devoted to unicellular Animals and Plants, but the advantage of that need hardly be dilated on in a Microscopical Journal. Two lessons are devoted to *Polygordius*; the selection of this worm as a type of triploblastic organization is quite new, and events must show if it is as wise as we may hope it is. The distinctive characters of the higher forms of animal and vegetable life are dealt with much more summarily.

Classification of Animal Kingdom.*—Prof. W. Schimkewitsch has proposed some changes in the classification of the Animal Kingdom. His scheme is as follows:—

I. Protozoa s. Monozoa.

II. Metazoa s. Polyzoa.

- | | | |
|----------------------------------|--|---|
| 1. Radiata | { A. Cœlenterata ..
{ B. Spongiaria. | { Hydrozoa.
{ Scyphozoa.
{ Ctenophora.
{ Ctenophoroidea [i.e. Cteno-
planidæ and Cœloplanidæ]. |
| 2. Bilateria. | | |
| A. Gastroneura. | | |
| α. Acœlomata .. | { 1. Anæmaria s. Plathelminthes.
{ 2. Hæmataria s. Nemertini. | { 1. Nemathelminthes (Kinorhyncha, Echino-
rhyncha, Nematodes, Nematomorpha). |
| β. Pseudocœlomata | | |
| γ. Eucœlomata .. | { 1. Helminthozoa
{ s. Vermes | { Asegmentata (Rotatoria,
Gastrotricha).
{ Segmentata (Dinophilidæ).
{ Parasita (Orthonectida and
Dicyemida).
{ Inarticulata (Sipunculoidea,
Phoronida, Bryozoa,
Rhabdopleurida).
{ Triarticulata (Chæto-
gnatha, Brachiopoda).
{ Articulata (Chætopoda,
Stelechopoda [including
Myzostomida], Hirudinei,
Echinoidea.) |
| B. Tetraneura s. Malacozoa. | | |
| C. Cycloneura s. Echinozoa. | | |
| D. Notoneura .. | | |
| { α. Achordata s. Enteropneusta. | { 1. Leptocardii.
{ 2. Tunicata.
{ 3. Vertebrata. | |
| { β. Chordata | | |

The objections to some of these names are sufficiently obvious.

* Biol. Centralbl., xi. (1891) pp. 291-5.

B. INVERTEBRATA.

Zoological Paradoxes.*—Under this heading Prof. A. Korotneff deals with some exceptional forms which “look like real nonsense, and can only as paradoxes excite the interest of naturalists.”

The first with which he deals is *Gastrodes parasiticum*, already described as being found in the gelatinous investment of *Salpa fusiformis*. It is now seen to be an endoparasitic Actinian which has become simplified by its mode of life, and so modified as to seem much like a *Scyphosoma*. In its internal cavity there are single and double folds, the former consisting only of endoderm, the latter of endoderm and ectoderm. These two layers are, in the wall of the body, separated from one another by a pretty strong gelatinous layer. The endoderm forms six processes which are either true or false septa; the two true septa consist of ectoderm also.

The ectoderm of *Gastrodes* differs in structure with the age of the animal and the part of the body whence it is taken; thus it may consist, on the surface, of one or two layers, while at the floor of the mouth there are several layers; near this it may contain true glands. Eggs appear in the ectoderm of quite young forms; their number, as in all parasitic forms, is somewhat considerable; their presence in the outer ectodermic layer is probably caused by their parasitic habit. The author has been able to detect what appear to be spermatozoa.

The endoderm seems to have a very peculiar construction; it consists of small cylindrical cells found at various spots on the inner wall of the stomach; these cells form the base of the gastric lumen which seems to be very much reduced, as it is almost completely filled by various endodermal elements; the endoderm of the gastric tube spreads out into a layer which lines the inner side of the oral disc and serves as the seat of origin of the spermatozoa. These cylindrical cells pass into others which form the peculiar endodermal mass; this consists of large vesicular elements, rich in yolk. There are other cells which are still more remarkable; here and there, and ordinarily inclosed in the endodermal mass, there are aggregations of protoplasm of a finely granular substance. No cell-boundaries are to be detected here. This plasmodium perhaps serves to effect chemical changes in the food.

The nearest ally of *Gastrodes* would appear to be *Scyphosoma*.

The next form discussed is also one on which Prof. Korotneff has before written; it is the remarkable creature called by Metschnikoff *Cunocantha parasitica*. A number of stages have now been observed, and it would seem that the ectoderm always consists of seven cells which exhibit absolutely no tendency to increase. In the endoderm it is otherwise. In *Cunocantha* there appears to be a case of sporogony.

The author states he has but little to add to the careful descriptions already given by R. Hertwig and Fol of the structure of the rhizopodal *Sticholonche zanclea*. The pseudopodia resemble exactly the protoplasm of the Heliozoa, for an axial homogeneous portion and a finely granular protoplasmic investment are to be seen. The relation of the pseudopodia to the body-mass appears to be also the same as in the

* Zeitschr. f. Wiss. Zool., li. (1891) pp. 613-28 (3 pls.).

Heliozoa. The remarkable "corps en spirale" which Fol is inclined to regard as a spermatophore appears rather to be a parasitic intruder, and is probably a life-stage in the history of one of the Orthonectida.

Biological Results of Cruise of the 'Argo.'*—Prof. W. A. Herdman has a report on the biological results of the cruise of Mr. A. Holt's steam yacht 'Argo' round the west coast of Ireland; bad weather unfortunately prevented dredging in deep waters. *Molgula holtiana* and *Polycarpa argoensis* were two new Tunicates that were found during the expedition.

Mollusca.

β. Pteropoda.

Development of *Clione limacina*.†—Mr. N. Knipowitsch has a preliminary account of the development of this Pteropod, on which Fol has already made some observations. The formation of the gastrula commences with the division of one of four macromeres into two; henceforward these two blastomeres distinguish the hinder end of the egg and are placed quite symmetrically; the structure of their protoplasm, which is clearer, is not inconsiderably different from that of other macromeres. These cells are the mother-cells of the mesoderm. By the division and invagination of the three other macromeres a bilaterally symmetrical gastrula is developed. The blastopore is elongated and almost cleft-like; it becomes gradually narrowed by the small ectodermal cells at its margin.

After the formation of the gastrula the mesoblasts begin to develop and small mesoderm-cells with a coarsely granular protoplasm like that of the mesoblasts become formed. As the cells grow forward they arrange themselves in such a way as to form a splanchnic and a somatic layer. The cells of the endoderm pass directly into those of the mid-gut, and the only differentiation to be noted is that some of the cells remain rich in yolk while others are smaller and consist only of protoplasm. The former appear to become the hepatic cells. There seems to be no doubt that in those Pteropods where one macromere is smaller and poorer in nutrient yolk that cell gives rise to the mesoderm.

γ. Gastropoda.

Embryology of *Crepidula* and *Urosalpinx*.‡—Mr. E. G. Conkton has a preliminary note on the embryology of *Crepidula fornicata* and *Urosalpinx cinerea*. In the former the cleavage follows the type of *Fusus*, *Planorbis*, *Neritina*, and others, but there is not, normally, any trace of an invagination at the ectodermal pole, such as has been seen in *Neritina* and *Fulga*. The gastrula is formed by typical epibole. The mesoblastic bands are soon separated from the mesoblasts, but the latter continue to proliferate mesoderm. The velum first appears on the ventral side and primitively consists of a single row of cells; two large velar lobes become formed, one on each side. The velum does not become ciliated until quite late in development, though the embryo swims

* Trans. Liverpool Biol. Soc., v. (1891) pp. 181-212 (3 pls.).

† Biol. Centralbl., xi. (1891) pp. 300-3.

‡ John Hopkins Univ. Circ., x. (1891) pp. 89-90.

about in the pouch by means of the cilia of the large ciliated cells which form the head-vesicle.

The foot is single and median, and though it shows no trace of a double origin, it may be considered as having arisen on both sides of the blastopore. At the posterior end of the embryo three or four large ciliated anal cells appear, and just ventral to them the distal end of the intestine is pressed against the ectoderm. The walls of the intestine are formed by small cells free from yolk. The supra-oesophageal ganglia appear as proliferations of the ectoderm on each side of, and dorsal to the mouth, and in connection with them, the eyes are formed as involutions of ectoderm; the pedal ganglion is formed by delamination from the ectoderm at the sides of the foot.

The segmentation of *Urosalpinx* is almost identical with that of the Oyster; only the very earliest stages of this Mollusc were investigated owing to the great difficulty in cutting sections of the egg.

Eyes of Pulmonata Basommatophora.*—M. V. Willem points out that suitable sections show that the portion of the integument placed above the eye is almost entirely occupied by a vast lacuna. This is limited externally by a delicate wall formed of epidermis and of a layer of connective tissue in which there is neither pigment nor mucus-forming gland. The constant presence of blood-corpuscles and often of coagulated plasma in spaces which correspond to this cavity, shows that it is part of the general lacunar system of the body. Injections of the circulatory system of *Limnæa stagnalis* show that the pre-ocular sinus is the confluence of afferent and efferent canals distributed in part of the eye and especially in the tentacle. The author has observed the lacuna in the snail just mentioned, in *L. palustris*, *Planorbis corneus*, *Physa fontinalis*, and *Aplexa hypnorum*, and it is probably generally present in the Basommatophora. The morphology of this lacuna is easier to understand than its physiology.

5. Lamellibranchiata.

Anodon and Unio.†—Mr. O. H. Latter has some notes on these animals. He first discusses the passage of the ova from the ovary to the external gill-plate, and thinks that this is effected by suction. With regard to the attachment of the *Glochidia* to the parent gill-plate it appears that the young attach themselves by their byssus, as the nutritive reserve in their neighbourhood becomes used up. It is very remarkable that the parent is able to draw back within the shell the long slimy masses of *Glochidia* even after they have been ejected a distance of two or three inches. It is not true, notwithstanding repeated statements to the contrary, that the young can swim; they can be put easily into a state of great excitement by the introduction of the tail of a recently killed stickleback into the watch-glass in which they are lying. The *Glochidium*-shell has nearly always an influence on the shell of the adult, causing an irregular notch in the otherwise symmetrical curve. Schierholz is correct in stating that it is impossible to distinguish the sexes by their shells. All the fish with which the

* Comptes Rendus, cxii. (1891) pp. 1378-80.

† Proc. Zool. Soc. Lond., 1891, pp. 52-9 (1 pl.).

author experimented have a strong dislike for *Glochidia* as an article of food. Both adult and young are able to resist a certain amount of freezing.

Molluscoida.

a. Tunicata.

Ecteinascidia and other Clavelinidæ.*—Prof. W. A. Herdman gives an account of the characters and relations of this group of Tunicata, and criticizes the work done since he established the genus in his ‘Challenger’ report. He describes two new species, *E. Thurstoni* from the Gulf of Manaar, and *E. Moorei* from Alexandria Harbour. A classification of the Clavelinidæ is proposed; this family is of great interest phylogenetically, because *Clavelina* comes nearer than any other known form to what we have good grounds for believing to be the common ancestors of all the simple or compound Ascidiæ (Proto-ascidiacea), and because this group occupies a central point between the simple and compound Ascidiæ; *Rhopalæa* links on in one direction to *Ciona* and the Ascidiidæ, while *Clavelina* and *Ecteinascidia* pass in the other direction into *Diazona*, *Chondrostachys*, and the Distomidæ.

Tunicata of Plymouth.†—Mr. W. Garstang publishes the first part of a report on the Tunicata of Plymouth, in which he deals with the Clavelinidæ, Perophoridæ, and Diazonidæ. Definitions of families, genera, and species are given, and there are copious synonymic lists. *Pycnoclavella* is a new genus for *P. aurilucens* sp. n., in which the zooids are small and delicate, clavate, and arise by slender stalks from a more or less thick basilar mass of test-substance.

b. Bryozoa.

Budding in Bryozoa.‡—Mr. C. B. Davenport has a preliminary notice of the results of his studies on budding in the Bryozoa. He makes some critical remarks on the recent work of Braem. It is stated that the polypides of the Bicellariidæ, Membraniporidæ, and Aleyonidiidæ arise like those of *Paludicella*; that is, from a mass of indifferent cells at the margin of the colony—a mass from which the body-wall is also derived. In all cases the polypide is formed by an invagination of the body-wall, which is two-layered at the margin of the colony.

In marine Gymnolæmata budding seems to obey certain laws, which may be deduced from the study of erect colonies like *Bugula*; these laws appear to be partly as follows:—The lateral buds are formed earlier than and do not extend so far distally as the terminal buds. When a terminal and a lateral bud attached to the same proximal individual are each immediately followed by two buds, the two laterals lie adjacent, and the two terminal buds outside. Lateral buds tend to arise at the same time on two branches which spring from a common individual, but this may be modified. The marginal branches are the shortest and the middle ones the longest. There is one proximal individual to each “fan”; this is followed by two and then by four;

* Trans. Liverpool Biol. Soc., v. (1891) pp. 144–63 (2 pls.).

† Journ. Mar. Biol. Assoc., ii. (1891) pp. 47–67 (1 pl.).

‡ Proc. Amer. Acad., 1891, pp. 278–82 (sep. copy).

each of the two outside individuals of these four bears more individuals than does each of the inner individuals. New individuals are constantly being formed at the periphery of the fan and at about the same time, but on some branches only one new bud arises, and on others two.

The normal architecture of the colony is obscured by inequalities of the surface on which it lies in the case of creeping forms like *Membranipora*, *Lepralia*, and *Escharella*.

Regeneration of Lost Parts in Bryozoa.*—Mr. S. F. Harmer has studied, especially in *Crisia*, the process of regeneration. It may take place in various ways; an old zoecium may form a fresh aperture and again become tenanted by a polypide, or it may grow out into a rootlet or into a growing-point, which will, in course of time, give rise to a complex branch. If a rootlet is formed, it may become pretty long, and then either give rise to a fresh stem as a lateral branch, or it may, after a time, take on the characters of a growing-point, so that the new stem is the direct prolongation of what was at first an ordinary rootlet. The new branches formed from the stumps of old colonies are more commonly developed from the old joints; sometimes from the lateral joints, at the points where old branches have been thrown off; and sometimes from the axial joints, at the points where old axial internodes have been lost. The broken surface of an internode has the power of developing a fresh growing-point, which ultimately gives rise to a new branch.

In the lower parts of a colony of some species of *Crisia* the long tube that forms the ordinary aperture of the zoecium is often lost, when the part left is protected from further injury by a calcareous diaphragm which prevents foreign bodies from falling into the cavity of the zoecium. Such a zoecium contains a brown body but no functional polypide. Sometimes a polypide-bud is developed below the diaphragm; as the bud develops the diaphragm becomes absorbed, and the mouth of the aperture again grows out into a long tube.

Origin of Embryos in Ovicells of Cyclostomatous Polyzoa.†—Mr. S. F. Harmer has investigated species of *Crisia*, in which the mature ovicells contain a large number of embryos. These are imbedded in the meshes of a nucleated protoplasmic reticulum, which also contains a mass of indifferent cells, produced into finger-shaped processes, the free ends of which are from time to time constricted off as embryos. These, after developing various organs, escape as free larvæ through the tubular aperture of the ovicell. The budding organ from which the embryos are formed makes its appearance at an early stage in the development of the ovicell. The supposed ovum is found in very young ovicells, imbedded in a compact follicle, and appears to give rise to the budding organ. The embryos are thus produced by the repeated fission of a primary embryo developed in the ordinary way from an egg.

Fresh-water Polyzoa.‡—Mr. A. Oka has studied *Pectinatella gelatinosa*, a new species found in a pond at Tokyo, with the object of throwing light on some obscure points in the structure and development

* Rep. Brit. Assoc., 1890 (1891) pp. 862-3.

† Proc. Camb. Philos. Soc., vii., pt. ii., 1 p. [separate copy].

‡ Journ. College of Science, Imp. Univ. Japan, iv. (1891) pp. 87-150 (4 pls.)

of the Phylactolæmata. The study was favoured by the transparency of the gelatinous ectocyst, the unique size of the polypide, and the promptness with which it is evaginated. The largest colony seen measured 7 cm. in diameter. The author proposes to apply the term polyzoid to every equal part of a colony which consists of a polypide and a portion of the cœnœcium, and to call "cystid" such portion of the cœnœcium.

In his detailed account of the organization of his new species the author does not confine himself to new facts. He confirms the statement of Verworn as to the presence of cilia at the end of the external wall of the stomach. He denies the existence of a circumœsophageal commissure; the ovary is a solid club-shaped outgrowth of the internal lining epithelium. He found muscular fibres in the funiculus, though their presence in *Cristatella* has been denied by Verworn. The statoblast and its development are described in considerable detail.

Arthropoda.

Extremities of Embryo of Arachnids and Insects.* — Dr. A. Jaworowski has been led to construct the following table:—

	<i>Arachnida.</i>	<i>Insecta.</i>	
Cephalothorax	1st appendage, Antennæ in embryo only.	Antennæ also in post-embryonic stage.	Head
	2nd " Mandibles.	Mandibles.	
	3rd " Maxillæ i.	Maxillæ i.	
	4th " Maxillæ ii, later 1st pair of legs.	Maxillæ ii., fused in embryo and forming labium.	
	5th " Later 2nd pair of legs.	1st thoracic appendage.	Thorax
	6th " Later 3rd pair of legs.	2nd " "	
	7th " Later 4th pair of legs.	3rd " "	
Abdomen	12 (?) abdominal segments in <i>Trochosa singoriensis</i> .	11 embryonic abdominal segments.	Abdomen
	4-5 pair of abdominal appendages in general.	Abdominal appendages of varying number.	

a. Insecta.

Chemistry of Insect Colours.†—Mr. F. H. Perry Coste has investigated the behaviour of the colours of Lepidoptera when treated with various chemical reagents. He gums the wings on to watch-glasses and then submits them to the action of reagents for one hour.

After describing his *a priori* expectations, and pointing out that in nearly every instance he has succeeded in modifying the colours *retrogressively* only, and not *progressively*, he describes his method of working and the reagents used. After experimenting with about two dozen different reagents, he concluded to make use of hydrochloric, nitric, sulphuric, and acetic acids; of potassic, sodic, and ammonic hydrates. He finds no difference between the action of acids and of alkalis, except that some colours are affected more by the one, some by the other; but

* Zool. Anzeig., iv. (1891) pp. 164-9, 173-6

† Entomologist, April 1890-August 1891.

in no case are *different* coloric reactions produced by the two classes of reagent. He next gives a list of the species experimented upon, the results being chiefly in tabulated form; and then proceeds to discuss the significance of these results. He distinguishes between *pigmental* and *physical* colours, the latter of which he subdivides into interference colours, reflection colours (other than interference colours), and absorption colours. He then discusses the colours one by one.

Black he finds in every instance, almost without exception, is unaffected by his reagents; and after discussing the subject in detail, he concludes that black is merely a (physical) absorption colour, and not due to any pigment. He points out the surprising nature of this result, seeing that a black pigment exists so commonly in the animal kingdom; and also remarks that, as a consequence of this, his experiments fail to throw any light on the melanic varieties of Lepidoptera.

White also he finds to be no pigment colour, but simply a reflection effect. In one case, however (*Arga galathea*), he found the white wing changed to a deep yellow, which yellow finally dissolved, leaving the wing colourless; he explains this by supposing an unstable pigment-mother-substance to exist in this species; this mother-substance is decomposed by his reagents with the production of the yellow pigment, whose subsequent dissolution is comparable with the behaviour of various normally yellow species.

Before discussing the other colours in detail, the author justifies his assumption that the changes induced by his reagents are uniformly retrogressive; and then proceeds to distinguish (among pigmental colours) between the "reversion" and the "soluble" effects. Some colours are soluble, and then the wing is permanently discoloured; but in the case of red, the effect of acid is to change this instantly to yellow, which yellow may subsequently be restored to red, and the process repeated indefinitely: this is the "reversion" effect.

Yellow and *red* he finds to be very closely related. In nearly every species red or pink is changed to yellow; but the yellow thus produced cannot be further affected, except in the very interesting case of species of *Delias*, in which the yellow so formed subsequently dissolves, leaving a white wing. He distinguishes at least three stages of coloric evolution in yellow. In the first stage the yellow is completely soluble in his reagents, leaving a pure white wing; and these yellows are very often of a pale tint. In the second stage, the yellow is only somewhat affected; and in the third stage (which also includes all the metamorphosed reds) the yellow is absolutely indifferent to the reagents: these last yellows are very often of a deep tint. The author proposes to account for all these facts on the theory of the gradual evolution of a deep yellow and finally of a red, from the primitive pale yellow; but he specially insists that this yellow was not developed from any white pigment, although usually in a white wing; experiments tending to prove this contention are cited. The author reserves his opinion as to whether among the unaffected yellows there may not be one or two that are not pigmental but simply "physical" colours.

The "reversion" experiments on red are next described. The author finds that a red wing when yellowed by nitric acid is permanently yellow; but when yellowed by other acids, the yellow is permanent

only so long as the wing remains acid; as soon as the acid is *entirely* removed, either by copious washing with water, or neutralization with ammonia, or by prolonged drying (exposure to the air for some weeks) the original red returns.

These phenomena are explained by assuming that the acids form probably *molecular* compounds with the red pigment molecule, thus producing yellow pigments; these molecular compounds being unstable are readily decomposed by excess of water, or by gradual oxidation (?) as in the air-drying experiments, leading to the restoration of the original red. In the case of nitric acid, it is clear that instead of the formation of such molecular compounds, a destructive action on the pigment molecule has taken place.

Chestnut or *brown* is very closely similar in character and behaviour to yellow; here too he distinguishes three stages of solubility, corresponding with those in yellow, and he also thinks it possible that some of the insoluble chestnuts also may be "physical" colours, and not pigmental at all. He finds further that a few reds (e. g. in *V. Atalanta*) have been evolved not from yellow, but from *chestnut*: these reds do not show the "reversion" effect.

Among the *greens* some are certainly physical; some are probably physical; and some are pigmental. The first class includes all the metallic greens; these may be either unaffected, or temporarily or permanently dulled or browned by the reagents; the alteration in such cases is to be attributed to injury of the molecular structure of the wing. The second class of greens are instantly changed to brown, or bronze-brown: these, too, are probably physical. The third class are dissolved, leaving a white wing: in some cases, however, a more or less yellowish white, and occasionally a deep yellow, are produced; it is therefore very probable that green also has been evolved from yellow.

Blue is an unsatisfactory colour from the author's point of view. In nearly every instance he finds it to be physical in nature; and the same general account may be given of these physical blues as of the physical greens. As to the blue of the *Lycænidae*, however, the author reserves his opinion for the present, although strongly inclined to consider this also a "physical" blue.

An account of the reaction of very damp potassic cyanide on certain yellow species is also given. The author's attention was called to this matter by a reported experiment of Edwards concerning which he was formerly very sceptical. He now finds, however, that in many species of *Rhopalocera* (no such results have yet been obtained from yellow *Heterocera*) the yellow, under these conditions, is changed to a more or less brilliant red; this is extremely interesting as being an instance of progressive modification. The author thinks it probable that in such cases, combination takes place between the pigment molecule and the cyanide radicle: but he is still employed in investigating the subject.

In the last section of his paper, the author remarks on the general chemical effect of soil, food, and the like, on the colours of insects, and suggests an explanation of several varieties such as white specimens of *E. Janira*, *Lycæna phléas*, *Colias helice*, &c., and finally points out, by quoting details, the interesting fact that in the course of his experiments

he has succeeded in producing varieties* identical in appearance with those occasionally found in nature. He also criticizes Mr. Cockerell's theory that yellow is anterior to white in the course of evolution, and argues that the course of evolution has really been white, yellow, red.

Early Stages of Development in Eggs of Insects.† — Dr. H. Henking, in his second memoir, deals with spermatogenesis in *Pyrrhocoris apterus*, and its relation to egg-development. He finds that the primordial sperm-cells correspond to the primordial ova; both forms of cells contain the characteristic number of twenty-four chromosomes. The spermatocytes of the first order correspond to unripe ova; both increase considerably in size, and both develop a proportionately large vesicular nucleus, in which yolk-spherules are produced. The formation of the first polar globules corresponds to the first division of the spermatocytes. In both cases there is a "reduction-division," for twelve chromosomes are found in each new cell. The formation of the second polar globule corresponds to the second division of the spermatocytes. The twelve chromatic elements are directly halved by "equation-division."

The following points are noticeable in the spermatosome:—The secondary nucleus is formed from the peripheral connecting fibres and by division of the spindle-fibres; the central bundles of the former give rise to the mitosoma; the paired secondary nucleus attaches itself to the nucleus which will become the head of the spermatozoon. The portion of the mitosoma which becomes attached to the nucleus becomes chromatic and wanders to the anterior end of the spermatozoon. It is probable that small quantities of chromatin substance pass into the secondary nucleus and the mitosoma. There are two distinct kinds of normal spermatozoa. Some contain only eleven chromatic elements, while others have in addition a chromatic element which remains undivided and is probably to be regarded as a nucleolus.

Insects injurious to Forest and Shade Trees.‡ — Prof. A. S. Packard publishes, in the reports of the United States Entomological Commission, a report on Insects injurious to Forest and Shade Trees; it is a subject to which, as yet, but little attention has been given. The materials are dealt with in twenty chapters, under the heads of various trees, such as oak, elm, hickory, and so on. There is a brief explanatory introduction.

Insect-larva eating Rust on Wheat and Flax. § — Messrs. N. A. Cobb and A. Sidney Olliff have observed orange-coloured larvæ (of a species of *Cecidomyia*) on many specimens of rusted wheat. Observation showed that the larvæ fed greedily on the rust. They suggest further study of the relations between insects and mites and fungi, and propose next season to continue their investigations. The larvæ are described.

Role of Nucleus in Formation of Muscular Reticulum in Larva of Phrygane.|| — M. E. Bataillon believes he has shown that the transverse

* In a note to the 'Entomologist,' March 1891, the author warned collectors against buying varieties, since such might now be easily manufactured by the methods described as having been employed in his experiments.

† Zeitschr. f. Wiss. Zool., li. (1891) pp. 685-736 (3 pls.).

‡ U.S. Department of Agriculture, Washington, 1890, vi. and 955 pp., 38 pls., and 306 woodcuts. § Ann. and Mag. Nat. Hist., vii. (1891) pp. 489-93 (3 figs.).

§ Comptes Rendus, cxii. (1891) pp. 1376-8.

striation of the muscles of the larvæ of Phryganids is developed in relation with the nuclei; it is from the nucleus that there grow out the striæ of the transverse plexuses, on which the refractive granules of the developed fibre represent the chromatic bodies of the formative period. The author has not been able to make out the origin of the longitudinal fibres or of the rods which appear in connection with the granules. The transverse plexuses appear first, before the muscle segments, and even before the longitudinal fibrils.

Absence of Wings in the Females of many Lepidoptera.*—Herr L. Knatz expresses surprise that biologists have not given more attention to the absence or the reduction of wings in many female Lepidoptera. There are many grades of this reduction, from the wingless female *Psyche* to forms like *Stilbia* and *Epimecia*, in which the wings of the females are but a little smaller than those of their mates. Herr Knatz classifies these grades of reduction, and compares them with cases of similar sexual dimorphism in Strepsiptera, Telephoridae, and Mutilidae. He notes that the distribution alone is enough to show that the ancestors of the wingless females must have had wings. This is obviously corroborated by the fact that the males are winged, and further proof of the reality of the reduction is furnished by the state of the rudiments in the pupal stages of the females. External conditions, deficient food, warmth, or moisture may injuriously affect the development of wings, or the reduction may be a constitutional variation. Females which cannot fly are in some ways at a disadvantage, they cannot soar away from their enemies nor attract their mates in flight; but there are obvious compensations,—the sedentary females are often hidden, the winged males become proportionately more active and eager in seeking their mates. Moreover, the reduction of wings is associated with a greater development of the abdomen, with an increase in the size of the ovaries, with greater fertility. It is therefore hardly surprising to find that the author is able to give no less than 183 instances of female Lepidoptera with reduced or absent wings. His paper is full of suggestiveness to evolutionists.

Natural History of Solitary Bees.†—Herr H. Friese records his observations on solitary Apidae, describing the two genera of Archiapidæ, —*Prosopis* and *Sphecodes*, twenty genera of Podilegidæ which collect pollen on their hind legs, and seven genera of Gastrilegidæ which have either no collecting apparatus or simply a special arrangement of hairs on the abdomen of the females. Notice is taken of the variability of these bees, of their seasonal and sexual dimorphism, of their nests and stores, of their eggs and larvæ, of their modes of life and manner of death. Herr Friese also maps out the relationships of the solitary bees, basing his scheme mainly on the nature of the collecting apparatus, of the mouth-parts, and of the nests. But the importance of his contribution consists in the numerous observations which he has made on the natural history of the twenty-nine genera described.

* Arch. f. Naturgesch., lvii. (1891) pp. 49-74 (1 pl.).

† Zool. Jahrb., v. (1891) pp. 751-860 (1 pl.).

B. Myriopoda.

Anatomy of Scutigera.*—Herr C. Herbst finds that this Myriopod is provided with five sets of glands in the head, and describes their arrangement and minute anatomy; some of them probably act as spinning glands and others prepare food. It is suggested that they are the homologues of the coxal gland. A cardiac nerve, arising from the sympathetic probably, is described in connection with the circulatory apparatus.

3. Arachnida.

Development of Araneina.†—Mr. Kamakichi Kishinouye has especially studied the development of the eggs of *Lycosa* and *Agelena*, but *Theridion*, *Epeira*, *Dolomedus*, and *Pholcus* were used for comparison. He agrees with Locy in thinking that the superficial polygonal areas on the egg are due to a pressure of the yolk columns on the periplasm; they are probably formed when the eggs pass through the oviduct. In the process of segmentation the yolk and the nucleus are divided at the same time; segmentation is syncytial. After segmentation all the nuclei are formed on the surface of the egg. The primary blastodermic thickening is regarded as a modified gastrula mouth, the formation of which was obstructed by the abundance of yolk. The brain and the ventral nerve-cords are formed as a continuous ectodermal thickening. All the appendages are post-oral in origin, but the first abdominal segment bears no appendages.

The large fat-cells, which are derived from the endoderm, form blood-corporuscles. The lung-book is formed by an invagination at the posterior base of the first abdominal appendage; a similar invagination at the base of the second gives rise to an abortive trachea. There is an unpaired cœlomic cavity which belongs to the anal lobe; this becomes converted into the so-called stercoral pocket, but it is excretory in function, and not part of the alimentary canal. The dorsal circulatory vessel is formed by the fusion of the mesoblastic somites at the dorsal median line. The so-called body-cavity of the adult is not a true cœlom, but a secondary cavity.

The posterior median eyes are developed in connection with the brain, and the mode of their origin is quite different from that of the other eyes; all, however, are dermal and not neural in origin. A pair of coxal glands opens at the base of the third appendage; its duct is an ectodermic invagination, and its glandular portion is cœlomic in origin. Pharynx, œsophagus, stomach, and anus are all derived from the ectoderm, but the Malpighian tubes are products of the mesoderm.

Mid-gut of Galeodidæ.‡—Mr. A. Bigula describes the anterior part of the mid-gut of the Galeodidæ as consisting of three layers; the connective tissue, which is outermost, corresponds generally with that described by Frenzel in some Decapods. The tissue is spongy internally, while the outermost layer consists of cellulofibrous elements. With higher powers the tissue is seen to be made up of finely granular and rounded portions of protoplasm in which lie nuclei; they are separated by

* Jena, 1890. See Amer. Nat., xxv. (1891) pp. 280-1.

† Journ. College of Science, Imp. Univ. Japan, iv. (1891) pp. 55-88 (6 pls.).

‡ Biol. Centralbl., xi. (1891) pp. 295-300.

refractive, colourless, homogeneous bands; the nuclei are polyhedral, feebly staining bodies containing large, intensely coloured chromatin granules. The epithelium of the same region of the gut consists of high and very delicate cylindrical cells, which widen out somewhat at their free ends. The nuclei are large and of an elongated oval form.

Between the third pair of blind tubes and the enteric sacs the dorsal wall of the mid-gut forms a glandular area; the peculiarity of the epithelial cells is that the nuclei, lying in the centre of the cell, are surrounded by a clear area. Just before the mid-gut passes into the abdomen there is developed a so-called enteric sac; this is a gland made up of four parts, which may be regarded as simple, pouch-like evaginations of the wall of the mid-gut. In the hind-body the mid-gut gives rise to the so-called hepatic tubes; these are not, as in true Spiders, united into a compact mass, but form a system of dichotomously branching cylindrical tubes, not connected together with intermediate tissue; these tubes fill up all the interspaces between the different organs. Their investing tunica serosa does not form a complete layer, but rather a loose meshwork, which consists of groups of cells connected with one another in a plexiform manner. The epithelium consists throughout of similar, cylindrical, high cells, and there is no division into ferment- and liver-cells, as in true Spiders and Crustacea. The pigment-granules contained in them show, however, that they must be compared with the liver-cells of Spiders, Crustacea, and Molluscs.

American Spiders.*—The first volume of this valuable and interesting work presented evidences of original and persistent research not often equalled in the class of biological work it deals with, and revealed to a much larger area of readers than his previous academic memoirs could possibly have done, the great value, and frequent entire originality of Dr. McCook's researches. Beyond this, the book was so written and illustrated as to arrest many other readers than biologists studying and seeking the fullest knowledge of aranean life and habits.

The present volume surpasses its predecessor in many respects; it represents a very large amount of close personal observation, and that on just those points on which information is so desirable and needed. Dr. McCook throughout deals lightly with the anatomy and physiology of the group; although he shows perfect familiarity with the latest and best work done on these subjects, up to the time of going to press. But his observations throughout are on the habits and work of the spiders. The chapters in this volume on "The Courtship and Mating of Spiders" are certainly treated in a popular manner; but manifestly this is the character of the entire book; nevertheless, it nowhere obscures or even endangers accuracy, and in so complex and difficult a subject this is evidence of a high order of success.

The illustrations given are as life-like, as to the observer of spider life they are singularly happy and true; only the author's opportunities of observation have been of an unusually ample nature. His observations on these aranean lovers, the stages of their courtship, and the fierce and curious quarrels of the males for the possession of the females, are not

* McCook, H. C., D.D., 'American Spiders and their Spinning Work. A Natural History of the Orbweaving Spiders of the United States, with special regard to their Industry and Habits.' Vol. ii., 479 pp., 5 pls. Published by the author.

only of much interest, but of much value; for it will be remembered that Mr. Blackwall informed Charles Darwin that he had never observed and was not inclined to think a quarrel probable. The drawings from life, and the further descriptions given by this indefatigable student of the living spiders, are of the utmost practical value. The same may be said of "the love dances of Saltigrades," as displays to attract females, and many similar observations are not only valuable confirmations of the studies of others, but are indications to field naturalists of new and important directions for observation.

On maternal industry and instincts we have another group of chapters, full of evident work and suggestiveness. The weaving of the silken sac within which the eggs are deposited, and its subsequent disposal so as to secure the greatest protection for its vital contents from the exigencies of weather and the assaults of enemies, are presented with a detail and sympathetic insight, accompanied by beautiful graphic portrayal, which gives unique value to the work; and at the same time attention is called to the work of others, so that a practical account of our present knowledge on the subject is fully given.

On the early life and distribution of species, and on the "ballooning" habits of spiders, there are many things of much interest said, as there are on the senses of spiders and the relation which the senses bear to habit, dealing with the minute structure of their eyes, and discussing in detail specialities in work, such as cocooning and snare-building in the dark, and the general "night habits" of the Spider; the colour of eyes, the cases of atrophy in these, their sensitiveness to light and the limit of their vision when they are normal, and the condition of cave spiders, are all carefully considered and illustrated. So also are the sense of smell, of hearing, and the delicacy of touch; in like manner an account is given of the nature and purpose of stridulation in some spiders.

This careful study of the nature and habits of aranean life also involves a discussion of colour and the colour sense in spiders, which we are inclined to believe would have been more broad and deep had their manifest sexual influence been more readily admitted; but no student of spiders can study it without much profit. The influence of mimicry amongst spiders is carefully considered and illustrated in all its relations; the influence of the enemies of spiders on their habits, and the disguises of death feigned by them are presented and illustrated in a manner which, if this book were accessible to the multitude, would secure for it a larger number of readers than are now likely to peruse its pages.

The book has yet to be completed by a third volume. Certainly this second one, with its five beautiful chromolithographic plates, surpasses the promises of its author, and when the whole book is complete we can but hope that its popularity, combined with its accuracy and originality, may make a new edition possible, which will at once relieve the author of the cares and, we fear, uncompensated cost of the present mode of publishing.

External Characters of Mites*—Dr. L. Karpelles describes the bristles, the extremities of the appendages, and the jaws of some mites.

* Verh. K. K. Zool.-Bot. Gesell., xli. (1891) pp. 300-6 (6 pls.).

The bristles on the back of *Smaridia pileifera* n. sp. are club-shaped and hollow; it may be that they are simply protective, but there is reason to believe that from them a repulsive excretion may exude. In a species of *Tinoglischrus* from a bat, the strong appendages end in two chitinous claws between which is a cup viscid internally. Some other peculiarities of the appendages are noticed. Herr Karpelles also describes the remarkably strong and long jaws of *Sciphiodes maxillatus*, and gives other illustrations of remarkable modifications.

Embryology of Mites.*—Dr. E. Sicher describes some of the stages in the development of *Tyroglyphus longior*, *Pterodectes bilobatus*, *Freyana anatina*, *Histiostoma iulorum*. The first stages were not in any case satisfactorily observed, but the history of the appendages was followed. The most novel result of Dr. Sicher's researches is the demonstration of the presence of a fourth pair of limb-buds in the earliest stages of development. They represent the corresponding pair of appendages, and suggest the idea of a "proto-larva."

Brain of *Limulus Polyphemus*.†—Prof. A. S. Packard has continued his investigation of the brain of the King-Crab. Its most striking histological feature is the immense development and singular arrangement of the convoluted, ruffle-like masses which form the thick layer of "nucleogenous bodies," which form the cortex of the cerebral and other lobes, and which inclose masses of myeloid substance. They appear to be simply nuclei, but when they are scattered they are seen to be ganglion-cells. Another characteristic of the brain of *Limulus*, as compared with all other Arthropods, is the remarkably small number of the normal ganglion-cells. The striking differences between the brain of *Limulus* and that of Arachnids are pointed out; in the adult it is made up of three pairs of lobes, the first and uppermost of which are the lateral-eye lobes; below them are the median-eye lobes, and the third are the cerebral; these last are very irregular in outline and slender. On the whole, however, the brain of *Limulus* resembles that of Arachnids more than that of Crustacea; no "deutocerebrum" or "tritocerebrum" is to be found in it.

The cerebral differences in addition to the other points of distinction appear to the author to warrant the separation of the Podostomata (Merostomata and Trilobita) from the Arachnids, although their common origin is not to be denied.

δ. Crustacea.

Arterial System of Crustacea.‡—M. E. L. Bouvier gives an account of his investigations into the arterial system of Crustacea. The ophthalmic artery, before reaching the anterior edge of the stomach, gives off several branches not only in the Brachyura, but also in some of the Macrura; at this edge it forms a more or less marked dilatation which is probably homologous with that observed in Amphipoda and Schizopoda. The antennary arteries always supply the eyes as well as the ophthalmic arteries, and combine with them in the Brachyura to irrigate the rostrum. In those Macrura in which the rostrum is well developed

* Atti Soc. Ven.-Trent. Sci. Nat., xii. (1891) pp. 1-22 (3 pls.).

† Zool. Anzeig., xiv. (1891) pp. 129-33.

‡ Ann. Sci. Nat., xi. (1891) pp. 197-282 (4 pls.).

they anastomose frequently. The green gland is supplied by the antennaries and by the anterior branches of the maxillipedal artery. The liver is almost entirely nourished by the superior abdominal artery. There are two small valves at the orifices of all the arteries in the heart, but the arrangement of the arteries varies somewhat. All the Decapoda with the exception of *Pagurus* are provided with two abdominal arteries, an upper and a lower. Important communications put these two vessels into connection with one another; these take the form of vascular arches which are always more or less symmetrical, and always circum-intestinal. The existence of these anastomoses is due to the great flattening of the abdomen; the two vessels having to irrigate parts very close to one another, fuse almost at once. The lamellated form of the abdomen in the *Brachyura* destroys completely the symmetry of the two abdominal arteries. In the *Macrura* the upper abdominal artery is very much more developed than the lower, in correlation with the great development of the dorsal muscles. In the *Brachyura* the lower artery is not as feeble as might be expected.

All the facts lead us to conclude, with Claus, that the arterial system of Decapod Crustaceans is most like that of the Isopoda.

Renal Organs of Decapod Crustacea.*—Prof. W. F. R. Weldon describes the renal organs of certain Carididæ (*Pandalus*, *Virbius*, and *Crangon*) in which the structure of the green gland is modified in a very remarkable manner. The result of his observations is that these forms exhibit a series of modifications which result in the disappearance of the whole tubular portion of the green gland, and the hypertrophy and specialization of the end-sac. A comparison is made between the different parts of the excretory system in the various families of the Decapoda; the general result appears to be that the nephro-peritoneal sacs of this division should be regarded rather as enlarged portions of a tubular system, such as that found in *Mysis* and the *Thalassinidæ*, than as persistent remnants of a "cœlomic" body-cavity into which tubular nephridia open.

Female Reproductive Organs of Decapoda.†—Dr. G. Canu has studied the structure of the ovaries, oviducts, and cement-glands in Decapoda, and has also made observations on the modes of impregnation. Beginning with the external morphology of the reproductive organs, he notes that they are primitively double and bilaterally symmetrical, that in *Penaidæ* they are least differentiated and nearest the simple type exhibited by *Nebalia*, and that the presence of a vagina and a receptaculum seminis in the females is correlated with the presence of a penis in the males.

In *Dromia* the receptaculum is formed after copulation as a simple evagination of the vagina, which seems to show that the evolution of the receptaculum was subsequent to that of the penis. The ovary and oviduct are formed from an external stroma of connective tissue and an internal stratum of epithelium; the ovary differs from the oviduct in the nature of its epithelium and in the presence of an internal stroma arising from the supporting membrane; the ova are always formed on

* Quart. Journ. Micr. Sci., xxxii. (1891) pp. 279-91 (2 pls.).

† MT, Zool. Stat. Neapel, ix. (1891) pp. 503-32 (1 pl.).

the internal surface of the ovary, and, except in the Mysidæ, along its whole length; in *Macrura* and *Paguridæ* the vulva is the only ectodermic portion of the internal reproductive organs; in *Dromiidæ* and *Brachyura* the ectoderm is invaginated to form a vagina and a seminal reservoir; the receptaculum seminis is a diverticulum of the vagina; the aggregating material in the receptaculum resembles fluid chitin.

In *Macrura*, the cement-glands are situated just under the epidermis on the internal surface of the epimera and on the ventral surface of the lateral laminae of the telson; the *Thalassinidæ* and *Stenopus* are exceptional in having the glands restricted to the pleopods; in *Paguridæ* the glands occur in 12-16 groups on the ventral and lateral surfaces of the pleon, near the pleopods and in the anterior labriform expansion; in *Homola* and in all *Brachyura* the receptaculum acts as a cement-gland.

In *Brachyura* and in *Anomura* the eggs are fixed to the hairs of the internal branch of the pleopods, in *Palinuridæ* and *Astacidæ* to the hairs on the stalk of this branch, in *Caridæ* to the hairs on the abdominal surface and on the basal joints of the first four pleopods, in *Lucifer* near the last pair of thoracic appendages. In *Penaidæ* the eggs are not fixed, perhaps because no incubatory chamber can be formed. It is likely that the cement-glands are modified glands of the appendages ("Beindrüsen"). The ova have at first a single membrane or chorion which becomes chitinous, but they subsequently acquire a second envelope formed from the cement-glands.

Copulation is always preceded by a moult, first of the male then of the female. When a receptaculum is developed, the ova are fertilized as they pass the opening of the seminal reservoir; when there is no receptaculum, they are fertilized as they are liberated. The cementing substance may serve as a medium through which the spermatozoa reach the ova, into which they pass in all likelihood through the pores of the chorion.

Compound Eye of *Macrura*.*—M. H. Vialanes is of opinion that Patten's views on the morphology and physiology of the eye have not the general character which he claims for them; each of the segments of the cone, far from being continuous with the rhabdoms, terminates in a filament which becomes attached to the basal membrane. In other words, the cone is to be regarded as merely an organ of refraction. The nerve-fibres do not terminate in the protoplasm of the retinal cells, but are directly connected with the rhabdoms. Each of the seven rhabdomeres is connected with a special nervous tube, and it is, therefore, very probable that each ommatidium may be the point of departure of at least seven distinct luminous sensations.

Development of American Lobster.†—Dr. F. H. Herrick gives a somewhat detailed account of the development of the American lobster. The animal appears to spawn at a definite period of the year, and copulation to precede oviposition by a considerable period.

There is great irregularity in the segmentation; the period of incubation is about three hundred days. Some remarkable variations

* Comptes Rendus, cxii. (1891) pp. 1017-9.

† Zool. Anzeig., xiv. (1891) pp. 133-7, 145-9.

and irregularities occur in the keel and egg-nauplius stages. Degenerating nuclei occur in the fully-formed egg-nauplius, and are most noticeable in the region of the stomodæum and optic discs. The author believes that the fragmentation and dissolution of cells is a common phenomenon among the Crustacea and other Arthropods.

Development of Daphnia from the Summer-egg.*—Mr. J. Lebedinsky has made a study of *Daphnia similis*, the summer-egg of which is quite spherical and 0·125 mm. in diameter; it is invested in a chorion and a vitelline membrane; the nutrient yolk is concentrically arranged, is green or blue in colour, and makes the egg quite opaque. In each egg there is always a large excentrically placed fat-sphere, around which smaller ones are grouped: the protoplasm is amœboid, has a lobate zone, and takes up the yolk.

Segmentation is superficial; the descendants of the amœboid cell multiply by division and creep from the centre to the periphery of the egg, only a few remaining in its interior; others give rise to plasmodia. In time a continuous blastodermal layer is formed, the cells of which are all of the same size and form. Some of the cells become high and cylindrical and form the elongated germ-stripe. The embryo is now bilaterally symmetrical, but has still a spherical form. The blastopore is a slight depression below which are a few amœboid cells which slowly sink into the yolk. These cells form the meso-endoderm which becomes differentiated into separate, independent layers. The endoderm forms a solid cord in which cavities appear later on. All the endodermal cells do not form part of the mid-gut, as some extend over the nutrient yolk, and form two large provisional liver-sacs.

The shell-gland is formed as a paired mass of mesodermal cells, which are clearly distinguished from their neighbours by their structure and size; the heart is at first an aggregate of mesodermal cells; later on the peripheral cells form a unilaminar pericardium. No special genital cells are present in the early stages of cleavage, and the rudiments of the gonads are not to be recognized in the nauplius stage.

Vermes.

a. Annelida.

Innervation of Proboscis of Glycera.†—M. E. Jourdan finds that in the muscular sheath of the proboscis of *Glycera* there are eighteen nerve-fibres; these end in a collar which is arranged around the opening of the proboscis, and which contains numerous nerve-cells; it may be called a proboscical nerve-ring. The fibres penetrate into the epithelial layer, and are distributed in the very curious papillæ which are found on the surface of the organ. At the extremity of the proboscis the nerve-elements enter into relation with an epithelial pad, which is set like a crown behind the hooks. The papillæ of the proboscis are of two types; some are cylindroconical, and others are irregularly spherical and analogous to fungiform papillæ. The investing cuticle is very delicate and perforated at a point which corresponds to the tip of these organs. The body of each papilla is formed of a pigmented protoplasm;

* Zool. Anzeig., xiv. (1891) pp. 149-52.

† Comptes Rendus, cxii. (1891) pp. 882-3.

this generally contains one, but sometimes two spherical nuclei. Other cellular elements appear to have other functions than that of forming the papilla.

Staining shows that there are three or four nuclei in the centre of the papilla; these are ovoid in form, and belong to fusiform cells which are arranged in bundles and traverse the papilla longitudinally.

The annular pad represents a region in which the sensory elements of the papilla are grouped into a larger organ and one of different morphological appearance. It is entirely formed of sensory fusiform cells, intermixed with which are a few cylindrical elements, and it is situated in a zone where the epidermic cells are ciliated. We need not wonder at the delicate tactile powers of the proboscis of these worms.

Nephridium of Lumbricus and its Blood-supply.*—Dr. W. B. Benham finds that where Goehlich's recent statements as to the structure of the nephridium differ from those of Gegenbaur, the latter author is the more correct.

He describes in detail the structure of the various regions of the nephridial tube, and makes suggestions as to the functions of the parts. A comparison is then instituted with the same organ in other genera of earthworms; greatest variety in structure obtains in the funnel. It has long been known that the nephridium is provided with an elaborate blood-supply, but no drawings or detailed descriptions have as yet been given; this lacuna the author now supplies.

In conclusion, an account is given of the nephridium of *Arenicola*, which has an elaborate vascular network, and a wide intercellular lumen. A figure of the whole organ is given, which represents more clearly than the generally accurate figures of Cosmovici and of Cunningham the form and situations of the parts.

Regeneration of Tail in Lumbricus.†—Miss H. Randolph has been led to conclusions which differ materially from those at present accepted. She finds that the new ectoderm arises by the proliferation of the ectoderm around the line of fission. From the ectoderm the ventral nerve-chain and the lateral nerve-line are formed. Between these two are two other "foundations" on each side, which correspond in position to those subsequently occupied by the nephridia and the ventral setæ. The new endoderm is formed from the old; as the ectoderm grows faster than the endoderm the material necessary for the proctodæal invagination becomes formed. The new mesoderm is largely formed from specialized cells of the peritoneal epithelium of the ventral longitudinal muscles, on each side of the ventral cords; these cells, which it is proposed to call neoblasts, are distinguishable from the cells of the peritoneum by their great size and by the presence of a cell-body. They represent the "chorda-cells" described by Semper in the Nais and *Chætogaster*. In very early stages, as soon as the ectoderm and endoderm have extended themselves sufficiently to form a new cavity, small cells are seen dorsally, laterally, and ventrally; they seem to have no connection with the neoblasts and their products, but no positive account can be given of their origin. These smaller mesoderm cells give rise to all the circular

* Quart. Journ. Micr. Sci., xxxii. (1891) pp. 293-334 (3 pls.).

† Zool. Anzeig., xiv. (1891) pp. 154-6.

muscles, and apparently to the dorsal longitudinal muscles, and the wall of the dorsal blood-vessel.

The neoblasts are to be regarded as specialized embryonic cells set apart for the rapid formation of new mesodermic tissue immediately upon the fission of the worm. Their general interest consists in their bearing upon the subject of the germ-layers and of organic reproduction. Their presence seems to point to the independent existence of the mesoderm as a germ-layer. With regard to the latter subject, the presence of neoblasts in Nais and *Tubifex* appears to connect the processes of budding and of regeneration on definite structural grounds.

New Earthworm.*—Mr. F. E. Beddard gives an account of the structure of the earthworm, whose remarkable action on the soil of Lagos we have already noticed.† It belongs to the genus *Siphonogaster*, and it is proposed to call it *S. Millsoni*. It is at once distinguished from *S. ægyptiacus* by the smaller size of the remarkable appendages which seem to have the function of copulatory organs, and which are so rarely developed in terrestrial worms.

Libyodrilus.‡—Mr. F. E. Beddard also describes a new genus of earthworm from West Africa, likewise discovered by Mr. Millson. It is allied to *Hyperiodrilus*, but is unique among earthworms in that the oviducal pores are on segment XV. The author abstains for the present from offering any suggestions as to its particular affinities. It is called *L. violaceus*.

Embryology of Nephelis.§—Dr. O. Bürger finds that the cavitory system of *Nephelis* which ultimately incloses the ventral cord and the nephridial funnels is developed in the following manner. In each segment a pair of primitive segmental cavities is developed which fuse with one another in the middle of the germ-stripe and form a median cavity; this gives rise to a continuous tube which traverses the whole length of the germ-stripe, and connects the lateral cavities not only with one another, but those of one segment with those of another. The primitive segmental cavities arise separately from one another by the cleavage of the two inner cell-layers of the germ-stripe which forms a somatic and a splanchnic layer.

The author thinks that the lateral cavities—the direct descendants of the primitive segmental cavities—are the spaces which Prof. A. G. Bourne has described as only secondary, and as formed by the botryoidal tissue; that, in fact, they are true cœlom-spaces and homologous with the segmental portions of the cœlom of Annelids.

The two blood-vessels first appear, at a relatively late period, in the œsophageal region; they are either developed from the remains of the primitive cleavage-cavity, which, extending actively forwards and backwards, drive the tissues apart, or they arise for their whole length by cleavage which commences in the œsophageal region. Their development has nothing to do with the cœlom or its layers.

Not only do the facts of embryology and anatomy show that there is no communication between the blood-vessels and the cœlom, but this is

* Proc. Zool. Soc. Lond., 1891, pp. 48-52 (3 figs.).

† See *ante*, p. 40.

‡ Proc. Zool. Soc. Lond., 1891, pp. 172-6.

§ Zool. Jahrb. (Abth. f. Anat.), iv. (1891) pp. 697-738 (3 pls.).

confirmed by the difference in colour between the blood of a quite young *Nepheleis* and the blood which fills the cœlom, for one is red and the other yellow. Later on this difference in colour disappears.

After some notes on the development of the nephridia the author treats at greater length of that of the generative organs. He finds that the ovaries are developed on the peritoneum of sections of the cœlom which, later on, become constricted off from it and cease to communicate with it; they then form special ovarial cavities on either side of the ventral cavity. The testes commence as a ridge of cells derived from the fusion of rudiments which have appeared in each segment on the peritoneum. This ridge becomes constricted off for its whole length from the cœlom, is hollowed out and formed into a tube. This gives rise to the testicular sacs by developing numerous outgrowths which widen out more and more, but never lose their connection with the genital tube. The epithelium of the testicular sacs which is derived from that of the tube, and ultimately from the peritoneum, gives rise to the rudiments of the male generative cells. The genital tube persists and takes on the function of a vas deferens. The development of the organs of the male copulatory apparatus is very complicated, but is interesting, from the histogenetic point of view, in consequence of the various glandular cells and muscular layers which go to make it up. In the course of his investigation the author was much struck by the many points of resemblance between the developmental history of *Nepheleis* and that of certain Annelids, so that he is brought to regard the Hirudinea as a special group of that division, standing nearest to the Oligochæta.

B. Nemathelminthes.

Nectonema agile.*—Dr. O. Bürger has made a study of this little-known worm, which, with some doubt, Prof. Verrill, its original describer, regarded as a Nematoid. The investigation shows that it is certainly a round worm, and it has some points of affinity to *Gordius*. It resembles it in the want of lateral areas, and the developed ventral ridge recalls the nervous system of *Gordius*; in its muscular and digestive apparatus it approaches rather *Trichocephalus*, but it is peculiar in having only a very small part of the enteric wall formed of four cells, and the rest consisting of two rows of cells only. In this latter point there is likeness to the *Rhabditis*-forms, but they have a pharynx which *Nectonema* has not. On the whole, the form seems to occupy a very isolated position.

Anticomma.†—Mr. N. A. Cobb has a monographic account of this genus of free-living Nematodes, in which he gives a detailed definition of the genus and of its four constituent species, one of which, *A. typica*, is new.

γ. Platyhelminthes.

Diplozoon nipponicum.‡—Mr. Seitaro Goti describes a new species of this remarkable Trematode which differs from *D. paradoxum* in the smallness of the posterior suckers, the greater length of the posterior

* Zool. Jahrb. (Abth. f. Anat.), iv. (1891) pp. 631-52 (1 pl.).

† Proc. Linn. Soc. N.S.W., v. (1891) pp. 765-74 (2 figs.).

‡ Journ. College of Science, Imp. Univ. Japan, iv. (1891) pp. 151-92 (3 pls.).

half of the body, the shortness of the "connecting canal" between the intestine and the oviduct, the presence of a pair of glands at the entrance to the mouth, and the absence of lateral branches from the posterior part of the intestine. The author gives a detailed account of the anatomy of his new species.

He confirms the view of Zeller that the union of the two individuals is a permanent copulation, but corrects him as to the mode, for he states that the vas deferens of one individual opens into the yolk-duct of the other, and not into Laurer's canal. It appears probable that in *Microcotyle* the spermatozoa are passed into a dorsal vagina which leads into a canal opening into the yolk-duct. If in *Microcotyle* there is also cross-copulation then the only extraordinary point about *Diplozoon* is that the mode of copulation regular in allied forms is there made permanent.

Structure of *Phagocata gracilis*.*—Mr. W. M. Woodworth devotes the first of his contributions to the morphology of the Turbellaria to the study of the remarkable Triclad, for which Dr. Leidy proposed the generic name. This worm differs from all known Triclads in possessing not only the ordinary pharynx, but many additional pharynges which are joined to the two lateral trunks of the intestine. Histologically they resemble the median pharynx, and differ from it only in size.

The rhabdites are developed in cells which lie in the subhypodermal mesenchyma, and these are connected with the hypodermis by fine tubular prolongations; they are ultimately discharged, and new rods are constantly being developed in new parent cells; these last are unicellular glands, and the rods are their condensed secretions.

The structureless basement membrane is a product of the hypodermis; the pigment is intercellular and occurs in the form of scattered granules. The pseudocœlar spaces of the mesenchyma are intercellular in origin, and sagittal muscles are directly continuous with processes of the mesenchyme cells. The superficial and deeper portions of the nervous system are indirectly connected by a marginal nerve, and the condition in *Phagocata* may be intermediate between that of *Gunda* and *Rhynchodesmus*; the brain has an anterior and a posterior commissure; the so-called "Substanzinseln" are regarded as intrusive connective tissue.

The vasa deferentia have terminal enlargements and function as vesiculæ seminales; the yolk-glands arise by cell proliferation from two cell-masses, the parovaria, which are in immediate contact with the ovaries. The intimate connection of the parovaria and ovaries indicates that the ovary and vitellarium were differentiated from a common gland. The so-called uterus is not merely a gland, but a place in which the sexual elements are brought together, and fertilization effected.

***Rhynchodesmus terrestris*.**†—Mr. S. F. Harmer has been able to show that this Land Planarian is by no means uncommon in Cambridge. It is probable that this animal is much commoner than is usually

* Bull. Mus. Comp. Zool., xxi. (1891) pp. 1-42 (4 pls.).

† Proc. Camb. Philos. Soc., vii., pt. ii., 1 p. [separate copy].

supposed; it should be looked for on the damp lower surface of logs of wood which have been lying for some time on the ground.

Victorian Land Planarians.*—Mr. A. Dendy describes fifteen Victorian species of Land Planarians, eleven of which are new. All but one—*Rhynchodesmus Victorix*—belong to the genus *Geoplana*. These forms do not appear to have wide specific areas of distribution. Specific distinctions may be safely based on a combination of the following characters—colour and pattern, position of the external apertures, and general shape of the body.

If a living land Planarian is placed in loose dry earth it forms a cyst for itself by cementing together the particles of earth with its slimy secretion. Within this cyst the worm lies completely hidden, and the habit of forming the cyst may be a protection against desiccation, and account for the disappearance of these Planarians in the heat of summer. They are certainly carnivorous in habit. The mode of copulation and the formation of cocoons are described.

The brilliant coloration of these worms appears to be of a warning nature, for the application of the tongue to the slimy surface of the animal suffices to produce an exceedingly unpleasant sensation, something like that caused by putting a piece of velvet or a lump of alum into the mouth. A living specimen of *Geoplana Spenceri* was thrown to some hens who, not being native birds, would not recognize it; they speedily took it into their mouths, but quickly dropped the pieces.

Genital Organs of Tristomidæ.†—M. G. Saint-Remy has studied the generative apparatus of *Tristomum molæ*, *Phyllonella solæ*, *Pseudocotyle squatinæ*, *Microbothrium apiculatum*, and *Udonella pollachii*. The male apparatus is formed on one and the same plan, but is simplest in the *Udonellinæ*, and most complicated in the *Tristominæ*. There are special glands which secrete a liquid destined to mix with the spermatozoa, and these "prostates" empty their products into a reservoir which communicates with the ejaculatory canal, and are under the influence of the muscles of ejaculation. In *Phyllonella* there are, in addition, special glandular cells which line a part of the seminal canal; these are analogous with those which have been observed by Linstow in *Epibdella*. The ejaculatory apparatus consists of an ejaculatory vesicle which is under the influence of more or less powerful muscles, and of a canal which is often situated in a penis, which, again, is lodged in a deep invagination of the wall of the body; in the *Udonellinæ*, however, there is no copulatory organ.

The female organs are similarly formed on a common type, and as in the male, the principal modifications are to be found in the copulatory apparatus. A seminal reservoir is always connected with the genital ducts; of these latter there is one or two, or none. In *Udonella* it is probable that self-fecundation is effected by the intermediation of the genital cloaca. *Tristomum* is the exception to the rule that the orifice of egress for the ova and that of the tegumentary invagination which incloses the penis are found in a common cloaca. There does not

* Trans. Roy. Soc. Victoria, 1860, pp. 65-80 (1 pl.).

† Comptes Rendus, cxii. (1861) pp. 1072-4.

appear to be in the Tristomidæ any duct analogous to the vitello-intestinal canal of many Polystomidæ.

Tristomum histiophori.*—Prof. F. Jeffrey Bell describes a new species of Trematode under the above name, and points out its differences from *T. coccineum*, to which it is closely allied, and which has been found on *Xiphias*, a close ally of *Histiophorus brevirostris*, the host of the new species.

Remarkable Flat-worm Parasitic in Golden Frog.†—Prof. W. A. Haswell describes a remarkable flat-worm, superficially like a *Ligula*, which he has found parasitic, chiefly in subdermal lymph-sinuses, in *Hyla aurea*. It has the form of a long and narrow, transversely ribbed white ribbon, and the largest was about two inches long and a tenth of an inch in breadth. The narrow segments of the body are very sharply defined in front; no opening could be found and no vestige of hooks or suckers. There is no alimentary canal and the worm is probably, therefore, a Cestode. Its situation and the absence of reproductive organs show it to be a scolex. Only three genera of Cestodes are known to have solid, elongated scoleces—viz. *Tetrarhynchus*, *Schistocephalus*, and *Ligula*, but that of the first is cylindrical in form, and is unsegmented.

An account is given of the appearances presented by sections of the worm; a nervous system can be detected, but it is very indistinct; the only internal organs that are well developed are the canals; a main trunk of considerable size runs along each side; numerous branches are given off, but not in any regular relation to the segments.

Symbiosis of Echinococcus and Coccidia.‡—Herr Lominsky found in the muscle of a ham a large number of nodules, roundish or oval in shape, and of a dirty grey or brownish colour. Most of the nodules were quite minute. The smallest consisted of a connective-tissue capsule with granular contents, in which the ovoid coccidia were very obvious. The larger ones contained as well as the coccidia an Echinococcus head with the characteristic hooklets.

The author supposes the coccidia to be *Coccidium oviforme*, and that these have found their way into the nodules through the blood-vessels in the capsule.

δ. Incertæ Sedis.

Anatomy and Transformation of Tornaria.§—Mr. T. H. Morgan comes to the conclusion that the larval *Tornaria* found on the coast of New England, and regarded by Agassiz as the young of *Balanoglossus Kowalevskii*, is not the young of that form. This explains the difficulty of Bateson who found direct or abbreviated development in that species.

The free-swimming *Tornaria* undergoes many changes both in size and structure during its pelagic life; the ciliated bands are not nearly so complicated in earlier as in later stages. As the larva increases in size, two posterior pairs of body-cavities appear, and a mass of cells is

* Ann. and Mag. Nat. Hist., vii. (1891) pp. 534-5.

† Proc. Linn. Soc. N.S.W., v. (1891) pp. 661-6 (1 pl.).

‡ Wratsch, 1890, No. 18. See Centralbl. f. Bakteriol. u. Parasitenk., ix. (1891) pp. 124-5.

§ John Hopkins Univ. Circ., x. (1891) pp. 94-6.

formed in the region of the opening of the water-tube. The first pair of paired body-cavities do not originate as folds from the gut, but a proliferation of cells forms a thickened mass at two opposite areas of the mid-gut. These cells afterwards arrange themselves round a central cavity, and the body-cavity arises by increase in number of these cells; the second pair of paired bodies arises from a solid fold at two opposite points of the posterior division of the mid-gut, which very early pinch off from the endoderm.

The two eyes are not simple pigment-spots, but well-defined structures; each is semicircular in shape, and each constituent cell ends towards the concave side in a sharp spine-like process.

As the larva alters in shape there is a decided decrease in size and the ectoderm becomes thickened over the whole embryo; the diminution in size is very similar to the process found in Echinoderms just before their metamorphosis. The most important change at this time is the development of the nervous system in the collar region; a plate of ectoderm sinks below the surface, and at the same time the collar rolls over the invaginating plate of ectoderm from the two sides. It is clear that in this region the nervous system originates in the same way as in *Amphioxus*, that is, the ectoderm from the two sides rolls over a median plate and fuses above it.

The walls of the heart are formed by the application of two vesicles—the mesenchymatous vesicle and the enterocoel—just as the other blood-vessels are formed by the contact of the body-cavities of the two sides.

It is obvious that the similarity of *Tornaria* to the larvæ of Echinoderms is very great, and the author cannot believe it to be superficial. If it be not, the antiquity of the larva must be very great.

Echinodermata.

Embryology of *Asterias vulgaris*.*—Mr. G. W. Field has commenced the study of the development of the common American starfish. The mother-cell gives rise to four spermatozoa. The formation of mesenchyme appears to precede and to be continued during the process of invagination; cells in the endodermic region of the blastula divide transversely, the part next to the segmentation cavity becomes amœboid, and wanders freely in the jelly-like substance, filling the segmentation cavity. Any endodermal cell may, with or without division, become a free, wandering, mesenchyme-cell. These observations seem to confirm the view of Metschnikoff and Korschelt as to the absence of the two primitive mesenchyme cells in Echinoderms.

The amœboid mesenchyme-cells form a supporting network between the external walls and the digestive tract; many apply themselves to the wall of the body and of the digestive tract; on the former they give rise to a discontinuous lining, and on the latter they form long, delicate, anastomosing processes, and give rise to muscles. The author's account of the distribution of cilia does not quite agree with that of Semon.

There is an ectodermal thickening at the apex of the pre-oral lobe, due to the more columnar character of the cells in this region; this thickening corresponds exactly in position with the apical plate of *Tornaria*.

* John Hopkins Univ. Circ., x. (1891) pp 101-3.

The pore-canal is formed from endodermal and ectodermal elements, and not as in *Antedon* (Bury), by the perforation of a single elongated cell. The stage with two bilaterally symmetrical pores does not appear to be pathological, but to be a definite stage in the ontogeny of *Asterias*, and to have a phylogenetic significance.

On the whole, this investigation tends to strengthen the view that the bilateral larval form of Echinoderms is ancestral and not secondarily acquired.

Early Stages of Echinoderms.*—Prof. W. K. Brooks found that normal, vigorous starfish larvæ have the water-system at first bilaterally symmetrical in every particular, though the right water-pore and pore-canal degenerate and disappear very early. Soon after the appearance of the ciliated bands there is, on each side of the stomach, an ingrowth of ectoderm, so that, later on, each enterocœl has a fully developed canal to the exterior, though the right one degenerates and disappears, while the left migrates towards the middle line of the body. The author thinks that this phenomenon furnishes a strong argument in favour of the view that the larva is ancestral, for a bilateral structure which loses its symmetry almost at the beginning of locomotor life cannot be an adaptation to locomotion.

The resemblance between the paired pore-canals of these larvæ and such structures as the spiracles of *Appendicularia* and other Tunicate larvæ is worthy of note, for in both cases paired ectodermal involutions meet and fuse with diverticula from the digestive tract.

Starfishes collected by the 'Hirondelle.'†—Prof. E. Perrier has a note on the starfishes collected by the Prince of Monaco in the Atlantic. Of the thirty-three species nine are new. Of these, four are types of new genera, and for them there are proposed the names *Prognaster Grimaldii*, *Calycaster monæcus*, *Scleraster Guernei*, and *Hexaster obscurus*. *Prognaster* has a dorso-central, five small underbasals, five large basals, and the first radials or "carinals." *Calycaster* is remarkable for the simplicity of its skeleton. *Hexaster* is one of the Pterasteridæ, allied to *Marsipaster* and *Calyptroster*, and is remarkable for having six arms, and a convex and relatively resistant dorsal surface.

Classification of Holothurians.‡—Prof. H. Ludwig, after giving a detailed account of *Ankyroderma musculus*, a Molpadiid from the Mediterranean, discusses the arrangement *inter se* of the groups of Holothurians. He takes notice of various organs of the body, such as the tentacles, the corpuscles in the skin, musculature of the body-wall, retractors, calcareous ring, tentacular canals and ampullæ, stone-canal, intestine, branchial trees, Cuvierian organs, gonads and blood-vascular system. A review of all these leads to the conclusion that the Molpadiidæ are most closely related to the Dendrochirotæ; the presence of retractors, the structure of the stone-canal, the arrangement of the muscles of the wall of the intestine, and the feeble development of tentacular ampullæ indicate the affinity of the Synaptidæ to these other two groups. Prof. Ludwig believes that there was a primary dendro-

* John Hopkins Univ. Circ., x. (1891) p. 101.

† Comptes Rendus, cxii. (1891) pp. 1225-8.

‡ Zeitschr. f. Wiss. Zool., li. (1891) pp. 569-612 (1 pl.).

chirotus trunk which early gave off a Synaptid, and later a Molpadiid branch. As to the Elasipoda, he does not believe that they form a group equal to the Dendrochirotæ and Aspidochirotæ, but that they are an offshoot from the latter.

The primitive Holothurian would have ten simple cylindrical tentacles provided with feeble tentacular ampullæ, which sprang from the five radial water-vessels, as did also the pedicels, which were limited to the rays and provided with ampullæ; it would also have a calcareous ring formed of five radials and five interradial pieces; the transverse musculature of their body-wall formed an unbroken circular layer, the simple longitudinal muscles gave off no retractors; the stone-canal was simple, fixed in the dorsal mesentery, and directly connected with the exterior; the genital tubes were symmetrically developed on either side of the dorsal mesentery; auditory vesicles lay on the radial nerves; the respiratory tree and a simply arranged enteric blood-vascular system were developed, and the enteron took the course characteristic of Holothurians, while the integument was filled with fenestrated calcareous plates formed of hexagonal meshes.

Prof. Ludwig gives the following phylogenetic diagram:—

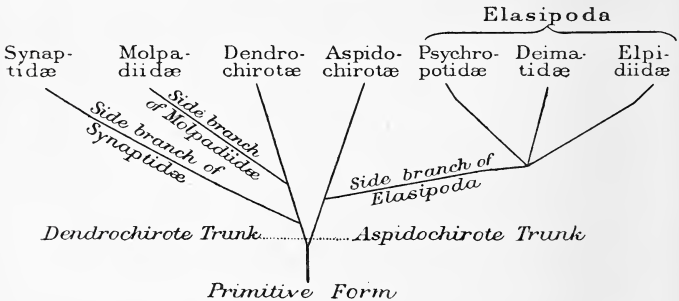

A criticism is made of the work of preceding systematists, some of whom fell into misleading errors. In all but the Synaptidæ all the feet and tentacles arise from the radial vessels which mark the rays of the plan of structure of the body, and they may, therefore, be called Actinopoda; in the Synaptidæ, however, some of the tentacular feet enter into relation with the circular canal, and they may, therefore, be called Paractinopoda. The following new classification of Holothurians is proposed:—

Class HOLOTHURIOIDEA.			
	1st Fam., Aspidochirotæ.		
1st Order, Actinopoda ..	{	2nd " Elasipoda {	1st Subfam., Psychropotidæ.
		3rd " Dendrochirotæ.	2nd " Deimatidæ.
		4th " Molpadiidæ.	3rd " Elpidiidæ.
		5th " Synaptidæ.	
2nd " Paractinopoda.			

Comatulids of Indian Archipelago.*—In a preliminary communication Dr. C. Hartlaub confines himself to a description of twenty-four new species of *Antedon* and two of *Actinometra*; most of them were collected by the late Prof. Brock. A key to the new forms, much after the method of that adopted by Dr. P. H. Carpenter, precedes the descriptions.

British Species of Asterias.†—In the course of a discussion as to the specific distinctness of *Asterias violacea* from *A. rubens*, Prof. F. Jeffrey Bell brings forward a considerable amount of evidence as to the great variations which are to be seen when a large collection of British specimens of *Asterias rubens* is examined; these are shown not to depend on depth or station. A well-marked form called *A. Murrayi* sp. n. is described from the West Coast of Scotland, where alone has it yet been obtained.

Cœlenterata.

Protanthea—a new Actinian.‡—Herr O. Carlgren describes a new and simple Actinian—*Protanthea simplex* g. et sp. n.—which he found on Ascidiæ off the Swedish coast at a depth of 20–30 fathoms. The animal is 10 mm. in length, of a salmon colour, with thin smooth walls without warts or cinclides, but with longitudinal furrows corresponding to the insertions of the mesenteries. There are about 100 tentacles, apparently in six groups; the oral disc bears radial furrows; the œsophageal tube is marked by six longitudinal grooves, of which two form the siphonoglyphes. There are 24 mesenteries, 8 reaching the œsophageal tube and resembling those of *Edwardsia*, 12 arranged in six pairs with intraseptal muscles, and 4 so disposed that each pair with one of the complete lateral mesenteries. All bear reproductive organs and mesenteric filaments. Herr Carlgren inclines to place the genus *Protanthea* between Hexactiniæ and Edwardsiæ, but would include it along with *Gonactinia* (if that be indeed an adult form) in a new tribe Protantheæ, which he defines as follows:—Actiniaria with paired mesenteries of which only eight are complete in the *Edwardsia*-stage, with two siphonoglyphes in the œsophageal tube, and with an ectodermic nervous and muscular layer.

Bolocera.§—Herr O. Carlgren has a contribution to our knowledge of *Bolocera*, of which he describes a new species, *B. longicornis*, from the west coast of Sweden. The most interesting point in the structure of the tentacles is the presence of a circular muscle to constrict them off. At the base of the tentacle there is an infolding of mesoderm towards the lumen of the tentacle; if this fold contracts strongly, the lumen is completely shut off from the cœlenteric space. If the tentacle is distended with water and there is a powerful contraction of the circular muscle, the tentacles break off at the point where the fold is formed. Nothing is suggested as to the cause of this self-mutilation.

The mesoderm of the upper part of the mesenterial filaments is

* Nachrichten K. Ges. Wiss. Göttingen, 1890, pp. 168–87.

† Ann. and Mag. Nat. Hist., vii. (1891) pp. 469–79 (2 pls.).

‡ Oefvers. af Förhandl. K. Svensk. Vet.-Akad., 1891, pp. 81–9 (4 figs.).

§ Oefvers. K. Vet. Akad. Förh., 1891, pp. 241–50.

provided with connective-tissue-cells rich in protoplasm; these are very numerous, particularly in the central parts, where they lie close to one another; in the lower part, where there is only one glandular band, the connective cells are less numerous, and the gland-cells are elongated and tubular. Elsewhere the gland-cells are large and ampullæform.

Relation of Septa of Parent to those of Bud in Blastotrochus.*—Dr. G. v. Koch has been able to determine that each of the two septa which lie in the plane that contains both the primary axis and the longest diameter are directly continuous with the two primary septa of the bud.

Cerianthus membranaceus.†—M. L. Faurot points out that the differences in length presented by the first eight mesenteries of *Cerianthus* call to mind the disposition of parts in the *Rugosa*. Although there is a want of bilateral symmetry in the development of the septa, the two sides of the animal always agree in the arrangement of the mesenteries in groups of four.

Antipatharia.‡—Prof. F. Jeffrey Bell gives a description of a very fine example of the "Black Coral" of the Mediterranean, lately added to the exhibition series of the Natural History Museum. It is more than six feet high and six feet wide, and its beauty is due to the closeness of the reticulation of the branches. The base spreads over an area of 350 by 200 mm., and from it spring two great trunks. The specimen was taken by sponge-fishers near Eubœa.

A remarkable Antipathid from Mauritius is also described. As the specimen is dry, it is not possible to say exactly what is its generic position; it is provisionally called *Antipathes*, while the specific name of *Robillardi* marks its discoverer. Several trunks arise abruptly from a small horny base; these soon divide and give rise to a number of greatly elongated stems, many of which are, henceforward, simple. As a result, the appearance of the whole colony is very unlike that of most Antipathids. Where the sclerenchyma is well preserved it has the appearance of being transversely striated, as its dark colour is relieved by narrower and lighter bands; the horny axis has a shagreen-like spinulation, and the spines are blunt and very numerous. There are, altogether, about forty-five stems, the longest of which measure almost exactly one metre. It is to be hoped that spirit specimens with the polyps preserved will enable us to complete our knowledge of this very remarkable form.

Ampullæ of Millepora Murrayi.§—Dr. S. J. Hickson has discovered that the ampullæ of *M. Murrayi* do not contain ova or embryos, but modified dactylozooids bearing very large sperm-sacs only. The ova of *M. Murrayi* are quite small, and similar to those of *M. plicata*. Every fact, as it is discovered, in the anatomy of *Millepora* separates it more and more from the other Hydrocorallinæ.

* Morphol. Jahrb., xvii. (1891) pp. 334-6 (8 figs.).

† Comptes Rendus, cxii. (1891) pp. 443-4.

‡ Trans. Zool. Soc. Lond., xiii. (1891) pp. 87-92 (2 pls.).

§ Rep. Brit. Assoc., 1890 (1891) pp. 863-4.

Male Gonangia of *Distichopora* and *Allopora*.*—Dr. S. J. Hickson finds that the spermatæ caecal diverticula of *Distichopora* are not as long and prominent as those of *Allopora*; they are usually grouped in threes and fours, and lie just beneath the surface, so that, when mature, they are quite visible before decalcification.

Structure and Development of Gonophores.†—Prof. W. K. Brooks and Mr. E. G. Conklin give an account of the structure and development of the gonophores of a certain Siphonophore belonging to the *Auronectæ* of Haeckel. One result of this investigation is to show that the so-called "polyovone gynophores" show no trace of medusoid structure and are merely pouches containing ova; such structures are therefore spoken of as egg-pouches.

The structure of the gonophores is so complicated that the authors find themselves compelled to describe their development in detail; in which course we have not space to follow them. The chief conclusions, however, are:—The egg-pouch must be regarded as a part of the stem, where the growth of the egg-cells may take place while the gonophore is developing. As soon as the gonophore is formed, one of the eggs, already quite large, passes into it and lies between the ectoderm and endoderm of the manubrium. The egg is rapidly nourished by the disintegration of the egg-cells remaining in the egg-pouch, and by the formation of large endoderm folds which have a secretory function. The whole contrivance is such as to secure as rapid a development of the sexual cells as possible, similarly to the cases described by Weismann in many *Hydromedusæ* and *Siphonophores*.

As female gonophores alone were found, it is possible that the male may be very different in form to the female, and it is thought very probable that the male of *Physalia*, if described, has been regarded as a very different genus to the female.

Halistemma in British Waters.‡—The Rev. A. D. Sloan records the first Siphonophore found in St. Andrews Bay. Prof. M'Intosh, in a note to the paper, remarks that Siphonophores are, as a rule, conspicuous by their absence, on the east coast of Britain. *Diphyes*, *Physalia*, and *Verella* are occasionally found in the British seas.

Development of *Cyanea arctica*.§—Prof. J. Playfair M'Murrich has had the opportunity of studying the development of *Cyanea arctica*, which was very abundant last May in Vineyard Sound. Segmentation is practically regular, and a blastula is formed; there is a transient pseudogastrula. A solid planula is formed by the immigration of cells, and this consists of an outer layer of columnar cells and a central mass, in which cell-outlines cannot be made out in sections. After some swimming about, the embryos settle down and inclose themselves in a circular plano-convex cyst. While within this the central mass becomes hollowed out and the endoderm is formed. After several days the embryo emerges from the cyst through an orifice formed apparently by solution.

* Rep. Brit. Assoc., 1890 (1891) p. 864.

† John Hopkins Univ. Circ., x. (1891) pp. 87-9 (1 pl.).

‡ Ann. and Mag. Nat. Hist., vii. (1891) pp. 413-6 (1 pl.).

§ Amer. Nat., xxv. (1891) pp. 287-9.

The mouth soon forms and four tentacles make their appearance; there does not seem to be any stomodæum, for the ectoderm and endoderm come into contact at the margin of the mouth-opening. Vogt has described the similar absence of a stomodæum in a form which he calls *Lipkea ruspoliana*, but which is, probably, simply a *Scyphistoma*. Mesenteries are not formed till eight tentacles have been acquired; this is a result at variance with the statement of Goette.

Physiology of 'Portuguese Man-of-War.'*—Mr. R. P. Bigelow has now published a more detailed account of his observations, a preliminary notice of which appeared last year.† *Caravella maxima* is an animal without any sense of sight, smell, or hearing, and with little or no sense of taste or touch. It has only a trace of co-ordination in its movements, in which there is a certain amount of rhythm, and every part is capable of originating an impulse. The only active part that it can take in its locomotion is to erect its sail when a breeze strikes it, or to heave to in a gale with its tentacles deeply extended into the water. If it rains, the float may be turned over so as to wash off the irritating fresh water.

From a few observations made on specimens still in the warm water of the Gulf Stream, it is clear that in observing specimens taken near shore, some allowance must be made for debility. In the warmer waters the animals usually hold their crests erect; the colours are much deeper and more brilliant than in the Woods Holl specimens, and the poison of the tentacles was very much more virulent; the merest touch of the back of the finger to one of the tentacles produced the most intense pain.

Four different fluids, at least, are secreted by *Caravella*; the surface of the float is covered by a mucous secretion; a very viscid fluid is secreted at the mouths of the siphons, by which they first attach themselves to foreign bodies. The siphons secrete a digestive fluid, as is evident from the effect produced on food substances. The endocells secrete a poisonous fluid which produces a very painful sensation on the human skin, and causes a temporary paralysis in a small animal, and in some cases death. The gas contained in the pneumatocyst is probably also a secretion.

New Family of Hydroida.‡—Prof. W. Baldwin Spencer proposes to establish a new family, that of the Hydroceratinidæ, which he thus defines:—"Hydrophyton consisting of a mass of entwined hydrorhiza, with a skeleton in the form of anastomosing chitinous tubes; the surface is studded with tubular hydrothecæ into which the hydranths can be completely retracted. Hydranths sessile, and connected with more than one hydrorhizal tube, claviform with a single verticil of filiform tentacles. Defensive zooids present, with a solid endodermal axis and nematocysts borne at the distal end."

This new family is established for a remarkable new form which is called *Clathrozoon Wilsoni*, and which was obtained in Bass Straits, close to the Victorian shore, and at a depth of from 20-22 fms. It appears to be very rare. The largest colony measures 10 in. by 4, and at

* John Hopkins Univ. Circ., x. (1891) pp. 90-3.

† See this Journal, 1890, p. 467.

‡ Trans. Roy. Soc. Victoria, 1890, pp. 121-9 (4 pls.).

first sight looks like a dark-coloured fan-shaped Gorgonid. In general appearance it is not unlike *Dehitella* and *Ceratella*, but these have the skeleton in the form of a horny network.

As the reproductive apparatus is as yet unknown, there is very considerable difficulty in speaking as to the affinities of the form; the gastrozooids call to mind *Clava*, the dactylozooids the Plumulariidae, and the relationship of the gastrozooids to the cœnosarcal tubes the Hydrocorallinae. The skeleton, though somewhat resembling that of the Hydractiniidae and Ceratellidae, differs by the presence of hydrothecæ and the possession of a thin layer of external perisarc, with projecting cylindrical tubes. The first of these differ in various points from those of any other Hydroid, and the second does not appear to be present in any other known form, and it is difficult to conceive how it arose.

Trembley's Experiments with Hydra.*—Dr. M. Nussbaum has repeated his observations on the behaviour of *Hydra* when turned inside out. He corroborates his previous conclusion that a *Hydra* thus treated and bored by a needle, recovers its normal arrangement of ectoderm and endoderm by a process of overgrowth and turning outside in, which may take effect at various places, and is associated with complex absorptive and formative changes. Some new details are added; thus, it is noted that a *Hydra* turned inside out may live in this state, at the expense of its own substance, for six days. Much of the paper has to do with an unfortunate discussion which has arisen in regard to the contributions which Nussbaum and Ischikawa have made to the solution of the problem of the restitution of an evaginated *Hydra*.

Protozoa.

Intracellular Digestion in Protozoa.†—M. Le Dantec has made experiments on intracellular digestion, following the same line as Metschnikoff, who showed that the chemical reaction of the contents of the vacuoles is acid, while that of the protoplasm is alkaline. The author used *Stentor polymorphus* and other Ciliata, and tested the vacuolar reaction with litmus grains. The secretion of the acid varied as to rapidity with the species examined, but in all cases appeared to be the same in kind.

Better results appear to have been obtained by using a sulphur compound of alizarin (alizarine sulfoconjugée). This is a brown pigment soluble in water (1-500) which when acted upon by alkalis becomes violet and yellow by acids. The transition stage being pink, the slightest alteration in the reaction is instantly recognizable.

With this pigment two kinds of amœbæ were experimented on. A few minutes after the inception of the pigment-granules an acid reaction was observable within the vacuoles, for the contents, originally violet, changed to pink and sometimes to yellow. The pigment-granules were afterwards frequently eliminated, retaining the colour they had acquired while within the vacuole.

He finds that ‡ in all cases the solid particles taken in were accom-

* Arch. f. Mikr. Anat., xxxvii. (1891) pp. 513-68 (5 pls. and 1 fig.).

† Annales de l'Institut Pasteur, 1890, pp. 776. See Centralbl. f. Bakteriol. u. Parasitenk., ix. (1891) pp. 355-6.

‡ Ann. Inst. Pasteur, 1891, p. 163. See Centralbl. f. Bakteriol. u. Parasitenk., ix. (1891) p. 736.

panied by a certain quantity of the surrounding water. Those that form currents around their mouth ("Infusoires à tourbillon") only seem to stop taking in particles when a kind of plethora appears to mechanically stop the formation of fresh vacuoles. Those that seize their food ("Infusoires capteurs") appear to make a selection; non-nutrient substances are only taken when they are attached to those which are really nutritious. In all cases studied the digestive vacuole was the seat of an acid secretion which first neutralizes the alkaline water and then makes the contents of the vacuole acid. This secretion goes on with the same intensity whether the contents of the vacuoles are animal, vegetable, or mineral. This acid appears to be strong, but the rapidity with which it is secreted varies greatly in different species; and there is, also, a difference in the toxicity of chemical substances introduced into their bodies, which points to a considerable amount of difference in the constitution of the protoplasm.

Conjugation in *Noctiluca*.*—Dr. C. Ischikawa points out that in the conjugation of *Noctiluca miliaris* the two nuclei of the copulating cells do not fuse but remain lying against one another till the mass divides again; division of the nuclei then takes place in such a way that half of each nucleus passes into each of the two resulting pieces.

When conjugating, a connecting bridge is formed between two individuals, and the two protoplasmic masses become one. Fusion goes on till a single body is formed. After repose the author often noticed rounded protoplasmic spheres, which stained intensely with methyl-green, close to the poles of the axis in which the two cells touched. These bodies may be centrosomata. The binucleated individual differs in no other particular from a form with a single nucleus; it possesses a new mouth, tentacle and flagellum, and for two days it may show no inclination to divide; others divide directly after copulation.

Sporulation does not occur until after division, and not then always in the same way exactly. In budding the nucleus becomes more obscure, but does not disappear, and the whole of the nucleus gradually passes into the buds, so that at the end of the process no protoplasm or nuclear substance remains over.

Pathogenic Protozoa.†—Dr. L. Pfeiffer, in discussing the pathogenic protozoa in relation to our present knowledge of contagious and miasmatic diseases, seems inclined to award them a prominent position among the causes of infectious disorders, and this chiefly on account of the mobile swarming stage in juvenile conditions of Coccidia. This mobile period of the larval stage, described by Dr. R. Pfeiffer in 1890, the author is disposed to regard as having a peculiar significance, and as capable of explaining the malignancy of certain diseases. The actual number of facts at our disposal is, however, small, and many even of those are disputed; it is well, however, to have attention called to a few positive data pointing in a certain direction, as well as to the inability of bacteriology to explain numerous disorders.

* Zool. Anzeig., xiv. (1891) pp. 12-14 (4 figs.).

† Centrabl. f. Bakteriöl. u. Parasitenk., viii. (1890) pp. 761 and 794.



BOTANY.

A. GENERAL, including the Anatomy and Physiology of the Phanerogamia.

a. Anatomy.

Anatomy of Plants.*—In connection with a plan for forming collections, at the People's Palace at Brussels, for the popular elucidation of the different branches of Natural Science, M. A. Gravis has published a useful summary of the general facts connected with the anatomy of plants, with regard both to the structure of tissues and to their arrangement in the different organs.

Wiesner's Anatomy and Organography.†—In the most recently published part of the new edition of Prof. J. Wiesner's 'Anatomy and Physiology of Plants' he describes the newest researches on starch, chromatophores, plastids, cell-division, structure of the leaf and stem, absorption of fluid nutriment, movements of gases, influence of external forces on growth, movements connected with growth, &c. The sections on cell-division and secretion are new. The difficult questions relating to the anatomical changes during the growth of the stem, the connection between the anatomical structure and the physiological function of the stem and of the root are treated with great detail and clearness. In the volume on Organography and Classification a large portion is devoted to the sources of medicinal drugs.

(1) Cell-structure and Protoplasm.

Hygroscopic Swelling and Shrinking of Vegetable Membranes.‡—Herr C. Steinbrinck treats this subject from a mathematical and from an empirical point of view, and offers an explanation of various phenomena connected with swelling, especially of those which have to do with torsions. He discusses also the various hypotheses on the constitution of the vegetable cell-wall, and gives his adhesion to Nägeli's micellar theory.

(2) Other Cell-contents (including Secretions).

Distribution of Starch at different periods of the year in woody plants.§—From a series of experiments made, especially on different species of Conifers, M. E. Mer finds the amount of starch in the leaves to be subject to a law of periodicity, and contests the ordinary view that the reserve-tissues of woody plants contain a large supply of starch throughout the winter. On the contrary, while, about the middle of October, the cortex, the phloem, and the xylem are, in general, filled with starch in all the organs, a month later it has almost entirely disappeared from the cortex and the phloem; and in another month this disappearance has advanced still further. The medullary rays are first

* CR. Soc. Roy. Bot. Belgique, xxx. (1891) pp. 8-23.

† 'Elemente d. Wiss. Bot. I. Anat. u. Phys. d. Pflanzen, 3. Aufl. (158 figs.). II. Organ. u. Syst. d. Pflanzen, 2. Aufl. (270 figs.)' Wien, 1890 and 1891. See Bot. Centralbl., xlv. (1891) p. 213.

‡ 'Zur Theorie d. hygroskopischen Flächenquellung u. -schrumpfung veg. Membranen,' Bonn, 1891, 128 pp. and 3 pls. See Bot. Centralbl., xlvi. (1891) p. 107.

§ Comptes Rendus, cxii. (1891) pp. 248-51, 964-6.

emptied of their starch, then the woody parenchyme, then the cells of the pith. In this state the wood remains stationary till the middle of March. About this time starch-grains begin to reappear in the green cortex of the branches, then in the phloem, spreading gradually to the xylem. The absorption of the starch in winter is, no doubt, due to respiratory combustion; and the winter is, in fact, the period of the year when there is the smallest quantity of starch in woody plants. The period of the greatest activity in the formation of starch is immediately after the close of the winter-rest, before the development of the buds and the activity of the cambium. After that, even under favourable conditions of a clear sky and high temperature, the amount of starch decreases, owing to its absorption in the formation of tissues and to respiration. In cloudy and rainy weather the decrease is still greater, especially in the parenchyme of the upper surface of the leaf.

Structure of Starch-grains in Maize.*—By boiling pieces of maize-grain in chloroform with a few drops of concentrated chromic acid, Dr. L. Buscalioni was able to produce a swelling in the starch-grains which showed a peculiarity in their structure. Some of the grains presented very numerous straight radial striæ, which, proceeding from the centre towards the periphery, were grouped in two systems crossing one another at an acute angle, so as to break up the surface into a number of minute regular rhomboid figures. At a later stage of swelling the striæ were resolved into punctations.

Spectrum of Chlorophyll.†—Mr. W. N. Hartley gives the result of fresh observations on the spectra of blue and yellow chlorophyll. The best solvents for leaf-green he finds to be chloroform and alcohol, but the former should be distilled off at once, otherwise a change takes place in the solution. Leaves of *Anacharis* were chiefly used where the quantity of foreign substances is comparatively small. In contrast to previous statements, Mr. Hartley asserts that yellow chlorophyll has a feeble but distinct absorption-band in the red, and a distinct fluorescence. It has also an absorption-band in the orange-red, and exhibits a very powerful absorption of all rays beyond the *b* group.

The leading characteristics of unaltered leaf-green are those of blue chlorophyll, viz. an intense absorption in the red, somewhat stronger even than in the violet and ultra-violet.

The author believes that the molecule of chlorophyll, or one of its transformation products, is actually capable of reducing carbon dioxide; and he supports the view that the first product of this reduction is probably formic aldehyde.

Aspergillin—a Vegetable Hæmatin.‡—M. G. Linossier gives an account of the pigment of the spores of *Aspergillus niger*, from which it seems that there is here a substance completely analogous with the hæmatin of blood. There is a resemblance in physical characters; both contain a distinct quantity of the same metal, iron; and both are capable of forming, under the action of a reducing agent, but not *in vacuo* or by

* Nuov. Giorn. Bot. Ital., xxiii. (1891) pp. 45-7.

† Journ. Chem. Soc., 1891, pp. 106-24.

‡ Comptes Rendus, cxii. (1891) pp. 489-91.

putrefaction, a reduction product which is oxidizable in contact with air, and thus reproduces the primitive substance.

It is probable that this similarity in properties is correlated with a similarity of function—in both it is respiratory.

In a subsequent communication * M. Linossier contests the assertion of Phipson † that aspergillin is identical with the palmellin obtained by him from *Palmella cruenta*.

(3) Structure of Tissues.

Variations in the Anatomical Structure of the same Species. ‡—Herr P. Schumann has undertaken a long series of experiments on a very large number of species, for the purpose of determining to what extent anatomical differences occur in different individuals of the same species grown in the same situations and under similar conditions, and especially whether the larger simply represent a magnified image of the smaller examples. The latter question is answered in the negative.

The difference between a large and a small specimen consists generally, in Monocotyledons, in an increase of the fundamental tissue; in Dicotyledons in an increase of the pith, the other tissues remaining nearly constant in dimensions. In *Hyoscyamus niger* and *Datura Stramonium* there is also an increase of the parenchyme between the primary vessels; and in *Carum Carui* the appearance of medullary bundles. Any considerable increase in the cortical system or the vascular-bundle system was observed only in a small number of examples. It may then be of three kinds:—(1) Increase in size and number of the separate bundles; (2) Formation of a continuous secondary ring of tissue; (3) Widening of a secondary ring, which occurs also in the smaller examples. The increase in the size of the root in larger specimens is almost invariably due to an increase of the woody cylinder, very rarely to that of the cortical tissue.

Wood of Conifers. §—Herr P. Schuppan has subjected to a critical examination the wood of various Coniferæ, especially that of *Pinus Laricio*, *P. sylvestris*, and *Picea excelsa*, with reference to the number of rows of bordered pits, the width of the annual ring, the distribution of the resin-passages, &c. He finds that the diameter of the cylinder of pith increases regularly from below upwards in comparison to the diameter of the stem. The width of the annual rings in the stem increases from below upwards, attains a maximum, and then again decreases. The distribution of the resin-passages is the same in the root as in the stem; near the apex of the stem and of the root, the number of resin-passages in a unity of surface attains a maximum and then again decreases.

Abnormal Structure of Annual Rings. ||—Herr L. Kny describes several instances in which, in contrast to what is usually the case, the elements of the autumn wood have distinctly thinner walls than those of

* Comptes Rendus, cxii. (1891), pp. 807-8.

† T. c., p. 666.

‡ Bot. Centralbl., xlv. (1891) pp. 357-62, 391-4; xlvi. (1891) pp. 1-6, 65-81, 145-9, 177-83, 209-15, 242-50, 305-11, 337-43, 369-73, 401-5 (2 pls.).

§ 'Beitr. z. Kenntniss d. Holzkörpers d. Coniferen,' Halle, 1889, 53 pp. See Bot. Centralbl., xlvi. (1891) p. 120.

|| SB. Gesell. Naturf. Freunde Berlin, 1890. See Bot. Centralbl., xlv. (1891) p. 183.

the preceding and succeeding spring wood. The libriform fibres of the spring wood showed, in some cases, five times greater thickness than those of the autumn wood; even the vessels of the spring wood had thicker walls than those of the autumn wood. This was especially the case in *Salix fragilis* and *cinerea* and *Pterocarya fraxinifolia*.

"Sanio's Bands" in the Coniferæ.*—By this term (*Sanioische Balken*) Herr C. Müller proposes to designate the beams or thickenings commonly found in the xylem-elements, chiefly in the tracheids of Coniferæ. In the twenty-eight species examined, he found no exception to their occurrence, but they are most frequent in *Araucaria brasiliensis* and *Salisburia adiantifolia*. They occur in all the axial organs, in the stem, root, and branches, in both the older and younger parts, and not only in the xylem, but also in the phloem and cambium; they are most abundant in the tracheids and in the sieve-tubes. They extend radially through the elements in which they occur, either singly, or more often in a large number of successive elements in the same radial row. Wherever a series of bands occurs in the xylem, a corresponding series is to be found in the phloem. They are probably formed by an infolding of the radial walls of the cambium cells. They exhibit the same microchemical reactions as the walls themselves; in the xylem they are also lignified. Their physiological significance is at present uncertain.

Suberin and Bark-cells.†—M. Gibson has found, in the cork of *Quercus suber*, besides Kügler's phellonic acid, two other acids, which he calls suberinic acid and phloënic acid. The mode of separation of the three acids is described in detail. For phellonic acid Gibson gives the formula $C_{22}H_{43}O_3$; it is insoluble in water, soluble in alcohol, ether, and boiling chloroform. Suberinic acid has the composition $C_{17}H_{30}O_3$; it is insoluble in water, readily soluble in alcohol, ether and chloroform, insoluble in petroleum-ether. Phloënic acid, $C_{11}H_{21}O_4$, is insoluble in cold, slightly soluble in hot water, soluble in alcohol, very slightly soluble in ether and chloroform.

The author finds the so-called suberin-lamella of cork membranes to contain either no cellulose, or only a very small quantity. He believes it to consist of a mixture of compound ethers or products of the condensation or polymerization of the various acids.

Reactions of Lignin.‡—According to Herr T. Seliwanow, the characteristic reactions of lignin are due to the lignified membrane itself, and not to the vanillin. In lime-wood the presence of vanillin is very doubtful. Pine-wood he regards, from its chemical reactions, as a compound of cellulose and a gum having the nature of an ether.

Hypertrophy of Lenticels.§—M. H. Devaux states that the tuber of the potato normally possesses numerous lenticels; these lenticels are open and admit of free access of air to the internal tissues. If, however,

* Ber. Deutsch. Bot. Gesell., viii. (1891) pp. 17-46 (1 pl.).

† La Cellule, vi. (1890) pp. 63-14. See Bot. Centralbl., xlv. (1891) p. 111.

‡ Arb. S. Petersburg. Natur.-Ver. (Bot.), xx. (1889) (Russian). See Bot. Centralbl., xlv. (1891) p. 279.

§ Bull. Soc. Bot. France, xxxviii. (1891) pp. 48-50.

the tuber be partially plunged in water, a considerable development of the lenticels takes place, and they become hypertrophied.

Development of the Root.*—M. P. Lesage makes some observations on the root of a *Phaseolus* which he grew in a humid atmosphere. In a root of the second order which was much longer than the primary root, the following striking differences were noticed.

The portion outside the water was covered with numerous root-hairs; near the water these hairs elongated, while in the water they were much shorter, and finally disappeared altogether. In a transverse section it was seen that the cortical layers in the air contained smaller elements than those in the water, and in the central cylinder the xylem was proportionately more lignified in the aerial portion. The root of the bean was made the subject of similar observations. It was found that when the numerous secondary roots were suppressed, the primary root was covered with numerous absorbing hairs.

Differentiation of the Phloem in the Root.†—While studying the anatomy of the roots of *Allium Cepa*, M. P. Lesage was struck with the early differentiation of the phloem. This was also found to be the case in the roots of *Anthurium Andreanum* and *Odontoglossum citrosinum*, and the progress of the differentiation of the phloem was especially well marked in *Athyrium Filix-femina*. The author concludes by giving a list of plants in the roots of which the cells of the phloem are differentiated before those of the xylem.

Medullary Phloem in the Root.‡—M. J. Hérail calls attention to the fact that certain plants belonging to the Gamopetalæ possess phloem on the inside of their conducting bundles, and that these bundles are known as bicollateral bundles. The author proposes to give to this inner phloem the name of medullary phloem. M. van Tieghem, in one of his papers, describes this formation in the adventitious roots of *Cucurbita maxima*. It is also present in the roots of *Vinca major* and *V. media*, but seems to be absent in *V. minor*.

Anatomical Researches on Carex.§—M. Bordet has paid special attention to the anatomical structure of the genus *Carex*, and the following is a résumé of the author's conclusions:—(1) The genus can be divided into four groups by means of the structure of the rhizome; the two first being characterized by the presence of xylem-vessels which are either collateral or concentric; the two others by a cortex formed of cells with small intercellular spaces, or by aeriferous canals formed by the separation of cells. (2) The stem furnishes no characters applicable for purposes of classification. (3) Considerable variation is to be found in the leaves of the different species of *Carex*.

Structure of Apocynaceæ.||—Herr M. Leonhard has examined the anatomical structure of a considerable number of species belonging to this order, and gives the following as the more important results:—

In the species specially examined in this respect (*Vinca major*

* Comptes Rendus, cxii. (1891) pp. 109-10.

† T. c., pp. 444-6.

‡ T. c., pp. 823-5.

§ Rev. Gén. de Bot. (Bonnier), iii (1891) pp. 57-69 (3 figs).

|| Bot. Centralbl., xlv. (1891) pp. 1-6, 33-40, 65-70, 97-104, 129-34 (2 pls.).

and *minor*, and *Nerium Oleander*), a broad annular zone of tissue is separated from the apical meristem immediately beneath the growing point, which furnishes an initial tissue for the primary vessels, the primary phloem groups, and the fibre-cells, and brings about a sharp separation between the pith and cortex. Intraxylary phloem was found in all the species, with scarcely an exception. Sclerenchymatous cells are a very common phenomenon in the pith. At the base of the leaves there are often very interesting emergences, as in the case of the oleander. The laticiferous vessels were wanting in only a single species (*Arduinia bispinosa*). The climbing species of the order may be arranged under three types, differing in the structure of the wood, of which illustrations are afforded by *Strophanthus scandens*, *Echites speciosa*, and *Lyonsia straminea*.

(4) Structure of Organs.

Influence of External Factors on the Formation and Form of Organs.*—Dr. F. Noll shows that external influences determine not only the direction of some organs, but also the position in which they are formed; as, for example, the development of gemmæ on *Marchantia*, of aerial roots on climbing plants, &c. In other and more numerous cases the formation of fresh organs appears to be independent of external forces, and to be determined only by internal forces in the plant, as, for instance, in the dorsiventral structure of many parts of plants. In *Bryopsis* the reversal of the plant brings about a corresponding internal organic transformation.

Epiphyllous Inflorescences.†—M. C. De Candolle has studied the morphology of epiphyllous inflorescences in *Helwingia japonica* (Araliaceæ), *Phyllonoma laticuspis* (Saxifragaceæ), and in some Chaillotiaceæ, Celastrineæ, and Begoniaceæ. His conclusion is that, in most cases, the normal position of the stipules, and the anatomical structure of the leaf, show that the epiphyllous inflorescence is a product of the leaf and not an axillary bud carried up by a subsequent growth of the axis. He regards the leaf and inflorescence together as constituting a single phyllome homologous to an ordinary leaf; and the occurrence of sterile and fertile leaves on the same branch as an example of heterophylly.

Variations in the Flower.‡—Dr. D. Levi Morenos states that out of 164 flowers of *Gentiana Amarella* gathered by him in Venetia, no fewer than forty-nine exhibited variations from the normal type, in the number and degree of development of the divisions of the calyx, in the relative position of the stamens, the relative length of the filaments, and other points.

Formation of Flower-buds of Spring-blossoming Plants.§—Mr. A. F. Foerste has investigated the history of the formation of the flower-bud in twenty-eight species of American plants which flower in the early spring, and finds that, in all cases, the flower has attained a considerable degree of development by the preceding August or September. All the

* SB. Naturhist. Ver. Preuss. Rheinlande, xlvii. (1890) pp. 109-10.

† Mém. Soc. Phys. et Hist. Nat. Genève, 1890, 37 pp. and 2 pls. See CR. Soc. Roy. Bot. Belgique, 1891, p. 29.

‡ Nuov. Giorn. Bot. Ital., xxiii. (1891) pp. 196-200.

§ Bull. Torrey Bot. Club, xviii. (1891) pp. 101-6 (1 fig.).

elements of the future blossom can, in many of them, be readily recognized at that time. In some cases the buds are formed underground.

Inferior Ovaries.*—M. P. Duchartre bases most of his remarks on this subject on the ovary of the Pomifereæ. The structure of the cupular ovary can be demonstrated by the organogeny, the anatomy, and by certain teratological facts connected with that organ. The organogeny of *Pyrus malus* and *P. communis* has been carefully described, the five carpels being first seen as five projections on the internal curvature of the floral axis. The author concludes by stating that the view of Naudin and Decaisne appears to be the correct one, that of a carpellary ovary inclosed in a receptacular cupule and adhering to it.

Influence of Moisture on Dehiscent Fruits.†—Prof. B. D. Halsted and Mr. D. G. Fairchild describe the mode of dehiscence of the capsule or other form of fruit of a number of American plants, the dispersion of the seeds being greatly assisted by the hygroscopic properties of the pericarp, or of some organ attached to the fruit, as the awn in the case of some grasses, or the pappus of Compositæ.

Geocarpous, Amphicarpous, and Heterocarpous Fruits.‡—Herr E. Huth enumerates the various geocarpous and amphicarpous, as well as the "rhizocarpous" species of plants, understanding by the last term those woody plants which, in addition to the normal aerial, produce underground flowers and fruits, such as *Cynometra cauliflora*, *Theobroma Cacao*, and *Anona rhizantha*. He also gives a list of species, belonging to a great variety of natural orders, which produce two different kinds of fruit.

Porosity of the Fruit of Cucurbitaceæ.§—M. H. Devaux gives the details of some experiments on the fruits of *Cucurbita maxima* and *C. melanosperma*. The following are the principal conclusions:—(1) The internal atmosphere of the fruit of Cucurbitaceæ communicates with the external air by means of stomates and lenticels. (2) The proportion of oxygen present in the internal atmosphere is nearly the same as that in the air; the amount of carbon dioxide was, however, found to be less in the formula case, in the analyses performed by the author.

Development of the Integument of the Seed.||—M. M. Brandza has made a detailed examination of the different modes of development of the integument of the mature seed from that of the ovule. These may be classified under two heads,—those in which the ovule has a single, and those in which it has a double integument. Under the latter head three different cases present themselves:—(1) The seed has only a single envelope, proceeding from the outer integument of the ovule, or, at least, from a part of it; (2) the two envelopes of the ovule develop into the two envelopes of the seed; (3) the nucellus enters into the composition of the inner integument of the seed. The first of these cases occurs only in the Ranunculaceæ, the Papilionaceæ, the

* Bull. Soc. Bot. France, xxxviii. (1891) pp. 28-38.

† Bull. Torrey Bot. Club, xviii. (1891) pp. 81-4 (1 pl.).

‡ Samml. Naturw. Vorträge, x. (1890) 32 pp. See Bot. Centralbl., xlv. (1891) p. 381.

§ Rev. Gén. de Bot. (Bonnier), iii. (1891) pp. 49-56 (1 fig.).

|| Rev. Gén. de Bot. (Bonnier), iii. (1891) pp. 1-32, 71-84, 105-26, 150-65, 229-40 (10 pls.).

Amaryllideæ, and a large portion of the Liliaceæ; the second, though regarded as exceptional, is found in certain genera belonging to a large number of different natural orders; the third, in genera of Lythraceæ, Enothereæ, Magnoliaceæ, and Aristolochiaceæ. In the greater part of the Gamopetalæ and Apetalæ, as well as in some Apopetalæ, the ovules are provided with only a single integument, and the envelopes of the seed are either developed from this integument alone, or the nucellus partakes in its formation. The latter case occurs in species belonging to the Linaceæ, Rhamnaceæ, and Compositæ. In most cases the inner layers of the integument of the ovule disappear in the course of development of the seed.

In opposition, therefore, to the view usually entertained, the author asserts that in those plants in which the ovule has a double integument, the inner envelope does not, as a rule, disappear in the course of development of the seed, but persists, and often constitutes the lignified portion of the seminal integument. The nucellus itself sometimes contributes to the formation of the mature envelope; and it is only in a few families that this is formed entirely from the outer integument of the ovule. In those plants in which the ovule has only a single envelope the lignified portion of the seminal integument has its origin, in some cases, in the epiderm of the nucellus.

Integuments of the Seed of Cruciferæ.*—M. J. d'Arbaumont has arrived at the following conclusions respecting the seminal integuments of the Geraniaceæ, Lythraceæ, and Enothereæ:—(1) The two integuments of the ovule frequently remain in the ripe seed. (2) The nucellus frequently contributes to the formation of the seminal integuments. (3) The endosperm itself even takes part in this formation. The object of the present paper is to show that this last often takes place also in the Cruciferæ, and especially in *Brassica nigra* and *Sinapis alba*. A layer formed from the endosperm is also present in *Iberis pinnata*, *Conringia perfoliata*, *Biscutella ambigua*, *Cochlearia officinalis*, &c.; sometimes this layer is reduced to a thin lamellated pellicle, as in *Capsella bursa-pastoris*, *Camelina sylvestris*, *Thlaspi perfoliatum*, *Hesperis matronalis*, &c.

Stem of Zostera.†—M. C. Sauvageau has studied the structure of the stem in the five species of *Zostera*—*Z. marina*, *Capricorni*, *nana*, *Muelleri*, and *tasmanica*, *Z. marina* being taken as the type. The cortical parenchyme is composed of a close external and an internal zone containing lacunæ; in the internal zone are fibrous strands, which are either in contact with the epiderm, or are separate, and, in one of the species (*Z. Muelleri*), surround the central cylinder. There are always cortical foliar bundles, either one on each side (*Z. marina*, *Capricorni*, and *nana*), or two to five (*Z. Muelleri* and *tasmanica*). The central cylinder is always surrounded by an endoderm, the phloem-bundles are more frequently isolated and distinct, while the xylem-bundles are united. A knowledge of the structure of the stem greatly facilitates specific determination.

* Bull. Soc. Bot. France, xxxvii. (1890) pp. 251-7. Cf. this Journal, 1890, p. 737.

† Journ. de Bot. (Morot), v. (1891) pp. 33-45, 59-68 (9 figs.). Cf. this Journal, 1890, p. 741.

For instance, *Z. nana* and *Muelleri* are more easily distinguished the one from the other by the structure of their stem than by their leaves. Inversely, however, *Z. nana* and *Capricorni* show more difference in the structure of their leaves than in that of their stem.

Spiral Phyllotaxis.*—Herr B. Rosenplenter points out that in the germination of dicotyledonous seedlings there must be either a single primary leaf or a primary pair. In the first case there is only one plane of symmetry, which bisects the angle of the median planes of the cotyledons. In the second case there are either two planes of symmetry, or only one which corresponds with the common median plane of the cotyledons. The various special modifications of these cases are described in detail.

Leaf-spirals in the Coniferæ.†—Herr A. Weisse treats from a mathematical point of view the turning of the leaf-spiral and the nature of the pressure which causes it in the axillary buds of Coniferæ. In the axillary buds of by far the greater number of Coniferæ with spiral phyllotaxis, the third leaf faces the stem. The lateral deviations depend upon three causes—a lateral displacement caused by the supporting leaf, a lateral insertion of the supporting leaf, and the pressure of the bases of the adjacent leaves of the mother-shoot which stand above the supporting leaf.

Influence of Light on the production of Spines.‡—M. A. Lothelier, in a former paper, made some observations on the influence of the hygrometric state of the air on the production of spines, and in the present paper studies the influence of light in the same relationship. Various examples are taken, for instance:—*Berberis vulgaris*, *Robinia pseudacacia*, *Ulex europæus*, *Cratægus oxyacantha*, and *Ribes uva-crispa*, the general conclusion being that stronger light causes the formation of more numerous, better-developed, and more differentiated spines.

Bulbs and Tubers in the Juncaceæ.§—Herr F. Buchenau describes the formation of tubers and bulbs in various species of *Juncus* and *Luzula*. They are produced either by the larvæ of animals or by fungi. In the latter case the parasite is a species of *Schinzia* or *Entorrhiza*, *S. Casparyana* or *digitata*.

Growth of Root-hairs.||—M. H. Devaux has already shown that light is favourable to the development of root-hairs. Observations on the root of *Lolium perenne* were made, and it was found that the minimum growth took place between midday and two o'clock. The maximum growth of the rootlets, however, took place in the region of the root formed during the day, and the minimum in that formed during the night. A certain equilibrium is thus maintained between the growth of the root-hairs and that of the root itself.

* 'Ueb. d. Zustandekommen spiraliger Blattstellungen b. dikotylen Keimpflanzen,' Berlin, 1890, 43 pp. and 1 pl. See Bot. Centralbl., xlv. (1891) p. 346.

† Flora, lxxiv. (1891) pp. 58-70 (1 pl.).

‡ Comptes Rendus, cxii. (1891) pp. 110-2. Cf. this Journal, ante, p. 214.

§ Flora, lxxiv. (1891) pp. 71-83 (2 figs.).

|| Bull. Soc. Bot. France, xxxviii. (1891) pp. 51-2. Cf. this Journal, 1888, p. 995.

Anatomy of the Malvaceæ.*—Herr G. Kuntze finds the following characters common to all species of Malvaceæ examined:—Small, usually brown capitate hairs; strong bast-bundles in the cortex; and especially mucilage in the cortex and pith, as well as in the epiderm of the upper surface of the leaves. The leaves are bilateral, and have palisade-cells on their upper surface only; crystals, both solitary and in clusters, are common, but never raphides. The hairs are very commonly stellate, and occasionally chambered. Mucilage occurs in all organs, and results from the disintegration of the cell-walls. The Bombaceæ differ in so many respects from the typical Malvaceæ that they ought, perhaps, to be regarded as a distinct order. They rarely possess stellate or tufted hairs; and the wood is in general less lignified, and contains larger vessels; mucilage-passages occur almost invariably on the under side of the larger veins. The author was unable to lay down any anatomical character for the separation of the genera.

β. Physiology.

(1) Reproduction and Germination.

Results of continual Non-sexual Propagation.†—Prof. M. Moebius discusses this subject in detail as regards flowering plants, and decides against the Darwinian hypothesis that continual propagation by non-sexual method must result in deterioration and ultimate extinction. He agrees with Schleiden in dissenting from the popular theory that the offspring of such modes of propagation must be regarded as constituting but a single individual. In support of these views he refers to the length of time—extending in some cases to thousands of years—during which some plants have been continuously propagated by non-sexual methods without apparent deterioration or increased liability to disease—e. g. *Elodea canadensis*, the fig, the date-palm, the banana, the yam, the batatas, the olive, and many others. On the other hand, the weeping-willow and the Lombardy poplar do appear to have been threatened with extinction, owing to their abnormal liability to disease. But degeneration as the result of age cannot be affirmed as a general law in such cases.

Cross-fertilization and Self-fertilization.‡—Mr. E. G. Hill describes in detail the mode of pollination in three American plants:—In *Campanula aparinoides* the structure favours the occurrence of self-pollination when there is a lack of insect visitors. In *Sabbatia angularis* (Gentianaceæ) there is a very interesting mechanism to secure cross-pollination by the agency of insects. *Eleocharis mutata* (Cyperaceæ) is protogynous and anemophilous.

Autogenetic and Heterogenetic Fertilization.§—Prof. Körnicke proposes these terms for the self-pollination and cross-pollination of plants; and adduces instances in which the former phenomenon is to all appearance constant and continuous, with abundant fertility, the flowers being in some cases open, in others cleistogamous.

* Bot. Centralbl., xlv. (1891) pp. 161-8, 197-202, 229-34, 261-8, 293-9, 325-9 (1 pl.). † Biol. Centralbl., xl. (1891) pp. 129-60.

‡ Bull. Torrey Bot. Club, xviii. (1891) pp. 111-8.

§ Verhandl. Naturhist. Ver. Preuss. Rheinland., xlvi. (1890) Korr.-bl., pp. 84-99.

Proterandry in the Umbelliferae.*—Herr A. Beketow states that in those genera of Umbelliferae where the normal proterandry is most strongly developed, such as *Anthriscus* and *Carum*, the earliest central umbel has reached the female stage, while the later lateral umbels are still in the male stage; and that the lower position of the central umbel insures its pollination from the lateral ones. Where proterandry is not so strongly developed, the central umbel often stands at a higher level than the lateral ones.

Reproduction of Hydromystria.†—Sig. A. Bottini describes the structure of the male and female flowers of *Hydromystria stolonifera* (Hydrocharideae), and the mode of the pollination, which seems to be altogether anemophilous. After impregnation the stalk of the female flower lengthens and then bends downwards, and the fruit is matured under water, very much as in *Vallisneria*.

Duration of the Life of certain Seeds.‡—M. H. de Vries states that most seeds, if kept in a dry state, lose their power of germination in a few years. A certain number of seeds were taken and kept seventeen years, and it was found that only two out of the number possessed the power of germination, viz. those of *Erodium cicutum* and *Nicandra physaloides*. In the first case only a single plant was raised. An experiment showing the rapidity of germination in *Oenothera Lamarckiana* is then described. Seeds were sown on the 14th of March, 1887, and between March and April 908 of these germinated; between April and May, 288; between May and June, 27; between June and July, 37; between July and September, 130; between September and October, 6.

Germination of the Sugar-cane.§—Mr. D. Morris describes the production of fertile seeds in the sugar-cane, which has very rarely been observed. All the spikelets observed were one-flowered, and the flower hermaphrodite. In germination the plumule and radicle emerge without the cotyledon.

Germination of Hydrastis Canadensis.||—Mr. H. Bowers describes a singular phenomenon in the germination of this plant—one of the Ranunculaceae. The complete germination extends over two, or even over three years. At the end of the first summer the seedling consists of the two foliaceous cotyledons, with a thick tapering radicle and a very small plumule. The rhizome and flowering stem develop only in the second or third year.

(2) Nutrition and Growth (including Movements of Fluids).

Biology of Parasites.¶—M. A. Chatin contests the prevalent view that leafless parasites can only make use of nutritive substances already elaborated by their hosts. The statements that the mistletoe of the oak contains tannin absorbed directly from the oak, and that the *Loranthus* parasitic on *Strychnos nux-vomica* contains strychnine, are founded on

* Arb. St. Petersburg. Naturf.-Ver. (Bot.), xx., pp. 11 *et seq.* (Russian). See Bot. Centralbl., xlv. (1891) p. 381.

† Malpighia, iv. (1891) pp. 340-9, 369-77.

‡ Arch. Néerland., xxiv. (1891) pp. 271-7.

§ Journ. Linn. Soc. (Bot.), xxviii. (1890) pp. 197-201 (1 pl.). Cf. this Journal, ante, p. 218.

|| Bot. Gazette, xvi. (1891) pp. 73-82 (1 pl.).

¶ Comptes Rendus, cxii. (1891) pp. 599-604; and Bull. Soc. Bot. France, xxxviii. (1891) pp. 124-8.

erroneous observations. Even leafless parasites (*Balanophora*, *Cytinus*, *Hydnora*, *Cuscuta*, *Orobanché*, &c.) contain abundance of starch in their parenchyme, which must have been formed in the tissues of the parasite. The carbon dioxide is formed in such plants, as in animals, by the consumption of their own carbon, this carbon being derived from the sap of the host-plant. But certain secondary products, such as the colouring matter of the flowers of *Cuscuta* and of some species of *Orobanché*, must be formed afresh in the tissues of the parasite. Many leafless parasites possess stomates and well-developed spiral vessels.

Assimilation of Leaves.*—Herr H. Vöchting describes an apparatus designed to determine the question whether the growth of each leaf is due to the energy of the assimilation in that particular leaf. The result of a number of experiments enabled the author to answer this question in the affirmative, both as regards the mature organ and the leaf in course of development, though this does not apply to the earliest stages of the development of leaves or of the leaflets of compound leaves.

Absorption of Atmospheric Nitrogen by Plants.†—Messrs. W. O. Atwater and C. D. Woods have carried out a long series of experiments in growing various plants—chiefly peas, lucerne, oats, and maize—in soils saturated with different infusions which promote the formation of root-tubercles. They find that, in all cases where tubercles are produced, there is a distinct absorption of nitrogen from the atmosphere. They assert that atmospheric nitrogen is undoubtedly acquired during the growth of peas and lucerne, and that the amount of nitrogen absorbed is in proportion to the number of tubercles. The addition of soil-infusion is not, however, necessary for the production of the tubercles. The cereals do not, as a rule, possess the power of acquiring nitrogen from the atmosphere, nor are root-tubercles formed on them as in the case of leguminous plants.

Perforation of Potatoes by the Rhizome of Grasses.‡—M. A. Prunet has investigated the perforation of the tuber of the potato by the rhizome of certain grasses, especially *Cynodon Dactylon* and *Triticum repens*, which is not an uncommon occurrence. He finds that it is not of advantage to the perforating organ in the way of obtaining nutriment from the reserve-materials in the tuber. In immediate contact with the perforating rhizome is a layer of disintegrated tissue of the tuber, and next to this a suberous sheath which completely cuts off the rhizome from the nutritive tissues of the tuber. The terminal bud of the rhizome presents no appearance of producing any substance of a diastatic nature, and the small roots which proceed from the rhizome are entirely destitute of root-hairs.

(3) Irritability.

Compass-plants.§—In addition to the well-known instances of *Silphium laciniatum*, species of *Lactuca*, &c., the leaves of which present their two surfaces successively to different points of the compass in order to prevent excessive radiation, Prof. G. Arcangeli describes

* Bot. Ztg., xlix. (1891) pp. 113-25, 129-43 (1 pl.).

† Amer. Chem. Journ., xii. (1890) pp. 526-47; xiii. (1891) pp. 42-63.

‡ Rev. Gén. de Bot. (Bonnier), iii. (1891) pp. 166-75 (2 figs.).

§ Nuov. Giorn. B. t. Ital., xxiii. (1891) pp. 145-9.

another instance of a similar phenomenon in *Larrea cuneifolia*, a shrub from the Argentine Republic. He distinguishes two different varieties of the phenomenon, *politropism*, in which the position assumed is always a meridional one, the two surfaces facing east and west, and *parorthotropism*, in which the lamina assumes a vertical, but not necessarily a meridional position. The latter condition may be a stage of transition to the former, and either may be brought about by different causes, such as heliotropism or geotropism.

(4) Chemical Changes (including Respiration and Fermentation).

Respiration of Plants.*—In a long series of experiments Dr. C. Stich has carefully investigated the effects on respiration of a diminished pressure of oxygen, and of injuries to the tissue. As a general result it was found that the activity of the intramolecular was in inverse proportion to that of the normal respiration; so that, even with a very great reduction of the proportion of oxygen in the surrounding atmosphere, no very great reduction ensued in the amount of carbon dioxide produced. In a general way also the effect of different kinds of injury on various parts of plants was to increase the activity of the respiring process. This is partly dependent on the increase of surface exposed to the air resulting from the injury.

Respiration in the interior of massive tissues.†—According to M. H. Devaux, such tissues as those of the beet and the potato are not so dense as to prevent the access of the atmospheric air to every cell in the interior of the organ. The gases imprisoned in such organs always contain a large proportion of oxygen, and respiration takes place in the normal way. The air gains access through a system of branching canals which permeate the tissue in every direction, and which allow of the rapid passage of gases, even when there is but a slight difference of pressure.

Composition of the internal Atmosphere of Plants.‡—According to a series of observations made by M. J. Peyron, the proportion of oxygen in the air contained in the tissues of plants is subject to great variations; the amount is always less than that in the surrounding atmosphere, while that of carbon dioxide is considerably greater. The proportion of oxygen shows two minima, between 7 and 9 A.M., and between 4 and 5 P.M., and two maxima, about noon and between midnight and 1 A.M. The night maximum is usually greater than that in the day; and these variations are independent of the time of year, of the temperature, and of chlorophyllous assimilation. Young leaves usually contain less oxygen than mature leaves, and those fully exposed to light less than shaded leaves; evergreen generally contain more than deciduous leaves. Movements in the air increase the amount of oxygen in leaves.

Influence of the Carbohydrates on the Formation of Asparagin.§—Herr N. Monteverde has attempted a solution of this question by

* Flora, lxxiv. (1891) pp. 1-57 (2 figs.).

† Comptes Rendus, cxii. (1891) pp. 311-3.

‡ 'Rech. sur l'atmosphère interne d. plantes,' Corbeil, 1888, 89 pp. See Bot. Centralbl., xlv. (1891) p. 217.

§ Arb. St. Petersburg. Naturf.-Ver. (Bot.), xx. pp. 28-30, 43-5 (Russian). See Bot. Centralbl., xlv. (1891) p. 379.

immersing the leafy portion of herbaceous stems or growing first-year branches of woody plants, partly in distilled water, partly in solutions of grape-sugar, cane-sugar, mannite, and glycerin, in the dark. He finds that, after soaking for fifteen days in distilled water or glycerin, there is a large accumulation of asparagin but no trace of starch or mannite in woody plants; in herbaceous plants the amount of asparagin formed is much less considerable; after immersion for a month in cane-sugar, grape-sugar, or mannite, no trace of asparagin is found, but abundance of mannite and starch. These facts point to the conclusion that the asparagin is the result of continued decomposition of the proteids.

Influence of Saltness on the Formation of Starch in Vegetable Organs containing Chlorophyll.*—M. P. Lesage comes to the conclusion that saltness has an influence on the formation of starch in vegetable organs. In extreme cases it hinders its formation. The author has shown that the presence of much salt is accompanied by a diminution of the chlorophyll and of the assimilation of carbon; subsequent processes will not therefore take place so rapidly.

Transformation of Starch into Dextrin by the Butyric Ferment.†—M. A. Villiers has undertaken the study of the action of certain ferments on the carbohydrates under various conditions. He gives the results of the action of the butyric ferment (*Bacillus amylobacter*) on potato starch, and states that under the action of this ferment it is easy to transform amylaceous matter into dextrin. The transformation is direct, maltose and glucose being completely absent; but further investigation is necessary in order to find out whether the dextrans so formed are identical with those obtained by the action of acids or through the influence of diastase. There is formed at the same time a small quantity of a carbohydrate, crystallizing in beautiful radiate crystals from the alcoholic solution, and having the composition $C_{12}H_{20}O_{10} + 3H_2O$. The author regards it as a new substance, and proposes for it the name *cellulosin*. Its physical and chemical properties are given.

Tannins and Trioxybenzols.‡—Referring to the observations of Waage§ on the occurrence and mode of formation of phloroglucin, Dr. E. Nickel suggests that the trioxybenzols may be formed in the same way by the withdrawal of water from inosite, a substance of very wide distribution in the vegetable kingdom, having the empirical formula $C_6H_{12}O_6$, but not nevertheless a true carbohydrate. These trioxybenzols are then probably the source of tannins.

γ. General.

Influence of External Factors on the Odour of Flowers.||—Prof. R. Regel states that while the odour of some flowers, such as those of the mignonnette, of *Stanhopea tigrina superba*, and of the stamens of *Philadelphus coronarius*, is due to the presence of a volatile oil, none appears to be present in the sweet-pea or in *Nycterinia capensis*. In both cases the

* Comptes Rendus, cxii. (1891) pp. 672-3.

† T. c., pp. 435-7, 536-8.

‡ Bot. Centralbl., xlv. (1891) pp. 394-7.

§ Cf. this Journal, ante, p. 209.

|| Arb. St. Petersb. Naturf.-Vcr. (Bot.), xx. pp. 32-7 (Russian). See Bot. Centralbl., xlv. (1891) p. 343.

odour is, as a rule, increased by heat and light. With *Nicotiana longiflora* the flowers are open and fragrant only at night; and here the darkening of the whole plant for three or four weeks is necessary to destroy the scent. *Nycterinia capensis* is peculiar in the fact that the odour is apparently dependent on the presence of starch in the parenchyme of the petals.

Relationship between Plants and Snails.*—Herr F. Ludwig gives a résumé of malacophilous plants, i. e. those that are fertilized by the agency of snails and slugs. He further describes the various modes in which plants are protected against the attacks of molluscs, especially by the presence in the cell-sap of raphides and of tannin. There can be no doubt that galls are a protection against the ravages of these and of other animals. Many spores and other germs do not lose their power of germination by passing through the intestinal canal of snails; and these animals probably play a considerable part in the dissemination of fungi.

Constitution and Formation of Peat.†—According to Dr. J. Früh, peat may be formed either above the surface of the water, when it is composed chiefly of remains of *Sphagnum*, *Eriophorum*, and *Calluna*, the latter being replaced in the West of Europe by *Erica tetralix*, or below the surface, when it consists chiefly of *Hypnum*, *Carices*, and grasses. But almost any plant except fungi and diatoms is capable of contributing to the formation of peat. The chief chemical characteristic of peat is the presence of large quantities of humic and ulmic acids, the latter very commonly in combination with lime, and forming the substance known as dopplerite.

B. CRYPTOGAMIA.

Cryptogamia Vascularia.

Tmesipteris.‡—M. P. Dangeard describes in detail the five species which, according to him, constitute the genus *Tmesipteris*, three of which are new—*T. Vieillardii*, *T. elongatum*, and *T. lanceolatum*. The following are some of the more important general characters of the genus:—

All the species are rootless, the function of the root being performed by a rhizome covered with absorbing hairs. Most of the species grow on tree-ferns, but *T. Vieillardii* is found on moist soil. The walls of the cortical cells often become converted into mucilage, the cell-cavities being filled by a black substance. In the stem the tracheids which form the protoxylem occupy the centre of the vascular bundles, but are often replaced at an early period by a lacuna; these are surrounded by the protophloem. The centre of the stem is in some species occupied by a pith, which may be parenchymatous or collenchymatous, or may be occupied by fibrous cells. The sporangium has the form of a two-chambered egg, and is situated on the upper part of a petiole; the author regards the sporangial leaf as the result of the fusion of two leaves. The cortical

* Bot. Centralbl., 1891, Beih. 1, pp. 35-9. Cf. this Journal, 1890, p. 486.

† Ber. Schweiz. Bot. Gesell., 1891, pp. 62-79.

‡ Le Botaniste (Dangeard), ii. (1891) pp. 163-222 (7 pls.).

cells of the rhizome of some of the species are infested by an endotrophic mycorrhiza (*vide infra*, p. 504).

Archegone of Ferns.*—Prof. D. H. Campbell corrects his previous statement that the ventral canal-cell is wanting in *Struthiopteris germanica*. Sections with the microtome exhibit it very clearly, and show that it is derived from the central cell.

Rhizome of Ferns.†—According to Herr J. Velenovsky, the lateral branches of the rhizome of Ferns do not always originate in the axil of a supporting leaf, but frequently from a true dichotomy. In *Polypodium Dryopteris* and *Phegopteris* the branching is not perfectly dichotomous; but in *Aspidium Thelypteris* it is regularly so; both branches are equally provided with leaves of equal length and vigour, and spring from two terminal segments of equal size. The so-called adventitious buds of *Pteris aquilina*, *Struthiopteris germanica*, *Nephrolepis tuberosa*, &c., are not altogether homologous to the adventitious buds of flowering plants; since in the Ferns these structures are constant, arising regularly at definite spots, and are the sole source of the growth of the plant, there being no other mode of branching. The rhizome of most ferns divides without any regular law, often regularly monopodially or dichotomously, but the branches do not originate in the axil of a leaf.

Apical Growth of Osmunda and Botrychium.‡—Prof. D. H. Campbell finds considerable variation in the structure of the root-tip in the Osmundaceæ. In the common American species of *Osmunda*, while the structure of *O. cinnamomea* agrees, in the mode of growth of the root-tips, very nearly with that of *O. regalis*, that of *O. Claytoniana* approaches much more nearly to the appearance presented by ordinary leptosporangiate ferns.

In the Ophioglossaceæ, a similar difference was observed in the native American species of *Botrychium*, *B. ternatum* and *B. Virginianum*. Of these two species, the latter approaches much more nearly to the true Filices in the structure of its roots, as it does also in other respects.

Structure of Ophioglossaceæ.§—M. G. Poirault calls attention to the following points in the anatomy of the vegetative organs of the Ophioglossaceæ (*Ophioglossum vulgatum* and *lusitanicum* and *Botrychium lunaria*). The sieve-tubes are destitute of callus, presenting a contrast to the structure in the normal Filices. The root grows by the segmentation of a single tetrahedral cell. The roots have a remarkable power of producing buds, which is most strongly displayed in *Ophioglossum vulgatum*. This species is apparently always propagated in this way, the author never having seen a prothallium.

Sphenophyllum.||—Prof. J. S. Newberry describes six American specimens of *Sphenophyllum*, which he regards as probably not the foliage of *Calamites*, but as representing a peculiar and extinct family

* Bull. Torrey Bot. Club, xviii. (1891) p. 16 (2 figs.). Cf. this Journal, 1888, p. 618.

† SB. K. Böhm. Gesell. Wiss., 1890 (2 pls.). See Bot. Centralbl., xlvi. (1891) p. 32.

‡ Bot. Gazette, xvi. (1891) pp. 37-43 (1 pl.).

§ Comptes Rendus, cxii. (1891) pp. 967-8.

|| Journ. Cincinnati Soc. Nat. Hist., xiii. (1891) pp. 212-7 (1 pl.). Cf. this Journal, *ante*, p. 73.

of plants that flourished in all parts of the world during the Devonian and Carboniferous periods, but disappeared at the close of the Permian, and has no nearer relative in our living flora than *Equisetum*. Of the ill-defined genus *Asterophyllites*, probably some species belong to *Sphenophyllum*, others to *Calamites*.

Muscineæ.

Influence of the hygrometric state of the air on the position and function of the leaves of Mosses.*—M. E. Bastit points out that when such a moss as *Polytrichum* grows in moist places, the leaves are expanded and the upper convex surface is at a considerable angle with the stem; while in dry situations the leaves are closed on themselves and on the stem. He found by experiment that, in accordance with the general law, respiration is considerably diminished, and the chlorophyll-function still more so, in the closed as compared to the expanded position. It is in winter, when the atmosphere is most saturated with moisture, that mosses elaborate with the greatest intensity their nutritive principles, owing to the expanded position of the leaves; and this accounts for the formation of the oosphere and the sporogone at that period of the year.

Sexual Organs and Impregnation in *Riella*.†—Dr. O. Kruch has followed out the development of the archegones and antherids in *Riella Clausonis*. The young cellular tissue was treated with eau de Javelle, washed with abundance of distilled water, and stained with congo-red. For the study of the archegones in the process of development, the best results were obtained with methyl-green, after clarifying with oil of marjoram. In the formation of the antherids a marginal cell divides by a transverse septum into two portions, the lower of which forms the foot, and the upper one the body of the antherid. In the formation of the antherozoids the process of nuclear division corresponds, in all essential respects, with that observed by Strasburger in the case of flowering plants. The number of nuclear filaments in the successive divisions of the mother-cells of the antherozoids is invariably eight; and during the process of impregnation the nucleus of the oosphere displays the same number of filaments. When the antherozoid penetrates the cytoplasm of the oosphere, it increases considerably in volume, and gives birth to the male-nucleus, in which there are also evidently eight filaments; the two sexual nuclei possess therefore the same number of filaments, and nearly the same dimensions. The secondary nuclei proceeding from the division of the nucleus of the embryo-cell present sixteen filaments.

Characæ.

Growth of the Cell-wall in *Chara fœtida*.‡—Herr E. Zacharias found that the thickenings of the cell-wall of the rhizoids of *Chara fœtida* are not caused by the excision of the node, nor by any mechanical irritation of the rhizoid, but are formed whenever the plant is placed in pure water not previously containing any *Chara*, or in solution of sugar or dilute glycerin. It is probable that the rhizoids grow by apical growth.

* Comptes Rendus, cxii. (1891) pp. 314-7.

† Malpighia, iv. (1891) pp. 403-23 (2 pls.).

‡ Ber. Deutsch. Bot. Gesell., viii. (1890) Gen.-Vers.-Hft, pp. 56-9.

Algæ.

Cystocarps and Antherids of *Catenella Opuntia*.*—Mr. R. J. Harvey-Gibson describes the hitherto but little known cystocarps and antherids of this species of red sea-weed. The cystocarps are immersed in ramifications of the erect branches; they are spherical, and each ramification contains from 50 to 150 procarps, of which, however, but few arrive at maturity. Each procarp consists of a single carpogonous cell, a single trichophore-cell, and a very long delicate trichogyne. After impregnation each carpogonous cell gives birth to from 12 to 20 carpospores. The antherids are also formed on special branches.

Galls on a Sea-weed.†—Miss E. S. Barton describes pathological structures found in the frond of *Rhodymenia palmata*, which appear to be the result of a stimulus caused by the attacks of a marine Crustacean, *Harpacticus chelifer*. They have the appearance of minute papillæ; and in the cells of these papillæ, as well as in diseased portions of the thallus in their neighbourhood, were found remains of the bodies of the attacking animal, and in some instances its eggs.

Structure and Development of *Chylocladiæ*.‡—Pursuing his investigation of the structure of the genera *Chylocladia*, *Champia*, and *Lomentaria*, especially as regards their vegetative organs, M. F. Debray distinguishes, in all the species examined, between the primary and secondary axes. The former is often short and always solid; and its peripheral portion consists of dichotomously divided rows of cells which become smaller towards the surface. The attachment-disc increases on the whole of its upper side by division of the terminal cells of erect rows. The secondary shoots grow from the primary axis either by lateral growth near the apex, or by actual prolongation of the apex. Special peculiarities of structure are described in *Chylocladia reflexa*, *C. ovalis*, *Lomentaria clavellosa*, and *L. articulata*.

Conjugation of the *Zygnemacæ*.§—Mr. W. West confirms the view taken by Bennett|| and others as to the sexuality of the filaments of the *Zygnemacæ*; all the cells in the same filament appear to be invariably of the same character, either active or passive, in the act of conjugation. He has frequently observed lateral conjugation in cells of a filament, some of the cells of which are in scalariform conjugation with those of another filament. As regards the conjugation of more than two filaments, he finds, like previous observers, polygamy to be much more common than polyandry.

Clamp-organs of the *Conjugatæ*.¶—M. P. A. Dangeard describes root-like organs by means of which some species of *Zygnemacæ*, which usually float free in the water, can attach themselves to a solid substance. They were observed in *Zygonium pectinatum* and in an undescribed species of *Spirogyra*.

* *Neptunia*, i. (1891) pp. 5-6.

† *Journ. of Bot.*, xxix. (1891) pp. 65-8 (1 pl.).

‡ *Bull. Scient. France et Belg.*, xxii. (1890) pp. 399-416 (17 figs.). See *Bot. Centralbl.*, xlv. (1891) p. 21. Cf. this *Journal*, 1888, p. 265.

§ *Neptunia*, i. (1891) pp. 81-5 (2 pls.). || Cf. this *Journal*, 1884, p. 434.

¶ *Le Botaniste* (Dangeard), ii. (1891) pp. 161-2, and 228 (1 pl.).

M. E. De Wildeman* describes similar structures in species of *Mesocarpus*, *Spirogyra*, and *Zygogonium*, produced under normal conditions of growth.

Mode of Attachment of Cladophora.†—M. F. Gay describes the mode of attachment to the substratum of two species of *Cladophora*, a character which he thinks will be useful in the discrimination of species. In *C. glomerata* the organ of attachment is a creeping "rhizome," consisting of short branches composed of short round or elliptical cells, each of which contains several nuclei. From this rhizome the erect branches spring in the ordinary way, and it puts out slender "rhizines" for further attachment. Containing a large quantity of starch, and often protected by a calcareous incrustation, this rhizome serves also for the perpetuation of the species during winter. *C. fracta* possesses a similar rhizome, from which, in the variety observed (forma *dimorpha*), there spring branches much more slender than the ordinary ones, which themselves branch, and, breaking off readily from the rhizome, form a floating mass of slender filaments which might readily be mistaken for a *Rhizoclonium*.

Pleiocarpous Species of Trentepohlia.‡—M. P. Hariot unites all the species of *Trentepohlia* characterized by a number of stalked zoospores springing from a single large cell, viz. *T. uncinata*, *pleiocarpa*, and *arborum*, into one, to which he restores the name *T. aurea*.

De-Toni's Sylloge Algarum.—The first part of the second volume of this most important work is just published, consisting of a complete and valuable Bibliography of the Diatomaceæ by M. J. Deby. The first volume (1889), devoted to the Chlorophyceæ, contains a description of every species of green Algæ at present recognized. These are arranged under 4 orders—the Confervoideæ, Siphoneæ, Protococcoideæ, and Conjugatæ, which are again divided into 25 families, viz. :—1, Coleochætaceæ, 2, Mycoideaceæ, 3, Ædogoniaceæ, 4, Cyliandrocapsaceæ, 5, Sphæropleaceæ, 6, Ulvaceæ, 7, Ulotrichaceæ (Ulotricheæ, Chætophoreæ, Confervæ), 8, Chroolepidaceæ, 9, Hansgirgiaceæ (*Hansgirgia flabelligera*), 10, Cladophoraceæ (Cladophoreæ, Spongocladiæ, Microdictyeæ, Anadyomeneæ, Valoniæ), 11, Pithophoraceæ, 12, Gomontiaceæ (*Gomontia polyrhiza*), 13, Vaucheriaceæ, 14, Dasycladaceæ (Dasycladeæ, Acetabulariæ), 15, Derbesiaceæ, 16, Bryopsidaceæ, 17, Caulerpacæ, 18, Spongodiaceæ, 19, Udoteaceæ, 20, Hydrogastraceæ (*Botrydium granulatum*), 21, Phyllosiphonaceæ (*Phyllosiphon Arisari*), 22, Volvocaceæ (Volvoceæ, Spondylomoreæ, Hæmatococceæ, Cyliindromonadeæ), 23, Palmellaceæ (Cœnobieæ, Pseudocœnobieæ, Eremobieæ, Tetrasporeæ, Dictyosphæriæ, Nephrocytiæ, Coccaceæ), 24, Zygnemaceæ (Mesocarpeæ, Zygnemeæ), 25, Desmidiaceæ. Of *Ædogonium* 189 species are enumerated, of *Cladophora* 229, of *Caulerpa* 80, of *Spirogyra* 81, of *Closterium* 103, of *Cosmarium* 308, of *Staurastrum* 250. A complete physiological bibliography is appended.

* CR. Soc. Roy. Bot. Belgique, 1891, pp. 35-9 (3 figs.).

† Journ. de Bot. (Morot), v. (1891) pp. 13-6 (3 figs.).

‡ T. c., pp. 77-8. Cf. this Journal, 1890, p. 490.

Fungi.

Influence of Light on the Growth of Fungi.*—According to Herr F. Elfving, the results of experiments on mould-fungi show that light has in general a prejudicial effect on synthesis, both the visible and the ultra-violet rays having this effect. With the same organisms, light diminishes respiration when they are young, but has no influence when they are mature.

Dispersion and Germination of the Spores of Fungi.†—Dr. M. C. Cooke doubts whether there is any actual evidence to support the prevalent theory that the spores of some fungi, such as those of the mushroom, must pass through the intestinal canal of an animal before they can germinate. On the other hand it seems clear that the fetid odour of *Phallus impudicus* and of other Phalloidei does attract flies and other insects which are serviceable in the dissemination of the spores.

Carbohydrates in Fungi.‡—M. E. Bourquelot points out that, in order to obtain a knowledge of the saccharine matters contained in fungi, it is necessary to submit both old and young specimens to the action of boiling water. The author has nearly always succeeded in isolating trehalose. It is to be found, for instance, in *Boletus scaber*, *B. versipellis*, *B. aurantiacus*, *B. edulis*, and *Hypholoma fasciculare*. If the fungus is fairly advanced, mannite will be found at the same time, while in still older fungi only mannite is found. Another point the author mentions is that the sugar contained in young fungi does not reduce the cupropotash solution, but it acts as a reducing agent when the fungus becomes old, or when it is dried at a low temperature.

Endotrophic Mycorrhiza.§—M. P. A. Dangeard describes the fungi which are found in the cortical cells of the rhizome of *Tmesipteris Vieillardii*. They are of two kinds, a *Cladochytrium* and an Ascomycetous fungus. The former is a new species which the author names *C. Tmesipteridis*, distinguished by its well-developed brown torulose mycele producing a great number of sporanges and oosperms. The author believes that we have not here an example of true symbiosis, but that the fungus is parasitic on its host and injurious to it. The Ascomycetous fungus was undetermined, no peritheces being seen, but it is probably nearly allied to *Nectria*; this latter is probably truly symbiotic, and of advantage to its host.

Chætostylum.||—M. A. de Wèvre identifies Klein's *Bulbothamnidium elegans* with the *Chætostylum Fresenii* of Van Tieghem, a small fungus belonging to the Mucorini found on horse-dung. He regards *Chætostylum* as sufficiently distinct generically from *Thamnidium*. A second species proposed by Sorokine under the name *Chætostylum echinatum* is identical with *Thamnidium chætocladioides*.

* 'Studien üb. d. Einwirkung d. Lichtes auf d. Pilze,' Helsingfors, 1890, 5 pls. See Biol. Centralbl., xi. (1891) p. 163.

† Grevillea, xix. (1891) pp. 84-6.

‡ Bull. Soc. Mycol. de France, 1890. See Rev. Mycol., xiii. (1891) p. 43. Cf. this Journal, ante, p. 77.

§ Le Botaniste (Dangeard), ii. (1891) pp. 223-8 (1 pl.).

|| CR. Soc. Roy. Bot. Belgique, 1891, pp. 40-4.

Mycele and Protospores of *Sphærotheca Castagnei* v. *humilis* and of *Pleospora herbarum* v. *Galii aparinis*.*—Dr. E. Lambotto states that the myceles of both the above species are composed of a large number of anastomosing hyphæ, the only difference being that in *Pleospora herbarum* the septa simulate chains of cells. The life-history of each fungus is carefully traced. In *Pleospora* we have, at the beginning of winter, the conidial condition (*Cladosporium herbarum*), then a little later *Phoma herbarum* shows itself, and it is towards the end of winter when the *Phoma* is at its point of greatest activity that *Pleospora herbarum* first appears.

“Tamel-getreide.”†—Herr M. Woronin has investigated this disease, which attacks the corn-crops, especially rye, in parts of Russia, Sweden, and Germany, causing the grains to shrivel up and turn black, and finds evidence of the presence of no less than fifteen species of parasitic or saprophytic fungi. The injurious effects resembling intoxication, observed in men or cattle which have eaten the grains attacked by the disease, are probably due to one or other of the four following species:—*Fusarium roseum*, *Gibberella Saubenetii*, *Helminthosporium* sp., and *Cladosporium herbarum*.

Musk-fungus.‡—Prof. G. v. Lagerheim identifies the *Fusisporium moschatum* of Kitasato, distinguished by its musk-like odour, with *Selenosporium* or *Fusarium aquæductuum*. It not uncommonly forms slimy masses where there is a continual dripping of water. Imperfect peritheces having been found upon it, it is doubtless a stage in the cycle of development of an ascomycetous fungus.

New Vine-disease.§—M. P. Viala describes a disease which has of late years been very destructive to the vines in the south and south-west of France. It makes its appearance in the form of black nodules on the stem, which are sclerotes belonging to the form of *Peziza* known as *Sclerotinia Fuckeliana*.

Atichia.||—This singular organism, which has been separated as a distinct genus of Collemaceæ, is classed by Herr A. Minks along with *Myriangiolum* ¶ as forming a class presenting none of the true characters of the Collemaceæ or gelatinous lichens, but belonging to the Ascomycetes, and recognized as true lichens by the possession of gonids.

Chlorodictyon foliosum and Ramalina reticulata.**—Prof. C. Cramer identifies *Chlorodictyon foliosum*, described by Agardh as belonging to the Caulerpeæ, with the lichen *Ramalina reticulata*. It is probably a marine form.

Arthonia.††—Mr. H. Willey publishes a monograph of this genus of Lichens, of which he enumerates 348 species, seven of them being new.

* Rev. Mycol., xiii. (1891) pp. 1-4. † Bot. Ztg., xlix. (1891) pp. 81-93.

‡ Centralbl. f. Bakteriol. u. Parasitenk., ix. (1891) pp. 655-9 (6 figs.) Cf. this Journal, 1889, p. 560.

§ Rev. Gén. de Bot. (Bonnier), iii. (1891) pp. 145-9 (3 figs.).

|| Bot. Centralbl., xlv. (1891) pp. 329-32, 362-5.

¶ Cf. this Journal, ante, p. 383.

** Ber. Schweiz. Bot. Gesell., 1891, pp. 100-23 (3 pls.).

†† ‘A Synopsis of the genus *Arthonia*,’ New Bedford, 1890, 62 pp. See Bot. Centralbl., xlv. (1891) p. 98.

Both the diagnosis of the genus and the discrimination of the species are attended with great difficulties.

Black-rust of Cotton.*—Prof. G. F. Atkinson describes this disease, which is very destructive to the cotton-crop in Alabama. The diseased spots show the presence of a considerable number of fungi, but the parasite to which it appears to be chiefly due is *Cercospora gossypina*.

New Genus of Tuberculariæ.†—L'Abbé I. Bressadola diagnoses the new genus *Kriegeria* as follows:—Sporodochia subinnata, mox superficialia, tremellinea læte colorata; conidia clavato-cylindracea, e continuo pluriseptata, ex sporophoris simplicibus, stipitem constituentibus, oriundis, apice, et ad septa conidiola simplicia vel subfasciculata gerentibus; conidiola oblonga vel clavata, fertilia, scilicet conidiola ipsis conformia germinantia. Hyphæ myceliales e conidiis septatis oriundæ. The single species, *K. Eriophori*, was found on the leaves of *Eriophorum angustifolium*.

Urocystis Violæ and Ustilago antherarum.‡—M. E. Roze has found *Urocystis Violæ* parasitic on *Viola odorata*. It is very easily recognized by the swellings it forms on the leaves and petiole of its host. The author also makes some observations on *Ustilago antherarum* parasitic on *Lychnis dioica*.

Gymnosporangium.§—Dr. C. v. Tubeuf gives a résumé of the present state of our knowledge of the native German species of *Gymnosporangium*, both in their teleutospore- and in their æcidio-form; and especially defines the distinctive characters of *G. Sabineæ*, *G. clavariæforme*, and *G. tremelloides* (= *G. conicum* and *G. juniperinum*). The latter is far the most destructive parasite to its host the juniper. The æcidio-forms of all these three species occur on a number of different trees and shrubs, all belonging to the Rosacæ.

The same author|| points out that the Uredinæ cannot be determined specifically by their *Roestelia*- or æcidio-form alone, as these frequently vary according to the host. Thus *Gymnosporangium tremelloides* produces on *Cratægus* æcidia with long horn-shaped, on *Sorbus latifolia* æcidia with very short peridia. The same species of tree may act as host for more than one teleutospore-species, as species of *Sorbus* for both *G. tremelloides* and *clavariæforme*.

New Anthracnose of Pepper.¶—Under the name *Colletotrichum nigrum*, Prof. B. D. Halsted describes a newly observed destructive parasite of the fruit of the pepper (*Capsicum annuum*), characterized by a large number of long straight black bristles which are found among the basids.

Sigmoideomyces, a new Genus of Hyphomycetes.**—Among a number of new North American fungi, belonging to the Hyphomycetes, Mr. R. Thaxter describes a new genus, *Sigmoideomyces*, with the

* Bot. Gazette, xvi. (1891) pp. 61-5. † Rev. Mycol., xiii. (1891) pp. 14-5.

‡ Bull. Soc. Bot. France, xxxvii. (1890) pp. 233-4 and xxxviii. (1891) pp. 69-71.

§ Centralbl. f. Bakteriöl. u. Parasitenk., ix. (1891) pp. 89-98, 167-71 (3 figs.).

|| SB. Bot. Ver. München. Feb. 11, 1891. See Bot. Centralbl., xlvi. (1891) p. 19.

¶ Bull. Torrey Bot. Club, xviii. (1891) pp. 14-5 (5 figs.).

** Bot. Gazette, xvi. (1891) pp. 14-26 (1 pl.).

following characters:—Fertile hyphæ erect, septate, growing in sigmoid curves, intricately branched, the main branches subdichotomous or falsely dichotomous, the ultimate branches sterile. Spores solitary, thick-walled, borne on the surface of spherical heads. Heads borne at the apex of short lateral branches which arise from opposite sides of certain cells in the continuity of the hyphæ.

Sclerote-forming Fungi.*—Herr E. Fischer describes various sclerotic formations of Fungi, and discusses their connection with the hymenomycetous fructification-form.

Pachyma Cocos is a widely distributed sclerote attached to the roots of trees, especially Conifers. The internal white substance of the sclerote consists of slender hyphæ and very strongly refringent, often branched, coral-like masses of various sizes. From their reaction towards chemical reagents, and by tracing the continuity of the hyphæ, Herr Fischer has determined that the hyphæ belong to the fungus and not to a modification of the woody structure of the host. *Pachyma* is a true parasite, exercising a destructive influence on its host. Its fructification-form is in all probability a *Polyporus*, but the species cannot at present be determined.

Polyporus sacer from Madagascar is a long-stalked species springing from a large and well-developed sclerote, which the author identifies with that described as *Pachyma Malaccense*, and has determined their genetic connection by tracing the continuity of the hyphæ from one to the other. This sclerote also contains strongly refringent bodies which are obviously a store of reserve food-material.

Several exotic species of *Lentinus* spring from sclerotes, known as *Tuber regium* and *Pachyma Woermanni*, on which they have been regarded by some as parasitic; the author has, however, traced a genetic connection between the two.

Mylitta, *Sclerotium stipitatum*, and *Pietra fungaja* are sclerote-like structures, the true nature of which it is impossible at present definitely to determine, from the want of material.

Prof. F. Cohn and Dr. J. Schroeter † describe the various forms of *Pachyma* and *Mylitta*, which they regard as sclerotes. From *Pachyma Woermanni* a hymenomycete-form was obtained described as *Lentinus Woermanni* sp. n., and from *Mylitta lapidescens*, from Japan and the West Indies, a fructification which also represents a new species, *Omphalia lapidescens*.

Sclerotoid Coprinus.‡—Messrs. J. B. Ellis and B. Everhart describe a species of *Coprinus* found growing on a sclerote. To this the name of *Coprinus sclerotigenus* has been given, it being sufficiently distinguished from other sclerotoid species of *Coprinus* by its habit, its few spores, and its stipe.

Mycodendron, a new Genus of Hymenomycetes.§—Mr. G. Massee describes a remarkable new genus of fungi from Madagascar, allied to *Merulius*, characterized by the stipe bearing a large number of super-

* Hedwigia, xxx. (1891) pp. 61-103 (8 pls.).

† Abhandl. Naturwiss. Ver. Hamburg, xi., 16 pp. and 1 pl. See Hedwigia, xxx. (1891) p. 117.

‡ Rev. Mycol., xiii. (1891) pp. 18-20.

§ Journ. of Bot., xxix. (1891) pp. 1-2 (1 pl.).

posed pilei. The following are the characters of the genus:—Stipe erect, central, elongate-conical, expanding at the base into an irregular disc; pilei several, imbricated on the stipe, distant, acropetal in development, circular or irregularly reniform, thin, sub-gelatinous; hymenium inferior, tuberculose or with sinuous nodulose ridges, showing a radial tendency of arrangement; basids tetrasporous; spores continuous, brown.

Protophyta.

a. Schizophyceæ.

Polycoccus.*—According to M. P. Hariot, this obscure genus of Algæ, founded by Kützing, which that author regarded as a stage of development of higher algæ, and which has been described as the algal constituent of several lichens, must be abolished. The plant described by Kützing is nothing but a minute species of *Nostoc*, indistinguishable from *N. punctiforme* Ktz. (*N. Hederulæ* B. & F.).

Movement and Reproduction of Diatoms.†—Sig. L. Macchiati gives his adhesion to the view that the power of movement of diatoms has its source in the contractility of an external "perifrustular" layer of protoplasm. This layer he has observed in diatoms belonging to the most various families,—Naviculaceæ, Cymbellaceæ, Gomphonemaceæ, Achnantheaceæ, Nitzschiaceæ, and Surirellaceæ.

Sig. Macchiati thus describes an example of conjugation observed in *Cymbella Cistula*. Two frustules approached and placed themselves opposite to one another by the slightly concave parts of the valves. They then began to excrete a large quantity of hyaline mucilaginous substance, which completely invested them in an ovoid mass. The chromatophores of the two frustules then collected in the centre of each, in the form of an ellipsoid body, which after a time divided into two spherical masses; these increased considerably in size, and eventually escaped from the valves. The four masses then fused together into two, and finally into a single globular body. This last inclosed itself in a double membrane and became a sporangium, within which was developed an auxospore. This auxospore, increasing in size, burst the membrane of the sporangium, and gradually assumed the form of a frustule of *Cymbella Cistula*.

A different mode of multiplication was observed in a specimen of *Hantzschia Amphioxys*. The protoplasm here divided itself into two ellipsoidal masses with numerous oily drops. These masses became inclosed with a cellulose wall while within the parent-frustule, afterwards escaping from it, after which the membranes became silicified. The parent-frustule was not invested with a mucilaginous envelope preparatory to the division, as in the case of conjugation.

Schmidt's Atlas der Diatomaceen-Kunde.—The most recently published part (Hefte 41 and 42) of this magnificent work consists of eight plates, containing representations of different views and different forms of species of *Aulacodiscus*, *Coscinodiscus*, *Porodiscus*, *Anthodiscus*, *Stephanopyxis*, *Craspedoporus*, and *Triceratium*.

* Journ. de Bot. (Morot), v. (1891) pp. 29-32.

† Nuov. Giorn. Bot. Ital., xxiii. (1891) pp. 175-84.

β. Schizomycetes.

Influence of the Digestive Secretions on Bacteria.*—Herr G. Leubuscher, in an experimental examination of the intestinal juice, the pancreatic secretion, and the bile, made use of typhoid bacillus, cholera bacillus, Finkler-Prior's bacillus, potato bacillus, anthrax, *Bacterium coli commune*, *Proteus vulgaris*, *Bacillus acidi tartarici*, *B. butyricus*, *Saccharomyces cerevisiæ* and *ellipsoideus*.

In the secretion from the small intestine a diminution was first remarked, but this was soon followed by an enormous increase. The micro-organisms seemed to thrive better in the juice of the jejunum than in that from the ileum.

Trypsin solutions formed still better media for the cultivation of these organisms. In fresh bile some of the microbes flourished, but others did badly; among these latter were *B. butyricus* and the *Saccharomycetes*. Solutions of the biliary acids, however, possessed a decidedly inhibitory action, except for anthrax, the spores of which germinated.

From his experiments the author concludes that in the intestinal and pancreatic juices bacteria of the most various sorts thrive extraordinarily well, and that digestive ferments have no influence over living organisms. Fresh bile is devoid of antiseptic property, yet the free biliary acids possess a disinfecting power; and the old view of the antiseptic action of the bile would therefore hold good, provided conditions were present which rendered it possible for these acids to exist in a free state.

Presence of Bacteria in normal Vegetable Tissue.†—The experiments of Bernheim, which led that investigator to conclude that the presence of bacteria in vegetable tissue was a normal phenomenon, have been repeated by Buchner. This author failed to find bacteria under similar circumstances, except where there had been an accidental contamination.

On the only occasion on which a particle of matter (within a maize-grain) was found to increase in size, it was not composed of bacteria but of oil.

Bacillus hydrophilus fuscus.‡—This pathogenic micro-organism was isolated by Dr. G. Sanarelli from the laboratory water used for keeping frogs intended for experiments on immunity. The mortality among the frogs was found after a time to be constantly associated with the presence of a bacillus in the serum used for experimenting with the anthrax bacilli.

Grown on artificial nutrient media, this micro-organism was found to thrive well, especially on gelatin and meat-broth, but potato cultivations presented very characteristic appearances. Hereon the inoculation track in twelve hours presented an overlay of a straw-yellow colour, which in four to five days became brown. Gelatin was liquefied,

* Zeitschr. f. Klin. Medicin, xvii. (1890) No. 5. See Centralbl. f. Bakteriol. u. Parasitenk., ix. (1891) pp. 244-5.

† SB. Gesell. Morphol. Physiol. München, iv. (1889) pp. 127-30. See Beihefte z. Bot. Centralbl., 1891, pp. 15-16.

‡ Centralbl. f. Bakteriol. u. Parasitenk., ix. (1891) p. 193 (1 pl.)

the softened portion having a funnel-shaped appearance. When grown in glycerin-agar the bacilli presented a fairly constant form, mobile rodlets 1-3 μ long being the predominant variety, while on gelatin they were inconstant in appearance, varying from spheroidal forms to filaments 12 to 20 μ long, although 2 to 3 μ was the most frequent length.

Inoculation experiments with pure cultivations of this bacillus showed that it was pathogenic to cold and warm-blooded animals, such as frog, toad, salamander, lizard, eel, guinea-pig, rabbit, dog, cat, mice, bat, hedgehog, pigeon, and fowl.

From the rapid action of the injections on animals, the author supposed that the metabolic products of these bacilli were endowed with some specially toxic properties, yet he admits that the intravenous and subcutaneous injections of fluid obtained by filtering broth and gelatin cultivations through a Chamberland's filter failed to bear out his assumption. The author next notices the points of difference between this bacillus (*B. hydrophilus fuscus*) and that described by Ernst, *B. rancida*, a form connected with an epidemic disorder to which frogs are liable in spring.

Variability of the Red Bacillus of Kiel Water.*—M. Laurent succeeded in depriving the Kiel water bacillus of its red pigment by exposing it to the action of sunlight, and the alteration thus induced was found to be constant, lasting for generations. This pigment is soluble in water and alcohol, less so in benzine, and insoluble in chloroform and sulphuric acid. In the presence of small quantities of acid the red pigment assumes a brighter hue, while alkalis have the contrary effect. The bacillus thrives between 10° and 42°, but the optimum temperature is from 30° to 35°. If air be excluded development may proceed, but without the formation of pigment.

Acid reaction of the medium (1 per thousand free tartaric acid) prevents development, the bacillus itself, in the presence of sugar, forming no inconsiderable quantity of acid, which eventually stops its growth. Before this has taken place the production of pigment has ceased, although a very feeble acid reaction seems to impart a more lively hue to the pigment. The temperature and the presence of carbonic acid have some determining influence on the shade of the pigment.

To light the bacillus is extremely sensitive; exposure for three hours to sunlight falling vertically caused the large majority of the colonies to be quite colourless, a condition which was retained by successive generations. Exposure for one hour had only a transitory effect, while five hours killed the colonies. Control experiments made with cultivations from which air was excluded, or in atmospheres of hydrogen or carbonic acid, showed that the alterative effect of the sun's rays was only evinced in co-operation with air.

Differences in the action of the component rays of the spectrum were not made out.

The colourless generations obtained by exposure to light retained their condition up to the thirty-second transference on potato at from

* Annales de l'Institut Pasteur, 1890, p. 465. See Centralbl. f. Bakteriol. u. Parasitenk., ix. (1891) pp. 105-6.

25°–35°, while before this they had constantly shown a violet-red colour under these circumstances.

Alteration in the kind and character of the medium had no effect in recalling the pigment, but the red colour was found to return on potato at 10° to 25°, but was lost again if further cultivations were made at higher temperatures.

Pseudotuberculosis produced by a pathogenic Cladothrix.*—Herr H. Eppinger found in an old glass-grinder who had died of cerebro-spinal meningitis, consecutive to a chronic metastatic abscess of the brain, and in whom were also present lymphatic abscesses and pseudotuberculosis of the lungs and pleura, that a hitherto unknown pathogenic cladothrix was the cause of the first-mentioned disease. Cultivated on artificial media it presented its characteristic appearances, and on account of its stellate form the author designates it *Cladothrix asteroidea*. In guinea-pigs and rabbits the pseudotuberculosis cladothrichica was produced, and from their morbid products pure cultivations of *Cladothrix asteroidea* were obtained.

Effect of the Koch Treatment on the Tubercle Bacilli in Sputum.†—Dr. J. Amann records the results of his experience of the effects of the Koch injection treatment from the examination of the sputa of 288 patients.

(1) The quantity of sputa is as a rule increased after the reaction.

(2) The number of the tubercle bacilli considerably increased. In seventeen cases where numerous examinations had previously failed to reveal the presence of bacilli, the sputum was afterwards found to contain the tubercle bacillus. In four patients the number of bacilli was obviously diminished.

(3) The medium exerts an unmistakable influence on the shape of the bacillus. By this the author means that the bacilli are changed into micrococci, or are seen as shapeless lumps of quite short, often punctiform bacilli.

(4) In certain cases their specific resistance to decolorizing reagents is diminished.

(5) In forty per cent. of the cases the quantity of elastic fibres found in the sputum is markedly increased.

Spongy Cheese.‡—Dr. E. de Freudenreich gives the name of *Bacillus Schafferi* to a micro-organism which he has found to be the exciting cause of the swelling of cheese. The swelling is due to a large number of holes of variable size, and these holes are formed by the gaseous products of colonies of bacilli, whereby the cheese becomes larger, soft, and spongy (boursoufflement, fromage mille trous). The bacillus is about 1 μ broad, and in length varies from 2–3 μ , although filaments of 20–25 μ were observed. It is extremely mobile, stains well with anilin dyes, and is easily cultivated on gelatin, agar, potato, and bouillon. It is somewhat sensitive to heat, desiccation, and antiseptics. It grows well in the absence of air, and in the presence of hydrogen,

* Ziegler's Beiträge zur Path. Anat. u. zur Allgem. Pathol., ix., No. 2. See Centralbl. f. Bakteriologie u. Parasitenk., ix. (1891) p. 274.

† Centralbl. f. Bakteriologie u. Parasitenk., ix. (1891) pp. 1–3.

‡ Ann. de Microgr., iii. (1891) pp. 161–77 (1 pl.).

with copious evolution of carbonic acid gas, probably the result of its action on the sugar of milk. The optimum temperature is 36°. *Bacillus Schaffer* appears to possess several characteristics common to other bacteria, notably to *B. coli commune* Escherich, but is distinguishable therefrom by differences in mobility, pathogenic action, and capacity for existing in absence of air.

The action of this bacillus was tested on newly made cheeses, and the results seem sufficient to support the author's view, since the inoculated cheeses became spongy, while those kept as control specimens remained healthy. The milk was inoculated at the same time as the rennet was added.

New Bacillus in Bees.*—Sig. G. Canestrini describes a new bacillus the occurrence of which is associated with great mortality in bee-broods. He thought at first that he would find the *Bacillus alvei* already described by several bacteriologists, but the new species is entirely different. Thus it forms a wine-red spot when cultivated on the potato, becomes encapsuled in blood-serum, and produces no pathological effects on the rat and guinea-pig inoculated with it.

Fraenkel and Pfeiffer's Microphotographic Atlas of Bacteriology.†—Parts 6–10 of this Atlas have now appeared. These numbers comprise plates XXVII.–LI., and the explanatory text. The micro-organisms dealt with in Parts 6–8 are those of malignant oedema, tetanus, symptomatic anthrax, tubercle, leprosy, syphilis, glanders, and diphtheria.

Anti-bacterial Properties of the Gastric Juice.‡—Dr. R. Kianowsky, from a series of careful experiments, finds that the fasting stomach (14–18 hours after the last meal) contains numerous microbes. The number of bacteria colonies which can be obtained an hour after a meal appears to have no relation to the acidity or to the amount of hydrochloric acid; it depends directly on the quantity of microbes contained in the food.

With a moderate amount of acidity and moderate quantity of hydrochloric acid the gastric juice keeps killing off the micro-organisms in the stomach; in other words, the more the microbes are annihilated, the longer the gastric juice works. A strict ratio between the increase of the acidity of the gastric juice and the disappearance of the microbes does not exist. If the acidity of the gastric contents be very slight, the microbes increase in number.

Experiments on the sick whose gastric juice still contains a sufficient quantity of free acid show that their gastric juice possesses anti-bacterial qualities similar to those of healthy men.

New Bacillus from the Small Intestine.§—Dr. V. Boret describes a bacillus which was isolated from the small intestine of a patient dying of acute enteritis. The bacillus is from 2–4 μ long, and from 1–1.5 μ broad, usually single and occasionally in pairs; it is extremely mobile. It was best stained with phenolphuchsin, and also with safranin or

* Atti Soc. Ven.-Trent. Sci. Nat., xii. (1891) pp. 134–7 (1 pl.).

† 'Mikrophotographischer Atlas der Bakterienkunde,' Berlin, 1890, 91. See Centralbl. f. Bakteriologie u. Parasitenk., ix. (1891) pp. 204–5, 507–8.

‡ Wratsch, 1890, Nos. 38–41. See Centralbl. f. Bakteriologie u. Parasitenk., ix. (1891) pp. 420–1.

§ Ann. de Microgr., iii. (1891) pp. 353–8.

Bismarck-brown. It grows well in peptonized agar, in gelatin, in bouillon, in solutions of sugar, and on potato. The most favourable temperature was about 37° C.

The microbe does not liquefy the medium nor develop spores. It is essentially aerobic. It has little or no action on albumen, and though it will develop on starch, does not saccharize this substance. It decomposes sugar, forming carbonic acid, lactic acid, succinic acid, and alcohol. It does not possess apparently any specific pathogenic action.

Pathogenic Bacillus obtained from Floor-dust.*—Dr. Okada has isolated from dust from the floor a bacillus endowed with pathogenic properties. It grows in the usual media at ordinary temperatures in whitish colonies somewhat like the bacillus of typhoid. Examined microscopically it is found to be a short rod with rounded ends, about twice as long as broad. It was stainable with the ordinary anilin pigments, but Gram's method failed. The bacillus is immobile, and spore-formation was not observed. Inoculations in rabbits, guinea-pigs, and mice were made. The most marked post mortem appearance was the great swelling of the lymphatic glands and of the spleen. The micro-organisms were found, by means of the Microscope, in all the organs.

The author conceives that this bacillus resembles those described by Emmerich and by Brieger, but is not identical therewith, since the two latter grow well on potato, while the former does not.

Baumgarten's Report on Micro-organisms.†—Dr. P. Baumgarten's Annual of Pathogenic Micro-organisms, which embraces Bacteria, Fungi, and Protozoa, has recently been published. The present volume deals with the year 1889, and contains 632 pages. It presents similar features to the previous volumes.

Action of Light on Acetic Fermentation.‡—Sig. M. Giunti finds that direct sunlight prevents the development of *Mycoderma aceti*, and therefore of the acetic fermentation. Even diffuse daylight possesses an inhibitory influence if the surface of the fluid be not shaded. Prolonged exposure to the sunlight, however, is not sufficient to sterilize the fluid.

Bacteria in Sputum.§—Dr. S. Panzini's examination of sputum was conducted at three different times. It was examined directly by different microscopical methods; it was inoculated in animals. Pure cultivations of the various organisms were made.

Besides the microbes already known, the author isolated a new organism, *Bacillus tenuis sputigenus*. This is a diplococcus or diplobacillus which stains by Gram's method, grows on gelatin at the ordinary temperature, spreading out flat on the surface of the medium, and in this differing from Friedlaender's bacillus, which forms a distinct swelling. It grows well on potato, and coagulates milk with formation

* Centralbl. f. Bacteriol. u. Parasitenk., ix. (1890) pp. 442-4.

† Baumgarten's Annual Report on Pathogenic Micro-organisms, 5th year, 1889, Brunswick, 1890, 8vo, pp. 632. See Centralbl. f. Bakteriologie u. Parasitenk., ix. (1891) p. 605.

‡ Le Stazioni Sperimt. Agrar. Ital., xviii. p. 171. See Centralbl. f. Bakteriologie u. Parasitenk., ix. (1891) pp. 539-40.

§ Virchow's Archiv, cxxii. (1890). See Centralbl. f. Bakteriologie u. Parasitenk., ix. (1891) pp. 566-9.

of acid. It is pathogenic to rabbits and white rats, but not to guinea-pigs (in small doses), nor to white mice.

Plate-cultivations were made from sputum of 52 different cases, and it is important to note that in all these instances there developed colonies indistinguishable from those of the Fraenkel-Weichselbaum pneumococcus, but which should be classed with that large family of cocci inhabiting the mucosa, the most important representative of which is the diplococcus of pneumonia.

Besides these mucosa-cocci the author describes 21 kinds of bacilli, 10 kinds of cocci, and 3 fungi.

Bacteria and their Products.*—This volume of about 400 pages, which are followed by an appendix giving a short account of the bacteriological methods and a diagnostic description of the commoner bacteria, and illustrated by twenty photomicrographs, is described by the author, Dr. G. S. Woodhead, as "an attempt to give some account of the main facts of bacteriology and of the life-history of bacteria," with special reference to fermentation, putrefaction, and disease.

From a careful perusal of the work we can recommend it very heartily to all who are desirous of learning the principles of bacteriology and ascertaining the facts on which these principles are founded. The style is extremely clear and easy of understanding.

If any exception can be taken to the book, it is the illustrations. Photomicrographs, unless very good indeed, are, in our opinion, very bad for teaching purposes.

- BILLROTH, DR. TH.—Ueber die Einwirkungen lebender Pflanzen u. Thierzellen auf einander. (On the Reciprocal Action of living Animal and Vegetable Cells.)
Vienna, Alfred Hölder, 1890, 43 pp.
- BURGI, DR. EINRIGO.—Contributo alla conoscenza dei caratteri biologichi e patogeni del *Bacillus pyogenes fetidus*. (Contribution to our knowledge of the Biological and Pathogenic Characters of *Bacillus pyog. fetidus*.)
Pisa, Mariotti, 40 pp.
- CHARRIN, A.—Toxicité du sérum. (Toxicity of Serum.)
Compt. Rend. de la Soc. de Biol., 1890, pp. 695-6.
- FOKKER, A.-P.—Ueber bakterienvernichtende Eigenschaften der Milch. (On the Bactericidal Properties of Milk.)
Zeitschrift für Hygiene, IX. p. 89.
- KIRCHNER, M.—Die Bedeutung der Bakteriologie für die öffentliche Gesundheitspflege. (The importance of Bacteriology in Public Hygiene.)
(*Berliner Klinik*, 33 Heft.)
Berlin, Fischer's Med. Buchh., 1891, large 8vo, 36 pp.
- LAURENT, E.—Expériences sur la réduction des nitrates par les végétaux. (Experiments on the Reduction of Nitrates by Plants.)
Annal. de l'Institut. Pasteur, 1890, No. 11, pp. 722-44.
- LAVERAN, —.—Au sujet des altérations des globules rouges du sang qui peuvent être confondues avec les hématozoaires du paludisme. (On the Alterations of Red Blood-corpuscles which can be confused with the Hæmatozoa of Marsh Fevers.)
Compt. Rend. de la Soc. de Biol., 1890, No. 39, pp. 733-5.
- MÜLLER-THURGAU, H.—Ueber den Ursprung der Weinhefe. (On the Origin of Wine-ferment.)
Weinbau und Weinhandel, 1889, Nos. 40 & 41.
- PHISALIX, G.—Étude expérimentale du rôle attribué aux cellules lymphatiques dans la protection de l'organisme contre l'invasion du *Bacillus anthracis* et dans l'immunité acquise. (Experimental study of the part attributed to lymphatic cells in the protection of the organism against the invasion of *Bacillus anthracis* and in acquired immunity.)
Compt. Rend. de l'Acad. des Sciences, CXI. p. 685.

* Contemporary Science Series, London, Walter Scott, 1891.

- SMITH, DR. THEOBALD.—**Einige Bemerkungen über Säure u. Alkalibildung bei Bakterien.** (Some Remarks on the Production of Acids and Alkalies in Bacteria.)
Centralbl. f. Bakteriol. u. Parasitenk., VIII. p. 389.
- TISSIER, P.—**Des moyens de résistance de l'organisme contre les infections—De la phagocytose.** (On the methods of resistance of the organism against Infection—of Phagocytosis.)
Annal. de Méd., 1891, pp. 73-5.
- TRENKMAN, DR.—**Die Färbung der Geisseln von Spirillen u. Bacillen.** (The Coloration of the Flagella of Spirilla and Bacilli.)
Centralbl. f. Bakteriol. u. Parasitenk., VIII. p. 386.
- VAUGHAN, V. C.—**A new Poison in Cheese.**
Med. and Surg. Reporter, II. (1890) No. 21, pp. 584-5.
- ZEIDLER, A.—**Beiträge zur Kenntniss einiger in Würze und Bier vorkommender Bakterien.** (Contributions to the Knowledge of some of the Bacteria present in Wort and Beer.)
Wochenschr. f. Brauerei, 1890, Nos. 47, 48, pp. 1213-15, 1237-40.
- ZÜLZER, W.—**Ueber ein Alkaloid der Tuberkelbacillen.** (On an Alkaloid of Tubercle-bacilli.)
Berlin. Klin. Wochenschr., 1891, p. 98.



MICROSCOPY.

a. Instruments, Accessories, &c.*

(1) Stands.

Baker's Student's Microscope.—We give a figure (fig. 53) of the Student's Microscope lately made by Messrs. Baker, to which Mr. E. M. Nelson called attention at the March meeting.†

FIG. 53.

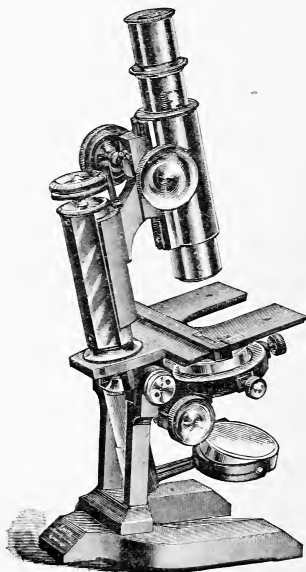

Zeiss's Crystallographic and Petrographical Microscopes.‡—Dr. S. Czapski describes the three latest forms of the Zeiss petrographical model.

The base of the large model (fig. 54) is of the usual horse-shoe form. The body-tube, &c., can be inclined and clamped in any position down to the horizontal. The illuminating apparatus, which is movable by rack and pinion, consists of the condenser and the diaphragm and polarizer holder.

The condenser has a numerical aperture of 1.4 and is movable in a socket, so that it can be easily removed and replaced by other illuminating arrangements, such as

(1) The achromatic condenser, or the special achromatic illuminating apparatus for photomicrography, by which a sharp image of the source of light is projected on the plane of the object.

(2) The Hartnack illuminating apparatus, for monochromatic light.

(3) The Engelmann microspectral objective.

(4) The spectro-polarizer of Rollet.

The polarizer holder carries the iris-diaphragm next to the condenser, and has the nicol P beneath. It is rotated by rack and pinion R, and the positions of 0° , 90° , and 180° are marked by a stop. To convert from polarized to ordinary light, the holder is simply pivoted aside (as represented in fig. 55).

* This subdivision contains (1) Stands; (2) Eye-pieces and Objectives; (3) Illuminating and other Apparatus; (4) Photomicrography; (5) Microscopical Optics and Manipulation; (6) Miscellaneous. † See *ante*, p. 295.

‡ Zeitschr. f. Instrumentenk., xi. (1891) pp. 94-9 (3 figs.).

The circular stage, graduated in degrees, is about 120 mm. in diameter, and is rotated by hand. For the orientation of the object, it is provided with a millimetre scale (100 mm.) along two diameters at right angles, and the diameters inclined to these at 45° are also provided with a division. The upper part of the stand is of the same form as in other

FIG. 54.

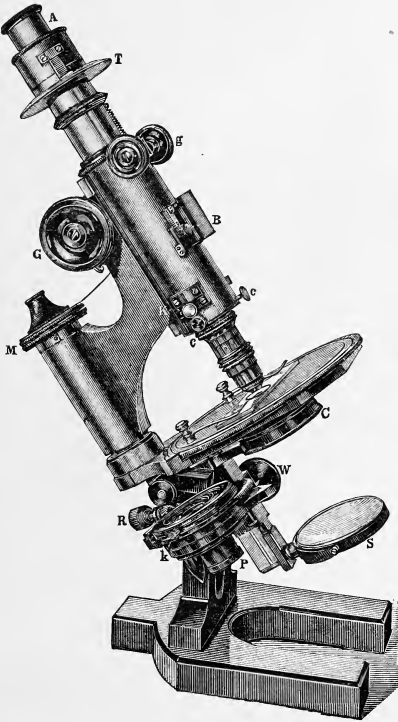

Zeiss models. The lower part of the body-tube has a centering arrangement *cc* provided with the Society screw. Near the end of the tube is a side opening in which slides a frame by means of the knob *K*. In the frame are two apertures side by side, one of which serves for the reception of a quartz plate, quarter-wave plate, &c., while the other usually remains empty, but may be used to receive a second plate. The draw-

tube is movable in the body-tube by rack and pinion *g*, and has a millimetre division giving the total tube-length. The eye-piece, which is provided with cross wires, is placed in the draw-tube from above. Above the eye-piece the analyser A (Hartnack-Prazmowski prism) is

FIG. 55.

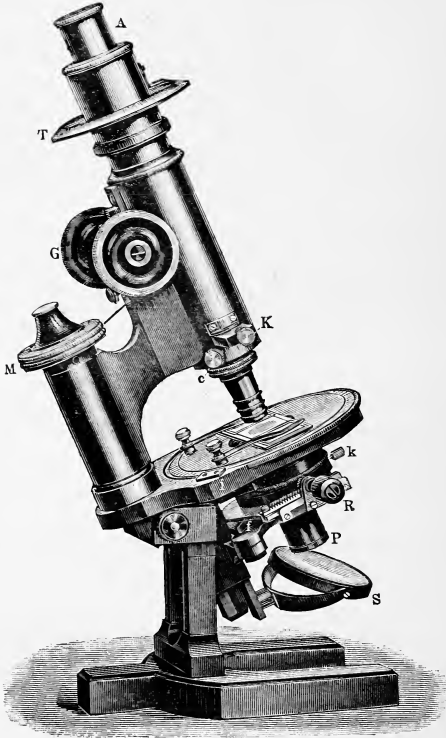

applied, the mounting of which carries an index showing the orientation of the analyser on the divided circle T.

For observing the optic axial figures in convergent light, an Amici auxiliary objective can be applied by the knob B through an opening in the outer tube, and fitted into a slot at the lower end of the draw-tube.

The eye-piece forms with this objective an observing Microscope,

which can be adjusted on the optic axial figure by means of the rack and pinion of the draw-tube.

Fig. 55 shows the medium size model which is generally similar to the preceding. It differs from it only in being of smaller size, and in having no Amici auxiliary objective. Instead it is arranged for the "axial image eye-piece," and consequently has no draw-tube.

The small model is of the English tripod form. The polarizer and condenser of aperture 1.0 are fastened in one socket, and can be rotated by an arm. When drawn down in the socket a few millimetres, so that the condensing lens comes beneath the stage-plate, they can be shifted to one side by a lever. The stage is movable, and is provided with a divided circle. The body-tube can only be moved by rack and pinion, but the mechanism is sufficiently rigid to allow of the use of objectives, up to a focal length of 4 mm. At the upper end of the tube is a divided circle for the analyser, and at the lower end are the centering arrangement and the slit for the Biot-Klein quartz plate.

(2) Eye-pieces and Objectives.

New Objective Changer.*—The firm of Klönne and Müller have recently brought out an apparatus which is intended for the rapid and easy substitution of objectives. The apparatus is constructed something like a pair of pincers, the upper limb of which screws on by means of an arrangement like that of the ordinary revolver nose-piece to the Microscope-tube. From the under side of this upper limb a conical piece, which is encircled by the adapter-ring screwed on to the objective, projects downwards.

The two limbs of the apparatus are kept firmly together by means of a spring. In order to insert or change an objective it is merely necessary to press the limbs together and then put the objective into the half-collar of the lower limb.

The apparatus can be used in any position of the Microscope, and can be fitted with a centering arrangement.

(3) Illuminating and other Apparatus.

On a new arrangement in Microscopes for the rapid change from parallel to convergent light.†—Herr R. Brunnée, of the firm of Voigt

FIG. 56.

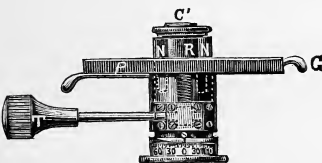
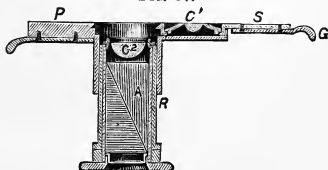

FIG. 57.



and Hochgesang, in Göttingen, has devised a method for the rapid change from parallel to convergent light, which he claims to be superior

* Central-Ztg. f. Optik u. Mech., xii. (1891) p. 46 (1 fig.).

† Zeitschr. f. Instrumentenk., xi. (1891) p. 136.

in simplicity and convenience of use to any other. In the plate P (figs. 56 and 57), by which the polarizer is connected with the instrument, is a slide S' , which, as soon as the tube R is lowered by the pinion T, has the effect of raising the lens C' from the lens C^2 . A pull on the arm G is then sufficient to move the lens C' to one side into a depression in the plate P, and the polarizer, thus left only provided with the lens C^2 , can be again adjusted in height and used for parallel light. To change again to convergent light, the tube R is lowered and the slide S pushed in, when the two lenses will again be connected together by means of the conical piece of the lens-holder C^2 . To assure the correct position of the lens C' in the ring of the slide S, the tube R is provided with four slots, in which fit four corresponding projecting pieces in the ring.

Kochs-Wolz Improved Microscope Lamp.*—The modifications introduced into the Kochs-Wolz lamp† are declared by Prof. P. Schiefferdecker, who describes the improvements, to make it an ideal lamp for microscopical purposes. The principal deviation from the original consists in a different form and method of illumination.

In the present lamp a cylinder of zirconium is rendered incandescent by the combined action of an oxygen and coal-gas flame. The essential parts are fixed to a stand consisting of a heavy base supplied with a grip-handle and a vertical upright MS (fig. 59), up and down which they may be moved by means of a rack-work, the milled head of which is seen at SS. Within the metal case MC is fixed the zirconium cylinder LK, against the middle of which plays the flame from the burner B. The burner is connected with two tubes Sr and Gr, through which the coal and oxygen gases pass. Both these tubes can be stopped off by the cocks Sh Gh. The glass rod G is fixed in a tube-like pro-

FIG. 58.

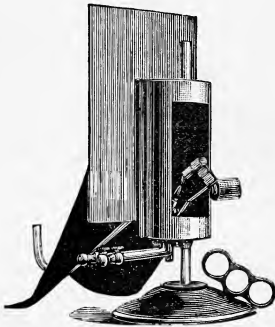

longation on the front of the metal case MC, its inner end lying over-against the zirconium cylinder, while its outer end, bent to a convenient curve, lies underneath the diaphragm of the Microscope. In order to intercept any heat or light from the lamp, a blackened screen Sch is placed in front, and from the lower end of this a dark cloth T hangs down over the glass rod. The correction glasses are cemented on to the outer end of the rod. To set the apparatus going the gas-jet is turned full on, lighted, and then the oxygen-tap turned on until the flame just hisses. When the zirconium is white hot, the tap is turned down carefully till the hissing ceases.

* Zeitschr. f. Wiss. Mikr., vii. (1891) pp. 450-7 (2 figs.).

† See this Journal, 1889, p. 126.

One of the chief advantages of this lamp is the facility with which the intensity of the light is graduated, an advantage which, coupled with the fact that it preserves the natural colours of pigments, renders it even superior to daylight.

If this lamp is to be used in conjunction with an Abbe condenser, then instead of the curved glass rod a straight and very thick one is used. The outer end is adjusted about 9–10 cm. from the centre of the concave mirror, so that the light may fall on the very middle—a procedure much easier in practice than might be expected.

FIG. 59.

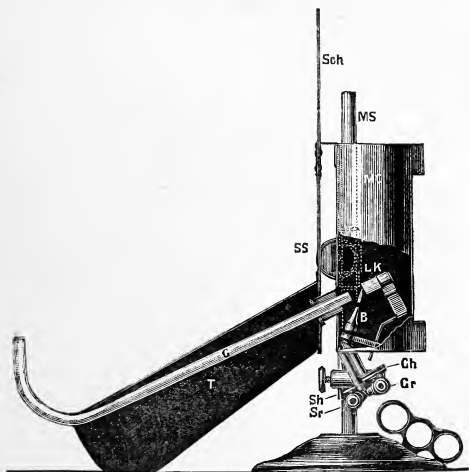

In a further communication * Prof. P. Schiefferdecker adds that the zircon cylinders have lately been rendered so much more durable that no cracking need be feared. It is advisable to use no more light than is absolutely necessary, otherwise the images are less well defined and the eye becomes fatigued. The glass rod should not be placed immediately beneath the diaphragm opening, but somewhat lower; and this is especially necessary when delicate colourless objects are under examination. Finally, new tubing should not be used for conveying the gas, since the dust which it usually contains will have the effect of partially stopping up the burner.

New Hot Stage and Accessories.†—Prof. W. Pfeffer describes a hot stage which keeps the temperature of the object and its environment

* Central-Ztg. f. Optik u. Mechanik, xii. (1891) p. 137.

† Zeitschr. f. Wiss. Mikr., vii. (1891) pp. 433–42 (4 figs.)

more constant than the ordinary apparatus. The general arrangement of the whole may be gathered from figs. 60 and 61. The water receiver is a rectangular box about 110 mm. long, 70 mm. broad, and 35 mm. high, and covered over with a glass plate *g*, perforated with three apertures for the Microscope, thermometer, and regulator. In this is placed

FIG. 60.

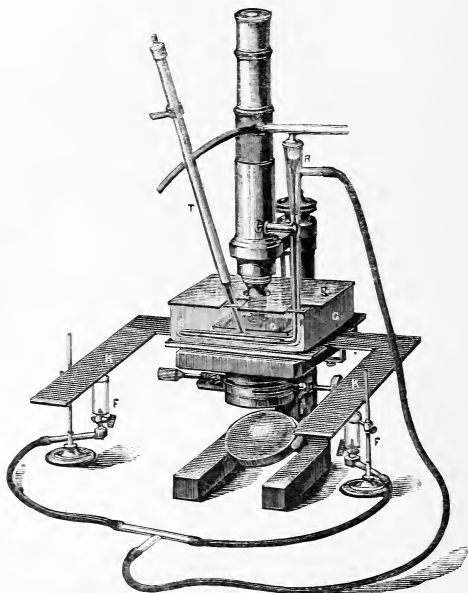

General arrangement of the apparatus when in working order.

the slide *o*, raised above the bottom from 4 to 8 mm. by strips of glass. The water is warmed by means of a copper plate *k*, heated by gas-jets *f*, the flame of which is regulated by a Stricker's regulator *r*. The pieces of vulcanite *c*, fig. 61, upon which the copper plate rests, are 3-4 mm. high, and are fixed on to the stage by the screw-clamps *e*. The thermometer *t* and the regulator *r* are kept in position by means of a stand (not shown in the illustration) to which they are clamped.

The light from the mirror is made to pass through a circular aperture in the copper plate, and then through the bottom of the glass trough on to the object. The bottom of the object trough at this part is polished on both sides. For observing the object a water-immersion lens is he

most appropriate and convenient, but if a dry lens is to be used then the objective is surrounded by a conical glass or metal case *n*, fig. 61, to the end of which a cover-glass is cemented on. The case is adjusted to the objective by packing it on with cotton-wool. For

FIG. 61.

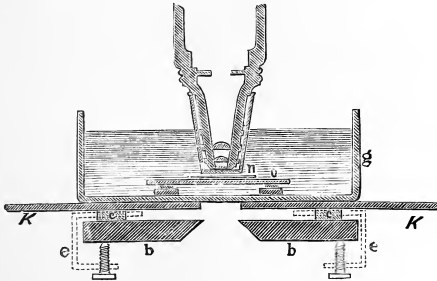

Vertical section through the objective, the water vessel *g*, the slide *o*, copper plate *k*, and Microscope-stage *b*. At *e* are shown the clamps, but these really lie in a different plane. About two-thirds natural size.

constructing an air-chamber suitable for most purposes, the author uses a couple of slides with central circular apertures. When these two slides are fixed or cemented together, and closed in above and below with a cover-glass, a fairly large air-chamber is obtained. If renewal of

FIG. 62.

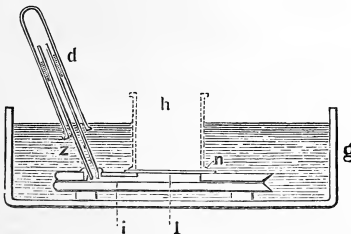

Vertical section through the water-vessel, as in fig. 61, showing the moist chamber with air-passage through *z*. The glass tube *b*, drawn in dotted line, is only used when the object is to be inspected through air. About two-thirds natural size.

the air be required, this is obtained in the manner depicted in fig. 62. A glass tube *z* communicates with the air-chamber by means of a passage *i* ground out of the uppermost slide. The tube is protected by inverting over it a test-tube.

The examination-chamber may be made of variable sizes by the method shown in fig. 63. Two cover-glasses separated by caoutchouc rings are fixed together by nickel plates with central circular apertures, and these plates are kept in position by the clamps *a*.

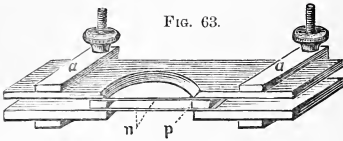

Chamber made with nickel plates. Bisected; natural size.

The temperature of the water-bath was found not to vary more than 0.1° C. in 12 hours when the water was kept throughout at 50° C.

Pfeffer's Water Thermostat.*—Prof. W. Pfeffer describes a water thermostat which, as it maintains a very constant temperature, is very

FIG. 64.

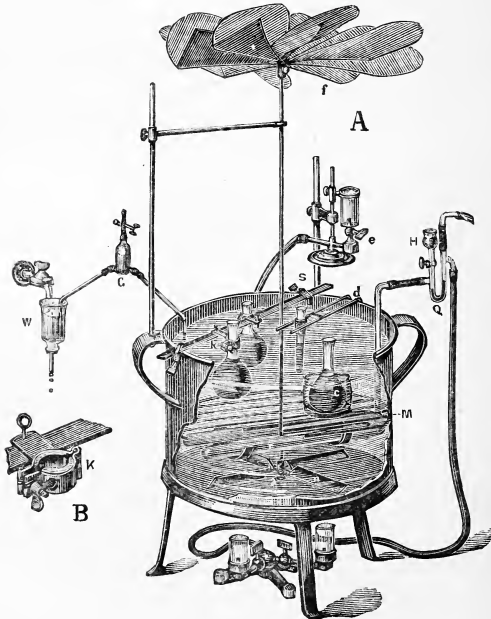

* Zeitschr. f. Wiss. Mikr., vii. (1891) pp. 442-7 (1 fig.).

useful for bacteriological and other purposes. The water-vessel, to hold 10-40 litres, is made of enamelled iron. Near the bottom is a floor made of brass bars *M*; beneath this is the U-tube, filled with 30 per cent. chloride of calcium solution, and the regulator *r*, which stops off access of gas to the flame in the usual manner by means of mercury.

An equable temperature of the water is effected by the working of the four scoops *n* driven by the fans *f*, which are set in motion by a gas flame *e*. The connecting-rod between the fans and the scoops is pivoted in an agate cup *a*. The water is maintained at a constant level by means of a siphon apparatus.

Flasks are fixed in position within the thermostat by means of the clamps shown in fig. B, or placed on the floor *M*, as at *c*. Test-tubes may be suspended by the device shown at *d*. Here they are placed in a cork which is jammed in between the two parallel bars.

Over the air thermostat this water thermostat possesses these advantages:—the cultivations are more rapidly brought up to the temperature of the surrounding medium, the water temperature is but little altered on the insertion or removal of the flask, and a greater constancy of temperature is attained.

(4) Photomicrography.

Baker's Photomicrographic Apparatus.—This apparatus, as recently supplied to Mr. Andrew Pringle, is shown in fig. 65. It consists of a substantial teak base-board 6 ft. 11 in. long, and 1½ in. thick, on which the camera with its support is placed, the other end carrying a teak-wood turntable clamping to the base. On the turntable a quadrangular metal frame is fixed, having a metal trestle to support the upper end of the limb of the Microscope when in the horizontal position, and two clamp-screws are fitted to receive the front feet of the Microscope. By this arrangement the instrument readily serves both purposes, either for ordinary observations or for photographing, the attachment in the latter case being easily and rapidly effected. The compound bull's-eye condenser, with centering adjustments, is carried by a pillar attached to the turntable; and beyond this is a support for the oxy-hydrogen lamp which is furnished with the usual mechanism for regulating the position of the lime-cylinder.

The Microscope is that known as the Nelson model, having the differential-screw fine-adjustment with actuating milled head at the lower end of the limb. It has a graduated rotating mechanical stage, and rackwork centering substage with differential-screw fine-adjustment. The body-tube is 150 mm. long, with racked draw-tube and an extra sliding draw-tube extending to 300 mm. An adapter with Society screw is fitted to the sliding draw-tube to allow the use of low-power objectives without racking the body-tube too far from its normal bearings, by which method the field of the objective is not cut off by the body-tube. The nose-piece is removable. The camera can be used at any length from 6-50 in.; it is provided with an exposure shutter and with a connecting tube sliding easily into a cap fitting on the eye-piece end of the Microscope. The camera can also be moved laterally and clamped to the base-board.

Focusing-rods run the whole length of the base-board, and con-

FIG. 65

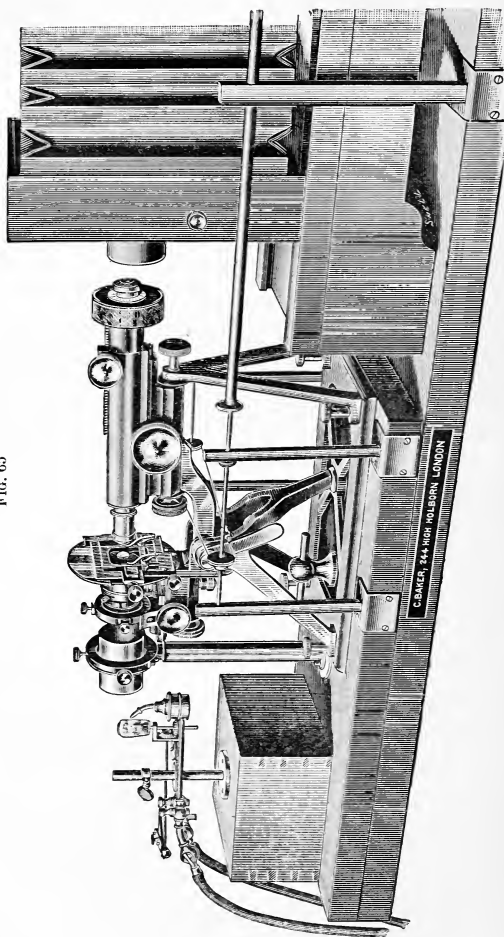

BAKER'S PHOTOGRAPHIC APPARATUS.

nect readily with the milled head of the fine-adjustment by means of a silk cord.

We are requested to note that in the woodcut the apparatus appears reversed from right to left.

(6) Miscellaneous.

A Method of Drawing Microscopic Objects by the Use of Coordinates.*—Dr. Cooper Curtice writes:—"The method which I am about to detail is one that I found in use by Dr. George Marx, of the Division of Illustrations, in the U.S. Agricultural Department, when I first engaged studying animal parasites in 1886, but it was originated some eight years earlier, as he informs me.

It is a method that has such obvious merits that I take pleasure in placing it before students of the Microscope, but I present it as a relater of a valuable method rather than of original work. Its simplicity, its cheapness, its accuracy, the ease with which a figure of any magnification or reduction may be made, and the rapidity with which a beginner adapts himself to its use, all serve to recommend it.

A small glass slide, of the size of an eye-piece micrometer, or a disc ruled into squares, is inserted into the eye-piece, so that the lines seem to rest upon the object. Tracing-paper is placed over cardboard ruled into squares. The drawing is then made freehand, the various points located in a symmetrical position with respect to the lines underlying the paper that they occupy in the apparently ruled image. The drawing made on the tracing-paper may then be either transferred to drawing-paper without reduction or be reduced by applying the same methods that produced the picture, and then be worked up.

Dr. Marx prefers using the slide. It is ruled into squares 1 mm. on each side, every third line being slightly deeper, to make it prominent. I prefer for most uses the finder made by Zeiss. It is a circular disc, upon the centre of which are ruled two sets of ten lines at right angles to each other, the lines being 5/10 mm. apart. The lines are very neatly ruled, and covered by a thin cover-glass cemented to it with balsam.

It is apparent that the system has a wide application, so far as the magnifications to be attained are concerned. The equation giving the magnification is $x = \frac{b}{a} \times c$, a being length of object, b the length of image, c the ratio of the image to the drawn figure.

Suppose that the amplification of objective is $5 \times$; that the lines on the eye-piece slide to 1/2 mm. apart, and those on the cardboard be 6 mm., then $x = 5 \times 6 \times 2$, or 60, for the unit of the card squares is twice those of the eye-piece squares.

To use a series of objectives, or of squares for the eye-piece and for the cardboard, are easy matters. A single glass ruled to half millimetres, made to fit a low-power eye-piece, is sufficient to try the plan. Cardboards, either of Bristol boards or heavy calendered Manilla paper, may be ruled into squares 3, 5, 7 mm., &c., until the student has all the combinations desirable.

By adopting this plan of drawing figures, I have found that objections

* Amer. Mon. Micr. Journ., xii. (1891) pp. 52-3.

which I find to using the camera are avoided. The lighting is not interfered with, the image moves but little, if any, with the movement of the head, and the image cannot be distorted. It is true that the accuracy of the figure depends on the skill of the artist, but a short trial of the method will satisfy most students that the actual variation of the drawing in symmetry from the image is less than that in figures made by the camera.

The objection now existing that American makers have not on hand necessary slides will be gladly removed by them as soon as they see a demand."

Carl Zeiss-Stiftung in Jena.—The following notice is of interest:—
 "By the present official notice the undermentioned firm has the honour to announce that their former proprietors, Dr. E. Abbe and Dr. R. Zeiss, have this day withdrawn from the firm, after having made over, according to agreement, the optical workshops in their entirety to the Carl Zeiss-Stiftung in Jena. The latter enters into all the rights, and accepts all the liabilities of the late proprietors. The firm itself remains unchanged. Dr. E. Abbe has been appointed by the Carl Zeiss-Stiftung as its authorized representative in all matters pertaining to the optical workshops, and to him, in conjunction with Dr. S. Czapski and Dr. O. Schott, the whole internal and external management has been transferred. Power of procuration has been granted to the two last-named gentlemen.—Jena, July 1st, 1891. Carl Zeiss Optische Werkstätte.

Extract from No. 153, 2. Juli, 1891 (2te Beilage) des 'Deutschen Reichs- und Preussischen Staatsanzeigers.' By a decree of His Royal Highness the Grand Duke, the undermentioned institution, inaugurated by deed of May 19, 1889, by Dr. Ernst Abbe, has been by law established, and received the right of legal personality.

The objects of the Institution are:—(1) The cultivation of the branches of scientific industry which, by the efforts of the founder, have been established in Jena by the optical workshops of Carl Zeiss, and the glassworks of the firm of Schott and Genossen; while at the same time attention is paid to the economical maintenance of those two establishments, and to the continued fulfilment of the social duties imposed upon the founders of the institution towards those who belong to it. (2) The advancement of mathematical and scientific studies by research and instruction.

The institution bears for all time the name Carl Zeiss-Stiftung, 'in honour of the man who first laid the foundation for the above undertaking, and in lasting remembrance of his own peculiar merit in having in his field of work always aimed at the co-operation of science and technical skill.' The management of the institution is by law transferred to the Kultusdepartement of the Grand Ducal Ministry of State; its judicial seat is Jena.

To the preceding public announcement must be added the fact that, after the Carl Zeiss-Stiftung had become the proprietor of the optical workshops of Carl Zeiss and co-proprietor of the glass technical laboratory of Schott and Genossen, (a) Dr. Ernst Abbe was appointed as authorized representative of the Carl Zeiss-Stiftung, with right of signing for the firm in all matters pertaining to these two establish-

ments, and Dr. Siegfried Czapski was allowed to act as deputy for him in his functions. (b) Privy Councillor Rothe, in Weimar, was appointed as commissioner of the management of the institution.—Weimar, June 24, 1891. Grossherzoglich Sächsisches Staatsministerium, V. Gross.

In our business register the following entries respecting this day's decree have been made:—in Fol. 49, Bd. 1, for the firm Carl Zeiss in Jena, and under the headings—

(a) Proprietor:—No. 5. The two proprietors named under No. 2 and No. 4, Dr. Med. Roderick Zeiss and Dr. Ernst Abbe, have withdrawn. No. 6. The Carl Zeiss-Stiftung in Jena is the sole proprietor of the firm.

(b) Representative:—No. 2. Dr. Ernst Abbe in Jena is the authorized representative of the Carl Zeiss-Stiftung in Jena, with the right of signing for the firm. No. 3. The power of procuration granted to Dr. Otto Schott in Jena, named under No. 1, has been renewed by the Carl Zeiss-Stiftung. No. 4. Dr. Siegfried Czapski in Jena is procurator.—Jena, June 30, 1891. Grossherzoglich S. Amtsgericht, Abtheilung IV. Dr. Jungherr."

Death of Mr. Mayall.—It is with the greatest regret that we have to announce the death, on July the 27th, of Mr. John Mayall, jun., one of the Secretaries of the Society. His death will be felt as a severe loss wherever the Microscope is studied scientifically. We must postpone till the next number a detailed account of the services rendered by our deceased friend to science, to the Society, and to this Journal.

The late Mr. Tuffen West, F.R.M.S.—Tuffen West, whose death at the age of sixty-eight we have recently had to lament, was one who has had few equals in devotion to natural history, and especially to its microscopic side. He was unrivalled as a draughtsman and a manipulator, and his love for his subject supplied him with never-failing energy. Severe bodily illness had for the last twenty years secluded him from contact with his fellow-workers, and robbed him of that public recognition of his services which he was about to reap. There are, however, still living many who well remember him, and can testify to the importance which was attached to securing his services in the production of any work requiring illustrations. As he was possessed of but a small income, and in the earlier part of his career of none at all, he made his dexterity with his pencil the source of his support. It was not, however, by any means solely for his artistic ability that his collaboration was eagerly sought by authors, for it was well known that he was both able and willing to give help in the most varied directions of scientific and pathological research. Work by others which had passed through his hands not only obtained a very considerable security against error, but not infrequently received important additions and elucidations. His good nature in these matters was occasionally somewhat imposed upon, and papers and books were published which really owed quite as much to the man whose name appeared only as artist, as they did to him who

assumed the rôle of author. In a general way he rendered these services with pleasure and because he delighted in his work, but there were instances of this kind of partnership which he felt to be unfair, and concerning which he would remark with a smile, "My poverty, but not my will, consents."

Tuffen West was the eldest son of a not undistinguished man. William West, of Leeds, his father, was F.R.S., and in a foremost position as a consulting chemist in the northern counties. He was one of the founders of the British Association for the Promotion of Science and of the Leeds Philosophical Society. He was much engaged as a medical jurist in cases requiring chemical knowledge, and it is said that his son's devotion to microscopic work was, when quite a youth, much developed by his being employed in the examination of blood stains in a case of murder which was tried at the York Assizes.

Those interested in tracing the hereditary descent of special faculties may hold it not superfluous to record that William West's father was cousin to Benjamin West, the distinguished President of the Royal Academy. Artistic taste had shown itself also in other members of the family.

West's parents were members of the Society of Friends, and Tuffen was educated at an excellent school at York belonging to that sect. There was a museum in the school, and much attention was given to the study of botany and zoology. The name of its master, John Ford, deserves to be recorded as one to whose kindly assistance Tuffen West, in common with many others, owed much in the development of his early tastes. As a schoolboy he was an indefatigable collector, and every moment that could be stolen from his lessons was devoted to insects, plants, and skeletons. Not far from the bottom of the school cricket-ground ran the Foss, a stream which yielded to the young naturalist uncounted treasures. In connection with this river an anecdote is told which illustrates alike West's habits and his character as a boy. The head-master having found that his boundary rules were often broken, proceeded on one occasion to make inquisition of his pupils. Calling them in succession before him, the question was put, "How many times hast thou been out of bounds during the last fortnight?" Some denied the charge altogether; some owned to once, some to more, but when it came to Tuffen's turn he replied frankly, to the astonishment alike of his comrades and the master, "Please, John Ford, every day."

After leaving school Tuffen West was apprenticed to Mr. Henry Brady, of Gateshead, a surgeon of scientific attainments himself, and who had the singular, possibly unique, good fortune to see three of his sons in succession elected into the ranks of the Royal Society. Although not much is known as to the details of his Gateshead life, it may well be supposed that in such a family a taste for natural science would certainly be fostered. Towards the end of his apprenticeship an accident occurred which put an end to his prospect of a medical career. By some inadvertency in a chemical experiment in his father's laboratory an explosion occurred, and in addition to other injuries Tuffen West incurred the irreparable loss of hearing. Through the whole of his subsequent life he was so deaf that in spite of mechanical aids it was impossible for him to listen to ordinary conversation. This was a terrible

deprivation to him, for it not only excluded him from the profession for the practice of which he had been trained, but it shut him off almost wholly from social converse. This to a man fond both of society and societies, was a most heavy blow. Thrown back on himself, Tuffen West now turned with increased zeal to his Microscope and his pencil. The result was that he rapidly developed unrivalled excellence in the use of both. Neither, however, offered much prospect of remunerative occupation, and for long Tuffen West lived in the most frugal manner. During some years he was engaged in continuous work in connection with the Queen's University at Belfast, and resided there. Subsequently he came to London, where a younger brother was in business as a lithographer, and was able to put scientific work into his hands. He now became well known, and his services were soon in great request. The Transactions of the various learned societies were year after year constantly illustrated by his hand. He was at the time of his first sudden illness in receipt of a good income, and overwhelmed with work. This was twenty years ago, and although he afterwards repeatedly resumed his pencil he was never able to undertake much. He resided during the latter part of his life in a house which he had built for himself in the beautiful neighbourhood of Frensham, near Haslemere. In personal appearance Tuffen West was thought by some to bear a resemblance to our present Prime Minister, Lord Salisbury. He was, however, of slighter build, and the regularity of his features had been somewhat marred by the accident to which reference has been made. He was a man of an affectionate disposition and of singular simplicity of character. He was twice married, but had the misfortune to lose his only son. Although an ardent Darwinian he retained an orthodox creed, and on one occasion protested with vehemence that nothing should ever make him give up his belief in the literal truth of the narrative of Jonah's escape. He took no part in politics; he read but little in poetry or fiction; he was deaf to music; he never in his life handled either rod or gun, nor did he often wear skates or mount a horse. He was, however, an invaluable companion in a country excursion, and could make himself and others happy anywhere if only a magnifying glass and a pencil were at hand. His Microscope and its accompaniments were his invariable companions. He was a diligent note-taker, and his memorandum books were crowded with pencil sketches of the objects which he described. The writer of this was on very intimate terms with him during the busiest part of his career, and often accompanied him in country excursions. On one of these they reached their destination, a lone farm-house close to the sea, a few miles from Hunstanton, near midnight and in darkness. Both were up by daybreak. They met at breakfast. "Well, Tuffen, how do you like the sea?" "To tell the truth, I haven't seen it. I got into a ditch at the back of the house, and I found it so full of interest that I did not go any further." On the same occasion, pockets crammed and arms burdened with specimens, he was stopped while trespassing by a landowner, attended by two gamekeepers. This was a not infrequent occurrence, and West on such occasions was accustomed to oppose to his enemies two deaf ears, with the result of much display of temper on their part and victory with little loss on his. He had a great contempt for the exclusiveness of proprietors,

and took a pride in going wherever he wished. His taste for natural scenery was not probably great, but his determination to secure any botanical or entomological specimen which he coveted was such as no gamekeeper could thwart.

From the nature of his occupations it almost followed as a matter of necessity that West did not do much work in his own name. He had to earn his livelihood in a very ill-paid and most engrossing occupation, and although he loved it in all its branches he yet felt somewhat keenly the fact that it took up all his time. He was accustomed to rise early and to work long into the night, yet his work was often in arrears and his employers clamorous. Nothing that he undertook was ever scamped. Thus it follows that but few original papers are to be credited to his pen. His work stands chiefly in other men's names. A paper on the mechanism of the feet of insects was of his own contributions to science the one in which he took most pride. Four years of his life were devoted to the illustrations of Blackwall's volumes on English spiders, and five to those of Smith on Diatomaceæ.

He was a fellow of the Linnean Society from the year 1861, and also of the Royal Microscopical Society. He was an honorary member of the Zoological and Botanical Society of Vienna, of the Tyneside Field Naturalists' Club, and of the Leeds Naturalists' Club.

Joseph Leidy.*—The following is part of a sympathetic notice of our late Honorary Fellow:—Dr. Joseph Leidy, the eminent comparative anatomist, zoologist, and palæontologist, died at Philadelphia on the 30th of April. He was born in the same city on the 9th of September, 1823. His father was a native of Montgomery County, Pa., but his ancestors on both sides were Germans from the Valley of the Rhine. While yet a schoolboy, minerals and plants were eagerly collected and studied, and also anatomical dissections were begun. He entered the Medical School of the University of Pennsylvania in 1840, and devoted his first year to practical anatomy. Having taken his medical degree in 1844, he became the next year, then twenty-one years of age, prosector to Dr. Horner, professor of anatomy in the university; and at the death of Dr. Horner, in 1853, he was appointed his successor.

In 1844 he made the many remarkable dissections of terrestrial molluses, the drawings of which cover sixteen plates and illustrate thirty-eight species, in Dr. Binney's fine work on the Terrestrial Molluscs of the United States, showing in all not only remarkable power as an anatomist, entitling him to high rank, as Dr. Binney remarks, among philosophical zoologists, but also great skill as a draughtsman. Thus from the first Dr. Leidy was the thorough, minutely accurate, and untiring investigator.

After the publication of Dr. Binney's work in 1845, Leidy was elected a member of the Academy of Natural Sciences of Philadelphia, and from that time he was its most active member, hardly a volume of its publications appearing without one or more papers on the results of his researches. His contributions to zoology and comparative anatomy have a wide range. The lower invertebrates occupied a large share of his time. Besides multitudes of short papers, he published in 1853 a

* Amer. Journ. of Science, xli. (1891) pp. 523-5.

work of sixty-seven pages, illustrated by ten plates, on 'A Flora and Fauna within Living Animals,' of the botanical part of which Dr. Gray said in this Journal, "A contribution of the highest order, the plates unsurpassed if not unequalled by anything before published in the country." In 1879 appeared his large quarto volume on the freshwater rhizopods of North America, containing forty-eight coloured plates, the material of which was in part collected during two seasons in the Rocky Mountain region. As a portraiture of the doctor over the little memberless species, we quote from his concluding remarks:—"The objects of my work have appeared to me so beautiful, as represented in the illustrations, and so interesting, as indicated in their history which forms the accompanying text, that I am led to hope the work may be an incentive, especially to my young countrymen, to enter into similar pursuits. 'Going fishing?' How often the question has been asked by acquaintances as they have met me, with rod and basket, on an excursion after materials for microscopic study. 'Yes,' has been the invariable answer, for it saved much detention and explanation; and now, behold, I offer them the result of that fishing. No fish for the stomach, but as the old French microscopist, Joblet, observed, 'Some of the most remarkable fishes that have been seen, and food-fishes for the intellect.'" He delighted in his work because he knew that there was no fact in connection with the structure and functions of the simplest living things that was not profound and comprehensive, that did not reach up through all species to the highest. The vertebrates described by him were mainly fossil species. Dr. Leidy has the honour of having opened to geological science a general knowledge of the remarkable mammalian fauna of the country, and especially that of the Rocky Mountain region. Species had been before described, but through him the general range of North American species began to be known. In 1847 he published on the fossil horse; in 1850, on the extinct species of the American ox; 1852 and 1854, on the extinct Mammalia and Chelonia from Nebraska Territory, collected during the survey under Dr. D. D. Owen; in 1855 on the extinct sloth tribe of North America; in 1869, on the extinct mammalian fauna of Dakota and Nebraska, a thick quarto volume published by the Philadelphia Academy of Sciences, based on materials that had been gradually and continuously accumulating for the last years; and in 1873, contributions to the extinct fauna of the Western Territories, making the first quarto volume of the Hayden Survey. The last two works mentioned contain over eight hundred pages of text and nearly seventy of plates. Besides these large works numerous short papers from time to time appeared.

Dr. Leidy retired from this field when questions of priority began to start up, it being no part of his nature to quarrel, and having the firm belief, as he said, that the future would award credit where it was deserved. His work among the fossil vertebrates extended also to fishes, batrachians, and reptiles of different geological periods. Dr. Leidy's zeal never flagged; his labours came to an end only with his sudden death. Eight days before it he delivered his last University lecture. Beginning original work before he was twenty, his published papers and larger books continued to appear through half a century, and number over nine hundred. As is well said in one of the many tributes to him

published in the Philadelphia papers after his decease, "He possessed to the end of a long career the freshest capacity of seeing the opportunities and openings for discovery and research offered by familiar phenomena. His vast store of exact and diverse knowledge in the whole wide field of animate nature was under the command of a logical judgment and synthetic powers which saved him from vagaries. These high intellectual powers were served by an untiring capacity for work and equal skill of eye and hand. These are rare gifts; but they are none of them, nor all of them put together, as rare as his character. His simplicity, his transparent sincerity, his ingenuous anxiety to serve science and to serve science alone, his freedom from all desire for the rewards, the honours, and the recognition after which lesser men go a-wandering, were as remarkable as his scientific powers." Never were words more truthful. Honours came to him from all parts of the civilized world, and more because unsought.

β. Technique.*

(1) Collecting Objects, including Culture Processes.

Preparing Tuberculin.†—Herr O. Bujwid prepared tuberculin by cultivating the bacilli in glycerin-bouillon at a temperature of 38° C., after a period of three weeks the cultivation fluid was sterilized thrice, being kept for ten minutes each time at intervals of ten hours at 100° C. The fluid was then filtered and the filtrate inspissated in a water-bath to one-fourth its previous volume. At a pressure of 20 mm. the boiling-point was found to lie between 30°–34° C. A fine precipitate which then formed was filtered off and the fluid further inspissated to the consistence of syrup. Thus obtained, the tuberculin was thinner and lighter than Koch's lymph. Experiments were then made on healthy and tuberculous guinea-pigs: the former bore well the injection of 1/2 ccm., while the latter manifested a general and local reaction. In two lupus patients who had been already treated with Koch's lymph the characteristic reaction occurred after injection of 10 mg., but without any rise of temperature.

The author considers that his tuberculin is about half as strong as Koch's fluid, and does not believe it is a toxalbumin, but is rather inclined to hold that it is a ptomaine, or an intermediate between a ptomaine and an enzyme.

Preparing Pepton-agar for studying Pyocyanin.‡—M. Gessard gives the following ready method for making the pepton-agar so useful in studying the formation of pyocyanin. In each test-tube is placed 0.25 grm. of finely-chopped agar, and then 5 ccm. of neutral 2 per cent. pepton solution and 5 drops of glycerin are added. The tubes are then

* This subdivision contains (1) Collecting Objects, including Culture Processes; (2) Preparing Objects; (3) Cutting, including Imbedding and Microtomes. (4) Staining and Injecting; (5) Mounting, including slides, preservative fluids, &c.; (6) Miscellaneous.

† *Gazeta Lekarska* (Polish), 1891, No. 4. See *Centralbl. f. Bakteriol. u. Parasitenk.*, ix. (1891) pp. 579–80.

‡ *Annales de l'Institut Pasteur*, 1891, p. 65. See *Centralbl. f. Bakteriol. u. Parasitenk.*, ix. (1891) pp. 541–2.

heated for some time to boiling-point in a water-bath in order to drive out the air from the agar. After this they are sterilized for five minutes at 120° C., and allowed to set in oblique position.

Simple Method for sterilizing Catgut.*—Mr. G. R. Fowler sterilizes commercial catgut by boiling it for an hour in 97 per cent. alcohol. The control experiments were made with anthrax and suppuration cocci. It was found that catgut which had been soaked in these germs was rendered perfectly sterile in an hour.

(2) Preparing Objects.

Dehydrating Apparatus.†—Mr. M. B. Thomas writes:—"A very convenient form of Schultze's dehydrating apparatus can be made as follows:—In a 9 × 9 in. Whittall-Tatum museum jar a disc of plaster of Paris is supported about 2 cm. from the top by means of legs made of glass rods (fig. 66, A and C). The disc is perforated to allow tubes of sizes varying from 2 to 4 cm. in diameter to pass through. These are the so-called dehydrating tubes (fig. 66, B). The plaster of Paris diaphragm can be made by first making a mould of the desired size with a paper bottom and a cardboard hoop for the outside. This must be placed on a level surface. The plaster of Paris is then softened with water and poured into the mould to about the depth of 1½ cm. While it is yet soft the three legs can be inserted near the edge, and holes for the dehydrating tubes cut in the disc with a knife, or pressed out with glass tubing of convenient size. When the plaster of Paris is thoroughly dry the hoop can be removed and the disc placed in position in the jar.

The jar is then filled with alcohol to about 2 cm. of the under side of the disc. The dehydrating tubes should be about 12 cm. long, and can be made by cutting off the bottom of large test-tubes. At the bottom is placed a diaphragm of chamois skin, which can be fastened in place by means of a spring made of steel wire, and forced inside of the chamois skin in the tube, thus pressing the former firmly against the latter (D, E). A rubber band around the tubes prevents them from falling through the holes in the disc, and enables them to be lowered to any desired depth in the alcohol.

The tissue to be dehydrated is packed closely in the dehydrating tube, and enough 50 per cent. alcohol poured over it to just cover it. It is then lowered through the hole in the disc until the two liquids are

FIG. 66.

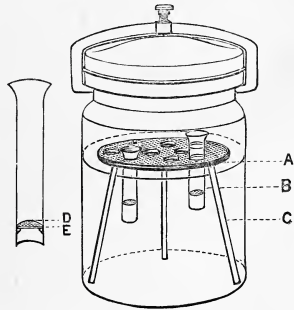

* New York Med. Record, 1890, pp. 177-9.

† Amer. Mon. Micr. Journ., vii. (1891) pp. 7-8.

just at a level. After from 12 to 24 hours the two liquids will be of the same strength. The tissue can then be taken out and placed in the infiltrating bath at once.

This method for hardening has been tried in the botanical laboratory at Cornell University on nearly all kinds of plant-tissue, and in every case it was found to be successful. For the most delicate tissues, where slow hardening is desired, 5 per cent. alcohol can be placed in the dehydrating tube and thick chamois skin used for a diaphragm, and for some of the more delicate algae it has been found advisable to use as low as 1 per cent. alcohol in the tube. The strength of the alcohol in the jar can be kept up by adding to it from time to time some calcium chloride. This will not injure the alcohol in the least.

The jar should be tall enough to allow the cover to be kept on while the tubes are in position, and thus prevent evaporation of the alcohol. An apparatus of such a form, having thirteen dehydrating tubes, has been in constant use in the botanical department for a year without changing the alcohol, and is yet in good working order.

Experiments have been made with one of smaller size, and it is found that all hardening agents, such as picric, chromic, acetic, or osmic acid, can be used in it with equal success.

The advantages claimed for the apparatus are these:—Not more than 24 hours is necessary for dehydrating and hardening nearly all kinds of plant-tissue. The apparatus does away with the transferring of the tissue from bottles containing alcohol of different strengths, and as no sudden transition from solutions of different strengths occurs, the tissue is less liable to shrink. The simplicity of the apparatus places it in the reach of all.

Many different materials may be used for a diaphragm, and almost any desired speed of dehydrating obtained. The apparatus can also be made of any size to adapt it for private or general laboratory work.

It would seem that such an apparatus would work equally well for animal tissue, but as yet I have not been able to make an extended trial of it; however, in the case of some insects hardened in it, it was found to be admirably adapted to the purpose."

Method for fixing Preparations treated by Sublimate or Silver (Golgi's Method).*—Sig. A. Obregia gives a method for rendering preparations treated by Golgi's sublimate or silver procedure so permanent that they may be afterwards stained and protected with a cover-glass.

The sublimate or silver preparations are sectioned without any imbedding or after having been imbedded in paraffin or celloidin. In the latter case care must be taken not to use alcohol weaker than 94 or 95 per cent., at any rate for the silver preparations. The sections are then transferred from absolute alcohol to the following mixture:—1 per cent. gold chloride solution, 8–10 drops; absolute alcohol, 10 ccm., which should have been made half an hour previously and exposed to diffuse light. After the sections are deposited therein the vessel containing them is placed in the dark. The silver is gradually replaced by gold, and

* Virchow's Archiv, cxvii. (1890) pp. 387 *et seq.* See Zeitschr. f. Wiss. Mikr., viii. (1899) pp. 97–8.

the mercury changed into gold amalgam. Finally, black delicate designs appear on a white field. According to the thickness of the section, the fluid is allowed to act for 15 to 30 minutes, but even longer is not harmful. Thereupon the sections are quickly washed first in 50 per cent. alcohol, then in distilled water, and finally in a 10 per cent. solution of hyposulphite of soda, in which, according to their thickness, they remain for 5 to 10 minutes. A longer immersion bleaches too much, so that the finer fibres disappear. Last of all they are thoroughly washed in distilled water twice renewed.

Sections thus fixed can afterwards be stained by any method—e. g. Weigert's, Pal's, &c.—after which they are cleared up with creosote, imbedded in dammar, and protected with a cover-glass.

Throughout the procedure the sections must be manipulated with glass instruments, and not allowed to touch any metallic substance.

Decalcification of Bone.*—In discussing various methods for decalcifying bone, and after indicating the shortcomings of the different solutions, most of which have been in vogue for a long time, Dr. R. Haug points out the advantages of phloroglucin in combination with acid. The introduction of this reagent was due to J. Andeer, who used it with a solution of hydrochloric acid.† According to the author this method was not altogether satisfactory, since the results were not invariable. By substituting nitric acid for hydrochloric a decalcifying fluid is obtained which effects its purpose very rapidly. Days and hours are only required where formerly weeks and months were necessary, and this without any damage to the tissues generally.

The solution is prepared by warming 1 grm. phloroglucin in 1 ccm. of pure non-fuming nitric acid (sp. gr. 1.4). This must be done slowly and very carefully, with slight agitation. After a very lively reaction a clear, dark ruby-red solution is obtained. To this combination of nitric acid and phloroglucin, which may be called nitrate of phloroglucin, 50 ccm. of water are to be added. In order to obtain a sufficient quantity of decalcifying fluid, to this stock solution 50 ccm. of water and 10 ccm. of acid are again added, and further additions of like percentages of water and acid may be made until the quantity reaches 300 ccm., which is the limit of the protective influence of the phloroglucin. Of course, if a further quantity of the decalcifying fluid be required, a fresh stock of solution must be made, and so on.

Fœtal or young bones of lower Vertebrata are completely softened in half an hour; older and harder bones, such as femur, temporal bone, &c., require a few hours. Of course, the pieces are small and the material previously washed. For teeth the amount of acid may be increased to 35 per cent.

When sufficiently decalcified, the preparations are to be placed in running water for about two days, in order to thoroughly remove all traces of acid. The after-treatment is as usual. If a less rapid decalcification be desired, the following formula suffices to give very good results:—Phloroglucin, 1; nitric acid, 5; alcohol, 70; distilled water, 30.

Other decalcifying methods are also discussed by the author; these

* Zeitschr. f. Wiss. Mikr., viii. (1891) pp. 1–11.

† See this Journal, 1897, p. 504.

are those most in use, and it will not be necessary to recount them. But it may be useful to give the formulas of solutions made with hydrochloric and nitric acids:—Hydrochloric acid, 2·5; alcohol, 500; distilled water, 100; sodium chloride, 2·5. A variation of the preceding is:—Hydrochloric acid, 1·5; alcohol, 70; distilled water, 30; sodium chloride, 0·5. These solutions decalcify somewhat slowly, but the structural relations of the tissue are well preserved.

The formula for the nitric acid combination used by the author is:—Nitric acid (sp. gr. 1·5–1·2), 3–9; alcohol, 70; distilled water, 30; sodium chloride, 0·25. This solution decalcifies rapidly, but without destroying the tissues, and may be used for bone of all ages and densities. Its action may be hastened by using an incubator. Preparations stain remarkably well after this method.

Demonstrating Mucin in Tissues.*—From a very thorough examination Herr H. Hoyer shows that the mucin in mucous glands of goblet-cells of Vertebrata and Invertebrata can only be demonstrated by the basic anilin dyes, the acid salts having no effect. The various carmine solutions behave like the acid anilins, and the aluminated hæmatoxylin solutions like the basic.

Double staining with methylen-blue and triamido-benzol, known as Bismarck or Vesuvium brown, are found even in dilute solution to impart a deep stain very resistant to alcohol; other pigments named as giving satisfactory results being methylen-green, dimethylphenylen-green, metamidomalachit-green, and safranin. This last produces a metachromatic staining of the mucin, imparting thereto an orange colour, while the tissue and nuclei are red.

Another pigment giving excellent results is thionin or Lauth's violet, a derivative of indamin containing sulphur. To the tissue Lauth's violet imparts a bright blue colour, while the mucinous elements are red-violet.

For demonstrating mucin the author treated fresh pieces of tissue for two to eight hours with 5 per cent. sublimate solution, and then with 80 per cent. spirit. After imbedding in paraffin and cutting the tissue, the sections, stuck on a slide, were stained with dilute watery solution (2 drops of a saturated watery solution of the pigment to 5 ccm. of water) for 5 to 15 minutes. Other details relative both to the pigments and to the technique are given.

Preparing and Examining Glandular Epithelium of Insects.†—Dr. V. Grandis recommends insects, and especially *Hydrophilus*, for studying glandular epithelium during secretion. After the animal's legs and wing-cases have been removed a cut is made down the whole length of the back, and then two others perpendicular to the first, one on either side. In making these incisions care must be taken not to tear the abdominal air-sacs or the tracheæ. The animal is then laid on a piece of cork, in the centre of which is a circular hole with a diameter of about 1 cm., on the under side of which is cemented a cover-glass,

* Arch. f. Mikr. Anat., xxxvi. (1890) pp. 310–74. See Zeitschr. f. Wiss. Mikr., viii. (1891) pp. 67–70.

† Atti R. Accad. Sci. Torino, xxv. (1890) pp. 765–89 (8 pls.). See Zeitschr. f. Wiss. Mikr., viii. (1891) pp. 86–7.

and it is so disposed that the abdomen lies in the cell. The lymph flows into the cell, and after adding to it some 0·7 per cent. salt solution, the viscera are placed therein, and the intestine, having been spread round the edge of the hole, is fastened down with needles. By this means the Malpighian vessels can be observed in the living condition.

To iodine-green they behave during life in a manner quite different from that after death. In the first case the nucleus does not stain at all, while the protoplasm assumes a purple-violet hue. After death the nuclei, which have then acquired an acid reaction, stain green, and the protoplasm bluish-green. Another differential stain is the Ehrlich-Biondi solution, which colours the nuclei green and the protoplasm orange. The other stains mentioned imparted a diffuse coloration or were otherwise imperfect.

Preparing and Staining the Ova of Chironomus.*—Herr R. Ritter obtains the ova of *Chironomus* from the water in which they have been laid during the twilight. The secretion which holds the eggs together swells up into a gelatinous mass. The egg-mass is then killed with hot 30 per cent. alcohol to which some sublimate has been added, and afterwards treated successively with 70, 90, and 100 per cent. spirit. It is then imbedded in paraffin after having been soaked in chloroform.

The author succeeded in staining the ova (a very difficult task) by placing the whole egg-mass for at least four days in picrocarmine, the transference from the absolute alcohol to the staining fluid being made very gradually. The sections may be contrast stained with hæmatoxylin.

Preserving Larvæ of Lepidoptera with their Colour.†—Sig. F. Crosa places the caterpillars in a 5 per cent. solution of chloride of zinc, and then heats the fluid almost to boiling. This hastens the process and prevents putrefaction. The objects are then placed successively in 10, 15, 20 per cent. solutions of the same salt, and remain therein until they sink to the bottom. For a caterpillar of medium size eight to ten days are necessary. After the last solution they are placed in glycerin. The zinc chloride must be perfectly neutral and contain no trace of iron salts. For this purpose commercial zinc is dissolved in pure hydrochloric acid, taking care that the zinc is always in excess, in order to prevent the formation of iron chloride; afterwards it is filtered. If commercial zinc chloride be employed, this is dissolved in water acidulated with hydrochloric acid and then boiled for some time with zinc.

It is advisable that before the treatment is commenced the caterpillars should be made to fast, and that they should be killed with chloroform. It is stated that, prepared by this method, caterpillars retain their colours (even the green and yellow hues) for quite two years, and that they are quite suitable for histological purposes.

Method of observing Pectinatella gelatinosa.‡—Mr. A. Oka states that this Polyzoön is remarkable for the ease with which it can be killed in an expanded condition. When 70 per cent. alcohol is gradually

* Zeitschr. f. Wiss. Zool., l. (1890) pp. 408-27 (1 pl.). See Zeitschr. f. Wiss. Mikr., viii. (1891) pp. 87-8.

† Boll. Mus. Zool. ed Anat. Comp. Torino, v. (1890) No. 85. See Zeitschr. f. Wiss. Mikr., viii. (1891) p. 86.

‡ Journ. Coll. of Science, Imper. Univ. Japan, iv. (1891) pp. 91-2.

poured into a vessel containing the colonies, more than half the polypides die protruded. With such reagents as chloral hydrate or cocain chlorohydrate every polypide dies expanded. Some colonies were fixed with a saturated solution of corrosive sublimate or a weak (0.1 per cent.) solution of chromic acid. Borax-carmine and picrocarmine were chiefly used for staining. Sometimes a whole colony was imbedded.

The development of the polypide within the statoblast was thus studied: a statoblast was hardened in alcohol, and its edge was then cut between two pieces of elder-pith so as to make an opening in the chitinous shell; it was then stained and kept in alcohol until cut. In cutting the statoblast celloidin was indispensable, owing to the hardness of the shell. Fresh specimens were put on a slide after stupefying with cocain. The habits of the colonies may be studied by keeping them in vessels through which water is always flowing.

Demonstrating Tactile Papillæ of *Hirudo medicinalis*.*—In order to show well, says Dr. S. Apáthy, the tactile papillæ of *Hirudo medicinalis*, strong spirituous solutions of sublimate should be added to the water in which the starved animal is kept until it moves no longer. Having been stretched out with pins, 10 per cent. sublimate or 70 per cent. alcohol is poured over it. This makes the tactile papillæ stand out from the smooth ventral surface.

Examining Ova of *Gordius*.†—In examining the yolk-stalk of *Gordius*, Sig. L. Camerano fixed this animal in one-third alcohol or picric acid. Mayer's carmine stained germinal vesicle and spot well. For ova the author recommends as fixative 3 per cent. nitric acid or a mixture of equal parts of absolute alcohol and acetic acid, and as stain, borax-carmine or a mixture of malachite-green and vesuvin.

Study of Nematodes.‡—Mr. N. A. Cobb recommends the following method:—"On capturing a worm with the medicine-dropper, I eject it forcibly into 20 ccm. of concentrated solution of corrosive sublimate, kept at 50°-60° C. by floating it in a porcelain dish on the surface of hot water. If the sublimate solution is much hotter than 60°, the bodies of some species burst. The worms should remain in the hot sublimate solution at least an hour, better longer. When a sufficient number of worms has been captured, pour the sublimate solution, worms and all, into a flat glass dish placed on a black background, and pick out the worms with the aid of a magnifying glass and a fine-pointed medicine-dropper, and put them into the prepared object-glass of a differentiator. Stain and bring into balsam by means of the differentiator. Most of the smaller species stain readily in borax-carmine, which is one of the best of stains for this work. *Oxyuris vermicularis* (adults, not the young) and a number of other parasitic species, however, do not stain in borax-carmine. Mayer's carmine rarely fails to stain these exceptional species. Overstaining is corrected by adding hydrochloric acid to the proper differentiator fluids. I can recommend this method very highly, not

* Zool. Anzeig., viii. (1890) pp. 320-2. See Zeitschr. f. Wiss. Mikr., viii. (1891) p. 81.

† Mem. della R. Accad. di Torino, xl. (1890) pp. 1-19 (2 pls.). See Zeitschr. f. Wiss. Mikr., viii. (1891) pp. 80-1.

‡ Proc. Linn. Soc. N.S.W., v. (1890) pp. 451-2.

only for Anguillulidæ, but also for numerous other groups of the smaller animals and plants."

Mode of Studying Phagocata.*—Mr. W. M. Woodworth found that the best reagent for killing these worms is hot corrosive sublimate; an excess of the salt is added to the saturated aqueous solution, and the whole is heated to the boiling point; by this means a very strong solution can be obtained. A modification of Kennel's process, viz. a cold saturated solution of corrosive sublimate in 50 per cent. nitric acid, was used with entire success. For the study of the intestinal tract, unstained specimens were cleared in clove oil. For staining, Grenacher's alcoholic borax-carmin, followed by differentiation with acid alcohol, proved to be the most useful method. Good sections for topographical study were obtained by staining in this carmin for twenty-four hours, and cutting, in the horizontal plane, sections 30 μ in thickness. With this light staining the nerve-tissue takes none of the colour, and in such comparatively thick sections the finer branches show as white lines against a red background. Orth's picrocarminate of lithium is a valuable reagent for all glandular tissues, as the picric acid brings them sharply out; this is also an excellent reagent for macerating. The osmic-acetic method of maceration was also successful. Isolated living pharynges were killed in hot 1 per cent. silver nitrate for the purpose of demonstrating the epithelium. Depigmenting was accomplished by the use of a 1 per cent. solution of potassic hydrate, which was allowed to act for a few minutes on sections fixed to the slide with Schällibaum's clove-oil collodion fixative.

Study of Rhizopods.†—Mr. S. H. Perry recommends the mounting of testaceous Rhizopods in glycerin-jelly rather than balsam, as the specimens do not become too transparent, and the protoplasm is preserved. Examples should be picked out singly with a fine camel's-hair brush, under powers of from 25 to 125 diameters, and transferred to a drop of glycerin, where they can be kept till required for mounting.

Demonstration of Cilia of Zoospores.‡—Prof. J. E. Humphrey recommends for this purpose, especially in the case of Fungi, a 1 per cent. solution of osmic acid, which is left for a few minutes to fix the spores thoroughly, and then drawn off by means of filter-paper. A staining-fluid is then applied, consisting of a drop of a moderately strong solution in 90 per cent. alcohol of Hanstein's rosanilin-violet composed of equal parts of fuchsin and methyl-violet. This stains both the cilia and the body of the zoospores very quickly and deeply. By this method the author was able to demonstrate that the zoospores of an *Achlya* allied to *A. polyandra* are ciliated.

(3) Cutting, including Imbedding and Microtomes.

Preparation and Imbedding of the Embryo Chick.§—Messrs. S. H. Gage and G. S. Hopkins write:—"An excellent method of preparing blastoderms of the chick, of from 1 to 96 hours incubation, both for

* Bull. Mus. Comp. Zool., xxi. (1891) pp. 6-7.

† Amer. Mon. Micr. Journ., xii. (1891) p. 80.

‡ Bot. Gazette, xvi. (1891) pp. 71-3.

§ Proc. Amer. Soc. Micr., 1890, pp. 128-131.

surface views and for sectioning, is given in Whitman's 'Methods in Microscopical Anatomy and Embryology' (p. 166).

With slight modifications, the method is as follows:—

(1) Break the shell by a sharp rap of the scissors at the broad end; then carefully break away the shell, beginning at the place of fracture and working over the upper third or half.

(2) After removing as much of the white as possible without injury to the blastoderm, carefully turn the yolk into a dish of nitric acid (10 per cent.) deep enough to float the yolk, taking care to have the blastoderm on the under side of the yolk.

(3) The coagulated white should next be removed from the blastoderm by the aid of a brush or feather, and the egg then allowed to remain in the acid from 20 to 30 minutes.

(4) Cut around the blastoderm with sharp-pointed scissors, taking care to cut quickly and steadily. After carrying the incision completely round, float the blastoderm into a watch-glass, keeping it right* side up and flat.

(5) Remove the vitelline membrane by the aid of dissecting forceps and the yolk by gently shaking the watch-glass and by occasional use of a needle.† The yolk can sometimes best be washed off by means of a pipette.

(6) Wash in water (several times change).‡

(7) Colour deeply with carmine or hæmatoxylin.

(8) Remove excess of colour by soaking a few minutes in a mixture of water and glycerin in equal parts, to which a few drops (about 1 per cent.) of hydrochloric acid have been added.

(9) Wash and treat 30 minutes with a mixture of alcohol (70 per cent.) 2 parts; water, 1 part; glycerin, 1 part.

(10) Transfer to pure 70 per cent. alcohol, then to absolute alcohol (95 per cent. alcohol answers every purpose), clarify with creasote or clove oil, and mount in balsam.

For sectioning, blastoderms prepared by this method should be dehydrated, either before or after staining, as is thought best, and immediately transferred to a thin solution of collodion † (2 per cent.), after which they are placed in a thick solution of collodion (5 per cent.) and then arranged for imbedding and sectioning. To accomplish this, the following procedure has been found useful:—

With a camel's-hair brush transfer the blastoderm from 95 per cent. alcohol to a paper box. It is better to fill this box partly full of alcohol (95 per cent.) before transferring the blastoderm to it, as the alcohol partially floats the blastoderm and thus facilitates its removal from the brush. As soon as the blastoderm is safely in the box, remove the alcohol with a dropper (do not try to pour it off, otherwise the blastoderm will curl up), and carefully pour in enough thin collodion to cover the

* We find it more convenient to remove the yolk from the blastoderm when it is kept ventral (or wrong) side up.

† We find that a small camel's-hair brush is the best thing with which to remove the yolk.

‡ We have found collodion more satisfactory, on the whole, than celloidin, and it is less costly. To make a 2 per cent. solution, dissolve 2 grams of gun-cotton in 100 ccm. of sulphuric ether and 95 per cent. alcohol, equal parts of each. For a 5 per cent. solution use 5 grams of gun-cotton instead of 2.

blastoderm to the depth of about 1/2 cm. The box is now placed in a tightly covered jar to prevent too rapid evaporation and the consequent solidification of the collodion. After the blastoderm has remained a sufficient length of time (from one to three or more hours, depending on the size of the blastoderm) in the thin solution, the collodion is removed with a dropper, and the thick solution poured on. After infiltrating sufficiently with thick collodion, 2-10 hours, open the jar and allow a film to form on the surface of the collodion, then fill the paper box with alcohol (60-80 per cent.) and allow it to remain till the collodion becomes firm and tough; 2-4 hours is usually sufficient. Now with a sharp knife a square or rectangular piece of collodion including the blastoderm is cut out and arranged on the cork in any position desired; the block is fastened to the cork, as any ordinary tissue, by simply pouring over it thick collodion, which is hardened by immersing in alcohol (60-80 per cent.) for from 5 to 15 hours.

For holding the corks under the alcohol the following apparatus has been found more economical and convenient than the method of attaching

FIG. 67.

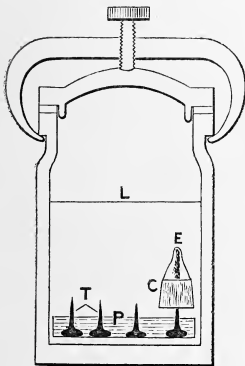

FIG. 68.

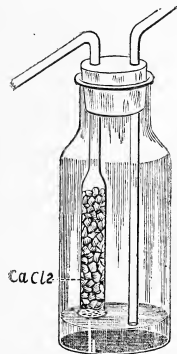

Fig. 67, jar for hardening the collodion of collodion-embedded objects. P, plaster of Paris disc, in which are imbedded the glass tacks. The cork C, on which the embryo E is imbedded, is pushed down upon a glass tack T, and is held in position under the liquid L, alcohol or chloroform, while the collodion is hardening. Fig. 68, ether wash-bottle for blowing ether vapour upon collodion or celloidin sections to fasten them to the slide. The tube of calcium chloride (CaCl_2) is for dehydrating the ether vapour.

weights to the corks. The apparatus consists simply of a glass jar, in the bottom of which are fastened several rows of glass tacks. The materials necessary for its construction consist of a wide-mouthed jar, a few pieces of glass rod, and a little plaster of Paris. The tacks are made by heating the glass rod and drawing it out to a rather sharp

point. It is then cut off at the right length and the cut end softened by heat and then quickly pressed upon some hard surface, so as to form a sort of head. The tacks are then arranged in rows in some shallow dish, previously oiled, and enough plaster of Paris poured around them to form a layer from $1\frac{1}{2}$ to 2 cm. deep. When this hardens, the tacks are firmly held in an upright position, and all that remains to be done is to place the plaster disc in the bottom of the glass jar.

To use the apparatus, fill it partly full of alcohol (60-80 per cent.). As the specimens are imbedded on the corks, transfer them to this jar, sticking each cork upon a tack."

An improved Method of preparing large Sections of Tissues for Microscopic Examination.*—Mr. J. C. Webster writes:—"Hitherto we have employed two methods of preparing large sections for microscopic study, viz. the freezing and the celloidin. In the former the Hamilton or Bruce microtome is used, and in the latter the Schanze. Each of these processes has connected with it certain difficulties which limit the range of its employment.

The objections to the first method are the following:—

(a) It is impossible to prepare delicate or friable tissues in large thin sections, because, after being cut, they either break into pieces when placed in water, or during the mounting process get torn and destroyed. The placenta, for example, cannot be cut into sections suitable for the finest microscopical work, as the villi and the blood-corpuscles in the maternal sinuses are almost entirely scattered when placed in fluid.

(b) The relations of parts cannot be preserved. Thus, for example, one cannot mount undisturbed a section through bladder and uterus, or through brain and membranes.

(c) The difficulties and discomforts connected with the working of a large freezing microtome are considerable.

The objections to the second method are:—

(a) It is impossible to prepare sections thin enough for examination by high powers. Those which can be made are only fit for study with low powers, or for lantern demonstration. This is the case with even the most easily cut tissues.

(b) The microtome employed—the Schanze—is complicated and expensive; its knife is with great difficulty kept sharp, and does not always cut large sections in slices of uniform thickness.

(c) The materials used in preparing the tissues for cutting are expensive.

The method which I am about to describe is not only free from these important objections, but possesses several distinct advantages.

(1) *Preparation of Tissues.*—Tissues may be hardened by any of the known methods, the last stage, however, being a twelve or eighteen hours' soaking in absolute alcohol.

The following method gives splendid results:—

Place the fresh tissue in a boiled saturated solution of corrosive sublimate for one night. Then wash in water, and place for 24 hours in a mixture of one part of methylated spirit and two of water; then in a mixture of equal parts for two days. Gradually increase the propor-

* Rep. Lab. R. Coll. Physicians Edinb., iii. (1891) pp. 266-70.

tion of spirit in the mixture, and at the end of eight or ten days place the tissue in pure spirit, and leave it until it is desired to examine it. A slice is then cut $\frac{3}{16}$ to $\frac{1}{16}$ in. in thickness, and placed for 12–18 hours in absolute alcohol. It is then soaked in pure naphtha for 24 hours. It is then placed in a mixture of equal parts of naphtha and soft paraffin, and exposed to a temperature of about 115° to 120° F. in a water-bath for 18–20 hours. The advantage of naphtha over turpentine is that it dissolves paraffin at a much lower temperature, thereby allowing the water-bath to be kept in such a condition that there is no danger of overheating the specimen. Throughout this process the temperature is kept lower than in the ordinary methods. The advantage of naphtha over chloroform and xylol is its cheapness. It is next placed in melted soft paraffin, and kept in the bath at about the temperature mentioned above for 24 hours. Then it is changed to a mixture of one part of soft and four or five parts of hard paraffin for the same length of time at a higher temperature. Care must be taken that the thermometer does not rise above 140° F.

(2) *Imbedding*.—Paper on thin cardboard boxes, about 1 in. in depth, and slightly more than large enough to hold the tissue, may be used. Nearly fill with a warm melted mixture of soft and hard paraffin in the proportions already mentioned. This mixture is better than the hard paraffin alone. The sections do not curl up as they generally do when pure hard paraffin is used; they can be cut in a much lower temperature, and they are not so brittle. With a pair of warmed forceps place the piece of tissue in the box, the face to be cut to be laid on the bottom. The paraffin should now almost fill the box which is at once placed in a flat dish of cold water. This is an important step; rapidly cooled paraffin makes a better bed, and is less apt to retain air-bubbles than the slowly cooled material. The boxes are removed from the water after a few hours, and can be kept until it is wished to cut them.

(3) *Cutting of Sections*.—This should be done in a room only moderately warmed. The Bruce microtome is employed. Having removed the box from the block of paraffin, pare away the upper surface of the latter, keeping always parallel with the lower surface, until there is left only the thickness of $\frac{3}{16}$ in. above the tissue. Then place this surface on the microtome plate, gently heating the latter until a thin layer of the paraffin melts. This is then allowed to cool, and the block becomes firmly attached to the plate.

The plate is then screwed to the microtome, and the sections are cut in the usual manner. As the sections are thrown off they are caught in a dry tray. They may be mounted at once or preserved in boxes or bottles in a cool place. Some of the sections will be rolled up, others being wavy or flat. When the sections are very large, I prefer to mount the former; they can be unrolled on the slide over a very gentle heat, without any wrinkling taking place, or without air-bubbles being caught beneath the tissue.

(4) *Mounting*.—A clean dry slide is covered with a thin layer of fixing-fluid by means of a glass rod. The fluid which I have found most suitable is a mixture of collodion and clove oil. The section is flattened out on the slide by a soft hair brush above a very gentle flame.

Excess of fixing-fluid and paraffin can now be wiped from the slide. Staining can be at once proceeded with, or the slides can stand for a time protected from dust.

(5) *Staining*.—Dissolve the paraffin from the section by two or three washings of naphtha, which is allowed to stand on the slide for about a minute. Then wipe the slide, and wash off the superfluous naphtha with methylated spirits.

The following stains give splendid results:—Logwood, logwood and eosin, logwood and Bismarck brown, and alum-carmine. To get the best results with logwood, the following method should be used:—Stain the section for three minutes or more in the Ehrlich's hæmatoxylin solution. Then place it in a bowl of distilled water containing a few drops of hydrochloric acid until it appears of a pale port wine colour. The acid dissolves the stain from all parts save nuclei. Then place in a very dilute alkaline solution (sodium bicarbonate) until it turns blue. The alkali deepens the stain in the nuclei.

If eosin is to be used as a contrast stain, wash the section in water and place it in 1/3 per cent. eosin solution (if Bismarck brown, in a 1/4 per cent. solution) for two minutes. Wash in water, then in methylated spirits, and finally dehydrate in absolute alcohol. Clear up in clove oil or xylol; mount in balsam dissolved in xylol, naphtha, or benzol. It is to be observed that naphtha serves for the early stage of soaking in paraffin, for dissolving the paraffin from the mounted sections, and for dissolving the balsam which covers them.

If it is desirable to stain the tissue *en masse* before cutting, the following method is valuable:—Stain the spirit-hardened tissue for 18-24 hours in a borax-carmine solution prepared as follows:—Add 4 grm. borax to 100 ccm. aq. dest., and heat to boiling point. Add 2½ grm. carmine, and boil for 12 minutes. Allow it to cool, and add an equal bulk of a 70 per cent. solution of alcohol. After allowing it to stand for three or four days, filter.

The now deeply stained tissue is partly decolorized by being placed for 12 or 15 minutes in a mixture of acid. hydrochlor. 4 drops, abs. alcohol 70 ccm., aq. dest. 30 ccm.

It is then placed in methylated spirit for three hours, and afterwards in alcohol for 18-24 hours. Clear up in clove-oil—denoted by its sinking.

It is now ready for the paraffin process, being first soaked in naphtha, &c. When the sections are cut they are fixed on the slide in the usual manner, the paraffin dissolved out with naphtha, and the mounting completed with balsam."

Sections of Staminate Cone of Scotch Pine.*—Mr. Charles E. Bessey sends the following contribution from the Botanical Laboratory of the University of Nebraska to show what can be done by the paraffin imbedding process in cutting and mounting objects which otherwise would fall to pieces. The preparation was as follows in detail:—

The cone was first put into 35 per cent. alcohol for 12 hours. Then successively 12 hours each in 50 per cent. alcohol, 75 per cent. alcohol, hæmatoxylin, 90 per cent. alcohol, absolute alcohol, alcohol and turpen-

* Amer. Mon. Micr. Journ., xii. (1891) p. 56.

tine, pure turpentine, cold paraffin and turpentine. It was then put into warm paraffin and turpentine for 6 hours, then into melted paraffin (50°-55°) for 6 hours. It was then imbedded in the paraffin and cut into ribbons upon a Reichert-Thomé microtome, the sections being 20 μ (1/250 in.) thick. The ribbons were fixed on the slide with white of egg and glycerin. The slide was warmed to melt the paraffin, which was then washed away with turpentine, washed next with absolute alcohol, then 90 per cent. alcohol, then water (distilled), then stained with fuchsin about two seconds, next washed with distilled water, 90 per cent. alcohol, absolute alcohol, and turpentine in succession. Canada balsam in chloroform was then poured over the specimen and the cover-glass laid on. I have given every step taken in the operation. The hæmatoxylin did not penetrate, hence the staining by fuchsin was necessary."

(4) Staining and Injecting.

New Method of Injecting Fluids into the peritoneal cavity of animals.*—Dr. A. F. Stevenson and Dr. D. Bruce describe a method for injecting fluids into the peritoneal cavity without danger of wounding the intestines with the point of the hypodermic needle. The needle is curved, its anterior half being solid, while the posterior part is hollow, the opening being in the middle, i. e. at the junction of the two halves. It may be fitted to any syringe. When using it, the abdominal wall of the animal is pinched up with thumb and forefinger of two hands, and then the needle plunged through until the middle (the opening) is in centre of the pinched-up tissue. Hence when the skin is relaxed the opening of the needle is freely within the peritoneal cavity.

Demonstrating the Cerebral Vessels of Mammalia.†—For studying the distribution of the cerebral vessels of Mammalia at various periods of intra- and extra-uterine life, Sigg. G. Valente and G. d'Abundo found that an aqueous solution, not stronger than 0.5 per cent., of silver nitrate, was more suitable than all other injection masses. By the injection of coloured gelatin the vessels, especially in the embryo, were dislocated from their normal position. This inconvenience is avoided by the silver solution, while at the same time, owing to its penetrating the walls of the vessels, the endothelium and the perivascular lymphatic sheaths are made clear. Brains injected in this way cannot, of course, owing to the precipitation which would ensue, be treated with the ordinary fixative media. After being exposed for twenty minutes to direct light they were at once transferred to alcohol. For staining, Meynert's method was preferred, and it is advised to stain the sections on the slide.

Three useful Staining Solutions.‡—Dr. R. Haug gives three formulæ for staining solutions which are stated to be extremely effective.

(1) Hæmatoxylin in acetic acid-alum. 1 grm. of hæmatoxylin is dissolved in 10 ccm. of absolute alcohol, and this mixed with 200 ccm. of liquor aluminis acetici (German Pharmacopœia—see also "Extra

* Brit. Med. Journ., June 6, 1891, p. 1224 (2 figs.). See also Centralbl. f. Bakteriöl. u. Parasitenk., ix. (1891) pp. 689-90.

† Atti Soc. Scienze Nat. Pisa Mem., xi. (1890) 14 pp., 1 pl. See Zeitschr. f. Wiss. Mikr., viii. (1891) p. 92.

‡ Zeitschr. f. Wiss. Mikr., viii. (1891) pp. 51-2.

Pharmacopœia"). The fluid, at first violet-black, becomes brownish-black in the course of a few weeks, and its maturation may be hastened by the addition of a few ccm. of saturated lithium carbonate solution. It is advised to overstain the preparation with this solution, and to decolorize with hydrochloric acid-alcohol. The sections are then placed in tap water until they become blue. Any contrast dye may be used afterwards.

(2) Alum-borax-carmin with acetic acid-alum. This gives similar but better results than alum-carmin. It is prepared by rubbing up 1 grm. carmin with 1 grm. borax and 2 grm. ammonia-alum, and then boiling this with 100 ccm. of liq. aluminis aceticis for half an hour or longer. It is then decanted, and after 24 hours filtered.

(3) Ammonia-lithium-carmin with ammonium chloratum. This gives a fine deep strawberry red colour in 1-3 minutes. Overstained sections may be differentiated with hydrochloric acid-alcohol. Afterwards they are placed at once in absolute (picric) alcohol. It is prepared by rubbing together 1 grm. carmin with 2 grm. ammonium chlorate, and boiling in 100 ccm. water. When cold, to the solutions are added drop by drop 15-20 ccm liq. ammonii caustici and lithium carbonicum from 0.3 to 0.5. Filter. The solution is ready for use at once, and is very permanent.

Fixation of the Stain in Methylen-blue Preparations.*—Prof. A. S. Dogiel finds that the addition of osmic acid to the picrate of ammonium solution used for fixing methylen-blue is attended with several advantages, not the least of these being that it hardens the tissue just a little, and, secondly, that it stains the medullary sheath of nerves black. The solution is made by adding 1 or 2 ccm. of a 1 per cent. osmic acid solution to 100 ccm. of a saturated aqueous solution of ammonium picrate. The stain is fixed by immersing the preparation for 18-24 hours in the mixture. It is then transferred to glycerin, diluted with water, in which the colour of the nerves will keep for quite a long time. Should it be necessary to impart a consistence to the object so that it may be sectioned, the author uses a greater quantity of osmic acid (25-30 ccm. ammonium picrate solution; 1-2 ccm. 1 per cent. osmic acid). In this solution the object remains for 24 hours, after which it may be imbedded e. g. in elder-pith, liver, &c., and sectioned.

Hints on Preparation of Tumours injected during life with anilin pigments.†—In order to examine sections made from malignant tumours which have been treated by injection with aqueous solutions of chemically pure anilin dyes, it is necessary, says Dr. R. Haug, to adopt a certain procedure. The dyes usually injected *intra vitam* by the surgeon are methyl-violet and methylen-blue. If, therefore, a piece of a tumour injected with these dyes be excised before their absorption, a blue-violet mass is obtained. This mass must be hardened, and for this purpose alcohol must be altogether excluded. Hardening may be effected in Erlitzki's fluid or some other combination of chromic acid salt and copper, or picric acid; better than these is cold saturated solution of sublimate. In this pieces, the sides of which are about 0.75 cm., are left for about 24 hours. The sublimate crystals are removed by

* Zeitschr. f. Wiss. Mikr., viii. (1891) pp. 15-9.

† T. c., pp. 11-15.

immersion in the following solution, which must be renewed until all traces of sublimate have disappeared:—Tincture of iodine, 2; iodide of potash, 1; distilled water, 50; glycerin, 50. After this the piece is placed in pure glycerin, to every 100 ccm. of which 2 gm. of anhydrous sulphate of copper are added. Herein it remains for 24–48 hours. The preparation is then to be imbedded. For this it is first saturated with glycerin-jelly or transparent soap, and then inclosed in pretty hard paraffin; but before this inclosure is made, the object must be immersed merely for a moment in quite absolute alcohol. Instead of inclosing in paraffin the object may be stuck on cork with thick jelly or jammed in liver. While sectioning it is necessary to cover both knife and preparation with a mixture of equal parts of water and glycerin, otherwise the section will be torn to pieces. The sections are then removed to water on a brush. The next step is to contrast stain, and for this purpose some of the various carmine solutions are most suitable. It is advised to place the sections for a quarter of an hour before staining in a saturated solution of lithium carbonate. If a single stain be desired, then alum-carmine or cochineal are suitable; if a double stain, then neutral carmine followed by differentiation with weak acetic acid. The sections are then placed in glycerin and water (equal parts), and then saturated solution of picric acid is added.

The sections are then transferred to pure glycerin and there examined. In successful preparations a triple stain is obtained, and we are enabled to ascertain how the pigment has acted during life, that is to say, what has been its distribution and effect; whether it has penetrated within the vascular channels, among the stroma of the tissue, whether it has obtained access to the interior of the cells, and what action it has had upon the epithelial cells.

Preparing and Staining Sections of Spinal Cord.*—In a contribution to the technique required for spinal cord, Dr. A. Ciagliński enunciates some apparently heterodox opinions, such as the uselessness of hæmatoxylin for staining, and gives with copious details his method of procedure. The spinal cord is to be cut up into pieces 1 cm. long, and these immersed in Erlitzki's fluid (3–4 weeks), or in Müller's fluid (3–4 months). As the former solution is prone to throw down a copper precipitate, the latter is preferred. When sufficiently hard, the pieces are carefully washed in water, and then placed for a day or two in 70 per cent. spirit, and finally for one day in absolute alcohol. Thus dehydrated, the object is immersed for 24 hours in anilin oil, then for 2 or 3 hours in xylol. Then for 20 hours in a mixture of equal parts of xylol and paraffin, and kept at a temperature of 37° C., after which it is imbedded in pure paraffin. The paraffin, which for winter should have a melting-point of 45° C., and for summer of 52° C., is melted over a gas flame. To the first paraffin imbedding are added some drops of cedar oil to make it more elastic, and the preparation left in the oven for 24 hours. The second imbedding is only incubated for 15–20 minutes, and then the preparation is turned out into a watch-glass smeared with glycerin. It is important to know which side is uppermost. The

* Zeitschr. f. Wiss. Mikr., viii. (1891) pp. 19–28.

paraffin is then set in cold water. The sections are then stuck on a slide and placed in a thermostat at 37° C.

The author then stains with safranin and anilin-blue as follows:—After the preparations have been freed from paraffin by means of xylol they are washed with absolute alcohol, and then for half an hour with distilled water. They are then covered with a watery 0·2 per cent. solution of safranin and kept moist by being put inside some glass vessel. After 1–3 days the safranin solution is poured off and the preparations thoroughly washed with distilled water, whereupon they are further stained for 1–5 minutes with anilin-blue (a saturated aqueous solution diluted with an equal volume of distilled water). The deeper the safranin stain, the longer the anilin-blue solution is allowed to act, and *vice versa*. The preparation, having been washed, is then dehydrated, cleared up with oil of cloves, treated with xylol, and finally mounted in xylol-balsam.

By this method the medullary sheath of nerves is stained orange-yellow; axis-cylinders, deep blue; ganglion-cells and their processes, blue; neuroglia-cells and their connective tissue, bright blue; walls of blood-vessels blue, while the elastic membrane and nuclei of the muscular fibres are red; pia mater, blue; white substance of cord, red; grey substance, pale blue; but if any morbid changes have occurred the degenerated parts stain deep-blue.

Manipulating and staining old and over-hardened Brains.*—M. J. Honegger, who has been making researches on the brains of Mammalia, communicates the interesting fact that old over-hardened brains, always provided that decomposition has not occurred before or during hardening, can be rendered perfectly sectionable and stainable by immersing them for several days in water which has been made nearly boiling and is frequently renewed.

For staining brains preserved in bichromate of potash an ammoniacal solution of carmine is very suitable, and the author makes his solution as follows:—The carmine is rubbed up to a thick pap with only just as much ammonia as is absolutely necessary, and having been spread all round the inside of the mortar, is allowed to thoroughly dry, and then finely powdered. After 24 hours' exposure to the air the powder is dissolved in cold water, and thus a very satisfactory staining solution is obtained.

Staining with acid-fuchsin and gold impregnation may also be adopted. In the latter case the sections are kept for 3/4 hour in 1/2 per cent. gold solution in the dark. They are then transferred to water slightly acidulated with acetic acid and exposed to full sunlight, and then kept for two days more in daylight. In this way a strong reduction is attained, and after-darkening quite avoided.

Staining Bacillus of Glanders.†—Herr E. Noniewicz advises a combination of Löffler's and Unna's method for staining *B. mallei*. The procedure, which is stated to give excellent results, is as follows:—The

* Rec. Zool. Suisse, v. (1890) pp. 201–310 (5 pls.). See Zeitschr. f. Wiss. Mikr., viii. (1891) p. 99.

† Deutsch. Zeitschr. f. Thiermed. u. Vergleich. Pathol., xvii. pp. 196–208. See Zeitschr. f. Wiss. Mikr., viii. (1891) pp. 109–10.

sections are transferred from alcohol to Löffler's methylen-blue solution (caustic potash 1:10,000). They are then washed in distilled water and placed in the decolorizing fluid (75 parts 1/2 per cent. acetic acid and 25 parts 1/2 per cent. watery tropæolin O O). The time for decolorizing depends on the thickness of the sections, the thick ones requiring from 2 to 5 seconds, the thin ones much less. The preparations are then thoroughly washed in distilled water; this removes the acetic acid and a good deal of the stain. The sections are then put on a slide, and the water having been removed with blotting-paper, are dried in the air or over a spirit-lamp. Xylol is then dropped on and allowed to remain till the section is quite clear. They may now be examined or mounted in balsam. Oil of cloves, origanum oil, and anilin oil are not to be used. In this way the glanders bacilli are stained almost black, while the tissue is bluish.

Staining Pathogenic Fungus of Malaria.*—Surgeon J. Fenton Evans has found it possible to stain the organisms of malaria with an anilized alkalized solution of rosanilin hydrochloride after treatment with bichromate of potash, and after treatment with dilute sulphuric acid by an anilized alkalized solution of Weigert's acid fuchsin. Another method is the saturation of the tissue with a copper salt, and its reduction by sulphuretted hydrogen previous to coloration with anilized alkalized acid fuchsin.

Characteristics of some Anilin Dyes.†—Dr. C. Vinassa, in a contribution to "pharmacognostic microscopy," communicates the results of a number of experiments made with fifty-one different anilin pigments. These results are displayed in two tables. In the first are noticed the behaviour to acids and alkalis, and the stain imparted to the microscopical preparation. Some of the dyes showed a capacity for double staining, the most noticeable of these being "Solidgrün" and "Deltapurpurin." By these the vessels were stained green and the parenchyma red.

Many other useful staining qualities and characteristics may be gathered from a perusal of the table, but for these the original must be consulted. Table 2 gives the chemical derivation, the peculiar microscopical stainings of the various tissue-elements, and the behaviour as dyes to certain commercial products, such as silk, wool, &c.

(5) Mounting, including Slides, Preservative Fluids, &c.

Mounting Botanical Preparations in Venetian Turpentine.‡—Herr F. Pfeiffer highly recommends Venetian turpentine for mounting botanical preparations, and states that it possesses qualities which render it capable of superseding glycerin-gelatin. On the whole, its manipulation is extremely simple. Sections of firm vegetable tissue are merely transferred from strong spirit (92–100 per cent.) to a drop of turpentine placed on a slide. After the cover-glass has been put on, the preparation can be ringed round. But if the sections are thin, liable to wrinkle up, and are to be stained, then certain eventualities have to be

* Proc. Roy. Soc. Lond., xlix. (1891) pp. 199–200.

† Zeitschr. f. Wiss. Mikr., viii. (1891) pp. 34–50.

‡ T. c., pp. 29–33.

borne in mind. These are, that the preparation while standing dehydration in strong spirit is distorted when transferred to the turpentine; for such preparations, though properly fixed and hardened, will not bear the transference to strong spirit. To obviate these inconveniences the author has adopted the principle of Overton's method.* The objects, already stained, are removed from alcohol to a solution of 100 parts 94 per cent. spirit and of 10 parts Venetian turpentine. The preparation is then placed in an air-tight glass capsule in the presence of chloride of calcium, by which means the turpentine is slowly concentrated by the removal of the spirit and water.

The glass capsules and other vessels employed in the manipulation should have tall sides, e. g. 2 cm. high to 1.5 cm. diameter, and 2.5 cm. high to 2 cm. diameter. The edge inside and out should be smeared with paraffin; this is easily done by just dipping the top of the capsule into molten paraffin and allowing it to set; the width of the paraffin rim should be 3-4 mm. These precautions prevent the turpentine from running up the inside and then down the outside of the capsule.

In these small capsules the object is immersed in the turpentine solution, and then these placed inside a larger closed capsule, the diameter of which is 8-10 cm., and the height 3.5-4 cm. In a few days the object will be found saturated and surrounded by thick turpentine, and suffering from no distortion.

Tissues which crumple up when placed in strong alcohol are treated by Overton's glycerin method. The object is placed in a mixture of 90 parts of water and 10 parts of glycerin; by slowly extracting the water the glycerin is inspissated, and this in its turn is removed with strong or absolute alcohol. The concentration is hastened by using the sulphuric acid exsiccator.

Preparations thus treated may, after 12-24 hours' immersion in spirit, be mounted straight away in the Venetian turpentine. If, however, they will not bear this, the procedure originally noticed must be adopted.

(6) Miscellaneous.

An Inexpensive Reagent Block.†—Prof. J. H. Pillsbury says:—“A frequently expressed need of some convenient and inexpensive block or case in which to place the reagents and apparatus used in the biological laboratory, leads me to describe the form I have used for some time (fig. 69).

It is a plain whitewood block, 15 cm. square and 4 cm. thick. On the upper side of this three grooves are cut, each 1.5 cm. deep. The first is 1 cm. from the edge, and 1 cm. wide. The second is 1 cm. from it, and 3.5 cm. wide. The third is 1 cm. from it, and 2 cm. wide. Into one end there is glued a closely-fitting block 1 cm. long, and in the other end one 5 cm. long, leaving a trough for slides about 9 cm. long. In the place where this last block is glued is bored a hole 1.5 cm. in diam. and 1 cm. deep, into which tightly fits a paper pill-box for covers. The remainder of the block is provided with two rows of five

* See this Journal, 1890, p. 535.

† Amer. Mon. Micr. Journ., xi. (1890) p. 2.

holes, each 2 cm. in diam. and 3.5 cm. deep, for reagent phials. The first groove is used for razor, and the second for pencils, pipette, forceps, &c. The block is easily made, costs very little, is very neat in appearance, and convenient in work."

Microscopic Diagnosis of Citric Acid in Plants.*

—M. E. Belzung states that, according to Schultze, citric acid may be recognized in the ripe seed of *Lupinus luteus* by treating the seeds with alcohol, evaporation, and treating the residue with water; from this solution citric acid can be separated.

The author, however, endeavours to diagnose the acid by means of the formation of citrate of calcium. Young plants were grown in a weak solution of nitrate of calcium, sections of the plant were made, and examined microscopically; after a short time, numerous acicular crystals appeared, which were found to be those of citrate of calcium.

Artificial Preparation of the Sphæroliths of Uric Acid Salts.†—Herren W. Ebstein and A. Nicolaier say that if some uric acid be dissolved on a Microscope-slide in a dilute alkaline solution, and watched with the Microscope, there is, after slight concentration, a formation of round particles of urates varying in diameter from 2–100 μ . These are mixed with needles, either singly or in bundles. As solvents, sodium hydroxide, potassium hydroxide, lithium carbonate, borax, ammonia, and piperazine were used; the best results were obtained by using the uric-acid sediment from human urine.

With the polarizing Microscope between crossed nicols the sphæroliths showed a right-angled, black interference cross, the arms of which lay parallel to the polarization planes of the nicols, and, concentric with the middle point of this cross, coloured interference rings were seen.

Similar sphæroliths were obtained with sodium hydrogen carbonate, so that they may consist either of acid or normal urates.

The interest of such an observation, as bearing on the formation of urinary calculi, is pointed out.

* Journ. de Bot. (Morot) v. (1891) pp. 25-9 (3 figs.).

† Virchow's Archiv, 123, pp. 373-6; see Journ. Chem. Soc. Lond., cccxliii. (1891) pp. 760-1.

FIG. 69.

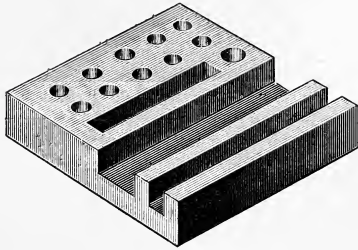

PROCEEDINGS OF THE SOCIETY.

MEETING OF 17TH JUNE, 1891, AT 20, HANOVER SQUARE, W.,
THE PRESIDENT (DR. R. BRAITHWAITE, F.L.S.) IN THE CHAIR.

The Minutes of the meeting of 20th May last were read and confirmed, and were signed by the President.

The List of Donations (exclusive of exchanges and reprints) received since the last meeting was submitted, and the thanks of the Society given to the donors.

	From
De Toni, J. B., <i>Sylloge Algarum</i> , vol. i. pts. 1 and 2. (8vo, Patavii, 1889)	<i>The Author.</i>
Parker, T. J., <i>Lessons in Elementary Biology</i> . pp. xxii. and 408, text illust. (8vo, London, 1891)	<i>The Author.</i>
Monograph of the Palæontographical Society, vol. xlv. .. }	<i>Mr. F. Crisp.</i>
Report of the British Association, 1890 }	
A series of figures illustrative of Geometrical Optics. Reduced from F. Engel and K. Schellbach. By W. B. Hopkins. Text, pp. iv. and 56; atlas, 13 pls. (8vo and fol., Cambridge, 1851)	<i>Mr. J. Mayall, junr.</i>
A slide containing Tubercle Bacilli	<i>Dr. G. H. F. Nuttall.</i>
Woodhead, G. S., <i>Bacteria and their products</i> . pp. xiii. and 459, text illust. (8vo, London, 1891) }	<i>The Publisher (Mr. W. Scott).</i>
Slides (4) of <i>Artemia fertilis</i> , and (1) of desert sand from the Great Salt Lake, Utah	<i>Dr. J. E. Talmage.</i>
Photographs (2) of Diatoms	<i>Mr. B. W. Thomas.</i>

The President called attention to the volumes presented by Dr. J. B. de Toni as being the commencement of a most important work upon the marine algæ. The portion now before them contained one section only—the green seaweeds, every known species of which was fully described. The other two great sections, the red and the brown varieties, would be afterwards dealt with, and the whole, when completed, would form the most valuable work of reference on the subject yet contemplated.

Prof. F. Jeffrey Bell referred to the book, 'Lessons in Elementary Biology,' presented by Prof. Jeffery Parker, of Otago, N.Z., as one likely to be of interest, an extract from the preface being read to show the aim of the author in seeking to assist the amateur microscopist as well as the professional student.

Mr. J. Mayall, junr., said he had much pleasure in presenting to the Society a copy of the English edition of Engel and Schellbach's optical diagrams, together with an explanatory volume by Mr. W. B. Hopkins, which he thought would prove of use to those who were giving attention to the passage of pencils of light through various forms of lenses. The original work was a recognized text-book in Germany and other parts of the Continent; but it had become very scarce and expensive. The English edition did not differ essentially from the original, though the diagrams were reduced in size, and in some cases, where the

rays were symmetrical on both sides of the optic axis, they were figured on one side only. Prof. Schellbach's was recognized as the most perfect work of the kind known.

The President announced the death of Prof. P. Martin Duncan, F.R.S., who, as a past President of the Society, was well known to most of the Fellows on account of the active and efficient manner in which he performed his duties during his occupation of the chair, and was equally well known to others through his great work on the Echinodermata. His sad death occurred on May 29th.

Prof. Bell said that, as the only officer of the Society present who held office during the presidency of Prof. Duncan, he rose to give expression to the regret which he felt at the loss the Society had suffered by Prof. Duncan's death. Prof. Duncan was one of the few remaining naturalists who were not merely specialists. His early contributions to botanical science were succeeded by very important contributions to geology, in which he not only dealt with fossils as such, but also in their relation to the fauna of Australia and elsewhere. The work to which the President had alluded was produced later on. His work as a Fellow of the Society was that of one of the older microscopists who laid great stress upon the use of the lower powers. The appreciation in which he was held was best shown by the fact that the ordinary bye-laws of the Society were suspended in order to keep him in office for a longer period than usual.² Those who knew him personally would regret that there had passed away from among them one whom they could not meet without feeling the happier for the meeting, and it would add to the sorrow of those who thus knew him in health to know that he lay for many months previous to his decease in a condition of almost intolerable suffering. His name would be remembered with affection by all who had come intimately into association with him.

A negative of *Amphipleura pellucida*, recently produced with Zeiss's new 1/10 of 1.6 N.A. and sunlight, by Mr. T. Comber, of Liverpool, was exhibited, and his letter was read suggesting that the want of sharpness was due to the employment of a projection eye-piece for a tube-length of 160 mm., whereas the objective was made for a tube-length of 180 mm. The illumination was axial with a Zeiss achromatic condenser of 1.2 N.A. Mr. Comber thought the resolution showed indications of so-called "beading," and hence he inferred that the ultimate resolution would be shown to be similar to that of its congener *Amphipleura Lindheimeri*. The mounting medium had a refractive index of 2.2, but was very unstable, granulations appearing in a very short time. The negative showed these granulations, though the object had only been mounted two or three days.

Mr. Mayall expressed his surprise at the want of sharpness in the definition, especially as the manipulations were conducted by so careful and accurate a microscopist as Mr. Comber. He regretted that Mr. Comber had not had a projection eye-piece corresponding precisely with the tube-length of the objective, so that his trial of that particular objective might have been regarded as authoritative. This was the more

regrettable from the fact that so few microscopists in England had their photomicrographic apparatus installed for use with sunlight. The difficulties involved in obtaining suitable objects for examination with Zeiss's new objectives of 1.6 N.A. were very great, due, as he understood, to the chemical action of the dense mounting medium on the flint-glass covers. So far the Society had not received a slide of a kind that could be regarded as satisfactory for testing such an objective.

Mr. C. L. Curties exhibited in its finished form Mr. Nelson's apparatus for obtaining monochromatic light, a specimen of *Rhomboides* being shown under a dry 1/6-in. objective.

Mr. Mayall said Mr. Curties had had the apparatus made entirely of metal, and had hit upon an inexpensive design, though the construction seemed rather too light to be steady enough for general use. He thought there was no absolute necessity to employ a high-class photographic lens for projecting the spectrum; any moderately good achromatic lens of suitable focus would answer the purpose. He understood from Mr. Nelson that for observation work with the Microscope the optical combination at the lantern or slit end of the apparatus was not needed, the slit screen being sufficient; but for photomicrography, by means of artificial light, this optical combination was important to increase the light. The apparatus was so devised that the microscopist might employ any prisms or photographic lenses he possessed. He thought the pierced cardboard on which the spectrum was projected would soon warp out of shape, and that it might be replaced with advantage by a metal plate coated white, which would retain its shape. If a prism had to be made specially, one of light crown-glass would probably answer better than the dense flint.

Mr. T. T. Johnson exhibited and described a new form of student's Microscope which he had devised.

Mr. Mayall said the special point was in the application of a screw movement instead of the usual rack-and-pinion to raise and lower the substage, the screw being in the axis of the bearings of the substage and tail-piece, and the actuating milled head projecting slightly at the back of the stage. He thought this was a very economical way of applying focusing mechanism to the substage. The position of the actuating milled head seemed to him most happily chosen for convenience, though it would probably be necessary to make the head larger so as to provide more grip for the finger, as the movement would be certain to become less free in course of time. When he saw the instrument on the previous day he pointed out that the mirror was connected with the substage and went up and down with it; this defect had since been corrected. He thought this substage adjustment would commend itself to notice, and that if it was not already registered it would certainly be taken up by other opticians for the less expensive forms of Microscopes. It seemed to him that Messrs. Johnson had undoubtedly "scored 1" by bringing out this screw-focusing arrangement for the substage.

Mr. W. Johnson said the arrangement had been devised by his son with very small encouragement from himself. He had to thank Mr. Mayall for calling his attention to the mistake of connecting the mirror

with the adjustable substage. His son recognized the error the moment it was mentioned, and at once removed the mirror to a separate sliding-piece.

The President said they were favoured by the presence of Dr. J. E. Talmage, of Salt Lake City, Utah, U.S.A., a recently elected Fellow, who had not only made a special effort to attend the meeting, but had also brought and exhibited some specimens of organic life found in the Great Salt Lake, which he would describe.

Dr. Talmage having expressed his thanks to the President for the kind way in which he had introduced him, and also to the Fellows of the Society for the cordiality of their reception, said that he left Salt Lake City rather hurriedly in order to avail himself of the opportunity of being present at the meeting. On this account he had not brought over as many specimens as he could have desired, but he had placed under some Microscopes in the room several examples of the brine shrimp, *Artemia fertilis*, from the Great Salt Lake, which he thought might prove of some interest. He found these objects rather difficult to mount for permanent observation. It was, for instance, almost useless to use glycerin, because it rendered the structure indistinct by transparency. He had at present discovered no way better than by putting them into some of the lake water with a 5 per cent. solution of alum. The structure was also so very delicate that it was very difficult to spread them out upon a slide, but by the use of the medium named the creature could be transferred to the slide and it spread itself out as it died. In addition to slides of these shrimps, prepared in the manner described, he also exhibited specimens of the calcareous sand from the lake shore.

Dr. Talmage, speaking of the occurrence of life in the Great Salt Lake, said it would seem to be a difficult task to determine the mean composition of the lake. An examination of the water by Dr. Gale, forty years ago, showed the solid contents to be 22.282 per cent., and the density 1.17. In 1869 Mr. Allen reported the water as containing 14.9934 per cent. solids. He (Dr. Talmage) had analysed the water in December 1885, and found 16.7162 per cent. solid matter, with a density of 1.1225. A later analysis, in August 1889, gave the density as 1.1569, and the total solids in solution as 19.5576 per cent. It is fairly safe to assert that under the conditions now prevailing in the Great Basin, the waters of the lake average from 16 to 18 per cent. solid contents. As would be expected, few species of living things have been found in its waters; yet the assertion that no life exists therein is entirely unwarranted. He vouched for the occurrence of each of the following, most of which were abundant:—(1) Larvæ of a species of the Tipulidæ, described as *Chironomus oceanicus* Pack. (2) Larvæ and pupæ of *Ephydra gracilis* Pack. The pupa-cases of this insect accumulate in great numbers upon the shores, where they undergo decomposition, with emanation of very disagreeable odours, recognizable at a distance of miles from the lake. (3) One species of *Corixa*, probably *C. decolor* Uhler. (4) But by far the most abundant is *Artemia fertilis* Verrill, commonly called the brine shrimp. These are often present in such numbers as to tint the water over wide areas. The structure and habits of the *Artemiæ* would prove a most interesting subject of investi-

gation. They are capable of adapting themselves to a wide range of conditions as regards the composition of the water. He (Dr. Talmage) had kept them alive for days in the lake water, diluted 25, 50, and even 75 per cent. with fresh water; and for periods varying from 8 to 18 hours in fresh water only.

Prof. Bell said a paper was read at the February meeting, in which Dr. W. B. Benham described a new earthworm from Central Africa under the name of *Eminia equatorialis*. It was found some time afterwards that the name *Eminia* had already been appropriated, Dr. Hartlaub, of Bremen, having given it to a bird previously found by Emin Pasha. In a letter received Dr. Benham proposed to alter the name given to the new earthworm to *Eminodrilus*.

Prof. Bell also noted that after the last number of the Journal went to press, a letter was received from Mr. Pringle containing additional particulars with regard to the approaching Bacteriological Congress, and giving notice to intending exhibitors as to the conditions under which objects would be received. As might be supposed in anything which Mr. Pringle had to do with, a special feature was made of photography.

Mr. Mayall said it would doubtless be remembered that at the last meeting of the Society Dr. Van Heurck's new Microscope was exhibited, and the design had been somewhat severely criticized. Having seen a report of what was then said, Dr. Van Heurck had written a rejoinder requesting that it might be read at the meeting:—

"I have just read in the 'English Mechanic' of May 29th, the criticism of the instrument which Messrs. Watson and Sons have constructed to my specification. I appeal to your impartiality to allow me to refute the assertions made, and I trust you will authorize the reading of my reply. (1) Defect of the fine-adjustment.—Mr. Mayall wrongly compares the Watson system to Zentmayer's. If the latter was defective, it was because it wanted a certain amount of play to work, as the small steel plate at the bottom, acting as a spring in the Zentmayer-Ross, was incapable of a quick action. It is not the same in Messrs. Watson's instrument, on account of the tightening pieces which allow of remedying the wear and tear which inevitably results in every machine, whatever it be, after some time. Besides, in Watson's system there is a strong counter-spring at the back coiled round a spindle having an action sufficiently strong to perfectly counter-balance the friction of the tightened sliding pieces. That the fixing of this fine-adjustment sliding between guide-pieces is not as bad as Mr. Mayall represents it, is also proved to me when I see that some other approved makers have adopted it for their best Microscopes, such as Messrs. R. and J. Beck, who, in their catalogue for 1890 declare this adjustment 'at once certain and decided.' I have, moreover, had a long experience with Messrs. Watson's system of fine-adjustment, and I know that when it gets out of order, which every fine-adjustment is liable to do in time, it can be put right in a few moments. This is not the case in several large Microscopes much praised. (2) The application of the fine-adjustment to the sub-stage is entirely defective, and seems even to prove, according to

Mr. Mayall, that I have a totally wrong idea of the essential principles of practical microscopy.—I regret I cannot accept Mr. Mayall's decision. I have my own method of working, a method too long to be described in this letter, and as this method enables me to produce work which is said not to be wholly valueless, I shall persevere in my errors. (3) Mr. Mayall says that the milled head of the fine-adjustment of the substage prevents the full rotation of the stage.—Here it is Mr. Mayall who seems to misunderstand the use of this rotating movement. We are no longer in the time when the illuminating apparatus consisted of a simple mirror, and the complete rotation might be of some utility. The condenser really is so arranged as to permit of a luminous pencil being moved all round the object. The rotation is therefore no longer necessary, except for adjusting the object in a convenient position for drawing or photography, or according to the astigmatism of the observer's eye. For all these purposes, the movement which the stage of my instrument possesses is more than sufficient. (4) Mr. Mayall criticizes as wrong the size of the milled heads of the movements of the stage.—It is, however, an elementary principle in mechanics that the larger the lever used, the better it will effect small, easy, and precise movements. If Mr. Mayall had tried oftener to put a diatom in the best possible position, either for photography or to make one of its striæ correspond with the micrometer, he would not recommend the small milled heads of the Mayall-Zeiss stage. This latter, with which I have worked for some time, can be used for finding an object, but it is very tiring to the fingers for continuous work, and cannot be used for work of precision. The displacement produced by the least motion of the milled head is far too rapid. (5) I am in the habit of photographing in the vertical position, and if one pillar gives me a sufficient stability, I do not see why I should have a second one, which would only hinder the handling of the mirror and parts of the substage. A second pillar only adds to the stability when it is put at a considerable distance from the other, as Messrs. Powell and Lealand make it. (6) The centering of the substage, described as of a cheap kind by Mr. Mayall, completely answers its purpose. It is the same as is used for the centering of the stage in Wenham's radial and Zeiss's Microscopes, &c. It would have been quite useless to spend money in superfluous complications. (7) The small screw to clamp the Microscope in the horizontal position was added by Messrs. Watson of their own accord. As I use only vertical cameras, I did not require it. It is possible that they took the idea from one of Swift's Microscopes; this, however, does not matter. The Mayall stage is nothing but Wenham's, constructed about 1878, but rendered independent of the Microscope-stage. No apparatus is now constructed, the suggestion of which cannot be found in some former Microscope. I believe I have replied to all the points criticized by Mr. Mayall. None of them seem to stand, and as for over two years I have used a similar instrument (which I had modified according to my experience) for my most delicate researches with the best results, I thought that others might use it with the same advantages. But one must not forget the conditions I prescribed: combine the convenience for everyday work with the greatest precision possible, at a relatively low price. I now maintain that the instrument fills these conditions; it

allows of the use of Continental as well as English objectives; its price is less than the large Continental stands; and, lastly, I challenge Mr. Mayall to make, with any Microscope he chooses, a delicate observation or any photograph which I cannot just as easily, conveniently, and perfectly make with my instrument."

Mr. Mayall said, with reference to Dr. Van Heurck's communication, there appeared to be only one matter calling for a detailed reply from him, and that was the oblique thrust given by Dr. Van Heurck in stating that the Mayall mechanical stage was nothing but the Wenham stage of 1878 rendered independent of the Microscope-stage. In assisting Mr. Frank Crisp in the preparation of the illustrated and descriptive catalogue of his Microscopes, &c., examples of nearly every Microscope and piece of accessory apparatus known had passed through his hands, and he had not only examined them all with considerable attention, but had taken many of them to pieces in order the better to understand and describe the mechanism. He thought, therefore, it might reasonably be supposed that if Mr. Wenham had preceded him in embodying the principle of the Mayall stage, the fact would not have escaped his own notice. Further, he might say that when he decided to have his stage made he went to Ross & Co., in whose house Mr. Wenham was engaged, and assuredly Mr. Wenham would at once have pointed out that the stage was a plagiarism if such had been the case. The fact was that Dr. Van Heurck had made a random guess at the matter without special knowledge, and had missed the point. In the course of years there had been a process of evolution going on in mechanical stages as in other parts of the Microscope. At first they were very elaborately made by the Duc de Chaulnes and by B. Martin in the last century, and were far ahead of the optical appliances to be used with them; then they were simplified, and brought into more general use; then, with the general introduction of achromatism, altogether superior mechanism was employed, and so important was it found to secure steadiness of motion, that stages were made of considerable thickness. Later on, attempts were made to reduce the thickness, and Mr. Wenham devised a stage using one plate only to carry the object. Mr. Tolles, the eminent optician of Boston, sent over a beautifully made stage, having two plates each of about $1/50$ in. thick, which Mr. Wenham modified by getting rid of one of the plates; and later still, he (Mr. Mayall) suggested that the plate might be removed and a frame substituted, by which the object could be moved about on the surface of the stage proper of the Microscope. The idea was found practicable and was taken up by various opticians, most recently by Zeiss, of Jena. So far, therefore, as regarded Dr. Van Heurck's imputation that he had plagiarized Mr. Wenham's stage of 1878, he could only regard that oblique thrust as, in fencing phrase, a "coup de Jarnac," and he did not feel under any sort of obligation to acknowledge that he was "hit." His remarks at the last meeting were intended to apply only to Dr. Van Heurck's specification and from what he then said he did not abate a word. He thought much of Dr. Van Heurck's defence of the Microscope was actuated by his not distinguishing between the design and the actual construction. On several points too, Dr. Van Heurck appeared not to have followed the criticism. He must add that the instrument itself had since been in his hands for trial, and he

must frankly say that the fine-adjustment worked smoothly and truly; but it should be noted that it had only just left the mechanician's hand. Other parts of the construction were not so well put together; but the defects might well be due to haste in finishing the work, some unavoidable delay having occurred in Messrs. Watson's workshop, in consequence of which the instrument was only ready for inspection a few hours before the meeting of the Society.

The President said that he noticed on the former occasion that Mr. Mayall expressly limited his criticism to the design of the Microscope, and that the manner in which he conveyed his adverse criticism was marked by great courtesy throughout, and it would be admitted that, with the experience he possessed, no one was more competent than he to give an opinion on either the design or the workmanship; hence he thought Dr. Van Heurck had been a little too hard upon Mr. Mayall in his remarks. At their meetings it was undoubtedly their duty to put before one another exactly what they thought with regard to matters brought to their notice.

Dr. W. H. Dallinger said he should like also to say that what impressed him so much at their last meeting was the fact that Mr. Mayall especially dissociated the workmanship of the instrument, and the plan as suggested by Dr. Van Heurck, keeping carefully apart two things which were totally and entirely distinct from each other, and dealing only with that which so intimately affected all who were accustomed to work with high powers. On those points of the principles of construction, apart from the way in which they were carried out, Mr. Mayall had said what, from his experience and his knowledge of the subject, was of great value to them all. They, in this country, were regarded as standing in the highest position as to the opportunities they possessed in forming correct judgments upon matters of that kind, and their judgment was regarded with respect by those who sought its expression. That being so, it was undoubtedly a serious thing for them to pass over lightly, or by their silence to appear to sanction, that which they believed to be inaccurate, simply for fear of offending the sensibilities of any one concerned. Whenever, therefore, a Microscope was brought before them for inspection, their duty was to express, just as a judge would express, a calm and fearless conviction of what was true and what was false. If, therefore, it was a fact that Microscopes were often brought before them, it was because their judgment was held in esteem, which esteem would not be longer valued as it was were they to express themselves loosely without the most absolute regard for that which was in itself perfectly true. Makers who regarded these matters in their true light should not consider themselves attacked when the principles of construction, and not the mechanical processes, were called into question.

Mr. Watson said he might mention that he came to their last meeting with a great deal of assurance because, knowing that much credit had been given to various Continental Microscopes which was not accorded to those of English makers, he thought he had achieved a position when the most competent of Continental microscopists had said with regard to this form of fine-adjustment, that it was the best he had ever seen, and that he was so well satisfied that after long trial he desired to have an instrument made specially for him on the same lines. When, therefore,

he brought it to the meeting, he thought he had a thing which would certainly be able to hold its own; and yet, on producing it, he found it was utterly condemned. Naturally, he felt very much hurt. He had nothing to complain of as regarded anything said about the workmanship, but what he still said was that the people who undertook to criticize it should be those who had had it in use and could speak from knowledge and experience, rather than a gentleman who had never seen it before. He said this because Dr. Van Heurck, after some years of actual use, had stated that it worked perfectly well. He would not add anything further on that occasion, except that he was much obliged to those present for listening to what he had said.

Dr. Dallinger, having suggested that they were not a debating society, and in no way bound by the rules of a debating society, expressed a hope that if any one had a truth to state he would feel at perfect liberty to speak further.

Mr. Mayall said he could not for a moment admit Mr. Watson's contention that no valuable opinion could be given of a Microscope unless the instrument was actually tried. The design was one thing and the construction another. The design might be good or bad, and the construction might also be good or bad, hence it was evident that one might be considered apart from the other. In condemning the design of the Van Heurck Microscope he had had no thought of hurting Mr. Watson's patriotic feelings. Until Mr. Watson stated the fact, he (Mr. Mayall) was not aware that any sort of patriotism was involved in the manufacture of a Microscope. He did not follow Mr. Watson in supposing that the approval given of the Microscope by Dr. Van Heurck would almost necessarily involve its being approved by those Fellows of the Society who were known to have made a special study of such matters. It was, perhaps, quite natural that Dr. Van Heurck and Mr. Watson should approve of their bantling, and say what they could in its defence; but he must claim for himself exactly the same liberty that was possessed by all other Fellows of the Society to decline to measure his criticism to suit the particular crotchets of this or that amateur, or the interest of any particular manufacturer of Microscopes. In dealing with such matters he was not acting in the name of the Society, but in his individual capacity as a Fellow. His approval or disapproval of a specification or of a construction had no other claim to serious consideration than in so far as it fairly represented opinions based on experience. It had been no satisfaction to him to condemn Dr. Van Heurck's Microscope, for he could only anticipate what had actually happened—that Dr. Van Heurck would defend himself vigorously. He had, however, been somewhat perplexed by the line of defence taken by Mr. Watson in asserting that the "principal points" in the Van Heurck Microscope existed already in a Microscope supplied by his firm to Dr. Van Heurck three or four years ago. The question seemed naturally to follow: Why, under these circumstances, was Dr. Van Heurck's name attached to the instrument? There seemed some sort of mystery in the matter. For his own part, he was practically certain that if Dr. Van Heurck had sent him the specification, with a drawing, asking his opinion, he should have dealt with the technical details as he had done at their last meeting. It was no new opinion of

his to condemn the Zentmayer system of fine-adjustment, and he had not condemned it until Messrs. Ross had gone through a most exhaustive series of experiments with the system, resulting in the abandonment of their patent rights, and in their adopting other systems for their best Microscopes. The fact that Messrs. Ross allowed the patent to lapse was the severest condemnation of Zentmayer's system of fine-adjustment. He might add that Messrs. Ross had submitted all their experimental devices to himself for trial, and that every step that had been taken in the matter was thoroughly discussed by Mr. Wenham and others before the Zentmayer system was given up. After this experience, he had felt justified in condemning the system frankly in his Cantor Lectures at the Society of Arts, and his criticism was published five years ago in the Journal of that Society. Dr. Van Heurck had received a copy of the reprint of those lectures, and might at any time have asked him for fuller details if he had thought proper to do so. It was hardly to be expected that he should seek information of that kind from Dr. Van Heurck, who had hitherto been totally unknown as taking any special interest in the design of Microscopes or microscopical apparatus; and he must confess that the recent discussion on the design of the "Van Heurck" Microscope had not impressed him with Dr. Van Heurck's knowledge of the mechanism of high-class Microscopes. It was, surely, a matter of common knowledge that a skilled manipulator could execute extremely delicate work with a Microscope of very inferior construction. Dr. Van Heurck's challenge to himself to a competition in manipulation would, if accepted, really end in no useful result. Whether one Microscopist could or could not do with inferior means what another had done with the best means available, would not advance the construction of the Microscope a jot. Instead of an idle competition of that kind, it would be infinitely preferable that experts in microscopical manipulation should frankly compare notes of past experience, and join in the promotion of the highest excellence attainable in the mechanical and optical construction of the Microscope. He thought the question of their right to freedom of discussion of the matters brought before them had been admirably laid down by Dr. Dallinger, who, in writing to him on the subject, had expressed himself as follows:—

"Our criticisms of instruments and apparatus are judicial—absolutely unbiassed, and wholly on the merits of the subject, or they are of no value—nay, they are pernicious. If ours were a debating club there might be limits to the 'right of reply.' We are a society seeking truth on a special subject. If a man happens to be able to add to or elucidate a truth by rising four or five times, and before or after any one else, I take it that he may and should do so. But as a matter of fact, I rose to criticize a principle, not a thing. My remarks on the thing were incidental. I merely demanded our right to criticize favourably or adversely, as our judgment dictated; and that carried with it the consequent impropriety of any attempt to *retort*. A modest reply would be different." He thought he need not read the remainder of the letter, though it emphasized Dr. Dallinger's agreement with the adverse criticism of the Van Heurck Microscope. He desired it to be clearly understood that when he criticized a Microscope, he did so in his individual capacity, and certainly not as speaking with authority on behalf of the Society,

and he hoped that opticians who brought instruments to the Society would not ask them as a Society to pronounce opinions either in praise or blame. Such matters could only be properly dealt with by the Fellows in their individual capacity, and the Society must not engage collectively to hold the balance steadily and weigh the merits of the various commercial interests involved in bringing new Microscopes to the notice of the public. Those Fellows who had had special experience in examining and testing Microscopes and Microscopical apparatus must be left to use their own discretion as to what they commended to the notice of the Society, and provided the principle laid down by Dr. Dallinger were kept in view—that the criticism was wholly and sincerely on the merits of the subject—the result must be to forward the best interests of microscopy and of the Society. As to what might be done in future cases, he trusted the principle advocated by Dr. Dallinger would be always maintained.

Mr. T. D. Aldous exhibited the eggs of a water-snail which were attacked by a hexapod parasite which seemed to be destroying the gelatinous matter to get at the eggs.

The President announced that the next meeting of the Society would be held on 21st October.

The following Instruments, Objects, &c., were exhibited:—

Mr. T. D. Aldous:—Eggs of Water-snail.

Mr. T. Comber:—Negative of *Amphipleura pellucida*.

Mr. C. L. Curties:—Nelson's apparatus for producing monochromatic illumination for the Microscope.

Mr. T. T. Johnson:—New form of Student's Microscope.

Dr. G. H. F. Nuttall:—A slide containing Tubercle Bacilli.

Dr. J. E. Talmage:—Slides of *Artemia fertilis* and Calcareous Sand.

Mr. B. W. Thomas:—Photographs of Diatoms.

New Fellows:—The following were elected *Ordinary* Fellows:—Messrs. John Hunt, Lemuel Benjamin Lilley, Charles Henry Southwell, Edwin Terry, and Miss Ida Agnes Sharpe. *Honorary* Fellow:—Prof. Thomas Henry Huxley, F.R.S. *Ex-officio* Fellow:—The President of the Scottish Microscopical Society.

The Journal is issued on the third Wednesday of
February, April, June, August, October, and December.

1891. Part 5.

OCTOBER.

{ To Non-Fellows,
Price 5s.

NOV 16 1891

6969

JOURNAL
OF THE
ROYAL
MICROSCOPICAL SOCIETY;

CONTAINING ITS TRANSACTIONS AND PROCEEDINGS,

AND A SUMMARY OF CURRENT RESEARCHES RELATING TO

ZOOLOGY AND BOTANY

(principally Invertebrata and Cryptogamia),

MICROSCOPY, &c.

Edited by

F. JEFFREY BELL, M.A.,

One of the Secretaries of the Society

and Professor of Comparative Anatomy and Zoology in King's College;

WITH THE ASSISTANCE OF THE PUBLICATION COMMITTEE AND

A. W. BENNETT, M.A., B.Sc., F.L.S.,
Lecturer on Botany at St. Thomas's Hospital,

R. G. HEBB, M.A., M.D. (Cantab.), AND

J. ARTHUR THOMSON, M.A.,
Lecturer on Zoology in the School of Medicine,
Edinburgh,

FELLOWS OF THE SOCIETY.



WILLIAMS & NORGATE,
5^m LONDON AND EDINBURGH.

CONTENTS.

TRANSACTIONS OF THE SOCIETY—

PAGE

IX.—THE FORAMINIFERA OF THE GAULT OF FOLKESTONE. By Frederick Chapman. (Plate IX.)	565
---	-----

SUMMARY OF CURRENT RESEARCHES.

ZOOLOGY.

A. VERTEBRATA:—Embryology, Histology, and General.

a. Embryology.

LAMEERE, A.— <i>Origin of Vertebrata</i>	576
ZELLER, E.— <i>Fertilization of Newts</i>	576
CHOLODKOVSKY, N.— <i>The Blastopore in Meroblastic Ova</i>	577
VOELTZKOW, A.— <i>The Eggs and Embryos of the Crocodile</i>	577
FROBIEP, A.— <i>Development of the Optic Nerves</i>	578
LACHI, P.— <i>Histogenesis of the Neuroglia</i>	578
VAN DER STRICHT, O.— <i>Development of Blood in Embryonic Liver</i>	578

b. Histology.

SCHNEIDER, C. C.— <i>Structure of the Cell</i>	579
SOLGER, B.— <i>Pigment-cells</i>	580
BALLOWITZ, E.— <i>Minute Structure of Spermatozoa of Mammalia</i>	580

B. INVERTEBRATA.

HADDON'S (A. C.) <i>Collections in Torres Straits</i>	581
---	-----

Mollusca.

a. Cephalopoda.

RAWITZ, B.— <i>Changes in the Retinal Pigment of Cephalopods</i>	581
--	-----

γ. Gastropoda.

PLATE, L.— <i>Anatomy of Daudebardia and Testacella</i>	582
COCKERELL, T. D. A.— <i>Geographical Distribution of Slugs</i>	582
BOUTAN, L.— <i>Larval Form of Parmophorus</i>	582

δ. Lamellibranchiata.

PELSENEER, P.— <i>Lamellibranchiata</i>	582
GROBEN, C.— <i>The Bulbus Arteriosus and Aortic Valves of Lamellibranchs</i>	584

Molluscoida.

a. Tunicata.

HERDMAN, W. A.— <i>Classification of the Tunicata</i>	585
---	-----

β. Bryozoa.

PROUHO, H.— <i>Lozosoma annelidicola</i>	585
WATERS, A. W.— <i>Characters of Melicertiliidæ and other Fossil Bryozoa</i>	586
HINCKS, T.— <i>Marine Polyzoa</i>	586

Arthropoda.

SCHNEIDER, A.— <i>Circulatory and Respiratory Organs of some Arthropods</i>	586
---	-----

	a.	b.	PAGE
SCHÄFER, E. A.— <i>Minute Structure of Muscle-columns in Wing-muscles of Insects</i> ..			587
GRABER, V.— <i>Origin of the Blood and Fatty-tissue in Insects</i>			587
LEYDIG, F.— <i>Signs of Copulation in Insects</i>			588
JACKSON, W. H.— <i>Morphology of Lepidoptera</i>			588
POULTON, E. B.— <i>Morphology of Lepidopterous Pupa</i>			588
PACKARD, A. S.— <i>Phylogeny of Lepidopterous Larvæ</i>			589
RECKER, P.— <i>Sound-Organs of Dytiscidæ</i>			589
β. Myriopoda.			
WILLEM, V.— <i>Ocelli of Lithobius</i>			590
δ. Arachnida.			
CANESTRINI, G.— <i>Classification of Mites</i>			590
STURANY, R.— <i>Coxal Glands of Arachnida</i>			591
ε. Crustacea.			
SZCZAWINSKA, W.— <i>Eyes of Crustacea</i>			591
ROULE, L.— <i>Development of Mesoderm of Crustacea</i>			592
MARCHAL, P.— <i>Renal Secretion in Crustacea</i>			593
NUSBAUM, J.— <i>Morphology of Isopod Feet</i>			593
STEBBING, T. R. R.— <i>Urothoe and Urothoides</i>			594
" " <i>New British Amphipods</i>			594
HESSE— <i>New and Rare French Crustacea</i>			594
CLAUS, C.— <i>Goniopelte gracilis—a new Copepod</i>			594
GIESBRECHT, W.— <i>New Pelagic Copepoda</i>			594
Vermes.			
a. Annelida.			
MALAQVIN, A.— <i>Homology of Pedal and Cephalic Appendages in Annelids</i>			595
" " <i>Development and Morphology of Parapodia in Syllidinae</i>			595
ANDREWS, E. A.— <i>Reproductive Organs of Diopatra</i>			595
MICHAELSEN, W.— <i>Earthworms of Berlin Museum</i>			596
BEDDARD, F. E.— <i>New Form of Excretory Organ in an Oligochæte Annelid</i> ..			596
BOURNE, A. G.— <i>Naidiform Oligochæta</i>			596
ROHDE, E.— <i>Histology of Nervous System of Hirudinea</i>			597
WARD, H. B.— <i>Anatomy and Histology of Sipunculus nudus</i>			598
β. Nemathelminthes.			
CHATIN, J.— <i>Stylet of Heterodera Schachtii</i>			598
GRAFF, L.— <i>Organization of Acelous Turbellaria</i>			599
γ. Platyhelminthes.			
SAINT-REMY, G.— <i>Nervous System of Monocotylidea</i>			600
BLANCHARD, R.— <i>Hymenolepis</i>			600
δ. Incertæ Sedis.			
MASIU, J.— <i>Contribution to the Study of Rotifers</i>			600
VALLENTIN, R.— <i>Anatomy of Rotifers</i>			601
THOMPSON, P. G.— <i>Dasydytes bisetosum</i>			602
FRENZEL, J.— <i>A Multicellular, Infusorium-like Animal</i>			602
Echinodermata.			
BELL, F. JEFFREY— <i>Classification of Echinodermata</i>			602
SLADEN, W. PERCY— <i>Echinodermata from South-west Ireland</i>			604
LUDWIG, H.— <i>Development of Holothurians</i>			604
BELL, F. JEFFREY— <i>Bathypæster vezillifer</i>			606
Cœlenterata.			
M'MURRICH, J. PLAYFAIR— <i>Phylogeny of Actinozoa</i>			606
HEIDER, A. R. v.— <i>Coral-Studies</i>			608

HICKSON, S. J.— <i>Medusæ of Millepora Murrayi and Gonophores of Allopora and Distichopora</i>	608
MAAS, O.— <i>Craspedota of the Plankton Expedition</i>	609
BRAUER, A.— <i>Development of Hydra</i>	609

Porifera.

DENDY, A.— <i>Victorian Sponges</i>	610
" " <i>Synute pulchella</i>	611
LENDENFELD, R. v.— <i>System of Calcareous Sponges</i>	611
KELLER, C.— <i>Sponge-Fauna of the Red Sea</i>	611

Protozoa.

BORGERT, A.— <i>Dictyochida</i>	611
BOURNE, A. G.— <i>Pelomyxa viridis</i>	612
BURGESS, E. W.— <i>Foraminifera of Hammerfest</i>	613
MINGAZZINI, P.— <i>New Monocystidea</i>	613
GREGORY, J. W.— <i>Tudor Specimen of Eozoon</i>	613

BOTANY.

A. GENERAL, including the Anatomy and Physiology of the Phanerogamia.

a. Anatomy.

(1) Cell-structure and Protoplasm.

GERASSIMOFF, J.— <i>Function of the Nucleus</i>	614
GUIGNARD, L., E. DE WILDEMAN, & P. VAN TIEGHEM—" <i>Attractive Spheres</i> " in <i>Vegetable Cells (Tinoleucites)</i>	614
MOORE, S. LE M.— <i>Nature of Callus</i>	615

(2) Other Cell-contents (including Secretions).

BELZUNG, E.— <i>Aleurone-grains in Papilionaceæ</i>	615
MANN, G.— <i>Chlorophyll</i>	616
BERTHELOT & G. ANDRÉ— <i>Sulphur in Plants</i>	616
KRAUS, G.— <i>Calcium oxalate in the Bark of Trees</i>	616
ARCANGELI, G.— <i>Crypto-crystalline Calcium oxalate</i>	616

(3) Structure of Tissues.

LESAGE, P.— <i>Differentiation of the Endoderm</i>	617
VAN TIEGHEM, P.— <i>Folded Tissue</i>	617
BACCARINI, P., & P. VUILLEMIN— <i>Secretory System of Papilionaceæ</i>	617
ZOFF, W.— <i>Alkaloid-receptacles of the Fumariaceæ</i>	618
DEHMEL, M., & THOUVENIN— <i>Latez-receptacles</i>	618
BEAUVISAGE, G.— <i>Sieve-fascicles in the Secondary Xylem of Belladonna</i>	618
VAN TIEGHEM, P.— <i>Extra-phloem Sieve-tubes and Extra-xylem Vessels</i>	618
FREMONT, A.— <i>Extra-phloem Sieve-tubes in the Root of the Enothereæ</i>	619
ZIMMERMANN, A., & C. GIESENHAGEN— <i>Cystoliths of Ficus</i>	619
PÉE-LABY, E.— <i>Supporting-elements in the Leaf</i>	619
BERGER, F.— <i>Anatomy of Ipomæa</i>	619
SCOTT, D. H.— <i>Anatomy of Ipomæa versicolor</i>	620

(4) Structure of Organs.

WIESNER, J.— <i>Changes in the Form of Plants produced by Moisture and Etillation</i>	620
KARSTEN, G.— <i>Mangrove-vegetation</i>	620
PITZORNO, M.— <i>Stigmatic Disc of Vinca</i>	621
PALLA, E.— <i>Pollen of Strelitzia</i>	621
KORELLA, W.— <i>Stomates in the Calyx</i>	621
LUBBOCK, J.— <i>Fruit and Seed of the Juglandææ</i>	621
" " <i>Leaves of Viburnum</i>	622
" " <i>Form and Function of Stipules</i>	622
MÜLLER-THURGAU, H.— <i>Pearl-like Glands of the Vine</i>	622
KLEBAHN, H.— <i>Roots springing from Lenticels</i>	622
PRAZMOWSKI, A.— <i>Root-nodules of the Pea</i>	623
LAMARLIÈRE, G. DE— <i>Structure of swollen Roots in certain Umbelliferae</i>	623

	PAGE
DIETEL, P.— <i>Puccinia parasitic on Saxifragaceæ</i>	635
MAGNUS, P.— <i>New Uredinæ</i>	635
BARCLAY, A.— <i>Himalayan Uredinæ</i>	635
GIARD, A.— <i>Entomophytic Cladosporiæ</i>	636
PRILLIEUX, E., DELACROIX, LE MOULT, & A. GIARD— <i>Parasite of the Cockchafer</i> ..	636
TRABUT, L., & C. BRONGNIART— <i>Parasite of Acridium peregrinum</i>	636
HESSE, R.— <i>Hypogæi of Germany</i>	637
VIALA, P., & G. BOYER— <i>Basidiomycete parasitic on Grapes</i>	637

Protophyta.

a. Schizophyceæ.

BORZI, A.— <i>Dictyosphaerium, Botryococcus, and Porphyridium</i>	637
MASSEE, G.— <i>Dictyosphaerium</i>	638
ONDERDONK, C., & R. W. HASKINS— <i>Movements of Diatoms</i>	638

β. Schizomycetes.

MESSEA, A.— <i>Classification of Bacteria</i>	638
FISCHER, A.— <i>Plasmolysis in Bacteria</i>	638
FRANK, B.— <i>Symbiosis of Rhizobium and Leguminosæ</i>	639
LAURENT, E.— <i>Microbe of the Tubercles of Leguminosæ</i>	640
ZOPF, W.— <i>Colouring-matter of certain Schizomycetes</i>	640
SLATER, C.— <i>A Red-Pigment-forming Organism</i>	640
KATZ, O.— <i>Phosphorescent Bacteria</i>	640
DANGEARD, P. A.— <i>Eubacillus, a new Genus of Bacteriaceæ</i>	641
HANSIRG, A.— <i>Phragmidiothrix and Leptothrix</i>	641
CABONI, G.— <i>Bacteria in the Colonies of Puccinia Hieracii</i>	641
SCHIAVUZZI, B.— <i>Bacillus malarie</i>	641
FISCHEL, F.— <i>Bacteria of Influenza</i>	641
CANEVA, G.— <i>Bacteria of Swine Diseases</i>	642
VINCENTINI, F.— <i>Diplococcus resembling Gonococcus</i>	643
MARTINAND, V., & M. RIETSCH— <i>Micro-organisms found on ripe Grapes and their Development during Fermentation</i>	643
GESSARD— <i>Races of Bacillus pyocyaneus</i>	643
CONN, H. W.— <i>New Micrococcus of Bitter Milk</i>	644
FÖKKER, A. P., & ED. DE FREUDENREICH— <i>Germeicidal Properties of Milk</i>	644
GAMALEIA— <i>Antitoxic Power of the Animal Organism</i>	645
NENCKI— <i>Isomeric Lactic Acids as criteria diagnostic of certain species of Bacteria</i> ..	645
EISENBERG'S <i>Bacteriological Diagnosis</i>	646

MICROSCOPY.

a. Instruments, Accessories, &c.

(1) Stands.

JOHNSON & SONS' <i>Advanced Student's Microscope</i> (Fig. 70)	648
SEAMAN, W. H.— <i>A College Microscope</i> (Fig. 71)	649

(3) Illuminating and other Apparatus.

ALTMANN'S <i>Thermoregulator</i> (Fig. 72)	651
MIQUEL, P.— <i>Metallic Thermoregulators</i>	652
ROUX— <i>Thermoregulator for large Drying-stoves and Incubators</i>	652
BEYERINCK, M. W.— <i>Capillary-siphon-dropping Bottle</i>	652
UNNA, P. G.— <i>Steam-filter</i>	653

(4) Photomicrography.

BORDEN, W. C.— <i>The Value of using different makes of Dry Plates in Photomicrography</i> (Fig. 73)	653
MARKTANNER-TURNERETSCHER'S ' <i>Die Mikrophotographie als Hilfsmittel Naturwissenschaftlicher Forschung</i> '	657

(5) Microscopical Optics and Manipulation.		PAGE
COX, J. D.— <i>Diatom-Structure—The Interpretation of Microscopical Images</i> (Fig. 74)		657
VANNI, G.— <i>On a new Method for the Measurement of the Focal Length of Lenses or Convergent Systems</i>		665
LEROY, C. J. A.— <i>Proof of a simple Relation between the Resolving Power of an Aplanatic Objective of the Microscope and the Diffraction of the finest Grating which the Objective can resolve</i>		665
(6) Miscellaneous.		
DR. DALLINGER'S <i>Address to the Quekett Club</i>		666
<i>The late Mr. John Mayall, Jr., Sec. R.M.S.</i>		673
<i>Carl Wilhelm von Naegeli</i>		675
<i>List of all Patents for Improving the Microscope issued in the United States from 1853 to 1890</i>		676
<i>Newspaper Science</i>		677
β. Technique.		
(1) Collecting Objects, including Culture Processes.		
SCHULTZ, N. K.— <i>Preparation of Nutrient Media</i>		678
SACHAROW, N.— <i>Preserving Malaria-Plasmodia alive in Leeches</i>		679
PASTERNAKI, T.— <i>Cultivating Spirillum Obermeieri in Leeches</i>		679
KAUFMANN, P.— <i>New Cultivation Medium for Bacteria</i>		679
REICHEL'S <i>Apparatus for Filtering Fluids containing Bacteria</i> (Fig. 75)		680
WINOGRADSKY— <i>Organisms of Nitrification and their Cultivation</i>		680
LINE, J. E.— <i>A Colony-counter</i> (Fig. 76)		681
D'ARSONVAL, A.— <i>Filtration and Sterilization of Organic Fluids by means of liquid carbonic acid</i>		682
„ „ <i>Apparatus for maintaining a Fixed Temperature</i>		682
(2) Preparing Objects.		
VAN DER STRICHT, O.— <i>Examination of Embryonic Liver</i>		683
SCHÄFER, E. A.— <i>Preparation of Wing-muscles of Insects</i>		683
ROHDE, E.— <i>Preparation of Nervous System of Hirudinea</i>		684
WARD, H. B.— <i>Mode of Investigating Sipunculus nudus</i>		684
BRAUER, A.— <i>Development of Hydra</i>		684
HERTWIG, R.— <i>Study of Karyokinesis in Paramœcium</i>		684
WARD, H. B.— <i>Method of Narcotizing Hydroids, Actinæ, &c.</i>		685
BEYERINCK, M. W.— <i>Method for Demonstrating the Formation of Acids by Micro-organisms</i>		685
EISELSBERG, A. VON— <i>Demonstration of Suppuration-Cocci in the Blood as an aid to Diagnosis</i>		686
MANN, GUSTAV— <i>On a Method of Preparing Vegetable and Animal Tissues for Paraffin Imbedding, with a few Remarks as to Mounting Sections</i>		686
(3) Cutting, including Imbedding and Microtomes.		
MOLL, J. W.— <i>Sharpening Ribbon-Microtome Knives</i>		689
<i>To preserve Edges of Microtome Knives</i>		689
(4) Staining and Injecting.		
MANN, G.— <i>Staining of Chlorophyll</i>		689
KAUFMANN, P.— <i>New Application of Safranin</i>		690
STRAUSS— <i>New Syringe for Hypodermic Injection</i>		690
ROUX, G.— <i>Colourability of Tubercle Bacilli</i>		690
MALLORY, F. B.— <i>Phospho-Molybdic Acid Hæmatoxylin</i>		690
MANN, GUSTAV— <i>Methods of Differential Nucleolar Staining</i>		690
(5) Mounting, including Slides, Preservative Fluids, &c.		
AUBERT, A. B.— <i>Reference Tables for Microscopical Work. III. Cements and Varnishes</i>		692
(6) Miscellaneous.		
STERNBERG, G. M.— <i>Coco-nut-water as a Culture Fluid</i>		693
PROCEEDINGS OF THE SOCIETY		694

APERTURE TABLE.

Numerical Aperture. ($n \sin u = a.$)	Corresponding Angle ($2u$) for			Limit of Resolving Power, in Lines to an Inch.			Illuminating Power. (a^2 .)	Penetrating Power ($\frac{1}{a}$)
	Air ($n = 1.00$.)	Water ($n = 1.33$.)	Homogeneous Immersion ($n = 1.52$.)	White Light. ($\lambda = 0.5269 \mu$, Line E.)	Monochromatic (Blue) Light. ($\lambda = 0.4861 \mu$, Line F.)	Photography. ($\lambda = 0.4000 \mu$, Near Line A.)		
1.52	180° 0'	146,543	158,845	193,037	2.310	.658
1.51	166° 51'	145,579	157,800	191,767	2.280	.662
1.50	161° 23'	144,615	156,755	190,497	2.250	.667
1.49	157° 12'	143,651	155,710	189,227	2.220	.671
1.48	153° 39'	142,687	154,665	187,957	2.190	.676
1.47	150° 32'	141,723	153,620	186,687	2.161	.680
1.46	147° 42'	140,759	152,575	185,417	2.132	.685
1.45	145° 6'	139,795	151,530	184,147	2.103	.690
1.44	142° 39'	138,830	150,485	182,877	2.074	.694
1.43	140° 22'	137,866	149,440	181,607	2.045	.694
1.42	138° 12'	136,902	148,395	180,337	2.016	.709
1.41	136° 8'	135,938	147,350	179,067	2.086	.709
1.40	134° 10'	134,974	146,305	177,797	1.960	.714
1.39	132° 16'	134,010	145,260	176,527	1.932	.719
1.38	130° 26'	133,046	144,215	175,257	1.904	.725
1.37	128° 40'	132,082	143,170	173,987	1.877	.729
1.36	126° 58'	131,118	142,125	172,717	1.850	.735
1.35	125° 18'	130,154	141,080	171,447	1.823	.741
1.34	123° 40'	129,189	140,035	170,177	1.796	.746
1.33	..	180° 0'	122° 6'	128,225	138,989	168,907	1.769	.752
1.32	..	165° 56'	120° 33'	127,261	137,944	167,637	1.742	.758
1.30	..	155° 38'	117° 35'	125,333	135,854	165,097	1.690	.769
1.28	..	148° 42'	114° 44'	123,405	133,764	162,557	1.638	.781
1.26	..	142° 39'	111° 59'	121,477	131,674	160,017	1.588	.794
1.24	..	137° 36'	109° 20'	119,548	129,584	157,477	1.538	.806
1.22	..	133° 4'	106° 45'	117,620	127,494	154,937	1.488	.820
1.20	..	128° 55'	104° 15'	115,692	125,404	152,397	1.440	.833
1.18	..	125° 3'	101° 50'	113,764	123,314	149,857	1.392	.847
1.16	..	121° 26'	99° 29'	111,835	121,224	147,317	1.346	.862
1.14	..	118° 0'	97° 11'	109,907	119,134	144,777	1.300	.877
1.12	..	114° 44'	94° 55'	107,979	117,044	142,237	1.254	.893
1.10	..	111° 36'	92° 43'	106,051	114,954	139,698	1.210	.909
1.08	..	108° 36'	90° 34'	104,123	112,864	137,158	1.166	.926
1.06	..	105° 42'	88° 27'	102,195	110,774	134,618	1.124	.943
1.04	..	102° 53'	86° 21'	100,266	108,684	132,078	1.082	.962
1.02	..	100° 10'	84° 18'	98,338	106,593	129,538	1.040	.980
1.00	180° 0'	97° 31'	82° 17'	96,410	104,503	126,998	1.000	1.000
0.98	157° 2'	94° 56'	80° 17'	94,482	102,413	124,458	.960	1.020
0.96	147° 29'	92° 24'	78° 20'	92,554	100,323	121,918	.922	1.042
0.94	140° 6'	89° 56'	76° 24'	90,625	98,233	119,378	.884	1.064
0.92	133° 51'	87° 32'	74° 30'	88,697	96,143	116,838	.846	1.087
0.90	128° 19'	85° 10'	72° 36'	86,769	94,053	114,298	.810	1.111
0.88	123° 17'	82° 51'	70° 44'	84,841	91,963	111,758	.774	1.136
0.86	118° 38'	80° 34'	68° 54'	82,913	89,873	109,218	.740	1.163
0.84	114° 17'	78° 20'	67° 6'	80,984	87,783	106,678	.706	1.190
0.82	110° 10'	76° 8'	65° 18'	79,056	85,693	104,138	.672	1.220
0.80	106° 16'	73° 58'	63° 31'	77,128	83,603	101,598	.640	1.250
0.78	102° 31'	71° 49'	61° 45'	75,200	81,513	99,058	.608	1.282
0.76	98° 56'	69° 42'	60° 0'	73,272	79,423	96,518	.578	1.316
0.74	95° 28'	67° 37'	58° 16'	71,343	77,333	93,979	.548	1.351
0.72	92° 6'	65° 32'	56° 32'	69,415	75,242	91,439	.518	1.389
0.70	88° 51'	63° 31'	54° 50'	67,487	73,152	88,899	.490	1.429
0.68	85° 41'	61° 30'	53° 9'	65,559	71,062	86,359	.462	1.471
0.66	82° 36'	59° 30'	51° 28'	63,631	68,972	83,819	.436	1.515
0.64	79° 36'	57° 31'	49° 48'	61,702	66,882	81,279	.410	1.562
0.62	76° 38'	55° 34'	48° 9'	59,774	64,792	78,739	.384	1.613
0.60	73° 44'	53° 38'	46° 30'	57,846	62,702	76,199	.360	1.667
0.58	70° 54'	51° 42'	44° 51'	55,918	60,612	73,659	.336	1.724
0.56	68° 6'	49° 48'	43° 14'	53,990	58,522	71,119	.314	1.786
0.54	65° 22'	47° 54'	41° 37'	52,061	56,432	68,579	.292	1.852
0.52	62° 40'	46° 2'	40° 0'	50,133	54,342	66,039	.270	1.923
0.50	60° 0'	44° 10'	38° 24'	48,205	52,252	63,499	.250	2.000
0.45	53° 30'	39° 33'	34° 27'	43,385	47,026	57,149	.203	2.222
0.40	47° 9'	35° 0'	30° 31'	38,564	41,801	50,799	.160	2.500
0.35	40° 58'	30° 30'	26° 38'	33,744	36,576	44,449	.123	2.857
0.30	34° 56'	26° 4'	22° 46'	28,923	31,351	38,099	.090	3.333
0.25	28° 58'	21° 40'	18° 56'	24,103	26,126	31,749	.063	4.000
0.20	23° 4'	17° 18'	15° 7'	19,282	20,901	25,400	.040	5.000
0.15	17° 14'	12° 58'	11° 19'	14,462	15,676	19,050	.023	6.667
0.10	11° 29'	8° 38'	7° 34'	9,641	10,450	12,700	.010	10.000
0.05	5° 44'	4° 18'	3° 46'	4,821	5,252	6,350	.003	20.000

COMPARISON OF THE FAHRENHEIT AND CENTIGRADE THERMOMETERS.

Fahr.	Centigr.	Fahr.	Centigr.	Fahr.	Centigr.	Fahr.	Centigr.	Fahr.	Centigr.
212	100	158	70	104	40	50	10	- 4	- 20
210 [·] 2	99	156 [·] 2	69	102 [·] 2	39	48 [·] 2	9	- 5 [·] 8	- 21
210	98 [·] 89	156	68 [·] 89	102	38 [·] 89	48	8 [·] 89	- 6	- 21 [·] 11
208 [·] 4	98	154 [·] 4	68	100 [·] 4	38	46 [·] 4	8	- 7 [·] 6	- 22
208	97 [·] 78	154	67 [·] 78	100	37 [·] 78	46	7 [·] 78	- 8	- 22 [·] 22
206 [·] 6	97	152 [·] 6	67	98 [·] 6	37	44 [·] 6	7	- 9 [·] 4	- 23
206	96 [·] 67	152	66 [·] 67	98	36 [·] 67	44	6 [·] 67	- 10	- 23 [·] 33
204 [·] 8	96	150 [·] 8	66	96 [·] 8	36	42 [·] 8	6	- 11 [·] 2	- 24
204	95 [·] 56	150	65 [·] 56	96	35 [·] 56	42	5 [·] 56	- 12	- 24 [·] 44
203	95	149	65	95	35	41	5	- 13	- 25
202	94 [·] 44	148	64 [·] 44	94	34 [·] 44	40	4 [·] 44	- 14	- 25 [·] 56
201 [·] 2	94	147 [·] 2	64	93 [·] 2	34	39 [·] 2	4	- 14 [·] 8	- 26
200	93 [·] 33	146	63 [·] 33	92	33 [·] 33	38	3 [·] 33	- 16	- 26 [·] 67
199 [·] 4	93	145 [·] 4	63	91 [·] 4	33	37 [·] 4	3	- 16 [·] 6	- 27
198	92 [·] 22	144	62 [·] 22	90	32 [·] 22	36	2 [·] 22	- 18	- 27 [·] 78
197 [·] 6	92	143 [·] 6	62	89 [·] 6	32	35 [·] 6	2	- 18 [·] 4	- 28
196	91 [·] 11	142	61 [·] 11	88	31 [·] 11	34	1 [·] 11	- 20	- 28 [·] 89
195 [·] 8	91	141 [·] 8	61	87 [·] 8	31	33 [·] 8	1	- 20 [·] 2	- 29
194	90	140	60	86	30	32	0	- 22	- 30
192 [·] 2	89	138 [·] 2	59	84 [·] 2	29	30 [·] 2	- 1	- 23 [·] 8	- 31
192	88 [·] 89	138	58 [·] 89	84	28 [·] 89	30	- 1 [·] 11	- 24	- 31 [·] 11
190 [·] 4	88	136 [·] 4	58	82 [·] 4	28	28 [·] 4	- 2	- 25 [·] 6	- 32
190	87 [·] 78	136	57 [·] 78	82	27 [·] 78	28	- 2 [·] 22	- 26	- 32 [·] 22
188 [·] 6	87	134 [·] 6	57	80 [·] 6	27	26 [·] 6	- 3	- 27 [·] 4	- 33
188	86 [·] 67	134	56 [·] 67	80	26 [·] 67	26	- 3 [·] 33	- 28	- 33 [·] 33
186 [·] 8	86	132 [·] 8	56	78 [·] 8	26	24 [·] 8	- 4	- 29 [·] 2	- 34
186	85 [·] 56	132	55 [·] 56	78	25 [·] 56	24	- 4 [·] 44	- 30	- 34 [·] 44
185	85	131	55	77	25	23	- 5	- 31	- 35
184	84 [·] 44	130	54 [·] 44	76	24 [·] 44	22	- 5 [·] 56	- 32	- 35 [·] 56
183 [·] 2	84	129 [·] 2	54	75 [·] 2	24	21 [·] 2	- 6	- 32 [·] 8	- 36
182	83 [·] 33	128	53 [·] 33	74	23 [·] 33	20	- 6 [·] 67	- 34	- 36 [·] 67
181 [·] 4	83	127 [·] 4	53	73 [·] 4	23	19 [·] 4	- 7	- 34 [·] 6	- 37
180	82 [·] 22	126	52 [·] 22	72	22 [·] 22	18	- 7 [·] 78	- 36	- 37 [·] 78
179 [·] 6	82	125 [·] 6	52	71 [·] 6	22	17 [·] 6	- 8	- 36 [·] 4	- 38
178	81 [·] 11	124	51 [·] 11	70	21 [·] 11	16	- 8 [·] 89	- 38	- 38 [·] 89
177 [·] 8	81	123 [·] 8	51	69 [·] 8	21	15 [·] 8	- 9	- 38 [·] 2	- 39
176	80	122	50	68 [·] 2	20	14	- 10	- 40	- 40
174 [·] 2	79	120 [·] 2	49	66	19	12 [·] 2	- 11	- 41 [·] 80	- 41
174	78 [·] 89	120	48 [·] 89	66 [·] 4	18 [·] 89	12	- 11 [·] 11	- 42	- 41 [·] 11
172 [·] 4	78	118 [·] 4	48	64	18	10 [·] 4	- 12	- 43 [·] 60	- 42
172	77 [·] 78	118	47 [·] 78	64 [·] 6	17 [·] 78	10	- 12 [·] 22	- 44	- 42 [·] 22
170 [·] 6	77	116 [·] 6	47	62	17	8 [·] 6	- 13	- 45 [·] 40	- 43
170	76 [·] 67	116	46 [·] 67	62 [·] 8	16 [·] 67	8	- 13 [·] 33	- 46	- 43 [·] 33
168 [·] 8	76	114 [·] 8	46	60	16	6 [·] 8	- 14	- 47 [·] 20	- 44
168	75 [·] 56	114	45 [·] 56	60	15 [·] 56	6	- 14 [·] 44	- 48	- 44 [·] 44
167	75	113	45	59	15	5	- 15	- 49	- 45
166	74 [·] 44	112	44 [·] 44	58	14 [·] 44	4	- 15 [·] 56	- 50	- 45 [·] 56
165 [·] 2	74	111 [·] 2	44	57 [·] 2	14	3 [·] 2	- 16	- 50 [·] 80	- 46
164	73 [·] 33	110	43 [·] 33	56	13 [·] 33	2	- 16 [·] 67	- 52	- 46 [·] 67
163 [·] 4	73	109 [·] 4	43	55 [·] 4	13	1 [·] 4	- 17	- 52 [·] 60	- 47
162	72 [·] 22	108	42 [·] 22	54	12 [·] 22	0	- 17 [·] 78	- 54	- 47 [·] 78
161 [·] 6	72	107 [·] 6	42	53 [·] 6	12	- 0 [·] 4	- 18	- 54 [·] 40	- 48
160	71 [·] 11	106	41 [·] 11	52	11 [·] 11	- 2	- 18 [·] 89	- 56	- 48 [·] 89
159 [·] 8	71	105 [·] 8	41	51 [·] 8	11	- 2 [·] 2	- 19	- 56 [·] 20	- 49
								- 58	- 50

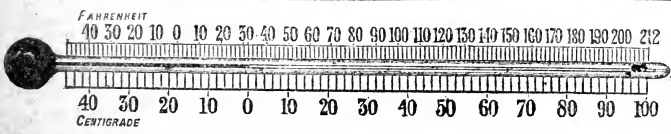

Illustrated by Fifty-three Plates and more than Eight Hundred Woodcuts, giving figures of nearly 3000 Microscopic Objects. 8vo. Cloth. £2 12s. 6d.

Griffith & Henfrey's Micrographic Dictionary:

A GUIDE TO THE EXAMINATION AND INVESTIGATION OF THE STRUCTURE AND NATURE OF MICROSCOPIC OBJECTS.

FOURTH EDITION.

Edited by J. W. GRIFFITH, M.D., &c., assisted by The Rev. M. J. BERKELEY, M.A., F.L.S., and T. RUPERT JONES, F.R.S., F.G.S., &c.

"A valuable handbook even for the advanced student of nature, to whom, moreover, the having such a vast mass of scattered zoological and botanical knowledge brought together within the compass of a single volume cannot but be exceedingly convenient."—*Annals of Natural History*.

LONDON: GURNEY & JACKSON, 1, PATERNOSTER ROW.
(SUCCESSORS TO MR. VAN VOORST.)

SWIFT & SON'S New 1/12 in. Homogeneous Immersion Objective of 1.25 N.A., in which the New Abbe-Schott glass is used, price £5 5s.

This lens SWIFT & SON guarantee to be equal to any other Homogeneous Immersion Objective of the same N.A.

SWIFT & SON are continually receiving testimonials in praise of the above Objective.

A New 1/12 in. Apochromatic Homogeneous Immersion Objective of 1.4 N.A., £16.

Compensating Eye-pieces, magnifying 10, 20, and 30 times, price each, £2.

These Eye-pieces also give excellent results with Objectives made with the old Media. Projection Eye-pieces for Photo-Micrography, magnifying 3 and 6 times, each £2.

For particulars of Professor Crookshank's Bacteriological Microscope, and Medical Press Comments, send for Circular.

UNIVERSITY OPTICAL WORKS,
81, TOTTENHAM COURT ROAD, LONDON, W.

ROYAL MICROSCOPICAL SOCIETY.

MEETINGS FOR 1891, at 8 p.m.

Wednesday, JANUARY 21	Wednesday, MAY 20
(Annual Meeting for Election of Officers and Council.)	" JUNE 17
" FEBRUARY 18	" OCTOBER 21
" MARCH 18	" NOVEMBER 18
" APRIL 15	" DECEMBER 16

Fellows intending to exhibit any Instruments, Objects, &c., or to bring forward any Communication at the Ordinary Meetings, will much facilitate the arrangement of the business thereat if they will inform the Secretaries of their intention two clear days at least before the Meeting.

Authors of Papers printed in the Transactions are entitled to 20 copies of their communications *gratis*. Extra copies can be had at the price of 10s. 6d. per half-sheet of 8 pages, or less, including cover, for a minimum number of 50 copies, and 6s. per 100 plates, if plain. Prepayment by P.O.O. is requested.

JOURNAL
OF THE
ROYAL MICROSCOPICAL SOCIETY.

OCTOBER 1891.

TRANSACTIONS OF THE SOCIETY

IX.—*The Foraminifera of the Gault of Folkestone.*—I.

By FREDERICK CHAPMAN.

(Read 21st October, 1891.)

PLATE IX.

OUR knowledge of the Foraminifera occurring in the Gault of England has hitherto been derived from collections of organisms from clay-washings of unknown horizons. The list published in the Geological Survey Memoir,* though comprising many varieties, has in some instances the disadvantage of uncertainty regarding the precise locality. The valuable paper of Dr. von Reuss † was based on specimens collected from clays of uncertain horizons.

Finding that the facies of Foraminifera from the Upper and Lower Gault beds showed marked differences, it seemed desirable that not only should the microzoa of the Gault be worked out at some definite locality, but that they should be collected at various levels throughout its thickness.

The section of Gault exposed at Copt Point, Eastwear Bay, Folkestone, being the most favourable, and one which has received most attention from stratigraphists, the author has, since December

EXPLANATION OF PLATE IX.

- Fig. 1.—*Nubecularia depressa* sp. n.
 " 2. " *nodulosa* sp. n.
 " 3a, b.—*Biloculina undulata* sp. n.
 " 4a, b.—*Spiroloculina asperula* Karrer.
 " 5a, b.—*Miliolina venusta* Karrer sp.
 " 6. " " broad variety.
 " 7. " *agglutinans* d'Orb. sp.
 " 8. " *Ferussacii* d'Orb. sp.
 " 9a, b. " *tricarinata* d'Orb. sp.
 " 10.—*Ophthalmidium tumidulum* Brady.
 " 11a, b.—*Cornuspira cretacea* Reuss.
 " 12a, b. " *involvens* Reuss.
 " 13a, b. " *foliacea* Philippi sp.

All the figures × 60.

* W. Topley, 'Geology of the Weald,' 1875, pp. 423-4.

† "Die Foraminiferen des norddeutschen Hils und Gault," Sitzungsber. K. Ak. Wiss. Wien, xlvi. pp. 5-105, pls. i.-xiii.

1885, employed himself in collecting and studying the Foraminifera from that locality.

The Gault at Copt Point has been divided into eleven zones by Messrs. C. E. De Rance, F.G.S.* and F. G. Hilton Price, F.G.S.† The divisions described by the latter author have been adopted in the present work.

Specimens of Gault were taken from each zone, and in some cases, where the same zone presented lithological differences, materials from more than one level were obtained. Thus from zone XI., which is 56 ft. 3 in. in thickness, specimens were taken at intervals of 5 ft. or more. In this work of collecting the clay samples I had the advantage of the assistance of John Griffiths, who has collected for very many years from all parts of this formation. The number of clay samples worked out was twenty-three.

My best thanks are due to my friend Mr. C. D. Sherborn, F.G.S., for his ready assistance at all times; to Professor J. W. Judd, F.R.S., for his counsel and for drawing my attention to the presence of borings of parasitic plants in the prisms of *Inoceramus* shells; to Professor T. R. Jones, F.R.S., for much useful advice; to Dr. D. H. Scott, for the information regarding the forms of parasitic plant-borings in the shells and fish remains from the Gault beds; and to Mr. J. W. Gregory, F.G.S., for the examination of many spines and other parts of Echinoderms. For the analyses of the various specimens of clays I am indebted to my friend Mr. S. Young. Mr. E. Halkyard, F.R.M.S., has kindly allowed me to examine his choice collection of Foraminifera from the Folkestone Gault, in which, however, I did not notice any forms new to my own series.

The following are the descriptions of the clays and their washings, given consecutively from the base to the top of the Gault.

Zone I. specimen *a*. From the greensand seam, above the line of nodules of sulphide of iron, with rolled fossils. A very dark green glauconitic clay. Residuum after washing, 33 per cent. of glauconitic sand, not including the rolled fossils intermingled. Many of the glauconitic grains are perfectly distinct casts of Foraminifera. The washed material consists mainly of bright green glauconite, with a few grains of quartz and chalcedony; also a small shark's tooth. The microzoa are scarce. There are prisms of *Inoceramus* (found in every bed throughout the Gault from the base to within 20 feet of the top), and fragments of other shells; these prisms and shell-fragments are tunnelled, the former in all cases, by borings of parasitic plants which Dr. D. H. Scott thinks may be referred to the genera *Ostracoblabe*, *Ostreobium*, and *Lithopythium*;‡ there is also a stelliform organism met with in the fish remains, shell fragments, and in *Nubecularia nodulosa*, which has been previously noticed by C. B.

* C. E. De Rance, Geol. Mag., 1868, p. 163.

† Q.J.G.S., xxx. p. 342; and 'The Gault: a Lecture,' London, 1879.

‡ MM. Bornet et Flahault, Bull. Soc. Bot. France, xxxvi. (1889) p. 147.

Rose* and Professor Kölliker.† These minute borings are not confined to any one stratum, but are well distributed throughout the whole of the Gault. The finest washings‡ consist of glauconite, angular quartz-grains, and *Anomalina ammonoides* Rss. sp.

Zone I., specimen *b*. From the level of 5 ft. above the base of the Gault. A greenish-grey clay, splashed with lighter markings. The proportion of sandy and shelly material remaining after washing is $1\frac{1}{4}$ per cent. The organisms are all very small. The washed material consists of glauconite, prisms of *Inoceramus*, fragments of *Nucula* and other testacea, spines of *Hemiaster*, numerous *Ostracoda*,§ *Foraminifera*, and fish remains. The fine washings consist of glauconite grains, angular quartz-grains, and prisms of *Inoceramus*; also *Bolivina textularioides* Rss. (generally filled with glauconite), very common; *Ramulina* sp., very rare; *Globigerina cretacea* d'Orb., very common; and *Anomalina ammonoides* Rss. sp., very common. The rotaline forms throughout the Gault are in very many cases filled with carbonate of lime, and each chamber of the shell shows a black cross between crossed nicols.

Zone II., specimen *a*. From the band of crushed *Ammonites*. A dark-green tenacious and fossiliferous clay; the fossils of a bright colour. Residuum after washing $12\frac{1}{2}$ per cent. The washed material consists of shelly sand, with some entire shells in a flattened condition. It is of great interest to note that although these larger shells show the effects of pressure, the microzoa remain intact. Spines of *Pseudodiadema* also occur here. The microzoa are not common. The finest washings consist of glauconite grains, prisms of *Inoceramus*, and angular quartz; also the following *Foraminifera*,—*Bolivina textularioides* Rss., frequent; *Globigerina cretacea* d'Orb., frequent; and *Anomalina ammonoides* Rss. sp., very common.

Zone II., specimen *b*. 11 ft. from the base of the Gault, from a bed 1 ft. thick. The clay is of a dark greenish-grey colour, full of shells. Residuum 4 per cent. consisting of shelly sand and containing crushed *Gastropods* and spines of *Hemiaster*. *Microzoa* are not common. The fine washings are glauconitic, and show a marked scarcity of quartz-grains; *Anomalina ammonoides* Rss. sp. is frequent.

Zone II., specimen *c*. A very dark clay from the level of 13 ft. above the base of the Gault, highly fossiliferous, with shells of rich colours. Residuum $6\frac{1}{2}$ per cent. of shelly material, containing *Gastropods* which are slightly crushed, and numerous fragments and prisms of *Inoceramus*. *Ostracoda* are common, with the valves frequently

* C. B. Rose, Trans. Micr. Soc. Lond., new series, iii. (1855) p. 7, pl. i.

† Kölliker, Quart. Journ. Micr. Sci., viii. p. 171.

‡ The fine washings referred to throughout this paper were all mounted in Canada balsam.

§ The *Ostracoda* of the Gault as already known have been described and figured in the Monograph of the Palæontographical Society for 1849 and 1849. See p. 572 of this paper.

united; the Foraminifera are not common. There are also numerous spines of *Hemiaster*. The fine washings consist almost entirely of glauconite, with a few grains of quartz; *Globigerina cretacea* d'Orb. frequent.

Zone III. "Crab Bed." The clay is of a pale brown or fawn colour, fine in texture, but not close. Residuum 5 per cent., of pale brown dusty sand with occasional shell fragments. There are also spines of *Hemiaster*. The specimens of *Globigerina* in this bed are of a whitish and weathered colour differing from those of other beds, where they are dark with a metallic lustre due to the infilling of their shells with pyrites. The Foraminifera are fairly common, and the Ostracoda are very abundant; the valves of the latter are often united. The fine washings contain a large proportion of tiny brown granular spherules, a little glauconite, occasional angular grains of quartz, and prisms of *Inoceramus*. The little brown spheroidal bodies are composed of carbonate of iron and appear to be casts of *Anomalina*, as a series may be made out, graduating from the infilled shell of the Foraminifer to the roughly spherical cast with its iron-stained umbilical depression. The fine washings on analysis yield 26.61 per cent. of metallic iron in the state of ferrous oxide. The following Foraminifera occur in these washings:—*Textularia pygmæa* Rss., common; *Bolivina textularioides* Rss., common; *Globigerina cretacea* d'Orb., very common; and *Anomalina ammonoides* Rss. sp., very common.

Zone IV. A dark green clay, very fossiliferous. The washed material consists of a brown shelly sand, $1\frac{3}{4}$ per cent. of the whole, with spines of *Hemiaster*. The Foraminifera are tolerably abundant and very small. The fine washings consist of glauconite, angular grains of quartz, and innumerable prisms of *Inoceramus*; also casts of *Anomalina* like those found in Zone III., though here very rare. The following Foraminifera occur in the washings:—*Lagena lævis* Montagu sp., one specimen; *Globigerina cretacea* d'Orb., frequent; and *Anomalina ammonoides* Rss. sp., frequent.

Zone V. "Coral Bed." A grey-blue clay. The residuum consists of $4\frac{1}{2}$ per cent. of somewhat sandy material, with a few shell fragments. The Foraminifera are very abundant; and the larger specimens are frequently filled with pyrites. Ostracoda are common. The fine washings consist of glauconite with numerous distinct casts of Foraminifera, a few angular grains of quartz, *Inoceramus* prisms, and numerous casts (in carbonate of iron) of *Anomalina*; also *Textularia pygmæa* Rss., frequent; *Bolivina textularioides* Rss., rare; *Globigerina cretacea* d'Orb., common; and *Anomalina ammonoides* Rss. sp., common.

Zone VI. "Mottled Bed." A blue-grey clay with dark-greenish spots and streaks; some of these markings are surrounded by rings of pyritous stain. The microzoa are very abundant, and *Rotalia spinulifera* Rss., is the commonest Foraminifer. The washed clay gives a

residuum of 7 per cent., which is composed mainly of glauconite and shell fragments. The fine washings consist of glauconite, a few Inoceramus prisms, shell fragments, many casts of *Anomalina*, a few angular grains of quartz, and the following Foraminifera:—*Lagena hispida* Rss., one specimen; *Globigerina cretacea* d'Orb., very common; and *Anomalina ammonoides* Rss., very common.

Zone VII. "Dark Bed." A dark-green clay, with a residuum of $6\frac{3}{4}$ per cent. after washing, consisting of sandy material with iridescent shell-fragments. The microzoa are fairly common; *Rotalia spinulifera* Rss. is excessively abundant; spines of *Hemiaster* and arm-joints of *Pentacrinus* also occur. The fine material consists of glauconite, a few angular quartz-grains, Inoceramus prisms, a very few granular casts of *Anomalina*, and the following Foraminifera:—*Nodosaria simplex* Silvestri, one specimen; *Globigerina cretacea* d'Orb., frequent; and *Anomalina ammonoides* Rss. sp., frequent.

Zone VIII. "Junction-bed" or "Nodule-bed." A pale-grey clay with an even texture. A residuum after washing of $4\frac{3}{4}$ per cent., of a dark colour, with a few shell fragments and spines of *Hemiaster*. The microzoa are common, with *Rotalia spinulifera* Rss. extremely common. The fine washings consist of glauconite, a few angular quartz-grains, prisms of Inoceramus, and the following Foraminifera:—*Globigerina cretacea* d'Orb., frequent; and *Anomalina ammonoides* Rss. sp., frequent. The granular casts of *Anomalina* are absent from this zone.

Zone IX. At 65 ft. below the top of the Gault. A somewhat dark blue-grey clay, with a residuum of $2\frac{3}{4}$ per cent. after washing. The washed material is of a grey colour, and contains many shell particles and spines of *Hemiaster*. Microzoa are common; the *Bulimines* very common. The fine washings contain an abundance of granular casts of *Anomalina*, a large quantity of Inoceramus prisms, many glauconite grains, and a very few angular grains of quartz; *Textularia pygmæa* Rss., one specimen; *Bolivina textularioides* Rss., frequent; *Nodosaria Jonesi* Rss., one specimen; *Globigerina cretacea* d'Orb., very common; and *Anomalina ammonoides* Rss. sp., very common.

Zone X. "Plicatula-bed." One foot in thickness, and 60 ft. from the top of the Gault. The clay is of a pale greenish-grey with shelly particles scattered throughout. The residuum after washing is $8\frac{1}{2}$ per cent., and consists almost entirely of shelly material, with two shark's teeth and joints of the stems and arms of *Pentacrinus*. The microzoa are very abundant. The fine washings consist of numerous Inoceramus prisms, some glauconite, granular casts of *Anomalina*, angular grains of quartz, which are scarce, and the following Foraminifera:—*Textularia pygmæa* Rss., rare; *Bolivina textularioides* Rss., rare; *Bulimina* sp., one specimen; *Cristellaria* sp., one specimen; *Globigerina cretacea* d'Orb., common; and *Anomalina ammonoides* Rss. sp., very common.

Zone XI. 55 ft. from the top of the Gault. A pale-grey marly clay, somewhat tenacious. The residuum after washing, 5 per cent. of greenish-grey sandy material, with numerous prisms of Inoceramus. The Foraminifera are not very common, and rather small; Ostracoda are frequent. The fine washings contain prisms of Inoceramus, glauconite, angular grains of quartz, rather scarce, granular casts of Anomalina, and the following Foraminifera:—*Textularia pygmæa* Rss., frequent; *Ramulina globulifera* Brady, rare; *Globigerina cretacea* d'Orb., very common; and *Anomalina ammonoides* Rss. sp., very common.

Zone XI. 50 ft. from the top of the Gault. A tenacious marly clay, of a pale-grey colour, containing 40·69 per cent. of CaCO₃. A residuum after washing, 1½ per cent. of grey shelly material, with many brown cylindrical stem-like casts? Foraminifera are common; Bulimines very common. Ostracoda are fairly common. The fine washings consist largely of *Globigerina* and other Foraminifera. There are also some shell fragments, a very few prisms of Inoceramus, a few granular casts of Anomalina, angular grains of quartz (extremely rare), and glauconite (rare). The following Foraminifera also occur in the fine washings:—*Miliolina venusta* Karrer sp., frequent; *Textularia pygmæa* Rss., frequent; *Bolivina textularioides* Rss., frequent; *Nodosaria* sp., one specimen; *Dentalina catenula* Rss., one specimen; *Dentalina communis* d'Orb., frequent; *Globigerina cretacea* d'Orb., very abundant; and *Anomalina ammonoides* Rss. sp., very common.

Zone XI. 45 ft. from the top of the Gault. A pale-grey marly clay. The residuum after washing, 3 per cent., consists of fine sandy material with some spines of *Pseudodiadema*. Microzoa are very abundant; *Globigerinæ* are excessively abundant in the fine washings. The fine washings contain shell fragments, granular casts of Anomalina in abundance, many Inoceramus prisms, some scattered grains of glauconite, and very few angular grains of quartz, also the following Foraminifera:—*Nubecularia nodulosa* sp. n., one specimen; *Miliolina venusta* Karrer sp., frequent; *Textularia pygmæa* Rss., common; *Bolivina textularioides* Rss., common; *Lagena apiculata* Rss., one specimen; *Lingulina semiornata* Rss., one specimen; *Ramulina aculeata* d'Orb. sp., frequent; *Globigerina cretacea* d'Orb., extremely abundant; *Spirillina vivipara* Ehrenb., one specimen; and *Anomalina ammonoides* Rss. sp., very common.

Zone XI. 40 ft. from the top of the Gault. A pale-grey marly clay. The residuum after washing, 1 per cent. of sandy material with brown stem-like fragments. Microzoa are common. During disintegration by washing, this clay shows a tendency to separate into distinct laminae, possibly due to intervals of rest during deposition. The *Globigerinæ* are not so abundant as in the last two samples. The fine washings contain shell fragments, and the parasitic borings in those of this bed are very well developed and abundant. There

are also many Inoceramus prisms, a few glauconite grains, and very few angular grains of quartz, but no casts of Anomalina. The following Foraminifera are also met with in the fine washings:—*Miliolina venusta* Karrer sp., frequent; *Textularia pygmæa* Rss., very common; *Textularia conica* d'Orb., frequent; *Bolivina textularioides* Rss., common; *Dentalina communis* d'Orb., frequent; *Ramulina globulifera* Brady, frequent; *Globigerina cretacea* d'Orb., very common; and *Anomalina ammonoides* Rss. sp., very common.

Zone XI. 35 ft. from the top of the Gault. A pale-grey marly clay, with 37·58 per cent. of CaCO₃, and a residuum of sandy material 1¼ per cent. with the brown cylindrical fragments. Microzoa are fairly common. The fine washings consist chiefly of *Globigerina*; with a few angular quartz-grains and Inoceramus prisms; glauconite common in the interior of Foraminifera, but scarce as free casts or grains; a few of the granular casts of Anomalina, and the following Foraminifera:—*Textularia pygmæa* Rss., common; *Bolivina textularioides* Rss., frequent; *Lagena hispida* Rss., one specimen; *Lagena lævis* Montagu sp., one specimen; *Ramulina globulifera* Brady, frequent; *Globigerina cretacea* d'Orb., very common; and *Anomalina ammonoides* Rss. sp., very common.

Zone XI. 30 ft. from the top of the Gault. A pale-grey marly clay. A residuum of sandy material, 1¾ per cent. Microzoa are not very common. The fine washings contain a little glauconite, a few prisms of Inoceramus, very few angular quartz grains, and the following Foraminifera:—*Textularia pygmæa* Rss., common; *Bolivina textularioides* Rss., frequent; *Lagena apiculata* Rss., one specimen; *Lagena lævis* Montagu sp., one specimen; *Polymorphina sororia* var. *cuspidata* Brady, one specimen; *Ramulina globulifera* Brady, frequent; *Globigerina cretacea* d'Orb., very common; and *Anomalina ammonoides* Rss. sp., very common.

Zone XI. 25 ft. from the top of the Gault. A heavy pale-grey marly clay. A residuum of fine sandy material, 4¾ per cent. Microzoa are very common. The fine washings consist almost entirely of the shells of *Globigerina*, with a few glauconite grains, a few angular quartz-grains, shell fragments, a very few casts of Anomalina, a few prisms of Inoceramus, fish remains, and the following Foraminifera:—*Nubecularia nodulosa* sp. n., one specimen; *Miliolina venusta* Karrer sp., rare; *Textularia pygmæa* Rss., common; *Bolivina textularioides* Rss., frequent; *Lingulina semiornata* Rss., one specimen; *Globigerina cretacea* d'Orb., very common; and *Anomalina ammonoides* Rss. sp., very common.

Zone XI. 20 ft. from the top of the Gault. A dull grey-green rock, or argillaceous greensand; when struck with a hammer presenting a bright-green surface, due to the fractured particles of glauconite. A residuum of a dark-green sand with a few shelly particles, 30 per cent. Microzoa are frequent, and spines of *Pseudodiadema*. The fine washings consist of a little more than one-half

green glauconite grains, nearly all the remainder being beautifully preserved Foraminifera; there are also numerous fish-bones and teeth, frequently exhibiting very fine borings of parasitic plants; the shell fragments also show very good examples of the plant-borings; and angular grains of quartz, more abundant than in the zones previously mentioned. In the fine washings are also the following Foraminifera:—*Textularia conica* d'Orb., one specimen; *Textularia pygmæa* Rss., very common; *Bolivina textularioides* Rss., very common; *Pleurostomella eocæna* Gumbel, frequent; *Lagena gracilis* Will., one specimen; *Globigerina cretacea* d'Orb., very common; and *Anomalina ammonoides* Rss. sp., very common.

Zone XI. 12 ft. from the top of the Gault. A pale-grey marly clay. A residuum after washing, 2¼ per cent. The washings consist of a pale-grey sand, with numerous fish remains and coprolites; microzoa are tolerably common. The fine washings consist almost entirely of well-preserved Foraminifera, with a few glauconite grains, numerous angular quartz-grains, fish-bones, and calcareous fragments with good parasitic plant-borings, and the following Foraminifera:—*Textularia pygmæa* Rss., very common; *Textularia gramin* d'Orb., one specimen; *Bolivina textularioides* Rss., frequent; *Ramulina globulifera* Brady, frequent; *Globigerina cretacea* d'Orb., very common; and *Anomalina ammonoides* Rss. sp., very common.

Zone XI. 6 ft. from the top of the Gault. A pale-grey marly clay, with a residuum of 1 per cent. of pale-grey sandy material, containing fish remains and tiny coprolites. Microzoa are common. The fine washings contain glauconite, much angular quartz, fish remains with plant-borings, and a fish-tooth; also the following Foraminifera:—*Textularia pygmæa*, Rss. frequent; *Ramulina globulifera* Brady, rare; *Globigerina cretacea* d'Orb., common; and *Anomalina ammonoides* Rss. sp., common.

The new species of Ostracoda will be described, and all the species of the Gault will be tabulated in a paper shortly by Mr. C. D. Sherborn and myself. (See also *ante*, p. 567.)

On the Foraminifera I now proceed to speak.

Family MILIOLIDÆ.

Sub-family NUBECULARIINÆ.

NUBECULARIA Defrance [1825].

Nubecularia depressa, plate IX. fig. 1.

This form consists of six more or less flask-shaped chambers, disposed in a curved line; slightly depressed, and adherent, in this example, to a fish-scale. The test has the true porcellanous appearance, being milky white. At the junction of the two last chambers the stoloniferous tube divides. Only one specimen was found. Zone XI., 35 ft. from the top of the Gault.

Nubecularia nodulosa, plate IX. fig. 2.

A free-growing form, having nodulous chambers united by slender stoloniferous tubes, and rectilinear in growth. All the specimens found are apparently fragments; the longest consisted of four chambers. This form resembles in some points *N. divaricata* Brady; but, on the whole, it appears to be a distinct form, and confined to the Gault. The aperture is a simple orifice, and not phialine, as in the form described by Dr. Brady. It occurs in zone iv., rare; zone v., frequent; zone x., rare; zone xi., 55 ft. from the top, rare; 50 ft., frequent; 45 ft., common; 35 ft., common; 25 ft., common; 6 ft., very rare.

Sub-family MILIOLININÆ.

BILOCULINA d'Orbigny [1826].

Biloculina undulata, plate IX. figs. 3 *a* and *b*.

A form which resembles *B. depressa* d'Orb. in contour, but with both surfaces of the test ornamented with concentric undulating ridges. One specimen only, from zone xi., 25 ft. from the top.

SPIROLOCULINA d'Orbigny [1826].

Spiroloculina asperula Karrer, plate IX. fig. 4.

Spiroloculina asperula Karrer, 1868, Sitzungsb. k. Ak. Wiss. Wien, vol. lvii. p. 136, plate i. fig. 10.

Recorded by Dr. Karrer from the Miocene of Kostej; and by Dr. Brady as a recent, comparatively shallow water form. One very fine specimen, from zone xi., 55 ft. from the top.

MILIOLINA Williamson [1858].

Miliolina venusta Karrer sp., plate IX. figs. 5 *a* and *b*, and 6.

Quinqueloculina venusta Karrer, 1868, Sitzungsb. k. Ak. Wiss. Wien, vol. lvii. p. 147, plate ii. fig. 6.

Recorded from the Miocene of Kostej (Karrer), from the London Clay of Piccadilly (Sherborn and Chapman), and noted by Dr. Brady as an essentially deep-water form. This variety is a very distinct one in the Gault series of Miliolines; with but one exception, however, which presents a broader aspect than the type, and of which a figure is given. This Foraminifer makes its appearance in the Gault in zone x., where it is very common; also in zone xi., 55 ft. from the top, very common; 50 ft., very common; 45 ft., frequent; 40 ft., frequent; 35 ft., frequent; 30 ft., frequent; 25 ft., very common; 20 ft., common; 12 ft., common; 6 ft., very rare.

Miliolina agglutinans d'Orbigny sp., plate IX. fig. 7.

Quinqueloculina agglutinans d'Orbigny, 1839, Foram. Cuba, p. 168, plate xii. figs. 11-13.

It is, perhaps, worth noting that this variety has only before been found in the fossil condition in the Post-tertiary clays of Norway and the west of Scotland. It is a scarce form in the Gault, one example only having occurred in each of the levels in which it is found. Zone xi., 55 ft. from the top; 20 ft.; and 12 ft.

Miliolina Ferussacii d'Orbigny sp., plate IX. fig. 8.

Quinqueloculina Ferussacii d'Orbigny, 1826, Ann. Sci. Nat., vol. vii. p. 301, No. 18; Modèle, No. 32.

The Gault specimens are very variable, but can be readily assigned to this species. The figure is from a good type specimen, the variation tending towards depression of the ribs. In its occurrence it shows a tendency to supersede *M. venusta*, as it increases in frequency towards the top of the Gault, whilst *M. venusta* becomes less common. This variety appears in zone xi., 45 ft. from the top, very rare; 35 ft., rare; 12 ft., very common; 6 ft., common.

Miliolina tricarinata d'Orbigny sp., plate IX. figs. 9 a and b.

Triloculina tricarinata d'Orbigny, 1826, Ann. Sci. Nat., vol. vii. p. 299, No. 7; Modèle, No. 94.

Hitherto this species has not been obtained from any formation earlier than the Eocene. Found in zone xi., 45 ft. from the top, rare; 30 ft., very rare.

Sub-family HAUERININÆ.

OPHTHALMIDIUM Zwingli and Kübler [1870].

Ophthalmidium tumidulum Brady, plate IX. fig. 10.

Ophthalmidium tumidulum H. B. Brady, Chall. Rep., 1883, p. 189, plate xii. fig. 6.

This interesting Foraminifer resembles *Cornuspira* in external appearance, but when rendered transparent the Spiroloculine arrangement of the later segments can be clearly made out. Zone iv., very rare; zone xi., 55 ft. from the top, rare; 40 ft., rare; 35 ft., very rare.

Sub-family PENEROPLIDINÆ.

CORNUSPIRA Schultze [1854].

Cornuspira cretacea Reuss, plate IX. figs. 11 a and b.

Operculina cretacea Reuss, Verstein. d. böhm. Kreideform., 1845, p. 35, plate xiii. figs. 64 and 65. *Cornuspira cretacea* Reuss, Sitzungsab. Ak. Wiss. Wien, 1860, vol. xl. p. 177, plate i. fig. 1.

This species is easily recognized by the thickened growth of the wall of the shell, especially in the last few whorls, which are generally superficially puckered. Moreover, the sections in some of the older specimens show the shell to be markedly biconcave. It appears both in the Lower and Upper Gault, but is more characteristic of the higher beds, where it is also better developed in point of size. Zone iii., very rare; zone iv., common; zone ix., very rare; zone x., very rare; zone xi., 55 ft. from the top, frequent; 50 ft., common; 45 ft., very rare; 40 ft., common; 30 ft., very rare; 25 ft., very rare; 12 ft., frequent; 6 ft., rare.

Cornuspira involvens Reuss, plate IX. figs. 12 a and b.

Operculina involvens Reuss, 1849, Denkschr. k. Ak. Wiss. Wien, vol. i. p. 370, plate xlv. fig. 20. *Cornuspira involvens* Reuss, 1863, Sitzungsab. k. Ak. Wiss. Wien, vol. xlviii. p. 39, plate i. fig. 2.

The shell of this species is biconcave, and the whorls increase rapidly in size towards the margin. A variation may be traced from this form to *C. cretacea* by the shell losing its roundness, consequently less embracing, and the surface becoming puckered. The earliest strata in which it has hitherto been found are the Septaria clays of North Germany, the Baden Beds of the Vienna Basin, and the *Clavulina-Szabói* Beds of Hungary. Zone iii., very rare; zone v., very rare; zone vi., very rare; zone xi., 55 ft. from the top, rare; 50 ft., very rare; 12 ft. very rare.

Cornuspira foliacea Philippi sp., plate IX. figs. 13 a and b.

Orbis foliaceus Philippi, 1844, Enum. Moll. Sicil., vol. ii. p. 147, plate xxiv. fig. 26. *Cornuspira foliacea* Parker and Jones, 1865, Phil. Trans., vol. clv. p. 408, plate xv. fig. 33.

The shell is uniformly thin. The Gault specimens do not exhibit so sudden an increase in the width of the last turn or so of the shell as do the typical recent specimens. Zone iv., very rare; zone xi., 55 ft. from the top, very rare; 45 ft., very rare; 30 ft., very rare.

SUMMARY

OF CURRENT RESEARCHES RELATING TO

ZOOLOGY AND BOTANY

(principally Invertebrata and Cryptogamia),

MICROSCOPY, &c.,

INCLUDING ORIGINAL COMMUNICATIONS FROM FELLOWS AND OTHERS.*

ZOOLOGY.

A. VERTEBRATA:—Embryology, Histology, and General.

a. Embryology.†

Origin of Vertebrata.‡—Prof. A. Lameere does not agree with those who think that the ancestor of the Vertebrata is to be found among Worms; he thinks that everything shows that they are derived from an Actinozoon in which the neural face remained superior in position. It was probably pelagic in habit, and did not, like most of its allies, become fixed after a free larval stage. For such an animal it would be a great advantage to be provided with a thickening of the endoderm which would give rise to a rigid axis; it would be still more advantageous if the tentacles were, as organs of locomotion, provided with proto-vertebræ; it is, in fact, in *Amphioxus* and Fishes that derivatives of these are used as locomotor organs, the fins serving only as directing organs. There would appear to be no direct relationship between the Chordata and the Echinodermata or Vermes.

Fertilization of Newts.§—Dr. E. Zeller observes that the females of *Triton* (*T. alpestris*, *T. tæniatus*, &c.) are active in availing themselves of the spermatophores. But it is not true, as he formerly believed, that the female removes the mass of sperms by the open lips of the cloaca. The female brings herself into contact with the end of the tag of sperms, and these attach themselves to the closed cloacal slit. The spermatozoa actively insinuate themselves through the slit of the cloaca, and are collected in the receptaculum seminis.

* The Society are not intended to be denoted by the editorial "we," and they do not hold themselves responsible for the views of the authors of the papers noted, nor for any claim to novelty or otherwise made by them. The object of this part of the Journal is to present a summary of the papers *as actually published*, and to describe and illustrate Instruments, Apparatus, &c., which are either new or have not been previously described in this country.

† This section includes not only papers relating to Embryology properly so called, but also those dealing with Evolution, Development, and Reproduction, and allied subjects.

‡ Bull. Soc. Belge de Microscopie, xvii. (1891) pp. 91-121.

§ Zeitschr. f. Wiss. Zool., li. (1891) pp. 737-41 (1 fig.).

The Blastopore in Meroblastic Ova.*—Herr N. Cholodkovsky seeks to unify the various forms of blastopore in meroblastic ova. In the crayfish, the endodermic disc is surrounded by an annular groove and is gradually invaginated into the yolk. In birds, the homologue of the blastopore is the sickle-shaped groove from which the primitive groove extends forward. In *Chalicodoma muraria*, according to Carrière, the median part of the germinal area is bordered laterally by two furrows, which pass at either end into the originally superficial but subsequently invaginated endodermic rudiments. In Muscidæ and in *Phyllodromia*, besides the primitive groove, there are two pairs of lateral furrows or pits which are separated by uninvasinated spaces, and seem rudiments of the complete annular groove of *Astacus* and *Chalicodoma*. "In *Phyllodromia* the primitive groove, extending from behind forwards, bears to the posterior pair of lateral invaginations the same relation that the primitive groove in birds bears to the sickle-shaped groove, which is probably the remains of an original annular groove. In Muscidæ, the primitive groove which begins at the anterior end, bears a similar relation to the anterior pair of lateral invaginations, which are probably remains of the anterior half of the annular groove." The broad and flat primitive groove of *Hydrophilus* recalls the lateral grooves in Apidæ; it is formed from lateral grooves which begin anteriorly and posteriorly, and represent both halves of the original annular groove. The forms of primitive groove in insects are not all homologous. "While the blastopore of *Hydrodoma*, *Apis*, and *Chalicodoma* is nearly related to the typical form in meroblastic ova, and represents the entire endodermic disc of *Astacus*, the primitive groove of Muscidæ and of *Phyllodromia* (like that of birds) represents only a median outgrowth of the rudimentary annular groove, and perhaps serves solely for the formation of mesoderm, the endodermic rudiments perhaps arising (as Graber suggests) from the complementary lateral invaginations. In some insects, therefore, the primitive groove represents the whole blastopore, in others only a part."

The Eggs and Embryos of the Crocodile.†—Dr. A. Voeltzkow has studied these in Madagascar, where *Crocodilus niloticus* is very common. The egg-laying lasts from the end of August to the end of September. The number of eggs in a nest varies from twenty to thirty. The nest is dug about two feet deep in the dry white sand; the bases of its walls are gouged out, and into the lateral excavations thus formed the eggs roll from the slightly raised centre of the nest-floor. Externally the nest is not discernible, but the parent sleeps upon it. The eggs differ greatly in form; the shell is white, thick, and firm, either rough or smooth; the double shell-membrane is so firm that the egg keeps its form after the shell has been removed; the albumen is a jelly firm enough to be handled, and the vitelline membrane is also very strong. When newly laid the eggs are very sensitive, and are readily killed by damp or by heat; the older eggs, however, are quite hardy. When the young embryos are about to be hatched, they utter very distinct notes. These calls the mother hears, even through two feet of sand, and proceeds to dig open the nest. Even the natives were unaware of the

* Zool. Anzeig., xiv. (1891) pp. 159-60 (1 fig.).

† SB. K. Preuss. Akad. d. Wiss., 1891, pp. 115-20.

manner in which the attention of the mother is called to her young. Before hatching the embryo turns, and in so doing partially tears the foetal membranes. With the tip of its snout turned to one end of the egg, the young animal bores through the shell with a double-pointed tooth comparable to that which young birds possess. This tooth appears very early—by the time the embryo is six weeks or two months old; it may still be seen a fortnight after hatching. Through the small perforation made by the tooth the embryonic fluid flows out, softening the adjacent parts, and the whole is widened into a cleft. The process of creeping out may take about two hours. The young animal seems large in comparison with the egg; thus one measuring 28 cm. in length came out of an egg 8 cm. long and 5 cm. broad. The young crocodiles are very wild little animals and are led to the water by the mother. They utter sounds, especially when hungry, but the pitch of their call is not so high as it was within the egg. Of the development, which takes about three months, some account is promised; but the embryos are extraordinarily delicate and their investigation is proportionately difficult.

Development of the Optic Nerves.*—Prof. A. Frioriep finds from his investigation of the embryos of *Torpedo ocellata* that the first nerve-fibres of the optic nerve originate in the rudiment of the retina, whence they grow centralwards along the stalk of the optic vesicle. Keibel has observed the same in the embryos of Reptiles, but of this Frioriep was unaware until he had completed his researches.

Histogenesis of the Neuroglia.†—Prof. P. Lachi finds that there are two important periods in the development of the neuroglia of the chick's spinal cord,—one limited by the 8th or 9th day of incubation, the other extending from this until the first few days after hatching. In the first period, the neuroglia is represented solely by ectodermic spongioblasts; in the second period these are joined by mesenchyme elements, which appear first in the white matter, but afterwards insinuate themselves into the grey. The new mesenchyme elements increase rapidly by indirect division, and towards the end of incubation they exhibit the prolongations characteristic of neuroglia cells. To these mesenchyme cells others of vascular origin—either endothelial cells or leucocytes—are added. From the twelfth day of incubation, Lachi observes the transformation and destruction of the spongioblasts, but their definite fate still requires investigation.

Development of Blood in Embryonic Liver.‡—Dr. O. Van der Stricht has studied the development of blood in the embryonic liver of representatives of various groups of Vertebrates. The hepatic cells themselves present special characters by which they may be easily distinguished from the adjoining blood-cells; they are rich in fatty granulations, and their protoplasm has a reticulated structure. In the first stages of intra-uterine life the liver of Mammals has a close resemblance to that of lower Vertebrates, and like theirs is formed of rows of hepatic cells arranged in a plexus; later on a fresh capillary plexus is intercalated on the course of the one already present, and while the

* Anat. Anzeig., vi. (1891), pp. 155-161 (12 figs).

† Atti Soc. Tosc. Sci. Nat., xi. (1891) pp. 266-310 (3 pls.).

‡ Arch. de Biol., xi. (1891) pp. 19-113 (2 pls.).

latter is inter-, the former is intra-trabecular. This latter attains an extraordinary development and the contents of the vessels of the two sets is quite different. The intra-trabecular plexus serves as a substratum for the multiplication of red cells, and the author proposes, therefore, to call it the hæmatopoetic capillary plexus.

Within the vessels are found, firstly, erythroblasts; these give rise to the red cells and have the form of elements with a characteristic, rounded nucleus, abundance of chromatin, arranged in a plexus; there is not much protoplasm, and what there is is homogeneous. The first erythroblasts of the liver are derived from young nucleated red cells which exist from the time of the appearance of blood in the embryo; they are more or less charged with hæmoglobin, but, later on, the products of their multiplication are colourless erythroblasts. The formation of new erythroblasts is effected by indirect division of pre-existing elements of the same kind; as long as the liver has its primitive character this multiplication is not very active. It becomes more marked on the appearance of the hæmatopoetic plexus. The conversion of erythroblasts into adult red corpuscles is effected by a series of changes of the nucleus and protoplasm which end with the removal of the nucleus.

After leaving the blood-corpuscle the free nucleus undergoes a series of changes; these are modifications of retrogression or normal degeneration; they end with the complete destruction of the nucleus which is effected either by chromatolysis or by phagocytosis. On the whole it would appear that the embryonic liver is just as much a hæmatopoetic organ as the osseous medulla of Birds.

The next of the contents of the vessels are the white cells; the leucoblasts are said to be characterized by the structure of their nucleus, the appearance of their protoplasm, and by the great delicacy of their cell-membrane; in the early stages of hepatic development the white cell is a phagocyte, and takes part in destroying the freed nuclei of the erythroblasts. The liver has probably some influence on the multiplication of leucoblasts; especially in very young embryos.

The last constituent is represented by the giant-cells; their protoplasm is often differentiated into distinct layers; vacuoles are present; the cellular contours are sometimes very irregular; the cells may exhibit prolongations in the form of pseudopodia or of finer processes; the cell is not bounded by a true membrane. These giant-cells take part in the destruction of the nuclei of the red corpuscles, being absorbed by phagocytosis. Some of the cells bud but they take no part in forming the red corpuscles. The giants multiply by direct division into two or into several daughter-cells similar to the parent cell; they are not retrograding elements, but cells with an independent existence, with a definite part to play, and multiplying like other cells; they appear to be derived from the leucoblasts.

B. Histology.

Structure of the Cell.*—Dr. C. C. Schneider has studied the ova of *Strongylocentrotus*, *Ascaris*, *Tiara*, &c., the young male-cells of *Astacus* and *Ascaris*, besides *Trichoplax adhærens*, *Vorticella*, &c. The cells

* Arbeit. Zool. Inst. Univ. Wien (Claus), ix. (1891) pp. 179-224 (2 pls.).

investigated have a framework of fine fibres; these are uniformly thick, optically distinguishable from the matrix, and have a coiled course; they form a meshwork but are not connected at their intersections. The fibres are seen to be movable (in the cilia of *Trichoplax*), and they may assume a straight course (in cilia and in division). Nucleus and protoplasm have a similar framework, the connectedness of which is not hindered by the nuclear membrane. The membranes of nuclei, vacuoles, and many cells arise from the coalescence of parts of the fibres. The chromatin-masses and nucleoli observed consisted of chromatin-granules fused in the meshes of the framework and around the fibres. A nucleolus is characterized by the presence of a membrane formed from the framework, the stainable granules are incapable of movement, but are displaced by the movement of the framework. "Chromatophores" arise from the attachment of chromatin-granules to a support formed from coalesced fibres. The attraction-sphere is at first an arbitrary, subsequently a spherical portion of the cell, in which the fibres are fixed by a homogeneous connecting mass. The "polar sun" and spindle arise from an extension of numerous fibres proceeding from the sphere; the extension is perhaps associated with the division of the sphere and the transport of its halves to the poles of the spindle, as also with the formation of "chromatophores." Neither attraction-sphere nor "polar sun" are essentially characteristic of division, nor is a homogeneous circular space untraversed by fibres a constant characteristic of the attraction-sphere. The spindle-fibres which unite sphere and "chromatophores" secure by their contraction the division of the latter. In the segmentation-spindle of *Ascaris megalcephala* the mass connecting the fibres in the spheres arises from the conical body of the spermatozoon. In the growing zone of the ovarian and testicular tubes of *Ascaris megalcephala univalens*, the diffuse chromatin material is collected into a more or less defined clump, which, by division into four, forms the chromatin elements of four spermatozoa, or the single element of the ripe ovum and three polar bodies. Finally, Herr Schneider seeks to explain the import of the nuclear membrane in keeping the chromatin together, and the numerical constancy of the "chromatophores" in the reproductive cells.

Pigment-cells.*—Dr. B. Solger finds in the dermic pigment-cells of the pike's head most admirable illustrations of attraction-spheres. They are very well seen in the pigment-cells of the frontal and ethmoidal regions; in the supra-orbital region, however, the individual cells are not readily defined. Sometimes there were several nuclei, but never more than one attraction-sphere in the cells; and Solger thinks that the presence of several nuclei without hint of more than one attraction-sphere must imply that amitotic nuclear division occurs.

Minute Structure of Spermatozoa of Mammalia.†—Dr. E. Ballo-witz has continued his researches on the minute structure of the spermatozoa of Mammals. About a score of species have been studied, several Bats having first been examined. He finds confirmation of the view that the axial filament consists of two apposed bundles of the finest elementary fibrils held together by a connecting substance; these fibrils which,

* Anat. Anzeig., vi. (1891) pp. 162-5 (2 figs.).

† Zeitschr. f. Wiss. Zool., lii. (1891) pp. 217-93 (3 pls.).

again, are connected with one another by a substance, traverse the whole of the flagellum of the spermatozoon from the beginning to the end of the axial filament. These fibrils are the contractile elements, and they have exactly the same relations as in the spermatozoa of other Vertebrates and of Invertebrates.

The relations of the axial cord to the neck vary considerably. In some, as in the Rat, the terminal knob is continuous with the anterior limit of the investment of the connecting piece; no "neck-piece" is therefore present, and the "neck" is only occupied by connecting substance. In most Mammals the anterior end of the axial cord passes freely through the "neck" as a "neck-piece," and is inserted, by means of its terminal knob, in the pit at the hinder edge of the head by means of a very small quantity of connecting substance. In other species, lastly, the "neck-piece" of the axial cord is divided into its two halves in the "neck" itself; these are attached to the hinder margin of the head by means of a small quantity of connecting substance.

The head of the mature mammalian spermatozoon consists of the true head and the head-cap; the latter often, and very probably always, persists. The true head is made up of the anterior and the posterior piece which are, in the course of development, derived from the nuclear hemispheres detected by Merkel. Between these two portions there is, in some Mammals, an internal body in the form of a semilunar and sharply-bounded area.

B. INVERTEBRATA.

Prof. Haddon's Collections in Torres Straits.—Some reports have now been issued on the zoological collections made by Prof. A. C. Haddon in Torres Straits in 1888-9. Mr. E. A. Smith* writes on the land Mollusca, of which only a few specimens were collected; their interest lies in the additions made to our knowledge of their geographical range, and, in one or two cases, they exhibit considerable variations in size. Sixty-six specimens of Lepidoptera, which represent twenty species and varieties, are recorded by Mr. G. H. Carpenter; † Australian, Austro-Malayan, and Oriental forms were all found. Mr. R. Kirkpatrick ‡ reports on the Polyzoa and Hydrozoa; of the former twenty-seven species were collected, of which four are new, and there are also four new varieties; in the somewhat smaller collection of Hydrozoa there were also four new species.

Mollusca.

a. Cephalopoda.

Changes in the Retinal Pigment of Cephalopods.§—Dr. B. Rawitz has experimented with *Eledone moschata*, *Sepia officinalis*, and *Sepioida Rondeletii*, and finds that the disposition of the pigment about the retinal cells changes when the animals are kept in darkness. It disappears from the free, inner ends of the rods, retreating to the posterior basal parts.

* Scientific Proc. Roy. Dubl. Soc., vii. (1891) pp. 5-13.

† Tom. cit., pp. 1-5.

‡ Op. cit., vi. (1890) pp. 603-26 (4 pls.).

§ Zool. Anzeig., xiv. (1891) pp. 157-8.

The retreat is proportionate to the time in which the Cephalopods are kept dark. Thus, what is true of Arthropods and Vertebrates is true of Cephalopods also. Full details are promised.

γ. Gastropoda.

Anatomy of Daudebardia and Testacella.*—Dr. L. Plate has investigated five species of *Testacella* and two species of *Daudebardia*, but his memoir describing these also contains numerous observations on the comparative anatomy of other Opisthopneumatous Pulmonates. He signalizes the following as the three most important general results of his work. Many structural peculiarities of *Testacella* occur in less differentiated form in *Daudebardia*, the latter thus linking the *Hyalina*- and *Testacella*-types. The divergent position of the kidney and heart on the roof of the pulmonary chamber may be referred to two conditions, both associated with the carnivorous diet, to the displacement of the mantle-cavity to the hind end of the body, and to the formation of an air-reservoir in connection with the pulmonary chamber; the *Testacella*-types are derived from prosopneumatous forms, their opisthopneumatous characteristic being secondarily acquired. The hypothesis of the diphyletic origin of the Pulmonata (von Ihering's Branchiopneusta and Nephropneusta) is not reconcilable with the fact that the *Testacella*-types have in the hindmost corner of the pulmonary cavity a smelling organ obviously homologous with the sense-organ which Spengel has demonstrated in other Gastropods.

Geographical Distribution of Slugs.†—Mr. T. D. A. Cockerell is of opinion that the "Slugs" are a polyphyletic group, and that five of the six constituent families are more nearly allied to as many testaceous groups than to one another. The families recognized are the Succineidæ, the Vaginulidæ, the Arionidæ (allied to the Helicidæ), the Limacidæ (allied to the Zonitidæ), the Testacellidæ (allied to the Oleacinidæ), and the Selenitidæ. The paper gives only a detailed statement of facts.

Larval Form of Parmophorus.‡—M. L. Boutan discovered near Suez some small black masses a few millimetres in diameter; these were Gastropods, the shell of which was partly covered by the lobes of the mantle; he was fortunate enough to find a series of forms which led at last to the adult. The author has already shown that the larva of *Fissurella* passes through stages at which other generic types rest, and the present discovery confirms that view.

δ. Lamellibranchiata.

Lamellibranchiata.§—Dr. P. Pelseuer treats very fully of this class, giving first details of descriptive anatomy, then a comparative anatomy of the organs under nine heads, and lastly discussing their relations to one another and to other Molluscs. He has convinced

* Zool. Jahrb., iv. (1891) pp. 505-630 (6 pls.).

† Proc. Zool. Soc. Lond., 1891, pp. 214-26.

‡ Comptes Rendus, cxiii. (1891) pp. 94-5.

§ Arch. de Biol., xi. (1891) pp. 147-312 (18 pls.).

himself that the complication of the gill indicates the degree of specialization of the different groups of Lamellibranchs, and he offers the following classification.

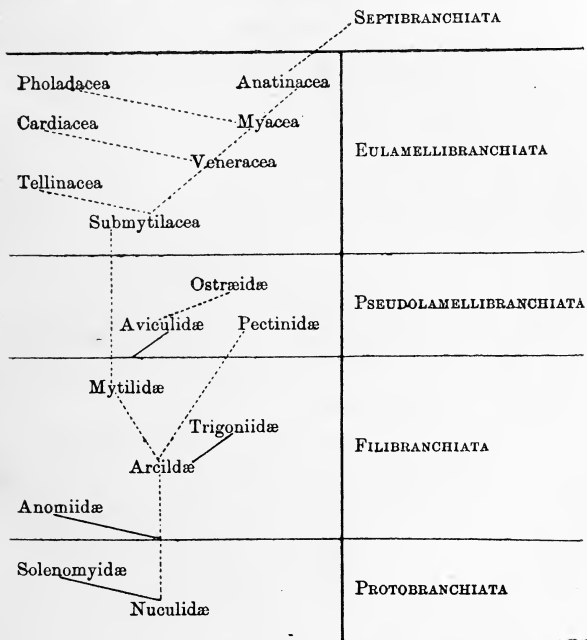

If we compare the Lamellibranchs with other groups of the Mollusca we find that they are much more specialized than the Amphineura, very different from the Cephalopoda, by no means so allied to the Scaphopoda as has been suggested by Lacaze-Duthiers, but showing many points of resemblance to the Rhipidoglossa. Of these last the least specialized show a marked symmetry of gills, osphradia, auricles, and renal organs; the edge of the mantle is free; some archaic forms, such as *Haliotis*, have well-developed hypobranchial glands; *Fissurella* and *Trochus turritus* have a crystalline style. The structure of the gills in dibranchiate Rhipidoglossa is absolutely similar to that of the Nuculidæ and Solenomyidæ. The crossing of the ventricle by the rectum is found only in Lamellibranchs and some Rhipidoglossa; pericardiac

glands are also found; the osphradia of the primitive Rhipidoglossa are found on the branchial nerve; the sexes are generally separate, and in archaic forms of both groups there are no accessory glands or copulatory apparatus.

In discussing the origin of the Lamellibranchiata it is as well to bear in mind that they cannot have given origin to the Rhipidoglossa, for the group of anisopleural Gastropods is, phylogenetically, more ancient than that of the Lamellibranchs; this is shown by morphology, individual and phyletic development.

Of all the Anisopleura the Rhipidoglossa are the most ancient; this is shown not only by their bilateral symmetry and the freedom of the edge of the mantle, but by the absence of centralization of the nervous system, the embryonic character of the eye, in some of which the invagination-cavity remains open, and by the opening of the gonad into the right kidney.

On the other hand, a number of characters show that the Lamellibranchiata are more specialized than the Anisopleura in general, and the Rhipidoglossa in particular; morphology, palæontology, embryology, may all be summoned to testify to this.

On the whole, Dr. Pelseneer concludes that the Lamellibranchiata are derived from forms of the rhipidoglossal type which have undergone no torsion, and he exhibits the relations thus:—

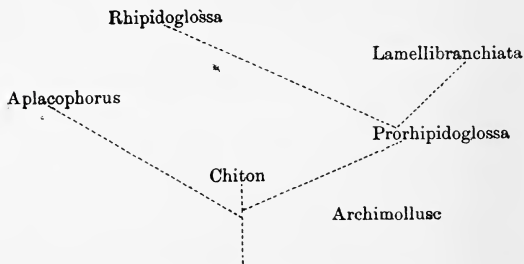

The Bulbus Arteriosus and Aortic Valves of Lamellibranchs.*—Prof. C. Grobben describes the post-ventricular bulbus arteriosus of *Cytherea chione*, *Venus verrucosa*, *Maetra stultorum*, and some other bivalves, and in part corroborates the recent investigations of Menegaux. The bulbus consists of interwoven smooth muscle-fibres extending through a matrix of connective tissue, and it contains a long valve which prevents regurgitation. Like Rankin and Menegaux, and others, Grobben finds a valvular arrangement at the beginning of the anterior aorta. In all the bivalves investigated there is a single semilunar valve, the nature of which in *Pecten Jacobæus* is described in detail. In the posterior aorta of *Pecten Jacobæus*, and probably in other Asiphoniata, there is, besides the sphincter described by Dogiel, another valvular structure.

* Arbeit. Zool. Inst. Univ. Wien (Claus), ix. (1891) pp. 163-73 (1 pl.).

Molluscoida.

a. Tunicata.

Classification of the Tunicata.*—Prof. W. A. Herdman has an essay on the classification of the Tunicata in relation to evolution. The exceptional diversity of opinion exhibited by systematists is probably due to the complex relations which obtain between the compound forms and the other Tunicata. He thinks that the only rational explanation of the protean forms and labyrinthine interrelations of the Ascidiæ is to be found in regarding the group as one in process of evolution, where many species, genera, and higher divisions have not yet become markedly differentiated by the elimination of intermediate forms; he thinks, moreover, that the animals are so much at the mercy of their environment that a special premium is set upon useful characters, so that the relations between modifications of structure and conditions of existence brought about by the action of natural selection are exceptionally evident.

The author becomes more and more convinced that it is necessary to regard the compound Ascidiæ as having had a polyphyletic origin, and to represent the group as linked on to the Ascidiæ Simplicæ by at least three points; moreover, if we attempt to arrange the families and genera in a series diverging from any one of these points alone, we must not be surprised if we arrive at obviously unnatural arrangements.

Prof. Herdman points out various objections to the scheme of classification lately propounded by M. Lahille, and urges that if the use of the modifications of structure of one organ are especially unsafe, it is the more so when, as in this case, the organ (the branchial sac) is of great physiological importance, and is therefore liable to be considerably modified in accordance with the mode of life of forms which are otherwise closely related.

Some interesting details are given as to the variation exhibited by the *Botrylli*, and the author concludes with pointing out that the theory of evolution has given taxonomy and speciology an additional and a very real interest. We know now just how much and how little the term species indicates, and it has, therefore, become of great importance that species and varieties should be restudied from the evolutionary standpoint, that the relations of allied forms should be carefully investigated, the limits of their variation determined, and the effect of their environment ascertained.

b. Bryozoa.

***Loxosoma annelidicola*.†**—Dr. H. Prouho gives a detailed account of this Bryozoon, to the preliminary notice of which we have already called attention.‡ The creature varies from 35 to 80 hundredths of a millimetre, and its integument is colourless. In this integument there are no glandular cells. The stalk ends in an adhesive disc which may attain considerable size, but there is no trace of the pedal gland which has been seen in other members of the genus; nor is there need of one, for the disc can act as a sucker. The arrangement of the muscles of the stalk is such that the animal is enabled to rotate on its

* Nature, xlv. (1891) pp. 130-3.

† Arch. Zool. Expér. et Gén., x. (1891) pp. 91-116 (1 pl.). ‡ Vide ante, p. 29.

base through 180°. The author describes in detail the calyx and the crown of tentacles; what is ordinarily known as the epistome is nothing more than that region of the floor of the lophophore which fuses with the upper edge of the buccal orifice. In some points Dr. Prouho's investigations enable him to confirm the results of Harmer; in the case of the nephridia he is able to make some additions to our knowledge. He regards the nephridium of *Loxosoma annelidicola* as being a group of two or three excretory cells placed in a definite space in the midst of the parenchyma; in this space there is also a vibratile area (the true structure of which is still unknown), which opens to the exterior by a ciliated canal. The space inclosing the excretory cells communicates with the exterior; the products excreted by these cells fall into the space and are carried outwards by cilia. The author cannot agree with Foettinger in thinking that there is any intracellular canal in these cells.

After some observations on budding, attention is drawn to the adaptation of *Loxosoma annelidicola* to its habitat; the Clymenid on which it lives is lodged in a thick and solid tube, between which and the worm there is but little space; we can understand, therefore, that in its normal position the *Loxosoma* is sharply inclined on its peduncle, while its calyx is extended transversely as if it had been flattened between the worm and its tube. As the Clymenid moves up and down its tube, it swells some of its rings; to avoid the danger to which it is thus exposed, the guest twists itself on its axis; and we may well suppose that the helicoidal muscles of the stalk are specially developed with regard to these movements. The Clymenids on which this species of *Loxosoma* has as yet been observed are *Nicomache lumbricalis* and *Petaloproctus terricola*.

Characters of Melicertitidæ and other Fossil Bryozoa.*—Mr. A. W. Waters calls attention to certain cheilostomatous characters in *Melicertites* and other fossil Bryozoa; such are the presence of aviculariæ, the large size of the pores, the plates on the apertures of the zoecia. He urges the importance of a thorough comparison of Palæozoic with Cretaceous genera, as the latter form an excellent stepping-stone between the rich Carboniferous fauna and the recent. In the Cretaceous Melicertitidæ the characters are in the main cheilostomatous but some are cyclostomatous, while in many Palæozoic fossils there are important structures similar to those in recent Cheilostomata.

Marine Polyzoa.†—The Rev. T. Hincks continues his "appendix" to his "Contributions towards a General History of the Marine Polyzoa"; in this new species are described and additions and corrections made to our existing knowledge.

Arthropoda.

Circulatory and Respiratory Organs of some Arthropods.‡—M. A. Schneider has some scattered notes on these organs in Amphipods, Arachnids, and Araneids; the lung of the last has not the chitinous envelope which has lately been described as investing it.

* Ann. and Mag. Nat. Hist., viii. (1891) pp. 48-53 (1 pl.).

† Tom. cit., pp. 86-93.

‡ Comptes Rendus, cxiii. (1891) pp. 94-5.

a. Insecta.

Minute Structure of Muscle-columns in Wing-muscles of Insects.*

—Prof. E. A. Schäfer has made a study of the muscle-columns, or sarcostyles, as he prefers to call them, of the wing-muscles of Insects. For the more or less cylindrical disc which forms the dark band the author retains the name of "sarcous element"; the fine line which bisects the light band he terms the "transverse membrane," while the light space which separates the ends of the sarcous elements from the transverse membranes may be called the clear interval; it corresponds with the isotropous substances of authors. The segment of a sarcostyle comprised between two transverse membranes may be termed muscle-segment or sarcomere. Prof. Schäfer finds that the sarcous elements are not made up of a bundle of rods, but are formed of a continuous substance (sarcous substance), staining with hæmatoxylin and with gold after hardening in alcohol; this substance is pierced by tubular canals which open at each end of the sarcous element, and in its middle abut against one another at the plane of Hensen's line. The optical section of each sarcous element shows a dozen or more of these canals, the contents of which are, apparently, freely continuous with the transparent, colourless substance of the clear intervals. The longitudinal striation of the sarcous element is due to this canalization; that of the clear interval to a prolongation of delicate lines of the sarcous substance through the clear interval to the transverse membranes. The whole sarcostyle seems to be inclosed by a membrane of extreme delicacy. Prof. Schäfer has been able to take photographs of his preparations which illustrate these points with great clearness.

If this view of the structure of muscle be accepted it is possible to form an idea of what happens when the muscle contracts or extends. In the latter case the sarcous elements are narrowed and laterally compressed by the extending force, and the fluid which is contained in their canals is squeezed out and passes into the clear intervals; furthermore, the process of extension elongates the sarcous elements and separates them further from the transverse membranes. When, on the other hand, the extended sarcostyle is retracted, the sarcous elements swell and the clear intervals become shortened so as eventually almost to disappear. This can only be effected by absorption of the homogeneous substance of the clearer intervals into the sarcous elements; in all probability it is imbibed into the canals or visible pores of the sarcous substance.

The author believes that the structure of the wing-muscles of insects furnishes the key to the comprehension of muscular structure in general, and that comparisons may be drawn, detail for detail, between them and the more intricate structures seen in Vertebrates and elsewhere.

Origin of the Blood and Fatty-tissue in Insects.†—Prof. V. Graber discusses the complex tissue found in the body-cavity of most insects. It includes (1) blood-corpuscles, (2) the fatty-body, (3) the yellow "œnocytes," which Wielowiejski finds to be usually arranged in segmental groups, and (4) the pericardial cells which lie near the dorsal vessel. All these Graber would include under the title "hæmosteatic tissue." From sections of the young larvæ of *Stenobothrus*, he finds that

* Proc. Roy. Soc. Lond., xlix. (1891) pp. 280-6 (2 pls.).

† Biol. Centralbl., xi. (1891) pp. 212-24.

the partially reticular fatty-body arises from the gradual vacuolation of œnocytes. Groups of these œnocytes occur in the eight anterior stigma-bearing segments of the abdomen. They arise from a proliferation and subsequent delamination of the ectoderm. Furthermore, in *Hydrophilus*, Graber has discovered that the parastigmatic groups of œnocytes arise in a hitherto unobserved fashion by an invagination of the ectoderm, which is, however, associated with a proliferation and delamination.

Signs of Copulation in Insects.*—Prof. F. Leydig has collected, partly from his own observations, partly from those of others, a number of cases in which female insects bear traces of copulation, in the form of tags or plates attached to the body, and apparently formed from material secreted by the male. Such probably is the “pouch” on the abdomen of *Parnassius Apollo*, and a somewhat similar structure in *Fulgora later-naria*, and such is the plate which is found on the posterior abdomen of *Dytiscus latissimus* and *D. marginalis*. Leydig compares these things with the white plate in *Astacus fluviatilis*, and with a little white lid on the spider *Argenna*, and finds analogues among Vertebrates.

Morphology of Lepidoptera.†—In the first of his communications under the above title Mr. W. Hatchett Jackson deals with two subjects—the external anatomical marks by means of which the sex of a chrysalis may be determined, and the mode in which the azygos oviduct or vagina of the female butterfly with its accessory organs develops between the close of larval life and the assumption of the imago-state. As we gave a full account of the preliminary notice of his results‡ we must, in calling attention to their publication, confine ourselves to one or two points. It would appear that, in Germany, some “practical Lepidopterists” were able to discriminate the sexes of Lepidopteran chrysalids, though none in England did so before Mr. Jackson’s work became known. Some experiments on colour-variation which were undertaken by the way seem to bear out the conclusions of Poulton. The anatomy of the genital ducts in the Microlepidoptera should be studied as it may bring to light transitional or primitive stages, just as Walter’s researches have clearly shown that a primitive biting condition of the mouth-parts exists in some of them at this day.

Morphology of Lepidopterous Pupa.§—Mr. E. B. Poulton, in describing the morphology of the lepidopterous pupa, discusses its relation to that of the other stages and to the origin and history of metamorphosis. He points out the error of naming the various appendages and other organs of the pupa as if they were mere cases for the corresponding parts of the imago; the appendages or organs are parts of the pupa, and should be spoken of as such; they are far more ancestral than the imaginal organs, and are remnants of a time when the last stage of metamorphosis in the ancestors of Lepidoptera was something very different from a butterfly or moth; the fault of the old terminology was that it obscured the fact that the pupa has a morphological meaning of

* Arbeit. Zool.-Zoot. Inst. Würzburg (Semper), x. (1891) pp. 37-55 (2 figs.).

† Trans. Linn. Soc. Lond., v. (1890) pp. 143-86 (5 pls.).

‡ This Journal, 1890, p. 29.

§ Trans. Linn. Soc. Lond., v. (1890) pp. 187-212 (2 pls.), 245-63 (2 pls.).

its own, and that traces of an extremely remote past can be deciphered by the study of its structure.

In investigating the persistent traces of larval structures upon the pupa, the author describes the claspers, the caudal horn of the Sphingidæ, and other structures, the larval tufts of hair indicated on the pupa, and the larval markings. He next discusses the number of abdominal segments and their relation to those of the larva, and concludes that both possess ten abdominal segments; even if this be shown to be incorrect it will not affect the segmental relations of the external reproductive organs, for they only come into relation with the eighth, ninth, and ventral (anal) part of the tenth abdominal segments.

The external generative organs are next described, and it is suggested that the median prolongation of the tenth abdominal and the relation of its apex to one of the generative apertures represents an ancestral ovipositor, now represented only by its external cuticular layer.

The relation of the pupal to the imaginal antennæ, and the history of the degeneration of the antennæ in female imagines form the subject of the next (fourth) part of the memoir; and the pupal wings are afterwards examined. In the course of an interesting discussion it is pointed out that when the two sexes seem to approach most closely in competition, flying together and both apparently exercising the powers of active courtship—when, in fact, courtship appears to be mutual—then the differences between the antennæ of the two sexes become very small, and in the cases of most complete equality disappear altogether. The antennæ are in all probability sense-organs of very general use, although their sexual function is by far the most important, while free and active flight gives abundant opportunity for their exercise in all possible directions, so that these organs may be sometimes equally developed in the two sexes.

Phylogeny of Lepidopterous Larvæ.*—Prof. A. S. Packard publishes some very interesting observations on the larvæ of Lepidoptera; his studies have led him to believing, provisionally at any rate, that the butterflies have originated from moths which resembled the Bombyces more than any other group; at any rate the ancestors were hairy or spiny caterpillars. The Nymphaliidæ may have originated from Arctian-like forms, and the Papilionidæ from Attacids. They certainly show no signs of descent from the Sphingidæ, the Castniidæ, Agaristidæ, Cossidæ, or Hepialidæ.

The Hesperidæ appear to be the most generalized butterflies, but their origin is not apparent. The Papilionidæ probably stand next above them, as they seem to have descended from an earlier and lower type than the Nymphaliidæ. The Lycænidæ appear to be the most extremely modified, and form a shoot perhaps parallel to the last; they are a more modern and highly modified family, though somewhat degenerate as regards their larval form; they thus recall the Cochliopodidæ, which are highly modified Bombyces.

Sound-Organs of Dytiscidæ.†—Herr P. Recker, after a historical account of our knowledge of the sound-organ of *Pelobius*, a genus of

* Proc. Boston Soc. Nat. Hist., xxv. (1891) pp. 82-114 (2 pls.).

† Arch. f. Naturg., lvii. (1891) pp. 105-12 (1 pl.).

Dytiscidæ, in which its characters are very well marked, describes in order the apparatus as found in the German species of *Cybister*, *Dytiscus*, *Acilius*, *Graphoderes*, and other representatives of the family.

B. Myriopoda.

Ocelli of *Lithobius*.*—M. V. Willem has made a study of the ocelli of *Lithobius forficatus*, on which Graber, Grenacher, and Sograff have published more or less discrepant reports; M. Willem confirms, in the main, the results of Grenacher. He finds that each ocellus has the form of an elongated cylinder, bounded externally by the cornea, and enveloped by a connective membrane which is traversed by the optic nerve; in the grooves which separate the corneæ from one another, this membrane is thickened and contains a mass of small pigmented cells. The cavity of the eye is occupied by two kinds of cells; some, the Haarzellen of Grenacher, are pigmented, and separate the cornea from the true retina. They end internally in delicate cilia which in the author's sections did not exhibit the regularity ascribed to them by the drawings of Grenacher; they are, rather, aggregated into irregular tufts.

The base of the optical section is occupied by a score of retinal cells, which Grenacher was only able to detect in exceptional cases. Each of these has a basal segment, which incloses the nucleus, pigment granulations, and Grenacher's rod; this last is distinctly striated transversely. In a few favourable sections the author was able to detect, between the striated segments of adjoining cells, elongated elements which present the same appearance as the lateral rods of the retinal cells of the larvæ of *Acilius*. Some of the author's preparations explained the cause of Graber's errors of interpretation, which he thinks due to preconceived notions and too thick sections.

C. Arachnida.

Classification of Mites.†—Prof. G. Canestrini proposes the following classification:—

Class ACAROIDEA.

Order 1. Astigmata	∴ Suborder Vermiformia.	Demodicidæ, Phytoptidæ.
	∴ Sarcoptina ..	Cytolichidæ, Psoroptidæ, Lincoptidæ, Listrophoridæ, Dermoglyphidæ, Analgesidæ, Tyroglyphidæ.
∴ 2. Hydracarina ..	Halacaridæ, Limnocharidæ.	Hydrachnidæ.
∴ 3. Prostigmata ..	Suborder Trombidina.	Tarsonemidæ, Cheyletidæ, Erythræidæ, Tetranychidæ, Raphignathidæ, Eupodidæ, Bdellidæ, Alychidæ, Rhyncholophidæ, Trombididæ.
	∴ Holopina ..	Hoplopodæ.
∴ 4. Cryptostigmata.	Oribatidæ, Nothridæ, Hoplophoridæ.	
∴ 5. Metastigmata ..	Isodidæ, Argasidæ.	
∴ 6. Mesostigmata ..	Nicoletiidæ, Uropodidæ, Zerconidæ, Lælaptidæ, Gamasidæ, Dermanyssidæ.	

* Comptes Rendus, cxiii. (1891) pp. 43-5.

† Atti R. Ist. Veneto, ii. (1891) pp. 699-725.

Coxal Glands of Arachnida.*—Dr. R. Sturany describes these organs which occur in all the orders of Arachnida, though with great diversity of form and size. In *Limulus* there is a four-lobed mass between appendages 2-5; the scorpion has a roundish packet at the base of the third and the fourth walking legs; in the Pseudoscorpionidea there are tubes in the region of the last three appendages; in the Solifugæ there is on each side a single long and much coiled tube; in the Pedipalpi there are packets of considerable size in the region of the last three legs; the spiders have diffuse coiled tubes in the Tetrapneumones, simple or quite rudimentary sacs in the Dipneumones; the Phalangiidæ have much coiled tubes, which open in spacious ventral sacs; finally, the mites have only traces of tubes. The glands have a striated cortex and a granular nucleated internal layer. The coxal glands of *Limulus*, Scorpions, Pseudoscorpionidea, Tetrapneumones, and Phalangiidæ are homologous and may be derived from a pair of nephridia opening on the fifth appendage; but the glands of the Dipneumones lie in the region of the third appendage. Therefore two pairs of nephridia may be represented in Arachnida.

e. Crustacea.

Eyes of Crustacea.†—The results of the studies of Wanda Szcza-winska may be shortly stated thus. The eye of *Gammarus* is provided with a hypodermis which is formed by a single layer of flattened cells not differentiated for each retinophore. In *Astacus* the cells of the hypodermis are grouped in pairs and cover the whole of the outer surface of a retinophore. The calyx and style in *Gammarus* and *Bran-chipus*, the calyx, style, and pedicel in *Astacus*, unite to form a continuous hyaline axis which reaches from the cornea as far as the basal membrane, to which it is attached by means of hyaline filaments.

In *Gammarus* three kinds of pigment-cells are grouped around each hyaline element of the eye, and are arranged in whorls of five each; these cells are provided with very distinct nuclei, which are arranged in three rows set in different planes. In *Astacus* the three kinds of pigment-envelope are arranged thus; the first covers the anterior part of the retinophore; it is formed by four cells placed at the four edges of the calyx; they give off filaments, one anteriorly and one posteriorly which serve to attach them to the cornea and to the basal membrane. The second envelope, or retinula of Grenacher, is formed of a verticil of seven cells, the nuclei of which are large and are placed at their anterior, enlarged extremity; four of these cells are shorter than the other three. The cells of the third set are placed near the basal membrane, and are distinguished from the first by their yellow crystalline contents; they appear to be seven in number.

From the experiments that were made it would seem that in the pigment-cells which surround the calyx and the style, the pigment, in darkness, is placed in the distal part of the eye; in the cells which surround the pedicel the pigment is in the proximal part and near the basal membrane. In light, the pigment of the cells which surround the calyx and style moves toward the optic nerve, so as to become more

* Arbeit. Zool. Inst. Univ. Wien (Claus), ix. (1891) pp. 129-50 (2 pls.).

† Arch. de Biol., x. (1891) pp. 523-66 (2 pls.).

extended, the cells themselves moving in the same direction; the pigment of the cells which surround the pedicel advances towards the cornea, and reaches as far as the outer pigment zone, so as to form a continuous layer of pigment which extends from the distal extremity of the retinophore as far as the basal membrane.

As the results now reached support those of Patten there does not seem to be any justification for regarding the eyes of *Branchipus*, *Gammarus* or *Astacus* as compound eyes; they are, rather, simple eyes the cornea of which is differentiated in a special manner, and the pigment-cells of which are grouped more regularly than in Vertebrates, where the adaptation of the optic organ to the changes in the surrounding media are produced by means of special organs, which are wanting to the Crustacea.

In the Crustacea this adaptation is effected by the movement of the granular pigment, and the pigment-cells. The eye of *Gammarus*, by the possession of a smooth cornea and an undifferentiated hypodermis—characters which distinguish the simple eyes of Arthropods—as well as by the structure of its calyx and style, approaches the eye of lower Crustacea; while, by the possession of pigment-cells which are not found in them, it affords an intermediate stage between the ocelli of Arachnids and the larval form of Arthropods on the one hand, and the so-called compound eyes of Crustacea on the other.

Notwithstanding some differences in detail the present researches, taken with those of Madlle. Stefanowska on Insects and those of Engelmann on Vertebrates, allow us to formulate the following generalization; in eyes exposed in darkness the pigment tends to occupy the smallest surface, while in light it spreads considerably, so as to protect the receptive elements against the influence of light.

Development of Mesoderm of Crustacea.*—M. L. Roule has a note on the development of the mesoderm of Crustacea, and that of the organs derived therefrom. His investigations have been carried out on *Porcellio scaber* and *Palæmon serratus*. At the time when the cells of the blastoderm are increasing on the medioventral line to produce the nerve-centres, and at the sides of the anterior end of the body to give rise to the foundations of the endoderm, two new bands of proliferation appear on either side of the ventral nervous band. The peripheral blastoderm becomes ectoderm; the central cellular mass represents the mesoderm; the cells of this mass are converted into muscular fibres. Similar cell-multiplications are found in most of the remaining portion of the blastoderm, but they are less active; they only produce elements which penetrate into the subjacent yolk, and gradually destroy the nutrient materials which it contains. These elements correspond to the vitelline cells of authors, as to which opinions of such different kinds have been expressed. They are all derived from the blastoderm alone, and are to be regarded as part of the mesoderm of the body.

The further development of the mesoderm is on the mesenchymatous type; the mass in each young appendage commences to form a central cavity, two or three being sometimes juxtaposed; the cells around the cavity break away from their neighbours, and become free in the interior. This process of dissociation leads to the formation of a network of meso-

* Comptes Rendus, cxiii. (1891) pp. 153-5.

dermal elements; the spaces are filled by a liquid or by unchanged cells, and become the vascular sinuses of the appendage. There is nothing in this mode of development which is comparable to the portioning-off of the coelom as seen in Annelids and Vertebrates; there is only the formation of clefts which become blood-lacunæ.

A similar mode of development is seen in the mesoderm of the body; its elements, while destroying the nutrient yolk, give rise to the formation of spaces which communicate with one another, and become blood-lacunæ. One of these, that around the intestine, is isolated from its fellows, and becomes the circumintestinal cavity. But, before this separation is effected, a group of mesodermal cells situated above the proctodæum elongates, and is pierced by a central cavity which unites two mesodermal spaces.

Renal Secretion in Crustacea.*—M. P. Marchal gives a short account of the excretory apparatus of *Nika edulis*, *Alpheus ruber*, and *Caridina Desmaresti*. He thinks that the production of the urinary liquid is not, in Crustacea, due to a simple filtration as the limpidity and abundance of the liquid which fills the bladder might lead one to suppose; it is a real secretion with separation of parts of cells. In the Paguridæ the clear liquid which fills the abdominal bladder contains more or less granular vesicles, often of large size, and sometimes containing more or less numerous secondary vesicles. When indigo has been injected into the animal blue granulations are found in the vesicles. It is evident that the bladder takes an important part in secretion.

The white substance of the Crayfish secretes in the same way as the bladder; its cells are likewise swollen at their extremity into large, clear vesicles, distinct from the cell-body. Several vesicles may be found at once in one and the same cell of the cortical substance of the Crayfish and the labyrinth of other Crustacea; they give the appearance of a sort of palisade, covering the cells. The sacculus also secretes and expels parts under the form of vesicles which are often coloured yellow.

Morphology of Isopod Feet.†—Dr. J. Nusbaum has observed in the embryos of Isopoda that all the thoracic feet have the biramose structure which is so characteristic of other Crustacea; it is well known that in the adult there is a considerable reduction; the young type approaches most closely that of *Nebalia*—two-jointed protopodite, five-jointed endopodite, unjointed exopodite, and simple lamelliform epipodite.

The first foundation of every thoracic foot appears in the form of two closely connected papilliform processes of the ectoderm. Simultaneously there appears outside each a small disc-like ectodermal thickening. The gradual differentiation of the appendages goes on, as usual, from before backwards. The inner process of each foundation soon becomes longer than the outer, and the foundation of the protopodite is differentiated somewhat later. The lateral foundation divides into a distal and broader part and a proximal and more delicate, which becomes intimately connected with the basal joint of the protopodite. It is very probable that this not only merely takes part in the formation of the pleura, but

* Comptes Rendus, cxiii. (1891) pp. 223-5.

† Biol. Centralbl., xi. (1891) pp. 353-6.

has also a considerable share in the constitution of the epimera. In the later stages of development the parts in question cannot be distinguished in the ventral wall of any segment. This share of part of the appendage (probably a homologue of the epipodite) in the formation of the ventral wall appears to be general in Isopods.

Urothoe and Urothoides.*—The Rev. T. R. R. Stebbing gives a monographic account of these genera of Amphipods, the second of which is new and is established for *Urothoe lachneëssa*, described by the author in his 'Challenger' Report. Of the former, eight species are recognized, which are more remarkable for their likeness to one another than for any differences that can be discerned. The size of the eyes and the structure of the lower antennæ vary greatly with the age and sex of the animal: the most constant feature is the possession by the female of a two-jointed flagellum on the antennæ. One characteristic of the genus is a vast number of gland-cells found all over the body, while others are the transparent caps to the tips of all the fingers, a peculiar spine-row on the wrist of the first gnathopods, and the long plumose setæ on some of the appendages.

New British Amphipods.†—The Rev. T. R. R. Stebbing and Mr. D. Robertson give descriptions of four new species of British Amphipods, which are called *Sophrosyne Robertsoni*, *Syrrhoë fimbriatus*, *Podoceros palmatus*, and *Podoceros cumbrensis*; they were all found in the Clyde.

New and Rare French Crustacea.‡—In the thirty-eighth of his communications on this subject M. Hesse describes a new Lepadid which he calls *Cirrhipedes pedunculatus laciniatus*, and in the thirty-ninth a Lernean found in the mouth of *Cottus bubalis*; in the latter he offers some observations on the metamorphoses of Cirripeds during their embryonic period.

Goniopelte gracilis—a new Copepod.§—Prof. C. Claus describes a new member of the family Peltidiæ—*Goniopelte gracilis*—characterized by the seven-jointed anterior antennæ, the unjointed simple outer branch of the first pair of legs, and the marked reduction of the accessory branch of the posterior antennæ. The similar form described by Brady as *Goniopsyllus rostratus* and referred to the Harpacticidæ, is insufficiently characterized, and with it the species which Lazarus Car described as *Sapphir rostratus* and referred to the Sapphirinæ, is identical.

New Pelagic Copepoda.||—Dr. W. Giesbrecht continues his list of pelagic Copepods collected on the "Vettor Pisani" expedition, adding four new genera, *Mormonilla*, *Ægisthus*, *Conæa*, and *Corina*, and forty new species belonging to the above and other genera.

* Trans. Zool. Soc. Lond., xiii. (1891) pp. 1-30 (4 pls.).

† Tom. cit., pp. 31-42 (2 pls.).

‡ Ann. Sci. Nat., xi. (1891) pp. 179-86 (1 pl.); and 187-95 (2 pls.).

§ Arbeit. Zool. Inst. Univ. Wien (Claus), ix. (1891) pp. 151-162 (2 pls.).

|| Atti R. Accad. Lincei—Rend., vii. (1891) pp. 474-81.

Vermes.

a. Annelida.

Homology of Pedal and Cephalic Appendages in Annelids.*—M. A. Malaquin is of opinion that the cephalic appendages of Annelids are morphologically comparable to the pedal appendages; he finds that the dorsal and ventral setigerous rami may undergo modifications and be converted into cirriform appendages which may be sensory; the cephalic lobe is regarded as a single segment, the appendages of which, though profoundly modified, may be homologized with the different parts that make up the parapodia of normal segments.

Development and Morphology of Parapodia in Syllidinae.†—M. A. Malaquin has made an examination of the appendage in this group of Polychæta. He looks on the organ when at its maximum size as being composed of, in the order of their development—a ventral branch, a dorsal cirrus, a ventral cirrus, and a dorsal branch. This is sometimes found, but only in segments provided with swimming setæ. The most general composition of the parapodium is ventral branch, dorsal and ventral cirri. Reduction may result in the loss of the last of these, or may, as in *Procerastea*, go further, so that there is merely a ventral swelling whence emerge setæ. In this genus, however, there is, at the time of reproduction, a series of complications due to the tardy development of the appendages in sexual forms.

A comparison of the morphology and development of the parapodia shows that the phenomena of retrogression of the constituent parts in the Syllidinae follow the inverse order of their embryological appearance. These facts confirm the view of Hallez, that in the development of an organ which has begun to retrograde the organ goes through a reduced number of stages; so that, in place of passing through stages *a*, *b*, *c*, and *d*, it only reaches *c*, then *b*, and finally *a*.

Reproductive Organs of *Diopatra*.‡—Mr. E. A. Andrews had his attention attracted by peculiar strings of green cells which occur abundantly in the body-cavity of *Diopatra magna* sp. n. and *D. cuprea* Bosc, found at Beaufort, North Carolina. On investigation they were found to be ovarian cells liberated along with the ova, and remaining for a time attached to them as peculiar processes. It is difficult to imagine what the function of these bodies can be. There is no reason for supposing that the ova derive nourishment directly from them, for a firm egg-membrane, which would prevent the ingestion of entire cells, is early developed, and, later on, they are entirely absent. Mr. Andrews suggests that the cell-strings may be mechanical supports which serve to keep the ova separate and well surrounded by the nutrient fluid while floating about. The most similar case is to be found in *Bonellia*, where the ovum is armed at one point of its periphery with a collection of cells of no apparent use.

A diagnosis is given of *D. magna*, the young of which often construct small tubes on the outside of those of the adult.

* Comptes Rendus, cxliii. (1891) pp. 155-8.

† Tom. cit., pp. 45-8.

‡ Journ. of Morphology, v. (1891) pp. 113-22 (2 pls.).

Earthworms of Berlin Museum.*—Dr. W. Michaelsen devotes the first of a series of articles descriptive of the Terricolæ of the Berlin zoological collection to those from the African region. *Kynotus madagascariensis* g. et sp. n. is remarkable for the want of congruence between the internal and external segmentation. In a layer of the anterior part of the body an internal segment is exactly twice the size of an external; it is clear, however, that the internal arrangement is secondary, for the various systems of organs are only to a certain extent adapted to it.

Dichogaster minus sp. n. is doubtfully assigned to this systematic position, and only a single specimen was available for examination; in a comparative table the points of difference and similarity between it, *D. Damonis*, and *Benhamia rosea* are exhibited. *Eudrilus pallidus* is another new species also founded on a single example, and the same is the case with *Preussia* (?) *lundaensis*, *Paradrilus ruber*, *P. purpureus*, *Benhamia intermedia*, and *Perichæta madagascariensis*; a new species of *Allolobophora* is described from Madeira. The *Lumbricus Kerguelarum* of Gruber is removed to the genus *Acanthodrilus*.

New Form of Excretory Organ in an Oligochæteous Annelid.†—Mr. F. E. Beddard observed in a new genus of Eudrilids that nephridia appeared to be absent in the genital region. But sections through the body-wall showed that the longitudinal and transverse muscular layers were traversed by a system of peculiar canals not at all like nephridia in appearance. They are arranged in a longitudinal and a transverse series, with numerous branches and interconnections; there are four principal longitudinal trunks which run through several segments without a break; they are connected with a metamerically repeated system of transverse vessels, which appear to run right round the body. They give off numerous branches and form a finer meshwork of tubules; those that run towards the epidermis open there by small orifices.

This arrangement may shortly be defined thus:—The nephridial system of the genital segments of this Eudrilid consists almost entirely of a complex system of tubes, which ramify in the thickness of the body-wall, open by numerous pores on to the exterior, and are connected by a few short tubes with the body-cavity.

This system is perhaps comparable to the nephridial network of Flat Worms, but its presence in the body-wall suggests a comparison with the Round Worms.

Naidiform Oligochæta.‡—Prof. A. G. Bourne describes some new species of the genera *Pristina* and *Pterostylarides*, and offers some remarks on cephalization and gemmation as generic and specific characters among the naidiform Oligochæta. The author takes the opportunity of pointing out that a monograph of the British species of this group is still a desideratum.

A certain amount of cephalization is almost always, if not always, exhibited by the Oligochæta; that is, there is in the anterior region a segment or a number of segments which differ in their organization

* Arch. f. Naturg., lvii. (1891) pp. 205-28 (1 pl.).

† Proc. Roy. Soc. Lond., xlix. (1891) pp. 308-10.

‡ Quart. Journ. Micr. Sci., xxxii. (1891) pp. 335-56 (2 pls.).

from the segments which follow; this difference may be exhibited by peculiarities of the alimentary canal, the circulatory system, the arrangement of the septa, the absence of nephridia, and so on. Prof. Bourne's remarks and diagrams illustrative of the processes of gemmation, which could not be reproduced otherwise than *in extenso*, should be studied by all microscopists who have the opportunity of observing worms of this group.

The author gives a system of the Naidomorpha, with definitions of the genera and notes on the species.

Histology of Nervous System of Hirudinea.*—Dr. E. Rohde has specially investigated the minute structure of the nervous system in *Aulostomum gulo* and *Pontobdella muricata*. All the parts of this system consist of a more or less distinctly fibrillar spongioplasm, and an inclosed and apparently homogeneous hyaloplasm; the former is intensely, the latter hardly at all stained by colouring matters; osmic acid reduces the spongioplasm, but leaves the hyaloplasm almost untouched.

As to the ganglia he notes that each ganglion is divisible into a central substance and a peripheral layer of ganglionic cells; this last consists of cells imbedded in a fibrillar supporting tissue; these fibrils are the processes of supporting cells, of which there are six in each ganglion. Each of these six cells incloses by its processes a definite number of ganglionic cells; each ganglion is consequently divided into six pockets which are sharply separated from one another. The spongioplasm of the central substance is formed of irregularly distributed fibrils; that of the ganglion-cells form a plexus of fibrils. The processes of these cells are, as a rule, finely fibrillated, and appear to pass gradually into the stronger fibrils of the central substance; only a proportionately small part pass directly into the commissures and nerves. The nerves contain three different elements, which are distinguished by the characters of the fibrils of their spongioplasm. The chief part (the central substance) is the continuation of the central substance of the ganglion, and consists of fibrils of equal size to its. Nerve-tubes are differentiated from the central substance, at definite points; these are ensheathed in circular fibrils. The nerves of *Pontobdella* contain fewer and thicker fibrils than those of *Aulostomum*.

The spongioplasm of the commissures which connect the ganglia with one another is made up of fibrils of about the same size as those in the central substance of the nerves; those fibrils unite at definite points to form thick radial septa.

A number of the nerve-cells in the nervous system differ essentially in their structure from the central ganglionic cells. For example, there are peripheral ganglionic cells, visible to the naked eye, which are not unipolar but have a large number of processes, and their fibrils are much larger than the ordinary.

Evidence is offered to show that the spongioplasm is only a supporting substance; the identity of the fibrils of the central substance of the ganglia, commissures, and nerves on the one hand, and of the central ganglionic cells on the other, is shown by certain structural characters

* Zool. Beiträge, iii. (1891) pp. 1-68 (7 pls.).

in some of the ganglion-cells of *Pontobdella*, by the median cells, some of the fibrils of which form a plexus of thick fibres, and by the structure of the ganglionic-cell-processes which pass directly into the nerves.

The hyaloplasm is the sole nervous constituent; in consequence of its homogeneity and its resistance to colouring matters it is only rarely detected in sections between the closely packed fibrils of the spongio-plasm; in teased preparations, however, it is distinctly seen not only in the ganglionic cells, but in the central substance of the ganglia, nerves, and commissures.

All the three last-mentioned parts are surrounded by a firm neurilemma, formed of connective tissue, almost homogeneous in appearance and often divided into lamellæ. In the ganglia it forms an inner layer which separates the central substance and ganglionic cell-layer, and an outer which marks off the cœlom. In *Pontobdella* the neurilemma remains as an outer layer, while in *Aulostomum* it makes its way into the interior. The radial septa of the commissures have nothing in common with the neurilemma, and they are not to be regarded, as they generally are, as internal continuations of it.

Anatomy and Histology of *Sipunculus nudus*.*—Mr. H. B. Ward has made a study of some points in the anatomy of *Sipunculus nudus*. He deals largely with the histology of the body-wall, the tentacular fold, and the nervous system.

Though there is a general similarity to *S. Gouldii*, correspondence in details is wanting; for example, bicellular dermal glands are entirely wanting in the latter, and the multicellular glands of the two species are different. Indeed, if the two are to be retained in one genus, some modification of Selenka's diagnosis of *Sipunculus* is needed.

In the nervous system of Sipunculids and Annelids there is, it is true, a striking similarity, but there are at the same time certain characteristic differences. In the former the peripheral system of plexuses is very highly developed and consists almost entirely of fibres, whereas the dermal plexus of Capitellids, Nemertines, and Polychæta is largely composed of ganglionic cells.

The minute anatomy of the central nervous system of *S. nudus* bears a close resemblance to that described by Rohde for Chætopods and by Bürger for Nemertines, but the Sipunculids have no "giant cells"; the Echiurids, on the other hand, have giant fibres, and it is very probable that they are more closely related to the Annelids than are Sipunculids.

B. Nemathelminthes.

Stylet of *Heterodera Schachtii*.†—M. J. Chatin points out that it is incorrect to say that this Nematoid of the beetroot and other plants is unarmed, for, as a matter of fact, it has a very interesting stylet. This is formed of a plate and an apophysis to which muscles are attached. Brownish in colour and very elastic the stylet is pierced by a central canal; it is moved by protractor and retractor muscles. The remarkable dimorphism exhibited by this worm is seen even in the stylet, for, among

* Bull. Mus. Comp. Zool., xxi. (1891) pp. 143-82 (3 pls.).

† Comptes Rendus, cxii. (1891) pp. 1516-8.

other points of difference, that of the female is smaller and weaker than that of the male. In the former, indeed, it has only to prick the plants to draw out the liquids necessary for food; in the latter it has to help a delicate worm to make an active passage through the tissues of the plant when a parasitic is about to be exchanged for a free mode of life. Similar differences, due to similar causes, are to be seen in the stylets of the first and second larvæ; the first is very agile and lives for a time freely in the earth; the second is sedentary or parasitic, and has a smaller flexible stylet. The changes are effected in the organ when the worm sheds its chitinous cuticle.

γ. Platyhelminthes.

Organization of Acœlou Turbellaria.*—Prof. L. Graff has a preliminary notice of the results of his work on this group of worms. He has been led to form a new classification, in which the first family, that of the Proporida, consists of Acœla with one genital orifice; *Proporus* has no bursa seminalis, *Monoporus* (g. n.) has one; the type of the last is *P. rubropunctatus*. The second family—the Aphanostomida—contains three genera, all of which have two genital orifices and a bursa seminalis; *Aphanostoma* has no chitinous piece to the bursa, *Convoluta* has one, and *Amphichærus* (g. n.) has two; the type of the last genus is *C. cinerea*.

If the epidermis be fixed by chrom-aceto-osmic acid and stained with hæmatoxylin, it is possible to perfectly preserve unicellular glands, the nature of which has been generally misunderstood. It is certain that all Acœla have the three layers of muscular fibrils described by Delage in *Convoluta roscoffensis*. All forms studied in the fresh state were seen to have a ventral mouth and a simple pharynx; hitherto its presence has been denied in some members of the group. Three types of structure may be distinguished in the parenchyma; in some it is reticulated, and there is a large number of free cells; in others the central parenchyma is a syncytium very rich in nuclei, but without any free cells, while the peripheral portion is a tissue of rounded cells closely packed against one another. In the third type the body is filled with a nucleated syncytium, in which amœboid cells swim.

From the morphological point of view the free cells are considered as mesodermal elements still inclosed in the endoderm; they have a digestive function. In more advanced forms (*C. paradoxa*) they lose this function, and become peripheral elements of support, while the reticulum alone performs the digestive functions.

Prof. Graff made use of Delage's gold method and found that it gave the best possible results; the want of certainty, however, is a serious objection. On the whole, the author agrees with the results of Delage, but he cannot find the cerebral cavity described by the latter. *Proporus* or *Monoporus* show some remarkable differences in the structure of the central nervous system.

The frontal organ of Delage is not an organ of sense, but part of a gland; the "nerve-cells" and "fibres" are merely formed by parenchymatous tissue distributed among the excretory ducts of this gland. It

* Arch. Zool. Expér. et Gen. ix. (1891) pp. 1-12.

is the homologue of the packet of rod-forming and mucus-producing glands which open at the anterior end in many Turbellaria.

The Zoochlorellæ of *Convoluta* are Algal in nature, and this worm exhibits in a high degree the phenomena of symbiosis.

Nervous System of Monocotyliidea.*—M. G. Saint-Remy has examined the disposition of the nervous system in *Pseudocotyle squatinæ* and *Microbothrium apiculatum*. He gives a detailed account of the former, which is not unlike that which is found in the Tristomidæ. In the latter it is more complicated than in any observed member of the group. The brain, which is greatly reduced, gives off anteriorly two branches, which correspond to the first pair in the Tristomidæ. Posteriorly it is prolonged on either side of the pharynx into a branch which goes to the pharyngeal ganglion, and gives off two small branches which are, perhaps, homologous with the second and third pairs of *Pseudocotyle*. The pharyngeal ganglia are two large masses connected by a transverse branch; from this last there arises a pair of very short nerves which correspond to the later dorsal nerves of the Tristomidæ; two ventral longitudinal nerves are given off from each ganglion as well as two accessory nerves which are lost in the parenchyma. Lastly, from the extremity of the nerve there is given off an anterior nerve, which seems to be a continuation of the external ventral nerve; it extends as far as the mouth, and on its way unites with the branch which goes from the brain to the pharyngeal ganglion; this nerve appears to represent the third anterior pair of the Tristomidæ. The two ventral nerves are connected with one another by commissures as in *Pseudocotyle*. On the whole the nervous system of Monocotyliidea exhibits an unexpected complication of the plan seen in the Tristomidæ.

Hymenolepis.†—Prof. R. Blanchard gives a zoological and medical account of the Tæniidæ of this genus, to which belongs the minute form often called the *Tænia nana* of Man; the author gives a full description of the structure and development of this parasite, and also deals fully with *H. diminuta*. The fourteen species of the genus are divided into two groups—one armed and one unarmed. The chorology of the species is also discussed.

δ. Incertæ Sedis.

Contribution to the Study of Rotifers.‡—M. J. Masius gives some details, without any generalizations, as to the structure of *Asplanchna helvetica* and *Lacinularia socialis*. Of the points described we may note that, in the first, the author observed the evaginated pharynx, where he was able to distinguish two large contractile cells with prolongations; these last were so distributed as to surround the pharynx with a kind of contractile plexus. Between the stomach and the hinder end of the body there is a cell of connective tissue; this cell is stellate, and its prolongations are directed in opposite directions and are inserted, some into the outer surface of the base of the stomach, others into the cuticle of the end of the body, and others into the generative apparatus.

* Comptes Rendus, exiii. (1891) pp. 225-7.

† 'Histoire zoologique et médicale des Téniaidés du genre Hymenolepis Weiland,' Paris, 1891, 8vo, 112 pp., 22 figs.

‡ Arch. de Biol., x. (1891) pp. 651-82 (2 pls.).

The function of this cell is to prevent the stomach moving too far towards the head of the animal, on the contraction of the muscles of the oesophagus.

The vibratile flame of the terminal organ of the nephridial apparatus is covered with longitudinal striæ, each of which begins by a small thickening; as a consequence of this the base of the flame is bounded by a row of small dots. In the living animal the vibratile flame and its filaments exhibit a continuous undulatory movement, which moves in a centripetal direction. The author thinks that the filaments serve merely to make the organ firmer, and that one of them, more powerful than the rest, is the seat of a movement analogous to that of the vibratile flame, and is perhaps destined to aid the movement of the fluid of the general cavity from the body towards the kidney. There is no valve at the opening of the duct into the bladder; it is possible that the numerous folds of the nephridial tube are sufficient to stop the reflux of the fluids.

The large, spherical bladder contracts ten times a minute; its wall is formed by large, very flat cells; in addition to these there are two large stellate cells with numerous prolongations which cover the whole of the bladder with a contractile plexus.

The winter eggs are covered with three membranes; a delicate internal membrane, most clearly visible when it becomes folded, owing to some alteration in the egg; the next membrane is very thick, striated and divided into two concentric zones; the striation is due to a number of fine canaliculi, radially arranged; they are thickened towards the interior, and it is these thickenings that give the appearance of a division of the membrane into two zones. The outermost membrane is homogeneous and yellowish.

The male efferent duct is remarkable for its enormous diameter; this is related to the presence of a large spermatophore. This last is of a yellowish-brown colour, and is formed by the union of a large number of chitinous elements, polyhedral in form and varying in size. The contained cavity is circular, but eccentric in position. As a canal which contains a spermatophore loses its glandular appearance, we may suppose that the product of its secretion has been used in the formation of the spermatophore.

In a somewhat shorter notice on *Lacinularia*, M. Masius calls attention to some groups of cells which form organs the significance of which is not as yet understood. At the sides of the dorsal part of the salivary glands there are two rows of cells which converge towards the medio-dorsal line. In the place of the posterior extremity of the vitellogenous gland, placed very superficially, there are always to be seen two small rows of cells which trend backwards and nearly meet in the medio-ventral line. These cells appear to have no relation to the adjoining organs. On the ventral surface there is a mass of multinucleate protoplasm without any visible cell-boundaries; the nuclei are arranged symmetrically, in fives.

Anatomy of Rotifers.*—Mr. R. Vallentin has made serial sections of *Melicerta ringens*, *M. conifera*, *Brachionus rubens*, and *Lacinularia*

* Ann. and Mag. Nat. Hist., viii. (1891) pp. 34-47 (2 pls.).

socialis; and he now publishes notes of his observations. He has failed to find any traces of the circular muscular bands which so many observers have seen in optical section in *Melicerta* and *Lacimularia*. He has only found one pair of muscles in the mastax; these appear to draw the rami upwards and inwards, and on their relaxation the rami are forced upwards by a semicircular band, which arches over the dorsal region. In *Brachionus rubens* the flame-cells are of considerable size; each consists of a hyaline cylinder, the extremity of which is rounded and closed, while a single nucleated cell forms the distal termination. A tapering broad-edged cilium springs from the centre of this cell and projects forwards about as far as the junction of the flame-cell with the lateral canal; this junction is marked by a fine granular deposit on the walls of the canal. These notes are fully illustrated. The author remarks that while he found Rotifers in abundance in Epping Forest, he was astonished at the absence in any quantity of all but *Brachionus rubens* in the neighbourhood of Falmouth.

Dasydytes bisetosum.*—Mr. P. G. Thompson calls attention to the neglect of the order Gastrotricha in England, and describes a new species which he found in a pond near Leytonstone in Essex. It appears to be most nearly allied to *D. longisetosum*, but is nearly twice the size, and has much more conspicuous caudal bristles. It is quite colourless, and, exclusive of the caudal setæ, measures 1/170 in.

A Multicellular, Infusorium-like Animal.†—Prof. J. Frenzel has found in the Argentine Fauna a somewhat remarkable organism. With a general resemblance to one of the Ciliates, it has a well-differentiated enteric tract and a single cell-layer. Tubular in form, tapering anteriorly and posteriorly, it is so flattened from above downwards as to be bilateral; the lower surface is flat, and the upper slightly curved; the former has fine cilia, by means of which the creature moves actively forwards, while it is also capable of worm-like or snake-like coils. The dorsal and lateral parts are not ciliated, but carry some short setæ. There is an anterior oral and an exactly terminal finer anal orifice. Longer and stronger cirri surround the former. There is no definite cuticle, but the cell-membrane is thicker externally than elsewhere.

The wall of this tubular organism is formed of a single layer of rather large, almost cubical cells, which leave a cylindrical lumen closely packed with foreign bodies; this is the enteric cavity. The face of the cells turned towards the lumen is finely ciliated. The mouth, which is not terminal, is overhung by a cell.

These animalcules were found of various sizes; growth is effected by doubling of the cells by division. Reproduction is effected by transverse division or by conjugation and encystation, when the contents of the cyst become all similar cells.

Echinodermata.

Classification of Echinodermata.‡—Prof. F. Jeffrey Bell in his observations on the arrangement and inter-relations of the classes of the

* Sci.-Gossip, 1891, pp. 160-2 (2 figs.).

† Zool. Anzeig., xiv. (1891) pp. 230-3.

‡ Ann. and Mag. Nat. Hist., viii. (1891) pp. 206-15.

Echinodermata, commences with discussing the relations of the Holothurioidea to the rest of the Echinodermata.

He points out various characters which indicate the primitive nature of the Holothurians; for example, the genital apparatus is not arranged quinquerradially, so that, whereas all other Echinoderms may be said to be actinogonidiate, the Holothurians are anactinogonidial; again, they alone have no system of plates corresponding to those that form the calycinal area in other Echinoderms, or, in a word, they are non-caliculate. Part of the diffused nephridial system, which there is every reason to suppose was possessed by the ancestors of the Echinoderms, has been retained by Synaptids, and part by other Holothurians. Prof. Bell revives the use of the word podia for tube-feet, and points out (*pace* Prof. Ludwig) that there are apodal and pedate Holothurians.

He concludes the argument, which is very briefly stated, by remarking, "the position, then, that the Holothurians are primitive forms, is spoken to (1) by the possession of characters certainly possessed by their ancestor, and (2) by the absence of characters seen in other Echinoderms, and evidently differentiations of structures developed after the ancestor of the Echinoderm had become separated from the ancestors of other phyla."

The relations of the remaining Echinodermata are next considered; the Cystids are recognized as the most primitive, and it is urged that some were probably anactinogonidial, while others had no stalk, or were apelmatozoic. The apelmatozoic actinogonidial Cystids divided into two main branches, one of which led to forms that are truly pelmatozoic, that is, forms that are fixed or had ancestors that were fixed—these are the Statozoa. The others which remain free are Eleutherozoa; such as Echinoids, Asteroids, and Ophiuroids.

The following diagram expresses the author's views:—

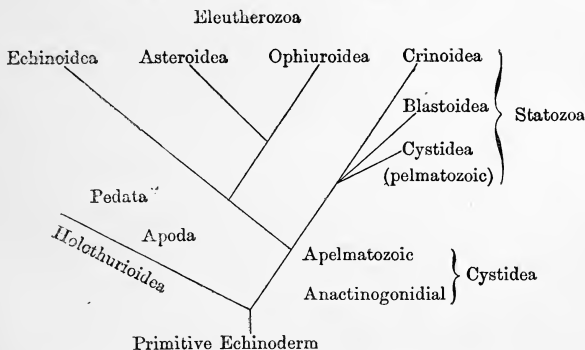

The Eleutherozoa either have, as in the Echinoidea, the ambulacra extending from the mouth to the boundaries of calycinal area, and such may be said to be zygapodous; or the ambulacra are, as in Asteroids

and Ophiuroids, confined to the oral surface; they are called azygopodous. Put in the ordinary linear way the proposed arrangement stands thus:—

Branch A. Incaliculata.

Stage *a*. Anactinogonidiata.

Class 1. Holothurioidea.

Branch B. Caliculata.

Stage *a*. Anactinogonidiata.

Class 2. Some Cystidea (?)

Stage *β*. Actinogonidiata.

1st Subbranch. Statozoa.

Substage i. Apelmatozoic.

Class 3. ? Some Cystidea. Class 4. ? Some Crinoidea.

Class 5. ? Some Blastoidea.

Substage ii. Pelmatozoic.

Class 6. Crinoidea. Class 7. Cystidea. Class 8. Blastoidea (s.s.).

2nd Subbranch Eleutherozoa.

Division I. Zygopoda.

Class 9. Echinoidea.

Division ii. Azygopoda (s. Stelleridea sens. em.)

Class 10. Asteroidea.

Class 11. Ophiuroidea.

Concise definitions of the divisions and classes, in which the new terms freely proposed by the author are made use of, complete the paper.

Echinodermata from South-west Ireland.*—Mr. W. Percy Sladen gives an account of the Echinodermata collected in 1888 by a Deep-sea Dredging Committee of the Royal Irish Academy. The cruise was made off the south-west coast of Ireland, and the most interesting forms were obtained from 345 and 750 fathoms. At the latter station the *Elasipod Lætmogone violacea* was obtained, as well as *Phormosoma placenta* and *P. uranus*, and a new species of *Porocidaris*, which is called *P. gracilis*. Of the Asteroidea *Pentagonaster balteatus* and *P. concinnus*, *Pteraster personatus*, *Hymenaster giganteus* were new. Mr. Sladen contests the view of Canon Norman, that *Nymphaster protentus* Sladen is a synonym of *P. subspinosus*. As only eight stations were dredged at and forty species were found, it is obvious that the collectors, of whom the Rev. W. S. Green was the head, hit on a rich locality.

Development of Holothurians.†—Prof. H. Ludwig has made a study of the development of *Cucumaria planci*, specimens of which were kept for one hundred and sixteen days; after the eighth or ninth day development proceeds very slowly. The larvæ and young are quite opaque and so full of calcareous bodies that the ordinary methods of preparing sections were quite useless. Owing to the small size of the cellular elements and the close approximation of the foundations of the various organs it was necessary to have sections no more than 5–7 μ thick.

* Proc. Roy. Irish Acad., i. (1891) pp. 687–704 (5 pls.).

† S.B. K. Preuss. Akad. d. Wiss. Berlin, 1891, pp. 179–92.

The author is not able to confirm the general belief that in Holothurians the plane of symmetry of the young Echinoderm corresponds with that of the larva; they rather cut one another at acute angles. The circular and radial canals have taken up their permanent position by the eighth day; the latter arise from the former with a wide lumen, and there is no constriction or formation of valves. The distribution of the first five tentacular canals is neither radial nor bilaterally symmetrical, but asymmetrical in this way that the two tentacles of the two ventral interradii receive their water-canals from the median ventral radial canal, while the tentacle of the median dorsal, as well as that of the left dorsal interradius, is supplied by the left dorsal radial canal, while the tentacle of the right dorsal interradius receives its supply from the right dorsal radial canal. All the tentacular canals arise from the radial canals by a narrow piece which is at first very short, but which elongates later; this opens by a valve into the wider part of the canal which lies in the tentacle itself. Notwithstanding its small size this valve may be seen to be formed of two semilunar valves, such as are already known in the tentacles of *Synapta*. On either side of the valve the enlarged portion of the tentacular canal widens out into a short cæcum; this is the foundation of the homologue of the tentacular ampulla which Hérouard discovered in the adult animal. On the fifteenth day the tentacles begin to show signs of their future arborescence.

The first two feet are laid down on the eighth day; they are first in a pit-like depression of the skin, and have the form of a hemispherical projection. On the succeeding days they become more and more tubular, and on the fifteenth a well-developed terminal disc becomes apparent. Their musculature is a direct continuation of that of the radial canal, and is exclusively formed of longitudinal muscular fibres. At the origin of the foot-canals there is a valvular arrangement, but it is much less well developed than that of the tentacular canals. A third foot does not make its appearance till the forty-fifth day, and a fourth not until the eighty-fourth. Further increase in the number of feet does not occur till the one hundred and eleventh day.

Prof. Ludwig does not confirm Selenka's statement that the Polian vesicle lies on the right half of the body, but always on the left, and without exception in that left dorsal interradius where Hérouard constantly found it in the adult. The young stone-canal has a vesicular enlargement, which is the commencement of the future madreporic head of the permanent stone-canal, and which may, therefore, be called the madreporic vesicle; this is the anterior enterocœl of Bury. On the ninety-eighth day of development the vesicle opens by its thin-walled side, and so puts the stone-canal into communication with the cœlom.

By the eighth day the central parts of the nervous system are laid down; both the circular nerve and the radials given off from it consist at this stage solely of closely packed cells, set in several layers one above another. On the next day a finely fibrous layer becomes apparent, the fibres of which run parallel with the long axis of the circular nerves. From the thirteenth day onward separate cells may be found irregularly scattered between these fibres. The circular nerve now consists of an outer cell-layer, and an inner fibrous layer which contains scattered cells. As early as the eighth day the nervous system ceases to have any

connection with the surface, and is everywhere separated from the ectoderm by an intermediate layer of mesenchym. Although the author made a careful search he was unable to find at any stage any indications of auditory organs.

The musculature of the body-wall is formed by cells of the parietal enterocœl. The first formed is the median ventral longitudinal muscle which may, on the ninth day, be made out as a fine simple layer of longitudinal fibres on the inner side of the median ventral radial canal. The separation of the retractor muscles from the longitudinal is not even indicated till the one hundred and eleventh day.

The ectoderm and mesenchym form in the young *Cucumariæ* a continuous tissue which does not till later on become differentiated into a distinct epithelium and an underlying layer of connective tissue. The blood-vascular system is derived from the remains of the cleavage cavity, or from clefts in the mesenchym. A distinct space appears between the visceral layer of the enterocœl and the endodermal wall of the mid-gut on the thirteenth day; this partly forms the marginal vessels of the intestine, and partly the blood-spaces which are found in the wall of the intestine. Lacunar vessels are similarly developed between the parietal wall of the enterocœl and the mesenchym of the body-wall. There is a vestibule in front of the mouth which is invested by a unilaminar and very low epithelium; this is continuous with the outer covering of the tentacles. On the eighth and ninth days the mouth is very narrow and cannot take in food. The coiling of the intestinal tract is obvious on the ninth day; on the fifteenth the mid-gut is considerably widened, and on the seventeenth diatoms were observed in it.

Bathybiaster vexillifer.*—Prof. F. Jeffrey Bell gives a description of the type of this rare and incompletely known form which has for many years since the cruise of the 'Porcupine' been inaccessible, and a comparison is instituted between it and its since described generic allies.

Cœlenterata.

Phylogeny of Actinozoa.†—Prof. J. Playfair M'Murrich discusses various groups of the Actinozoa from the phylogenetic point of view; he points out certain facts which tend to confirm the hypothesis that the Actiniaria are descended from ancestors which possessed an arrangement of the mesenteries similar to that which is found in existing *Edwardsiæ*; explanations are offered of a few points which do not seem to support it.

It is probable that the Actinozoa are to be traced back to an ancestor which possessed only four mesenteries. The *Edwardsia*-stage, in which there are eight, is repeated in the ontogeny of the *Cerianthæ*, the *Zoanthæ*, and the *Hexactiniæ*. The first of these come off close from the *Edwardsia* stock. The direct line of descent leads to a stage in which twelve mesenteries are present; the four additional are imperfect and are arranged in two pairs; so far as we know, this stage is now only larval, but it seems to represent an important epoch in development.

A second offset from the main line gave rise to the *Zoanthæ*, while a third leads to such forms as *Scytophorus*, in which there is, in addition

* Proc. Zool. Soc. Lond., 1891, pp. 228-31 (2 pls.).

† Journal of Morphology, v. (1891) pp. 125-61 (1 pl.).

to the twelve primary mesenteries, a single mesentery present on each side of the dorsal directives. A fourth offset leads to *Gonactinia*, which presents a stage in advance of *Scytophorus*. Further on *Oractis* is reached, in which there are two pairs of imperfect secondary mesenteries.

All the forms hitherto mentioned are strictly bilateral; so in reality also are the Hexactinian, as may be shown if their structure be regarded as a development from the plan seen in *Scytophorus*, *Gonactinia*, and *Oractis*. An explanation is offered of the difficulties presented by the *Halcampæ*, some of which have, and some of which have not, secondary mesenteries; the latter are looked on as derivates of the former in which

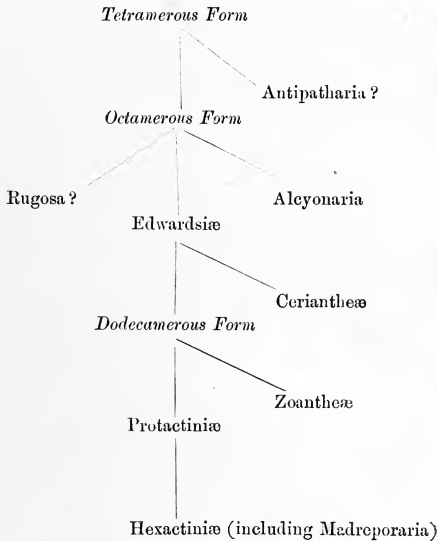

there has been an arrest of the development of the secondaries. The *Peachiæ* appear to have arisen from forms which possessed a complete cycle of secondary mesenteries, one pair of which—the dorso-lateral—has been lost.

Recent observations have taught us that the Madreporaria are constructed upon essentially the same plan as the Hexactiniæ; the author quotes and accepts Hertwig's opinion on this point. He sums it up in saying that the arrangement of the mesenteries and the order of their appearance demonstrate conclusively that the majority, if not all of the Hexacoralla are closely related to the Hexactiniæ.

There does not seem to be much room for doubt that the mesenteries of the *Rugosa* increased in a bilateral manner, but it is still a matter for doubt whether the primary plan of the organism was hexamerous or tetramerous. In any case, the mode of formation of the septa in the *Rugosa* seems to have been entirely different from that which obtains in the *Hexacoralla*, and it is, therefore, unlikely that there is any intimate relation between the two groups.

The *Aleyonaria* were, possibly, antecedent phylogenetically to the *Edwardsiæ*; the arrangement of the mesenterial musculature seems to the author to be simpler, and the slight development of the siphonoglyphs a point of considerable importance. At any rate, the group is one that is very highly specialized. A pressing need is the careful and comprehensive study of the filaments of the *Aleyonaria*. Provisionally they are regarded as forms which branched off from an *Octactinian* ancestor which they had in common with the *Edwardsiæ*.

It is still difficult to suggest the history of the *Antipatharia*, but Prof. M'Murich is inclined to regard the six-mesenteried condition as the more primitive.

The phylogenetic diagram given in the preceding page is offered.

The term *Protactiniæ* denotes an order consisting of forms with twelve primary mesenteries; and with one or a pair or two pairs of secondary mesenteries on each side of the sagittal axis; this order includes *Scytophorus*, *Gonactinia*, and *Oractis*.

Coral-Studies.*—Dr. A. R. v. Heider discusses under the above title a coral which Heller described as *Madracis pharensis*, *Astrocœnia pharensis* n. sp. It belongs to the family *Oculinidæ* and to the genus *Madracis*, to which should also be referred *Axohelia* M. Edw. et H., *Astrœa decactis* Lyman, *Stylophora incrustans* Duch. et Mich., and *Reussia lamellosa* Duch. et Mich. The genus *Madracis* includes two species—*M. decactis* Verrill from the Atlantic and *M. pharensis* Heller from the Adriatic, which differ in the marking and colouring of the polypes.

Medusæ of Millepora Murrayi and Gonophores of Allopora and Distichopora.†—Dr. S. J. Hickson finds that the male gonads of *M. Murrayi* are borne by medusæ which escape from the ampullæ in which they are developed before the spermatozoa are matured; the ova, as in *M. plicata*, are extremely small and alecithal. They move in an amœboid manner in the cœnosarcial canals, and do not ultimately rest in gonophores or in any specialized portion of the system. The medusæ have no radial or ring canals in the endoderm of the umbrella, no velum, no sensory organs, and no mouth; they are formed by the metamorphosis of either a dactylozoid or a gastrozoid. The sperm-cells originate in the ectoderm of the cœnosarc and wander into the ectoderm of the zooids, where they fuse into aggregations to form a spermarium. This last causes in time a retrograde metamorphosis of the tissues of the dactylozoid, at the distal extremity of which it is formed. A cup-shaped outgrowth next appears which forms the umbrella of the medusa, and subsequently a conical growth of the endoderm penetrates into the substance of the spermarium and forms the manubrium.

* Zeitschr. f. Wiss. Zool., li. (1891) pp. 677-84 (1 pl.).

† Quart. Journ. Micr. Sci., xxxii. (1891) pp. 375-407 (2 pls.).

The male gonophores of *Distichopora* occur in groups of two or three in each ampulla, in different stages of development. The gonad is supported by a small cup-shaped trophodisc and inclosed in a double sac of ectoderm and endoderm. At the distal pole of the ripe gonophore there is a short seminal duct. The male gonophore of *Allopora* differs from that of *Distichopora* in being provided with a club-shaped endodermal manubrium.

The author does not regard the gonophores of the Hydrocorallinæ as degenerate Medusæ, but as special organs of the colony bearing the gonads. This may puzzle those who believe they should draw a sharp distinction between the idea of the "individual" and the "organ" in the Animal Kingdom, but Dr. Hickson is not inclined to believe that it is possible to draw this sharp distinction; they are, as Claus maintains, relative ideas.

Although the classification of the Hydrocorallinæ with the Hydroidea was perfectly justifiable at the time it was made, the progress of our knowledge seems to point to the separation of the former from the latter, that is from the Tubulariæ and Campanulariæ.

Craspedota of the Plankton Expedition.*—Dr. O. Maas concludes as to the Craspedote Medusæ of the Plankton, (1) that the Aglauridæ occur chiefly in the northern part of the Atlantic Ocean, (2) that these are replaced in the median region by the Trachynemidæ, (3) that the Geryoniidæ have a more southern distribution and increase in the number both of species and individuals towards the equator. But there are many individual exceptions.

Development of Hydra.†—Dr. A. Brauer finds that the ova of *Hydra* are developed in the interstitial cell-layer; one cell of the ovary becomes the egg-cell, while the others are broken up and their substance converted into yolk-grains, the so-called pseudo-cells; these are taken up by the growing cell. Cleavage is total and equal and leads to the formation of a large hollow blastula. The formation of the endoderm, which is multipolar, is effected by immigration and division of the blastoderm-cells. After the disappearance of the cleavage cavity the two germinal layers are sharply separated from one another. The ectoderm gives rise to an outer envelope, the chitinous shell, and an inner one which is the internal germinal envelope. The ectoderm is retained and passes into the permanent ectoderm. While the germ is still surrounded by the shell the layer of interstitial cells is formed from the ectoderm. The differentiation of tissues begins after this, the supporting lamella becomes recognizable, and the body-cavity begins to be formed. At the same time the shell disappears. When the embryo has become free the processes of development go on rapidly, the tentacles are formed and the mouth appears. The oral pole is identical with the pole of the directive corpuscle.

It would appear that the method of multipolar endoderm-formation is limited to the Cœlenterata, and, among them, is seen only in those forms in which there is no free-swimming blastula stage; all the forms that have a free-swimming blastula exhibit a polar formation of the

* SB. K. Preuss. Akad. d. Wiss., 1891, pp. 333-8.

† Zeitschr. f. Wiss. Zool., lii. (1891) pp. 169-216 (2 pls.).

endoderm, whether it be hypotropic or by invagination. If this generalization be just it would follow that the mode of movement of the unilaminar vesicle is of importance; multipolar endoderm-formation presupposes that the blastula is made up of cells that are physiologically and morphologically equivalent; but this can only happen if the vesicle rotates all round and has no movement in any given direction.

The author is inclined to regard the multipolar as the more ancient of the two modes of endoderm formation, and he attaches great importance to its presence in *Hydra*, as that animal is universally allowed to be very primitive. In addition to its adult structure, evidence in support of this view is to be found in the great regularity of its cleavage and the large size of the hollow blastula.

Porifera.

Victorian Sponges.*—The first part of Dr. A. Dendy's projected monograph of the Victorian Sponges treats of the organization and classification of the *Calcarea homocœla*, with descriptions of the Victorian species. A short description is given of the *Olynthus*-type, and the histology is next discussed. For, as it seems, the first time, the ectoderm of the *Homocœla* is described; it is found to agree precisely with what Schulze has found in *Sycandra raphanus*; unless specimens are at once immersed in a sufficient quantity of strong spirit and the sections carefully prepared by the paraffin method, it is difficult to make out satisfactorily the structure of the ectodermal epithelium; when well seen in section the ectoderm appears as a delicate but sharp outline, with a moniliform or beaded appearance due to the swelling caused by the presence of the nucleus in each cell; the cells are thin, flattened and plate-like, polygonal in outline and about 0.0136 mm. in diameter. Dr. Dendy throws some doubt on Lendenfeld's statement that the ectodermal cells are ciliated.

The ground-substance of the mesoderm is usually but feebly developed in the *Homocœla*; as yet the different kinds of mesodermal cell-elements that have been recognized are—(1) the ordinary multipolar or stellate connective-tissue-cells, which are the most abundant; (2) amoeboid cells, which are difficult to distinguish from the first; (3) the author is not able to certainly say whether or not subdermal gland-cells are present; and (4) in some there are more or less plate-like endothelial cells of two kinds, and found in two distinct situations. The fifth form of cell is the reproductive, but spermatozoa have not as yet been distinctly seen; the ova are extraordinarily complex in structure, and especially is this the case with their nucleus.

In addition to these various cell-elements the author calls attention to the presence in the mesoderm of yellow granules, which are probably symbiotic algæ.

The constitution of the skeleton is next considered, and it is found to contain the three main forms of spicule alone found among the *Calcarea*—the biradial, the quadriradial, and the oxeote. Considerable attention is given to the canal system.

The author proposes to divide the *Homocœla* into three sections; in

* Trans. Roy. Soc. Victoria, iii. pp. 1-81 (11 pls.).

the first—*H. simplicia*—the Ascon-persons either remain solitary and do not fuse or they form simple colonies in which the component Ascon-persons may branch but never form complex anastomoses nor give off radial tubes, so that the individuality of the different members of the colony is easily recognizable; the *H. reticulata* have a sponge-colony which forms a more or less complex network of branching and anastomosing tubes, so that it is no longer possible to distinguish the individual Ascon-persons of which the colony is composed; in the *H. radiata*, or third group, the sponge consists of a single central Ascon-tube, from which secondary tubes are budded off radially.

Leucosolenia is the only genus recognized in the order; fourteen Victorian species are described, in most cases fully, and three are regarded as doubtful.

Synute pulchella.*—Dr. A. Dendy has a preliminary notice of a new genus of Calcareous Sponges from Port Phillip Heads, which may be imagined as a colony of the Sycon genus *Ute*, in which the component members have become fused together completely, so that the whole colony forms a single vallate mass, in which the individuals can only be recognized externally by their oscula; there is a thick common cortex formed chiefly of huge oxecote spicules.

System of Calcareous Sponges.†—Dr. R. v. Lendenfeld publishes a revised scheme of classification of the Calcareous Sponges; a new Adriatic Syconid, the chambers of which open by groups into the oscular tube, is made the type of a new sub-family of Sycanthinæ, while the Syconids with unjointed tube-skeleton form the new sub-family Amphoriscinæ.

Sponge-Fauna of the Red Sea.‡—Prof. C. Keller, who has made an exhaustive investigation of the sponge-fauna of the Red Sea, finds that fifty-three genera are represented by eighty-eight species, fifty-four of which belong to the Monactinellidæ. Among these the Chalinidæ are best represented; the Renieridæ are remarkable for the new genus *Dasiuria*. It is remarkable that there should be no representative of the widely-spread genus *Geodia*. No Hexactinellids are yet known from the Red Sea. The chorographical relations of the fauna are worked out, and there is a discussion of the vertical distribution, and its influence on the mechanical construction of the Sponge-body. He finds that purely mechanical characters will explain many of the morphological peculiarities of the sponge-organism—not only the necessity of primary and connecting fibres, but of spongin structures in general. The mechanical cause which led to the formation and successive development of Monactinellids and horny sponges is the influence of the pressure of moving water. It would be interesting to make observations on the thickness and elasticity of fibres in a given species, and to correlate them with variations in locality and depth.

Protozoa.

Dictyochida.§—Herr A. Borgert regards these forms not as Radiolarians, as Haeckel, Hertwig, and others do, but as an order of Mastigo-

* "Roy. Soc. Victoria," 1891, pp. 1-6.

† SB. K. Akad. Wiss. Wien, c. (1891) pp. 4-19.

‡ Zeitschr. f. Wiss. Zool., lii. (1891) pp. 294-368 (5 pls.).

§ Op. cit., li. (1891) pp. 629-76 (1 pl. and 2 figs.).

phora. He suggests that they might be called Silicoflagellata, and defines them as follows:—"Flagellate-like organisms, with a radially symmetrical shell composed of hollow siliceous elements, with an unensheathed body and a long thin flagellum, with a nucleus (observed only in *Distephanus speculum*) vesicular in form and consisting of a central nucleolus and a vacuolar cortex." The shells do not consist, as Hertwig and Haeckel believed, of the isolated skeletal elements of various species of Phæodaria, but are the true "houses" of independent individual organisms. What Hertwig and Haeckel observed were originally skeletonless Phæodaria which had taken up the shells of Dictyochida into their substance. Herr Borgert gives a detailed account of *Distephanus speculum*—a species whose variations cover eighteen forms, to which specific rank has been granted. His memoir also includes an account of the minute structure of the parapyla in the central capsule of Phæodaria and a note on *Sagenoarium Chuni* g. et sp. n. from the Atlantic.

Pelomyxa viridis.*—Prof. A. G. Bourne gives an account of a new species of *Pelomyxa* found in a pond at Madras, and takes the opportunity of making some remarks on the vesicular nature of protoplasm. The new species is about 1/10 in. in diameter, and is interesting not only from being larger than any known form of the Lobosa, but because of the presence of chlorophyll and symbiotic Bacteria. It should be noted that the bodies which Prof. Bourne regards as Bacteria were described by Greef as crystals of unknown composition, and by Leidy as exhibiting transverse striations.

In describing the structure of his new form, the author uses the word protoplasm in the sense in which Bütschli uses the word plasma. It designates the substance which Leydig calls spongioplasma, as distinguished from hyaloplasma. He is inclined to support the view of Bütschli that the plasma is the substance which forms the envelopes of the vesicles, and that it does not include their contents. He finds that he can distinguish in *P. viridis* between two varieties of non-contractile fluid-containing spaces, the vacuoles containing water, and the vesicles having chlorophyllogenous contents.

The protoplasm of *P. viridis* appears to be perfectly homogeneous, and small portions of it may at times be observed at the periphery of the organism free from all contents, but the great mass of it forms a mere scaffolding for the numerous vesicles, and is, moreover, densely packed with Bacteria, to say nothing of its various other contents. The vesicles contain a fluid substance impregnated with chlorophyll. The vesicles and the Bacteria are to be regarded as bodies contained in the protoplasm, and the latter may flow out, leaving all its contents behind. When the protoplasm does flow out in this way some of the Bacteria soon follow, and may be seen to start an active movement; and, if the outflow continues, the superficial vesicles leave the central mass and may be seen isolated in the hyaline protoplasm.

The author discusses the protoplasmic movements, and states that the large pseudopodia are protruded at a velocity of about .75 mm. a minute; Engelmann regarded a velocity of .5 mm. as exceptionally rapid. The number of nuclei in *P. viridis* is enormous; a large individual may, it is estimated, have as many as 10,000. He suggests that

* Quart. Journ. Micr. Sci., xxxii. (1891) pp. 357-74 (1 pl.).

there may be some connection between the bulk of nuclear matter and the bulk of protoplasm connected with it; it is pointed out that all these nuclei occupy 1/60 of the total bulk of the organism, and that the same proportion holds in the mammalian ovum.

Other contents of the organism are small globular refractive bodies, which appear to be of a fatty nature, and food-debris.

In conclusion the author directs attention to the views of the late Dr. Gulliver, published in a paper in our 'Transactions.*' Dr. Gulliver believed that the exoplasm was permanently differentiated from the endoplasm, and that the latter was composed of a number of cells. Though not accepting these views, Prof. Bourne allows that *Pelomyxa* may exhibit appearances which justify them. The phenomenon of the breaking away of the exoplasm is a mere accident in the hardening process. The appearance of several cells may be due to an accidental rounding off of portions of protoplasm, which takes place during the hardening process.

Unfortunately the author is unable to throw any light on the reproductive processes which may obtain in *Pelomyxa*.

Foraminifera of Hammerfest.†—Mr. E. W. Burgess gives a list of fifty-one species of Foraminifera found in mud from the bottom of Hammerfest Harbour; some are very rare, such as *Cassidulina crassa*, *Lagena striato-punctata*, *Lagrina dimorpha*, and *Spirillina limbata*.

New Monocystidea.‡—Sig. P. Mingazzini describes from the Gulf of Naples—*Cytomorpha Diazonæ* g. et sp. n. from *Diazona violacea*, *Lecudina* (g. n.) *pellucida* Köll. from *Nereis cultrifer*, *Lecudina Leuckartii* sp. n. from *Sagitta*, *Köllikeria Staurocephali* g. et sp. n. from *Staurocephalus Rudolphi*, *Lobianchella beloneides* g. et sp. n. from *Alciope*, *Ophioidina elongata* g. et sp. n. from *Lumbriconereis*, *Ophioidina Hæckelii* sp. n. from *Sapphirina*, *Oph. heterocephala* sp. n. from *Nephtys scolopendroides*, and *Oph. Discocelides* from *Discoscelis tigrina*.

Tudor Specimen of Eozoon.§—Mr. J. W. Gregory has had the opportunity of making a close examination of the so-called "Tudor specimen of *Eozoon*." The importance of this specimen lay in the fact that the opponents of the organic nature of *Eozoon* argued in favour of the mineral origin of specimens from the fact that the appearances of organic structure were seen only in serpentinous limestones, whereas the Tudor specimen was found in pure carbonate of lime. It has always been agreed that this example, therefore, was of great value as a crucial test.

Mr. Gregory finds himself unable to recognize any trace of the "proper wall," "canals," or "stolon passages" which are claimed to occur in *Eozoon*, or any reasons for regarding the calcite bands as the "intermediate skeleton" of a foraminifer. The bands in the specimen appear to be of secondary origin. Other authorities who have had an opportunity of seeing this specimen appear to all agree that the "Tudor specimen of *Eozoon*" at any rate is not of organic origin.

* See this Journal, 1888, p. 11. † Midland Naturalist, xiv. (1891) pp. 153-8.

‡ Atti R. Accad. Lincei—Rend., vii. (1891) pp. 467-74.

§ Quart. Journ. Geol. Soc. Lond., xlvii. (1891) pp. 348-55 (1 pl.).

BOTANY.

A. GENERAL, including the Anatomy and Physiology
of the Phanerogamia.

a. Anatomy.

(1) Cell-structure and Protoplasm.

Function of the Nucleus.*—Herr J. Gerassimoff has found that cells without nuclei occur in *Sirogonium* and in various species of *Spirogyra*. As the neighbours of the non-nucleated cells have two nuclei, the absence of the nucleus is explained by supposing that in cell-division one of the daughter-cells retains both of the daughter-nuclei. Herr Gerassimoff was able to study these non-nucleated cells in their natural conditions, and found that they were short-lived. In the binucleated cells the nuclei lay opposite one another in the peripheral protoplasm and on a line bisecting the cell transversely. The author's theory is that the nucleus is the seat of a specific energy, such that two nuclei repel one another.

"Attractive Spheres" in Vegetable Cells (Tinoleucites).†—M. L. Guignard calls attention to the fact that, in studying the phenomena accompanying nuclear division in animals, especially at the moment of fecundation, and later in the embryonic tissues, a special element known as an "attractive sphere" has been observed. Hitherto the presence of these bodies has not been noticed in plants, but the author states that they exist in the primordial mother-cells of the pollen of certain plants (*Lilium*, *Listera*, *Naias*), in the mother-cell of the embryo-sac, &c. These bodies rather merit the name of "directing spheres," since they govern the division of the nucleus, and are transmitted from cell to cell without discontinuity during the whole life of the plant.

M. E. De Wildeman ‡ confirms M. Guignard's observations on all important points, and finds the phenomena to agree closely with those observed by Van Beneden in the ovum of *Ascaris megalcephala*. In its typical condition the attractive sphere consists of a small central mass or centrosome, which is coloured somewhat more strongly than the surrounding protoplasm by staining reagents. This mass is surrounded by a delicate hyaline zone, and this again by a thicker granular zone; in certain cases the granulations of the latter have a radial arrangement, especially during the phases of division. When the cell is at rest, the attractive sphere is situated near the nucleus; when the cell is dividing, the sphere divides into two, one of the new spheres being placed at each pole of the spindle. Very typical examples of these attractive spheres occur in *Spirogyra*, especially *S. nitida*; they have also been observed in the mother-cells of the spores of *Anthoceros lævis* and *Isoetes Durieui*, and in those of several mosses, *Funaria hygrometrica*, *Ceratodon purpureus*, and *Bryum caespitosum*. For the observation of these structures the fixing material used should not be alcohol,

* Bull. Soc. Imp. Nat. Moscou, 1890 (1891) pp. 548-54 (3 figs.).

† Comptes Rendus, cxii. (1891) pp. 539-42.

‡ Bull. Acad. Roy. Sci. Belgique, lxi. (1891) pp. 594-602 (1 pl.).

but chrom-acetic acid (0·7 parts chromic acid and 0·3 parts glacial acetic acid, in 100 parts water).

For these "attractive spheres," which have the property of inciting and directing the binary division of nuclei, M. P. Van Tieghem* proposes the term "directing leucites" or *tinoleucites*.

Nature of Callus.†—Mr. S. Le M. Moore has investigated the chemical nature of the stoppers of callus in the sieve-tubes of the vegetable marrow and of *Ballia callitricha*. The following is a summary of the chief results.

The callus of the vegetable marrow gives all the three chief proteid reactions; it is also dissolved by a peptonizing fluid, and is therefore a typical proteid. The callus cannot be pressed from the sieve, both because it is a proteid, and because, when it undergoes digestion, the sieve-plate is "cleared," and is then left in its pristine condition. The stoppers of *Ballia* give all three proteid reactions, but are not attacked by a peptonizing fluid; they stain in the same way as does callus, except that they take a rich brown with iodine alone, and are untouched by anilin-blue. The stoppers react altogether differently from the wall of the cell-tubes, and to a very large extent similarly to the cell-protoplasm.

The callus of the vegetable marrow has many of the characters of the coagulated proteids, and should probably be classified with them; the substance of the stoppers of *Ballia* most closely resembles lardacein. The function of the callus, in both cases, is to moderate the flow of proteids, and direct it so that all the growing points shall receive their due amount of the necessary food-material. Many of the phenomena presented by the dissolution and renewal of the masses of callus on sieve-plates call to mind the action of ferments.

(2) Other Cell-contents (including Secretions).

Aleurone-grains in Papilionaceæ.‡—The following is a *résumé* of M. E. Belzung's researches on the above subject:—(1) The aleurone-grains of Leguminosæ arise at the periphery of the cells; they are small and insoluble in water, and are formed of legumin. (2) Their deposition begins when the cell-sap is sufficiently concentrated, and the proportion of free acid large enough to cause the precipitation of the albuminoid principle. (3) The aleurone-grains enlarge rapidly, and then, in virtue of their osmotic property, vacuoles arise. (4) The mature aleurone-grain consists of a regular or irregular network containing in its meshes a sap rich in dissolved albuminoids. A circular wall borders a large central aquiferous vacuole. Both network and circular wall are insoluble in water. (5) In the species examined the aleurone-grains contain no inclosed substances. (6) When the grain is completely mature, an albuminoid principle, soluble in water, and precipitated by heat or by certain acids, more or less completely fills the vacuoles. (7) In the presence of water, and with a tempera-

* Journ. de Bot. (Morot), v. (1891) pp. 101-2.

† Journ. Linn. Soc. (Bot.), xxvii. (1891) pp. 501-26 (1 pl.).

‡ Journ. de Bot. (Morot), v. (1891) pp. 85-93, 109-16 (14 figs.).

ture insufficient to induce the commencement of germination, vacuoles again form in aleurone-grains.

Chlorophyll.*—From a spectroscopic examination of the chlorophyll of *Spirogyra*, *Ulva latissima*, and several Ferns and Flowering Plants, Mr. G. Mann has come to the following conclusions:—Chloroplasts consist of a green protoplasmic ground-substance, which is rendered spongy by the presence of an oily material secreted by the ground-substance, and enclosed in a clear protoplasmic envelope. The oily material in *Spirogyra* is partly given off directly into the surrounding protoplasm, partly consumed by the ground-substance. Chlorophyll does not consist of a mixture of a yellow and a blue colouring matter, but is a green substance, which readily decomposes into a yellow and a blue substance. The first absorption-band of Kraus really consists of two bands. The fourth band of Kraus is probably a decomposition-product. Measurements are given of the position of the six bands in the various examples examined, the following being the variations:—Band 1 = λ 686·69–661·5; Band 2 = λ 656·86–640·93; these two constitute together Kraus's Band I; Band 3 (Kraus's Band II), centre at λ 616·6; Band 4 (Kraus's Band III) centre at λ 578; Band 5 (Kraus's Band V) = λ 514·9–460·9; Band 6 (Kraus's Band VI) = λ 452–440·75.

Sulphur in Plants.†—MM. Berthelot and G. André have investigated the quantities of sulphur present—whether as sulphates, organic sulphur, or volatile sulphur—in the seed and in the plant during germination, flowering, and fructification, in *Sinapis alba*, *Camelina sativa*, *Allium cepa*, *Lupinus albus*, *Urtica dioica*, *Tropæolum majus*, and *Arena sativa*. They find the total quantity of sulphur to increase continually from germination to flowering, but the relative quantity to decrease. The organic sulphur reaches a maximum when the plant is in flower. They believe that the sulphur is not absorbed from the soil entirely in the form of sulphates.

Calcium oxalate in the Bark of Trees.‡—Herr G. Kraus finds that a large quantity of calcium oxalate is stored up in the bast-layer of the bark of many trees and shrubs, where it plays the part of a reserve food-material, i. e. it is, to a large extent, as much as 50 per cent., taken up again on the revival of the activity of growth in the spring. Calcium oxalate is soluble in many of the organic acids that occur in the tissues of plants.

Crypto-crystalline Calcium oxalate.§—Prof. G. Arcangeli has observed that the deposit of calcium oxalate in the cells of a large number of plants has the form of a crystalline powder. In the Cinchonæ and Solanæ these crystals have a diameter of no more than 1–3 μ ; they belong without doubt to the tetrahedral system.

* Trans. and Proc. Bot. Soc. Edinb., xviii. (1889–90) pp. 394–420 (2 pls.).

† Comptes Rendus, cxii. (1891) pp. 122–5.

‡ 'Ueb. d. Kalkoxalate d. Baumrinden,' Halle, 1891. See Biol. Centralbl., xi. (1891) p. 282.

§ Nuov. Giorn. Bot. Ital., xxiii. (1891) pp. 367–73.

(3) Structure of Tissues.

Differentiation of the Endoderm.*—M. P. Lesage notes that in many plants (the bean, radish, &c.), the endoderm, especially of the root and of the hypocotyl, may possess a different structure, even in different spots of the same transverse section; in one spot it may be suberized, in another spot amyliiferous. As a general rule the cell-walls of the endoderm become more and more differentiated the greater the distance from the summit of the root; and in the same plant this differentiation may be manifested at very different distances from the summit, according to the mode of development of the root.

Folded Tissue.†—M. P. Van Tieghem states that the endoderm of the root, and often of the stem and leaf, shows a more or less decided suberification or lignification of its membranes, strictly limited to one band on the lateral and transverse faces of its cells, and unaccompanied by any thickening. This has been termed by the author *tissu plissé*, and may occur in other regions besides the endoderm. Thus in the Coniferæ and Cycadææ the piliferous layer of the root, which is of epidermal origin, is formed by this variety of lignified parenchyme. This is the first time that this tissue has been met with at the periphery.

Secretory System of Papilionaceæ.‡—Sig. P. Baccarini states that the secreting elements in the Leguminosæ—which mostly contain tannin—form two principal systems in the branches and leaves, one of them consisting of tubular elements of greater or lesser length which accompany the xylem and the phloem of the vascular bundles in their course, the other consisting of idioblasts scattered among the cells of the cortex and of the parenchyme of the leaf. The xylem-tubes are always situated on the periphery of the pith; those of the phloem occupy various positions, being often dispersed among the sieve-tubes. The greater number of Leguminosæ are furnished with these tubes in both the xylem and phloem, though others have them in one or other only of these portions of the vascular bundles. Idioblasts occur in the cortex in most species examined. Those found in the parenchyme of the leaves either form a special layer in the spongy parenchyme, or are in immediate contact with the epiderm of both surfaces, forming a kind of sheath which incloses the mesophyll, or less often they are dispersed among the palisade-cells. A considerable number of Leguminosæ are destitute of these secretory idioblasts.

M. P. Vuillemin § criticizes several points in Sig. Baccarini's paper. Tanniferous cells or tannocysts are but feebly developed, or are entirely wanting, throughout the tribes Genisteæ, Viciææ, and Trifoliææ; the inconstancy of the characters of other tribes in this respect is often due to errors of classification; or sometimes to the substitution of the tanniferous by some other secretory system, as, for example, by oxaliferous cells. The special structure of the tannin-cells is described in a large number of cases.

* Comptes Rendus, exii. (1891) pp. 1522-3.

† Journ. de Bot. (Morot), v. (1891) pp. 165-9.

‡ Malpighia, iv. (1891) pp. 431-5; and Nuov. Giorn. Bot. Ital., xxiii. (1891) pp. 297-301.

§ Bull. Soc. Bot. France, xxviii. (1891) pp. 193-200.

Alkaloid-receptacles of the Fumariaceæ.*—Herr W. Zopf has investigated the chemical nature of the contents of the special receptacles of the Fumariaceæ. He found the underground organs of *Corydalis cava* to contain six different substances, viz. :—(1) a resin-acid soluble in benzol, (2) a resin-acid insoluble in benzol, (3) a yellow acid pigment soluble in water, (4) a yellow-green oil, (5) a special alkaloid, corydalin, (6) sugar. Of these substances, the one which is especially found in the idioblasts of the aerial organs is the alkaloid corydalin, which is replaced in *Fumaria* by fumarin, and in *Dicentra*, *Adlumia*, &c., by other special alkaloids. The alkaloids have their origin partly in the primary, partly in the secondary meristem.

Latex-receptacles.†—According to Herr M. Dehmel, latex-tubes are organs for the conduction of nutrient material, and are therefore nearly related to sieve-tubes. In the species of Compositæ examined, all the Liguliferæ contained latex, but none of the Tubulifloræ.

M. Thouvenin‡ describes the laticiferous system in *Cardiopteris lobata*, belonging to the Olacaceæ. In the stem the latex-tubes occur in the middle region of the cortex, in the liber, and in the periphery of the pith; they are also found in the petiole and in the veins of the leaf.

Sieve-fascicles in the Secondary Xylem of Belladonna.§—Dr. G. Beauvisage states that the details of the anatomical structure of the roots of *Atropa Belladonna* have hitherto been only inadequately described. In the secondary tissues there is a somewhat abnormal structure analogous to that described in the stems of *Strychnos*, which consists in the presence of numerous sieve-fascicles in the secondary xylem. In the case of *Strychnos* two modes of formation have been suggested, the one by De Bary, the other by M. Hérial. After careful research the author finds that proposed by De Bary to be applicable to *Atropa Belladonna*. It is that the cambial zone, instead of giving rise, as is usual, to sieve-tubes without and vessels within, produces both on its internal face.

Extra-phloem Sieve-tubes and Extra-xylem Vessels.||—M. P. Van Tieghem states that sieve-tubes can be formed outside the phloem, in the root, stem, and leaf. A lateral root of *Strychnos nux-vomica* has six phloem-bundles, and as many primary alternate xylem-bundles outside the pith. At the periphery of the pith small bundles may be seen, which are composed of narrow sieve-tubes and parenchymatous cells; these circummedullary sieve-bundles are formed at first in correspondence with the primary xylem-bundles. Sieve-tubes are occasionally found in the cortex of the stem, for example in Cucurbitaceæ and certain Melastomaceæ. The stem of Cucurbitaceæ also has sieve-tubes in the pericycle. Vessels may be found outside the primary xylem also, in the root, stem, and leaf. Many Monocotyledons produce vessels in the pith of their roots larger than those which form the xylem-bundles.

* Ber. Deutsch. Bot. Gesell., ix. (1891) pp. 107-17. Cf. this Journal, 1887, p. 427.

† 'Beitr. z. Kenntniss d. Milchsaftbehälter d. Pflanzen,' Liegnitz, 1889, 46 pp. See Bot. Centralbl., xlv. (1891) p. 385.

‡ Bull. Soc. Bot. France, xxxviii. (1891) pp. 129-30.

§ Journ. de Bot. (Morot), v. (1891) pp. 161-3.

|| Tom. cit., pp. 117-28.

Vessels may also be found in the rays which separate the xylem-bundles and in the pericycle of the roots, as in *Taxus* and *Torreya*. The stem can produce primary extra-xylem vessels in the cortex, in the pericycle, and in the pith.

Extra-phloem Sieve-tubes in the Root of the *Enothereæ*.*—Mdlle. A. Fremont finds that sieve-tubes may occur in the *Enothereæ* either in the pith of the root, in the secondary xylem, or in the "ulterior pith," by which term the authoress designates a cellular structure sometimes formed in the axis of a root after the separation of the vascular bundles which at first formed a closed central cylinder. Medullary sieve-tubes in the root have hitherto been only known in three families of Dicotyledons, viz. Cucurbitaceæ, Loganiaceæ, and Apocynaceæ. Mdlle. Fremont points out, however, that circummedullary sieve-tubes, situated at the internal edge of the primary xylem-bundles, exist in *Enothera Fraseri* and *E. riparia*. Good examples of sieve-tubes produced by local differentiation of the secondary woody parenchyme are to be found in *E. parviflora*, *cruciata*, *macrocarpa*, *Sellowii*, and *Fraseri*; and finally it is pointed out that sieve-tubes exist in a region where they have not before been observed, viz. in the ulterior pith of the root. A good example of this occurs in *Epilobium parviflorum*.

Cystoliths of *Ficus*.†—Herr A. Zimmermann has examined the cystoliths in the leaves of *Ficus elastica*, and supports Kny's view that the strings which penetrate them in a radial direction at right angles to the stratification, are solid, and consist essentially of cellulose, rather than Giesenhagen's, that they are hollow cylinders filled with lime. In the Acanthaceæ, on the other hand, the radial strings are the part of the cystolith which contain the smallest amount of cellulose.

Commenting on this communication, Herr C. Giesenhagen‡ says that he thinks that Zimmermann has been led into error by examining only cystoliths from which the lime has been removed.

Herr Zimmermann, in reply,§ states that a fresh series of observations has confirmed his previous conclusions.

Supporting-elements in the Leaf.¶—M. E. Pée-Laby describes special organs of support which he finds in the leaves of Dicotyledons. These may either have the form of fibres in the woody pericycle (*Hakea*, *Burchellia*), or may consist of isolated cells. These, again, are either simple cells, as in *Osmanthus aquifolius*, *Olea europea*, and *Phillyræa*, or they are branched (spicular cells), as in *Limnanthemum nymphæoides*, *Begonia sanguinea*, *Ternstrœmia japonica*, &c. In all cases these organs make their appearance only when the leaf is assuming its final form.

Anatomy of Conifers.¶¶—Herr F. Berger argues against the correctness of the distinction drawn by Caspary between two different kinds of tracheid in Coniferæ, viz. the conducting cells in the medullary sheath

* Journ. de Bot. (Morot), v. (1891) pp. 194-6.

† Ber. Deutsch. Bot. Gesell., ix. (1891) pp. 17-22 (1 fig.).

‡ Tom. cit., pp. 74-7.

§ Tom. cit., pp. 126-8.

¶ Comptes Rendus, cxii. (1891) pp. 1276-9.

¶¶ 'Beitr. z. Anat. d. Coniferen,' Halle, 1889, 8vo, 33 pp. See Bot. Centralbl., xlvi. (1891) p. 363.

and the fusiform cells in the wood. The distinction is, he states, supported neither by the history of their development nor by any difference in their structure.

The resin-passages (in *Pinus Strobus*) may be divided into two kinds—the large passages situated in the inner layers of the cortex, and the smaller passages situated nearer the periphery. The former kind traverse the branch from its base to its apex, and are in uninterrupted communication with those of the previous year.

Anatomy of *Ipomœa versicolor*.*—Dr. D. H. Scott finds the following peculiarities of structure in the twining stem of this plant, belonging to the Convolvulacæ:—It possesses the bicollateral structure of the vascular bundles, which is very characteristic of the order; but, while the structure of the greater part of both stem and root is normal, the transitional region between the two presents singular abnormalities. The internal phloem extends downwards into the hypocotyl, and passes out between the converging protoxylem-groups of each cotyledonary pair of bundles, thus joining the external phloem of the root. The hypocotyl and adjacent parts of the stem and root have a complex secondary wood containing numerous strands of interxylary phloem (phloem-islands) imbedded in parenchyme, and produced centrifugally by the cambium.

(4) Structure of Organs.

Changes in the Form of Plants produced by Moisture and Etio-lation.†—Herr J. Wiesner has investigated the changes produced in those plants which bear a rosette of ground-leaves, but no stem-leaves, by growing either in an atmosphere saturated with moisture or in darkness, and finds that they can be arranged in the four following categories:—(1) Those which, both in a saturated atmosphere and in the dark, lose their radical rosette and form well-developed internodes in the stem (*Semperivum tectorum*); (2) Those which undergo no change under either of these conditions (*Oxalis floribunda*, *Plantago media*); (3) Those which form well-developed internodes under the influence of darkness, but not under that of saturation (*Taraxacum officinale*); (4) Those which form well-developed internodes under the influence of moisture, but not under that of darkness (*Capsella bursa-pastoris*).

Mangrove-vegetation.‡—Herr G. Karsten enters into further details respecting the structure of the Rhizophoreæ and other trees which compose the mangrove-vegetation of the swamps of the Malayan Archipelago. In his observations on the structure of the embryo-sac and the development of the embryo, he agrees, in all essential points, with Treub.§ In all cases, except *Lumnitzera* and *Sonneratia*, the embryo-sac breaks through the nucellus, usually consumes it, and hence lies free in the integument. Typical formation of endosperm occurs in *Scyphiphora* and *Nipa*. In sheltered situations many mangrove-trees are “vivi-

* Ann. of Bot., v. (1891) pp. 173-9 (2 pls.).

† Ber. Deutsch. Bot. Gesell., ix. (1891) pp. 46-53.

‡ Biblioth. Bot. (Luerssen u. Haenlein), Heft 22, 1891 (71 pp. and 11 pls.). Cf. this Journal, ante, p. 365.

§ Cf. this Journal, 1885, p. 271.

parous," i. e. the seeds germinate while still attached to the parent-tree. That the aerial roots in *Bruguiera eriopetala* and other species are organs of respiration, is unquestionable. In *Rhizophora Mangle* their chief function is a supporting one; but they also possess large inter-cellular spaces which serve to assist respiration. Similar aerial roots or "pneumatophores" occur also in many other plants. All mangrove-trees contain large quantities of tannin, which is probably serviceable in preventing rotting.

Stigmatic Disc of Vinca.*—Sig. M. Pitzorno has studied the structure of the viscid discoidal expansion which lies beneath the tuft of hairs on the stigma of *Vinca major*, and which plays an important part in the process of pollination. He finds that the viscid substance which is exuded, during the time of flowering, from the periphery of the stigmatic disc, is a product of the secretion of special glandular hairs which clothe its margin. The exudation takes place by simple diffusion through the membrane of these hairs. The viscid substance appears to be the result of a chemical transformation of starch-grains which are present in abundance in the subjacent parenchyme; the transformation takes place within the glandular hairs.

Pollen of Strelitzia.†—Herr E. Palla describes the structure of the threads which are found among the pollen-grains of *Strelitzia reginæ*, and which have been mistaken by some writers for pollen-tubes. Each thread usually consists of two or three, less often of four cells, the length of which varies between 200 and 550 μ ; the end of the thread is frequently closely attached to a pollen-grain. As to their origin, each thread was originally a row of cells belonging to the epidermal portion of one of the two pollen-sacs, which had become detached from the rest of the tissue shortly before the bursting of the anther. The threads appear to continue to grow in length among the pollen-grains after their separation. Their object appears to be to assist in the dissemination of the pollen, which is chiefly brought about by the agency of birds.

Stomates in the Calyx.‡—Herr W. Korella found that, out of 288 species of plants examined, belonging to 192 genera and 58 families, stomates were entirely wanting in the calyx in only five species; in by far the greater number they were present on both surfaces. Their size and their distribution over the surface of the sepals vary greatly.

Fruit and Seed of the Juglandæ.§—Sir John Lubbock describes the structure and development of the fruit and seed of *Pterocarya*, and compares them with those of the walnut. The fruit of the former is winged, while that of the latter is not. While the cotyledons of *Pterocarya* are leaf-like and aerial in germination, those of the walnut never emerge from the seed, but are curiously folded by the efforts made to occupy the interior of the nut. The seeds of the walnut are large and contain a supply of nutriment, which causes them to be dispersed by

* Nuov. Giorn. Bot. Ital., xxxviii. (1891) pp. 280-2.

† Ber. Deutsch. Bot. Gesell., ix. (1891) pp. 85-91 (1 pl.).

‡ 'Ueb. d. Vorkommen u. d. Vertheilung d. Spaltöffnungen auf d. Kelchblättern,' Königsberg, 1889, 68 pp. and 1 pl. See Bot. Centralbl., xlv. (1891) p. 385.

§ Journ. Linn. Soc. (Bot.), xxviii. (1891) pp. 247-54 (6 figs.).

squirrels and other animals, while in the case of *Pterocarya* the dissemination is aided by the wings of the fruit.

Leaves of Viburnum.*—Sir John Lubbock points out and attempts to explain the remarkable difference between the leaves of our two native species of *Viburnum*,—*V. Opulus* and *V. Lantana*. The former have stipulæform appendages, while the latter are entirely exstipulate; the former have honey-glands at the base of the lamina, the latter have not. The former of these two differences he attributes to the different way in which the leaves are folded in the bud, in consequence of those of *V. Opulus* being three-lobed, those of *V. Lantana* not lobed. The honey-glands probably serve to protect the young and tender leaves of *V. Opulus*, which are quite smooth, from the attacks of caterpillars and other insects, while the leaves of *V. Lantana* are otherwise protected by a felt of hairs.

Form and Function of Stipules.†—Sir John Lubbock adduces a number of examples where, within the same natural order, some species have stipulate, others exstipulate leaves, and endeavours to arrive at a general law governing the presence or absence of stipules. He believes that, as a general rule, the difference has reference to the mode of protection of the bud. This protection may be effected in various ways,—by the stipules, by the base of the leaves, by the more or less expanded base of the petiole, by the pedestal of the petiole, by scales, by hairs, by gummy secretions, &c. Sometimes, also, the stipules assume the function of the leaves themselves, or they become spiny and serve as a general protection to the plant, or they are glandular, &c.

Pearl-like Glands of the Vine.‡—According to Herr H. Müller-Thurgau, the small pearl-like structures which occur on the young branches and leaves of most, though not of all, varieties of the grapevine, are of a trichomic nature. They are usually spherical, and are elevated on a short pedicel; from ten to twenty large cells are covered by a small-celled epiderm, usually provided with one stomate to each gland. Their formation is independent of the vigour of the plant or of the moisture of the air. Their purpose appears to be to serve as protecting organs against the attacks of small animals.

Roots springing from Lenticels.§—Herr H. Klebahn describes the roots which spring from beneath the lenticels in the stem of *Solanum Dulcamara*, often even at a considerable distance from the soil. These roots possess a well-marked root-cap, dermatogen, periblem, and plerome.

Somewhat similar structures are found in *Herminiera Elaphrozylon*, a floating plant belonging to the Papilionaceæ from the Nile region; and here also are remarkable tubercles on the roots, the tissue of which is partly of an aerenchymatous character. They contain also, beneath the cortical layer, a bacteroid tissue of the same nature as that in the tubercles of many other Papilionaceæ.

* Journ. Linn. Soc. (Bot.), xxviii. (1891) pp. 244-7 (1 fig.).

† Tom. cit., pp. 217-43 (11 figs.).

‡ Weinbau u. Weinhandel, viii. (1890) pp. 178-9 (1 fig.). See Bot. Centralbl., xlv. (1891) p. 362.

§ Flora, lxxiv. (1891) pp. 125-39 (1 pl.).

Root-nodules of the Pea.*—Herr A. Prazmowski gives a *résumé* of the numerous observations on this subject by different observers, and details of fresh experiments of his own. He regards the structures as truly symbiotic, since it is only plants provided with these nodules that can acquire nitrogen from the free nitrogen of the atmosphere, by the intervention of the nodule-bacteria. The plant can derive benefit from the symbiosis only after it has overpowered the bacteria, the resorption of the products of the bacteria being the main cause of the increased vigour of the plant from that time. Starch is present in the nodules in considerable quantity, and is directly taken up by the bacteria.

Structure of swollen Roots in certain Umbelliferae.†—According to M. G. de Lamarlière, the adventitious swollen roots of *Ænanthe* present a somewhat abnormal structure. The author has studied these, together with the swollen roots of species of *Carum*, *Cicuta*, and *Sium*, and found a series of transitions between the abnormal *Ænanthe* and the normal lateral roots of other species of the same family, and concludes by stating that the abnormality of *Ænanthe* and *Carum* is rather apparent than real.

β. Physiology.

Hansen's Vegetable Physiology.‡—Dr. A. Hansen publishes a complete text-book of vegetable physiology, intended especially for the instruction of non-scientific readers. The subject of metabolism is treated in especial detail. With regard to the conduction of water, the author declares himself an adherent of Sachs's theory of imbibition.

(1) Reproduction and Germination.

Sexual Nuclei in Plants.§—M. L. Guignard points out that the number of chromatic segments in the nuclei of the embryo is exactly that in either the male or female nuclei respectively. There must, therefore, at some period in the course of development, be a reduction of one-half in the number of chromatic segments; and he sets himself to discover at what period this reduction takes place. From observations made on *Lilium Martagon*, with which those on other plants also agree, M. Guignard finds that the reduction takes place suddenly, and always at the same stage, in both male and female organs, viz. at the moment of the first binary division of the pollen-mother-cell and of the embryo-sac. A similar phenomenon is stated by Hertwig to occur in the animal kingdom, in the course of development of the spermatozoa of *Ascaris megalocephala*.

Formation of Endosperm in the Embryo-sac of Gymnosperms.||—Mdlle. C. Sokolowa describes in detail the mode of formation of the endosperm within the embryo-sac of some Gymnosperms, especially *Pinus*, *Juniperus*, and *Ephedra*. Her observations agree, in general, with

* Landw. Versuchs-Stat., xxxvii. pp. 161-238, and xxxviii. pp. 5-62. See Journ. Chem. Soc., 1891, Abstr. p. 607. Cf. this Journal, 1890, p. 59.

† Comptes Rendus, cxii. (1891) pp. 1020-1.

‡ 'Pflanzen-Physiologie,' Stuttgart, 1890, 8vo, 314 pp. See Bot. Centralbl., xlvi. (1891) p. 196.

§ Comptes Rendus, cxii. (1891) pp. 1074-6. Cf. this Journal, 1890, p. 358.

|| Bull. Soc. Imp. Nat. Moscou, 1890 (1891) pp. 446-97 (3 pls. and 10 figs.).

those of Strasburger. At an early stage the parietal protoplasmic layer of the embryo-sac contains a single layer of lenticular nuclei which are connected together by a number of radiating strands of protoplasm. Between the nuclei, and in the midst of the radiating strands, are the cell-plates, i. e. plates composed of isolated granules of protoplasm. When the formation of endosperm begins these cell-plates are transformed directly into the cellulose-membranes which eventually divide the parietal layer of nuclei into a number of polygonal cells. The process is somewhat intermediate between that of ordinary cell-division and that known as free-cell-formation. While this process is taking place the embryo-sac of Gymnosperms is a free cell with rounded outline, sufficiently large to be visible to the naked eye. By the gradual increase of the parietal layer, the embryo-sac eventually becomes completely filled up by a compact tissue of remarkable regularity, the cells of which are mostly elongated greatly in the radial direction. In smaller details four different types are described, represented by *Cephalotaxus*, the *Cupressinæ*, *Taxus*, and *Ephedra*.

The appearance of the cell-plates above described coincides with the fragmentation of the large and dense elements of the chromatin into fine granules. The authoress agrees with Frommann and Heuser, but differs in this respect from Strasburger, in asserting that the filaments of the nuclei in the parietal layer are intimately united with those of the surrounding protoplasm, forming, with them, a continuous net-work. The substance of which the cell-plates are composed consists of granules, the denser and larger of which are coloured by methyl-green with the same intensity as the nucleoles and other denser elements of the nucleus. The number of primary cells of the endosperm usually corresponds to that of the original parietal nuclei of the embryo-sac, and it appears certain that these are the essential factors in the cell-formation which takes place within the sac.

It is a group of short cells belonging to the parietal layer which ultimately develop into the corpuscles or secondary embryo-sacs; and, in the tendency, in *Pinus* and *Cephalotaxus*, towards the early differentiation of these cells, the authoress sees the foreshadowing of the process which is universal in Angiosperms, the formation of the embryonic vesicles before that of the endosperm. *Ephedra* exhibits a still closer approximation in this respect to Angiosperms.

Relations between Insects and Flowers.*—Mr. T. Meehan epitomizes his arguments in favour of the view that too much stress is laid by botanists of the Darwinian school on the part played by insects in the pollination of flowers. He affirms that flowers do not abhor "own-pollen," and that no flowers are so truly fertile as the cleistogamous, while those which fertilize before the corolla expands are also certainly fertile. Plants wholly dependent on insects for fertilization are all perennials; and an innumerable number of the flowers of these plants fall unfertilized. All annuals, on the other hand, though in some cases so arranged that cross-fertilization may occur, can self-fertilize when cross-fertilization fails; and in almost all cases annuals have every flower fertile.

* Bot. Gazette, xvi. (1891) pp. 176-7.

Fertilization of Papilionaceæ.*—Herr E. Loew describes the mode of pollination in two species of Papilionaceæ that are cross-pollinated by the agency of Lepidoptera.

In *Oxytropis pilosa* the process is aided by the union of the alæ and carina into a cone-like body; the visiting insects are chiefly *Eucera longicornis* and *Osmia aurulenta*.

In *Apios tuberosa* from North America, the structure is different, and does not favour the usual process in Papilionaceæ,—the pollination of the under side of the body of the visiting insect by the pressing of both stigma and anthers out of the trough formed by the carina. Self-pollination is in this instance prevented by the remote position of the anthers and stigma from one another caused by the remarkable coiling of the style.

Lepidopterophilous Flowers.†—Herr A. G. Kellgren enumerates thirty-three species of flowers growing on the Omberg, an isolated mountainous region in Germany chiefly covered with pine-woods, which are pollinated by the agency of lepidoptera. They all belong to the order Leguminosæ.

(2) Nutrition and Growth (including Movements of Fluids).

Physiological Function of Phosphoric Acid.‡—Dr. O. Loew attributes an important function to phosphoric acid in promoting the nutriment of the nucleus and the consequent faculty of growth and division of the cell. Although cells can live and form starch and protoplasm without the presence of phosphoric acid, their power of growth and multiplication is greatly dependent on it. The author regards nuclein, of which the cell-nucleus is composed, as a compound of an albuminoid with phosphoric acid. Experiments on *Spirogyra nitida* and *Weberi* showed that the addition of 0·1 per cent. of potassium phosphate to the nutrient solution in which they were grown, resulted on an average in an increase in the cells to nearly double their normal length, while their diameter was not materially increased. There was no increase in the amount of starch formed, nor in the number of bands of chlorophyll.

Influence of Salt on the Quantity of Starch contained in the Vegetative Organs.§—M. P. Lesage gives the results of numerous experiments made on this point with *Lepidium sativum*. When this plant was watered with a liquid containing 12–15 gr. of salt per litre, starch disappeared completely, but the author also states that the diminution of starch is not proportional to the augmentation of salt.

Transpiration-current.||—Herr T. Bokorny recommends ferric sulphate in a 0·1 per cent. solution as by far the best colouring fluid for following the course of the transpiration-current in plants. By its use he has determined that collenchymatous tissue is one of the paths through which the current passes. By precipitation with potassium

* Flora, lxxiv. (1891) pp. 84–91, 160–71 (2 pls.).

† Bot. Sekt. Naturv. Studentsällsk. Upsala, Dec. 5, 1889. See Bot. Centralbl., xlv. (1891) pp. 317 and 343.

‡ Biol. Centralbl., xi. (1891) pp. 269–81.

§ Comptes Rendus, cxii. (1891) pp. 891–3.

|| Ber. Deutsch. Bot. Gesell., ix. (1891) pp. 2–9.

ferrocyanide, the iron may be perceived to have ascended as much as from 20 to 50 or even 70 cm. in half an hour.

Passive Circulation of Nitrogen in Plants.*—According to M. H. Devaux, the tissues of aquatic plants are not equally permeable to different gases, carbonic acid permeating them much more easily than oxygen. The author draws the following conclusions on the circulation of nitrogen. If nitrogen is found in the internal atmosphere of plants in a larger or smaller proportion than in the external air, the difference is due to the gaseous current produced through the openings. The difference of pressure between the external and internal nitrogen causes constant diffusion, which tends to re-establish equilibrium.

(4) Chemical Changes (including Respiration and Fermentation).

Fermentation of Tobacco.†—Herr E. Suchsland has investigated the chemical changes which take place in tobacco after it has been gathered and packed, and which result in the formation of aromatic and other compounds. He finds them to be of the nature of fermentation, comparable to the lactic, butyric, and acetic fermentations. The cause of this fermentative process is the presence of large numbers of Schizomycetes, belonging to the bacterium-, and in smaller quantities to the micrococcus-forms. They are of two or three different kinds, but their special characteristics are not described.

Nitrification by a Schizomycete.‡—Dr. O. Loew suggests that the oxidization of ammonia caused by the nitrifying Schizomycete *Nitromonas*, is partly complete, as expressed by the equation $2\text{NH}_3 + 3\text{O}_2 = 2\text{NO}_2\text{H} + 2\text{H}_2\text{O}$, partially incomplete, $2\text{NH}_3 + 2\text{O}_2 = 2\text{NO}_2\text{H} + \text{H}_4$; and that the hydrogen thus set free immediately combines with carbon dioxide to form formic aldehyde, according to the equation $\text{CO}_2 + \text{H}_4 = \text{CH}_2\text{O} + \text{H}_2\text{O}$.

γ. General.

African Myrmecophilous Plants.§—Herr K. Schumann describes the species of the African genus *Cuviera* (Rubiaceæ) which furnish abodes for ants, viz.:—*C. physinodes* sp. n., *angolensis*, and *longiflora*; also *Canthium glabriflorum*, belonging to the same natural order, and *Barteria Nigritiana* and *fistulosa*, belonging to the Passifloraceæ. *Cola marsupium* sp. n. (Melastomaceæ) possesses bladders on the leaves similar to those of other myrmecophilous species of the same order; but it can only be placed provisionally in this category, as the author has not been able to detect that the bladders are inhabited by ants.

Atavism of Plants.||—Baron d'Ettingshausen and Prof. Krasan again call attention to the phenomena of polymorphism, and especially of heterophylly in the Cupulifere, as an example of atavism. A polymorphic species, such as frequently occurs in that order, is a collection of forms, some of which are successive, others contemporaneous.

* Journ. de Bot. (Morot), v. (1891) pp. 130-2.

† Ber. Deutsch. Bot. Gesell., ix. (1891) pp. 79-81.

‡ Bot. Ver. München, April 20, 1891. See Bot. Centralbl., xlv. (1891) p. 222.

§ Ber. Deutsch. Bot. Gesell., ix. (1891) pp. 54-72. Cf. this Journal, ante, p. 73.

|| Arch. Sci. Phys. et Nat., xxv. (1891) pp. 257-74. Cf. this Journal, 1890, p. 635.

B. CRYPTOGRAMIA.

Cryptogamia Vascularia.

Phylogeny of Ferns.*—Returning to the subject of the relative antiquity of the leptosporangiate and eusporangiate ferns, Prof. F. O. Bower now abandons his previous view, and adopts rather that of Campbell.† He discusses the points which have been relied on as showing an affinity between the Hymenophyllaceæ and Mosses, viz. :—The filmy character of the leaf, the filamentous prothallium, the projecting sexual organs, the presence of a single well-defined apical cell, and the reputed absence of roots in some filmy ferns; and shows that none of them can be regarded as trustworthy evidence of genetic affinity. On the other hand, the fact that the leptosporangiate ferns are the only known leptosporangiate Vascular Cryptogams is some indication of their later origin, a view strongly supported by the facts of palæophytology; the Marattiaceæ attained a great preponderance in the Carboniferous period compared to their frequency at the present time.

Prof. Bower is disposed to trace an affinity between the eusporangiate ferns and the Hepaticæ, the sporophyte of the fern corresponding to the sporogone of the liverwort, and the isolated archesporial cells of the former to the united archesporium of the latter. The Cycadæ have probably sprung from some forms allied to our modern Marattiaceæ and Ophioglossaceæ, the Coniferæ from some forms allied to Lycopodiaceæ.

Apical Growth of the Prothallium of Ferns.‡—Prof. D. H. Campbell describes the mode of growth of the prothallium of *Onoclea sensibilis*, *O. Struthiopteris*, *Osmunda cinnamomea*, and some Polypodiaceæ, and points out its identity, in all essential features, with that of the Hepaticæ, especially in *Metzgeria*, *Aneura*, and the Anthocerotæ, as well as in the Marchantiaceæ and Ricciaceæ. This consists essentially in growth from a single two-sided apical cell, from the sides of which two rows of segments are cut off by parallel walls. From these facts he argues the genetic derivation of Filices from Hepaticæ, the Osmundaceæ and Marattiaceæ being probably the primitive forms of the former.

Muscineæ.

British Mosses.§—Rev. H. G. Jameson publishes a complete key for determining British mosses; the first part giving the distinguishing characters of the genera, the second part the distinguishing characters of the species in all those genera which include more than a single British species.

Apical Growth of Hepaticæ.||—From observations on several species of thalloid Hepaticæ, especially *Marchantia polymorpha*, Mr. D. M. Mottier has come to the conclusion that the apical growth takes place not, as usually supposed, from several, but originally from a single apical cell.

* Ann. of Bot., v. (1891) pp. 109-34 (1 pl.). Cf. this Journal, 1890, p. 66.

† Cf. this Journal, 1890, p. 637.

‡ Bull. Torrey Bot. Club, xviii. (1891) pp. 73-80 (1 pl.).

§ Journ. of Bot., xxix. (1891) pp. 33-45, 132-42, 196-206 (1 pl.).

|| Bot. Gazette, xvi. (1891) pp. 141-3 (1 pl.). Cf. *supra*, Prof. Campbell.

Algæ.

Continuity of Protoplasm in Algæ.*—Herr F. G. Kohl has detected continuity of the protoplasm from cell to cell in *Spirogyra*. The connection is of two kinds, one of which is transitory, the other permanent. The pores in the septa through which the threads of protoplasm pass exist from the time when the membrane is first formed. The staining reagent with which the best results were obtained was tannin-anilin.

Mr. B. M. Davis † describes the same phenomenon in the cells of the filament of the *Chantransia*-form of a species of *Batrachospermum*. The best staining reagent is, according to him, an alcoholic solution of eosin, after the application of which the filament is first washed with water, and the cell-contents then shrunk by dilute glycerin.

Histology of *Polysiphonia fastigiata*.‡—Mr. R. J. Harvey-Gibson describes several features in the structure of this sea-weed, epiphytic on *Ascophyllum nodosum*. The protoplasm both of the central and of the pericentral cells are in complete communication when in a young condition; but the author believes that this is not maintained in older conditions. The tetraspores appear to be formed by a process of ordinary but incomplete division of the contents of an apical cell. They have special cell-walls while still within the mother-cell. Between the central and the pericentral cells well-marked intercellular spaces occur, which have a distinct lining of their own. The attachment of the epiphyte to its host is very intimate. Root-filaments given off from the base of the frond penetrate deeply into the tissue of the host, and wander amongst the cortical cells and medullary hyphæ; these filaments have very thick cell-walls.

Sporange of *Rhodocorton*.§—Mr. R. J. Harvey-Gibson describes the tetrasporanges of *Rhodocorton Rothii* and *floridulum*, the tetraspores being formed in them as quadrants, not as tetrahedra. After the formation of the first sporange a series of fresh ones are sometimes produced by a method of innovation, which is simply an extension of the mode of renewed growth of the vegetative filaments.

Caloglossa *Leprieurii*.||—Prof. C. Cramer describes the vegetative structure and the reproductive organs of this sea-weed. The tetraspores are formed in mother-cells, which are metamorphosed superficial cells, and escape through oval or fissure-like openings. These mother-cells are situated on each side of the row of cells which subsequently becomes the mid-rib of the leaf, and are distinguished from the first by a special mode of growth and of division, in consequence of which they become much larger than the sterile marginal cells. Antherids appear to be of very rare occurrence; they are situated, like the tetraspores, in a double row on each side of the mid-rib of the leaf.

Antherids of *Lomentaria*.¶—Mr. H. J. Webber describes the antherids of *Lomentaria uncinata*, which are usually found at the ends

* Ber. Deutsch. Bot. Gesell., ix. (1891) pp. 9-17 (1 pl.).

† Bot. Gazette, xvi. (1891) p. 149 (1 fig.).

‡ Journ. of Bot., xxix. (1891) pp. 129-32 (1 pl.).

§ Journ. Linn. Soc. (Bot.), xxviii. (1891) pp. 201-5 (1 pl.).

|| 'Ueb. Caloglossa Leprieurii,' Zurich, 1891, fol., 18 pp. and 3 pls.

¶ Ann. of Bot., v. (1891) pp. 226-7 (2 figs.).

of the branches of the frond, forming little spherical heads. The male plant does not differ, in general appearance or manner of growth, from the tetrasporic or sterile plant; and in one instance, antherids and tetraspores were found on the same plant.

Cystocarp of *Callophyllis*.*—From observations made on *Callophyllis laciniata*, Miss A. L. Smith concludes that the cystocarp is a compound body, and includes the products of a number of procarps. The carpogone, with its trichogyne, is borne upon one of the smaller cells of the medullary tissue, which lies alongside a larger auxiliary cell. After the trichogyne has forced its way between the cortical cells, and fertilized the carpogone, fusion takes place between the carpogone and the auxiliary cells. The procarps in each cystocarp are sometimes separated from each other by a mass of tissue, sometimes crowded together in immediate contact.

New Freshwater Florideæ.†—Herr G. Karsten describes a freshwater alga from Amboyna belonging to the Florideæ, and to the hitherto entirely marine genus *Delesseria*. The frond is of a reddish-brown colour, only a single layer of cells thick except at the mid-rib, 2–3 mm. broad, and constricted at intervals of 8–10 mm. into narrowly elliptical segments; at these points of constriction numerous rhizoids grow which fix the alga to various substrata. The growing point is always recurved, and growth takes place by means of a single apical cell, from which successive segments are cut off by transverse septa. No organs of reproduction were observed. It is named *D. amboinensis*.

Chantransia, Lemanea, and Batrachospermum.‡—Mr. G. Murray and Miss E. S. Barton describe, under the name *Chantransia Boweri*, a new species found growing on *Lemanea fluviatilis* in Scotland. Not only were monospores found, but also antherids, trichogynes, and cystocarps. The cystocarps form corymbose stalked clusters of carpospores, and resemble those of *C. corymbifera*.

The authors dispute the conclusion of Atkinson § that *Lemanea* has itself a *Chantransia*-form, the form so described being, they believe, a protonemal form bearing a close resemblance to *Chantransia*; and they also throw very considerable doubt on Sirodot's well-known view that the freshwater species of the so-called genus *Chantransia* are but a special form of *Batrachospermum*. They claim to have established a freshwater group of species of *Chantransia*, consisting of *C. Boweri* and *investiens*, and corresponding to the suppressed genus *Balbiana*, which, in all generic points, resembles the marine species *C. corymbifera*.

Classification of Fucoideæ.||—Dr. J. B. De Toni proposes an arrangement of the genera of Fucoideæ (comprising the Cyclosporinæ or Fucaeæ, the Tetrasporinæ or Dictyotaceæ, and the Phæozosporinæ or Phæosporeæ) into families. The Cyclosporinæ are divided into the Durvillæaceæ, Himanthaliaceæ, Fucaeæ, Cystosciraceæ, and Sargassaceæ.

* Journ. Linn. Soc. (Bot.), xxviii. (1891) pp. 205–8 (1 pl.).

† Bot. Ztg., xli. (1891) pp. 265–71 (1 pl.).

‡ Journ. Linn. Soc. (Bot.), xxviii. (1891) pp. 209–16 (2 pls.).

§ Cf. this Journal, 1890, p. 641.

|| Flora, lxxiv. (1891) pp. 171–82; and Ber. Deutsch. Bot. Gesell., ix. (1891) pp. 129–30.

The Tetrasporinæ comprise the Dictyotaceæ only. The very numerous genera of Phæozoosporinæ are distributed among the following families:—Cutleriaceæ, Lithodermataceæ, Ralfsiaceæ, Sporochneæ, Arthrocladiaceæ, Laminariaceæ, Spermatochnaceæ, Stilophoraceæ, Chordariaceæ, Elachistaceæ, Desmarestiaceæ, Myriotrichiaceæ, Dictyosiphonaceæ, Striariaceæ, Enceliaceæ, Sphacelariaceæ, Ectocarpaceæ, Phæothamniaceæ, Phæocapsaceæ, and Tilopteridaceæ. The genera *Nodaria* and *Thorea* are not placed; and *Actinema* is excluded.

Phæosporeæ.*—Prof. T. Johnson makes the following observations on various species of Phæosporeæ:—In *Carpomitra Cabreræ* and *Sporochmus pedunculatus*, the mode of growth of the thallus is trichothallic, the apices of the branches being occupied by tufts of innumerable hairs with basal growth. The sporanges are unilocular and multisporeous. The receptacle is the modified apex of a branch of the thallus. The zoospores of *S. pedunculatus* are sensitive to light. In *Asperococcus* plantlets arise on the thallus by trichothallic growth, from hairs with basal growth, in a mode which shows an affinity with *Punctaria* rather than with the Sporochneæ. In *Arthrocladia villosa* the sporanges are unilocular and multisporeous, and form stalked chain-like sori. *Desmarestia ligulata* has unilocular sporanges containing from 1 to 4 spores, and morphologically equivalent to any cell of the thallus. In the mode of growth of the thallus, and in the contents of the sporanges, *Desmarestia* shows a close affinity to the Tilopteridæ.

Dictyotaceæ.†—From observations made chiefly on *Dictyopteris polypodioides*, Prof. T. Johnson regards the Dictyotaceæ as forming a family of the Phæophyceæ. In the possession of tetrasporanges it does not differ essentially from the Tilopteridæ, where the non-sexual non-motile spores are quadrinucleate. The contents of the antherids have hitherto been described as non-motile pollinoids, but the author thinks they are probably ciliated antherozoids resembling those of the Cutleriaceæ and Fucaceæ. In the brown pigment and in the presence of isolated scattered oogones in *Dictyopteris* and *Spatoglossum*, the Dictyotaceæ also present characters which belong to the Phæophyceæ rather than to the Floridæ. The family to which they are probably most nearly allied is the Tilopteridæ.

Spirogyra.‡—Mr. G. Mann finds that when *Spirogyra nitida* and *jugalis* grow at a great depth, the filaments present some differences from those growing in shallow water. The filaments are from 2·5 to 3 feet long, and are divided into an apical, a shaft, and a foot-portion, the cells of which present certain differences. Crystals are of common occurrence in the filaments, composed probably of calcium oxalate.

Ctenocladus.§—Reviewing his description of this genus, Prof. A. Borzi removes it from the Chætophoraceæ to another section of the Ulotrichiaceæ, mainly on account of the structure of the cells, which are cylindrical and arranged in filaments branching in one direction only, the single chromatophore being in the form of a parietal plate placed

* Ann. of Bot., v. (1891) pp. 135-44 (1 pl.).

† Journ. Linn. Soc. (Bot.), xxvii. (1891) pp. 463-70 (1 pl.).

‡ Trans. and Proc. Bot. Soc. Edinb., xviii. (1889-90) pp. 421-31 (8 figs.).

§ La Nuova Notarisia, 1891, pp. 385-7. Cf. this Journal, 1884, p. 103.

longitudinally on one side of the cell with a central pyrenoid surrounded by an amyloiferous envelope. He divides the Ulotrichiaceæ into three sub-families, viz. :—(1) CHÆTOPHOREÆ, filaments branching, branches ending in a hyaline hair (*Stigeoclonium*, *Draparwaldia*, *Chætophora*, &c.); (2) CTENOCLAD[IT]IÆ, filaments branching, not piliferous (*Ctenocladus*, *Chlorotylum*, *Chloroconium*, g. n.); (3) ULOTRICHIEÆ, filaments not branching nor piliferous, rarely acuminate (*Hormiscia*, *Ulothrix*, *Uronema*). The new genus *Chloroconium* is thus characterized,—Ramuli alterni, omnes aut saltem fructiferi repentes, ad apicem fructiferi; zoosporæ ciliis binis. It includes *Chlorotylum coriaceum* Borz., *Cladophora compacta* A. Br., and three new species.

Leptosira and Microthamnion.*—On similar grounds to those mentioned in the preceding paragraph, Prof. A. Borzì now considers the genus *Leptosira* as belonging to the Chroolepidaceæ rather than to the Ulotrichiaceæ. The cells are of a very light green colour, with a single broad parietal chromatophore, which often clothes the cavity on all sides. In the possession of a single chromatophore and in other characters it agrees closely with *Microthamnion*, and the author proposes to classify the genera of Chroolepidaceæ in three subfamilies as follows:—(1) CHROOLEPIDEÆ, branches entirely free, each cell containing several chromatophores (*Trentepohlia*, *Trichophilus*, *Gongrosira*, *Acroblaste*); (2) PHYCOPELTEÆ, branches, or at least the fructiferous ones, frequently coalescing laterally, and forming a broad disc-like thallus attached to the substratum, each cell with several chromatophores (*Phycopeltis*, *Hansgirgia*); (3) MICROTHAMNIEÆ, branches erect, free, each cell with a single chromatophore (*Microthamnion*, *Leptosira*).

Cell-sap of Valonia.†—Herr A. Meyer has examined the chemical composition of the cell-sap of *Valonia utricularis*. He finds the residue on evaporation to amount to 3·244 per cent., or somewhat less than that of sea-water. Of this, about 0·238 is organic. In the relative proportion of the inorganic salts, the most noticeable differences from the composition of sea-water are the much larger proportion of potassium chloride, the much smaller proportion of sodium chloride, and the entire absence of calcium salts and of bromides.

Structure and Reproduction of Chlamydomonas.‡—Prof. Gorschankin has confirmed his observations published many years since (in Russian) on the mode of reproduction of *Chlamydomonas Braunii* Gor. (*C. pulvisculus* Dang. non Ehrb.).

This species multiplies rapidly, under favourable circumstances, in the ordinary non-sexual manner. The non-sexual individuals are provided with a perceptible membrane, and always with two flagella of about equal length with the body; the chromatophore has the form of a cup, at one end of which lies the massive pyrenoid; the “eye-spot” has the form of a long slender rod; and non-sexual propagation takes place in quite the ordinary way; but the sexual mode of reproduction is of a very unusual character, owing to the conjugating individuals being furnished with a membrane. The larger female individuals containing

* La Nuova Notarisia, 1891, pp. 387–91.

† Ber. Deutsch. Bot. Gesell., ix. (1891) pp. 77–9.

‡ Bull. Soc. Imp. Nat. Moscou, 1890 (1891) pp. 498–520 (2 pls.).

the oosphere may be termed *megagametes* (macrogametes), the much smaller male individuals *microgametes*. Both kinds arise, after many non-sexual generations, the former by division of the non-sexual cells into two or four, the latter by division into four or eight. The former vary between 20 and 29 μ , the latter between 9 and 15 μ in size; both closely resemble the non-sexual individuals, but are somewhat more elliptical, and possess a distinct double membrane. Conjugation was never observed between gametes of the same kind. A mega- and microgamete unite by their narrower ends, and continue in motion for a considerable time, often more than an hour; they then lose their flagella and come to rest. While still in motion, the contents of the male cell begin to move towards its anterior portion, and gradually pass over entirely into the anterior portion of the female cell through a canal which connects the two with one another. The protoplasts and the two nuclei unite completely, but not the pyrenoids and chromatophores. The product of conjugation becomes rounded off and excretes a coat of cellulose. The author compares this process of conjugation to that which takes place in the Zygnemaceæ. The gradual coalescence of the two nuclei can be easily followed in a hanging drop, even without the use of staining-reagents. A cellulose-reaction was in a few cases observed in the membrane of the gametes. The zygotes are usually enveloped in a brownish granular mucilaginous substance. Their contents break up into two, and eventually into four or eight, non-sexual flagellated individuals.

Chlamydomonas Braunii has also a palmella-condition, which can be readily cultivated in a moist chamber, and is then indistinguishable from colonies of *Pleurococcus* or *Gleocystis*; from these the non-sexual flagellated individuals are again developed.

Hariotina.*—Prof. A. Borzi identifies Dangeard's *Hariotina reticulata* with *Cælastrum verrucosum* (Reinsch) De Toni. It consists of colonies of four, eight, or sixteen spherical cells; each cell has a chromatophore in the form of a parietal plate inclosing a pyrenoid. It is propagated by zoospores, from sixteen to thirty-two being formed in each cell, in the same way as those of *Hydrodictyon* and *Pediastrum*.

Fungi.

Nucleus of the Oomycetes during Fecundation.†—M. P. Dangeard has investigated the appearance of the nuclei of the sexual elements in cellular Cryptogams, and particularly in Fungi. He points out that with care two cases can be distinguished, the one in which the sexual elements are uninucleated, and the other where they are plurinucleated. An example of the first is afforded by *Basidiobolus ranarum*, in which simple fusion takes place, analogous to the fecundation of the Conjugatæ and Chlamydomonadineæ, among Algæ. The second case, however, is much more common among Fungi, in which the vegetative and reproductive cells are plurinucleated. The nuclei of the oospheres can be easily observed until the time of communication with the antherids; but they then disappear, and either assist in the formation of the oosperm

* La Nuova Notarisia, 1891, pp. 382-4. Cf. this Journal, 1890, p. 489.

† Rev. Mycol., xiii. (1891) pp. 53-5.

and of the oleaginous globule, or the new character of the protoplasm hides them from the observer. A little later several nuclei are to be found in the protoplasm between the oleaginous globule and the membrane.

Hemiasci and Ascomycetes.*—From an investigation of the history of development of a very large number of Basidiomycetes and Ascomycetes, Dr. O. Brefeld has arrived at the conclusion that there is a much closer affinity between these two groups than has generally been supposed, the sole constant distinction between the two being the formation of spores within asci in the latter. The examination of 400 species of Ascomycetes has led him to the conclusion that the so-called pollinode (antherid) and carpogone, as well as the trichogyne, of lichens, are not true sexual organs, and that the so-called spermata (pollinoids) are simply very small conids, which can be made to germinate. The only reproductive organs in the Ascomycetes are non-sexual spores, conids, chlamydospores, and ascospores. The ascus is derived from the many-spored sporange of the lower alga-like fungi, just as the basid is from a one-spored sporangiophore. There is, however, a sharp distinction to be drawn between the true Ascomycetes (Exoasci and Carpoasci) and the *Hemiasci* (*Ascoidea*, *Thelebolus*, *Protomyces*).

The author then proceeds to describe the experiments by which he succeeded in causing the "spermata" of the true Ascomycetes to germinate. Among the Pyrenomycetes this occurred in *Ophionectria scolecospora* sp. n., *Polystigma*, and in many Trichosphæriaceæ, especially in the stromatic Sphæriaceæ, as in numerous species of *Xylaria* and *Hypoxyton*. Similar results were obtained with *Hysterium pulicare* (Hysteriaceæ) and with many Discomycetes.

The conids which are so characteristic of Fungi are regarded by Dr. Brefeld as having been acquired when the algal ancestors of the Fungi took to a terrestrial mode of life and became Fungi; they are derived from one-spored sporanges in which the formation of the endogenous spore has been suppressed. Asci and basids have a common origin in the sporanges of the lower Fungi.

The fructification of the Hemiasci approaches that of the Phycomycetes, while the vegetative condition agrees more closely with that of the typical Ascomycetes. The new genus and species *Ascoidea rubescens* is described, as is the development of *Protomyces* and *Thelebolus*.

Among true Ascomycetes, the Exoasci include only the genera *Endomyces*, *Taphrina*, and *Exoascus*, and the new genus and species *Ascocorticium albidum*. The development of *Endomyces* is described in detail. The author regards the Saccharomycetes not as Ascomycetes, but as a stage in the development of some higher form of Fungi which cannot at present be determined.

Intoxicating Rye.†—M. E. Prillieux describes the phenomena attending the eating of bread made from a certain sample of rye, in a

* 'Unters. aus d. Gesamtgebiete d. Mykologie,' Heft 9; Münster, 1891, 156 pp. and 4 pls. See Bot. Centralbl., xlv. (1891) pp. 321 and 350. Cf. this Journal, 1890, p. 368.

† Bull. Soc. Bot. France, xxxviii. (1891) pp. 205-8; and Comptes Rendus, cxii. (1891) pp. 894-6.

country village in France, both on men and other animals. They resembled intoxication rather than the effects of ergot. M. Prillieux found these results to be caused by a fungus, the mycele of which attacks the seed of the rye; it resembles *Dendrochium*, but differs from that genus in the spores being produced in the interior of the branches. He names the fungus *Endoconidium temulentum* g. et sp. n., with the following diagnosis of the genus:—Sporodochia pulvinata albida, sporophoris hyalinis ramosis; conidia hyalina rotundata, in interiore ramulorum subinde generata et mox ex apice exsiliencia.

Assimilation in Lichens.*—M. H. Jumelle distinguishes three series of lichens in relation to their powers of assimilation. The first includes those in which the thallus is well developed and green or greenish (ex. *Peltigera canina*, *Physcia ciliaris*, &c.), the assimilation being particularly active. In the second series the thallus is still well developed, but is of various tints (ex. *Umbilicaria pustulata*, *Parmelia caperata*); the process of assimilation is here still evident. Finally, we have the crustaceous lichens (ex. *Lecanora hæmatostoma*, *Lecidea superans*), in which assimilation is feeble. The conclusion is thus arrived at that all lichens are able, when the conditions are favourable, to decompose carbonic acid gas, gaining carbon thereby.

Dependence of Lichens on their Substratum.†—Herr A. Zahlbruckner points out the difference between the lichens which inhabit siliceous primary and those which inhabit calcareous rocks. As a general rule also, different species of lichens are found on the different primary rocks—granite, gneiss, quartz, basalt, serpentine, &c.; and the same is true of chalk and limestone. The first of these two groups of lichens is characterized in general by bright colour, the second by various shades of grey and yellow.

Lichens of the Mulberry.‡—According to M. G. Hallauer, the corpuscles which cause *pébrine* in the silkworm are masses of the “antherozoids” (pollinoids) of the lichens which infest the mulberry-tree. When these lichens grow on the leaves they are harmless to the tree itself; but when they cover the branches or trunk, they are exceedingly prejudicial to the next crop of leaves.

Structure of Uredinæ.§—Herr P. Dietel has investigated several points in connection with the Uredinæ, especially the structure of the spore-membrane and the nature of the colouring matter of the spores.

In many teleutospores the membrane consists, when mature, of three layers. From the history of their development, and from the behaviour of the different layers with nitric acid, the author shows that the outermost only must be regarded as exospore, both the inner layers belonging to the endospore, which arises as an excretion from the cell-contents. The germ-pores, which appear like bright spots on the membrane, perforate, in most species of *Phragmidium*, only the inner layer of the endospore; in many species of *Puccinia*, where there is

* Comptes Rendus, cxii. (1891) pp. 888-91.

† Mittheil. Sect. f. Naturkunde d. Oesterr. Touristen Club, ii., pp. 81-3. See Bot. Centralbl., xlvi. (1891) p. 229.

‡ Comptes Rendus, cxii. (1891) pp. 1280-3.

§ Flora, lxxiv. (1891) pp. 140-59 (1 pl.).

only a single germ-pore, it perforates the whole thickness of the endospore. In many species of *Puccinia* the endospore consists of only a single layer. In *Coleosporium* each spore is invested by only a single membrane, and is usually divided by septa into four cells. According to the author's view, the teleutospores of *Coleosporium* are equivalent, strictly speaking, to basids or promyces. In *Chrysomyxa*, also, the spores have only a single membrane.

Most uredospores have also a distinctly recognizable exospore and endospore, the latter, again, often consisting of two layers. Those of *Coleosporium* and *Chrysomyxa* have, however, a very abnormal structure, and the author regards them as in no way equivalent to the urediforms of the Uredineæ, but as representing the æcidium-generation. The elevations which frequently occur on the surface of spores belong sometimes entirely to the exospore, sometimes also partly to the endospore.

Two kinds of pigment are found in the membranes of uredospores and teleutospores—one soluble, the other insoluble in water. The latter occurs in all brown membranes of uredospores, and in the brown paraphyses of many species; the former in the membrane of teleutospores, rarely in that of uredospores. The soluble pigment is found only in those species the teleutospores of which are firmly attached to the host-plant.

Puccinia parasitic on Saxifragaceæ.*—Herr P. Dietel identifies *Puccinia Saxifragæ*, parasitic on *Saxifraga granulata* and *carpathica*, with the *fragilipes* form of *P. Chrysosplenii*, parasitic on *Chrysosplenium alternifolium* and *oppositifolium*, the *persistens* form of this species being suppressed. He also identifies *P. pallido-maculata*, parasitic on *Saxifraga punctata* in Colorado, with *P. Adoxæ*, parasitic on *Adoxa* both in that State and in Europe, and founds on this fact an argument for placing *Adoxa* among the Saxifragaceæ, rather than among the Caprifoliaceæ or Araliaceæ.

New Uredineæ.†—Herr P. Magnus describes two new species of Uredineæ:—*Diorchidium Steudneri*, parasitic on *Ormocarpum bibracteum* (Leguminosæ) from Abyssinia, and *Cœoma circumvallatum* on *Geum heterocarpum* from Armenia; the latter is characterized by the sterigmas being surrounded by a wall of paraphyses.

In another communication † the same author makes *Triphragmium Acaciæ* the type of a new genus *Sphærophragmium*, characterized by the teleutospores consisting of from four to nine cells, which are not arranged in a row, as in *Phragmidium*, but form a spherical or ellipsoidal body.

Himalayan Uredineæ.§—After describing a new species of *Puccinia*, *P. (Cœoma) Smilacis*, parasitic on *Smilax aspera*, the late Dr. A. Barclay discusses the characters of the alleged genus *Cœoma*, and sees no good ground for separating it from *Æcidium*.

In another memoir the same author describes a teleutospore-, a uredo-, and an æcidio-form of *Puccinia*, all parasitic on different species

* Ber. Deutsch. Bot. Gesell., ix. (1891) pp. 35-45 (1 pl.).

† Tom. cit., pp. 91-100 (1 pl. and 1 fig.). ‡ Tom. cit., pp. 118-24 (1 pl.).

§ Scient. Mem. by Med. Officers of the Army of India, pt. vi. (1891) 5 pp. and 1 pl., and 4 pp. and 2 pls. Cf. this Journal, ante, p. 231.

of *Rhododendron* in the Himalayas. Whether these three forms are genetically related to one another cannot at present be decided.

Entomophytic Cladosporiæ.*—M. A. Giard classifies the entomophytic Fungi under four heads:—(1) The Laboulbeniaceæ, whose attachment to the host is simply a superficial one; (2) the Entomophthoræ, which are entomophagous, and fatal to the infected insect; (3) the Hypocreaceæ and imperfect forms (Isariæ), which attack living insects, but are also capable of living on their dead bodies or on artificial media; (4) the Entomophytic Cladosporiæ, which kill the insect, not by the destruction of its tissues, but by closing up the tracheæ. Of this last group M. Giard cites five examples:—*Cladosporium parasiticum*, parasitic on *Polyphylla fullo*; *Penomyces telarium* (*Entomophthora telaria*), infesting *Ragonycha melaneura*, or less often the hemipterous *Phygadeuon Urticæ*; *Penomyces cantharidum* sp. n., parasitic on *Telephorus lividus* and *Ragonycha testacea*; *Polyrhizum Leptophyei*, parasitic on an orthopteron, *Leptophyes punctatissima*; and *Lachnidium Acridiorum* g. et sp. n. (*vide infra*), the fungus which is so destructive to the migratory locust in Algeria. It presents itself under two forms, a *Cladosporium*- and a *Fusarium*-form.

Parasite of the Cockchafer.†—MM. E. Prillieux and Delacroix have examined the parasitic fungus which has recently been very destructive to the larva of the cockchafer in certain districts of France, and find it to be a *Botrytis*, very nearly allied to the *B. bassiana* which causes the muscardine of the silkworm, and describe it as *B. tenella*. An *Isaria* was once found, probably the conidial form of *Melanospora parasitica*, but this was parasitic on the *Botrytis*, and not pathogenic to the larva. The *Botrytis* was found to be very readily cultivatable on potato and sweet juices.

M. Le Moutt ‡ describes the ravages committed by the parasite on the cockchafer larva, and recommends its culture for the purpose of destroying that agricultural pest.

M. A. Giard,§ in reference to this subject, considers the forms *Botrytis* and *Isaria* as stages in the evolution of Ascomycetous Fungi, only a few of which are at present known in the ascogenous form. When the conidiferous hyphæ are united into long thick tufts, more or less regularly club-shaped, they come under the denomination of *Isaria* (or *Stilbum*); when these hyphæ form a kind of veil, covering the substratum, they constitute a *Botrytis*. Some species may occur in both forms. Thus the *Botrytis bassiana* of the silkworm, cultivated on the larva of *Gastropacha Rubi*, gives rise to an *Isaria*; while the *Isaria farinosa* of the latter larva may develop into *Cordyceps militaris*. The parasite of the cockchafer is rather an *Isaria* than a *Botrytis*.

Parasite of *Acridium peregrinum*.||—M. L. Trabut describes a parasitic fungus which is extremely destructive to this locust in certain districts of N. Africa. It has the appearance of a white efflorescence, the filaments of the mycele producing great numbers of spores, and forming white spots on the rings of the abdomen. The author regards

* Comptes Rendus, cxii. (1891) pp. 1518-21.

† Tom. cit., pp. 1081-3.

‡ Tom. cit., pp. 1383-4.

† Tom. cit., pp. 1079-81.

§ Tom. cit., pp. 1270-3.

it as a *Botrytis*, and describes it as a new species under the name *Botrytis Acridiorum*.

M. C. Brongniart * has further examined the parasite, and finds that it produces spores of two kinds. He has cultivated the fungus successfully, and believes that it may be found a very useful check on the spread of the grasshopper.

Hypogæi of Germany. †—Dr. R. Hesse publishes a monograph of the German species of Hymenogastreæ, Elaphomycetes, and Tubercaceæ, numbering about forty species, of which about thirty are not at present known elsewhere. They are found most abundantly on ground covered with trees, some species being parasitic on their roots.

Basidiomycete parasitic on Grapes. ‡—MM. P. Viala and G. Boyer describe a basidiomycete parasitical on the grape, belonging to the group Hypochneæ; and the authors create for it a new genus *Aureobasidium*, the characters being founded on the filamentous hymenium, the arrangement of the basids, and the form, coloration, and variation in the number of the spores. The malady develops during wet years, especially in the months of September and October, when the grapes are nearly ripe, and the first appearance of *A. Vitis* is in the form of small dull spots.

Protophyta.

a. Schizophyceæ.

Dictyosphærium, Botryococcus, and Porphyridium. §—Prof. A. Borzi publishes a contribution to our knowledge of the structure of *Dictyosphærium Ehrenbergianum*. The characteristic gelatinous colonies originate from special spherical cells, which, inclosed in thin amorphous gelatin, form small colonies of the type of *Palmella*. These colonies become rapidly disintegrated, and the cells, when isolated, undergo a process of rapid vegetative multiplication, the division taking place in two directions only. In this way the reniform cells which bear a close resemblance to *Nephrocytium* are formed. The colonies subsequently become spheroidal by division in three directions. Each of these then divides by two successive bipartitions into four portions, connected together by a slight basal attachment. This attachment subsequently divides into four pieces, each of which becomes a kind of stalk to one of the four young colonies. The chromatophore of the cell of *Dictyosphærium* is not parietal, but central, and contains a polygonal pyrenoid. The author regards the above details as showing an affinity between *Dictyosphærium*, *Schizochlamys*, and *Tetraspora*, which constitutes the family Prasiolacæ. ||

Botryococcus Braunii the author regards as probably a stage of development of *Mischococcus confervicola* while *B. terricola* Klebs appears to belong to an entirely distinct genus.

Experiments on the cultivation of *Porphyridium cruentum* were not

* Comptes Rendus, cxii. (1891) pp. 1494-6.

† 'Die Hypogæen Deutschlands,' Lief. i. and ii., 4to, 32 pp. and 4 pls. See Bot. Centralbl., xlv. (1891) p. 228. Cf. this Journal, ante, p. 230.

‡ Comptes Rendus, cxii. (1891) pp. 1148-50.

§ La Nuova Notarisia, ii. (1891) pp. 367-82. || Cf. this Journal, 1889, p. 793.

decisive on the question of the genetic connection of this organism with *Pleurococcus vulgaris*.

Dictyosphærium.*—Mr. G. Masee has followed out the life-history of *Dictyosphærium Ehrenbergianum*. In its earliest stage it cannot be distinguished from a small specimen of *Pleurococcus vulgaris*. After considerably increasing in size the spherical cell divides simultaneously into four equal parts. The mucilaginous portion of the mother-cell-wall does not divide along with the chlorophyllous portion, but continues to increase in quantity, and envelopes the segments in a continuous hyaline stratum. The segments of the mother-cell eventually become spherical, and still remain attached by their central stalk-like portions, which are hollow, the contents of the minute cavity being sometimes coloured green; the cavity subsequently becomes completely obliterated. Each of the four segments again divides into four by a double bipartition; and this process may again be repeated once or twice. The contents of each final division escape as a zoospore, provided with two very long and slender cilia.

Movements of Diatoms.—Mr. C. Onderdonk † finds that several species of *Pinnularia* and one of *Nitzschia*, when in active motion, are at once arrested by a delicate application of methyl-anilin-green; this stains blue a mantle of protoplasm, which it raises up from the surface of the frustule, and shows, by the varying depths of colour, that it is folded and wrinkled; the contents of the diatom itself are stained green. He concludes from this that the motions of diatoms are due to an excessively thin external coating of protoplasm, which is probably not more than 0·00002 in. in thickness, and in a state of perpetual pulsation as long as the cell is in a living state.

Mr. R. W. Haskins, ‡ on the other hand, believes, from observations on a species of *Nitzschia*, that the motion is due to the action of very minute cilia.

β. Schizomycetes.

Classification of Bacteria.§—Sig. Al. Messea suggests that the presence or absence of cilia in Bacteria may afford a basis for classification, and gives the following scheme:—I. Gymnobacteria; II. Trichobacteria. 1, Monotricha; 2, Lophotricha; 3, Amphitricha; 4, Peritricha. The Monotricha possess a flagellum at each pole, e. g. *B. pyocyaneus*. Lophotricha are characterized by a tuft of flagella at one pole, e. g. *Bacillus* of blue milk. The Amphitricha have one cilium at each pole (*Spirillum volutans*). The Peritricha have flagella all round (*Bacillus proteus vulgaris*, *B. typhosus*).

Plasmolysis in Bacteria.||—Plasmolysis, says Herr A. Fischer, is that phenomenon occurring in the protoplasm of vegetable cells under the influence of substances having affinity for water, such as saline

* Journ. Linn. Soc. (Bot.), xxvii. (1891) pp. 457-62 (1 pl.).

† The Microscope, x. (1890) pp. 225-30.

‡ Com. cit., pp. 272-3.

§ Rivista d' Igiene e Sanità pubblica, i., No. 14. See Centralbl. f. Bakteriol. u. Parasitenk., ix. (1891) pp. 106-7.

|| Berichte üb. d. Verhandlungen Sächs. Gesell. Wiss. zu Leipzig, i. (1891) pp. 52-74 (1 pl.).

solutions, &c. Under these circumstances, the protoplasm which has hitherto been spread throughout the cell and lined quite completely the cell-wall, becomes contracted, assuming various shapes and positions.

Several examples of this inspissated condition of cell-plasma are depicted in his illustrations; such are the appearance of the cholera nostras bacillus, typhoid bacillus, *Bacterium termo*, *Clostridium butyricum*, *Bacillus neapolitanus*, *Leptothrix buccalis*, and *Spirogyra*. In the bacilli, the plasma, acted on by salt-solution, is gathered up as polar bodies at one or both ends of the cell; if at both, then the polar bodies may be joined by a narrow filament of inspissated plasma.

Quite similar effects, but with different arrangement of the plasmolysed cell-contents, are easily seen in *Spirogyra*. The plasmolytic condition is easily induced by any substance which will withdraw water from the cell-protoplasm, but the most convenient medium appears to be sodium chloride in solutions of 1/2 to 10 per cent., 1/2 to 2 per cent. being the strength most usually adopted.

Plasmolysis also occurs in disease conditions, and in cultivations; examples of the former case are *Streptothrix* disease of rabbits, and actinomycosis.

The condition of plasmolysis artificially induced by means of reagents is not without its practical value, for it enables the observer to determine whether the cells be still alive, viable indeed, since only living protoplasm is susceptible of this change.

The author concludes by discussing the views of Ernst and Bütschli on the nature of protoplasm and the nucleus of cells in particular.

Symbiosis of Rhizobium and Leguminosæ.*—In an exhaustive treatise, Herr B. Frank sums up the present state of our knowledge of this subject, and adds some new observations.

The symbiotic organism he regards as a Schizomycete, *Rhizobium Leguminosarum*, common to all the Leguminosæ. He has isolated and cultivated it in hanging drops. In a period varying from 1 to 5 days there appear in the drop actively motile swimmers which originate from the bacteroids in the tubercle. The coccus-like contents of these bacteroids develop into the swimmers which become free and motile after the absorption of the bacteroids. They are of roundish form, from 0.9 to 1.3 μ in diameter, while the bacteroids are from 3 to 5.5 μ long, the microbes lying in the latter usually in one row. Non-motile bacteria also occur. No cilia could be detected. A zoogloea-form was also observed. The bacteroids are therefore neither purely protoplasmic structures (Brunchorst) nor pure bacteria (Prazmowski), but a combination of the two, a *mycoplasm*. The author regards the microbe to be a parasite in *Phaseolus*, and the formation of tubercles to be of no use to the host. In most other Leguminosæ, on the contrary, the relationship of the microbe to the host is a symbiotic one, enabling the latter to obtain normal development under unfavourable conditions of growth, in soil containing but little humus. He finds the *Rhizobium* not only in the root-tubercles, but also in the aerial organs of the infected plants.

* Landwirthsch. Jahrb., xix. pp. 523 *et seq.* (12 pls.). See Bot. Centralbl., xlv. (1891) p. 242. Cf. this Journal, 1890, p. 372.

Microbe of the Tubercles of Leguminosæ.*—According to M. E. Laurent the bacteroids of the tubercles of Leguminosæ are not endowed with any power of motion except a brownian movement. They differ from true bacteria in multiplying, not by transverse division but by a kind of dichotomous budding which produces structures of the characteristic T or Y shape. This resembles the mode of multiplication described by Metschnikoff in *Pasteuria ramosa*, a parasite on *Daphnis*; and M. Laurent proposes to unite these into a new group PASTEURIACEÆ, intermediate between true bacteria and the lower filamentous fungi.

Colouring-matter of certain Schizomycetes.†—Following up his observations on the occurrence of a true lipochrome in certain Bacteriaceæ—*Micrococcus rhodochrous*, *M. Erythromyxa*, and *Bacterium Chryso-gloia*—Herr W. Zopf states that the oily colouring-matter is excreted by the organism when in a living condition. There is, however, a notable distinction between the red pigment of the first two, and the yellow pigment of the last; while the former forms well-defined crystals, the crystalline character of the latter is very obscure. Herr Zopf proposes to remove *Micrococcus rhodochrous* and *Erythromyxa* from the subgenus *Staphylococcus*, and to found on them a new subgenus of *Micrococcus*, which he proposes to call *Rhodococcus*.

A Red-Pigment-forming Organism.‡—Mr. C. Slater gives with a query the name of *B. corallinus* to a red-pigment-forming organism which differs from any of those already known. It occurred as a coral-red, slow-growing, circular, non-liquefactive colony on a gelatin plate, and was probably due to an air-contamination. The colony consisted of short, thick bacilli, with very rounded ends; their breadth was almost constantly $1\ \mu$, and the average length from 2 to $3\ \mu$. The organism has a rolling, recurving motion, with, generally, but slow motion of translation. The most noticeable characteristic is the highly refringent nature of the poles of the cells; growth occurs easily on gelatin-peptone; the organism is distinctly aerobic. The optimum temperature for growth is between 20° and 23° . The pigment is largely contained in the cells and is not an excretion; it cannot be extracted till first liberated by the disruption of the cells by boiling; it then dissolves easily in alcohol and chloroform, though not in ether. No absorption-bands were detected. Pigment is produced in darkness as well as in diffused light. Growth by fission was observed. A comparative table is given to show the differences exhibited by six pigment-producing bacteria.

Phosphorescent Bacteria.§—Dr. O. Katz communicates at considerable length an account of the six species of light-developing bacteria previously described by him in the Transactions of the Linnean Society N.S.W.¶ Except to remark that the micro-organisms referred to are now discussed in greater detail the present paper does not demand further notice.

* Comptes Rendus, xvi. (1890) pp. 754-6. Cf. this Journal, 1890, p. 372.

† Ber. Deutsch. Bot. Gesell., ix. (1891) pp. 22-8 (1 fig.). Cf. this Journal, 1889, p. 560.

‡ Quart. Journ. Micr. Sci., xxxii. (1891) pp. 409-16 (1 pl.).

§ Centralbl. f. Bakteriol. u. Parasitenk., ix. (1891) Nos. 5-10.

¶ See this Journal, 1888, p. 101.

Eubacillus, a new Genus of Bacteriaceæ.*—M. P. A. Dangeard describes a fresh-water Alga which, though green, forms endogenous spores like the Bacteriaceæ. The alga, which is designated *Eubacillus*, consists of long slender filaments matted together; these do not present septa or ramifications, and their hyaline contents have a greenish tinge. The formation of spores imparts to this alga its specific characters. These spores are from six to eight μ long and about three μ broad.

The mode of sporulation is similar to that observed by L. Klein in five species which are referred by this latter to the genus *Bacillus*. Herein the spores are formed by a condensation, so to speak, of the protoplasm, this by its contraction separates from the wall of the filament, and after becoming more and more refracting, finally surrounds itself with a membrane.

Phragmidiothrix and Leptothrix.†—Dr. A. Hansgiring identifies the following species of Schizomycetes:—*Beggiatoa multiseptata* Eng., *Phragmidiothrix multiseptata* Eng., *Crenothrix marina* Hansg., and *Beggiatoa fetida* Fior.-Mazz., and all these probably with *Leucothrix Mucor* Oerst., in which case the name to be retained will be *Crenothrix Mucor* (Oerst.) Hansg. He divides the genus *Crenothrix* into two sections,—*Phragmidiothrix*, which includes the single species above named, which is marine, and *Eucrenothrix*, which is freshwater, and comprises the single species *C. Kuhniana* (Rbh.) Giard, including *C. polyspora* Cohn with its synonyms.

Bacteria in the Colonies of Puccinia Hieracii.‡—Sig. G. Caboni has observed that the spots on the leaves of *Leontodon hastilis* caused by the attacks of this fungus are infested with enormous quantities of bacteria which move about actively within the stalks of both the teleuto-spores and the uredospores. They were detected only when the spots had shown themselves for some time.

Bacillus malarie.§—Dr. B. Schiavuzzi confirms the results of the investigation on malaria by Klebs and Tommasi-Crudeli, who detected the presence of a bacillus in malarious districts. The author, however, not only identifies the micro-organism with which he has been working as that described by Klebs and Tommasi-Crudeli, but he has been able to make cultivations thereof, and so carry out some satisfactory infection experiments with animals.

From his experiments the author concludes that the principal habitat of the bacillus of malaria is the air; that it is rarely found in water, especially if it have a good fall; that the districts it thrives best in are those where the soil is damp, but not covered with water; and that as the temperature of the air and soil increase, so do its germs multiply.

Practically, of course, the author's paper is an attempt to prove that the Plasmodium malarie is not the cause of malaria.

Bacteria of Influenza.||—Dr. F. Fischel records the isolation of two micro-organisms from the blood of persons suffering from influenza.

* Comptes Rendus, cxii. (1891) pp. 251-3. † Bot. Ztg., xli. (1891) pp. 313-5.

‡ Nuov. Giorn. Bot. Ital., xxxviii. (1891) p. 296.

§ Beitr. z. Biol. der Pflanzen (Cohn), v. (1890) pp. 245-88 (1 pl.).

|| Zeitschr. f. Heilkunde, xii., 1891. See Centralbl. f. Bakteriell. u. Parasitenk., ix. (1891) pp. 611-15.

The blood was taken from the forearm with the usual precautions, and cultivated in the media commonly in use. Micro-organism i. consists of cocci $\cdot 75$ - $\cdot 5 \mu$ in diameter; these are frequently paired, but also are found singly or in chains. They were not decolorized by Gram's method. Inoculation experiments on animals (rabbits, dogs, horses, fowls) failed to show any pathogenic property, the absence of which is ascribed by the author to loss of vitality, during the residence of the microbe in the animal body.

Micro-organism ii. is also a coccus, of $1-1\cdot 25 \mu$ in diameter. Injection into animals was followed by rise of temperature and catarrhal conjunctivitis. In some dogs balanitis was observed.

One horse died after injection of 40 ccm. of a bouillon cultivation, the most prominent features being jaundice, fever, and conjunctivitis; the most important post-mortem appearance, lobular consolidations of the lung. From this lung, cultivations of a coccus resembling micro-organism ii. were obtained. In another horse injected with 100 ccm. of bouillon, the symptoms were fever, conjunctivitis, exudation into anterior chamber of eye, marked weakness of posterior extremities, and hebetude. The symptoms passed away in about a week.

From a comparison of the results of these experiments on animals with the clinical picture of "Hundestaube" the author concludes that the morbid appearances produced by intravenous injection of micro-organism ii. are comparable to those of the catarrhal form of "Staube" and that this view receives further confirmation from the occasional participation of the intestinal, preputial, and nasal mucosae.

The author is inclined to think that these two diseases may be identical, and it is pointed out that this view receives further support from the fact that *Bacillus pneumoniae* Friedlaender and *Streptococcus pyogenes* thrive better in bouillon which has been used for cultivating micro-organism ii. than in fresh bouillon.

Bacteria of Swine Diseases.*—Dr. G. Caneva, after an examination of the bacteria found in certain diseases affecting pigs and other animals, classifies these micro-organisms under three principal categories. The micro-organisms dealt with are the bacteria of hæmorrhagic septicæmia (Hueppe), hog-cholera (Salmon), swine-plague (Billings), swine-pest (Selander), American cattle-plague (Billings), Büffelseuche (Oreste-Armanni), Marseilles Schweinseuche (Jobert, Rietsche), Fretchen-seuche (Eberth). All the organisms have some few characteristics in common; they do not liquefy gelatin, do not form endospores, are not stained by Gram's method, but when aqueous methylen-blue solution is used the pigment accumulates in greater or less quantity at both poles. On the other hand, these microbes present, in addition to obvious morphological differences, special characteristics which permit their division into three distinct classes.

The first group comprises bacteria producing symptoms of hæmorrhagic septicæmia. These are non-mobile, do not thrive luxuriantly on gelatin; do not grow at all on potato; do not produce any special changes in milk, are found both in the blood-vessels and scattered diffusely throughout the tissues.

In the second group, which includes Marseilles pig-disease, swine-

* Centrabl. f. Bakteriol. u. Parasitenk., ix. (1891) pp. 557-61.

plague, American cattle-plague, and "Fretchenseuche," these are fairly mobile, grow on gelatin like typhoid bacillus, thrive luxuriantly on gelatin, coagulate milk with formation of acid, form capillary emboli, but are not scattered about in the tissues.

In the third group are included hog-cholera and swine-plague. The characteristics of these are lively movements; luxuriant growth on gelatin, but not resembling that of typhoid bacillus; growth on potato luxuriant, and resembles that of typhoid; peptonizes milk, without previous coagulation; small capillary emboli only; not scattered throughout the tissues.

Diplococcus resembling Gonococcus.*—Sig. F. Vincentini narrates a case of cancer of the bladder, in which he found a microbe resembling in all respects the micrococcus of gonorrhœa. The coccus described by the author is identical in form, size, and appearance with the micrococcus of blennorrhagia described by Cornil, Babes, and others. The record is interesting, since a very similar case has been recorded by Bockhart, and it helps to throw doubt on the specific value of the gonococcus.

Micro-organisms found on ripe Grapes and their Development during Fermentation.†—M. V. Martinand and M. M. Rietsch record the results of their examination as to the nature and number of the micro-organisms found on grapes grown in different parts of France. Their method was to place a grape in a test-tube containing a sterilized sugary liquid. Some of the fermented fluid was afterwards tested by means of plate cultivations. In the result it was found that the microbes capable of developing in acid media (and these are the only ones which are interesting in regard to wine-making) are present on the surface of grapes in very variable numbers. The moulds and *S. apiculatus* are much more frequent than *S. ellipsoideus*. Acid-making bacilli and Mycodermis are not rare. The spontaneous fermentation of grapes is usually brought about in the first twenty-four hours by *S. apiculatus* and this subsequently gives way to *S. ellipsoideus* but without disappearing altogether.

Bacteria and Mycodermis are met with not only at the outset of fermentation, but even in the lees, a fact which indicates that it is quite possible that the cause of the deterioration of wine is to be sought for in the skin of the grape rather than in some after-contamination by the air or vessels.

Races of Bacillus pyocyaneus.‡—M. Gessard who had already found that the production of pigment by *Bacillus pyocyaneus* depends directly on the quality of the medium, has now shown that this production depends on certain attributes in the microbe.

By thirty-four sub-cultivations which took more than a year, a variety was obtained, which formed pyocyanin in bouillon. Another variety was developed by heating a normal cultivation for five minutes to 57°. This one only produced green fluorescing pigment in bouillon. By heating the first mentioned variety a third race was produced, which had lost all power of producing pigment. All these races could be reconverted into the original stock by cultivating in pepton-glycerin-agar.

* Atti d. Accad. Med. Chi. di Napoli, xliii. (1889) 29 pp.

† Comptes Rendus, cxii. (1891) pp. 736-8.

‡ Annales de l'Institut Pasteur, 1891, p. 65. See Centralbl. f. Bakteriol. u. Parasitenk., ix. (1891) pp. 541-2.

Similar varieties with partial or complete loss of their chromogenic function, could be obtained by passage through the animal body.

The conclusion, which is obvious, arrived at by the author from his experiments, is that the results of a species of microbe depend on the nutrient medium, and if the medium remain the same, on the races which that species is in condition of forming.

New Micrococcus of Bitter Milk.*—Mr. H. W. Conn describes a coccus which he has isolated from bitter milk. Its most prominent characteristics are the following. Grown on gelatin, it betrays little or no tendency to chain formation, although on agar chains consisting of four or more individuals are quite common. The organism is of pretty fair size, non-mobile, aerobic, and liquefies gelatin with the formation of gas. It grows well on agar, potato, bouillon, and in milk. The latter medium is rendered bitter, and at a temperature of 35° C. is coagulated. The coagulation is probably due to a soluble enzyme, but the author failed to isolate the ferment.

The most remarkable effect of this micro-organism is the viscosity and ropiness it induces in gelatin and bouillon when cultivated therein. Strings 3 m. long and not thicker than a silk thread may be drawn out from these culture media, but it is noteworthy that this phenomenon is not observed when the coccus is cultivated in milk.

From the organism described by Weismann, which is also causative of bitter milk, the author's coccus differs in the fact that it produces butyric acid.

Germicidal Properties of Milk.†—Herr A. P. Fokker finds that if fresh goat's milk be placed in sterilized vessels and then boiled for some minutes it coagulates in 24 hours after having been inoculated with a minute quantity of *B. acidi lactici*, but if unboiled it does not do so for two to four days. By investigations with plate cultivations and counting the colonies, it was shown that, as with blood, there is at first a diminution (even to abolition) and afterwards an increase of the fungi. When heated for only a short time, the germicidal faculty was not always destroyed.

M. Ed. de Freudenreich,‡ in describing his experiments on milk, draws attention to the difficulty there is in obtaining it in perfectly sterile condition. Only sometimes, even after taking the greatest precautions, were the tubes perfectly free from germs. The most simple way is after having carefully cleansed the udder, to milk straight away into sterilized test-tubes, and this was the method most frequently adopted. But another procedure, and one which from *a priori* considerations ought to have yielded better results, was also tried. This was by means of a system of glass and caoutchouc tubes so arranged as to connect the sterilized udder with the receiving flask in such a way that there should be no contamination from the air. Some few quite sterile tubes of milk were thus procured, but on the whole we gather that the simpler method was not only less cumbersome but more successful.

The micro-organisms employed in the experiments were the cholera bacillus, the typhoid bacillus, the *Bacillus Schafferi*, and an oval micro-

* Centralbl. f. Bakteriol. u. Parasitenk., ix. (1891) pp. 653-5.

† Op. cit., vii. (1890) p. 648.

‡ Annales de Microgr., iii. (1891) pp. 415-33.

coccus often found by the author in milk. The procedure adopted was the usual one, viz. first to wait to see if the milk in the tubes was quite sterile, and then having inoculated them with different micro-organisms to incubate the tubes at 37°.

The results of the action of these microbes in cow's and goat's milk are then given in a series of tables, the first two of which deal with fresh milk drawn in sterilized tubes. The diminution was most notable in the case of the cholera vibrio and the typhoid bacillus, the other two being more resistant. If the milk were inoculated with a large quantity of the poison the germicidal action would seem to be in great measure overpowered. Again, if milk be heated, the germicidal action is diminished or lost, hence pasteurization or heating milk to kill off contaminating germs to 68°-69° for 20 minutes is detrimental to this vital phenomenon.

The bactericidal power was found to reside almost entirely in the serum or skim milk, the cream having almost no deleterious action.

The author concludes with some speculations on the nature of the bactericidal substance or essence, and gives reasons for preferring to regard it in the light of a ferment, insoluble perhaps, rather than as a something having a certain chemical reaction, and possessing properties in virtue of this alkaline or acid reaction.

Antitoxic Power of the Animal Organism.*—M. Gamaleia records the results of experiments with *Vibrio Metschnikovi*. The author had previously shown that animals naturally insensitive to the infection of the vibrio (e. g. rabbits) are also insensitive to the toxin produced by the vibrio. The present experiments were directed to ascertain if possible on what this insensibility depended. He collected the urine of rabbits which had been injected with large quantities of sterilized cultivations of the vibrio, and sought, but in vain, for some evidence of the toxin. He then supposed that perhaps the tissues of the insensitive animals possessed the property of destroying the toxin. To prove this hypothesis he rubbed the inoculation fluid with the spleen just removed from a living rabbit. This mixture was placed in an incubator at 37°, filtered and inoculated in mice and guinea-pigs. Inoculations showed that the mixture had lost its toxic action. It was also found that this antitoxic action was possessed not only by the spleen, but also, though in a less degree, by the blood-serum of rabbits. Hence it follows that the living tissues of insensitive animals are endowed with the capacity of destroying the vibrio toxin.

With sensitive animals the antitoxic action does not increase, for the author found that in guinea-pigs, after protective inoculations against *V. Metschnikovi* and cholera vibrio, their power of resistance to the soluble products of these micro-organisms does not increase, while on the other hand their power of destroying the microbes augments. From this the author concludes that there exists a certain antagonism between the antiseptic and the antitoxic properties of these animals.

Isomeric Lactic Acids as criteria diagnostic of certain species of Bacteria.†—M. Nencki after alluding to the discovery of a micro-

* La Semaine Méd., 1890, No. 56. See Centralbl. f. Bakteriol. u. Parasitenk., ix. (1891) pp. 452-3. † Centralbl. f. Bakteriol. u. Parasitenk., ix. (1891) pp. 304-6.

coccus (*M. acidi paralactici*) which fermented grape-sugar, but the principal product of which was not optically inactive, but turned polarized light to the right, states that from the human intestine he has isolated no less than six microbes capable of fermenting sugar, and three of these form optically active acids. Now Schardinger has isolated from water a short bacterium which decomposes cane sugar and dextrose with the formation of lactic acid, having all the chemical properties of paralactic acid and forming salts with the same composition, e. g. the zinc salt crystallizes with two molecules of H_2O , and the calcium salt with four and a half molecules. On the other hand the acid and its salts behave differently from ordinary paralactic acid to polarized light, for while the latter turns the plane to the right and its salts to the left, Schardinger's acid turns the plane to the left and its salts to the right.

Since most of the potential and essential anaerobes which decompose carbohydrates form varying quantities of lactic acid, it becomes necessary in bacterio-chemical investigations to determine not only that lactic acid is produced, but to ascertain whether this acid be optically inactive or whether it turns the plane to the right or the left. The author relates how he isolated from the human intestine a bacterium closely resembling *B. coli commune*. But while the latter forms from glucose a dextro-lactic acid, the former (*B. Bischleri*) is optically inactive. There is no doubt that the observations of the author are extremely interesting, but we cannot follow him further into the details of the procedure pursued in his laboratory for the study of the decomposition products of the carbohydrates affected by bacteria. For this the original must be consulted.

Eisenberg's Bacteriological Diagnosis.* — The third edition of Eisenberg's Bacteriological Diagnosis has recently appeared. The whole work has been completely revised and much enlarged. Two hundred new species are described, and these are divided into three great groups:— (1) Non-pathogenic Bacteria; (2) Pathogenic Bacteria; (3) Fungi. In Group 1 are included micrococci, bacilli, and spirilla, and these are further subdivided into those which liquefy gelatin and those which do not, and also into two other classes according as they do or do not produce pigment. Still smaller groups are arranged in alphabetical order.

Of the pathogenic bacteria the author makes four great divisions:— (1) Those specifically pathogenic to man; (2) those specifically pathogenic to animals; (3) those pathogenic to animals, but which are found in man; (4) those pathogenic to animals, but which have diverse origin. This group as well as the fungi are, like Group 1, further subdivided alphabetically. The author also gives another system by classifying them according to their local origin, e. g. from water, air, skin, sputum, &c., and then again indicating that these may be further separated into pathogenic and non-pathogenic bacteria and fungi.

* Eisenberg's 'Bacteriological Diagnosis, with Appendix on Technique,' 3rd edition, Voss, Hamburg and Leipzig, 1891, p. 509. See *Centr. bl. f. Bakteriologie u. Parasitenk.*, ix. (1891) pp. 677-8.

- BARBIER, H.—Du sang dans la défense de l'organisme contre les infections. (Blood as a defence of the organism against infection.)
Gaz. Méd. de Paris, 1891, Nos 3-7, pp. 25-6, 37-40, 49-51, 61-3, 73-8.
- BAUM, JOHN.—Zur Morphologie und Biologie der Sprosspilze. (Contributions to the Morphology and Biology of Fermentation-fungi.)
Zeitschr. f. Hygiene, X, p. 1.
- CHARRIN, A.—Sur la nature chimique des sécrétions microbiennes. (On the Chemical Nature of the Secretions of Microbes.)
Journ. de Pharm. et Chimie, 1890, p. 255-61.
- DIAGO, J.—Lugar que ocupa la Bacteriologia en la categoria de las ciencias. (On the position of Bacteriology in the category of the Sciences.)
Crón. Med.-quir. de la Habana, 1890, pp. 559-62.
- FAJARNES, E.—Nuevos estudios sobre los hematozoarios del paludismo. (New Studies on the Hæmatozoa of Malaria.)
Rev. de Med. y Ciruj. Práct., Madrid, 1890, pp. 113-5.
- GOLGI, GAMILLO.—Demonstration der Entwicklung der Malaria-parasiten durch Photographien. (Demonstration of the Development of the Parasites of Malaria by Photographs.)
Zeitschr. f. Hygiene, X, p. 136.
- HANKIN, E. H.—Report on the Conflict between the Organism and the Microbe.
Rep. Brit. Med. Assoc., 1891, pp. 89-98.
- HOFFA, A.—Weitere Beiträge zur Kenntniss der Fäulnisbakterien. (Further Contributions to the Knowledge of Putrefaction Bacteria.)
Münch. Medic. Wochenschr., 1891, No. 14, pp. 247-8.
- HOLST, A.—Uebersicht über die Bacteriologie. (Sketch of Bacteriology, translated by O. Reider.)
Basel, Bonacker & Sallman, 1891, large 8vo, 210 pp.
- HUNT, J. S.—The Evolution of Malaria.
Australas. Med. Gaz., 1890-91, pp. 75-8.
- HULLE, L. VAN DEN, & HENRI VAN LAER.—Nouvelles recherches sur les bières bruxelloises à fermentation dite spontanée. (New Researches on the Beers of Brussels with so-called spontaneous fermentation.)
Bruxelles, F. Hayez, 1891.
- IMBER, N. H.—The Bacilli in the Talmud.
Med. Record, 1891, No. 6, pp. 164-5.
- KIRCHNER, M.—Bacteriologische Untersuchungen über Influenza. (Bacteriological Researches on Influenza.)
Zeitschrift f. Hygiene, IX, p. 528.
- POKROFFSKY, D. J.—Ueber den Einfluss einiger Mittel auf die Entwicklung und den Wuchs von *Aspergillus fumigatus*. (On the Influence of some Reagents on the Development and Growth of *Aspergillus fumigatus*.)
Warschauer Univers.-Nachr., 1890, No. 6/7, pp. 374-424 (Russian).
- MONTI, A.—La patologia cellulare e la patologia parassitaria. (Cellular Pathology and Parasitic Pathology.)
Milano, 8vo, 1891.
- OGATA, M. (Tokio).—Ueber die Bakterienfeindliche Substanz des Blutes. (On the substance in blood which is destructive of Bacteria.)
Centrabl. f. Bakteriol., IX, p. 597.
- PARKES, L.—The Relations of Saprophytic to Parasitic Micro-organisms.
Lancet, I, (1891) No. 4, pp. 773-4.
- PODBIELSKIJ, A.—Examen des microbes de la cavité buccale saine chez l'adulte et l'enfant. (Examination of the Microbes of the healthy Buccal Cavity of adults and children.)
Thesis; Kasan, 1890, 124 pp. (Russian).
- ROMANOWSKI, D. S.—Ueber die Struktur der Malariaparasiten. (On the Structure of the Parasites of Malaria.)
Wratsch, 1890, No. 52, pp. 1171-3 (Russian).
- SERAFINI, A., & J. SERATA.—Intorno all'azione dei boschi sui micro-organismi trasportati dei venti. (On the action of Woods on Micro-organisms transported by winds.)
Annali dell' Istituto d' Igiene sperimentale dell' Univ. rsità di Roma, II., series 2, p. 165.
- WORKMAN, C.—Bacteriology: a general review of its progress and its prospects.
Glasgow Med. Journ., 1891, No. 4, pp. 272-80.
- WLADIMIROFF, ALEXANDER.—Biologische Studien an Bakterien. Ueber das Verhalten beweglicher Bakterien in Lösungen von Neutralsalzen. (Biological Studies on Bacteria. On the habits of mobile Bacteria in neutral salt solutions.)
Zeitschr. f. Hygiene, X, p. 59.

MICROSCOPY.

a. Instruments, Accessories, &c.*

(1) Stands.

Johnson & Sons' Advanced Student's Microscope.—At the meeting of the Society in June last,† Mr. T. T. Johnson, of the firm of W. Johnson

FIG. 70.

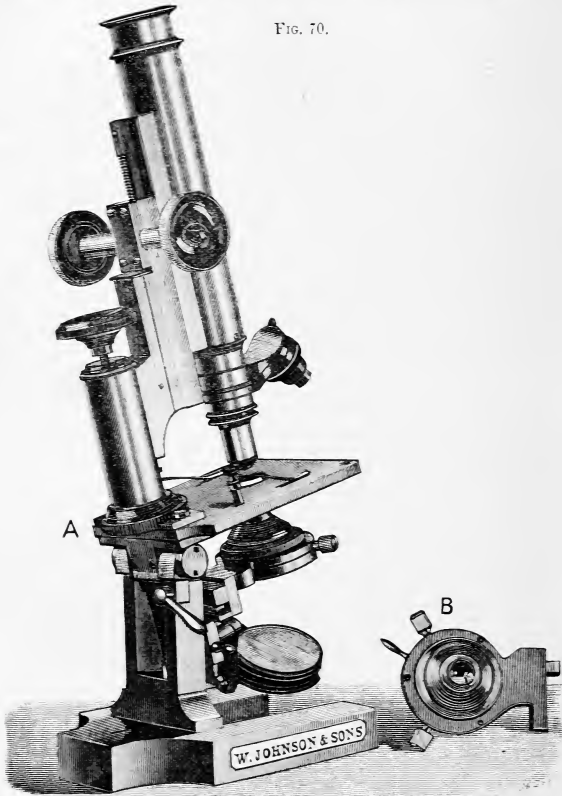

* This subdivision contains (1) Stands; (2) Eye-pieces and Objectives; (3) Illuminating and other Apparatus; (4) Photomicrography; (5) Microscopical Optics and Manipulation; (6) Miscellaneous.

† This Journal, *ante*, p. 556.

& Sons, exhibited and described a new student's Microscope which he had devised.

The late Mr. John Mayall, in introducing it to the President, said the special point was in the application of a screw movement for the substage adjustment. He thought it a very economical and excellent way of applying the focusing arrangement to the substage, and it appeared to him most happily chosen for convenience, and would certainly commend itself to notice. It seemed to him that Messrs. Johnson had undoubtedly "scored 1" by bringing out this screw-focusing arrangement for the substage.

This instrument has been constructed with a view to supply the student in the higher branches of research with a suitable Microscope at a moderate cost. The foot (fig. 70, A) is of the horse-shoe form, and sufficiently weighty to insure steadiness when used in a horizontal position for photomicrography.

The patented screw substage adjustment consists of a screw placed in the axis of the substage and tail-piece, which is actuated by a milled head nut, slightly projecting at A; this being readily at command gives great facility for raising or lowering the substage, and delicately focusing the condenser, &c. The substage carrying an Abbe condenser with iris diaphragm and mechanical centering arrangement is mounted on a substantial tail-piece and slides in dovetailed fittings. The substage with its fittings (when in use) is fixed to the Microscope, and is free from lateral motion; by a simple arrangement of a clamping screw it can be readily removed or replaced (see fig. 70, B) and is, as regards durability, far superior to the pivoting system. The mirror can also be removed for direct lights if required.

The fine-adjustment is on the differential screw principle insuring delicate focusing for high powers, and the coarse-adjustment on the oblique rack-and-pinion system, giving equality and smoothness of motion, the body being supplied with a draw-tube, and marked for English or Continental objectives.

A great advantage is gained by this position of the substage adjusting knob, as in addition to its being readily at command, all liability of tilting the mirror or disarranging any of the under-stage apparatus is avoided, "accidents" which often happen where it is necessary to feel for the adjustment when placed beneath the stage.

A College Microscope.*—Dr. W. H. Seaman observed:—"It may be remembered that in March 1888, *Science* published an article by me, maintaining the excellence of American Microscopes. The train of thought inspired by that article led me to make working drawings of an instrument with some novel features. These were shown to a few friends at Columbus, and were unfortunately lost from my coat-pocket at Buffalo. I did not have time to reproduce them till recently, and hoped to have the instrument itself here, but it is not quite done.

The figure (fig. 71) shows the features which are essential, in my judgment, to a good College Microscope. It will also be well adapted to the average professional man and amateur. A tripod base, rather thin,

* Proc. Amer. Soc. Micr., xii. (1891) pp. 67-8.

single foot back, wide open in front. The pillar may be single or double, but must have thumbscrew at the joint to hold it firm at any desired inclination; the mirror on swinging arm, adapted to carry a condenser if desired, and the stage just high enough to admit a short Abbe condenser; the centre of rotation of the mirror-bar just above the stage. The arm is a box-arm, Jackson model, shown with one side removed. The barrel should

FIG. 71.

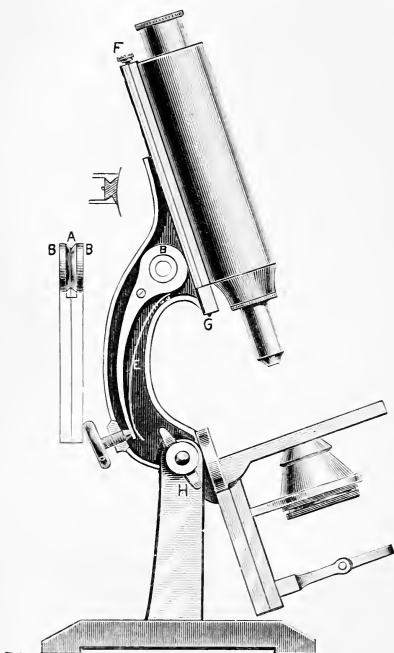

be of the short type and is supported on an X-shaped bar, that slides between the V's on each inside of the box-arm, as shown by detailed section. A steel tape or picture cord is fastened at each end of the X-bar, one end being the tightening screw F. This tape is wound once round the grooved wheel A, which is turned by the usual milled head and gives the coarse-adjustment to the instrument. On each side of the wheel A and on the same axis are two discs B B, that pinch the wheel A between them by a screw and act as a friction clutch. These discs are prolonged downward in the curved bar against which presses the spring E. The micro-meter screw D forces the bar against this spring, and, turning the wheel A by friction, forms the fine-adjustment. Every part of the instrument is adjustable for wear. The stage is a ring, with a plate of glass dropped in it. A Zentmayer sliding holder may be used. The condenser is not shown

in detail, as no special features are claimed for it. I am aware that friction fittings are not new; one was described by Mr. Wenham, vol. vii., Q. J. M.; also a chain movement was made by Pike or Grunow, of New York city, about 1850. Nevertheless, these devices do not appear to me to be as useful as that here described. The steel tape has proved successful in mechanical combinations where racks, &c., have failed, and it may succeed in the Microscope. The micrometer screw D may be replaced by a cam.

A Microscope built on the plan here outlined need not be expensive, and would be capable of all but the highest class of angular work. It may be conveniently used in its simplest form, and is at the same time adapted for the successive addition of those accessories essential to the prosecution of advanced researches with the instrument. Should it prove to answer my expectations I may refer to it again."

(3) Illuminating and other Apparatus.

Altmann's Thermoregulator.*—Herr P. Altmann has devised a very simple instrument for regulating temperatures below 100° C. The instrument works with great precision, not varying more than $\pm 0.05^{\circ}$ C.

From the illustration it is seen to be made in a single piece. D is the reservoir fitted with mercury; this is narrowed above to a capillary tube, which at the side is in connection with a tube fitted with an air-tight iron screw S, which serves to regulate the apparatus for any desired temperature.

The way the instrument works is easily conceived from the illustration. When the reservoir D is heated, the mercury therein expands, and rising, cuts off, in the V tube of A, the stream of gas passing along in the direction B A C and only allows the transit of the small current along B E C. At E is a tap for regulating the supply of gas for keeping the burner just alight, and this is adjustable for any size of flame.

The instrument depends for its sensitiveness and accuracy on the large surface of the reservoir, so that the tube at A is opened or closed with great facility.

Metallic Thermoregulators.†—M. P. Miquel describes two thermoregulators, the action of which is determined by the expansion and contraction of metal bars. The bars, made of zinc, are from 25 to 50 cm. long, and are inserted in porcelain or glass tubes. The tubes are

FIG. 72.

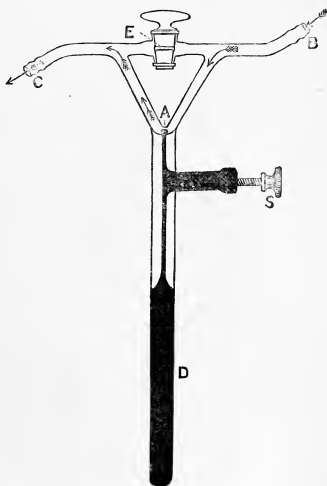

* Centralbl. f. Bakteriol. u. Parasitenk., ix. (1891) pp. 791-2 (1 fig.).

† Annales de Microgr., iii. (1890) pp. 150-8 (2 figs.); iii. (1891) pp. 241-6 (2 figs.) and 363-74 (1 fig.).

immersed in the water-bath, and as the bar lengthens from the increased temperature, its upper end presses directly against a caoutchouc tube, through which the gas passes to the flame. Hence the flame diminishes and consequently the temperature of the thermostat. In the second model the end of the zinc bar is bevelled and its edge made to press against a lever, which is always kept opposed to the bar by means of a spring. The other arm of the lever runs between two caoutchouc tubes, one of which introduces a cooling, the other a heating medium.

The author states that having used these for some years he is able to testify that they work with great efficiency and accuracy, and gives a table recording their diurnal variations, which are certainly small. For the minute details of construction the original must be consulted.

The question of heating media is then discussed and an ingenious method for employing alcohol is described. In this case the alcohol is supplied to the flame through a tube coming from a reservoir fitted with a Mariotte's tube. The tube has an overflow pipe placed at an angle between the flame and the regulator. The regulator placed within the water-bath embraces the caoutchouc tube as it passes from the spirit reservoir to the flame, and so acts that as the bar expands it nips the tube, and thus diminishes the flow to the lamp.

Thermoregulator for large Drying-stoves and Incubators.*—M. Roux recommends the thermoregulator which has been in use at the Pasteur Institute for some years, as being very suitable for large ovens or incubators.

It is made of two metal bars welded together and bent to a U-shape. The inner bar is made of steel and the outer one of zinc. These are massive enough to prevent any springing. The length of the legs of the U are from thirty to forty cm.

The variations in temperature as recorded from the use of the large incubator at the Institute are said never to exceed 0.5° .

Capillary-siphon-dropping Bottle.†—Prof. M. W. Beyerinck says that if the V-shaped tube of a dropping-bottle be made of capillary size it will be found very useful for microscopical purposes. Thus it may be used for distributing small quantities, droplets, of any reagents from the bottle, or for capturing small animals, Infusoria, from a watch-glass, and so on.

Steam-filter.‡—The apparatus devised by Dr. P. G. Unna for filtering agar is a hollow copper sphere, the upper half of which serves as a lid.

In the bottom is a hole, through which passes the stem of an enamelled iron funnel. The top of the funnel projects above the level of the lower hemispherical segment or pan, and the distance between the edge of the funnel and the pan is about 1 cm. The pan is suspended on a tripod, from the ring of which a semicircular band passes over the pan. By means of a screw at the uppermost part of this band the lid is firmly screwed on. In the lid is also a small tap for letting off the

* *Annales de l'Institut Pasteur*, 1891, p. 158. See *Centralbl. f. Bakteriol. u. Parasitenk.*, ix. (1891) p. 737.

† *Centralbl. f. Bakteriol. u. Parasitenk.*, ix. (1891) pp. 589-90 (1 fig.).

‡ *Tom. cit.*, pp. 749-52 (1 fig.).

steam. The apparatus is heated by means of a cylindrical closed pipe, projecting obliquely from the lower pan.

The agar having been cut up is boiled for half an hour on the open fire, and then having been mixed with any desired substances is placed in the funnel. In the funnel is fitted an ordinary filter-paper, filled with siliceous sinter. When the lid is screwed down, and heat applied, the pressure of the steam serves to drive the liquefied agar through the funnel into a flask placed underneath.

The chief advantages of this apparatus are its rapidity,—a litre of 2 per cent. agar can be filtered in two hours, a great economy of gas, simultaneous sterilization and clarification.

(4) Photomicrography.

The Value of using different makes of Dry Plates in Photomicrography.*—Dr. W. C. Borden remarks:—"While the variation in rapidity of different makes of plates is pretty generally understood and taken advantage of in practical work, the variations of plates in contrast and range of tones are not generally discussed in photographic literature, nor are the great benefits to be obtained by taking proper advantage of these variations understood, or generally practised. Hardly a photographic journal appears without either some new formula for a developer, or some new method of working an old one, by which it is claimed that some modification of rapidity or contrast may be produced in the plate on which they are used. Quite a large portion of photographic literature is devoted to giving these means of producing required effects in negatives, and every box of plates contains information (?) how to obtain greater or less rapidity, or contrast, as may be desired; when in fact, after a light has once struck a plate in a particular way, so changing a particular ratio, the molecular structure of the sensitizing chemicals with which it is coated, but little change in result can be produced by any developer, however much that developer may be modified. A modification, however, of the coating of the plate, giving a different chemical basis upon which the light acts, will, from the different arrangement and kind of molecules acted upon, produce a different result whatever developer may be employed. It is in this way that variations in result may be best and most surely obtained, for different makers of plates use sensitizing formulas differing in such manner that the coatings, when acted upon by light and "developed," give results differing in rapidity, contrast, and range of tones. That almost universal advice: "Get a good plate, master its peculiarities, and then use this plate exclusively," is good only so far as getting a good plate and mastering its peculiarities are concerned, for, however well the working of any one plate may be understood, results cannot be obtained from it alone, upon all kinds of objects, equal to those obtainable when different makes of plates are intelligently used, in a manner to make their peculiarities bring out, in the resulting negative, the effect sought for. For instance, if the object to be photographed has but little contrast, and a plate giving great contrast and a short range of half tones be used, a good printing negative will usually be obtained, while, if a plate having

* Amer. Mon. Micr. Journ., xii. (1891) pp. 169-72.

opposite qualities were used, no amount of careful exposure or development would give a negative having sufficient contrast to print properly. Similarly, with an object having great contrasts, a plate giving little contrast and long range of tones, will give a negative in which the contrasts of the object are so lessened that printable details are given in the densest parts, while were a plate having opposite qualities used, the strong contrasts of the object would be so reproduced or exaggerated that a print devoid of all detail could be obtained only. As in photomicrography, owing to the peculiar nature of the objects to be photographed, great difficulties are often encountered, the ingenuity of the operator often being taxed to the utmost, it follows that a proper selection of the plate to be used will add greatly to his resources, and will enable him to obtain results which could not be obtained were only one make of plates used, whatever legerdemain of exposure or development he might practise.

But, in order to take advantage of the different properties of different plates, it is necessary to know exactly how they differ; and this must be determined not by exposing the plates to be compared in a camera where the light may be constantly varying, and where the personal equation of the operator may enter as a disturbing factor, but in a manner by which each shall receive equal treatment. For purposes of comparison I have used a pad of thin white tissue paper (onion skin), 4 in. by $4\frac{1}{2}$ in. in size, made of superimposed pieces of paper, each sheet being 4 in. long, and $\frac{1}{2}$ in. narrower than the next sheet underneath. This pad, when placed on a piece of clear glass in a 4 in. by 5 in. printing frame, and viewed by transmitted light, gives nine gradations of density, from clear glass up. Such a pad answers for all practical purposes, though one $7\frac{1}{2}$ in. long, placed in a 5 in. by 8 in. printing frame, and used with strips cut lengthways from 5 in. by 8 in. plates, will give a longer range of gradations. To test two or more plates, a strip about 1 in. wide and 5 in. long is cut from each, and placed side by side, film side down, on the pad in a 4 in. by 5 in. printing frame. They are then clamped in the frame, exposed for one instant to diffuse daylight, or for a few seconds to lamplight; and are then all developed together in the same developer.

It is best to develop for fully twenty minutes in a covered tray, with a developer containing a rather large quantity of sodium sulphite. If about thirty grains of the granular sulphite is used to each ounce of the developer, yellowing of the films, which might be produced by the prolonged development, will be prevented; and this without any ill effect on the resulting negatives. Development for fully twenty minutes is recommended in order that development be fully completed, i. e. that all the molecules of silver acted upon by light be reduced, for in this way only can the exact properties of all the strips be brought out, inasmuch as some plates develop more rapidly than others, and a stoppage of development before completion will produce erroneous results. The illustration is a reproduction of the result arrived at by comparing a "Harvard" plate, sensitometer 40, with a "Seed" plate, sensitometer 25, in the manner above described (fig. 73). It is a reproduction of the negatives themselves (not a print from them), so the lighter bands represent the thinner bands of the original negatives.

The great difference in the two negatives is seen at a glance. The greater rapidity of "Seed" plate is shown by band 9 in the plate, where the light had to act through but nine thicknesses of paper before acting upon the plate, being equally as dark as band 5 in the "Harvard" where the light had to act through but five thicknesses. The comparative rapidity of the Seed to the Harvard is therefore as nine to five; or for

FIG. 73.

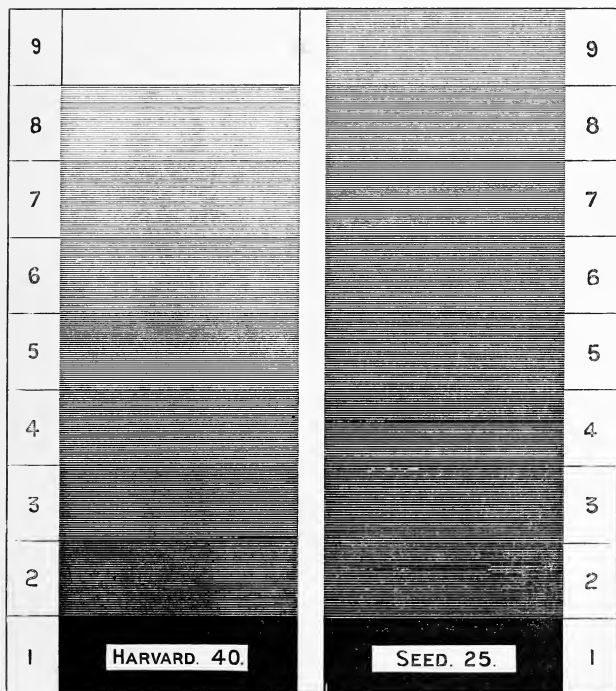

practical purposes it may be considered as double. The greater contrast of the Harvard, and longer range of half tones of the Seed are shown by the same range being gone through in five bands in the Harvard, i. e. from band 1 to 5, that requires nine bands in the Seed, i. e. from band 1 to 9. In other words, a certain gradation of light in an object photo-

graphed, which will give with a Seed plate a certain contrast in the negative, will with a Harvard plate give practically double the contrast.

This comparison shows at once that the Harvard is the better plate to use when objects having little contrast are to be photographed, or when contrast is desired; and the Seed is the better plate when rapidity is desired, when an object having strong contrasts is to be photographed, or when strong contrasts are to be avoided and a "soft" negative desired. Also, that by the intelligent use of these plates, or others having similar qualities, results may be arrived at which could not be obtained by the exclusive use of either alone.

I have called attention to these particular plates, and have used them in illustration, because they have the opposite qualities, by taking advantage of which almost any Microscope object can be successfully photographed. Not but that there are on the market other plates having qualities in every way equal to the plates particularly mentioned. For instance, the "Eagle" plate, sensitometer 40, is an almost exact duplicate of the "Harvard," 40, in both rapidity and relative contrast; and Carbutt's "Keystone," sensitometer 16, is almost identical with the Seed, 25, in all properties except rapidity. All plates having the qualities of the Harvard and Eagle give great contrast and short range of half tones, and are therefore best adapted to objects having but slight contrasts. With such plates satisfactory negatives can be made from such little contrast, that were plates like the Seed, 25, and Keystone, 16, used, negatives having printing contrasts could not be made at all. Conversely, plates like the Seed, 25, and Keystone, 16, low contrast and long range of half tones, will satisfactorily reproduce the details of objects having great density or contrast, which details would be entirely obliterated if plates like the Harvard or Eagle were used. As plates similar in other qualities often vary in rapidity, as is the case with the Seed, 25, and Keystone, 16, this variation can be taken advantage of where the light is more or less strong, or where greater or less rapidity is desired, without in any way affecting the result, so far as the printing qualities of the negative are concerned.

I have, however, never found the most rapid plate too quick, even with low powers and sunlight, as I habitually use a light-filter of a colour complementary to that of the object photographed. For these filters, being generally either yellow, green, or yellowish-green, considerably lengthen the time of exposure; so much so, that while with a Zeiss 2 mm. h. i. apochromatic objective, a projection eye-piece, 4, and an amplification of 1500 diameters, a Seed, 25, plate will require about 35 seconds; a wet collodion plate, using a blue filter, would require but about two seconds.

As the Seed and Harvard plates have opposite qualities, which adapt them to almost every object to be photographed, before using other makes they should be comparatively tested, either with the plates named, or with some plate with the workings of which the operator is familiar, when their actual qualities will be demonstrated and their adaptability ascertained. Only by such testing can the operator know exactly what to expect, or be able to arrive at the best results, for this, like other work connected with microscopy, should never be of a haphazard sort.

The worker in photomicroscopy, who uses plates having opposite qualities as regards density, contrast, and range of tones, and who uses them intelligently, will obtain results which cannot be equalled by the one who uses one make of plates only, or who uses all kinds as may happen, without a knowledge of their properties arrived at by comparative testing."

Marktanner-Turneretscher's 'Die Mikrophotographie als Hilfsmittel Naturwissenschaftlicher Forschung,'*—The aim of this little work on photomicrography is to afford assistance to those who wish to make use of photomicrography in their investigations, so that they may attain their object with as little expenditure of time and trouble as possible. The theoretical considerations are supplemented by a number of very serviceable practical hints. After a brief sketch of the history of photomicrography and its uses, the author gives a description of a complete photomicrographic apparatus, and explains the various uses and modes of production of the different sources of light. He then deals with the properties of photomicrographic preparations and gives a concise but comprehensive account of the practical operations which are necessary for the production of a good photomicrogram. The usefulness of the book is increased by numerous bibliographical references, good illustrations, and well-executed photomicrograms.

(5) Microscopical Optics and Manipulation.

Diatom-Structure—The Interpretation of Microscopical Images.†—Dr. J. D. Cox in speaking on this subject made the following among other remarks:—

"In such a case the real question is one of interpretation of appearances seen under the Microscope, and what I have to say will bear chiefly on this point, with direct application to the study of diatoms.

All microscopists are acquainted with the position of Prof. Abbe in regard to images formed by diffraction. As commonly stated it amounts to a declaration that all microscopical images of structure with details smaller than $\cdot 0005$ of an inch are diffraction images from which the true structure may be argued, but which cannot be taken as in themselves true representations of the structure. 'The resulting image produced by means of a broad illuminating beam,' says Prof. Abbe,‡ 'is always a mixture of a multitude of partial images, which are more or less different (and dissimilar to the object itself).'

This theory has been very vigorously assailed by Mr. E. M. Nelson, of London, from the practical and experimental side. In a paper read before the Quekett Club in May [1890], entitled "The Substage Condenser: its history, construction, and management; and its effects theoretically considered," Mr. Nelson asserts that the cone of light from a substage condenser 'should be of such a size as to fill $\frac{3}{4}$ of the back of the objective with light; thus N.A. 1.0 is a suitable illuminating cone for an objective of 1.4 N.A.' He says that 'this opinion

* Biol. Centralbl., xi. (1891) p. 351.

† Journ. New York Micr. Soc., vii. (1891) pp. 76-87.

‡ R. M. S. Journal, December 1889.

is in direct opposition to that of Prof. Albe,' and to maintain it he denies the truth of the diffraction theory as applied to microscopical images. He says of it: 'The diffraction theory rests on no mathematical proof—in the main it accepts the physical law of diffraction; but on experiment it utterly breaks down, all criticism is stopped, and everything connected with it has to be treated in a diplomatic kind of way.*' I state Mr. Nelson's position without any purpose of discussing it, and only to point out that it is this to which Mr. Smith refers in his paper when he says: 'This capacity of standing more light was pointed out from the first by Mr. E. M. Nelson, but has not received the attention it deserves, and the neglect of this point has stultified the efforts of many microscopists, both here (in England) and on the Continent, to get more out of the new glasses than the old objectives.'

Mr. Smith's investigation of diatom-structure is thus closely connected with Mr. Nelson's views and experiments upon the diffraction theory. Both will challenge the attention of practical microscopists as well as physicists. I have not gone far enough in my own investigations to warrant me in expressing a judgment on the questions involved; but I would urge every microscopist to make his ordinary work the occasion for accumulating evidence which may help to settle the very important debate. My suggestions are only such as are based upon the well-known history of diatom-study and my own experience. They are offered by way of clearing the field by pointing out the limits of the discussion and the known facts which ought to be kept firmly in mind in all such investigations.

It is no reproach to the Microscope as an instrument of investigation that there are limits to its powers and capabilities. Such limitations are common to all methods of investigation. If, trusting to my natural eyesight, I am trying to make out the meaning of appearances on a distant hillside, I find at once that all perception by the sense of sight is an interpretation of visual phenomena which are not in themselves decisive. They may lack clearness by reason of the mist in the air. They may be obscured by something intervening, like foliage, or may be partly hidden by inequalities of surface. A thousand things may prevent clear and easy interpretation of what I see. I may have to change my point of view before I can reach a conclusion, or even have to go to the object itself. If I cannot do this I may be left in abiding doubt as to what I have seen.

Microscopical examination is precisely analogous to this. If I am examining a mounted object I am tied to one point of view. I cannot approach nearer, and cannot do more than note the visual appearances and make theories to account for them in accordance with facts already learned. We try to vary the conditions as much as we can; we change our objectives; we try central light and oblique light; we examine one specimen dry and another in a dense medium; one by transmitted and another by reflected light; but when we approach the limit of minuteness of object or detail which our instruments will define, we are in the same situation as when using our natural eyes across a chasm, neither better nor worse: we have to account for what we see by a reasonable

* Quckett Club Journal, July 1890, pp. 124-5.

hypothesis which will make it take an intelligible place amongst natural objects.

Our skill as microscopists, apart from the technical dexterity in the use of our tools, consists largely in devising varied experiments and changes of condition, so as to enlarge the body of evidence from which we draw our inductive conclusions. To assist ourselves in this, we also catalogue such facts and methods, and such cautions and warnings, as our experience (or that of others) has taught us. Let us look for a moment at some examples.

We know very well that we are liable to illusions of sight, so natural and so powerful that even the intellectual certainty that they are illusions will not destroy them. If we are looking through the Abbe binocular eye-piece, using the caps with semicircular openings, we see a hemispherical object as if it were a hollow bowl, and, visually, it refuses to be anything else. But this is not peculiar to microscopical vision, for we do an analogous thing with the stereoscope, and by wrongly placing the pictures may make an equally startling pseudo-perspective.

We find that what we call transparent bodies are full of lines as dark as if made with opaque paint, and throw far-reaching shadows. But I see similar ones in the cubical glass paper-weight on the table before me, and know that by the laws of refraction the surface of a transparent body is always dark when its angle to the eye is such as to cause total reflection of the light in the opposite direction. By the same law we know that if the angle of total reflection in the same transparent cube were differently placed with regard to the eye, the now dark surface would become a mirror, reflecting the sky and distant objects as brilliantly as if silvered. Our diatom-shells give us constant experience in these phenomena. A prismatically fractured edge will scintillate so as to defy all efforts to define its outline. Reflected images look like actual details of structure in the object. Dealing, as we constantly are, with objects made of glass, we have constant use for our reasoning faculties to determine the meaning of all these refractions and reflections, which sometimes are almost as confusing as the broken images seen through the glass pendants of a chandelier.

In addition to these familiar effects of refraction and reflection, we have the class of phenomena which we call diffraction effects. These may be wave-like fringes of light and shadow following the outline of the transparent object, and reduplicating this outline; or they may be analogous fringes thrown off the subdivided parts of the object, as from the cup-like outline of alveoli, or from some projecting rib or groove like those along the diatom's median line.

We know by constant experience that when we throw light obliquely through a transparent reticulated object like a diatom-shell, the diffraction fringes from the separate alveoli run together across the shell in dark striæ, oblique or at right angles to the direction of the light. In the *Pleurosigma*, in which the rows of alveoli are oblique to the midrib, we very easily get the oblique striation by the use of oblique light; getting both series of lines at once, one only, or one strong and the other faint, as we please, and with very little trouble. We get, with a little more pains, a transverse striation, at right angles to the midrib,

which is fainter because it proceeds from alveoli not so closely connected in rows. It may be called a secondary striation. With still more effort we may get a much finer and fainter striation, parallel to the midrib, by throwing light at right angles to it, or nearly so. By lamplight, and with objectives not apochromatic, and not exceeding the aperture of 1.0 N. A., these lines are usually in patches, upon spots here and there, longer (in the length of the shell) than they are wide. But with sunlight this tertiary diffraction striation may be made to cover the whole surface of *Pleurosigma angulatum* by an exquisitely fine longitudinal grating over its whole surface, as was demonstrated by Dr. Woodward in one of the most striking of his photomicrographs in what is called "the Abbe experiment." * As the improvement in our lenses, both by increasing their angle, and by the apochromatic system, tends to make visible by lamplight what before could only be seen by the sun, we should expect that something like the fibrillæ shown in Mr. Smith's photographs would be visible. Finding it would not prove that it is purely the result of known laws of diffraction; but it justifies a cautious and scientific scepticism in receiving a new explanation until we have repeated the experiment often enough, and under such varying conditions as to exclude doubt.

As we increase or reduce the obliquity of the light in examining *Pleurosigma formosum*, we know that the alveoli are distorted (or may be) in varying ways and directions. Some of these are figured in 'Carpenter on the Microscope,' but they are only a few of a numerous series. Whoever will experiment a little may satisfy himself that the permutations and transmutations of the diatom markings may be made little short of kaleidoscopic. Hexagonal markings may become square, and may have short lines running off from one angle. These lines may be lengthened, and the square or hexagon reduced to a dot, so that the appearance of the surface may be that of oblique series of parallel dashes. The direction of these lines depends on the direction of the light, making a series of gratings, of which the prevalent character may be oblique in either of two directions, transverse or longitudinal. The so-called intercostal points may be enlarged and brightened until they become the most prominent marking, and the alveoli proper may be diminished to insignificance. These appearances are so like many of those in Mr. Smith's series that we, who can only see the print and cannot get our fingers upon the fine-adjustment of the Microscope and note for ourselves the effect of a change of focus, are necessarily made cautious in accepting his interpretations; but there should be caution in rejecting as well as in accepting, and he fairly challenges us to repeat his investigations under similar circumstances, and with similar objectives.

An examination of his print No. 12 with a hand-lens will illustrate what I am saying. When looked at with the naked eye, this print shows a long patch of longitudinal striation on the lower side of the valve. Immediately below the midrib we see the coarse, oblique dotting peculiar to *Pleurosigma formosum*; but if we use the lens we see at once that, in the patch referred to, the dots are twice as numerous as the

* See Roy. Micr. Soc. Journ., ii. (1879) p. 675; also Mon. Micr. Journ., xvii. p. 82.

alveoli of the shell. The interpolated ones (proceeding from above downwards) are at first very small, then larger but rectangular, and twice as long as wide, making the pattern one of alternate dots and rectangles; as we pass to the right the rectangles run into each other obliquely, making a wavy white line, the dots of the alveoli proper being in the bends of the line, very much as in the longitudinal fibrils of print No. 11. This change, distortion, and multiplication of the dots is so entirely within our common experience in diatom-study, that I have no hesitation in explaining the longitudinal striated appearance in this patch as the result of the reduplicating of the dots by the intercalation of the rectangular ones, making in fact broken lines, which on so small a scale are sufficiently even to make continuous ones to the naked eye. On the other side of the midrib in the same print (No. 12) the rectangles and round dots are of nearly equal size, but they still make a faint longitudinal striation, diverging a little from the midrib as we pass from left to right.

We thus have an ocular demonstration how a striated appearance may be made out of a tessellated one, when there is no question of continuous fibrils. Yet even this does not prove that the fibrils are not there. Of course all visual appearances under the Microscope have their cause in the structure of the object, considered in relation to the laws of transmitted and reflected light. The puzzle often is to tell what to attribute to each factor. I do not think it difficult to account for the tessellated appearance of dots and squares with alternate blue and red colour. To do so may require us to refer to some elementary matters in diatom-marking.

Dr. Brebisson, at a very early day, divided the regular dotted markings of diatoms into three classes: (1) *Quadrille rectangle droit*—in squares parallel to midrib, e. g. *Pleurosigma balticum*; (2) *Quadrille rectangle oblique*—in squares oblique to midrib, e. g. *P. formosum*; (3) *Quinconce*—quincunx or lozenge of 60° smaller angle, e. g. *P. angulatum*. This classification has been a good deal neglected, but has good claims to remembrance, and will assist me in explaining the phenomena before us.

In Mr. Smith's print No. 6 is well shown what I regard as the normal scheme of areolation of *P. formosum*. It will be seen to be a reticulation with meshes as nearly square as nature gives us in growing things. If the corners of these meshes be filled up, the included circles will still keep to each other the relative position of Brebisson's oblique quadrille. The diminution of the round alveoli would not need to proceed far before the approximately rectangular mass of silex between the circles would be about as large in diameter as the circles themselves. Under the laws of optics, which we have already seen illustrated in print No. 12, the tendency of approximately rectangular details is to become more strictly so in the microscopical image. In Fig. 74 I have illustrated this by a geometric diagram, of which one half shows the square reticulation, and the other the resulting tessellation of solid squares and round alveoli when the walls are thickened and the corners filled up. It will be noticed that when the corners are so filled as to make the alveoli circular, the interspaces are approximately square, and, being solid, will be red or pink by transmitted light when the alveoli are

bluish-white. On the inner side of the shell the thin circles, or "eye-spots," are usually smaller than on the outer side; the diffraction effect by transmission of light will straighten the edges of the tessellated outline; the squares will each have half the area of, and will be diagonal

FIG. 74.

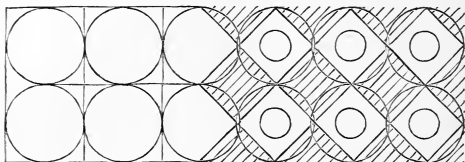

to, the original squares; and with their alternate colours we shall have exactly the appearance which Mr. Smith describes, and which is very well shown in prints * Nos. 1 and 2, compared with No. 6.

The peculiarity of the quincuncial arrangement of alveoli is that when the circles crowd upon each other so as to become polygons bounded by straight lines, they form hexagons instead of squares, and even when they are circles in a continuous plate of silex the hexagonal outline is a persistent ocular illusion. We should expect, therefore, that the tessellated appearance with equal squares of red and blue would be a mark of *P. formosum* as distinguished from *P. angulatum*, under proper conditions of illumination and examination.

We are justified in concluding, therefore, that the phenomena of colour and form thus examined are not only consistent with, but strongly confirm, the generally received theory of diatom-structure, and cannot be said to indicate anything new in that direction.

Mr. Smith also expresses the opinion that only by means of a wide-angled objective, and illumination by a wide cone of light from the sub-stage condenser, can the upper and lower films of a shell like *P. angulatum* be discriminated. As he recognizes some photographs made by me, and deposited with the Royal Microscopical Society in 1884, as showing this discrimination, it is due to scientific accuracy to say that they were made with a Wales 1/15 water-immersion objective of about 1.0 N.A. aperture, and with a narrow cone of light coming from a Webster condenser under the stage having a diaphragm with a 1/4-in. opening behind it. Mr. Smith's own objects photographed could not be illuminated with a very wide cone of light, as they were mounted dry, and he tells us he used his condenser dry. There was therefore a stratum of air both above and below the slide on which the object was mounted, and the illumination could not exceed the "critical angle," 82°, in passing through the cover-glass, and must in fact have been considerably less.†

* These prints are given in an article by Mr. Smith in the journal here quoted (pp. 61-72).

† In my note-book, June 3rd, 1884, I find that I entered my observation of one of the broken shells which I photographed, as follows: "A remarkably interesting

In my own experience I have found a broad cone of illumination unsatisfactory, for the same reason that I have found oblique light in one direction unsatisfactory. It is almost impossible to centre the sub-stage condenser so accurately that a wide cone can be trusted to be central. If you centre it by examination with a low power, it is almost certain that it will not be centered for a high power, for two objectives are rarely centered alike. The field, under a magnification of 1750 which Mr. Smith has commonly used, is so small that the least decentering will illuminate it only by the oblique rays from one side of the cone, and we then immediately get diffraction effects. I am bound in candour to say that in most of Mr. Smith's prints I recognize similar effects to those which, in my own work, I attribute to oblique light. It may be that, with improved contrivances to secure exact centering of objective and condenser, we shall find advantages in the use of the wide cone. I speak now only of my own experience under existing methods. The slightest turn of the mirror on its axis will change light from central to oblique; and I suppose we are all in the habit of doing this, so as purposely to throw light through one side or segment of the condenser for the purpose of studying the effect on an object of the changing direction of illumination. So unstable a source of light prevents our knowing very exactly when the light is strictly central, and makes it hard to return to any exact condition from which we have departed even a little. These considerations have kept me (perhaps mistakenly) in the practice of using the narrow cone of light for photography, reserving my oblique light for special resolutions of striation and for the professed study of changing effects.

Similar reasons have made me distrustful of dry mounts when high powers are to be used upon any but the thinnest objects. Refraction, and attendant diffraction, are so increased with increase of index, or rather increased difference of index, that it has grown to be a maxim with me to have the mounting medium and the object as near alike in index as is consistent with the discrimination of structure. The pale images of transparent objects are those I find most truthful, for paleness is consistent with good definition and resolution, whilst the brilliant pictures are apt to be glittering deceptions. I fully admit, however, that it may well be that with improved glasses we may add to the extent of details visible upon a surface, like that of a diatom-shell, and that it is possible that mounting in most media would obliterate the finest of these details. To a certain extent we are all familiar with this. A rather coarse dry shell like *P. balticum* will have its details instantly obliterated if water from the immersion of our objective penetrates beneath the cover-glass. Mr. Smith's print No. 50 might pass as an excellent reproduction of this effect, the fluid passing along the structural lines, obliterating part and leaving part.

But when full weight has been given to all these things, and we have put aside those of Mr. Smith's long and beautiful series of photographs

fragment of *P. angulatum*, showing partial removal of one film, and fracture through dots over a large space." In preparing this paper I have repeated the examination with the objective named, and find the distance between upper and lower film easily appreciable in focusing.

which are liable to our criticism, there still remain several which cannot be thus disposed of.

Prints Nos. 14 and 15, taken with half the magnification of most of the others ($\times 875$), show strips of surface marking which strongly support Mr. Smith's interpretation, viz. that the outer surface of *P. formosum* is covered by a longitudinal series of fibrils separating so as to pass round the alveoli and uniting over the solid corner interspaces. The definition in these cases is not only reasonably clear and free from the ordinary marks of diffraction effects, but, most conclusive of all, there is in No. 15 a bit of this film floated off the shell and lying detached by its side. The fibrillar structure of this bit leaves little room for scepticism, and it so exactly accords with the appearance of the similar fibrils remaining on the surface of the shell that I cannot refuse to accept it as evidence of structure. Going back from these to prints Nos. 10 and 11, we now find reason to accept these also as evidences of the same structure, though distorted by obliquity of light, so that they would not have been satisfactory taken by themselves. On No. 5 also we may recognize some of the same fibrils. The single detached fibril in No. 9 is not so directly connected with any other specimen, either in the photograph or in Mr. Smith's description, as to present the evidence on which it is shown to be part of the same structure; but the measurement of its flexures so corresponds with the areolæ of the shell that its probable connection with a similar valve may be assumed.

The interpretation of this structure which seems to me most satisfactory is to regard these fibrils as superposed upon the general surface of the shell as a protection to the thin capping of the alveoli against abrasion. It would, in that case, come under the description of those appearances which I have referred to in paragraph 4 of my general summary, viz. a "thickening on the exterior of the lines bounding the areolæ . . . which is not in contravention of, but is in addition to," the usual formation of the shell by means of two principal plates or films. All the species of *Pleurosigma* which have the alveoli arranged in Brebisson's *quadrille* seem to have strengthened ribs between the rows of "dots"—*P. balticum*, *P. attenuatum*, &c., have them longitudinal and straight. Mr. Smith's observations seem to prove that *P. formosum* and its congeners have them longitudinal but wavy, which is a positive addition to our knowledge, since we should naturally have expected them to be oblique. The appearance of the finer square tessellation in either of the principal films of an obliquely marked *Pleurosigma* would seem to prove it to belong to the "quadrille" marked class, and I think the smaller forms which Mr. Smith has left unnamed may be identified as *P. obscurum* W. Smith, which is probably only a small form of *P. formosum* or *P. decorum*.

I do not find in the prints any conclusive evidence that the quincuncial marked species, as *P. angulatum*, have the same series of fibrils. No one doubts that all have a vegetable membrane in which the siliceous is deposited, and, under favourable circumstances, a fracture through a row of dots would leave the thicker connecting membrane looking approximately like a fibril. The argument from analogy is not as strong here as in the case of the "quadrille" marked kinds. The structure may be

found in all, but the evidence does not yet seem complete. There is here a good field for further investigation.

This leads me to say that the size of the fibrils shown by Mr. Smith does not seem to me so minute that any good 1/10 or 1/15 objective should not define them. We must remember that the condition of an object may count for much in the resolution of its structure. A thickly silicified shell may not show what an imperfectly silicified one will demonstrate. The former will break into small angular bits with a mineral fracture; the latter may separate into threads or membranes. The floating off of the fibrils in print No. 15 seems to show that the shell was in a peculiar condition; a sort of dissection of an uncommon kind having taken place naturally or artificially. It would be an interesting experiment to subject various species of *Pleurosigma* to the action of hydrofluoric acid for varying periods, and then mount them for examination. To extend Prof. Bailey's old experiments in this direction would be very useful, but the danger of injury to the objective is such that it would hardly be advisable to watch the action of the acid under the Microscope.

If I seem to have reduced the new matter in Mr. Smith's observations to a minimum, I should not do justice to my sense of the real value of his work unless I add that enough remains to make it, in my judgment, a very important and interesting step in the investigation of diatom-structure. It is also full of promise that still further results may be attained by pursuing the investigation on the same line. I am confident, therefore, that the Society will join with me in expressing a sincere sense of obligation to him for communicating the results of his observations, and especially for the valuable aid in understanding them which is given by his beautiful series of lantern slides and prints."

On a new Method for the Measurement of the Focal Length of Lenses or Convergent Systems.*—Sig. G. Vanni gives the following method for measuring the focal length of lenses. If F denote the focal length, p and q the distance of the object and image from the two focal points, we have $p q = F^2$. Small displacements of the object $\Delta \Delta_1$ produce corresponding small displacements of the image $\delta \delta_1$ in such a way that always $(p + \Delta)(q - \delta) = F^2$ and $(p - \Delta_1)(q + \delta_1) = F^2$. These three equations determine p , q , and F when the displacements are known. The plane object is movable on the optical bank and the position of the image corresponding to known displacements of the object is determined by means of a Microscope.

Proof of a simple Relation between the Resolving Power of an Aplanatic Objective of the Microscope and the Diffraction of the finest Grating which the Objective can resolve.†—M. C. J. A. Leroy starts with the general theorem of Abbe that an objective in order to resolve a grating must have its aperture sufficiently large to admit at least two spectra of the grating. Abbe deduces this relation as the expression of a special function of the angular aperture of the

* See Central-Ztg. f. Optik u. Mechanik, xii. (1891) p. 152; and Atti dell' Acc. d. Nuov. Linc., 6, 90.

† Séances de la Soc. Franc. de Phys., 88. See Central-Ztg. f. Optik u. Mechanik, xii. (1891) p. 152.

objective, his "specific function of the aperture," and takes it as the starting-point of a theory of microscopic vision. To the latter the author raises objections, although he admits that the experimental data are beyond doubt. His idea is that the theorem is an immediate consequence of the diffraction on the edges of the diaphragm which limits the aperture of the objective, and that consequently the specific function of Abbe is nothing else but the diffraction produced by the edges of the aperture.

(6) Miscellaneous.

Dr. Dallinger's Address to the Quekett Club.*—The Rev. Dr. Dallinger said:—"In addressing you to-night, as President of our Club, I shall keep before me the fact that, whilst we seek as a Club to prosecute all our mutual and individual inquiries in a completely scientific spirit, many amateurs are included in and welcomed by the Club, and that we aim at promoting and aiding early efforts with our favourite instrument, quite as much as criticizing the last results of experienced research, or the latest endeavour to render more perfect the instruments with which we work.

Keeping these facts before me, I am strongly impressed with the conviction that no subject can have a more general area of interest among microscopists than the work being done regarding the nature of the animal and vegetable cell. To what extent a full and complete knowledge of animal and vegetable cellular life and history, leading to a full grasp of the comparative physiology and morphology of cells, may ultimately contribute to a completing of our knowledge of life and function in animals and man, it may not be possible to say; certain it is that what we already know has profoundly affected our insight into animal structure; but our progressive and further knowledge of the structure of the tissues that form the body, and of their physiological and even pathological action, must be concurrent with our advancement in this subject.

Upon the progressive excellence, therefore, of the Microscope as an instrument of precision on the one hand, and upon the increasing delicacy and skill with which we are enabled to prepare tissues for examination and progressive research with that instrument on the other hand, must depend our advancement.

Whatever leads to more perfect optical construction is an essentially good thing; and what is sometimes cavalierly treated as "amateur microscopy" has contributed largely to optical advancement.

It is after all "the battle of the lenses" that has led up to, and called into existence, the splendid lenses of to-day. But this was, for all practical purposes, a battle fought by amateurs and opticians. Our schools of biology in England, the Continent, and America took little, if any, part in it. Yet without question it is the students in our great biological schools who are deriving the largest benefits from the splendid improvements in quality, price, and modes of using recent Microscope objectives.

By apochromatism the study of ultimate cell-structure and cell change,

* Journ. Quek. Micr. Club, iv. (1891) pp. 304-14.

normally and pathologically, has been made a splendid possibility. The "laying" of optical "ghosts," the elision of complicated and confusing foci, by beautiful optical construction, is of incalculable value. It gives certainty and precision to all work done.

But we must be careful now not to reintroduce the ghostly element by false interpretation. I am increasingly convinced of the possible danger of employing shafts of oblique light only in one azimuth. The peril of misinterpretation is enormous.

Indeed, I have a growing conviction that all small cones of illumination may be fraught with danger, at least to the amateur.

Our German fellow-workers have only lately risen to the perception that the condenser is of value at all, but the condenser they universally employ is chromatic. Its aberration is enormous. True, their greatest microscopical optician has within the last three years seen the value of achromatism, and has made an achromatic condenser; and its value, as compared with that of the chromatic combination, is inestimable.

But surely if we are to get the purest results from apochromatized lenses, if we are to get a focal image absolutely freed from ghostly confusion, we should have an apochromatized condenser, and a condenser of the greatest possible numerical aperture.

In England those who have made microscopy a special pursuit, have long worked with fine achromatic condensers. I am glad now to know that the first apochromatic condenser yet made has been produced by the firm of Powell and Lealand, and it only needs an hour's trial in expert hands, and experienced judgment, to discover its great superiority. It has an aplanatic focus of $\cdot 9$, and even if oblique beams only in one azimuth be used, their danger is reduced to its lowest. But it is by the employment of large cones of illumination, and not with small ones, that I say cautiously, but still with emphasis, the finest and truest results are to be obtained.

We may well pause before we finally pronounce on this subject, but it certainly is one that must be settled in practice, however present theory may point; and we must all feel that the remarkable paper of my friend Mr. Nelson on this subject, read to us during the past year, must be gravely considered, and made a starting point for patient research. For it is by such means that an amateur club like ours may contribute what is of permanent value to the professors and students who use the Microscope so largely in our schools of biology and medicine.

But, nevertheless, it is possible to push one phase of optical construction so far as to accomplish the object, but to leave doubtful the usefulness of the object gained.

We have all heard of the new objective produced by the firm of Zeiss, of Jena. It has a numerical aperture of $1\cdot 60$. This from one point of view, is a great advantage. None would have greater reason to hail it than I, in the special work with which my life has been largely occupied.

Now, I have spent five consecutive days in the close and critical examination of one of these objectives, which, so far as I know, has been in no other hands but my own and those to whom I have shown it. I desire to take the sole responsibility of estimating its value. In my hands it is an extremely beautiful lens; it is well centered, well corrected,

and shows plainly the advantage of its enormous aperture. It is a triumph of the optical firm which produced it.

But I would hasten to say (1) That I would not trust a single result produced by its means, when oblique light in one azimuth is employed, especially with the chromatic flint condenser provided by the firm of Zeiss for its illumination. It is fatal to its truth. We can absolutely get almost any desired result with it. It is a very optical witch of Endor for calling up ghosts and ghostly visions.

(2) I did not use with it the condenser provided for its illumination. This has a dense flint front lens, and an enormous amount of aberration. It breaks the delicate balance of the beautiful objective, and is to it, in critical hands, worse than the chromatic Abbe condenser used upon fine apochromatic objectives of lower aperture; and naturally

(3) I could only successfully employ the fine achromatic condenser of Powell and Lealand with the great numerical aperture of 1.4. This, of course, could not utilize all the immense aperture of the lens, but when its full cone was employed with its relatively great aplanatic aperture of 1.1, it yielded results that to a student of delicate diatomaceous images was a vision of beauty indeed.

And it could do more than this with an apochromatic or even an achromatic condenser of its own aperture.

But now comes the pragmatic question, which we are bound to ask, "What does this objective contribute to the practical work to which, for the attainment of the highest results, the Microscope must be applied?"

I say at once for the amateur and the lover of splendid images the objective may be a delight.

But I have pointed out before that even immersion objectives, though they have a great, have nevertheless a very limited, use in strict biological inquiries of a certain kind.

This is true of water; it is doubly true of oil. If we are examining minute life under a limited cover, the fluid above, between the lens and the top of the cover-glass, will ultimately, in following the travels of the living creature, be caused to mingle with the fluid between the cover and the slip, and so destroy the work.

But in spite of this, immersion and especially homogeneous objectives have an enormous value for experiments in control and comparison.

But with the new lens of this great aperture, not only have we to use flint covers, specially and expensively ground, and flint slips, but of course we have to employ a dense mounting medium absolutely fatal to all organic tissues.

Flinty and carbonaceous animal and vegetable products, however fine, may be examined by its means; but the cell as such, to say nothing of the living cell and unicellular organisms, can never at present be subject to its optical analysis.

Now it must not be supposed that this fact was not fully known to its accomplished makers when they devised and sent it out; that would be an error. But in our inquiry as to the influence it will exert upon the special work of the Microscope in unravelling the structure and deportment of animal and human tissues it is a great factor.

In spite of the splendid result attained by it, as biologists we gain nothing. We are where we were, and studies of cells and cell life must be made with dry and immersion apochromatics of N.A. 1.4, or at most 1.5.

With this fact before us, it will be well for us to remember what we are searching for as experts, in tracking the life and behaviour of various cells, and founding, or endeavouring to found, a comparative morphology and physiology of cells and unicellular bodies.

The sphere of all research is strictly physical. Existence, not the cause of existence, succession, not the cause of succession, is our object. There can be, perhaps, but little doubt that life is a cause of phenomena, not a phenomenon in itself. As such it is impalpable to the scientific method. It cannot be the subject of experiment nor the object of a demonstration.

Certainly, in tracking the essential activities of life home to the individual cell amidst its class, or group of cells, or to the unicellular organism, we are coming into closer quarters with the mysterious cause of the phenomena of vitality. But its nature eludes us as much as before. We are, of course, no nearer to the solution of the problem of what life—the cause of all the phenomena of living things—is, than we were before.

We track its phenomena to almost their last scene of phenomenal action, but it is still only phenomena we are studying.

I do not assume that life is not a physical cause. We have no justification for doing so. But if we would go further back than the finally accessible phenomena of cell morphology and cell function it would appear that we must penetrate the mystery of atomic properties as they are found in living things, for it is, so far as our present knowledge can carry us, to the unaccountable combination of thoroughly known chemical elements that life and its properties are due. The at present unanswerable question is how not-living substances, such as C, H, O, N, with whose properties we are so familiar, should so combine, as in their combination to acquire the properties of life.

But while our inquiry will strictly confine us to phenomena, the study of the phenomena of minute cellular structure and minute unicellular organisms is essentially the highest, and, in some senses, the newest line of inquiry open to patient and enlightened study.

Its promise is enormous. But I would urge the necessity for the study of the living cell; the dead cell, dried and stained, is a poor representative of the living cell both in form and internal appearance.

The unicellular organisms, as the simplest types of cell, deserve the closest and most untiring research before broad inferences are made upon the nature and behaviour of grouped cells in tissues.

As there can be no abstract protoplasm—no protoplasm not belonging to a specific organism—and not therefore presenting itself to us as protoplasm with its own specific history and inherited qualities, so there cannot be an abstract cell. That can only exist in the imagination of the theorist. Every cell we meet with in biological realities is not only a cell, but a cell complicated with its own peculiar history and inheritance, and therefore those cells with the least complicated history should command our earliest and most thorough study; and from these we may safely advance to the more and the most complex.

Some of the cellular elements of the tissues have been noted with even simple Microscopes for over two hundred years, Dr. Hooke, in the year 1665, being among the first observers. The nucleus itself may be said to have been seen and described over one hundred years ago. It is still, however, true that the first great step leading to actual scientific advancement in this subject was made in 1831 by the distinguished botanist Robert Brown. He gave us definite knowledge of vegetable cells, and he demonstrated that the nucleus was a normal element of the cell.

What was called the nucleolus was discovered by Valentin five years later.

But even before Brown, Turpin had affirmed the physiological significance of the cell, attributing to cells distinct individualities, and affirming generally that plants were formed by their agglomeration.

But, as is now well known, the cell theory proper was founded by Schleiden, but by him it was restricted to plants. He defines the vegetable cell as "the elementary organ which constitutes the sole essential form-element of all plants, and without which a plant cannot exist; and as consisting, when fully developed, of a cell-wall composed of cellulose, lined with a semi-fluid nitrogenous coating."

To him, therefore, the cell presented itself as a vesicle with semi-fluid contents. This was in 1838. In the following year Schwann extended the cell to the animal kingdom, but to the two elements of Schleiden he added a third, that is to say, the nucleus, which he deemed essential to the existence of the cell in some period of its history. And on his authority these triple elements of the cell were universally believed to exist.

In proportion, however, as the cell theory was more and more extensively seen to characterize the animal world, it was found increasingly difficult to maintain the threefold constituents of the cell.

The conception that the cell was a "vesicle closed by a solid membrane containing a liquid in which floats a nucleus containing a nucleolus" rapidly gave way before investigation. In 1841 it was shown that cells multiplied by budding, and that the nucleus underwent fission when the cell divided; and it was contended by Goodsir that no cell could arise save from a parent cell, which was seen by Virchow to have direct application to pathology.

But it was Naegeli, a botanist, who showed first the unimportance of the cell-wall, and he was supported by Alexander Braun. But it was scarcely a universally accepted belief until Leydig, in 1857, decidedly declared it unessential, and defined a cell as "a soft substance inclosing a nucleus."

After this it was shown by Max Schultze that a cellular life might be complete even without a nucleus, as in *Amœba porrecta*; thus we come back to the cell as the ultimate morphological unit in which there is any manifestation of life.

Thus, then, by the cell theory in this form we discover that "every animal presents itself as a sum of vital unities, any one of which manifests all the characteristics of life."

I must not linger even for a recapitulation of the earlier views held regarding the living matter which constituted the cell; enough here that it was held to be a matter with an endowment of its own, possessing

properties which were *sui generis*, that is to say, that not-living matter could not, by any process we are acquainted with, take on the unique properties of matter which lived. Only from the living could the living arise. This matter was called *protoplasm*, and a quarter of a century ago was defined as "a diaphanous semi-liquid viscous mass, extensible, but not elastic, homogeneous, that is to say, without structure, without visible organization, having in it numerous granules, and endowed with irritability and contractility."

A minute particle of this, either nucleated or non-nucleated, was considered a cell.

But undifferentiated protoplasm did not long universally hold the field. It was gradually shown that a distinct structure was discoverable in some cells, and subsequently it was shown that nearly all cells and all forms of protoplasm show a microscopic network of fine fibres. In short, it became plain that the reputed structurelessness of the cell was due to the inefficiency of the lenses used, and was dissipated when competent optical aids were employed.

Since this time great progress has been made, and modern objectives, finely corrected and of great optical precision, have been very widely used, and it has been shown that the nucleus, instead of being the simple body it was at one time believed to be, proves itself to be of great complexity; and, as I believe, within it are initiated all the great changes which the cell as a whole undergoes.

This could be shown in various ways, but I have been able to demonstrate it in regard to the lowliest and least of all the organisms fairly accessible to us.

The histories of the Saprophytes of this country I have been working at for over twenty years. It is only within the last six or seven that I have been able to deal with the nucleus as an optical entity to be investigated by itself.

In my earlier work we were obliged to study the organism as a whole. Our best objectives failed us when we ventured to study the nucleus. So we were obliged to treat the nucleus as participating in or sharing the life processes of the cell. It was, in fact, to us then a mere passive instrument.

But homogeneous and apochromatic lenses have changed all that. With the objectives I can now employ I am able to deal as definitely with the nuclei of such saprophytes as possess them as I was twelve years ago with the whole organism. Yet the amplification is not greater, nor so great; but that secret of all successful microscopic investigation, a numerical aperture suited to the amplification used, is at our disposal, and this with the ghosts of injurious spectra taken away.

The result is a discovery that the apparently simple nucleus of the lowliest and the least of known organic forms is complex in a high degree; that it is the spring and fountain of vitality in the cell. All modifications to which the cell is subject in its life cycle originate in it. It is, moreover, at certain periods of development of the cell endowed with striking structure, and this structure grows more or less marked as the unicellular organism enters upon or passes certain cyclic periods of change.

In brief, the nucleus of the simplest of living cells is complex in an

astonishing degree; and, therefore, I would argue that by its careful study, and by the study and comparison of kindred unicellular organisms, we shall find nuclear complexity in its least complex condition, and, therefore, more capable of guiding us amongst the perils of the karyokinetic figures of the cells of tissues with vast biological histories and long biological inheritance.

Nor is this all. They may be studied in their living condition, and, I will add, only with efficiency in that condition. Stains may be to some extent used without destroying the organism, and by patience and a thorough knowledge of the nature and use of objectives and condensers, facts of immense value can be made out.

What we want to discover is, what determines the changes in so lowly and minute a nucleus, and what are the correlations between the changes in the nucleus, and the powerful changes brought about in the minute unicellular organism.

The entire organic cell, with a complete life-history definitely known, if relatively large, may be, say, the one-thousandth of an inch in breadth and thickness respectively. Cubically it occupies the four-thousand-millionth of a cubic inch.

The nucleus may be the one-tenth part of this cubically. Yet within this area all the determinate causes of vital phenomena of the whole unicellular organism are at work; and what is more, they are accessible to our perception through modern instruments—and those, when properly used, are instruments of precision.

So far as my present ability and instruments carry me, when the organism is in a fixed or static condition, whether for a shorter or a longer time, the nucleus is a glossy hyaline body with considerable refractive power and no discoverable structure.

But directly a change is about to ensue the nucleus puts on the first evidence of it. The cyclic change of these unicellular organisms is, that after growth from the germ or egg emitted from a maternal sac, and when maturity is attained, the cells go through rapid and successive fission. Their division into two or more in every case is complex, inasmuch that, however complicated the flagella of the organism may be, the division is so effected as to produce for each divided part the flagella possessed by the original undivided form, and so with the nucleus.

Following upon this, after a long series of fissions extending over many hours, the final links unite with other ordinary forms, the protoplasm of each melting into the other and producing a sac in which the genetic seed arises, from which a new generation grows.

Now the added point of great moment is that I can now—previous to the first fission in a new generation—discover the initiation of this act in the nucleus. In fact a powerful change takes place. The hyaline particle becomes turbid, as I now know, with structure; this structure divides, and this initiates the division of the nucleus. Upon this follows the division of the whole organism.

This takes place in every fission.

But quite another change comes over the nucleus of the last link in a chain of fissions. Instead of becoming semi-opaque with structure, it becomes opaque by what, to our present resources, is a homogeneous milkiness, and greatly enlarges.

Once observed, there is no mistaking the nucleus in the two conditions, and always when in this last condition it seeks and effects union with another, and genetic products ensue.

I cannot but believe that we have here the act of fertilization in its simplest condition, and the act of cell-budding in its most initial state. By their study the complexities of karyokinesis may be, I believe, approached and understood. It is worthy of our best effort; and certainly is worthy of the finest endeavour of the optician and the chemist to provide us with the best possible objectives—not objectives that, though triumphs of science and art, are not adapted to our wants—but objectives that may be applied to this most difficult and most promising labour by meeting our specific and inevitable wants.

This may not be possible without the chemist's aid. It seems almost certain that mounting media of great refractive indices are indispensable; but to serve the purpose of the student of living cells they must be media applied without heat, and at least tolerant, or for some moments at least not destructive of organic tissues.

Of this I do not despair, and when I see what great mathematical and optical insight and ability have done in the past, combined with perfect lens grinding and mounting, I anticipate a nobler future for microscopic biology and microscopists of the true type."

The late Mr. John Mayall, Jr., Sec. R.M.S.—Our deceased friend, who to so many of us was the type of manly vigour no less than of great mental activity, died on the 27th of July last, from an attack of acute pneumonia; his illness was so short that many learnt of our loss only when the August number of the Journal came into their hands.

Mr. Mayall was not fifty years of age, having been born at Lingard, in Yorkshire, on January the 7th, 1842; he received his early education at the Lycée Bonaparte, where, as we may suppose, he acquired his accurate knowledge of French language and literature: on his return to England he was for a time a student at King's College, London. But, as we all recognize, a man's education depends as much, if not more, on his associates than his schoolmasters; Mayall was a friend of the great French painter Meissonier and the distinguished English mathematician Augustus de Morgan.

His acquaintance with and mastery of the theories of mathematical optics was of great service in the introduction and explanation of the views of Prof. Abbe; he translated Naegeli and Schwendener's treatise on the Microscope, and he delivered two valuable series of Cantor Lectures on his favourite instrument before the Society of Arts. He first became associated with this Society in 1867, and was a member of its Council from 1881 to the time of his death; in 1890 he was elected to succeed Mr. Crisp as one of the Secretaries of the Society. In this last office he was most energetic, undertaking the greater part of the direction of the affairs of the Society, and being a constant visitor to our rooms. He carried through the business of our removal at great trouble to himself, but none to the Society, and, even on his death-bed, he sent communications to his colleague regarding some difficult questions in which the Society's interests were involved.

The Fellows had ample opportunity of observing Mayall's acquaintance with all the details of the manufacture and manipulation of the

Microscope; he made himself personally acquainted with what was being done at Jena, and he may well be said to have been the link between English and foreign microscopists of all nations. The large collection made by Mr. Crisp was thoroughly well known to him, and he took a warm interest in everything that concerned it.

If his great knowledge of his subject had any drawback, it was one that affected him alone adversely; an inventor of a new instrument never likes to be told that much or all is old; the constructor of a faulty one objects to having his errors swiftly exposed. As Mayall was no respecter of persons, and perfectly lucid in his criticisms, he was, perhaps, a more unpopular man than he really deserved to be. To a rare knowledge he added a rare courage.

The activity of his mind showed itself in his proficiency at games of skill, and particularly of chess, but he was hardly less active of body; not only was he a good fencer, but in these days of cycling it must not be forgotten that he was the first to ride a bicycle from London to Brighton.

The thoroughness with which he put his hand to do his duty or his pleasure was equally evident when he was called upon to serve a friend or do a kindness; others beside the present writer must have been astonished at the time and trouble he would ungrudgingly devote to serve them.

The anonymous manner in which this Journal is conducted makes it impossible for any not "behind the scenes" to know how much its success has been due to his assistance; one who does know may sum it up by saying that the death of Mayall has deprived him of one of the shrewdest counsellors a man may ever hope to meet with in his earthly pilgrimage. The student of microscopy will regret that a work just commenced on the history of the Microscope will now never see the light.

We append a list of Mr. Mayall's papers and inventions:—

C. Naegeli and S. Schwendener, *The Microscope in Theory and Practice*. Translated from the German. 8vo, London, 1887.

Immersion Objectives and Test Objects. *Monthly Micr. Journ.*, 1869, pp. 90-3.

The Controversy on the Aperture Question. Letters in the *Monthly Micr. Journ.*, 1875, pp. 93-7, 150-1, 214-5, 299-301; 1876, pp. 50-1, 97-100.

Aperture Measurement of Immersion Objectives. *Journ. R. Micr. Soc.*, 1879, pp. 842-3.

Immersion Illuminators. *Journ. R. Micr. Soc.*, 1879, pp. 27-31.

Description of Nobert's Ruling Machine. *Journ. Soc. Arts*, xxxiii. (1885) pp. 707-15.

Cantor Lectures before the Society of Arts, 1886, 1888, 1889. Published in *Journ. Soc. Arts*, xxxiv., xxxvi., and xxxvii.

An account of his visit to Jena. *Journ. R. Micr. Soc.*, 1887, pp. 322-5.

Various Papers on Microscopy and Microscopical subjects published in the 'English Mechanic' under his *nom de plume* of F.R.M.S.

He also devised and improved the following, of which notices were published:—

Immersion Stage Illuminator. *Journ. R. Micr. Soc.*, 1879, pp. 837-8.

Spiral Diaphragm for Oblique Illumination. Journ. R. Micr. Soc., 1881, pp. 126-7.

Modified form of Nelson's Lamp. Journ. R. Micr. Soc., 1884, pp. 286-7.

Amplifiers for the Microscope. Journ. R. Micr. Soc., 1884, p. 607.

Stepped Diagonal Rackwork. Journ. R. Micr. Soc., 1885, pp. 958-9.

Mechanical Stage. Journ. R. Micr. Soc., 1885, p. 122.

Jewelled Fine-Adjustment. Journ. R. Micr. Soc., 1890, pp. 508-9.

Carl Wilhelm von Naegeli.*—As the son of a country physician at Kilchberg near Zurich, Naegeli was originally intended for the medical profession, and for this purpose studied at the University of Zurich. His interest in medical matters, however, soon waned, and it was not long before he turned his attention to botany, in the study of which his progress was so rapid, that in 1840 he obtained his doctor's degree at Zurich by a work on the Swiss *Cirsixæ*. After a brief sojourn in Berlin, spent in the study of Hegel's philosophy, Naegeli turned to Jena, where he became associated with Schleiden in editing the 'Zeitschrift für Wissenschaftliche Botanik.' In that journal he published his important discovery of the spermatozoids of Ferns as well as of the Rhizocarpeæ, first explained the importance of the apical cell, and showed by examples the astonishing regularity in the growth of the cells of plants. Journeys to Italy and England gave Naegeli opportunities for the study of marine Algæ, which resulted in the appearance in 1847 of his work 'Die neueren Algensysteme und Versuch zur Begründung eines eigenen Systemes der Algen und Florideen,' followed in 1849 by his 'Gattungen einzelliger Algen.'

Naegeli entered upon his academic career, first as Privatdocent and then as Professor at Zurich. From Zurich he soon received a "call" to Giessen, and in 1852 to Freiburg. The three years which he spent in the latter place were devoted to the work which was contained in the physiological researches published later in conjunction with Prof. Cramer: it included the exhaustive work on the starch-granules, and on the theory of intussusception. In 1855 Naegeli returned to Zurich as professor in the then recently opened Swiss Polytechnic School. In the summer of 1857 he received a call to the University of Munich, where his first work was to prepare plans for the Botanical Museum, for which purpose he made journeys to St. Petersburg and Paris.

Amongst those who received instruction from Naegeli at Munich were Schwendener, Leitgeb, Engler, Brefeld, Prantl, Peter, and Dingler. The scientific work which he next produced, including the important researches on the course of the vascular bundles, on the examination of microscopic objects in polarized light, and the classic treatment of the question of the formation of varieties and the laws of hybridization, soon led to his being regarded as the first of living botanists. It was in the winter of 1876-7 that he brought before the Aerzlicher Verein in Munich a series of papers on the lower Fungi and their connection with infectious diseases; in 1879 appeared the 'Theorie der Gärung,' and in 1882 the 'Untersuchungen über niedere Pilze.' Naegeli's contributions to bacteriology met with great opposi-

* Chiefly from a notice in the Münchener Med. Wochenschrift, by H. B.

tion, and it is true that later researches have shown that many of his theories are untenable; but the correct ideas which he was the first to enunciate have since borne fruit. For instance, he was the first to clearly explain the grounds for supposing that infectious matter could not be gaseous.

In 1884, in spite of failing health, he succeeded in completing the great work of his life on the doctrine of descent, the 'Mechanisch-physiologische Theorie der Abstammungslehre,' which will ever remain as a monument to his powers as a scientific thinker. Naegeli's principles differed widely from those of Darwin. Natural selection he was only able to recognize as a means for the removal of unsuitable forms. The production of new forms he ascribed to the principle of progression existing in the organism. To the microscopist our deceased Honorary Fellow was best known by the work on the Microscope which he published in conjunction with Prof. Schwendener, and which has passed through three editions in Germany and was translated into English. In the winter of 1889-90 Naegeli was prostrated by an attack of influenza, but recovered so far as to be able to go to the Riviera in the following winter. He died somewhat suddenly in May last.

List of all Patents for Improving the Microscope issued in the United States from 1853 to 1890.*—The following list is of interest:—

- 1853. H. De Riomonde: Oscope. No. 9581.
- 1861. R. P. Dagron: Photo charm. No. 33,031.
- 1862. H. Craig: Charm. No. 34,409.
- 1864. J. Ellis: Seed Microscope. No. 42,843.
- 1865. Wales: Plain movable front to lens. No. 46,511.
- 1865. J. J. Bausch: No. 47,382.
- 1865. C. B. Richards: Friction wheels on rack motion. No. 47,860.
- 1866. H. L. Smith: Side reflector above objective. No. 52,901.
- 1866. Heath: Combined Microscope, telescope, and eye-glass. No. 54,542.
- 1866. R. B. Tolles: Binocular eye-piece. No. 56,125.
- 1866. O. N. Chase: Seed glass. No. 56,178.
- 1869. J. H. Logan: Dissecting Microscope. No. 93,895.
- 1874. J. J. Bausch: Botanical Microscope. No. 151,746.
- 1876. Wales' pillar fine-adjustment. No. 178,391.
- 1876. J. Zentmayer: Fine-adjustment carrying rack, swinging substage. No. 181,120.
- 1876. Gundlach: Fine-adjustment. No. 182,919.
- 1877. Gundlach: Glass stage, sliding carrier. No. 198,607.
- 1878. R. B. Tolles: Sector illuminator. No. 198,782.
- 1878. R. B. Tolles: Swinging illumination tube. No. 198,783.
- 1878. J. J. Bausch: Convex base to stand. No. 199,015.
- 1879. Gundlach: Pillar tube. No. 211,507.
- 1879. Gundlach: Eye-piece of field lens and triplet. No. 212,132.
- 1879. H. G. Deal: Cloth-counter for bolting cloth. No. 214,283.
- 1879. W. H. Bulloch: Swinging substage loose from mirror. No. 215,878.

* Amer. Mon. Mier. Journ., xi. (1890) pp. 280-1.

1879. Gundlach: Triplets as one element of lens combination. No. 222,132.
1880. W. H. Bulloch: Scroll turntable. No. 226,648.
1880. Molera and Cobrian: Binocular. No. 230,320.
1880. E. Bausch: Folding Microscope. No. 230,688.
1880. J. W. Sidlo: Cog-wheel turntable. No. 235,030.
1882. Lomb and Bausch: Trichinoscope. No. 251,721.
1882. P. H. Yawman: Differential screw fine-adjustment. No. 262,634.
1883. Foster: Socket. No. 270,296.
1883. W. J. McCausland: Magnifier for telegraph. No. 270,907.
1883. F. B. Gould: Microphotographs. No. 271,838.
1883. L. McIntosh: Pin arm. No. 273,752.
1883. E. Bausch: Electric light and Microscope. No. 277,869.
1883. W. H. Bulloch: Bayonet-catch nose-piece. No. 287,904.
1883. D. Tetlow: Bottle seed Microscope. No. 287,978.
1884. E. Bausch: Swinging Wenham prism. No. 293,217.
1884. W. K. Kidder: Electric spark device for Microscope. No. 295,770.
1885. E. Bausch: Microtome. No. 325,722.
1885. E. Bausch: Sheet-metal flanges to tubes. No. 328,277.
1886. G. Fasoldt: Spring nose-piece. No. 334,009.
1886. G. Klippert: Turntable. No. 334,530.
1886. G. W. Palmer: Bevelled slides. No. 336,257.
1886. B. F. Allen: Stand. No. 352,639.
1886. E. H. Griffith: Turntable. No. 354,130.
1889. S. Frost: Botanical Microscope. No. 407,192.

Newspaper Science.*—"One of the latest specimens is furnished by the *Globe-Democrat*, of this city, which a few Sundays ago printed the following:—

'Charles X. Dalton, instrument-maker, says R. B. Tolles, of Boston, now dead, was the greatest maker of Microscope lenses the world has ever seen. He once made an object-glass that magnified 7500 times. It was the first and only one ever constructed, and was made as the result of a long controversy with other microscopists in regard to the possibility of resolving what was known as Nobert's nineteenth band. Nobert was a Frenchman, who, by mechanical appliances, ruled on glass parallel lines at the rate of about 100,000 to the inch. No Microscope lens then made was sufficiently powerful to count these lines. Mr. Tolles, as a result of statements made during the controversy, started to make an objective that should magnify 7500 times. This he succeeded in doing somewhere about 1874. This objective was 1/75 in. in diameter, and is about as large as the hole made in a sheet of paper by the point of a very fine needle. This lens was afterwards sold to Major Woodward, in the Government employ at Washington, but his bill was not allowed by the auditor, and the lens was taken off his hands by one Dr. Harriman. In turn he sold it to Dr. Ephraim Cutter, in whose possession it now is. Objectives that magnify 5000 times are rare, and it is a powerful Microscope that magnifies even 2500 times. These

* National Druggist (St. Louis), xix. (1891) p. 25.

are necessary in bacteriological research, and in testing blood-corpuscles to determine, for instance, whether they are of human blood or not. A local paper recently told of a Boston physician who examined the tubercle bacillus with a powerful glass that magnified 900 times. Ridiculous! You can't see the consumption bacillus with an objective that magnifies less than 1200 times. England is the great rival of this country in Microscope-making. France and Germany are behind. I suppose that sometime an objective will be made that will magnify 10,000 times, but it will be a much more difficult task than the making of a telescope glass five feet in diameter.'

"While no one will deny that Robert B. Tolles was one of the greatest lens-makers that the world ever saw, there are a great many who would hesitate to place him above his great contemporary and teacher, Charles A. Spencer, of Canastota, N.Y. Neither of them, however, ever 'made an object-glass that magnified 7500 times.' To do this would require the manufacture of an objective with a focal length of $1/750$ in., which, it is needless to say, has never yet been attempted. Nobert's 'nineteenth band' contains 112,595 lines to the inch (estimating the Paris line at $0.088.813.783$ in.). The Tolles 'seventy-fifth' was not ' $1/75$ in. in diameter,' but the combination had a theoretical focal length of $1/75$ in. When used with a 1-in. ocular and with a 10-in. tube-length the combination would give an amplifying power of about 7500.

'Objectives that magnify 5000 times are rare.' We should say so—and likely to remain so, since to make one would require the construction of a combination with a theoretical focal length of $1/500$ in. The balance of this sentence shows that Mr. Dalton (or the reporter) confuses the Microscope (here the combination of eye-piece and objective) with the objective alone.

The statement regarding the visibility of bacillus tuberculi is not less misleading than the balance of the farrago. Bacillus tuberculi can easily be seen and recognized with a $1/5$ -in. objective and a 2-in. ocular, or, roughly, with an amplification of 250. With twice this amplification (i. e. 500) it becomes a very conspicuous object. In fact, the writer rarely uses amplification over 500 in making examinations for tubercle bacilli, his favourite combination being a 2-in. ocular and $1/10$ -in. objective."

β. Technique.*

(1) Collecting Objects, including Culture Processes.

Preparation of Nutrient Media.†—Dr. N. K. Schultz finds that really good bouillon agar and gelatin can be obtained by attending to several details which in practice are highly important. He recommends that the precipitates formed during the preparation of the medium should be removed separately, because each precipitate has its own special properties. The reaction of the medium should be determined by titration since neutralization cannot be accurately ascertained by

* This subdivision contains (1) Collecting Objects, including Culture Processes; (2) Preparing Objects; (3) Cutting, including Imbedding and Microtomes. (4) Staining and Injecting; (5) Mounting, including slides, preservative fluids, &c.; (6) Miscellaneous. † Centrabl. f. Bakteriöl. u. Parasitenk., x. (1891) pp. 52-64.

means of litmus paper. This is quite a simple process, and merely consists in adding a drop of phenolphthalein to 1 ccm. of bouillon, and then dropping in 0.4 per cent. caustic soda solution until a pale rose colour appears. Phenolphthalein is a greyish-yellow powder, and dissolved in alcohol (1 to 300) is almost colourless, but on the addition of an alkali turns dark red. This sensitiveness to alkalies renders it a convenient reagent for measuring the amount of alkalinity of nutrient media.

Bouillon should be neutralized before either agar or gelatin is added. Agar requires to be boiled for quite a long time before it is completely dissolved, while gelatin should only be boiled for a very short time.

Preserving Malaria-Plasmodia alive in Leeches.*—Dr. N. Sacharow finds that leeches (*Hirudo medicinalis*) may be used for keeping alive the plasmodia of malaria. The leeches were frozen in a piece of ice and kept in an ice-cellar for a week, the plasmodia being found at the expiration of this time quite unchanged. Their mobility was even greater than when taken directly from the blood of a patient suffering from malaria, though their form was somewhat altered and their size diminished.

Cultivating Spirillum Obermeieri in Leeches.†—Dr. Th. Pasternacki gives the result of fourteen observations made by means of leeches on *Spirillum Obermeieri*, from which it seems that this micro-organism is very resistant to low temperatures. The leeches were filled with blood from cases of relapsing fever, and a drop of blood was obtained for microscopical examination by placing some salt crystals on their tails: this caused the leech to evacuate a drop of blood on a cover-glass placed ready for the purpose.

Directly after sucking the relapsing fever blood the leeches were exposed for various lengths of time to temperatures varying from 0°–40°, and then if alive, a specimen of the blood was obtained in the manner described.

New Cultivation Medium for Bacteria.‡—Dr. P. Kaufmann states that he has obtained very favourable results from the use of jequirity as a cultivation medium. The solution is prepared in the following manner:—10 grms. of jequirity seeds are pounded in a mortar to remove the husks, and this reduces the weight to about 8 grms. The 8 grms. are then boiled in a steam sterilizer with 100 ccm. water for two hours, and when cold filtered. The fluid thus obtained is of a yellow colour, with a neutral or very slightly alkaline reaction, and after sterilizing in the usual manner, can be used without further addition or treatment as a medium for cultivating bacteria.

From their behaviour to the jequirity solution the bacteria were divisible into three classes:—(1) in which the colour remained unchanged; (2) in which it was discharged; (3) in which a green colour was produced. A further examination showed that the green cultures had an alkaline

* Wracz, 1890, pp. 644–5. See *Centralbl. f. Bakteriol. u. Parasitenk.*, x. (1891) p. 199.

† Wracz, 1890, p. 297. See *Centralbl. f. Bakteriol. u. Parasitenk.*, x. (1891) pp. 198–9.

‡ *Centralbl. f. Bakteriol. u. Parasitenk.*, x. (1891) pp. 65–9.

reaction, and those in which the colour was discharged an acid one. This was confirmed by chemical experiment, for by adding an alkali the solution became green, while the addition of acids removed this colour. In this jequirity solution, therefore, there exists a means of distinguishing between bacteria which form acids and those which form alkalis.

The results of the addition of various substances, agar, gelatin, pepton, glycerin, alone or in combination and with neutral or alkaline reaction are exhibited in two tables. The most favourable results seem to have been obtained from the simple solution of jequirity with neutral reaction, and from an alkaline solution to which 2 per cent. of pepton had been added.

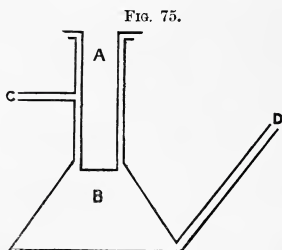

Reichel's Apparatus for Filtering Fluids containing Bacteria.*

—Herr Reichel describes an apparatus which he has devised for filtering fluids, and which is expressly intended for bacteriological work. It consists of a glass vessel somewhat resembling an inverted funnel. The body B is intended for the receiver, while from the bottom projects upwards

the tube D, and from the neck the exhaust-tube C. Into the neck fits the porcelain filter A. The tube D is intended for the evacuation of the filtrate or removal of small portions for test purposes. When in use, the air is exhausted by means of an air-pump attached at C, the orifices at A being carefully plugged with cotton-wool.

Organisms of Nitrification and their Cultivation.†—M. Winogradsky, who at one time ascribed the nitrifying faculty to a single species of bacteria called *Nitromonas*, has by later investigations satisfied himself that morphological differences exist in these organisms, and they are now classed together in a group of "Nitrobacteria," the common characteristic of which is the oxidation of the ammoniacal nitrogen. The bacteria were cultivated on the following medium, devised by Kühne,‡ and modified by the author:—Commercial silicate of soda is diluted with thrice its volume of water, and then 100 ccm. is thoroughly mixed with 50 ccm. of dilute hydrochloric acid. The mixture is dialysed for 24 hours in running water, and then for two days in distilled water frequently renewed. The dialysis is completed when the fluid remains quite clear on addition of silver nitrate. The solution may now be sterilized by boiling, and preserved in flasks closed with cotton-wool.

The second solution is composed as follows:—Ammonia sulphate, 0·4; magnesium sulphate, 0·05; potassium phosphate, 0·1; calcium chloride, trace; sodium carbonate, 0·6–0·9; distilled water, 100. The sulphates and chloride are dissolved and sterilized together, as also are

* SB. Phys.-Med. Gesellsch. zu Würzburg, 1891, pp. 44–7 (1 fig.).

† Ann. de l'Inst. Pasteur, 1891, p. 92. See Centralbl. f. Bakteriol. u. Parasitenk., ix. (1891) pp. 603–5.

‡ See this Journal, ante, p. 130.

the phosphate and carbonate, and the two solutions mixed after cooling.

The next thing is to evaporate down to about one-half the silica solution in a flask until 2-3 drops set within five minutes when a drop of the salt solution is added. Ten to fifteen minutes suffice to render it firm enough to stand being scratched across. When this degree of concentration is reached the evaporation is suspended and the silica solution is pipetted into glass capsules. It is then set by adding to it one-half or one-third its volume of the salt solution, according to the degree of consistence required. The two constituents must be well mixed, and in a few minutes a slight opalescence will denote that coagulation has set in.

The material to be tested may be inoculated by mixing it with the salt solution or scratching it over the medium when solidified. For sodium carbonate magnesium carbonate may be substituted; although this impairs the transparency, it renders the colonies more evident, since this carbonate is dissolved from round about the colonies. The deep-lying colonies of the nitrobacteria are very small, while the superficial ones form a pretty thick crust along the course of the inoculation track.

Nitrobacteria may be obtained by direct inoculation of the earth, but it is better to set up nitrification in a watery saline solution by means of a bit of earth and then to transfer some of this to the solid medium. In this way are developed colonies consisting almost exclusively of nitro-bacteria, and that they do form nitrate is easily ascertainable by the nitric acid reaction with diphenylamin.

A Colony-counter.* —

Mr. J. E. Line writes:—

“In the study of the comparative biology of water-supplies, sewage, infusions, secretions, &c., it is necessary to fix the organisms in a nutrient medium, cultivate them to a given limit, and make a count. To do this neatly and effectively two pieces of apparatus are requisite—an Esmarch tube and a colony-counter. Glass plates and a linen-prover have been made use of, but

for the more accurate results other and better means are called for. The Esmarch tube is simply a test-tube evenly coated internally with a solid sterilized nutrient medium—agar-agar, gelatin, combinations of

FIG. 76.

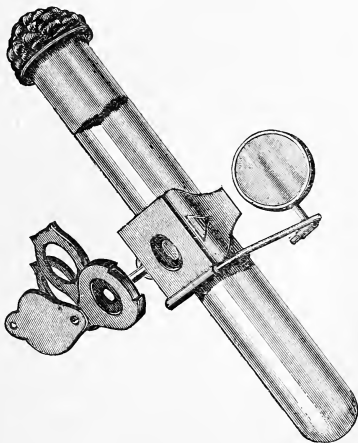

* The Microscope, xi. (1891) pp. 179-80.

the two, &c.—and stopped with cotton. The coating is done by pouring into the tube a quantity of medium, tipping and turning the same until no part of the surface remains untouched, except, of course, that in the immediate vicinity of the cotton stopper. When the medium has thus been evenly spread, the tube is immersed to the neck in ice-water, and then stored for future use. Some roll the tubes on ice, but the medium sets and hardens unevenly, in lumps, ridges, &c.—a condition of things likely to vitiate the count. In making a comparative determination a series of tubes are taken, a given quantity of the material under examination put into each one, “swashed” about and the surplus thrown out, or by means of gentle heat (not, however, always advisable) incorporated with the medium. At the end of a given number of hours or days a count is made, the count repeated at intervals, the results recorded, and, if it is desired to experiment further, a cultivation begun.

At this stage of the examination the counter (fig. 76) comes into play. It is simply a small Microscope adapted to tube examinations, and consists of a modification of a brass knife-clamp that grasps the tube, holding it firmly to the under side of the stage, the opening in which contains a cover-glass divided into square millimetres, or, in a more recent and better form, an opening in the stage 1×4 mm., and the greater diameter running lengthwise with the tube. The optical part is an “Excelsior” triplet, the lenses of which can be used separately or in combination; the adjustment is frictional. The substage has universal movements, and may be readily detached if window or lamp-light is preferred direct. The Bausch and Lomb Optical Company make the instrument.”

Filtration and Sterilization of Organic Fluids by means of liquid carbonic acid.*—M. A. d'Arsonval describes a quite simple instrument for the cold-filtering and sterilizing of liquids containing colloid or albuminoid substances. A wrought-iron bottle filled with liquid carbonic acid is connected by means of a narrow tube with a steel or copper cylinder which is to receive the fluid to be filtered. The receiver of course contains a porcelain filter, and this is easily removable for the purpose of cleaning or sterilizing.

In practice the pressure used is about 45 atmospheres, and this is found to be quite as efficacious in many cases as sterilizing by heat.

The effect of this method may be increased by combining a temperature of 40° with the pressure, and, by certain modifications, cultivations may be attenuated or their development retarded.

The author noticed that the richness of the filtrate in colloid substances was in close relation to the pressure, and that in mixtures containing various ferments, for example, pancreatic fluid, the action of the fluids obtained by filtration varied with the different pressures.

D'Arsonval's Apparatus for maintaining a Fixed Temperature.†—M. A. d'Arsonval has invented a new thermostat, the temperature of which is regulated by quite a new device. The apparatus, intended chiefly for embryological and cultivation purposes, consists of a double-walled case, the interior of which is filled with water. At the middle

* Comptes Rendus, cxii. (1891) pp. 667-9 (1 fig.).

† Arch. de Physiol. Norm. et Pathol., ii. (1890) pp. 83-8. See Zeitschr. f. Wiss. Mikr., viii. (1891) pp. 102-4.

of its bottom is a folded metal plate similar to those in aneroid barometers, and under this a sort of box, into which the gas passes through a tube. From this the gas passes by two tubes, one on either side, to a couple of burners. The heat from these burners passes up through the water through two metal tubes or chimneys. When heated, the excess of water passes out through an opening in the middle of the top, and when the desired temperature is attained the aperture is closed with a caoutchouc plug, into which fits a long glass tube open at both ends. Further expansion of the water causes it to ascend in the tube, and also to press on the metal plate, and as the latter descends it presses on the central gas-pipe, and thus stops off the superfluous access of gas. In this way the temperature of the thermostat remains quite constant. An additional power of regulating the supply of gas is obtained by means of a screw fitted to the pipe, by which it is brought nearer to the flexible metal plate.

The author describes other apparatus constructed on a similar principle.

(2) Preparing Objects.

Examination of Embryonic Liver.*—In his study of the liver of the embryos of mammals Dr. O. Van der Stricht examined fresh tissue in serum and in different fluids; teasing was effected in an aqueous solution of 1 per cent. sublimate, 1 per cent. osmic acid, or Flemming's liquid, and the elements stained with a dilute solution of safranin, methyl-green, or gentian-violet. Fixing was effected with an aqueous solution of 2 per cent. sublimate, either pure or with the addition of a little chloride of sodium, with Flemming's liquid, either pure or with an equal part of water, or with Hermann's liquid; of these Flemming's was found to be the best. The best colouring agents were safranin, gentian-violet, or Ehrlich's violet. The finest preparations were obtained by using safranin and gentian-violet simultaneously. Imbedding in celloidin was found to be preferable to the use of paraffin.

Preparation of Wing-muscles of Insects.†—Prof. E. A. Schäfer cuts open a suitable insect and places it in alcohol of about 90 per cent. for twenty-four hours or more; it is afterwards transferred into glycerin, when the sarcostyles of the wing-muscles can be isolated and examined without difficulty. When stained, as with hæmatoxylin, the dark bands take the staining most intensely, but the various parts of the sarcostyle differ in their behaviour to staining reagents. A very valuable method is to apply the gold-formic method to the tissue when taken from the glycerin. If fresh muscle be so treated the sarcoplasm alone is stained, but if the alcohol-glycerin muscle be taken, the reduction of the metal takes place in the sarcostyles and almost exclusively in their dark bands. By these means there may be brought out, with a clearness which renders the application of the photographic method comparatively easy, points of structure which, with our present usual methods of investigation, have remained obscure.

* Arch. de Biol., xi. (1891) pp. 41-2.

† Proc. Roy. Soc. Lond., xlix. (1891) pp. 280-1.

Preparation of Nervous System of Hirudinea.*—Dr. E. Rohde investigated the nervous system of *Aulostomum* by means of teased preparations as well as of sections. The latter were generally prepared after hardening in sublimate; the living animals were forcibly extended and fixed in a small vessel containing wax; an opening was made along the dorsal middle line; the worms were covered with a one to two per cent. solution of sublimate and left for several hours. After this was removed they were gradually put into strong alcohol. Only after they had been for a day in 80 per cent. of alcohol was the nervous system taken out, stained, and imbedded in paraffin. The author strongly recommends this method. Of *Pontobdella* serial sections only were made. Mayer's alcoholic carmine solution is highly praised as a staining reagent, but Golgi's method is found to be useless for Invertebrata. The sections were generally 1/200 mm. thick, but for the recognition of the finest structural relations much more delicate sections were necessary. The sections were always put in glycerin; resinous media are to be avoided as they make the preparations too transparent for very fine work.

Mayer's picric glycerin mixture was found to be of no use, but salt solution was useful.

Mode of Investigating Sipunculus nudus.†—Mr. H. B. Ward attempted to kill his specimens in such a way as to prevent distortion and to preserve well the tissues; the thick impermeable cuticle and the wealth of muscular tissue made the operation one of some difficulty.

Specimens were allowed to remain for some time in clear sea-water so as to get rid of adhering sand; they were then brought into a shallow dish of sea-water, and 5 per cent. alcohol was allowed to flow gently over the surface; the spirit must be allowed to disseminate gradually. Narcosis varies with individuals, but supervenes in from four to eight hours. When the animals make no contractions on being gently probed with a dull instrument they may be regarded as sufficiently stupefied, and be transferred to 50 per cent. alcohol. After a short stay in this the introvert was cut off, and alone subjected to stronger alcohol. Material thus preserved may be well stained by all methods.

Development of Hydra.‡—Dr. A. Brauer, in his study of the development of *Hydra*, preserved the shell-less eggs chiefly in Flemming's solution, and those that retained their shells by treatment with hot corrosive sublimate. The yolk-granules were distinguished from the nuclei by double-staining with borax-carmine and malachite-green; and, later, as the nuclear stain was found to be too faint, shell-bearing eggs were alone so treated, and the others were put for twelve hours in Grenacher's hæmatoxylin and washed with acid alcohol. Paraffin was used as the imbedding material; for sections the older shelled ova alone gave difficulty; for these Heider's mastic-solution was used.

Study of Karyokinesis in Paramœcium.§—In the study of *Paramœcium*, Prof. R. Hertwig made use of picro-acetic acid, chromic

* Zool. Beiträge, iii. (1891) pp. 1-3 and 49-51.

† Bull. Mus. Comp. Zool., xxi. (1891) pp. 144-5.

‡ Zeitschr. f. Wiss. Zool., lii. (1891) p. 170.

§ Abh. d. K. Bayer. Akad. d. Wiss., ii. Cl., xvii. Bd., i. Abth. (1889) pp. 4-5.

See Amer. Nat., xxx. (1891) p. 87.

acid, and chrom-osmic acid, as hardening reagents. Picro-acetic acid followed by borax-carminé was the principal method. The staining process was aided by the heat of an incubator, and decoloration was effected by alcohol acidulated with hydrochloric acid. The preparation was mounted in glycerin or in clove-oil. Clove-oil is preferable to balsam, as it reveals more clearly the fibrous structure of the spindle, and allows of turning and pressing of the object at any time.

Clove-oil causes the cytoplasm to become brittle, so that the body of the infusorian may be broken up by pressure or blows on the cover-glass, and thus the nuclear spindles be set completely free. In this isolated condition they can be studied to the best advantage, as they are not obscured by overlying cytoplasm. For the study of the chromatic figures clove-oil is too strong a clarifying medium. Glycerin or water will serve better. Hertwig examined the preparation first in clove-oil, then isolated the nuclear figures, washed in alcohol, and mounted in glycerin. He was thus able to study all parts and figures under most favourable conditions.

Method of Narcotizing Hydroids, Actiniæ, &c.*—Mr. H. B. Ward writes:—"In order to kill Hydroids, Actiniæ, and similar forms in an expanded condition, a little expedient may be recommended which the writer has tried in many places and on many forms, and has uniformly found of value. The animals to be killed are left in a small quantity of the salt water in which they were brought in, until this becomes rather warm and stale, or until, in fact, they are weakened by the narcotizing effect of impure water. This manifests itself in one or two ways; some forms draw themselves completely together, while others hang half expanded and limp in the water. They are then transferred in colonies or in large groups into [a] fresh [quantity of] salt water, which is at the same time cool. The effect of a mass of cool, pure water is such as to cause the animals to expand fully and promptly. Immediately as the expansion is seen to reach its maximum, in the course usually of a few seconds, they are transferred by a quick motion into some rapid-killing reagent. After the long narcosis in poor water the polyps appear to lack energy to contract forcibly, as is usually the case. As killing reagents, alcoholic corrosive sublimate and picro-nitric acid have given the most uniformly good results. In this way the most susceptible Actiniæ may be easily preserved expanded and intact, and hydroids of all genera yield good specimens. The transfer to fresh sea-water is the only point requiring care. No time limit can be given, as the factors are too variable, but a little practice is sure to show the character and advantages of the method."

Method for Demonstrating the Formation of Acids by Micro-organisms.†—Herr M. W. Beyerinck describes a method for showing the acidity or alkalinity of the products of micro-organisms.

It consists in mixing a suitable medium, and one which will set well with very fine whiting, and then pouring the mixture into a glass capsule. The nutrient layer thus made is opaque and milky white. As coagulation media, gelatin, agar, or silicate may be employed. To

* Amer. Nat., xxv. (1891) pp. 398-9.

† Centrabl. f. Bakteriöl. u. Parasitenk., ix. (1891) pp. 781-6 (1 fig.).

exemplify his method, the author gives in detail the procedure for demonstrating the presence of lactic acid bacteria and for isolating them from fermenting maize. 20 grms. gelatin (or 3/4 gm. agar) are dissolved in yeast-water made by boiling 8 grms. yeast in 100 ccm. tap water. 5-10 grms. glucose are then added, and the mixture having been boiled again, it is filtered, and a few drops of whiting and water added. It is then poured into glass capsules, so that the layer at the bottom is about 1 mm. thick.

The micro-organisms are obtained by shaking a drop of fermenting maize up in a flask of boiled water and then pouring the infected water over the chalked medium. The water is then poured off, but sufficient adheres to inoculate the medium.

As the colonies develop their immediate vicinity clears up, owing to the acid produced by the micro-organisms, and these transparent areas are visible even to the naked eye.

In addition to whiting, the medium may be mixed with carbonates of magnesium, barium, strontium, manganese, zinc. The mixture of zinc carbonate appears to be very suitable for lactic acid bacteria.

Besides indicating the production of acid, this method may be used for demonstrating the formation of alkalies. In the illustration given by the author of his apparatus, this production of alkali by an organism is shown by its power of neutralizing the acidity resulting from an acid-forming bacterium in an adjacent colony.

Demonstration of Suppuration-Cocci in the Blood as an aid to Diagnosis.*—Baron A. von Eiselsberg describes four cases in which the original diagnosis was confirmed by a bacteriological examination of the blood. In all four cases suppuration cocci were cultivated from the blood (*Streptococcus pyogenes*, *Staphylococcus pyogenes albus*, and twice *Staphylococcus pyogenes aureus*).

Examination of the blood in five cases of laparotomy where the symptoms soon after the operation were unsatisfactory, failed to show micro-organisms—a result confirmed by the subsequent satisfactory issue of all the cases. In three cases of phlegmon, one of acute osteomyelitis, and four of septic peritonitis, the cocci could only be demonstrated in three instances—a result which is explained by supposing that in certain cases of sepsis the phenomena are due to the absorption of certain chemical matters from the original inflammatory focus. Moreover, it must be remembered that as the cocci are only sparsely present in circulating blood, catching a visible germ in any given drop of blood is not a matter of certainty.

At any rate the author's recommendation that the bacteriological examination of blood should be undertaken as a supplementary aid to diagnosis is a good one, for while negative results only leave the matter in the *status quo ante*, a positive result is extremely valuable.

On a Method of Preparing Vegetable and Animal Tissues for Paraffin Imbedding, with a few Remarks as to Mounting Sections.†—Mr. Gustav Mann writes:—"Requisites"—I. Picro-corrosive alcohol.

* Wiener Klin. Wochenschr., 1890, p. 731. See Centralbl. f. Bakteriol. u. Parasitenk., ix. (1891) p. 834.

† Trans. and Proc. Bot. Soc. Edinb., xviii. (1890) pp. 432-5.

Heat absolute alcohol to 50° C., saturate with picric acid, and then add bichloride of mercury to saturation. When cool decant. This solution may be made in quantity and kept. II. Absolute alcohol. III. Chloroform-alcohol—chloroform and absolute alcohol mixed in equal parts. IV. Chloroform. V. Solid paraffin, melting-point 46°–50° C. VI. Short wide-mouthed bottles. VII. Best cork stoppers, two for each bottle; the one fitted with a piece of glass tubing 1 cm. in diameter and 3 cm. long. VIII. Number of glass rods drawn out into fine points, as one must avoid bringing metal instruments in contact with the picro-corrosive fluid.

Method—A. The fixing and hardening of tissues.—Place tissue in at least fifty times its bulk of the picro-corrosive alcohol. Leave small objects (up to 1 cubic cm.) for twenty-four hours, larger objects for forty-eight hours and upwards in the fluid. Keep the bottle well corked.

B. The replacement of the picro-corrosive alcohol by pure absolute alcohol.—1. Pour off the hardening fluid till the tissue is just covered. Add absolute alcohol according to the size of the tissue in 1–10 drops every ten minutes, till the tissue is again in fifty times its bulk of fluid. After each addition move the bottle very gently to allow the added alcohol to mix with the hardening fluid. Leave tissue in this diluted mixture for twenty-four hours. In no case should this process be hurried, or strong diffusion currents will be set up, and the protoplasmic contents of the cell separate from the cell-wall. 2. Pour off the fluid till the tissue is just covered, and add absolute alcohol up to the original bulk. Move about the bottle gently every three or four hours. Most of the picro-corrosive material will thus be extracted after twenty-four hours. 3. Draw the fluid rapidly off by means of a pipette, and add absolute alcohol up to half of the original bulk. Any drying of the tissue must be carefully guarded against. Leave for twenty-four hours, and repeat the process.

C. The replacement of the alcohol by chloroform.—1. Pass, by means of a pipette, the chloroform-alcohol mixture to the bottom of the vessel, when the tissue will float on the mixture. Remove then the superfluous alcohol by a pipette, leaving only enough to cover the tissue. 2. When the tissue has sunk in the chloroform-alcohol mixture, introduce by a pipette pure chloroform, on which the tissue will float; the fluid above the tissue is removed by a pipette. After twenty-four hours the tissue may or may not have sunk in the chloroform; if not, it may be induced to do so by heating the chloroform to 20° C. (not higher); if this fail, a little sulphuric ether may be added. After the tissue has sunk, leave for twenty-four hours. 3. Place a fresh supply of chloroform at the bottom of the vessel (50 times the bulk of the tissue), and if there is a distinct line of demarcation between the newly-added and the old chloroform, the upper layer should be removed by a pipette.

D. The replacement of chloroform by paraffin.—1. Place the tissue in a warm chamber heated to 25° C.; add solid paraffin in pieces up to the size of a small pea. After each piece has dissolved, the bottle has to be moved about very gently to hasten the mixing of the paraffin, which will be in the upper layers, with the chloroform. Continue till no more paraffin dissolves. Tissue which did not sink in pure chloro-

form will always sink as soon as paraffin is added. 2. Place the tissue in a warm chamber heated to 30° C. for twenty-four hours. 3. Place the tissue in a warm chamber heated to the melting-point of the paraffin (46° C.), and after six hours replace the ordinary cork stopper (which up to this stage has always to be employed) by a perforated one. This method is adopted to ensure a gradual giving off of the chloroform, for I find that, if the latter be driven off rapidly, a good deal of shrinkage always results. When all the chloroform has evaporated, i. e. if after shaking the bottle gently one is unable to detect by smelling the faintest trace of chloroform, then the tissue is ready for sectioning. If the bottle be not shaken gently before smelling the solution, it is often impossible to detect chloroform, although a large quantity of the latter is still in the lower layers of the paraffin, as the upper layers part more readily with the chloroform. 4. The tissues should not be exposed longer than just necessary to the temperature of melted paraffin, but should be imbedded by means of Leuckart's type-metal box, or by two L-shaped pieces of metal running in an oblong box, the breadth of which corresponds to the short limb of the L. The metal boxes should be warmed and filled with melted paraffin. After five to twenty seconds, when the paraffin at the bottom of the box has solidified, the tissue is removed from the bottle by a copper lifter, and, without being allowed to cool, it is dropped into the imbedding box, put into any desired position by means of hot needles, and the paraffin cooled very gradually. It is best not to touch the tissue with any instrument till it is ready to be placed in the imbedding box, and also to avoid heating the copper lifter or the needles too much. Tissues thus imbedded may be kept unchanged for any length of time.

To get perfectly satisfactory results, the tissue we are treating must be living; smaller vegetable objects, as flower-buds, ovaries, growing apices, &c., must be dropped into the fluid as soon as separated from the plant, and animals like tadpoles, worms, and larvæ are placed directly into the fluid, where they are killed rapidly and in an extended position. Tissues of plants and animals must be placed in the fluid as soon as separated by dissection. Tissues of warm-blooded animals should be placed in the micro-corrosive alcohol of corresponding warmth. Treating tissues like brain, it is best to place into the bottom of the vessel a pad of cotton-wool or felt to allow the hardening fluid to penetrate readily; the pad must be removed before the chloroform-alcohol is placed below the tissue. My method was found to give very satisfactory results with plasmodia of myxomycetes, growing apices, developing endosperm, stem and leaf structures, human foetal brain, frog's cartilage, muscle, myxomatous tissue, retina, tadpoles, wasp larvæ, caterpillars, &c. Karyokinetic figures are specially well fixed, and show the minutest details.

Now a few words as to mounting sections. Sections cut in ribbons (I use the Cambridge rocking microtome) are fixed to a slide by Schällibaum's method, thus:—An even layer of the fixing material is spread on the slide, the slide heated to 30° C. (melting-point of paraffin = 46° C.), and a piece of the ribbon gripped by a pair of forceps at one end and quickly laid down on the warm slide. In this way I get the sections to lie perfectly flat, and it is even possible to make a closely coiled-up

ribbon expand with the greatest ease, without causing any further trouble. The slide is next heated above a Bunsen, just enough to melt the paraffin; it is then placed in a vessel containing resinified turpentine, which latter removes the paraffin in a few minutes; the turpentine is removed by absolute alcohol, and the sections stained by any of the current methods, then dehydrated in absolute alcohol, cleared in resinified turpentine, and, lastly, mounted in Canada balsam dissolved in turpentine, as turpentine-balsam has a low refractive index."

(3) Cutting, including Imbedding and Microtomes.

Sharpening Ribbon-Microtome Knives.*—M. J. W. Moll says that the ribbon-microtome is far superior to the sliding microtome, provided that the knife be properly sharpened.

After alluding to the shape of the knife, the form and dimensions of which are figured in his illustrations, the author says the knife is honed on a glass plate, 19 cm. long, 4.5 cm. broad, and the manner of holding the knife is depicted. The first stage consists in sharpening the knife on the dull side of the glass plate with emery and water, and then having washed it, to hone it on the smooth side of the glass, using a little "chaux de Vienne." In this way an edge quite straight and without any serrations is obtained, and a 5 μ thick section perfectly smooth, without a tear and showing no knife-marks, may be cut with certainty.

To preserve Edges of Microtome Knives.†—A writer in the 'Dental Review' says:—"To render instruments perfectly aseptic, and to preserve the cutting edges from oxidation, they should be boiled for five minutes in one per cent. solution of carbonate of sodium. They can remain in this solution indefinitely without rusting or dulling the cutting edge. When required for operation they are taken out, dried with a sterilized piece of gauze, and handed to the operator. Whenever, in course of operation, they come in contact with anything not aseptic, all that is required to resterilize them is to dip them for a few seconds into the boiling solution of sodium bicarbonate."

(4) Staining and Injecting.

Staining of Chlorophyll.‡—For staining the chlorophyll-bands of *Spirogyra*, Mr. G. Mann recommends the following process:—A glass vessel is filled with two litres of water, to which six drops are added of a 10 per cent. solution of cyanin in absolute alcohol. Then a small quantity of either *Spirogyra jugalis* or *S. nitida* is placed in the vessel, which is exposed to bright daylight. After some time, varying with the temperature of the room and the activity of the threads, from 3–24 hours, the whole of the cyanin will have been taken up by the threads. The ground-substance of the chlorophyll-bands will have changed from a green to a bluish-green colour, while the oil-globules and many of the microsomes between the bands will have turned blue, showing their fatty nature. Concentrated solution of alcanna-root, or a

* Botanisch Jaarboek, Gent, 1891, pp. 541–56 (1 pl.).

† Amer. Mon. Micr. Journ., xii. (1891) p. 124.

‡ Trans. and Proc. Bot. Soc. Edinb., xviii. (1889–90) pp. 394–6.

1 per cent. solution of osmic acid, may be used instead of the cyanin, but the results are not so good.

New Application of Safranin.*—Dr. P. Kaufmann says that he has obtained surprising results with the following solution, which stains both the tissue and the micro-organisms, though of different colours, the nuclei being red and the bacteria and fibrin blue. After the preparations have been stained for two to eighteen minutes, they are treated as in Gram's method with the iodo-potassic iodide. The solution, which does not keep very long, and should therefore be freshly made, is composed of the following:—Alcohol 98–100 per cent., 2 grms.; anilin oil, 0·5; aq. destil., 30·0; gentian-violet, 0·25; safranin, 1·25. Or the last three ingredients may be formulated thus:—25 ccm. of aqueous 5 per cent. solution of safranin, 5 ccm. of aqueous 5 per cent. solution of gentian-violet, the anilin-oil and alcohol being afterwards added.

New Syringe for Hypodermic Injection.†—M. Strauss has, by a simple modification of the plug of an ordinary Pravaz syringe rendered its cavity sterilizable by steam, dry air, or boiling. The plug is made of compressed elder-pith, and in case it should become too slack, the metal discs are screwed on to the piston rod, so that the intervening pith may be tightened up.

Colourability of Tubercle Bacilli.‡—M. G. Roux thinks that the reason why tubercle bacilli frequently fail to stain or exhibit such differences in appearance when they are stained is to be sought for in the degeneration of the anilin-oil used as mordant or in the method adopted. After obtaining a perfectly pure and recently made anilin-oil, the preparations of sputum showed numerous deeply-stained bacilli, while those stained with a solution made of old dark-coloured anilin-oil showed scarcely any at all. The author also notes that with Hermann's method the bacilli appear thicker and more numerous than when stained by the anilin-oil or carbolic acid solutions.

Phospho-Molybdic Acid Hæmatoxylin.§—Dr. F. B. Mallory recommends as a useful stain in the study of nerve-tissue a mixture of 1 part 10 per cent. solution of phospho-molybdic acid, 1 part of hæmatoxylin crystals, 6–10 parts of chloral hydrate, and water to 100. Expose to sunlight for a week and filter before using. Discharge excess of stain, which acts in from ten minutes to an hour, with 40–50 per cent. alcohol, changing twice or thrice. Dehydrate and mount as usual. If the solution does not stain deeply, add more hæmatoxylin.

Methods of Differential Nucleolar Staining.||—Mr. Gustav Mann says:—"As far as I am able to ascertain, Guignard ¶ was the first to describe a differential nucleolar stain by a certain mixture of methyl-green and fuchsin, but he does not specify any proportion of admixture,

* Centralbl. f. Bakteriologie u. Parasitenk., ix. (1891) pp. 717–8.

† Le Bulletin Méd., 1891, p. 89. See Centralbl. f. Bakteriologie u. Parasitenk., ix. (1891) p. 737.

‡ La Province Méd., 1891, No. 4, p. 37. See Centralbl. f. Bakteriologie u. Parasitenk., ix. (1891) pp. 678–9. § Anat. Anzeig., vi. (1891) pp. 375–6.

|| Trans. and Proc. Bot. Soc. Edinb., xix. (1891) pp. 46–8.

¶ Ann. Sci. Nat., sér. 6, xx. p. 318.

though he repeatedly mentions the fact of the differentiation. I am unable to follow him in his method, and, notwithstanding many trials, have failed to get his differential stain, namely, the chromatin-elements of the nucleus green and the nucleolus red by means of methyl-green and fuchsin.

While endeavouring to stain the nucleolus and endo-nucleolus differentially, my attention was drawn by Dr. Macfarlane to heliocin as a good nuclear stain for *Spirogyra*. By extending its action in combination with anilin-blue to other tissues, I have succeeded in obtaining an excellent differentiation.

Method.—Tissues, both vegetable and animal, preferably fixed by my micro-corrosive method,* are treated for ten minutes in a saturated solution of heliocin in 50 per cent. alcohol; the sections are then transferred for from five to fifteen minutes to a saturated watery solution of anilin-blue. The superfluous stain is rapidly washed off by distilled water, and the sections placed again for one to two minutes in the heliocin-solution, dehydrated, cleared by resinified turpentine, and mounted in turpentine-balsam.

Effect.—The whole of the cell and the nucleus blue, the nucleolus red. In karyokinetic figures the cell and nuclear barrel are stained blue, the nuclear plate, monaster and diasters stained red.†

The chemical constitution of the heliocin I used I am unable to find out; when dry it is a brick-red powder, readily soluble in water, slightly so in absolute alcohol, and in each case showing no fluorescence. A watery solution is of an orange brick-red colour. My friend Mr. Terras was kind enough to test this heliocin chemically, and found it to act thus: The dye dissolves in concentrated sulphuric acid with a red orange colour, which on boiling becomes dark brown. Water added to the dark brown fluid does not produce any precipitate. Hydrochloric acid added to the solution in water gives no precipitate, and does not change the colour. Zinc-dust added to the acid solution decolorizes it in the cold easily, and the colour does not return on exposure to the air. Strong caustic potash added to the watery solution of the dye produces no change either in the cold or when boiled. Zinc-dust added to the alkaline solution decolorizes it in the cold.

Besides the heliocin just described, another one is in the market, a dark brownish-red powder soluble in water, with a distinct fluorescence, readily soluble in alcohol, and giving the reactions of true eosins.

One should endeavour to get the heliocin first described, for it makes a beautiful contrast with the blue, and allows one to study the finer structure of nucleoli.

Should either of the two heliocins not be obtainable, any of the eosins, or erythrosins, may be substituted, when treating vegetable tissues, while for animal tissues safranin makes a tolerably good substitute.

Another differential stain is got by placing living tissues for at least a week in a saturated picric acid solution of absolute alcohol, to which

* See Trans. Bot. Soc. Edinb., xviii. (1890) p. 432, *et supra*, pp. 686 *et seq.*

† "I may state that in dividing cells of the root of *Nymphæa alba*, we may stain the whole of the cell pink, and the nuclear plate, monasters and diasters blue, by treating sections first with alcoholic eosin and then with alcoholic methylene-blue."

that variety of nigrosin known as alcohol-soluble nigrosin has been added. After-staining the sections with eosin or Kleinenberg's hæmatoxylin causes the nigrosin to be replaced by either dye, leaving only the nucleolus of a greenish-blue colour."

(5) Mounting, including Slides, Preservative Fluids, &c.

Reference Tables for Microscopical Work. III. Cements and Varnishes.*—Prof. A. B. Aubert gives the following list:—

Asphalt varnish:—Asphalt, 450 grm.; linseed oil, 225 grm.; turpentine, 1000 ccm.; or dissolve asphalt in benzol and to the solution add gold size. In the first method, dissolve by the aid of heat; dilute when necessary, with turpentine. Not very reliable as a cement.

Bell's cement:—Probably a solution of shellac, but the exact composition is not known. This in the opinion of many is an excellent cement.

Gold size:—Linseed oil, 25 oz.; red lead, 1 oz.; powdered white lead and yellow ochre, of each a sufficient quantity. Boil the oil and red lead together carefully for three hours; pour off the clear liquid, and boil with a mixture of equal parts of the white lead and yellow ochre added in small successive portions. Let it stand, and pour off the clear liquid for use.

Gram-Rutzon's cement:—Hard Canada balsam, 50 grm.; shellac, 50 grm.; absolute alcohol, 50 grm.; anhydrous ether, 100 grm. The ingredients are mixed, and when the gums are dissolved, filter if necessary, and evaporate, away from the flame, over a water-bath until of a syrupy thickness.

Gutta-percha cement (Harting):—Gutta-percha cut in pieces, 1 part; turpentine, 15 parts; shellac, 1 part. Heat the gutta-percha and turpentine together, filter, add the shellac pulverized, and heat until a drop hardens on a cold glass plate. Used to attach cells; the slide must be warm when using the cement.

Brown cement:—Pure gum rubber, 20 grains; carbon disulphide, a sufficient quantity; shellac, 2 oz.; alcohol, 8 oz. Dissolve the rubber in the smallest possible amount of carbon disulphide, add this slowly to alcohol, avoiding clots; add powdered shellac and place the bottle in boiling water until the shellac is dissolved and no more smell of carbon disulphide is given off.

Guaiacum varnish:—Gum guaiacum, 2 oz.; shellac, 2 oz.; alcohol, 10 oz. The powdered gum guaiacum is dissolved in the alcohol and the powdered shellac added; keep the bottle in hot water until all is dissolved.

Shellac varnish:—1, shellac, 60 grm.; 2, alcohol, 60 grm.; 3, castor oil, 25 grm.; 4, alcoholic solution of anilin dye, a few drops. 1 and 2 are dissolved and heated until quite thick, then a little of 4 is added, and for every 60 grm. of the mixture add 25 grm. of castor oil, and heat for a short time.

Electrical cement:—5 parts of resin; 2 parts of hard balsam; 1 part of yellow beeswax; 1 part of red ochre. The components are melted together.

* Microscope, xi. (1891) pp. 150-2.

This is not usually employed for mounting purposes, but may be used in cementing glass and metal parts of instruments.

Zinc-white cement, German formula:—1, mastic, 10 pts.; 2, dammar, 4 pts.; 3, sandarac, 4 pts.; 4, Venetian turpentine, 1 pt.; 5, turpentine, 20 pts.; 6, benzol, 10 pts.; 7, zinc-white. 1, 2, and 3, powdered are mixed in a well-corked bottle with 4, 5, and 6; shake well occasionally; after several days filter, and triturate in a mortar with zinc-white in quantity sufficient. Dilute if necessary with benzol.

Zinc-white, English formula:—1, gum dammar, 3 pts.; 2, gum mastic, 1 pt.; 3, benzol, 6 pts. Dissolve powdered 1, 2, and 3 in a well-corked bottle; when dissolved filter, and mix carefully in water with zinc-white.

Marine glue:—India-rubber shreds, 2 oz.; shellac, 2 oz. Dissolve the rubber in mineral naphtha, add the powdered shellac, heat until liquefied, and mix well together. This gives solid marine glue, and requires heat in its application. Great care should be observed in having all fire and flame removed while there still remains naphtha in the mixture.

Lovett's cements:—Powdered white lead, 2 parts; powdered red lead, 2 parts; powdered litharge, 3 parts; gold size. The white and red lead and the litharge must be very finely powdered; for use this powder is mixed with gold size to the consistency of cream, and the cells immediately fastened to the slide. They are secure in two weeks. This stands considerable heat, and is excellent for fluids containing some alcohol. Make a little only of the mixture with gold size at a time, as it hardens quite rapidly and becomes useless.

King's cement and lacquer.—Satisfactory, and highly recommended by some.

Brown's rubber cement.—Very good for finishing slides.

Miller's caoutchouc cement.—Sold in England by opticians. It is a most excellent and quickly drying cement.

Hollis's glue.—Somewhat similar to Bell's cement.

Nearly, if not all the foregoing can be most advantageously bought of the opticians and dealers in microscopical material.

(6) Miscellaneous.

Coco-nut-water as a Culture Fluid.*—Mr. G. M. Sternberg points out that the fluid contained in unripe coco-nuts is quite transparent, with a specific gravity of 1.02285. Chemical analysis showed that it was composed of water 95 per cent., ash 0.618 per cent., glucose 3.97 per cent., fat 0.119 per cent., albumen 0.133 per cent. This fluid forms an excellent medium for numerous kinds of micro-organisms. There is no need to sterilize it, if it be removed with the necessary precautions. As its reaction is slightly acid, it must be neutralized before being used for cultivating certain kinds of pathogenic micro-organisms.

* Philad. Med. News, 1890, p. 262. See Centralbl. f. Bakteriol. u. Parasitenk., ix. (1891) p. 834.

PROCEEDINGS OF THE SOCIETY.

The first Conversazione of the Session was held at 20, Hanover Square, on Monday, the 1st December, 1890.

The following objects, &c., were exhibited :—

Mr. J. Badcock :—*Megalotrocha albo-flavicans*.

Pond Life.

Rev. G. Bailey :—Foraminifera from the Red Chalk.

Mr. C. Baker :—Dr. Dallinger's pattern Microscope Lamp.

E. Leitz's Microscope and Microtome.

Photomicrographic Microscope as suggested by Mr. Andrew Pringle.

Portable Limelight Projection Lantern and Slides of Microorganisms.

C. Reichert's Apochromatic Objective 1/3 N.A. ·50.

C. Zeiss's Apochromatic Objective 1/8 N.A. ·95; Microscopes; and Abbe's Achromatic Condenser.

Mr. W. I. Chapman :—*Limnias annulatus*.

Ecistes crystallinus and *intermedius*.

Mr. H. E. Freeman :—Group of Foraminifera from Porto Seguro.

Casts of Foraminifera from Colon.

Mr. J. E. Ingpen :—Contrast in effects in objects mounted in Air, Canada balsam, Oil of Anise, Styra, Piperine, Bisulphide of Carbon, Chloride of Tin, Bromide of Antimony, Phosphorus, Sulphide of Arsenic, and Platina deposit.

Mr. R. Macer :—*Lophopus crystallinus*.

Stephanoceros Eichornii.

Mr. C. J. Martin :—*Megalotrocha albo-flavicans*.

Pond Life.

Mr. A. D. Michael ;—Trans. Sect. of a Mite (*Gamasus terribilis*) showing the whole body filled with Nematoid worms.

Serial Sections of Acarina cut in a Swiss hotel with a common Cathcart microtome and an ordinary shaving-razor.

Mr. E. M. Nelson :—Zeiss's Apochromatic Objective 1/6 N.A. ·95.

Messrs. Powell and Lealand :—*Triceratium favus* with an Apochromatic Oil-immersion 1/12 N.A. 1·40.

Upper valve of *Pleurosigma balticum* with an Apochromatic Oil-immersion 1/8 N.A. 1·40.

Mr. B. W. Priest :—Fossil Sponge, *Cœloptychium agaricoides*.

Mr. A. Pringle :—Photomicrographic Apparatus.

Mr. C. Rousselet :—Pond Life in Winter: Collection of Rotifers obtained from under the ice.

Mr. G. J. Smith :—Chiastolite Schist, Gefrees, Fichtelgebirge.

Granulite, with Kyanite, Saxony.

Ottrelite Schist, Ottrez, Ardennes.

Pikrite, Inchcolm.

Mr. W. T. Suffolk :—Bordered Pits—Deal, 1/4 in.; with spherical Lieberkuhn.

- Mr. J. J. Vezey:—Mucous membrane of Cæcum (human) injected.
 Messrs. Watson & Sons:—New pattern Binocular Microscope.
 Group of Diatomaceæ.
 Section of Eye of Fly (*Tabanus*).
Bacillus anthracis in section of malignant pustule from the cheek
 of a person infected by a cow suffering from Anthrax.
 Leaf of New Zealand Hemp.
 Esophagus of Dog.
 Type-slide of Holothurida.
-

The second Conversazione of the Session was held at 20, Hanover Square, on Thursday, the 30th April, 1891.

The following objects, &c., were exhibited:—

- Mr. J. Badcock:—Freshwater Polyzoa (*Lophopus crystallinus*).
 Mr. C. Baker:—*Navicula rhomboides* in quinidine under Zeiss Apochromatic 1/6 N.A. ·95.
N. Lyra under Reichert's Apochromatic 1/3 N.A. ·50.
 Mr. W. A. Bevington:—Head of Jumping Spider.
 Mr. F. Enock:—Eggs of *Psocus fasciatus* showing parasitic fly (*Alaptus minimus*) *in situ*.
 Eggs of *P. fasciatus* on leaf.
 Mr. J. G. Grenfell:—A new "Diatom" with long branching pseudopodia or filaments, from the Botanical Gardens, Regent's Park.
 A new Freshwater Organism.
 The Symbiosis of *Micrococcus* with a new form of the Flagellata.
 Mr. J. D. Hardy:—An attempt to express a frustule of *Heliopelta* in modelling clay, 9 in. diam. × 1000.
 Mr. A. Howard:—Epithelioma of Human Tongue showing *Trichina spiralis*.
 Mr. W. Johnson:—*Bacillus anthracis* (cultivation).
 Spleen of Guinea-pig, showing *B. anthracis*.
 Lung of Guinea-pig showing *B. anthracis*.
B. tuberculosis (cultivation).
Streptococci Pyogenes (cultivation).
 Lung of Horse showing nodule of *B. tuberculosis*. Prepared by
 Mr. T. N. Davis, M.R.C.V.S.
 Foot and stage of Microscope by Varley (date about 1812).
 Mr. R. Macer:—*Cristatella mucedo*.
Stephanoceros.
 Mr. C. Machins:—*Asplanchna Brightwellii*.
 Mr. J. Mayall, Jr.:—John Marshall's Microscope (*vide* Harris's Lexicon Technicum, 1704).
 Messrs. E. M. Nelson and C. L. Curties:—Projection Microscope exhibiting micro. slides with 70 mm. and AA objectives.
 Mr. J. M. Offord:—*Actinocyclus Barklii*.
 Messrs. Powell and Lealand:—*Rhomboides* in Balsam and *Coscinodiscus asteromphalus*, with an Apochromatic Oil-immersion 1/10 N.A. 1·50 and new dry Apochromatic Condenser.

- Mr. C. F. Rousselet:—*Stephanoceros Eichornii*.
- Mr. T. Ryley:—Plagioclase Felspar; Pitchstone; Gabbro; *Eozoon canadense*.
- Mr. G. F. Smith:—Magma-Basalt (Limburgite), Kaiserstuhl, Baden; Basalt intrusive in carb. limestone, Carlingford; Tachylite, showing arrested development of crystal of Olivine, Schiffenberg, Giessen; Lava of Vesuvius, eruption of 1872 (Augite, Leucite, Plagioclase, &c., in vitreous base); Basalt with selvage of Tachylite, Ardtum Head, Scotland; Basalt with Nickeliferous Iron, Ovifac, Disco Island; Palatinite with twinned Augite, Martinstein, Nahe; Andesite (vitreous), Cheviots.
- Mr. W. T. Suffolk:—Transverse section of Gland on Petiole of *Viburnum Opulus*.
- Mr. J. J. Vezey:—Section of yolk of Egg of the Domestic Fowl.
- Messrs. W. Watson & Sons:—Type-slide of Diatomaceæ from Oamaru.
Gill of Mussel with *Glochidia in situ*.
Type-slide of Sponge-spicules.
Fungus on stem of wheat (*Puccinia graminis*).
Hand of Human Fœtus showing ossification.
Bacillus tuberculosis in sputum.
-

The Journal is issued on the third Wednesday of
February, April, June, August, October, and December.

1891. Part 6.

DECEMBER.

To Non-Fellows,
Price 5s.

6994

JOURNAL

OF THE

JAN 12 1892

ROYAL MICROSCOPICAL SOCIETY;

CONTAINING ITS TRANSACTIONS AND PROCEEDINGS,

AND A SUMMARY OF CURRENT RESEARCHES RELATING TO

ZOOLOGY AND BOTANY

(principally Invertebrata and Cryptogamia),

MICROSCOPY, &c.

Edited by

F. JEFFREY BELL, M.A.,

*One of the Secretaries of the Society
and Professor of Comparative Anatomy and Zoology in King's College;*

WITH THE ASSISTANCE OF THE PUBLICATION COMMITTEE AND

A. W. BENNETT, M.A., B.Sc., F.L.S.,

Lecturer on Botany at St. Thomas's Hospital,

R. G. HEBB, M.A., M.D. (Cantab.), AND

J. ARTHUR THOMSON, M.A.,

Lecturer on Zoology in the School of Medicine,

Edinburgh,

FELLOWS OF THE SOCIETY.



WILLIAMS & NORGATE,

LONDON AND EDINBURGH.

CONTENTS.

TRANSACTIONS OF THE SOCIETY—

PAGE

X.—NOTES OF NEW INFUSORIA FROM THE FRESH WATERS OF THE UNITED STATES. By Dr. Alfred C. Stokes. (Plate X.) ..	698
XI.—ON AN IMPROVED METHOD OF MAKING MICROSCOPICAL MEASUREMENTS WITH THE CAMERA LUCIDA. By Sir Walter Sendall, K.C.M.G., M.A., F.R.M.S. (Figs. 77-80) ..	705

SUMMARY OF CURRENT RESEARCHES.

ZOOLOGY.

A. VERTEBRATA:—Embryology, Histology, and General.

α. Embryology.

HOLL, M.— <i>Maturation of the Egg-Cell of the Fowl</i>	710
FIELD, H. H.— <i>Development of Pronephros and Segmental Duct in Amphibia</i> ..	711
MORGAN, J. H.— <i>Breeding and Embryology of Frogs</i>	712
RYDER, J. A.— <i>Development of Eugystoma</i>	712
HOLT, E. W. L.— <i>Egg and Larvæ of Teleosteans</i>	713
GOLDBERG, M.— <i>Development of Ganglia in the Fowl</i>	713
JANOŠIK, J.— <i>Development of the Genital System</i>	713
VEJDOVSKY, F.— <i>Phenomena of Fertilization</i>	713

β. Histology.

AUERBACH, L.— <i>Difference between the Nuclei of Male and Female Reproductive Elements</i>	714
FLEMING, W.— <i>Structure and Division of the Cell</i>	714
SOLGER, B.— <i>The "Intermediate Body" in Cell-division</i>	715
HERMANN, F.— <i>Origin of the Karyokinetic Spindle</i>	715
HEIDENHAIN, M.— <i>Central Corpuscles and Attraction-Spheres</i>	715
BÜRGER, O.— <i>Attraction-Spheres in Celomic Cells</i>	715
FLEMING, W.— <i>Division of Leucocytes</i>	716
HAYCRAFT, J. B., & A. ROLLETT— <i>Structure of Striped Muscle</i>	716
MAGINI G.— <i>Structure of Nerve-cells</i>	716
ZOJA, L. & R.— <i>Bioplasts or Plastidules</i>	717

γ. General.

MORGAN, C. LLOYD— <i>Nature and Origin of Variations</i>	717
IMHOF, O. E.— <i>Exploration of Lakes</i>	717

B. INVERTEBRATA.

LANKESTER, E. RAY— <i>Animal Chlorophyll</i>	717
DIXON, G. Y. & A. F.— <i>Marine Invertebrate Fauna near Dublin</i>	718
BIEDERMANN, W.— <i>Origin and Mode of Termination of Nerves in Ganglia of Invertebrata</i>	718
WHITMAN, C. O.— <i>Spermatophores as a Means of Hypodermic Impregnation</i>	719

Mollusca.

THIELE, J.— <i>Phylogenetic Affinities of Mollusca</i>	721
JOHNSTON, R. M.— <i>Tasmanian Mollusca</i>	722

γ. Gastropoda.

SCHMIDT, F.— <i>Development of Central Nervous System of Pulmonata</i>	722
MOYNIER DE VILLEPOIX— <i>Growth of Shell of Helix aspersa</i>	723
FRANÇOIS, PH.— <i>Habits of a Murex</i>	723
ERLANGER, R. v.— <i>Development of Paludina</i>	724
SIMROTH, H.— <i>The Genus Atopos</i>	724
FISCHER, H.— <i>Development of Liver of Nudibranchs</i>	725
BLUMRICH, J.— <i>Integument of Chiton</i>	725

δ. Lamellibranchiata.

BLOCHMANN, F.— <i>The Free-swimming Larva of Dreissena</i>	726
FRANÇOIS, P.— <i>Circulation in Arca</i>	726

Molluscoida.

α. Tunicata.

HERDMAN, W. A.— <i>Tunicata</i>	726
GARSTANG, W.— <i>New and Primitive Type of Compound Ascidian</i>	727

	PAGE
β. Bryozoa.	
BRAEM, F.— <i>Freshwater Polyzoa</i>	727
PROUHO, H.— <i>Free Development in Ectoproctous Bryozoa</i>	728
γ. Brachiopoda.	
FRANÇOIS, P.— <i>Anatomy of Lingula</i>	728
Arthropoda.	
α. Insecta.	
GRABER, v.— <i>Embryology of Insects</i>	729
" " <i>Abdominal Appendages of Insect Embryos</i>	730
POULTON, E. B.— <i>Protective Mimicry in Insects</i>	730
δ. Arachnida.	
WARBURTON, C.— <i>Oviposition and Cocoon-weaving of Agelena labyrinthica</i>	731
KOENIKE, F.— <i>Copulation of Water-mites</i>	731
BATELLI, A.— <i>Anatomical and Physiological Notes on Ixodida</i>	731
KRAMER, P.— <i>Post-embryonic Development of Acarida</i>	732
BERTKAU, PH.— <i>A Hermaphrodite Spider</i>	732
KISHINOYO, K.— <i>Development of Limulus longispinis</i>	732
ε. Crustacea.	
PARKER, G. H.— <i>Compound Eyes of Crustacea</i>	733
RATH, O. VOM.— <i>Dermal Sense-organs of Crustacea</i>	734
DEMOOR, J.— <i>Motor Manifestations of Crustacea</i>	735
CANO, G.— <i>Post-embryonic Development of Gonoplacidae</i>	735
GROBEN, C.— <i>Antennary Gland of Lucifer Reynaudii</i>	735
SCHNEIDER, A.— <i>Arterial System of Isopods</i>	736
ROULE, L.— <i>Development of Germinal Layers of Isopoda</i>	736
LEICHMANN, G.— <i>Reproduction of Isopoda</i>	737
GIESBRECHT, W.— <i>Secondary Sexual Characters in Copepods</i>	737
" " <i>Distribution of Copepods</i>	737
EDWARDS, C. L.— <i>New Copepoda</i>	737
HERDMAN, W. A.— <i>Copepoda as Food</i>	738
BENEDEN, P. J. VAN.— <i>Two new Lernæopoda</i>	738
Vermes.	
α. Annelida.	
ANDREWS, E. A.— <i>Eyes of Polychæta</i>	738
TREADWELL, A. L.— <i>Anatomy and Histology of Serpula dianthus</i>	739
WATSON, A. T.— <i>Protective Device of an Annelid</i>	739
ANDREWS, E. A.— <i>Distribution of Magelona</i>	740
WHITMAN, C. O.— <i>Clepsine plana</i>	740
BOLSIUS, H.— <i>Further Researches on Segmental Organs of Hirudinea</i>	740
β. Nemathelminthes.	
HAMANN, O.— <i>Structure of Nemathelminthes</i>	741
" " <i>Monograph on Acanthocephala</i>	741
KAISER, J.— <i>Structure and Development of Echinorhynchus</i>	742
STILES, C. W.— <i>Notes on Parasites</i>	742
γ. Platyhelminthes.	
SHARP, B.— <i>Large Land Planarian</i>	742
WAGNER, F. v.— <i>The Papillæ of Microstoma</i>	742
MONTICELLI, F. S.— <i>The Genus Apoblema</i>	742
BRAUN, M.— <i>Free-swimming Sporocysts</i>	743
LINSTOW, v.— <i>Structure and Development of Tænia longicollis</i>	743
MRÁZEK, A.— <i>Development of some Tæniæ of Birds</i>	744
ROSSITER, T. B.— <i>Tænia coronula</i>	745
GUILLEBEAU, A.— <i>Echinococcus multilocularis in the Cow</i>	745
" " <i>Cysticercus of Tænia saginata in the Cow</i>	745
δ. Incertæ Sedis.	
COBELLI, R.— <i>Desiccation of Rotifers</i>	745
MAUPAS, M.— <i>Determination of Seæes of Hydatina senta</i>	745
BRYCE, D.— <i>Distyla; New Rotifers</i>	745
Echinodermata.	
CUÉNOT, L.— <i>Morphology of Echinoderms</i>	746
LUDWIG, H.— <i>Ludwig's Echinodermata</i>	748
JANET, C., & L. CUÉNOT.— <i>Apical System of Echinoids</i>	748

Cœlenterata.		PAGE
SCHNEIDER, K. C.— <i>Histological Observations on Cœlenterata</i>	748	748
CERFONTAINE, P.— <i>Organization of Anthozoa</i>	749	749
LACAZE-DUTHIERS, H. DE— <i>Kophobelemonn at Banyula</i>	750	750
STUDER, T.— <i>New Alcyonarian</i>	750	750
KENNEL, J. V.— <i>A Freshwater Medusa</i>	750	750
SCHLATER, G.— <i>Sensory Papillæ of Haliclystus auricula var.</i>	750	750
WILSON, E. B.— <i>Heliotropism of Hydra</i>	750	750
Porifera.		
LENDENFELD, R. V.— <i>Classification of Sponges</i>	751	751
DELAGE, Y.— <i>Development of Spongilla fluviatilis</i>	751	751
Protozoa.		
BALBIANI, E. G.— <i>Successive Regeneration of Peristome in Stentor</i>	751	751
CERTES, A.— <i>Two new Infusoria</i>	752	752
PÉNARD, E.— <i>Rhizopoda of the Lake of Geneva</i>	752	752
RHUMBLER, L.— <i>Origin and Growth of the Shell in Freshwater Rhizopods</i>	752	752
PÉNARD, E.— <i>Freshwater Rhizopods</i>	753	753
SIMMONS, W. J.— <i>Bionmyxa vagans</i>	753	753
CERTES, A.— <i>Trypanosoma Balbianii</i>	753	753
SCHILLING, A. J.— <i>Freshwater Peridinea</i>	753	753
LABRÉ, A.— <i>Hæmatozoa of the Frog</i>	754	754
VINCENT— <i>Presence of bodies resembling Psorosperms in Squamous Epithelioma</i>	754	754
DANILEWSKY, B.— <i>Polymytilis malarie</i>	754	754
ANTOLISEI & ANGELINI— <i>Biological Cycle of Hæmatozoon falciforme</i>	755	755
GRASSI, B., & R. FELETTI— <i>Malaria Parasites in Birds</i>	755	755
MASSART, J.— <i>Researches on Low Organisms</i>	756	756
SCHEWIAKOFF, W.— <i>Zoochlorella</i>	756	756

BOTANY.

A. GENERAL, including the Anatomy and Physiology of the Phanerogamia.

a. Anatomy.

(1) Cell-structure and Protoplasm.

FAYOD, V.— <i>Structure of Living Protoplasm</i>	757	757
AQUA, C.— <i>Structure and Growth of the Cell</i>	757	757
WILDEMAN, E. DE— <i>Influence of Temperature on Caryokinesis</i>	758	758

(2) Other Cell-contents (including Secretions).

MONTEVERDE, N.— <i>Chlorophyll</i>	758	758
PALLADIN, W.— <i>Green and Etiolated Leaves</i>	758	758
LESAGE, P.— <i>Quantity of Starch contained in the Radish</i>	759	759
BRAEMER, L.— <i>Tannoids</i>	759	759
ARCANGELI, G.— <i>Crystals of Calcium oxalate</i>	759	759

(3) Structure of Tissues.

GRAVIS, A.— <i>Anatomy and Physiology of the Conducting Tissues</i>	759	759
SCOTT, D. H., & G. BREBNER— <i>Internal Phloem in Dicotyledons</i>	760	760
DANGEARD, P. A.— <i>Equivalence of the Vascular Bundles in Vascular Plants</i>	760	760
KOCH, L.— <i>Structure and Growth of the Apex in Gymnosperms</i>	760	760
JOST, L.— <i>Increase in Thickness of the Stem and Formation of Annual Rings</i>	761	761
BERCKHOLTZ, W.— <i>Gunnera manicata</i>	761	761

(4) Structure of Organs.

CHATIN, M. A.— <i>Comparative Anatomy of Plants</i>	761	761
HILDEBRAND, F.— <i>Sudden Changes of Form</i>	762	762
CHAMBERLAIN, J. S.— <i>Styles of Compositæ</i>	762	762
CLOS, D.— <i>Embryo of Trapa, Nelumbium, and of some Guttifera</i>	763	763
HUTH, E.— <i>Fruits which expel their seeds with violence (Schleuderfrüchte)</i>	763	763
TANFANI, E.— <i>Fruit and Seed of Umbellifera</i>	763	763
HEINECK, O.— <i>Pericarp of Compositæ</i>	764	764
BARONI, F.— <i>Structure of Seed of Eouonymus</i>	764	764
SIMEK, E.— <i>Structure of Cotyledons</i>	764	764
SAUVAGEAU, C.— <i>Stem of the Cymodocea</i>	764	764
KRICK, F.— <i>Swellings in the Bark of the Copper-beech</i>	764	764
SCHMIDT, C.— <i>Leaves of Xerophilous Liliifloræ</i>	765	765

	PAGE
KLEIN, J.— <i>Abnormal Leaves</i>	765
WAAGE, T.— <i>Roots without a Root-cap</i>	765
ATKINSON, G. F.— <i>Tubercles on the roots of Ceanothus</i>	766

β. Physiology.

(1) Reproduction and Germination.

BURCK, W.— <i>Weismann's Theory of Heredity</i>	766
WESTERMAIER, M.— <i>Function of the Antipodals</i>	766
HÉRALD, J.— <i>Reproductive Organs of Phanerogams</i>	766
BURCK, W.— <i>Cleistogamic Flowers</i>	767
ROSEN, F.— <i>Importance of Heterogamy in the formation and maintenance of species</i>	767
OVERTON, E.— <i>Fertilization of Liliium Martagon</i>	767
DODEL, A.— <i>Fertilization of Iris sibirica</i>	768
LOEW, E., & OTHERS— <i>Contrivances for Pollination</i>	768
WILSON, J. H.— <i>Pollination and Hybridizing of Albica</i>	769
KNUTH, P.— <i>Pollination of Orobanchæ</i>	769
DAY, T. C.— <i>Influence of Temperature on Germinating Barley</i>	769
HEMSLEY, W. B.— <i>Vitality of Seeds</i>	769
GANDOGER, M.— <i>Longevity of Bulbils</i>	770

(2) Nutrition and Growth (including Movements of Fluids).

PFEFFER, W.— <i>Absorption and Elimination of Solid Substances by Cells</i>	770
JUMELLE, H.— <i>Assimilation and Transpiration</i>	770
LAMARLIÈRE, G. DE— <i>Assimilation in Umbelliferae</i>	770
OTTO, R.— <i>Assimilation of free atmospheric Nitrogen</i>	771
SCHMIDT, R. M.— <i>Absorption and Metabolism of Fatty Oils</i>	771

(3) Irritability.

STEINBRINCK, C.— <i>Anatomico-physical causes of Hygroscopic Movements</i>	771
MACFARLANE, J. M.— <i>Irritability of the Leaves of Dionæa</i>	771
HALSTED, B. D.— <i>Heliotropic Sundew</i>	772

(4) Chemical Changes (including Respiration and Fermentation).

PURJEWICZ, K.— <i>Influence of Light on Respiration</i>	772
WEHMER, C.— <i>Formation and Decomposition of Oxalic Acid and its Function in the Metabolism of Fungi</i>	772
LINossier, G., & G. ROUX— <i>Alcoholic Fermentation and the Conversion of Alcohol into Aldehyde by the "Champignon du Muguet"</i>	773
BOUÏROUX, L., & CHICAUDARD— <i>Fermentation of Bread</i>	773
FRANKLAND, P. F., & OTHERS— <i>Fermentations induced by the Pneumococcus of Friedlaender</i>	773
VINES, S. H.— <i>Diastatic Ferment in Green Leaves</i>	774

γ. General.

MEEHAN, T.— <i>Evolution of Parasitic Plants</i>	774
LEVEILLE, H.— <i>Exudation of Sap by Mangifera</i>	774

B. CRYPTOGRAMIA.

Cryptogamia Vascularia.

CAMPBELL, D. H.— <i>Life-history of Isoetes</i>	774
POIRAULT, G.— <i>Sieve-tubes of Filicinæ and Equisetinæ</i>	775
FIGDOR, W.— <i>Nectaries of Pteris aquilina</i>	775
POIRAULT, G.— <i>Peculiarity in the Root of Ceratopteris thalictroides</i>	776
HOVELACQUE, M.— <i>Structure of the Primary Fibro-vascular System in Lepidodendron selaginoides</i>	776

Muscineæ.

MITTEN, W.— <i>New Genera of Mosses, Aulacomnium and Willia</i>	776
---	-----

Characeæ.

MIGULA, W.— <i>Rabenhorst's Kryptogamen-Flora v. Deutschland (Characeæ)</i>	776
---	-----

Algæ.

OLTMANN, F.— <i>Influence of the Concentration of Sea-water on the Growth of Algæ</i>	777
MÖBIUS, M.— <i>Endophytic Algæ</i>	777
ISTVÁNFFI, J.— <i>"Meteor-paper"</i>	777
BUFFHAM, T. H.— <i>Reproductive Organs of Floridææ</i>	777
RICHARDS, H. M.— <i>Chroococci</i>	778
REINKE, J.— <i>Sphaclariaceæ</i>	778
MURRAY, G.— <i>Cladothele and Stictyosiphon</i>	778

	PAGE
WILDEMAN, E. DE— <i>Cladophora</i>	778
HANSRIG, A.— <i>Hormidium</i> , <i>Schizogonium</i> , and <i>Hormiscia</i>	778
BARBER, C. A., & W. T. THISELTON-DYER— <i>Pachytheca</i>	779

Fungi.

VUILLEMIN, P.— <i>Mycorhiza</i>	779
FRANK, B.— <i>Endotrophic Mycorhiza</i>	779
MANGIN, L.— <i>Disarticulation of Conidia in the Peronosporæ</i>	779
RUSH, W. H.— <i>Penetration of the Host by Peronospora gangliiformis</i>	780
WEYRE, A. DE— <i>Biology of Phycomyces nitens</i>	780
SETCHELL, W. A.— <i>Doassansia</i>	780
KRÜGER, W.— <i>Fungus-parasites of the Sugar-cane</i>	781
BOMMER, C.— <i>Fungus parasitic on Balanus</i>	781
MARCHAL, E.— <i>New Genus of Fungi (Sphæropsidæ)</i>	781
ZABRISKIE, J. L.— <i>New Pestalozzia</i>	781
HUMPHREY, J. E.— <i>Diseases caused by Fungi</i>	782
PRILLIEUX, E., & DELACROIX— <i>Fungus-parasites on Pines</i>	782
MÄLE, C.— <i>Fructification of Physcia pulverulenta</i>	782
HANSEN, E. C.— <i>Germination of Spores in Saccharomyces</i>	782
DIETEL, P.— <i>Researches on Uredinæ</i>	783
BARCLAY, A.— <i>Uromyces Cunninghamianus</i> sp. n.	783
MAGNUS, P.— <i>Diorchidium</i>	783
PRILLIEUX, E., & DELACROIX— <i>Parasite of the Cockchafer</i>	783
THAXTER, R.— <i>New Genera of Hyphomycetes</i>	784
LUDWIG, F.— <i>Mucilaginous Slime on Trees</i>	784
BUSQUET, G. P.— <i>New Achorion, A. Arloini</i>	784

Protophyta.

a. Schizophycæ.

REINHARD, L.— <i>Glæochæte</i>	784
DEBY, J.— <i>The Idea of Species in Diatoms</i>	785
TEMPÈRE, J., & H. PERAGALLO— <i>Diatoms of France</i>	785
BRUN, J., & W. H. SHRUBSOLE— <i>New Genera of Diatoms</i>	785
PERAGALLO, H.— <i>Monograph of Pleurosigma</i>	785
DEBY, J.— <i>Auliscus</i>	785

β. Schizomycetes.

ROUX & OTHERS— <i>Phagocytosis</i>	785
SAWTSCHENKO, J.— <i>Immunity to Anthrax</i>	795
SANARELLI, G.— <i>Natural Immunity to Anthrax</i>	796
TIZZONI, G., & G. CATTANI— <i>Immunization against the Virus of Tetanus</i>	796
METSCHNIKOFF, O.— <i>Anthrax Vaccination</i>	797
OGATA, M.— <i>Germicidal Substance of the Blood</i>	797
STERN, R.— <i>Effect of Human Blood and other Body-juices on Pathogenic Microbes</i>	798
VALUDE— <i>Antiseptic Value of Anilin Pigments</i>	798
ALTHEOFER— <i>Disinfecting property of Peroxide of Hydrogen</i>	799
TIZZONI G., & G. CATTANI— <i>Attenuation of Bacillus of Tetanus</i>	799
VERHOOGEN, R.— <i>Action of the Constant Current on Pathogenic Micro-organisms</i>	799
KOLLMAN— <i>Pseudomicrobes of Normal and Pathological Blood</i>	800
BEYERINCK, W.— <i>Photogenic and Plastic Nutriment of Luminous Bacteria</i>	800
ZEIDLER, A.— <i>Bacteria found in Beer</i>	801
LORTET— <i>Pathogenic Bacteria obtained from the mud of the Lake of Geneva</i>	801
BURCI, E.— <i>Bacillus pyrogenes fetidus</i>	801
ADAMETZ, L.— <i>Bacillus lactis viscosus</i>	801
BUCHNER, H.— <i>Bacteria-protein and its relation to Inflammation and Suppuration</i>	802
JANOWSKI, TH.— <i>Action of Light on Bacillus of Typhoid Fever</i>	802
BIBLIOGRAPHY	803

MICROSCOPY.

a. Instruments, Accessories, &c.

(1) Stands.

FIELD, A. G.— <i>A Universal Stand (Figs. 81 and 82)</i>	805
BECK'S <i>Bacteriological "Star" Microscope (Fig. 83)</i>	806
GIANT <i>Projection Microscope</i>	806
SACCARDO, P. A.— <i>Eustachio Divini's Compound Microscope (Figs. 84 and 85)</i>	808
" " <i>Invention of the Compound Microscope</i>	808

(3) Illuminating and other Apparatus.

THOMPSON, S. P.— <i>New Polarizer</i>	810
SELLE, GUSTAV— <i>Microscope Mirror for Illumination by Reflected Light (Fig. 86)</i>	810
WATRINS, R. L.— <i>Electro-Microscope Slide for Testing the Antiseptic Power of Electricity (Fig. 87)</i>	810

	PAGE
EDINGER, L.— <i>New Apparatus for drawing Low Magnifications</i> (Fig. 88)	811
BEHRENS, W.— <i>Glasses for keeping Immerston Oil</i>	812
(4) Photomicrography.	
NEUHAUSS, R.— <i>Magnesium Flash-Light in Photomicrography</i>	812
LUMIÈRE— <i>Coloured Photomicrograms</i>	813
(5) Microscopical Optics and Manipulation.	
CZAFSKI, S.— <i>Probable Limits to the Capacity of the Microscope</i>	814
THOMPSON, S. P.— <i>Measurement of Lenses</i>	818
CAPLATZI, A.— <i>Photographic Optics</i>	818
(6) Miscellaneous.	
DALLINGER, W. H.— <i>New Edition of Carpenter on the Microscope</i>	819
DEATH of Mr. Walter H. Bulloch	820
UNIVERSAL Microscopic Exhibition at Antwerp	820
MEETING of American Microscopists	821
EBBAGE, H.— <i>Recreative Microscopy</i>	823
β. Technique.	
(1) Collecting Objects, including Culture Processes.	
KIRCHNER— <i>Methods of Bacteriological Research</i>	823
SLESKIN, P.— <i>Silicate-jelly as a Nutrient Substratum</i>	824
MARPMANN— <i>Substitutes for Agar and Gelatin</i>	824
STEVENS, T. S.— <i>Miniature Tank for Microscopical Purposes</i>	824
HOPKINS, G. M.— <i>Apparatus for Gathering and Examining Microscopic Objects</i> (Figs. 89 and 90)	825
(2) Preparing Objects.	
STROBEL— <i>Preserving Fluid</i>	827
HOLL, M.— <i>Investigation of Fowl's Ovum</i>	827
FIELD, H. H.— <i>Preparation of Embryos of Amphibia</i>	827
BURCHHARDT, R.— <i>Investigation of Brain and Olfactory Organ of Triton and</i> <i>Ichthyophis</i>	827
VISART, O.— <i>Preparing Epithelium of Mid-gut of Arthropods</i>	828
PARKER, G. H.— <i>Mode of Preparing Crustacean Eyes</i>	828
BOLSUS, H.— <i>Preparing Segmental Organs of Hirudinea</i>	828
CERTES, A.— <i>Eismond's Method of Studying living Infusoria</i>	828
MACALLUM, A. B.— <i>Demonstration of Presence of Iron in Chromatin by Micro-</i> <i>chemical Methods</i>	828
BORZI, A.— <i>Culture of Terrestrial Algae</i>	829
REINKE, J.— <i>Re-softening dried Algae</i>	829
MÖLLER, H.— <i>Demonstrating Fungi in Cells</i>	829
ROSCOE, H. E., & J. LUNT— <i>Mode of Investigating Chemical Bacteriology of Sewage</i> FAVRAT, A., & F. CHRISTMANN— <i>Simple Method for obtaining Leprosy Bacilli from</i> <i>living Lepers</i>	830
(4) Staining and Injecting.	
OBREGIA, A.— <i>Method for fixing Preparations treated by Sublimate or Silver (Golgi's</i> <i>Method)</i>	830
BURCI, E.— <i>Rapid Staining of Elastic Fibres</i>	831
MOELLER, H.— <i>New Method of Spore-staining</i>	831
MAYER, PAUL— <i>Hæmalum and Hæmacalcium Staining Solution made from Hæma-</i> <i>tozylin Crystals</i>	831
FRAENKEL (B.) <i>on Gabbet's Stain for Tubercle Bacilli</i>	832
TAVEL— <i>Syringes and their Sterilization</i>	832
(6) Miscellaneous.	
MOORE, S. LE M.— <i>Microchemical Reactions of Tannin</i>	833
KNAUER, F., & J. B. NIAS— <i>Cleansing Used Slides and Cover-glasses</i>	833
NUTTALL, G. H. F.— <i>Method for the Estimation of the actual number of Tubercle</i> <i>Bacilli in Phthisical Sputum</i>	833
ARONSON, H.— <i>Colloidal Clay for Filtering Fluids containing Bacteria</i>	835
HOPKINS, G. M.— <i>Some suggestions in Microscopy</i> (Figs. 91 and 92)	835
LEVI-MORENOS, D.— <i>Artificial Sea-water</i>	836
PROCEEDINGS OF THE SOCIETY	837
INDEX OF NEW BIOLOGICAL TERMS	849
INDEX	851

APERTURE TABLE.

Numerical Aperture. ($n \sin u = a$.)	Corresponding Angle ($2u$) for			Limit of Resolving Power, in Lines to an Inch.			Illuminating Power. (a^2)	Penetrating Power ($\frac{1}{a}$)
	Air ($n = 1.00$.)	Water ($n = 1.33$.)	Homogeneous Immersion ($n = 1.52$.)	White Light. ($\lambda = 0.5269 \mu$, Line E.)	Monochromatic (Blue) Light. ($\lambda = 0.4861 \mu$, Line F.)	Photography. ($\lambda = 0.4000 \mu$, Near Line h.)		
1.52	180° 0'	146,543	158,845	193,037	2.310	.658
1.51	166° 51'	145,579	157,800	191,767	2.280	.662
1.50	161° 23'	144,615	156,755	190,497	2.250	.667
1.49	157° 12'	143,651	155,710	189,227	2.220	.671
1.48	153° 39'	142,687	154,665	187,957	2.190	.676
1.47	150° 32'	141,723	153,620	186,687	2.161	.680
1.46	147° 42'	140,759	152,575	185,417	2.132	.685
1.45	145° 6'	139,795	151,530	184,147	2.103	.690
1.44	142° 39'	138,830	150,485	182,877	2.074	.694
1.43	140° 22'	137,866	149,440	181,607	2.045	.694
1.42	138° 12'	136,902	148,395	180,337	2.016	.709
1.41	136° 8'	135,938	147,350	179,067	1.988	.709
1.40	134° 10'	134,974	146,305	177,797	1.960	.714
1.39	132° 16'	134,010	145,260	176,527	1.932	.719
1.38	130° 26'	133,046	144,215	175,257	1.904	.725
1.37	128° 40'	132,082	143,170	173,987	1.877	.729
1.36	126° 58'	131,118	142,125	172,717	1.850	.735
1.35	125° 18'	130,154	141,080	171,447	1.823	.741
1.34	123° 40'	129,189	140,035	170,177	1.796	.746
1.33	..	180° 0'	122° 6'	128,225	138,989	168,907	1.769	.752
1.32	..	165° 56'	120° 33'	127,261	137,944	167,637	1.742	.758
1.30	..	155° 38'	117° 35'	125,333	135,854	165,097	1.690	.769
1.28	..	148° 42'	114° 44'	123,405	133,764	162,557	1.638	.781
1.26	..	142° 39'	111° 59'	121,477	131,674	160,017	1.588	.794
1.24	..	137° 36'	109° 20'	119,548	129,584	157,477	1.538	.806
1.22	..	133° 4'	106° 45'	117,620	127,494	154,937	1.488	.820
1.20	..	128° 55'	104° 15'	115,692	125,404	152,397	1.440	.833
1.18	..	125° 3'	101° 50'	113,764	123,314	149,857	1.392	.847
1.16	..	121° 26'	99° 29'	111,835	121,224	147,317	1.346	.862
1.14	..	118° 0'	97° 11'	109,907	119,134	144,777	1.300	.877
1.12	..	114° 44'	94° 55'	107,979	117,044	142,237	1.254	.893
1.10	..	111° 36'	92° 43'	106,051	114,954	139,698	1.210	.909
1.08	..	108° 36'	90° 34'	104,123	112,864	137,158	1.166	.926
1.06	..	105° 42'	88° 27'	102,195	110,774	134,618	1.124	.943
1.04	..	102° 53'	86° 21'	100,266	108,684	132,078	1.082	.962
1.02	..	100° 10'	84° 18'	98,338	106,593	129,538	1.040	.980
1.00	180° 0'	97° 31'	82° 17'	96,410	104,503	126,998	1.000	1.000
0.98	157° 2'	94° 56'	80° 17'	94,482	102,413	124,458	.960	1.020
0.96	147° 29'	92° 24'	78° 20'	92,554	100,323	121,918	.922	1.042
0.94	140° 6'	89° 56'	76° 24'	90,625	98,233	119,378	.884	1.064
0.92	133° 51'	87° 32'	74° 30'	88,697	96,143	116,838	.846	1.087
0.90	128° 19'	85° 10'	72° 36'	86,769	94,053	114,298	.810	1.111
0.88	123° 17'	82° 51'	70° 44'	84,841	91,963	111,758	.774	1.136
0.86	118° 38'	80° 34'	68° 54'	82,913	89,873	109,218	.740	1.163
0.84	114° 17'	78° 20'	67° 6'	80,984	87,783	106,678	.706	1.190
0.82	110° 10'	76° 8'	65° 18'	79,056	85,693	104,138	.672	1.220
0.80	106° 16'	73° 58'	63° 31'	77,128	83,603	101,598	.640	1.250
0.78	102° 31'	71° 49'	61° 45'	75,200	81,513	99,058	.608	1.282
0.76	98° 56'	69° 42'	60° 0'	73,272	79,423	96,518	.578	1.316
0.74	95° 28'	67° 37'	58° 16'	71,343	77,333	93,979	.548	1.351
0.72	92° 6'	65° 32'	56° 32'	69,415	75,242	91,439	.518	1.389
0.70	88° 51'	63° 31'	54° 50'	67,487	73,152	88,899	.490	1.429
0.68	85° 41'	61° 30'	53° 9'	65,559	71,062	86,359	.462	1.471
0.66	82° 36'	59° 30'	51° 28'	63,631	68,972	83,819	.436	1.515
0.64	79° 36'	57° 31'	49° 48'	61,702	66,882	81,279	.410	1.562
0.62	76° 38'	55° 34'	48° 9'	59,774	64,792	78,739	.384	1.613
0.60	73° 44'	53° 38'	46° 30'	57,846	62,702	76,199	.360	1.667
0.58	70° 54'	51° 42'	44° 51'	55,918	60,612	73,659	.336	1.724
0.56	68° 6'	49° 48'	43° 14'	53,990	58,522	71,119	.314	1.786
0.54	65° 22'	47° 54'	41° 37'	52,061	56,432	68,579	.292	1.852
0.52	62° 40'	46° 2'	40° 0'	50,133	54,342	66,039	.270	1.923
0.50	60° 0'	44° 10'	38° 24'	48,205	52,252	63,499	.250	2.000
0.45	53° 30'	39° 33'	34° 27'	43,385	47,026	57,149	.203	2.222
0.40	47° 9'	35° 0'	30° 31'	38,564	41,801	50,799	.160	2.500
0.35	40° 58'	30° 30'	26° 38'	33,744	36,576	44,449	.123	2.857
0.30	34° 56'	26° 4'	22° 46'	28,923	31,351	38,099	.090	3.333
0.25	28° 58'	21° 40'	18° 56'	24,103	26,126	31,749	.063	4.000
0.20	23° 4'	17° 18'	15° 7'	19,282	20,901	25,400	.040	5.000
0.15	17° 14'	12° 58'	11° 19'	14,462	15,676	19,050	.023	6.667
0.10	11° 29'	8° 38'	7° 34'	9,641	10,450	12,700	.010	10.000
0.05	5° 44'	4° 18'	3° 46'	4,821	5,252	6,350	.003	20.000

COMPARISON OF THE FAHRENHEIT AND CENTIGRADE THERMOMETERS.

Fahr.	Centigr.	Fahr.	Centigr.	Fahr.	Centigr.	Fahr.	Centigr.	Fahr.	Centigr.
212	100	158	70	104	40	50	10	- 4	- 20
210.2	99	156.2	69	102.2	39	48.2	9	- 5.8	- 21
210	98.89	156	68.89	102	38.89	48	8.89	- 6	- 21.11
208.4	98	154.4	68	100.4	38	46.4	8	- 7.6	- 22
208	97.78	154	67.78	100	37.78	46	7.78	- 8	- 22.22
206.6	97	152.6	67	98.6	37	44.6	7	- 9.4	- 23
206	96.67	152	66.67	98	36.67	44	6.67	- 10	- 23.33
204.8	96	150.8	66	96.8	36	42.8	6	- 11.2	- 24
204	95.56	150	65.56	96	35.56	42	5.56	- 12	- 24.44
203	95	149	65	95	35	41	5	- 13	- 25
202	94.44	148	64.44	94	34.44	40	4.44	- 14	- 25.56
201.2	94	147.2	64	93.2	34	39.2	4	- 14.8	- 26
200	93.33	146	63.33	92	33.33	38	3.33	- 16	- 26.67
199.4	93	145.4	63	91.4	33	37.4	3	- 16.6	- 27
198	92.22	144	62.22	90	32.22	36	2.22	- 18	- 27.78
197.6	92	143.6	62	89.6	32	35.6	2	- 18.4	- 28
196	91.11	142	61.11	88	31.11	34	1.11	- 20	- 28.89
195.8	91	141.8	61	87.8	31	33.8	1	- 20.2	- 29
194	90	140	60	86	30	32	0	- 22	- 30
192.2	89	138.2	59	84.2	29	30.2	- 1	- 23.8	- 31
192	88.89	138	58.89	84	28.89	30	- 1.11	- 24	- 31.11
190.4	88	136.4	58	82.4	28	28.4	- 2	- 25.6	- 32
190	87.78	136	57.78	82	27.78	28	- 2.22	- 26	- 32.22
188.6	87	134.6	57	80.6	27	26.6	- 3	- 27.4	- 33
188	86.67	134	56.67	80	26.67	26	- 3.33	- 28	- 33.33
186.8	86	132.8	56	78.8	26	24.8	- 4	- 29.2	- 34
186	85.56	132	55.56	78	25.56	24	- 4.44	- 30	- 34.44
185	85	131	55	77	25	23	- 5	- 31	- 35
184	84.44	130	54.44	76	24.44	22	- 5.56	- 32	- 35.56
183.2	84	129.2	54	75.2	24	21.2	- 6	- 32.8	- 36
182	83.33	128	53.33	74	23.33	20	- 6.67	- 34	- 36.67
181.4	83	127.4	53	73.4	23	19.4	- 7	- 34.6	- 37
180	82.22	126	52.22	72	22.22	18	- 7.78	- 36	- 37.78
179.6	82	125.6	52	71.6	22	17.6	- 8	- 36.4	- 38
178	81.11	124	51.11	70	21.11	16	- 8.89	- 38	- 38.89
177.8	81	123.8	51	69.8	21	15.8	- 9	- 38.2	- 39
176	80	122	50	68.2	20	14	- 10	- 40	- 40
174.2	79	120.2	49	66	19	12.2	- 11	- 41.80	- 41
174	78.89	120	48.89	66.4	18.89	12	- 11.11	- 42	- 41.11
172.4	78	118.4	48	64	18	10.4	- 12	- 43.60	- 42
172	77.78	118	47.78	64.6	17.78	10	- 12.22	- 44	- 42.22
170.6	77	116.6	47	62	17	8.6	- 13	- 45.40	- 43
170	76.67	116	46.67	62.8	16.67	8	- 13.33	- 46	- 43.33
168.8	76	114.8	46	60	16	6.8	- 14	- 47.20	- 44
168	75.56	114	45.56	60	15.56	6	- 14.44	- 48	- 44.44
167	75	113	45	59	15	5	- 15	- 49	- 45
166	74.44	112	44.44	58	14.44	4	- 15.56	- 50	- 45.56
165.2	74	111.2	44	57.2	14	3.2	- 16	- 50.80	- 46
164	73.33	110	43.33	56	13.33	2	- 16.67	- 52	- 46.67
163.4	73	109.4	43	55.4	13	1.4	- 17	- 52.60	- 47
162	72.22	108	42.22	54	12.22	0	- 17.78	- 54	- 47.78
161.6	72	107.6	42	53.6	12	- 0.4	- 18	- 54.40	- 48
160	71.11	106	41.11	52	11.11	- 2	- 18.89	- 56	- 48.89
159.8	71	105.8	41	51.8	11	- 2.2	- 19	- 56.20	- 49
								- 58	- 50

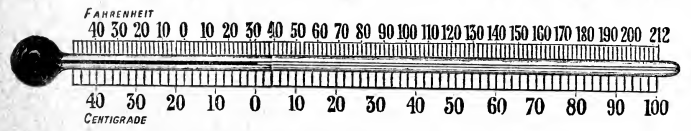

Illustrated by Fifty-three Plates and more than Eight Hundred Woodcuts, giving figures of nearly 3000 Microscopic Objects. 8vo. Cloth. £2 12s. 6d.

Griffith & Henfrey's Micrographic Dictionary:

A GUIDE TO THE EXAMINATION AND INVESTIGATION OF THE STRUCTURE AND NATURE OF MICROSCOPIC OBJECTS.

FOURTH EDITION.

Edited by J. W. GRIFFITH, M.D., &c., assisted by The Rev. M. J. BERKELEY, M.A., F.L.S., and T. RUPERT JONES, F.R.S., F.G.S., &c.

"A valuable handbook even for the advanced student of nature, to whom, moreover, the having such a vast mass of scattered zoological and botanical knowledge brought together within the compass of a single volume cannot but be exceedingly convenient."—*Annals of Natural History*.

LONDON: GURNEY & JACKSON, 1, PATERNOSTER ROW.
(SUCCESSORS TO MR. VAN VOORST.)

SWIFT & SON'S New 1/12 in. Homogeneous Immersion Objective of 1.25 N.A., in which the New Abbe-Schott glass is used, price £5 5s.

This lens SWIFT & SON guarantee to be equal to any other Homogeneous Immersion Objective of the same N.A.

SWIFT & SON are continually receiving testimonials in praise of the above Objective.

A New 1/12 in. Apochromatic Homogeneous Immersion Objective of 1.4 N.A., £16.

Compensating Eye-pieces, magnifying 10, 20, and 30 times, price each, £2.

These Eye-pieces also give excellent results with Objectives made with the old Media.

Projection Eye-pieces for Photo-Micrography, magnifying 3 and 6 times, each £2.

For particulars of Professor Crookshank's Bacteriological Microscope, and Medical Press Comments, send for Circular.

UNIVERSITY OPTICAL WORKS,
81, TOTTENHAM COURT ROAD, LONDON, W.

ROYAL MICROSCOPICAL SOCIETY.

MEETINGS FOR 1891, at 8 p.m.

Wednesday, JANUARY 21	Wednesday, MAY 20
(Annual Meeting for Election of Officers and Council.)	„ JUNE 17
„ FEBRUARY 18	„ OCTOBER 21
„ MARCH 18	„ NOVEMBER 18
„ APRIL 15	„ DECEMBER 16

Fellows intending to exhibit any Instruments, Objects, &c., or to bring forward any Communication at the Ordinary Meetings, will much facilitate the arrangement of the business thereat if they will inform the Secretaries of their intention two clear days at least before the Meeting.

Authors of Papers printed in the Transactions are entitled to 20 copies of their communications *gratis*. Extra copies can be had at the price of 10s. 6d. per half-sheet of 8 pages, or less, including cover, for a minimum number of 50 copies, and 6s. per 100 plates, if plain. Prepayment by P.O.O. is requested.

JOURNAL
OF THE
ROYAL MICROSCOPICAL SOCIETY.

DECEMBER 1891.

TRANSACTIONS OF THE SOCIETY.

X.—Notes of New Infusoria from the Fresh Waters of the United States.

ERRATA.

- Page 727, for "β. Polyzoa" read "β. Bryozoa."
" 728, omit "β. Bryozoa."
" 778, lines 4 and 5, for "Chreocolax" read "Chorcocolax."

contractile vesicles two, one near the centre of each lateral border, a large, conspicuous vacuole often developed at the posterior extremity; pedicle stout, apparently hollow, from two and a half to three times

EXPLANATION OF PLATE X.

- Fig. 1.—*Monosiga lacustris*. × 750.
" 2.— " *flicaulis*. × 720. A portion of the pedicle omitted.
" 3.—*Salpingoeca brunnea*.
" 4.—*Plagiopyla Hatchi*. × 195.
" 5.—*Strombidinopsis similis*. × 400.
" 6.—*Chilodon labiatus*. × 375.
" 7.—*Urostyla elongata*.
" 8.— " *fulva*. × 220.
" 9.—*Trichototaxis stagnatilis*. × 260.
" 10.—*Oxytricha setigera*. × 550.
" 11.— " *ludibunda*.
" 12.—*Histrio Sphagni*. × 315.
" 13.— " " Diagram of the concave margin of some forms.
" 14.— " *vorax*. × 150.
" 15.—*Acineta æqualis*. × 525.
" 16.— " *pyriformis*. × 730.

as long as the body. Hab. pond water; attached to the rootlets of *Lemna*. Solitary.

This form most nearly approaches the *Monosiga obovata* described by the writer, but is readily distinguishable by its smaller size, the proportion borne by the length to the width, and the presence of two contractile vesicles.

Monosiga flicaulis. Fig. 2.

Body broadly ovate, the length but little greater than the width, slightly changeable in shape, elevated upon a delicately filiform pedicle from ten to twelve times as long as the zooid; contractile vesicles two, placed near the centre of the opposite lateral borders, a vacuole developed close to the posterior extremity. Length of the body, 1/1800 in. Hab. pond water; attached to the rootlets of *Lemna*. Solitary.

This is distinguishable from the *Monosiga longipes* of the author by the different form of the body, the smaller size and the much greater proportionate length of the pedicle.

Salpingœca brunnea. Fig. 3.

Lorica vasiform, the body or main portion sub-hemispherical, somewhat depressed, the neck almost as long as the height of the sub-spherical portion, the anterior margin flaring; body of the lorica usually a deep, chestnut brown in colour, while the neck-like prolongation is entirely colourless; inclosed organism not entirely filling the lorica, projecting some distance beyond the anterior aperture. Length of lorica about 1/600 in. Hab. pond water.

This beautiful form is not rare in the writer's vicinity, and it is specially noteworthy for the deep chestnut-brown colour of the body of the lorica and the colourless condition of the neck. How speedily after its formation the lorica assumes this tint is not known; I have not seen a colourless specimen.

Plagiopyla Hatchi. Fig. 4.

Body elongate-obovate, somewhat depressed, soft and flexible, less than three times as long as broad, the anterior border often obliquely rounded, the posterior extremity somewhat tapering and subacutely pointed; right-hand lateral margin frequently flattened, the left-hand side convex; oral aperture ovate, situated in the anterior body-half, near the right-hand body margin, its right-hand border bearing a narrow, undulating membrane; pharynx obscure; nucleus ovate, sub-centrally placed; contractile vesicle single, spherical, near the centre of the right-hand body margin; cilia numerous, fine; trichocysts abundant, placed perpendicularly to the cuticular surface, which is minutely papillose. Length of body 1/150 to 1/200 in. Hab. ponds and standing water near Minneapolis, Minn.

The food of this interesting form seems to be chiefly vegetable, the infusorian feeding greedily upon spores and diatoms, which it engulfs apparently by suction. The body is very soft and flexible, easily forcing itself through narrow places and quickly turning on its course by a flexure or doubling of itself.

For the pleasure of studying it I am indebted to Dr. P. L. Hatch, of Minneapolis, Minn., who finds it abundantly during the summer months in grassy and shallow ponds, and observes that it thrives almost as well in standing water. He also reports that the anal aperture is postero-terminal.

Strombidinopsis similis. Fig. 5.

Body obovate, about twice as long as broad, finely striate longitudinally; frontal border truncate, slightly oblique, the body being somewhat constricted beneath it; posterior extremity obtusely rounded; a series of fine, hair-like setæ outwardly directed and projecting from the cuticular surface immediately beneath the peristome border, their length about one-half that of the body; oral depression broad, excavate, and continued as a wide, conspicuous, ciliated, pharyngeal passage extending to near the centre of one lateral border of the zooid, a tongue-like motionless projection present on one internal lateral margin of the peristome border, the oral depression appearing to be rather deeper beneath it than elsewhere; contractile vesicle single, spherical, located posteriorly; nucleus not observed. Length of body 1/400 in. Hab. standing pond water.

This form remotely resembles the author's *Strombidinopsis setigera*, and both so differ in important particulars from the typical *Strombidinopsis* that it may at some time be proper to relegate them to a new genus. The present form differs from that just referred to, in the general shape of the body, the presence of the apparently rigid, tongue-like peristomial projection, but particularly in a characteristic habit of producing from the mucous secretions of the cuticular surface a soft, shapeless, indistinct, sheath-like covering into which it retreats backward at the approach of danger. The frontal region is then somewhat contracted, the cilia and setæ being projected forward, the animal gliding backward for only a momentary and a very imperfect concealment. The mucous covering is so slight that it would commonly be unnoticeable but for the adhesion of minute floating particles and of rejected food. Its production seems to be involuntary; it is at least without definite form or describable consistence. The infusorian is in no way attached to this mucous formation, and may leave it at will. The creature at times avails itself of almost any soft collection of debris, beneath which it temporarily and imperfectly conceals itself while its ciliary currents bring to it the food morsels it needs. The peristomial cilia are capable of individual movement, the infusorian having complete control of each and all.

Chilodon labiatus. Fig. 6.

Body obovate, about twice as long as broad; posterior border usually obtusely pointed, often obliquely directed, occasionally somewhat acuminate; lip prominent, conical in outline, directed somewhat obliquely upward and outward, the anterior margin convex and continuous with the frontal border of the body, the posterior border obliquely truncate; nucleus ovate, in the posterior body-half; contractile vesicles not numerous, only two usually conspicuously developed, one on each side of the nucleus; ciliated adoral line conspicuous. Length of body $1/500$ – $1/665$ in. Hab. pond water, with decaying vegetation.

This form, as far as the lip-like prominence is concerned, somewhat resembles the *Chilodon caudatus* described by the author, conspicuously differing, however, in the absence of the dorsally developed and rigid, tail-like prolongation characteristic of the last named form, which is common and abundant in the shallow waters near the writer's home.

Urostyla elongata. Fig. 7.

Body elongated or sub-elliptical, very soft and flexible, less than four times as long as broad, both extremities rounded, the posterior often slightly the wider; anterior lip narrow, crescentic; peristomial field obovate, extending obliquely from the left-hand side of the anterior extremity toward the right for a distance about equal to one-third the length of the body, and continued internally as a narrow, tubular, non-ciliated pharyngeal passage extending to the body centre; the right and left-hand margins of the peristome ciliated, and a series of long intra-oral cilia depending from the central region; frontal styles numerous, the anterior the largest; ventral styles fine, numerous, arranged in six longitudinal series; marginal setæ longest and largest at the posterior extremity; anal styles from eight to ten, arranged in an oblique row, not projecting beyond the posterior extremity; endoplasm brown, semi-opaque; nucleus not observed; cuticular surface roughened by minute, hemispherical elevations arranged in irregular series. Length of body $1/85$ in. Hab. standing pond water.

Urostyla fulva. Fig. 8.

Body sub-elliptical, soft and flexible, somewhat broader anteriorly, about three times as long as wide, the extremities rounded, the anterior lip crescentic and capacious; peristome obovate, extending to near the centre of the ventral surface, the right-hand or reflected border finely ciliate, and bearing an undulating membrane, the left hand margin also finely ciliate, and a series of long, fine intra-oral cilia depending from the roof of the peristome region and continued through the narrow, tubular pharyngeal passage which is curved toward the

right-hand side; ventral cilia in six longitudinal series; frontal styles numerous, the most anterior the largest; marginal series not projecting beyond the lateral borders; anal styles five or six, fine, not projecting beyond the posterior margin, arranged in an obliquely directed series; endoplasm brown, semi-transparent. Length 1/100 in. Hab. standing pond water.

Trichototaxis * g. n.

Animal free-swimming, hypotrichous, soft and flexible, depressed; frontal styles numerous, in two curved, sub-parallel series; ventral styles forming three longitudinal rows; marginal setæ uninterrupted; anal styles well developed; inhabiting fresh-water infusions.

Trichototaxis stagnatilis. Fig. 9.

Body obovate or sub-elliptical, three times as long as broad; anterior extremity obliquely rounded, the posterior also rounded and often centrally emarginate; right-hand lateral border more or less convex, the left-hand margin flattened; frontal border exhibiting a somewhat conspicuous semicircular, ridge-like elevation, continuous with the inner or right-hand margin of the peristomial field, the latter ovate, obliquely placed at some distance from the frontal border, and extending to near the centre of the ventral surface, the posterior apex continued toward the right-hand side as a short, infundibuliform prolongation, the adoral cilia fringing the left-hand margin being directed toward the right-hand side and vibrating across the peristome field, the right-hand border bearing an undulating membrane; frontal styles numerous, in two curved series, continued posteriorly in two subcentral longitudinal rows of ventral styles, the third series of ventral setæ placed nearer the left-hand body margin: marginal setæ projecting at the posterior border only, where they are largest and most conspicuous; anal styles six or more, delicate and inconspicuous, not projecting beyond the posterior margin but arranged in an oblique row; contractile vesicle single, sub-spherical, in the anterior body-half, near the left-hand body margin and apparently discharging its contents through the dorsal surface; nucleus multiple, scattered or moniliform, the nodules sub-spherical, or broadly ovate; endoplasm finely granular, brownish; animalcule's movements seldom rapid. Length of body 1/150 in. Hab. an infusion containing decaying *Sphagnum*.

Oxytricha setigera. Fig. 10.

Body sub-elliptical, from three and one-half to four times as long as broad, soft, flexible, and contractile, the frontal border rounded, the

* Τριχωτος, hairy; ταξις, rows.

posterior tapering and obtusely pointed, the lateral margins flattened and nearly parallel; dorsal surface rounded, the ventral plane; lip narrow, inconspicuous; frontal and ventral styles five, scattered; anal styles five, all projecting beyond the posterior margin, their extremities usually fimbriated; marginal styles uninterrupted, long and conspicuous; dorsal, hispid setæ long and prominent; peristome field small, obovate, somewhat remote from the frontal margin, the inner or right-hand border apparently bearing a pendent membrane; nucleus double; contractile vesicle single, spherical, situated near the centre of the left-hand body margin, between the nuclear nodules. Length of the body $1/500$ in. Hab. standing pond water.

Oxytricha ludibunda. Fig. 11.

Body ovate, depressed, soft and flexible, less than three times as long as broad, widest and rounded posteriorly, tapering toward the rounded anterior extremity, the right-hand border somewhat flattened, the left-hand margin convex; peristomial field narrow, scarcely arcuate, the right-hand or reflected border ciliate and bearing a membrane; frontal styles about eight, the three posterior smallest and most setose; ventral setæ five in number, two situated near the posterior termination of the peristome field, one subcentrally placed on the ventral surface, and two in close proximity to the five anal styles, the last often fimbriated; marginal setæ largest and most conspicuous at the posterior border; nuclei two, ovate; contractile vesicle single, spherical, near the centre of the left-hand body margin. Length of the body $1/245$ in. Hab. standing pond water with decaying *Sphagnum*. Movements rapid and erratic.

Histrio Sphagni. Figs. 12 and 13.

Body obovate, depressed, about twice as long as broad; posterior extremity rounded, narrower than the anterior, the latter obliquely truncate at the left-hand side; upper lip small, crescentic; right-hand lateral border convex, the left-hand margin somewhat flattened, often sub-centrally concave or broadly emarginate; peristomial field broadly obovate, the posterior apex directed toward the right-hand side, the right-hand border finely ciliated and bearing a membrane; frontal styles nine, the three most posterior smallest and most setose; ventral styles five, two anteriorly, one sub-centrally, two posteriorly placed; anal styles large, only the first and the second on the right-hand side projecting beyond the posterior body margin, the extremities of all usually fimbriated; marginal setæ uninterrupted, those on the posterior margin largest; contractile vesicle single, spherical, on the left-hand side near the apex of the peristome field. Length of body $1/1225$ in. Hab. standing water, with decaying *Sphagnum*.

Fig. 13 shows a diagram in outline of the left-hand body margin

of those forms that present a concavity in the part, the appearance varying from a conspicuous sub-central hollow to a slight depression or even none, as already mentioned.

Histrio vorax. Fig. 14.

Body broadly ovate, often somewhat curved toward the left-hand side, widest posteriorly, the right-hand margin evenly convex, the left-hand side usually concave, yet sometimes almost straight; posterior margin rounded, or in mature and old forms slightly emarginate; frontal border oblique, often somewhat concave; upper lip small, crescentic; peristome extending to the centre of the ventral surface, the right-hand border ciliate and bearing a narrow membrane; frontal styles six or seven, large, uncinatè, with three smaller setæ in an oblique series nearer the right-hand body margin; ventral styles five, two near the apex of the peristome field, two near the five large, broad, fimbriated anal styles, one sub-centrally placed; marginal setæ longer and more prominently projecting beyond the posterior extremity, but there comparatively few and wide apart, only the first, second and third anal styles on the right-hand side usually projecting beyond the body margin; endoplasm usually dark and semi-opaque by reason of the numerous, inclosed, small, dark granules. Length of body $1/150$ in. Hab. standing pond water with decaying vegetation.

Acineta æqualis. Fig. 15.

Lorica broadly sub-triangular, much compressed, the length equal to the width of the anterior margin, the frontal border truncate, somewhat convex, apparently closed except at the slightly produced antero-lateral angles, but probably opening by a transverse slit for the escape of the embryo; gradually diminishing toward the posterior extremity, the lateral borders slightly and sub-centrally constricted, the posterior margin truncate, slightly convex; pedicle in length less than one-half the greatest width of the lorica; tentacles capitate, in two antero-lateral fascicles, one or more presenting externally a spiral aspect; endoplasm coarsely granular, entirely filling the cavity of the lorica; contractile vesicle single, spherical, located in the anterior body-half, near one lateral border; nucleus spherical, sub-centrally located near the lateral margin opposite the contractile vesicle. Length and greatest width of the lorica, $1/750$ in. Hab. attached to the leaflets of *Myriophyllum* and to other aquatic plants.

In form this resembles *Acineta foetida* Maupas, a salt-water species.

Acineta pyriformis. Fig. 16.

Lorica broadly ovate or sub-pyriform in outline, twice as long as broad, obtusely pointed at the anterior extremity, the lateral borders convex, slightly constricted near the truncate posterior extremity; pedicle short, its length less than one-half the diameter of the lorica, often somewhat curved; tentacles few, capitate, protruded from the anterior apex; contractile vesicle in the anterior body-half, apparently single; nucleus not observed; endoplasm usually coarsely granular, entirely filling the cavity of the lorica. Length of the lorica $1/1125$ in. Hab. attached to aquatic plants in shallow ponds.

XI.—*On an Improved Method of making Microscopical Measurements with the Camera Lucida.*

By Sir WALTER SENDALL, K.C.M.G., M.A., F.R.M.S.

(Read 21st October, 1891.)

IN fig. 77, abc is a section, through the plane of the paper, of the draw-tube of the Microscope, in a horizontal position; A is the extremity of the axis of the tube, from which the line AB is drawn perpendicular to the axis, and meeting the plane of the table in the point B . If AB , the height of the Microscope from the table, be

FIG. 77.

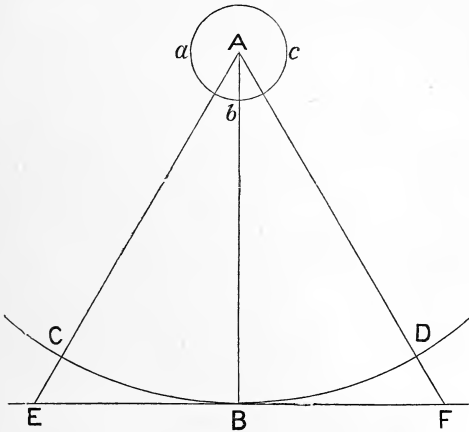

equal to ten inches, and a camera be placed at A , we shall have the arrangement commonly recommended for making drawings and measurements of the virtual image of an object, projected upon the plane surface of the table.

With centre A , and radius AB , describe CBD ; take any points E, F , in the line EBF , and join AE, AF . Then, since the amount of magnification of the object, afforded by its virtual image, is dependent, at every point, upon the distance of the image from the eye placed at A , an inspection of the figure will show that it is only at the point B that we obtain a degree of magnification due to a distance of ten inches. At every other point in the surface of the

table, such as E, F, we get an amplification due to a distance greater than ten inches.

A little consideration will in fact show, that if we desire to investigate the true dimensions of an object by examining its virtual image projected upon an area of uniform magnification, we must employ for this purpose, not the plane surface upon which such measurements are usually made, but a concave spherical surface, having the eye at A for its centre, and for its radius a length of ten inches, or whatever other distance may be convenient to the observer, or may be conventionally agreed upon, as affording a standard by which different observations may be compared with one another.

FIG. 78.

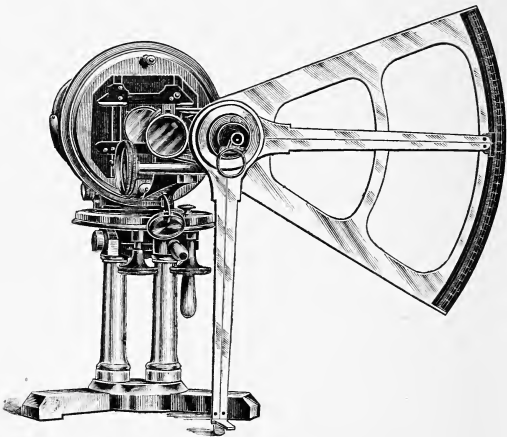

Reverting to the figure, if E F be a measurement taken across the image of an object projected upon the plane of the table, the amount of magnification deduced from such measurement will be in excess of the magnification due to a distance of ten inches, by as much as the length of the straight line E B F exceeds that of the circular arc C B D; and any conclusions drawn therefrom, either as to the magnifying power of the glasses employed, or as to the dimensions of the object under examination, will be affected with a corresponding error.

The error here involved may be corrected by a simple calculation, provided care be taken that the line to be measured is so placed (like the line E B F in the figure) as to be bisected by the central point of

the field; and this can generally be effected with a fair amount of approximation to accuracy. The calculation is as follows.

The line A B, in the figure, being given equal to ten inches, and B E being known by observation, the tangent $\frac{B E}{A B}$ of the angle E A B, and hence the angle itself, becomes known; whence also the angle E A F, which is double of E A B, is known; and the linear value of the arc C B D can then be taken at once from the table of circular values, to be found in every collection of mathematical tables.

FIG. 79.

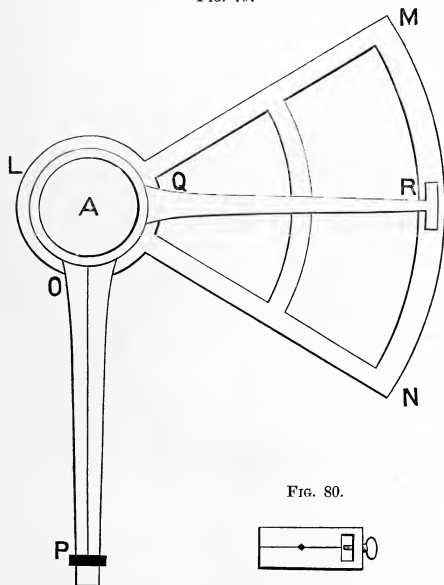

FIG. 80.

Substituting this value for the measurement E F, we obtain a quantity which accurately expresses the dimensions of the magnified image, due to a uniform distance from the eye of ten inches.

By applying a similar calculation in every case, all measurements taken with the camera upon a plane surface can approximately be reduced to their proper values; it would, however, be much simpler and more satisfactory, where accurate results are of importance, to

take our measurements directly along the circular arc $C B D$ of the figure; and this is the object of the instrument about to be described.

A mere inspection of figs. 78 and 79 will indicate the nature of the instrument, and its use.

A , being, as in fig. 77, the extremity of the axis of the Microscope, $L M N$ is a graduated arc of 60° , fitted accurately upon the open end of the draw-tube, and secured in the position shown in the figure, by means of pins or studs which enter into notches cut upon the shoulder of the tube. It is essential that the draw-tube should not be able to turn; in a binocular body this will of course be the case, and in all others it must be specially arranged.

$O P$ is a radial arm, which, together with $A R$, attached to it at right angles, swings freely about the axis of the Microscope. At P is placed a projecting piece, shown separately in fig. 80, which may be termed the speculum; this piece is slipped over the end of the radial arm $O P$, and kept in position at right angles to it by a binding screw. The speculum may be placed with either face uppermost; one being white with a black central line, the other black with a white line.

The arc $M N$ is divided into degrees and parts (not shown in the figure); and at R there is a vernier, reading to the tenth of a part.

To use this instrument, a camera being placed at A , any part of the image of an object in the Microscope can readily be brought upon the face of the speculum; one edge of the image being then brought into contact with the line on the speculum, the arm $O P$ is swung round until the same line coincides with the opposite edge, and the angle passed through is read off upon the arc $M N$.

This will give the dimension of the image, with perfect accuracy, measured along the circular arc $C B D$ in fig. 77, and therefore upon an area of uniform magnification; the linear value of the measurement, to any radius, being ascertained at once from the table of circular arcs.

It is to be noted that the instrument will give accurate measurements only in one plane; that, namely, which cuts the axis of the Microscope vertically, at its point of intersection with the reflecting surface of the camera; the image should therefore be so adjusted that the required measurements may lie along the diameter in which the field is intersected by this plane; this will coincide with the horizontal diameter of the field, as presented to the observer looking through the camera.

It is also obvious that the action of the instrument is independent of the inclination of the Microscope body, or of its distance from the table; all that is requisite is that the radial arm shall have room to swing. The graduated arc may be of any dimensions, and the speculum may be adjusted to any length of radius to suit the observer's sight. In the instrument which Mr. Holtzapfel has made for the writer, the arc has a radius of ten inches, and is graduated in

degrees, halves, and quarters. The least division therefore contains fifteen minutes; and by help of the vernier, readings may be taken to a minute and a half of arc; the linear value of which, to a radius of ten inches, is less than the $\frac{1}{200}$ of an inch.

When constructed upon this scale the instrument requires a somewhat massive stand to support it; but it could easily be made smaller and lighter, though with some loss of range in the graduation.

The black face of the speculum will be found useful, in cases where the field of the Microscope is feebly illuminated; it being often easier in such cases to catch the outlines of the image upon a dark surface, than upon a light one.

SUMMARY
OF CURRENT RESEARCHES RELATING TO
ZOOLOGY AND BOTANY
(*principally Invertebrata and Cryptogamia*),
MICROSCOPY, &c.,

INCLUDING ORIGINAL COMMUNICATIONS FROM FELLOWS AND OTHERS.*

ZOOLOGY.

A. VERTEBRATA:—Embryology, Histology, and General.

a. Embryology.†

Maturation of the Egg-Cell of the Fowl.‡—Prof. M. Holl, after describing young ova, and the formation of the tunica adventitia and the follicle, gives an account of the changes which occur in the nucleus during the process of maturation. In its youngest form the nucleus is circular or shortly oval, and placed in the middle of the egg. It soon becomes round if it was oval, and moves nearer to the surface of the cell. As it increases in size it returns to the centre of the cell. It shortly afterwards becomes flattened on one side, and with this again passes to the surface of the cell. During these changes in position the nucleus is always increasing in size.

The nuclear membrane has at first a distinct double contour, but this is lost as the nucleus grows; the membrane in time becomes almost or altogether lost, and the nuclear contents abut on the elements of the yolk. The nucleolus is, in the early stages of the nucleus, always visible in 2.5μ sections; it is always placed peripherally in a space of the chromatic plexus. After increasing somewhat in size, the nucleolus begins to break up, and finally disappears altogether. The nuclear substance appears at first as an extremely fine plexiform mass, which does not stain; it fills up the narrow spaces of the nuclear plexus and extends in a thin layer between it and the nuclear membrane. This layer soon increases so that it forms an ever widening zone around the spherical plexus. In cross-section the whole of the nuclear substance appears as a disc, in the interior of which is

* The Society are not intended to be denoted by the editorial "we," and they do not hold themselves responsible for the views of the authors of the papers noted, nor for any claim to novelty or otherwise made by them. The object of this part of the Journal is to present a summary of the papers *as actually published*, and to describe and illustrate Instruments, Apparatus, &c., which are either new or have not been previously described in this country.

† This section includes not only papers relating to Embryology properly so called, but also those dealing with Evolution, Development, and Reproduction, and allied subjects.

‡ SB. K. Akad. Wiss. Wien, xcix. (1899) pp. 311-70 (1 pl.).

the circular chromatin body; at first the disc stains only slightly, but with increasing changes of the chromatic substance it becomes darker, and has very fine darker grains scattered in it. This chromatic substance consists, at first, of a close network, which gradually becomes looser and passes into a filamentar coil; this coil increases in extent, becomes looser, and the filaments which form it begin to show cross-structure, that is, they consist of spheres set in rows and connected together by achromatin. As the cross-structure becomes more and more distinct, the particles send off from their surfaces very fine processes into the surrounding nuclear substance. The coil disappears as such, and in its place "supporting cords," which are distinctly cross-structured, traverse the nucleus; the processes, meanwhile, continue to increase in length; they, too, show cross-structure, and appear to send off processes themselves. From the ends of the ray-like processes the smallest cross-pieces are repeatedly broken up, and pass into the nuclear substance. In this way the chromatic cords become broken up, and finally disappear, while at the same time the nuclear substance becomes granular. The grains are so fine that the nuclear substance retains almost a homogeneous consistency.

The essential part in the changes of the chromatic substance of the nucleus consist in this, that what is primitively in the form of a close network increases in quantity and becomes distributed through the whole of the nuclear substance in the form of very fine granules. Finally, there are formed six chromatic rods, one end of which is placed close to the surface of the nucleus, while the other knob-like end projects into its interior; these rods have probably some relation to the formation of directive corpuscles.

When the work of others is compared with the author's results, it seems clear to him that the nuclear network of Amphibia, Birds, and Lizards passes through a regular series of changes during the maturation of the egg-cell, and there can be no doubt that similar, or very similar, changes are to be seen in the nuclei of the ova of other Vertebrates. The changes which occur in the body of the cell, in the tunica adventitia, and the zona radiata are described in detail, as are also the changes which occur in the follicle.

Development of Pronephros and Segmental Duct in Amphibia.*—Mr. H. H. Field has studied the development of these organs in *Rana*, *Bufo*, and *Amblystoma*, and he gives a very detailed account of his observations. He finds that the first trace of the excretory system is a solid proliferation of somatopleure, the pronephric thickening; the lumen of the system arises secondarily, and the pronephric tubules do not appear in consequence of the local fusion of the walls of a widely open pouch, but are differentiations at an early stage from the hitherto indifferent pronephric thickening.

Taking a wider survey of the Vertebrata generally, the author suggests that the pronephros and mesonephros are parts of one ancestral organ; that the glomeruli are strictly homodynamous with the glomus; that the entire tubular portion of the pronephros is represented in the mesonephros; that the cavity of a Malpighian capsule and the nephro-

* Bull. Mus. Comp. Zool., xxi. (1891) pp. 201-340 (8 pls.).

stomial canal connecting it with the body-cavity are detached portions of the coelom, the equivalents of which are not so differentiated in the pronephros. This last is developed as a larval excretory organ, and it is suggested that the period at which it appears largely accounts for its peculiarities of structure.

So far as the excretory organs may throw light on the origin of the Vertebrata, Mr. Field is of opinion that the group of animals which presents nephridia most closely resembling those of Vertebrates is unquestionably that of the Chætopod Annelids, while the Vertebrate excretory system can be readily derived from that of Annelids by a series of steps which are in accord with the evidence afforded by the ontogeny of Vertebrates. At the same time he is careful to point out that none of the evidence is final, for we have no means of saying definitely what part has been played by physiologically similar needs in moulding the structure of the organs.

The author details and discusses the views of the numerous writers who have, especially in recent years, made contributions to this subject.

Breeding and Embryology of Frogs.*—Dr. J. H. Morgan states that the series of diagrams of the segmentation of the ovum ordinarily found in text-books is exceedingly diagrammatic and gives an entirely erroneous impression as to the appearance of the segmenting egg, especially during the later stages. Rauber has given excellent figures of the later stages of frog's eggs, and Dr. Morgan has in many points verified his account. Up to the eight-celled stage the segmentation is very regular, but after that no particular planes of division can be prophesied for any segment.

Newport's experiments on the orientation of the egg are the most to be relied on, and the author has been able to verify his results on a small scale.

Development of Engystoma.†—Mr. J. A. Ryder has some notes on the development of the "frog-toad," as it is called by the natives of North Carolina. The larvæ escape from the envelope three days after the deposition of the ova. Through the whole course of development there is well-marked evidence of the action of gravity in maintaining the equilibrium of the egg, the heavier or light-coloured vegetative pole remaining lowermost. There seems to be no tendency to rotate the egg through ciliary action, previous to the closure of the medullary folds. The fact that no change of position occurs for a long time in the eggs of *Engystoma* would indicate that possibly the future cephalic pole of the egg bears a constant relation to the cephalic pole of the parent, such as is known to be the case in *Batrachus tau*. As such relations between parent and offspring exist to a marked degree, if they are not universal in plants, Mr. Ryder justly remarks that it is desirable to know to what extent this rule holds for animals.

As soon as the larvæ become free they swim about actively; not, however, like a fish, for they revolve on their own long axes; after a day they take to the usual fish-like mode of progression. The adhesive organs of the mouth soon become functional; the head begins to widen

* Amer. Natural., xxv. (1891) pp. 753-60.

† Tom. cit., pp. 838-40.

rapidly, the tail-fold soon becomes very thin, and the general behaviour is much more like that of the larvæ of *Rana*.

Egg and Larvæ of Teleosteans.*—Mr. E. W. L. Holt has a report on a series of observations carried on during the Royal Dublin Society's Survey of Irish Fishing-grounds. Twenty species were identified and nine not. The ova of *Lepadogaster bimaculatus* are attached to the shell by numerous interlacing fibrils which form, by the cohesion of their distal ends a structure resembling a shallow circular basket with a thickened rim, from which are given off numerous fine filaments of considerable length. In *Trachinus vipera* it was observed that the pectoral and pelvic fins were connected by a narrow lateral ridge which may, as Balfour suggested for Elasmobranchs, be regarded as a continuous lateral fin. For the first time the larva of the Dragonet (*Callionymus lyra*) has been hatched out from the egg, and the author gives a detailed description of it. With regard to a very conspicuous egg of an unknown species the author notes that it was only found in comparatively open water.

Development of Ganglia in the Fowl.†—Herr M. Goldberg finds, in sections of embryos of the second day's incubation, a strand of cells dorsal to the medullary canal, and connected with the ectoderm. This strand is derived from the ectoderm, has a secondary connection with the medullary canal, and gives origin to the ganglia of the trunk, to most of those in the head, and also to the peripheral nerve-ganglia. Goldberg confirms the observations of Onodi, Loewe, and others as to the origin of the spinal ganglia. In the head, the Gasserian, ciliary, acoustic, petrosus, jugular, and nodosus develop as the spinal ganglia do; while the genicular, the optic, and the olfactory ganglia develop directly from the brain. As to the origin of the sympathetic ganglia, Onodi's observations are confirmed.

Development of the Genital System.‡—Dr. J. Janošík has made a study of this question; he comes to the conclusion that if all the parts of the generative system were fully developed in Mammals (inclusive of Man) and the Fowl, a hermaphrodite gland would result; in this the testis would be internal, and the ovary superficial, as in lower animals where such relations have been described.

Primitively a gland is formed in which the only epithelial elements are those of the primary proliferation; if the secondary proliferation is weakened or suppressed, the gonad becomes a testis, but if it increases considerably an ovary arises. It follows that the cells from which the sperm is formed are descendants of the cells which arise from the primitive proliferation of the germinal epithelium, and are, therefore, ontogenetically older.

Phenomena of Fertilization.§—Prof. F. Vejdovsky points out that Fol is mistaken in saying that the "centrokinetic theory" was discovered by E. van Beneden and Boveri. In his memoir on *Rhynchelmis*, first published, in Bohemian, in 1887, but deposited in MS. in November

* Scientific Trans. Roy. Dublin Soc., iv. (1891) pp. 435-74 (6 pls.).

† Archiv f. Mikr. Anat., xxxvii. (1891) pp. 587-602 (1 pl.).

‡ SB. K. Akad. Wiss. Wien, xcix. (1890) pp. 260-88 (1 pl.).

§ Anat. Anzeig., vi. (1891) pp. 370-75.

1886, Vejdovsky described the periplast of the male pronucleus, its division, the appearance of daughter-periplasts, &c. The attractive spheres correspond to the periplasts, the central corpuscles to the daughter-periplasts. In contrast to Boveri, Vejdovsky regards the periplast as a structure arising independently of the sperm-cytoplasm; with daughter-periplasts appearing endogenously within it, it is continued in all subsequent divisions of the segmenting ovum. Vejdovsky does not believe in the reality of the "ovo-centrum" which Fol describes as associated with the female pro-nucleus. In the ova of *Rhynchelmis* at least there is no "marche du quadrille."

B. Histology.

Difference between the Nuclei of Male and Female Reproductive Elements.*—Prof. L. Auerbach has studied the male and female reproductive organs and elements of *Cyprinus Carpio*, *Esox lucius*, *Triton taeniatus*, *Rana temporaria*, *Lacerta agilis*, *Gallus domesticus*, &c., and after subjecting sections and preparations to the same technical treatment, finds that the sex-elements differ in nuclear characters. The head of the ripe spermatozoon consists entirely of cyanophilous substance; the tail and the intermediate portion are erythrophilous. In the ova the germinal vesicle is distinctly erythrophilous, and the nucleoli especially so. The same is true of yolk-granules, and of the cell-substance of follicular epithelium. But the substance of the ovum, and the outer layer of the vitelline membrane in the carp's ova, are more or less amphichromatic, sometimes reddish, sometimes bluish. As the head of the spermatozoon and the germinal vesicle of the ovum are the most important parts of the reproductive cells, it may be said that the male fertilizing-stuff is cyanophilous, while the complementary female-stuff is erythrophilous. And as the yolk-corpules are also erythrophilous, this characteristic is preponderant in the female germinal substance. Thus there is a qualitative nuclear difference between the male and the female reproductive elements.

Structure and Division of the Cell.†—Prof. W. Flemming has made a fresh study of epithelial, endothelial, and similar cells from larval salamanders. In division he finds traces of what seems to represent a cell-plate, such as occurs in plants and in some Invertebrates. He calls attention to a change in the cell-substance during mitosis—a peripheral thickening and the appearance of a clear loose internal stratum around the nucleus. He then gives a full account of what he has observed in regard to the attraction-spheres and central corpuscles in leucocytes and other cells, adding some observations to what was previously communicated.

The greater part of the present memoir is devoted to a discussion of cell-division and the origin of the spindle. The rudiment of the central spindle lies outside the nucleus, but Flemming cannot admit that the greater part of the spindle-fibres is due to extra-nuclear material. He is more inclined to believe that it is due to the linin-substances and membrane of the nucleus. But the spindle may well have a double origin.

* SB. K. Preuss. Akad. Wiss., 1891, pp. 713-50.

† Archiv f. Mikr. Anat., xxxvii. (1891) pp. 685-751 (3 pls.).

As to the cause of the initial longitudinal splitting of the chromosomata, this cannot be referred to a mechanical pull exercised by the spindle-fibres. It may be, as Boveri thinks, an independent vital process, a reproduction of chromatin elements; or it may have some relation to the formation of the intranuclear portion of the spindle-fibres. The unravelling of linin-threads from the chromatin of the nucleus may give some stimulus to the biserial arrangement of the chromatin elements which remain.

The "Intermediate Body" in Cell-division.*—Herr B. Solger has studied the division of the connective-tissue cells in the amnion of the rat, and has observed within the bridge between two almost separated cells a rod-like body which stains more darkly than the cell-substance, though less intensely than the chromatin. He refers to previous observations by Flemming and others on this minute structure.

Origin of the Karyokinetic Spindle.†—Dr. F. Hermann has studied this in the spermatocytes of *Salamandra*. The achromatin spindle certainly owes its origin to the cell-substance, to the protoplasm, but it is possible that the achromatin of the nuclear framework has some secondary share. From the dividing centrosomata to the nucleus contractile fibrils are developed, which eventually enter into a secondary connection with the achromatin fibres of the nucleus. All the fibrils which exhibit contractility belong to the cell-substance. In the central part of the completed spindle, fibrils run from polar corpuscle to polar corpuscle without entering into connection with the chromatin elements of the nucleus. But as a kind of mantle over the central spindle there extends another system of fibrils which proceed from the centrosomata to the chromatin elements. These do not run from pole to pole, but are interrupted by the chromatin elements near the equator. Around the centrosomata of the spermatocytes in *Proteus anguineus*, Hermann discovered groups of short, curved threads, which he calls archiplasmic.

Central Corpuscles and Attraction-Spheres.‡—Dr. M. Heidenhain finds attraction-spheres and centrosomata in the leucocytes of *Salamandra*, in the medullary cells of young rabbits, in the alveolar epithelium and leucocytes of the lung of a pneumonic patient, and describes the variations which these exhibit in the different cases.

Attraction-Spheres in Cœlomic Cells.§—Dr. O. Bürger finds, within the proboscis-sheath ("rhynchocœlome") of Nemerteans, resting cells, each with an attraction-sphere and a central corpuscle. The attraction-sphere lies in the long axis of the cell, often towards one end, usually by the side of the nucleus which almost always lies to one side of the cell. The centre of the attraction-sphere lies very near the nucleus, at an almost constant distance. The nucleus was often kidney-shaped, and then the centre of the sphere lay in the concavity. Only twice were double attraction-spheres observed, and the cells do not appear to divide.

* Anat. Anzeig., vi. (1891) pp. 482-3 (3 figs.).

† Archiv f. Mikr. Anat., xxxvii. (1891) pp. 569-86 (1 pl. and 2 figs.).

‡ Anat. Anzeig., vi. (1891) pp. 421-7.

§ Tom. cit., pp. 484-9 (7 figs.).

Division of Leucocytes.*—Prof. W. Flemming recognizes, as others have recognized, that free, colourless, amœboid cells, with polymorphic nuclei, in short with the characteristics of leucocytes, occur as wandering cells in the connective tissue and as inhabitants of the medullary spaces, and that they multiply abundantly by mitosis. It is certain that leucocytes divide both with and without mitosis. Like so many other cells they exhibit attraction-spheres and central corpuscles, but these do not seem to be implicated in the fragmentation or direct division of the nucleus. As to the significance of the two modes of division, Flemming comes to the following important conclusions:—The leucocytes *multiply* by mitosis, only the products of mitotic division live on and multiply; fragmentation of the nucleus, with or without division of the cell, has not to do with the production of new cells, but is a degeneration or an aberration; in some cases, where multinuclear cells are formed, it perhaps influences cellular metabolism by increasing the nuclear surface.

Structure of Striped Muscle.†—Dr. J. B. Haycraft finds that an “impression” of a muscle-fibre on a film of collodion shows in every detail the appearances characteristic of the muscle used to stamp it, in whatever state of contraction or relaxation that muscle may be. This confirms Dr. Haycraft in his previous conclusions as to the structure of striped muscle, for as the stripings are well seen on the films, they must be in part due to varicosities of the fibrils. The interfibrillar substance is of the nature of a matrix perforated by varicose tubes. There are two chief varieties of fully differentiated muscular tissue:—(a) There is the nucleated spindle devoid of sarcolemma and made up of fibrils cemented together, and these spindles may be striped or unstriped, the difference depending upon the rapidity of their contraction. (b) There is a second type consisting of cylindrical threads, sometimes invested by a sarcolemma, and with nuclei within the fibrils, under the sarcolemma, or in both of these situations, and these threads of tissue are striped or unstriped, according to the rapidity of their contraction. Striated muscle is defined as “muscular tissues, the ultimate fibrils of which have become varicose, in association with the power of quicker and more active movement.” When a fibril segments into a number of much smaller portions, each one contracting and relaxing on its own account, the contractions are necessarily more rapid.

Prof. A. Rollett ‡ insists on the reality of the accessory disc (*Nebenscheiben*) or N-stripe of striated muscle-fibres. Retzius has recently maintained that this is merely due to a regular row of sarcoplasmic granules. Rollett maintains that it is due to definite anisotropic segments of the fibrils. This is shown by the appearance in polarized light, in alcoholic maceration, in stained preparations, as well as by the behaviour of the N-stripe during the contraction of the fibre.

Structure of Nerve-cells.§—Sig. G. Magini would make the following additions to the differential characters of nerve-cells. The

* Archiv f. Mikr. Anat., xxxvii. (1891) pp. 249–98 (2 pls.).

† Proc. Roy. Soc. Lond., xlix. (1891) pp. 287–303 (1 pl. and 5 figs.).

‡ Archiv f. Mikr. Anat., xxxvii. (1891) pp. 654–84 (1 pl.).

§ Atti R. Accad. Lincei—Rend., vi. (1890) pp. 19–23; vii. (1891) pp. 277–9.

nucleus has little or even no chromatin. In the motor nerve-cells of Mammals the chromatin is richly distributed in the cell-substance. There is generally a nucleolus, but this is rare in the cells of the neuroglia whose nuclei have many chromatin-granules. In motor nerve-cells the nucleolus is always excentric in position—a morphological fact perhaps of physiological interest.

Bioplasts or Plastidules.*—Drs. L. and R. Zoja have studied in various kinds of cells the bioplasts of Altmann or the plastidules of Maggi. Fuchsinophilous elements or plastidules are widely diffused in all the animals investigated. Their varied distribution in the cell is described, and particular attention is directed to their occurrence in spermatoblasts and spermatozoa. As to the probable function of the plastidules, the authors believe that they are nutritive.

γ. General.

Nature and Origin of Variations.†—Prof. C. Lloyd Morgan took the nature and origin of variations as the subject of an interesting and philosophical address to the Bristol Naturalists.

Exploration of Lakes.‡—Dr. O. E. Imhof reports on recent progress in lacustrine zoology. The littoral fauna—from the shore to a depth of 20–25 metres—is richest. Zacharias has explored forty-two lakes, Seligo sixty-four, Ssowinsky seventy-five, and so on. The fauna of the deep water in Scandinavian lakes contains some forms identical with or closely related to marine forms in the North Sea and Baltic. Numerous Alpine lakes—there are 590 in the Canton of Graubünden—have been searched. Almost all are rich in animal life, which persists even under cover of ice. Trout were found in Lej Sgrischus which lies 2640 metres above the sea-level. Most is known about the surface animals. Of these many have a very wide distribution; a few are quite local in their occurrence; some are restricted to distinct limits of vertical distribution. The list includes about 27 species of Protozoa, about 16 Rotifers, about 27 Copepods, about 46 Cladocera. As to number of individuals, one sample contained about 66,000 forms in a cubic metre, another about 113,040; but the number varies considerably at different periods.

B. INVERTEBRATA.

Animal Chlorophyll.§—Prof. E. Ray Lankester calls attention to Dr. G. Haberlandt's researches on the structure and significance of the chlorophyll-cells of *Convoluta Roscoffensis*. They have led to the suggestion that, whilst phylogenetically the cells must be regarded as Algæ, yet at the present time they have by profound adaptation to life in and with the *Convoluta*, altogether lost their character as independent algal organisms, have become an integral histological element of the worm, and, in fact, constitute its assimilation tissue. Prof. Lankester points out that this hypothesis is in complete accord with the views several

* Mem. R. Ist. Lomb. Sci., xvi. (1891) pp. 237–70 (2 pls.).

† Proc. Bristol Natural. Soc., vi. (1891) pp. 249–73.

‡ Ver. Schweiz. Naturf. Gesell., 1890 (pub 1891) pp. 157–70.

§ Nature, xliv. (1891) pp. 465–6.

times expressed by him that there is no more reason for regarding the chlorophyll-corpuseles of *Hydra viridis* and of *Spongilla viridis* as symbiotic Alge than there is for so regarding the chlorophyll-corpuseles of a buttercup. Whether there is sufficient reason for the latter is a different question, and one not to be hastily dismissed.

It is obviously necessary to distinguish for the present the strongly marked unicellular parasites of Radiolaria and Anthozoa—the “yellow cells”—from the green cells of *Convoluta* and the chloroplasts of various forms.

Marine Invertebrate Fauna near Dublin.*—Messrs. G. Y. and A. F. Dixon have a report of their observations on various marine animals. They find that the number of œsophageal grooves in *Metridium dianthus* is not constant, as it is not unusual to find two. In the process of reproduction by fission it would appear that the parts separated from the parent are not in any way specialized; in some cases, however, there have been appearances of the formation of a bud. In this species one tentacle sometimes becomes greatly elongated and arches over the other tentacles; it ultimately returns to its normal condition, when it is not distinguishable from the others. One large example, while roving through the tank, stumbled across a fine specimen of *Bunodes verrucosa*, over which it poured out such an enormous number of acontia that the *Bunodes* drooped more and more until it died. *M. dianthus*, like *Actinia equina*, has the power of floating on the surface of the water, base upwards. The authors have paid particular attention to the arrangement of the mesenteries in this and other species, on which they have notes. Variations in coloration are also carefully noted.

Peachia hastata appears to have no stinging cells, or weak ones only, for gobies and other small fish rest placidly on it. Its ova were seen to be small spheres, furnished with short, stiff hairs or bristles, which stick out straight from the surface, and do not move like cilia. Gosse's *P. undata* is probably an immature *P. hastata*.

The authors justly remark that Gosse's description of *Zoanthus Couchii* is very general, and includes many forms that are or might be referred to distinct species—one for example is the *Epizoanthus Wrightii* shortly to be described by Prof. Haddon.

Of Crustacea the authors speak only of *Hyas araneus*, and express their belief that its habit of clothing itself with corallines, shells, and other foreign bodies is useful to it by helping to furnish it with the means of catching its prey. If the environment of the crab is changed its dress becomes altered to suit it.

The grace of the motion of *Eledone cirrosa* as it propels itself backward by ejecting water from the funnel is thought to be due to the position in which it folds its arms, always keeping the base of one on either side sharply projecting, so as to make a pair of lateral keels.

Origin and Mode of Termination of Nerves in Ganglia of Invertebrata.†—Herr. W. Biedermann gives first an account of the results of his investigations on *Hirudo medicinalis*. Of the fibres that form the commissures two that are broad generally exhibit a very distinct fibrillar

* Proc. Roy. Irish Acad., ii. (1891) pp. 19-33.

† Jenaische Zeitschr. f. Naturwiss., iv. (1891) pp. 428-66 (1 pl.).

structure, and are thereby specially distinguished from all the rest. The intraganglionic continuations of the commissural fibres are chiefly distinguished by the fact that most of them are branched. But few traverse the internal capsule without giving off numerous branchlets to the dotted substance. It is only at two points, and they are in the plane of the origin of the nerve-roots, that a branch is given off on either side from the bundle of fibrils which passes directly into the root of its side, and with it leaves the ganglion. Along the whole of the inner edge of each half of the internal capsule there are numerous nerve-branchlets which ramify in the dotted substance; these arise from the axis-cylinders which are given off from the roots of the other half of the ganglion. The central fibrous mass, or dotted substance of Leydig, is made up of elements of various origins; it forms an extraordinarily complicated plexus or rather a network of very fine nerve-fibres inclosed in itself; this is partly formed by the branching of the processes of ganglionic cells and partly from root-fibres which branch directly, as well as by lateral branches of the commissural longitudinal fibres which traverse the ganglia.

Nereis pelagica is an animal well adapted for the investigation of the minute structure of the ganglia of the ventral cord by means of methylene-blue. In all essential points there is a resemblance to what is seen in *Hirudo*. In both the most essential morphological constituents of the dotted substance is an extraordinarily complicated plexus of fine and very fine nerve-fibres, which have three points of origin. There are longitudinal fibres which, on their course through the ganglion, give off a number of lateral branches, which branch again. Then there are fibres, which, without becoming directly connected with cells, also branch considerably in the dotted substance, and, finally, a considerable contingent is afforded by the numerous secondary branches of the nervous processes. In both cases two bundles of fibrils traverse the whole of the ganglionic chain; these, in *Hirudo*, give off a branch at each, but in *Nereis* only to the four thickest roots.

The results of a few observations on *Astacus fluviatilis* and *Oniscus* are also given; in the latter the dendritic branching within the dotted substance is richer than has been observed in Worms.

In conclusion the author examines, in a general way, the results he has arrived at, and discusses them chiefly from the physiological side.

Spermatophores as a Means of Hypodermic Impregnation.*—Prof. C. O. Whitman thinks that the following proposition will with difficulty be credited:—The spermatophores represent an injecting apparatus, by means of which the spermatic elements of one individual are forced through the body-wall of another, at any point whatsoever. Such is, however, certainly the case, and may be demonstrated as often as one pleases, on almost any species of *Clepsine*. Without affirming it as a positive certainty, the author thinks there is evidence, little short of conclusive, that this is the normal method of bringing the sexual products together. Long-continued observation under most favourable circumstances has never given him so much as a single indication that the

* Journal of Morphology, iv. (1891) pp. 361-406 (1 pl.).

genital pores are ever united in the act of copulation. On the other hand, the planting of spermatophores on the surface of the body at any point that happens to come first is a common occurrence. Prof. Whitman has followed the track of the spermatozoa from the point of penetration to the coelomic cavity in which the ovaries lie, but he has not yet determined when or how the spermatozoa pass through the wall of the ovisac; that they do so seems to be an inference justified by all the known facts. As the ovarian walls are represented by a thin membrane which becomes enormously distended as the eggs enlarge to maturity, the difficulty of penetration cannot be great; *Peripatus* and the Turbellaria seem to show that spermatozoa are capable of effecting the passage automatically. The discovery of spermatozoa projecting through the ovarian walls of *Peripatus*, as described by Moseley and Sedgwick, ceases to be a mystery.

The author gives a catena of authorities which appears to him to indicate that the original function of the spermatophore was what it now is in the Turbellarians, Rotifers, *Dinophilus*, and *Clepsine*—the injection of spermatozoa through the body-wall. This mode of impregnation is an important advance on the more primitive mode of setting the seminal elements free in the water. This deposition of sperm-capsules at random is further improved upon by restricting the act to a definite region, as the clitellum of Annelids, or the region around the external openings of the oviduct in crayfishes.

Prof. Whitman very justly remarks that what he formerly regarded as positive proof, either of self-fertilization or of parthenogenesis, is now open to some doubt.

An account is given of what was seen in the case of a new species of *Clepsine* (*C. plana*); when first placed in a dish several long white bodies were observed to be attached by one end to the dorsal surface of one or two individuals; those were naturally thought to be parasites. But, when put under the Microscope, a stream of spermatozoa was seen slowly issuing from the end that had been detached. Closer observation showed the mode of deposition; one individual, coming in contact with another, fixed itself by its oral sucker to some convenient point, and then, while pressing its protruded male pore against the back of its fellow, planted a fresh sperm-case. During the operation, which lasted only a few seconds, the region of the genital pores was more or less constricted, somewhat as it is in the act of forming an egg-cocoon. The case was, very likely, filled with spermatozoa by this act. This operation was repeated by the same individual several times in a period of thirty minutes; one of the first deposited spermatophores was 8 mm. long and 1 mm. wide; some of the last only 3 mm. or even less.

In the spermatophore it is possible to distinguish (1) a short constricted basal portion with a single tubular lumen, formed in the median unpaired portion of the male organs; (2) an elongated body with a double saccular lumen, formed in the enlarged terminal portions of the common vasa deferentia; and (3) a free end, consisting of two parts with the lumen closed or reduced to a narrow line, and formed in the ends of the ejaculatory ducts. The wall of the spermatophore is composed of two well-defined layers, the outer of which is thin, transparent, and cuticula-like, while the inner is denser, thicker, and stainable.

When first placed, the spermatophore usually stands nearly perpendicular to the surface, and considerable force is required to detach it; its mouth is completely plugged up with a peculiar secretion formed of elongated elliptical or spherical corpuscles; these dissolve in water in the course of a few minutes. They seem to serve not only as a means of protecting the spermatozoa against contact with water, but also as a means of opening and clearing the way for the safer penetration of the spermatozoa, for this mass is impelled through the skin in advance of the spermatophore. In the course of an hour the greater part of the contents of the spermatophore will be found to have escaped. What happens when a spermatophore is produced may be supposed to be somewhat of this kind:—As soon as the sperm-case is ready for the reception of its burden, the corpuscular secretion and the spermatophore are driven forward into it. The spermatophore would sweep the corpuscular mass before it, and leave it in the basal portion of the sperm-case. The author is inclined to think that the charge is measured off each time in the ejaculatory ducts, and that the contents of the vesiculæ seminales are brought forward only to replace what has been ejected.

After some interesting extracts from various memoirs in which the mode of impregnation is discussed, the author concludes with drawing attention to the sceptical attitude adopted by Dr. Hudson* towards Dr. Plate's statements regarding the injection of spermatozoa through the body-wall. As may be supposed, Prof. Whitman is inclined to accept Dr. Plate's account.

Mollusca.

Phylogenetic Affinities of Mollusca.†—The essay of Herr J. Thiele has a much wider scope than his principal title would lead us to suppose. The following is the conclusion at which he arrives:—The decentralization of the organs is the ground-plan which is exhibited in the organism of Cœlenterates and Polyclads. Each system of organs extends over the whole body. The higher Bilateria, on the other hand, show a more or less extensive centralization; the enteron ceases to be branched, the numerous germ-glands unite; motor ganglionic swellings are formed; while the newly formed blood effects a distribution of the nutrient or excretory materials through the body, there are formed instead of water-vessels the primitively more localized nephridia; the respiration of the whole surface becomes limited to special respiratory organs, and arterial blood is distributed through the body.

The swimming movement, which was effected by cilia, is given up by the Cnidaria and Porifera, as well as by the Bilateria; but cilia are retained by Sponges, Polyclads, and other Turbellaria, and by the Nemertinea; the cilia disappear from a large part of the body in Gastrotricha and Rotifers, Molluscs and Annelids, while in some groups they may disappear altogether. Their place is taken by the development of more or less strong cuticular structures, which afford the animals a better protection against unfavourable external influences, which must be of very great significance to the slow-swimming Mollusca

* This Journal, *supra*, p. 6.

† Jenaische Zeitschr. f. Naturwiss., lv. (1891) pp. 480-543.

and to fixed animals. Hermaphroditism is completely retained by Ctenophores and Polyclads, and it is only in the higher forms that the Bilateria are seen to have the sexes separate. The Solenogastres are still partially hermaphrodite, and some of the larger groups of Molluscs and Annelids which have hermaphrodite glands appear to retain the primitive relations. The gonochorism of Cnidaria and of Rotatoria is a secondary character, as, in the author's judgment, is shown by the phylogenetic affinities of these animals.

The author deals with his subject under the following heads:—

- (1) General Phylogenetic Laws; (2) Development of Cœlenterata from colonies of Flagellata; (3) Relation of Ctenophora to Sponges; (4) of the same to the Cnidaria; (5) Relation of Polyclads to Molluscs; (6) Affinities of the Amphineura; (7) Derivation of the Trochophore; (8) On Substitution of organs.

Tasmanian Mollusca.*—Mr. R. M. Johnston has published an introductory paper which he calls a provisional aid to the study of Tasmanian Mollusca. Something of the kind appears to be needed, for more than seven hundred species are known to exist in this area.

γ. Gastropoda.

Development of Central Nervous System of Pulmonata.†—Dr. F. Schmidt gives an account of his observations on the development of the central nervous system in *Limax agrestis* and *Clausilia laminata*. He agrees with those of his predecessors who derive the entire central nervous system from the external epithelium; the central ganglia arise from the epithelium of the sensory plates in the form of solid proliferations; soon after their separation from them the plates give off three blunt papillæ on each side to form the foundations of the two tentacles and the oral lobes. The epithelium of three of the tentacles gives rise by proliferation to the tentacular ganglia. The two pedal ganglia appear at the same time as the central, and are derived from the epithelium of the foot-plate. The visceral ganglia do not appear till later; they arise by proliferation of the epithelium in the neighbourhood of the orifice of the two primitive kidneys.

At this stage of development the nervous system of the Pulmonata exhibits a remarkable agreement with that seen in such Lamellibranchs as *Unio* or *Cyclas*. The subsequent changes in relative position may, Dr. Schmidt thinks, be thus explained:—After the several pairs of ganglia have separated in the embryo from the epithelium of the surface of the body and have become connected together by means of commissures, they form an integral system of organs, the further development of which proceeds quite independently of the increase in size and the unequal development of different parts of the body. Ganglia increase more rapidly in size than the commissures which unite them.

Structures known as cerebral tubes arise from the sensory plates after the formation of the foundations of the central nervous system. They first arise as sac-shaped invaginations of the epithelium of the sensory

* Papers and Proc. Roy. Soc. Tasmania, 1890 (1891) pp. 57-151.

† SB. Nat. Ges. Univ. Dorpat, ix. (1891) pp. 277-82. See Ann. and Mag. Nat. Hist., viii. (1891) pp. 186-9.

plates which appear, on each side, below the eye-tentacle, and grow in deeper and deeper until they finally come into contact with the cerebral ganglion of one side or the other. The lumen of the tube subsequently closes and loses its connection with the external epithelium, till at last it is transformed into a roundish mass which becomes completely fused with the corresponding cerebral ganglion; the boundaries of the original can, however, be subsequently made out as the small constituent elements take a much deeper stain than those of the cerebral ganglia. The author agrees with the Doctors Sarasin, the original discoverers of these tubes, in regarding them as corresponding to the cephalic pits and similar organs of various worms.

Growth of Shell of *Helix aspersa*.*—M. Moynier de Villepoix has investigated the growth of the shell of this snail. The epidermis with which it begins is peculiarly interesting on account of the presence of hyaline spherical globules, 10–12 μ in diameter, which cover its outer surface. They are organic in nature, and persist in the oldest shells. Calcareous matter is deposited on the inner surface of the epidermis at some distance from its edge. There is a white zone which is a gland formed of lageniform cells, with very elongated necks and granular contents; this is shown to contain calcareous matter. Behind this zone the mouth is covered by a cylindrical epithelium which contains pigment or colourless granules. In front of the zone the epithelium is invaginated to form the groove in which the free extremity of the epidermis is lodged. The bottom of this groove is occupied by an irregular plexus of cells, which appear to be epithelial; they contain transparent spherules, which present all the characters of the globules of the epidermis. This tissue forms a series of pockets in the connective tissue; the spherules grow at the expense of the protoplasm of the cells, which at last contains nothing but them. When set free the spherules collect on the fine organic membrane which is secreted by the epithelium.

The calcareous glands of the collar do not take any part in the formation of the shell, which is formed solely by (1) the pallial groove, in which are found the epidermis and the glandular pouches which produce the globules and which are now described for the first time; (2) the pallial band or gland which secretes the calcareous matter; (3) the pallial epithelium behind the gland which furnishes the pigment for the shell, and completes its calcification by the deposit of organo-calcareous layers, homologous with the nacreous layer of Lamelli-branches. When the animal has attained its definite size the band and the globe-glands completely disappear. The epithelium of the mantle and of the pulmonary sac alone remains active to serve in the internal thickening of the shell and not to repair its losses. The secretory activity of the pallial epithelium is so great that the author was able, for a period of two months, to see animals, deprived of food, reproduce every day the organo-calcareous membrane which he removed every morning.

Habits of a *Murex*.†—Dr. Ph. François writes that he has observed a species of *Murex* ("*M. fortispinna*"), at Noumea, in which one of the

* Comptes Rendus, cxiii. (1891) pp. 317–9.

† Arch. Zool. Expér. et Gén., ix. (1891) pp. 240–2 (1 fig.).

serrations at the mouth of the shell forms a prominent tooth-like process; and that this often looks worn, when the adjoining processes are intact. He one day saw one example of this species devouring a large *Arca*, and noticed that the tooth in question held apart the valves of the Lamelli-branch and prevented them closing; the *Murex* was thus able to insert its proboscis and devour the unfortunate bivalve. The *Arca* (*Anadara pilosa*) is very difficult to detect, and shuts itself up at the least alarm.

Development of Paludina.*—Herr R. v. Erlanger has studied the development of *Paludina vivipara* with special reference to the development of the pericardium, the heart, and the persistent nephridium. In the young gastrula there are no hints of primitive mesoblasts; the mesoderm has its beginning in a ventral diverticulum of the archenteron. The cœlomic sac thus formed subsequently surrounds the gut in a bilaterally symmetrical crescent-shaped fold. Finally the mesoderm breaks up into spindle-shaped cells, which cross the body-cavity irregularly, but line the ectoderm on the one hand and the gut on the other. Erlanger believes that the mesoderm of Gastropoda is typically derived from the endoderm, in enterocœlic fashion, and thinks that the ova of the primitive forms had probably little or no yolk. A posterior aggregation of mesoderm cells, usually paired to begin with, represents the incipient pericardium; the septum between its two divisions is soon ruptured and absorbed. An evaginate thickening of the right side of the pericardium represents the beginning of the permanent nephridium. The development of the secreting portion of the kidney from cœlomic epithelium justifies the homology between the nephridia of Molluscs and of Annelids. On the left side there is a diverticulum which makes no progress; it represents the rudimentary left nephridium. The heart appears as an invaginate groove on the dorsal wall of the pericardium. This groove is somewhat curved, and is at an early stage slightly constricted in the middle. It gradually becomes a tube, retaining an anterior and posterior communication with the secondary cœlom. The median constriction is the first hint of the division into auricle and ventricle. The author also describes the pair of primitive nephridia which lie to the right and left behind and below the velum. The occurrence of primitive and permanent nephridia suggests that the Molluscs have developmentally two segments.

The Genus Atopos.†—Dr. H. Simroth describes the structure of this new genus of Vaginulidæ. He has studied three (all new) species:—*Atopos Semperi*, *A. Leuckarti*, and *A. Strubelli*. The internal anatomy is very peculiar. The heart, kidney, and lung are even further forward than in *Limax*, a position so divergent from that in *Vaginula* that Semper sought to refer *Atopos* to the Limacidæ. The mouth has no jaw-plate; the radula-sheath is remarkably developed and hidden in a special sac; the sharp rapacious teeth suggest those of Testacellidæ. From the mouth a pharynx leads to a short and narrow intestine, with a single but very large mid-gut gland in which the digestion takes place. The foot-gland is free, and around its

* Morphol. Jahrb., xvii. (1891) pp. 337-79 (4 pls.).

† Zeitschr. f. Wiss. Zool., lii. (1891) pp. 593-616 (1 pl.).

aperture there is a thick white mass formed from numerous accessory tubules. A pair of large and remarkable glands with long efferent ducts opening at the sides of the mouth, are described provisionally as spinning glands. The reproductive organs are like those of *Vaginula*; the female genital aperture is beside the anus and pulmonary aperture; the vas deferens extends forwards under the epidermis; the penis has no accessory gland. The œsophageal ring is very narrow. The whole of the interior is without pigment; the external pigmentation varies even within the limits of one species. Shell and shell-sac are as completely unrepresented as in *Vaginula*. Dr. Simroth describes the minute anatomy of the organs, and then compares the three genera *Onchidium*, *Vaginula*, and *Atopos*, which he regards as links of one genetic chain.

Development of Liver of Nudibranchs.*—M. H. Fischer has made a study of the young of *Eolis exigua*. When the larvæ escape the digestive tube is composed of a moderately long œsophagus, an ovoid stomach, and an intestine. In the anterior region of the stomach organs lie to the right and left; that on the left is a sac of some size, the cavity of which opens into the digestive tube and is lined by large cells with very fine cilia; these cells are capable of intracellular digestion, and the sac is the active digestive organ of the larva. The organ on the right is very small, and appears to have no function. The two form respectively the right and left lobes of the liver; the larval stomach has no relation to the similarly-named part in the adult. The two lateral organs increase in size, and in time the right hepatic lobe gives off a bud which goes to the right dorsal papilla and the left one which goes to the left, while behind it are a pair of buds destined for the second pair of papillæ. The liver of the adult Dorid is composed of a principal and of an accessory mass which seem to be derived respectively from the right and left lobes of the embryo.

Integument of Chiton.†—Herr J. Blumrich describes the structure of the decalcified dorsal shells of *Chiton siculus*, *Ch. lævis*, *Ch. Polii*, and *Acanthochiton fascicularis*, the disposition, arrangement, and development of the æsthetes and their fibrous strands, the mantle margin and its spines, and finally the epithelium of the branchial groove, the smelling organ, and the foot. The ectodermic epithelium in Chitonidæ typically consists of two kinds of cells, thread-like and glandular, with a simple cuticular fringe. This type is seen in the epithelium of the sole and in the glandular epithelium of the wall of the foot and of the olfactory organ. On the mantle-wall of the branchial cavity, the epithelium consists of cubical ciliated cells and is only locally glandular. The epithelium of the mantle is most divergent, for its cells have a very strong cuticular covering. This may be chitinous as in the "cuticula" and the "tegmentum," or calcareous as in the "articulamentum" and the spines. The glandular cells on the mantle are mainly restricted to the æsthetes and to most of the spine-bearing papillæ. There is no real difference between cuticula and tegmentum, the latter being simply the cuticula continued over the articulamentum.

* Arch. f. Naturgesch., lvii. (1891) pp. 75-104 (5 pls.)

† Zeitschr. f. Wiss. Zool., lii. (1891) pp. 404-76 (8 pls. and 1 fig.).

The entire mantle may be said to be covered with a cuticular shield, which outside the region of the shell bears calcareous spines. As the articulamentum alone is comparable with the ordinary Gastropod shell, and as the cuticula covers all, it seems certain that the cuticula is phylogenetically the more primitive. Herr Blumrich sketches the possible evolution of the shells from spines, and of the æsthetes from specialized papillæ of the mantle, but we cannot enter into the detailed results of his investigations. In a preface, Prof. Hatschek discusses the general importance of this study, which has obvious bearings on the question of the relationship between the Chitonidæ and the Aplousobranchia. Pelsener's conclusion is corroborated that *Chiton* is nearer the primitive type than *Chitonellus*, and that *Neomenia* and *Chaetoderma* are degenerate forms.

3. Lamellibranchiata.

The Free-swimming Larva of Dreissena.*—Prof. F. Blochmann has found this larva, which has strangely escaped earlier discovery. It swims freely and seems to be abundant in the Ober-Warnow at Rostock, where *Dreissena* has firmly established itself. The transparent ova are extruded in clumps at the bottom of the stream; only the larvæ rise in the water. Dr. E. Korschelt has also found the larvæ, and will study their development.

Circulation in Arca.†—Dr. P. François has a note on the circulatory apparatus of *Arca barbata* (?). The auricles are almost triangular with the bases widely separated, so that, superficially, they look like two hearts; the ventricle is much reduced, and forms a sort of aortic bulb; the aorta, on leaving the heart, passes forwards, and to the right; it gives rise, on its left side, to three or four secondary trunks. The blood is like that of Vertebrates, coloured with a little water. This colour is due to a large number of very flat elliptical corpuscles which are all about 21 μ across. These observations have been verified on *A. pilosà* (?).

Molluscoida.

a. Tunicata.

Tunicata.‡—Prof. W. A. Herdman has published a revised classification of the Tunicata, in which he gives definitions of the orders, sub-orders, families, sub-families, and genera, with analytical keys to the species. He now takes a more extended view of the group than he was able to take in his 'Challenger' Reports. Among the Cynthiinae there are the new genera *Rhabdocynthia*, which is established for the reception of those species which are provided with needle-like or rodlike spicules of carbonate of lime scattered through their tissues, and *Forbesella*, for *C. tessellata* of Forbes, which is remarkable for having only four folds on each side of the branchial sac. Among the Clavelinidæ *Rhopalopsis*, *Podoclavella*, and *Stereoclavella* are new generic groups which material recently acquired by the author has led him to establish. The

* Biol. Centralbl., xi. (1891) pp. 476-8.

† Arch. Zool. Expér. et Gén., ix. (1891) pp. 229-31 (1 fig.).

‡ Journ. Linn. Soc. Lond., xxiii. (1891) pp. 558-652.

monograph is one of the kind that is of great value in the present state of zoology.

New and Primitive Type of Compound Ascidian.*—Mr. W. Garstang describes an interesting form of compound Ascidian which he dredged off Plymouth in 5 to 15 fathoms. He calls it *Archidistoma* (*A. aggregatum*) and defines it as having incrusting colonies, and consisting of a spreading basal portion from which zooids arise at irregular intervals. Zooids free and partially fused, with distinct oral and cloacal apertures. No incubatory diverticulum of the cloaca. The test is arenaceous and there are about thirty tentacles; the ova are large and contain much food-yolk.

Archidistoma is a connecting link between the true Distomidæ and the Clavelinidæ. No true Distomid is known to possess free zooids, that is, zooids not completely imbedded in a common test. This new form, therefore, combines the structural characters of the Distomidæ with a social form of colony which is only slightly removed from that of the Clavelinidæ. It is also of especial interest because it exhibits the first stage in the evolution of the cœnobitic type of colony from the social Ascidian type, in which the zooids are entirely free and irregularly placed. Though the clumps of its zooids have no common cloaca, the cloacæ of the individuals are usually situated towards the centres of the groups.

β. Polyzoa.

Freshwater Polyzoa.†—Dr. F. Braem begins his memoir with a faunistic account of the freshwater Polyzoa of Prussia, where all the species known to be native in Europe are represented. He then passes to the problems connected with the development and reproduction of the Phylactolæmata. In *Cristatella*—and the same is true for the others—all the buds of the colony are traceable to a limited complex of embryonic cells, left over from the material of the statoblast or of the ovum, and carried on from bud to bud. This relation is expressed as the "principle of the double-bud," each bud usually forming, on its oral aspect and directly from itself, two daughter-buds, which multiply in the same way. In youth more than two buds may be formed; in older stages sometimes only one. The cystids—portions of the colonial wall interpolated between the polypides—also develop from the cells of the polypoid rudiment. The varied growth of the stock is discussed in detail. Besides the budding of individuals, there is budding of the entire colony. The movement of the *Cristatella*-stock is an essential condition of its growth. Dr. Braem then describes the development of the individual, the formation of the funiculus, and the origin of the statoblasts. He is convinced that the statoblasts are derived from both layers of the budding which leads to the formation of the germinal cells in the funiculus. The formation of statoblasts is like that of the buds; all are referable to older buds, which from the first divide into material for the upbuilding of the colony and material for the continuation of the species. The author then discusses the environmental conditions—such as cold—

* Ann. and Mag. Nat. Hist., viii. (1891) pp. 265-8 (2 figs.).

† Bibliotheca Zool. (Leuckart and Chun), vi. (1890) 134 pp., 15 pls. and many figs.

which favour the development of the statoblasts, and describes the complex internal processes which then occur. The germinating statoblast is equivalent to a single bud of the stock, or to a single cystid with its associated polypide. But in the stock the cystid develops from the polypoid bud, while the reverse is true of the statoblast, in which the cystid is primary and gives rise by folding and contraction to the polypide. The statoblast is like a bud, but with an inversion of the germinal layers. The bud is an individual developing from the polypoidal pole with a secondary formation of the cystid; the statoblast is an individual developing from the cystidal pole with a secondary formation of the polypide. Dr. Braem also describes the sexual reproduction, which in a general way may be thus contrasted with reproduction by statoblasts:—The statoblast is an individual formed by budding, retained within the maternal colony, destined after the death of the latter and a resting period to continue the old stem; the fertilized ovum leaves the maternal colony while that still lives and is destined to begin a new stem. The embryonic cystid of the larva is a formation *sui generis*, and not comparable with the external part of the statoblast rudiment. This important memoir, the nature of which we have merely outlined, closes with a description of *Paludicella Ehrenbergii*.

B. Bryozoa.

Free Development in Ectoproctous Bryozoa.*—M. H. Prouho calls attention to three cases of free development in this group; these are represented by *Acyonidium albidum*, *Membranipora pilosa*, and *Hypophorella expansa*; as these three forms differ not only in important morphological characters but in habitat and habits we may conclude that the *Cyphonautes* form is the larva of all Bryozoa whose ova undergo free development.

γ. Brachiopoda.

Anatomy of *Lingula*.†—Dr. P. François found that *Lingula anatina* could be detected by a small cleft in the sand which closes suddenly. Having discovered this he was able to get, in less than an hour, thirty specimens, of all sizes, from .015 m. to .05 m. in length. This proves that the form lives for at least more than a year, and that it therein differs from its ally *Glottidia*, which, according to Morse, attains its full development in one year. *Lingula* lives upright in its burrow, the upper part of the shell being flush with the surface and projecting at those points which correspond to the three tufts of long setæ on the upper edge of the mantle. The burrow in which it lives is not a tube in the sense of the "tube" of Annelids, for the sand is merely pushed aside, while the interior is lined with mucus secreted by the *Lingula*. The peduncle is greatly elongated and its lower part is lodged in a true tube of sand agglomerated by mucus; when the creature feels the approach of danger, the peduncle is suddenly contracted on itself, and the shell brought down to the mouth of the tube; the downward movement is effected as rapidly as that of a Serpula, and it often results in the com-

* Comptes Rendus, cxii. (1891) pp. 1316-8.

† Arch. Zool. Expér. et Gén., ix. (1891) pp. 231-9.

plete closure of the small cleft which alone revealed the presence of a *Lingula*. As in all Brachiopods the vitality is very great.

On each valve there are five muscular insertions—some for the adductors and protractors of the dorsal valve, others, more posterior, for the rotators and retractors of that valve. With regard to the circulatory apparatus the author has not been able to see the contractile ampulla described by Morse as situated in the mantle. In each of the canals of the mantle the blood is constantly directed along an outgoing and an incoming current, and the boundary of each current is so sharp that one is tempted to believe that each series is divided into two parts by a longitudinal septum. All the vascular ramifications end in rounded culs-de-sac, at the bottom of which the current makes a half-turn on itself. The arrangement of the trunks is such that each of them and of the branches of the sinus-system fulfils by itself at one and the same time the function of an artery and of a vein. In the body-cavity the circulation of blood is aided by the lining cilia; the mesenteries contain lacunæ. The body-cavity is prolonged into the arms and stalk; in the former there are three canals—a central sinus, the canal of the cirri and a very small labial canal. The author, in distinction to most who have written on the subject, regards the mantle and not the arms as the chief organ of respiration; and he thinks that the fleshy and muscular structure of the latter, and their thick envelope suffice to show this.

The blood is opaline and of a rosy violet; it contains a large number of corpuscles. These are more or less conical in form, and are from 20 to 25 μ in diameter.

The stalk consists of several distinct layers—an outermost, delicate, chitinous cuticle; a hyaline gelatinous layer, cartilaginous in consistency, and showing in section that it is formed of concentric lamellæ; a delicate layer of transverse muscular fibres; and a layer of longitudinal muscular fibres; there is a central cavity in which the blood circulates. In life, the stalk looks like a crystalline rod with an opaque white axis. In all the living specimens the stalk was seen to end in an ampulla, which was gorged with blood, but it has a delicate wall; it secretes the hyaline matter which surrounds the stalk. If, as often happens, a stalk is broken at its insertion into the mantle, the wound cicatrizes rapidly, and a small bud is formed which begins to elongate: it soon secretes a hyaline envelope. Dr. François kept specimens for at least six weeks in perfect health; he observed that they moved the valves of the shell in the most remarkable manner, now rubbing them on one another as a man does when he hears a piece of good news, and now moving them laterally, like the jaws of a ruminant. Now and again they contract rapidly, expel the water and draw themselves down on their stalk.

Arthropoda.

a. Insecta.

Embryology of Insects.*—Prof. v. Graber describes the development of *Meloë scabriusculus* Brdt. At a certain stage the ptychoblast shows on its inner side a hint of the ento-merosomes, but there is no segmentation of the ptychoblast into macrosomites. As regards the

* Zool. Anzeig., xiv. (1891) pp. 286-91.

curvature of the germinal streak, this species of *Meloë* comes between *Lina* and certain Hymenoptera. Of the gastropyche only the caudal part at first develops; this extends forwards in two lateral processes, so that the contour has the form of the letter M; between the two lateral lobes the ptychoblast appears; the primitive head-lobes are still uncovered, even when the caudal fold has almost reached them; the ectoptygma persists as in *Lina*. The upper lip arises from paired swellings on the anterior margin of the protocephalon. The rudiments of the antennæ are visible even when the blastopore is still recognizable. The appendages of the first abdominal segment appear almost at the same time as the buds of the thoracic appendages, with which they are evidently homologous. On the following abdominal segments the appendages, whose existence is denied by Carrière but observed by J. Nushbaum, are at a certain stage distinctly bilobed. There are eight, not seven pairs of abdominal stigmata. Three pairs of Malpighian vessels arise as evaginations of the proctodæum. The incipient brain exhibits a single patch of dotted substance, most of the ventral ganglia show two. On very young embryos of *Hydrophilus piceus*, Graber has observed the bilobed character of the most anterior abdominal appendages. In very young embryos of *Gryllotalpa vulgaris*, the earliest rudiments of the most anterior abdominal appendages show the characteristic trilobed form of the thoracic appendages. Finally, Graber dissents from Cholodkovsky's interpretation of "lateral gastrulation."

Abdominal Appendages of Insect Embryos.*—Dr. v. Graber once more returns to the problem of the morphological import of the ventral abdominal appendages of insect embryos. Wheeler and Carrière regard these structures, especially the most anterior, as glands which were functional in ancestral forms. Graber regards them as remnants of appendages. The development suggests this; so do those cases in which they persist throughout life; the incipient rudiments are sometimes segmented; they may contain, like the limbs, a mesocoelic diverticulum; such are some of the arguments which Graber uses. He gives a table showing the different ways in which the appendages are reduced. The anterior or "prosthypogastric" structures may be reduced by constriction, by invagination, or by both, or by gradual flattening off; in the latter way most of the posterior or opisthopyogastric appendages disappear.

Protective Mimicry in Insects.†—Mr. E. B. Poulton draws attention to a Homopterous Insect from British Guiana, which mimics a leaf-carrying ant carrying its leaf. He suggests that we have here to do with a palatable insect much relished by insect-eating foes, which defended itself by acquiring a protective resemblance to leaves. The green colour and compressed body were probably evolved in response to the need for concealment. As the foes increased in acuteness, and penetrated this common disguise, it became of advantage to certain hard-pressed forms to resemble something which was positively objectionable to their enemies rather than merely useless and uninteresting. In the present case the transition from protective resemblance to protective

* Morphol. Jahrb., xvii. (1891) pp. 467-82 (6 figs.).

† Proc. Zool. Soc. Lond., 1891, pp. 462-4 (1 pl.).

mimicry would be especially easy, for it would be brought about by comparatively insignificant modifications of colour and form. The mimicking insects appear to be a species of *Stegaspis*, one of the Membracidae, and the Ant mimicked is the Cooshic Ant (*Ecodoma cephalotis*).

3. Arachnida.

Oviposition and Cocoon-weaving of *Agelena labyrinthica*.*—Mr. C. Warburton remarks that no accurate account appears to have been published of the cocoon-weaving of this form, one of the largest and most abundant of British species. If placed in a box, web-spinning begins by the stretching of a number of foundation-lines across the box at the level of the future sheet; the spider then walks to and fro along these lines, strewing them with numerous threads from its long, up-turned, posterior spinnerets; at last an almost opaque white sheet becomes formed. The approach of oviposition is indicated by the animal commencing to weave a hammock-like compartment from the roof of the box and above the sheet-like web, to which it is braced by lines. Oviposition takes between five and ten minutes, and the eggs are entirely enveloped in a coating of soft material of loose texture. The final process is the construction of a closed box or case with the egg-bearing sheet for its roof; this is a beautiful filmy transparent structure.

The work is very varied and perfectly regular in the sequence of its variations; the author has been able to show that the work is performed even if the eggs are removed immediately after they have been laid; this extends and confirms the remarkable experiments on bees made by Fabre.

Copulation of Water-mites.†—Herr F. Koenike describes the peculiarities of the male *Curvipes fuscatus* and its remarkable copulation. The fourth joint of the hindmost leg is much incurved and bears strong bristles; the last joint of the third leg is shortened, curved, slightly swollen, and clawed; behind the very small genital aperture a chitinous receptaculum seminis projects into the body-cavity. At the breeding season the male keeps the tips of both of the third legs in the sperm-sac. The female offers prolonged resistance, but is gradually quieted. With the third legs the male seems to stir up the sperm-sac until emission occurs. With the bent joint of the last leg the male seizes the base of each of the fore legs of the female, the bristles making the grasp secure. The modified third legs are then used to transfer the semen, which forms a viscid mass of spermatophores and minute sharp spines. The latter may help to break up the spermatophores. The seminal mass is not directly placed in the vagina, but is fixed to the body of the female.

Anatomical and Physiological Notes on Ixodidæ.‡—Prof. A. Batelli has investigated *Ixodes reduvius*, *Ixodes hexagonus*, *Phaulixodes rufus*, *Rhipicephalus sanguineus*, and *Hyalomma marginatum*. He first describes the buccal apparatus with its stylets, rostrum, buccal glands, &c. In connection with the gut, he discusses the hepatic cæca which serve two purposes—storing and digesting. The destructive changes

* Ann. and Mag. Nat. Hist., viii. (1891) pp. 113-7 (1 pl.).

† Zool. Anzeig., xiv. (1891) pp. 253-6 (1 fig.).

‡ Monitore Zool. Ital., ii. (1891) pp. 78-84, 98-104 (1 fig.).

in the hepatic cells are then described. In the food-canal the blood loses all traces of red corpuscles, and forms a homogeneous reddish-brown mass, sometimes with crystals. Batelli supplements Pagenstecher's vague description of the Malpighian tubules, and describes the tracheal system which is genetically integumentary. A stigma is morphologically derivable from a group of hairs. The Ixodidæ have no eyes, nor apparently any dermoptotic sense, but there are various seemingly sensitive setæ on the appendages.

Post-embryonic Development of Acarida.*—Dr. P. Kramer has studied *Diplodontus filipes* Dugès and *Nesæa fuscata* C. L. Koch. He distinguishes in the developmental history of Acarida (1) a *Tarsonemus* type in which a hexapod larva—in adult form—leaves the egg; (2) a *Trombidium* type (Trombidiidæ and Hydrachnidæ) in which an octopod nymph is interpolated between the larval and the adult form; (3) a *Tyroglyphus* type (Sarcoptidæ, Tyroglyphidæ, Gamasidæ, Demodicidæ) in which two nymph stages occur, and (4) an *Oribates* type (Oribatidæ) in which there are three nymph stages.

A Hermaphrodite Spider.†—Dr. Ph. Bertkau describes a species of *Lycosa* which exhibited the epigyne of a female and the swollen palp of a male, and had degenerate reproductive organs apparently most like diseased testes. His list of casually hermaphrodite Arthropods now includes 361 forms—9 Crustaceans, 3 Arachnids, 349 Insects.

Development of *Limulus longispinis*.‡—Mr. K. Kishinouyo has a preliminary note on the development of this King-Crab. About nine days after fertilization a blastodermic thickening comparable to the "primary thickening" already described by the author in the Spider, may be seen on the ventral surface of the egg. Its indifferent cells separate into ectoderm and mesoderm and form the commencement of the ventral plate. About the fourteenth day the mesoderm is divided into a number of transverse metameres, and, almost simultaneously, into two lateral parts. The endoderm is represented by the yolk-cells, which remain in the interior of the egg.

The segments of the cephalic lobe and the first appendage are primitively cut off from the anterior end of the ventral plate as one segment; all the appendages are post-oral in origin. The coelomic cavity is not produced in the segments of the second, third, or fourth appendages; the cephalic lobe and the segment of the first appendage have a common cavity which develops along the sides of the stomodæum, and extends through the yolk to the dorsal part. In each of the segments posterior to the fifth a pair of coelomic cavities appear which extend over and envelope the yolk; they give rise to a dorsal longitudinal median lumen (the dorsal circulating vessel) and many lateral slits (ostia). The mesoderm belonging to the second, third, and fourth appendages plays no part in the formation of the dorsal vessel.

In *Limulus* there is a distinct line of demarcation between the dorsal and the ventral surfaces. The cephalothorax, as in Trilobites, is composed of five lobes—a median, and two laterals on either side. In both,

* Arch. f. Naturgesch., lvii. (1891) pp. 1-14. † Tom. cit., pp. 229-38 (1 pl.).

‡ Zool. Anzeig., xiv. (1891) pp. 264-6.

again, the eyes are always on the ventral side of the line of demarcation, and on this line there are always spines.

The nervous system arises from a paired longitudinal thickening of the ectoderm; the anterior are much broader than the posterior ends, and there are two pairs of ectodermic invaginations; these parts form the brain. The ganglia are separated gradually from the general ectoderm, and this separation is effected before that of the brain. The eyes are developed from pre-oral ectodermic invaginations, externally to the brain; they are produced at the margin of the ventral plate and retain this position; the lateral eyes migrate backwards, and it is this movement which has led many authors to suppose that they belong to a thoracic segment.

The median eyes arise from a pair of small ectodermic invaginations, which are afterwards united into a tube; this tube is subsequently reduced to a solid rod, the distal end of which is enlarged, and lies at the margin of the ventral and dorsal surfaces.

e. Crustacea.

Compound Eyes of Crustacea.*—Mr. G. H. Parker has an elaborate memoir on this subject. The principal question which he put before himself was, "What are the means by which ommatidial types are modified, and what is the significance of the changes through which these types pass." He has himself suggested already that those ommatidia which are composed of a small number of cells more closely resemble the ancestral type than those composed of many cells.

Three retinal types are distinguished in the compound eyes of Crustacea. In one the retina is a simple thickening in the hypodermis; this type is characteristic of Isopods, Branchiopodidæ, Nebaliidæ, Stomatopods, Schizopods, and Decapods. In the second type the ectodermal thickening becomes inclosed within an optic pocket; this may remain permanently open, as in the Apusidæ and Estheriidæ, or may become closed as in the Cladocera. In the third type the retina originates from thickened hypodermis, which subsequently separates into the corneal hypodermis and the retina proper. This is seen in Amphipods and Copepods.

The author thinks that the course of development taken by each of the three types very clearly indicates their mutual relations. The first of the types is evidently primitive, and as the other two pass through it they may be supposed to have been derived from it. In each case the retina is fixed in the simpler and movable in the more differentiated types.

The author very conveniently sums up his knowledge of the cellular composition of the ommatidia in the table given on the next page, wherein the abbreviation *pr.* marks the presence of any kind of cell when the number of that kind is not constant for different ommatidia in the same individual. In the Estheriidæ cones with four cells are sometimes found, though five is the usual number. It is possible that in *Serolis* there may be more than two cells in the corneal hypodermis of each ommatidium. In Schizopods, Stomatopods, and Decapods, the eighth proximal reticular cell is rudimentary.

* Bull. Mus. Comp. Zool., xxi. (1891) pp. 45-140 (10 pls.).

	Cells of Corneal Hypodermis.	Cone- Cells.	Retinular Cells.			Accessory Cells.
			Undiffer- entiated.	Differentiated.		
				Proximal.	Distal.	
1. Amphipoda ..	pr.	2	5	pr. (ect.?)
2. Branchiopodidae and Apusidae }	2	4	5	0
3. Estheriidae ..	pr.	5 (±)	5	0
4. Cladocera ..	?	5	5	pr. (ect.?)
5. Copepoda—						
<i>Pontella</i> ..	pr.	2	5	pr. (ect.?)
<i>Sapphirina</i> ..	?	?	3	?
<i>Argulus</i> ..	pr.	4	5	?
6. Isopoda—						
<i>Idotea</i> ..	2	2	6	pr. (ect.?)
<i>Porcellio</i> ..	2	2	7	4	2	"
<i>Serolis</i> ..	2 (+?)	2	"
7. Nebaliæ ..	2	4	7	"
8. Schizopoda ..	2	2	..	7 + 1	2	+ pr. (mes.?)
9. Stomatopoda ..	2	4	..	7 + 1	2	"
10. Decapoda ..	2	4	..	7 + 1	2	"

The author thinks that the type from which the ommatidia of all living Crustacea are probably derived would exhibit the following structures, a corneal hypodermis in which the cells are not regularly arranged, and the corneal cuticula was not faceted; a cone composed of two cells; a retinula composed of five retinular cells, and a rhabdome consisting of five rhabdomeres. The retina of the primitive eye, a simple thickening in the superficial ectoderm, would be composed of ommatidia of this type, arranged upon the hexagonal plan. No known Crustacean has an eye of exactly this structure, but that of *Gammarus* seems to most nearly represent it.

If these conclusions are correct, the principal types of ommatidia must have been produced mainly by increasing the number of cells in the primitive type; the most influential means of modifying the structure of the ommatidia must have been cell-division.

Dermal Sense-organs of Crustacea.* — Dr. O. vom Rath gives a preliminary account of his comparative observations on the sensory organs of various Crustacea. He has discovered sensory hairs on almost all parts of the body. The first pair of antennæ are the bearers of the most important; some act as protecting setæ to the olfactory organs; these are so attached to the cuticle as to be incapable of any great power of movement; they appear to be closed by membranes so thin as to allow of delicate sensation and the passage of fluids. Unfeathered, half feathered, completely feathered, and toothed sensory hairs may all be found on the first antennæ. The organs on the second pair are far less important than those on the first, though tactile hairs are often abundant, and exhibit great variation in size and shape. The gnathites always carry a number of sensory hairs, which the author regards as tactile bristles.

* Zool. Anzeig., xiv. (1891) pp. 195-200, 205-14. See Ann. and Mag. Nat. Hist., viii. (1891) pp. 299-313.

The histology of the nerve-end apparatus is essentially the same as that which the author has already described for Myriopods and Insects; he thinks we must exercise great caution in assigning functions to the dermal sense-organs, as their structure differs essentially from that of our own sense-organs, and they may possess senses entirely unknown to us.

Motor Manifestations of Crustacea.*—Dr. J. Demoor, after a historical introduction, gives an account of his experiments on *Palæmon serratus*. He finds that the fibres of the cerebral nerves do not cross to any considerable extent; the commissural fibres which connect the two halves of the supra-oesophageal ganglion have but little importance; each cephalic nerve ends partly in an independent nerve-centre, and each sends off a bundle of fibrils into the lateral ganglion. In the ventral cord, some fibres of the afferent nerve traverse the ganglion, and pass into the median region of the symmetrical ganglion. Fibres given off from the internal surface of the ganglion, take part in the formation of part of the transverse commissure; these curve at right angles, so as to become longitudinal, and pass towards the large internal nerve-cells of the ganglion of the same side. The number of fibres increases the more anterior the section; they predominate in the superior part of the chain, and are continuous with the fibres of the circum-oesophageal commissures. The author also gives an account of some experiments on the nervous system of Crabs made by means of sections, and the injection of various drugs.

Post-embryonic Development of Gonoplacidae.†—Dr. G. Cano describes the larval stages of *Brachynotus* and *Gonoplax*. The former genus exhibits marked affinities with some *Grapsidae*—*Pachygrapsus* and *Nautilograpsus*. As Cano was unable to examine the first larval stages of *Gonoplax*, he can give no verdict as to its systematic position.

Antennary Gland of Lucifer Reynaudii.‡—Prof. C. Grobben has made a careful examination of the antennary glands of this strange Decapod. That on the right side has an elongated terminal saccule near its hinder end and on the ventral surface there arises a constricted neck-like intermediate piece which leads to the urinary canaliculus. This at first runs parallel with the terminal saccule, and then makes a bend upwards and again descends to the ventral side; it again makes an upward and a downward turn and finally passes into a narrow canal, the ureter; this last traverses the conical excretory papilla as far as the tip, where it finds its orifice. The left antennary gland has, in general, the same arrangements as the right; but the several parts of the canaliculus occupy different positions. With regard to minute structure, the author observes that the terminal saccule is formed of an epithelium, the cells of which are generally flat, but sometimes make rounded projections into the lumen of the sac. The cell-contents are granular, and the nucleus, as compared with those of the renal-canal-cells, is small. These cells are set on a basal membrane, which

* Arch. Zool. Expér. et Gén., ix. (1891) pp. 191-227.

† Atti R. Accad. Sci. Torino, xxvi. (1890-91) pp. 639-48 (1 pl. not published in this part).

‡ SB. K. Akad. Wiss. Wien., xcix. (1890) pp. 559-67 (1 pl.).

is followed by connective tissue; the latter is connected with the large blood-vascular trunk which passes into the head.

The histological structure of the renal canaliculus is altogether different from that of the terminal saccule. The epithelial cells are large and polygonal, and so flat as to be worthy of being called pavement cells. The side turned towards the lumen has a thick striated cuticle. The protoplasm is granular in the part of the cell near the lumen, but in the rest has a peculiar structure; it is arranged in plates which are disposed perpendicularly to the surface of the cells. In places, the protoplasmic plates of one cell are continuous with the plates of a neighbouring cell; these plates are of irregular thicknesses, and a wavy course may be sometimes observed. Dr. Grobben states that his earlier view that the plates are arranged parallel to the contour of the nucleus was incorrect.

In cross-section the protoplasmic plates appear as rods, and have, therefore, the same appearance as the so-called rods in which the protoplasm of the kidney-cells so often appears to be arranged. The plates may be supposed to have arisen from protoplasmic rods set in order one behind another, and fused with one another. A similar disposition has been observed by the author in the renal cells of *Sepia*, and by Rabl in the oral epithelium of the larva of the Salamander.

The ureter has the same structure as the integument, of which it is an invagination. The wall consists of small cells with a cuticular lining on the side nearest the lumen.

Arterial System of Isopods.*—M. A. Schneider points out that in Isopods there is a vascular collar anterior to the nerve-ring, which supplies the arteries of the oral appendages. In Annelids, however, as well as in Myriopods and Arachnids, the analogue of this vessel is situated behind the brain. He has made some injections of *Porcellio* and *Lygia*, which show that the condition which obtains in Isopods is not really anomalous. In them, there are, behind the nerve collar, two arteries which arise from the aorta in the immediate neighbourhood of the point of origin of the ophthalmic artery. The course which they follow shows that they form a ring in every way comparable to that of Arachnids. The author has also been able to show that in *Porcellio* and *Lygia* the ophthalmic and antennary arteries form a vertical vascular ring which recalls that of Amphipods. He has, therefore, been able to show that the previously supposed unique arrangement of Isopods is not a true morphological peculiarity, and that they do not differ from Amphipods, as has been believed.

Development of Germinal Layers of Isopoda.†—M. L. Roule has studied the early development of *Porcellio scaber*. He finds that the blastoderm proliferates in several regions, and on the internal surface; but, notwithstanding the organs to which it gives rise, it does not lose the appearance of a simple epithelial layer set around the nutrient yolk. It retains this appearance even after the mesoderm and endoderm have been formed at its expense, and have become separated from it; and it then represents the ectoderm.

* Comptes Rendus, cxiii. (1891) p. 316.

† Op. cit., cxii. (1891) pp. 1460-2.

Reproduction of Isopoda.*—Dr. G. Leichmann describes residual traces of hermaphroditism in the reproductive organs of Sphæromidæ, the form studied being *Sphæroma rugicauda*. The fact is of obvious interest in relation to the typical hermaphroditism of Cymothoidæ. In discussing the oogenesis of *Asellus aquaticus*, he describes the formation of the brood-chamber from peculiar lamellar appendages developed at the base of some of the thoracic limbs. In *Porcellio scaber*, the lamellæ are formed in the gap between the hypodermis and the cuticle of the thorax, and their formation is restricted to a single moulting period. In *Asellus*, however, the lamellæ appear very early as external appendages and their complete formation extends over three moulting-periods. It seems that the spermatozoa both in *Asellus* and *Sphæroma* penetrate as far as the ovaries, and that the fertilized ova pass rapidly down the oviducts and into the brood-chamber without the occurrence of the remarkable processes which are characteristic of the egg-laying of Oniscidæ. The author describes the typical formation of two polar bodies. It has been commonly supposed that the young of Isopoda are hatched in the brood-chamber, except indeed in the parasitic Anceidæ and Cryptoniscidæ. But Leichmann finds that in Sphæromidæ the development takes place within the body of the mother in eight thin-walled sacs which lie in pairs on the skin of the thoracic segments by the side of the nerve-cord. These sacs are not in direct connection with the ovaries or oviducts, they are invaginations of the skin. The eggs pass as usual into the space beneath the lamellæ, but are transferred thence into the eight sacs which have slit-like external apertures. As the mass of yolk is insufficient to account for the size of the larva, there must be some nutritive supply from the blood of the mother. So too in the structure of the lamellæ of *Asellus aquaticus*, Leichmann finds evidence that these serve for filtering nutritive constituents from the blood into the brood-cavity—an important addition to their acknowledged protective function.

Secondary Sexual Characters in Copepods.†—Dr. W. Giesbrecht, answering Prof. Claus, notices a number of omissions in Claus's account of the secondary sexual characters in *Calanidæ*. The omissions concern the following genera:—*Calanus* (*Cetochilus*), *Paracalanus*, *Eucalanus* (*Calanella*), *Clausocalanus* (*Eucalanus* Claus, non Dana), *Euchæta*, *Euchirella* (*Undina* Claus, non Dana), *Phænna*, and some others.

Distribution of Copepods.‡—Dr. W. Giesbrecht adds to a previous list a summary in regard to the geographical distribution of the Copepoda collected on the "Vettor Pisani" expedition.

New Copepoda.§—Dr. C. L. Edwards describes five new Copepods which he found in the body-cavity of the Holothurian *Mülleria Agassizii*. Three of them are free-living forms,—*Dactylopus bahamensis* sp. n., *Esola longicauda* g. et sp. n., both belonging to the family Harpacidæ, and *Rhapidophorus Wilsoni* g. et sp. n., referable to the family Calanidæ.

* Bibliotheca Zool. (Leuckart and Chun), x. (1891) 44 pp. (8 pls.).

† Zool. Anzeig., xiv. (1891) pp. 308-12.

‡ Atti R. Accad. Lincei—Rend., vii. (1891) pp. 63-8.

§ Comptes Rendus, cxii. (1891) pp. 1268-70.

Two were semi-parasitic,—*Diogenidium nasutum* g. et sp. n., belonging to the Lichomolgidae, and *Abacola holothurise* g. et sp. n., representative of a new family Abacolidæ. Along with the above the author also found a single specimen of a remarkable Crustacean, which he calls *Leuckartella paradoxa* g. et sp. n., whose external features suggest affinities with Copepods and with Phyllopods, though the organism is not referable to either of these orders.

Copepoda as Food.*—Prof. W. A. Herdman took an opportunity of getting large hauls of these Crustaceans to try them as food. A haul of twenty minutes, with a small net, made a dishful, which was shared by eight persons; with bread or biscuit it would probably have been a nourishing meal for one person. The species eaten was the large red form *Calanus finmarchicus*.

Two new Lernæopoda.†—Prof. P. J. Van Beneden describes two new Lernæopods, one from the Azores and the other from the coasts of Senegal. The former was found on a Ray and the latter on one of the Squalidæ. The first species is called *Brachiella Chavesii*, and on the single female there was fortunately a male; the female extends over 25 mm., and is most interesting for the characters of the abdomen, which is perfectly distinct from the rest of the body, flattens as it widens, and is triangular in form; there are four cylindrical appendages set parallel to the ovisacs, and there is no caudal segment. In some points this species is allied to *Charopinus*. The second species, *Brachiella Chevreuxii*, has a long cephalothorax, a very wide and wavy abdomen, four cylindrical appendages and a caudal segment; the female is in all not more than 12 mm. long, and its anterior part is flexible like a swan's neck; one male was found with its mouth applied to the skin of the female in the region of the sexual orifices; the circular mouth is surrounded by a circle of small setæ, and the abdomen is terminated by two conical appendages.

Vermes.

a. Annelida.

Eyes of Polychæta.‡—Mr. E. A. Andrews has made a study of the eyes of members of various families of Polychæta. He comes to the conclusion that the eye is a collection of pigment-cells with clear refracting portions at the cuticular and nerve-processes at the hinder ends. In the branchial eyes of some tubicolous forms the retinal cells are isolated by intervening pigment-cells, and each bears its own refracting medium in its cuticular end. There is thus no fusion of refracting media to form a common lens. Each true "camera" eye of the higher errant forms is composed of many cells crowded into a spheroidal mass; the pigment portions of the cells form a deep optic or retinal cup, from the open pupil of which the lens mass may project towards the cuticle. The retinal cup is lined by a layer of clear rods, each a part of one retinal cell. Between these rods and part of the lens a "vitreous body" may be interposed, or the lens may occupy the whole of the central space within the layer of rods. This lens is often con-

* Nature, xliv. (1891) p. 274.

† Bull. Acad. Roy. de Belgique, lxi. (1891) pp. 23-35 (2 pls.).

‡ Zool. Anzeig., xiv. (1891) pp. 285-6.

nected with the cuticle by a slender stalk. The retina is looked upon as a single layer of epidermal cells, each of which has elongated in such a way that its nucleus has receded from the cuticle while the clear, cuticular end has fused more or less with that of the other cells to form the layer of rods, the lens, and (if present) the vitreous body.

Anatomy and Histology of *Serpula dianthus*.*—Mr. A. L. Treadwell has made a study of this small worm by means of serial sections; the original describer, Prof. Verrill, appears to have taken the dorsal for the ventral side and *vice versa*. Owing to the extraordinary development of the dorsal longitudinal muscles the animal, when coiled, has its dorsal side concave rather than convex, and this may have led to the error. The operculum is sometimes on the right and sometimes on the left side; on the opposite side is a small pseudoperculum, which seems to be of a sensory nature. The external cilia found by Claparède in allied Annelids appear to be absent from this species, but in a number of characters it agrees with *Spirographis Spallanzani* as described by that well-known anatomist. The food consists largely, if not entirely, of diatoms. The nervous system is highly developed, and the cerebral ganglion has a diameter of 5 mm. in specimens whose whole body-diameter was 14 mm.; it gives off anteriorly two large branchial nerves, two smaller œsophageal, and one posterior and median. There is a large circum-œsophageal commissure and a large ventral ganglion on either side. The ventral system is composed of two long nerves, swollen out into segmentally arranged ganglia which decrease in size from before backwards. The tubular fibres are not so highly developed in *S. dianthus* as in allied forms, for they thin out and disappear in the first pair of ventral ganglia.

The posterior dorsal portion of the cerebral ganglion is prolonged into a most remarkable process, for a large lobe passes outwards and backwards, and after a short course bends suddenly downwards and passes into the first ventral ganglion. They form, in fact, a second pair of œsophageal commissures made up almost entirely of nerve-cells, and giving rise, apparently, to no nerves.

The tubiparous glands lie one on either side in the first body-segment, and open by a common duct; they are much convoluted and have an internal duct which opens into the body-cavity by an expanded elongated funnel. The ovaries are small rounded bodies, one on either side in each segment behind the middle of the body, and set close against the segmental septa; the ova lie loose in the body-cavity, and completely fill it towards the hinder end; the external openings are in the posterior part of each segment, are small and surrounded by a thin lip made up of hypoderm, muscles, and peritoneum, greatly reduced in thickness, and of a special layer of circular muscles. The arrangement is such that a contraction of the body-muscles would open and that of the circular muscles would close the orifice. No male specimens have yet been seen.

Protective Device of an Annelid.†—Mr. A. T. Watson describes a Sabellid worm in which the tube, on the retreat of the contained

* Zool. Anzeig., xiv. (1891) pp. 276-80.

† Nature, xliv. (1891) p. 507 (3 figs.).

animal within it, proceeds to coil up like a spiral spring. This is, of course, an effectual protection against the intrusion of enemies. The worm, which belongs to an undetermined species, was obtained from Jersey.

Distribution of *Magelona*.*—Mr. E. A. Andrews adds the coast of North America for *M. papillicornis* found off the British coast; the worm has also been taken at Wimereux and off the coast of Brazil. Its wide distribution would be remarkable, as the adult lives buried in the sand, were it not for the long duration of the pelagic larval stage which allows of transport by ocean currents.

***Clepsine plana*.**†—Prof. C. O. Whitman gives a detailed description of this new American species. In the course of his remarks he draws attention to the hitherto overlooked fact that, among Leeches, metamerism has undergone modification in two opposite directions. Variation by centripetal reduction of the number of rings is universal; variation by multiplication of rings characterizes, as a rule, only the higher forms, such as *Hirudo* and *Nepheleis*. *Clepsine* rarely exhibits the second mode of variation, but a physiological explanation can be offered of the difference in this respect between the Clepsinidæ and the Hirudinidæ. *Hirudo* swims, and for this purpose a long flexible body is required; *Clepsine* habitually creeps, and for this mode of locomotion supplementary rings have not been essential. A preliminary and not a comparative description of the new leech is, for the present, offered.

Further Researches on Segmental Organs of Hirudinea.‡—Prof. H. Bolsius gives an account of his further researches on the segmental organs of various Leeches. In all the forms examined the terminal funnel of the organ is absent, as Vejdovsky has stated for the adults of all the species which he studied. *Hæmopsis vorax* differs from *Hirudo medicinalis* and *Alostomum gulo* in having the organ less closely packed and more coiled; a single layer of glandular cells surrounds the cells which contain the collecting tube. In *Clepsine* and *Hemiclepsis* the three canals take their origin from ramifications or lacunæ: both these form three independent systems, one for each canal; they may pass from one cell to another by a special prolongation, which is distinct from that which conveys an earlier formed canal. The three canals finally unite into one collecting canal, and the union is effected at a varying distance from the inferior orifice in various species.

The protoplasm in the cells of *Clepsine* and *Hemiclepsis* is sometimes divided into areas which separately surround each canal. In most cases these areas are not limited all round, but fuse partly with the ordinary protoplasm of the body of the cell. The boundaries of the areas never have a well-marked membrane. The typical mode of union of the cells is by as many separate prolongations as there are canals in the cells.

* John Hopkins Univ. Circ., x. (1891) p. 96.

† Journal of Morphology, iv. (1891) pp. 407-18 (1 pl.).

‡ La Cellule, vii. (1891) pp. 1-77 (3 pls.).

B. Nematelminthes.

Structure of Nematelminthes.*—Dr. O. Hamann calls attention to the pædogenesis not only of *Echinorhynchus clavæceps* but also *Ech. agilis*. Both persist and are mature in a larval state. Like *Archigetes Sieboldi*, they have arisen by "phylo-pædogenie." The author would interpret many forms, even *Amphioxus*, in a similar way, as larval stages which have become sexually mature. Four species of *Echinorhynchus* which Molin described as distinct, viz. *Ech. crassatus*, *flavus*, *de Visianii*, and *solitarius*, are really one. Hamann was fortunate enough to find numerous specimens of the genus *Lecanocephalus*, of which little has hitherto been known. It has only one longitudinal vessel, situated along the right lateral line in the anterior half of the body. This vessel opens to the exterior under the nerve-ring, and communicates posteriorly with the body-cavity. Some preliminary notes on the various structures of Nematodes are communicated.

Monograph on Acanthocephala.†—Dr. O. Hamann begins his monograph with an account of the maturation and segmentation of the ova in *Echinorhynchus acus*. Among the segmenting ova in the body-cavity lie ensheathed egg-balls which result from the disruption of the ovary. While the egg-cells are still in this stage, two polar bodies are formed. The precise moment of fertilization remains unknown; the spermatozoa are sometimes found in the body-cavity of the female; it is certain that in *Ech. acus* they penetrate the membrane of the egg-ball, for within this the first two stages of division occur. The two cells which result from the first division are unequal, the larger being towards the pole which bears the polar bodies; but on the whole the segmentation is regular. The central cells are always richer in chromatin than the peripheral. There is a triple sheath round the whole mass. The epiblast is never without nuclei, though these are poor in chromatin; a few giant nuclei appear at an early stage at the posterior end; in the larva the epiblast is a syncytium. In *Ech. hæruca* no polar bodies were observed; the segmentation is at first very irregular. The stage with an epiblast of several layers all poor in chromatin, and with a hypoblast represented by an internal mass of cells whose nuclei are rich in chromatin, is regarded as a gastrula. The larval forms *Ech. proteus* and *Ech. polymorphus* are then described. Hamann regards *Ech. clavæceps* Zed. as a species which has arisen by pædogenesis, for it is sexually mature at a stage which corresponds to a comparatively early one in most other Acanthocephala.

In the second part of his monograph the author describes the histology and organogeny. The larval state of the skin—a syncytium with a few giant nuclei and direct division—persists in *Ech. clavæceps*. The lemnisci act like the ampullæ of starfishes, helping in the extrusion of the proboscis, serving as a reservoir for the lacunar fluid. The musculature and the proboscis, the ganglion of the proboscis sheath, and the peripheral system, the gonads and their associated ducts are all described in detail. Under the title *Ech. proteus* Westr. von Diesing

* SB. K. Preuss. Akad. d. Wiss. (1891) pp. 57-61.

† Jenaische Zeitschr. f. Nat., xxv. (1890) pp. 113-231 (10 pls. and 4 figs.).

two quite different species—*Ech. proteus* and *Ech. Linstowi* sp. n.—have been confused.

Structure and Development of Echinorhynchus.*—Herr J. Kaiser continues his account of the Acanthocephala. The sub-cuticular fibrillar feltwork is described in great detail. The constant circulation of fluid has suggested to previous investigators that the fine fibres which bound the cavities might serve to keep up the current; Kaiser has shown that the radial fibres are the sole motor elements. The zone of radial fibres and the feltwork are very closely connected, but they are quite different; the latter is secreted from the hypodermis and is truly cuticular, whereas the radial fibres are formed from the plasma of the hypodermis cells and are contractile. As to the lemnisci, it is at least certain that they are not excretory. They are homologous with the lateral vessels of Nematodes, while the tubular network in the skin is an independent nutritive system, which might be compared to a system of blood-vessels. The rest of Kaiser's memoir, so far as published, is devoted to a description of the musculature, which presents a close resemblance to that of Nematodes, and yet has very distinctive peculiarities.

Notes on Parasites.†—Dr. C. W. Stiles fails to find the tooth which some authors have described in the embryos of *Ascaris*; he has seen, however, signs of the three lips characteristic of the adult, and thinks that he has here the origin of the error. He describes a new species of *Filaria*, *F. Gasterostei*, from the body-cavity of *Gasterosteus aculeatus*. In Paris, in May, he observed the escape of a number of specimens of *Mermis crassa* from the larvæ of *Chironomus plumulosus*.

γ. Platyhelminthes.

Large Land Planarian.‡—Dr. B. Sharp proposes the name of *Bipalium manubriatum* for a large land planarian, found in a green-house at Lansdowne, Pa. The tail is said to be rounded, and not, as is usual, pointed. The ground colour is greyish-yellow and is traversed by five longitudinal black bands. No comparison is made with *B. Kewense*, which has been found in so many green-houses.

The Papillæ of Microstoma.§—Dr. F. v. Wagner finds that the "attaching papillæ," described by von Graff at the posterior end of *Microstoma lineare*, are not papillæ at all, but simply the projecting terminal portions of unicellular glands.

The Genus Apobolema.||—Dr. F. S. Monticelli describes *Apobolema* (*Distoma*) *appendiculatum*, *A. ocreatum*, and *A. Stossichii* sp. n. He accepts and corroborates Juel's reasons for considering these and related tailed Trematodes as in a distinct genus of the subfamily Distomidæ, a genus for which the title *Apobolema* proposed by Dujardin is adopted. He reduces the species to nine and gives a diagnostic table of these.

* Bibliotheca Zool. (Leuckart and Chun), vii. (1891) pp. 41-72 (2 pls.). Cf. this Journal, *ante*, p. 196.

† Bull. Soc. Zool. France, xvi. (1891) pp. 162-5.

‡ Proc. Acad. Nat. Sci. Philad., 1891, pp. 120-2.

§ Zool. Anzeig., xiv. pp. 327-31 (1 fig.).

|| Atti R. Accad. Sci. Torino, xxvi. (1890-1) pp. 496-524 (1 pl. not published in this part).

Free-swimming Sporocysts.*—Dr. M. Braun has found a number of examples of a free-swimming sporocyst, of which only one had as yet been seen, in an aquarium in which various freshwater Gastropods had been recently placed. But, whereas the unique American specimen was only 1 mm. long, his were 6 mm. in length, and they were not quite transparent. Their bodies have a T form, the azygos limb being band-like in cross-section and thickened to a knob at the free end. In this last there was a yellow opaque corpuscle which was seen to be a coiled up *Distomum*; the paired limbs form lamellar, movable appendages.

These sporocysts came, it was ascertained, from *Limnæus palustris* var. *corvus*; they were discovered to be enormously developed *Cercariæ*, and only differ from *Cercaria macrocerca* and *C. cystophora* in having a furcocercal form. The only fish seen to swallow them were goldfish, but in these no Distomata were found. For the present this interesting form may be known as *C. mirabilis*.

Structure and Development of *Tænia longicollis*.†—Dr. v. Linstow's present memoir is a contribution to our knowledge of the *Tæniæ* of Fishes. All these combine to form a small and distinct group, which are distinguished by the absence of a rostellum with hooks at the apex of the scolex. Very little is as yet known as to their minute structure, so that the author takes the opportunity of giving an account of *T. longicollis* from *Osmerus eperlanus*.

Although Dr. v. Linstow has found various Fish-*Tæniæ*, this is the first case in which he has found one with sexually mature proglottids; it is probable that the proglottids only mature in the summer. The Fish-*Tæniæ* form an intermediate stage between the *Tæniæ* of warm-blooded animals and that family of Cestodes which Diesing called the Paramecotyleæ. The cuticle is very fine and appears to be homogeneous; the cutis is .0026 mm. thick and is unstained by colouring matters; it exhibits a fine radial striation, but does not deserve the name of epidermis, as it does not consist of cells. Behind it there is a circular and then a longitudinal layer of muscles, while the parenchym is traversed by separate and feebly developed dorso-ventral muscles. The hypodermis or subcutaneous layer is remarkably well developed, and consists of closely pressed, large, vesicular cells with one or more rounded nuclei. The parenchym consists of cells with a very remarkable flask-like structure; from the nuclei septa pass to the outer membrane of the cell. In *T. longicollis* there are no calcareous corpuscles, though these bodies have been observed in other Fish-*Tæniæ*. The suckers on the scolex are circular, and in addition to the ordinary four, there is a fifth of half their size; they consist of cuticle, equatorial, meridian, strong radial, again meridian, and again equatorial muscles. The ganglionic cells of the brain are unipolar; two primary nerve-cords arise from the brain and pass down the sides within the inner longitudinal layer of muscles; they are semi-ovate in cross section, .026 mm. broad and .011 mm. thick.

The vascular system is formed of two larger longitudinal trunks

* Zool. Anzeig., xiv. (1891) pp. 368-9.

† Jenaische Zeitschr. f. Naturwiss., lv. (1891) pp. 565-76 (1 pl.).

and six smaller vessels which are much looped and anastomose considerably; it may be made out without the aid of sections by simply compressing an uninjured specimen.

The generative orifices lie at the sides and are (irregularly) alternately right and left. The testes are large multicellular organs which lie to the inside of the vitellaria; there are about twenty-five in each proglottid; the seminal vesicle is a large organ which is formed by a looped and coiled continuation of the greatly widened trunk of the vas deferens. The cirrus-sheath is spindle-shaped and its wall is formed by a layer of longitudinal and one of circular muscles; when the cirrus is protruded the space between it and the sheath is filled by loose connective tissue.

The two ovaries lie at the hinder margin of the proglottid and contain germ-cells $\cdot 013$ mm. in diameter; the efferent ducts lie on the inner side, opposite one another, and lead to the ootyp; the vitellaria occupy almost the whole of the outer side of the proglottids. The various efferent ducts unite at the hinder end of the vitellaria into a common yolk duct. In the form and position of their vitellaria the Fish-Tæniæ differ considerably from those of Mammals and approach those of the Paramecetylæ on the one side, and many Trematoda on the other. In describing these various organs the author makes comparisons with those of other Fish-Tæniæ which have been already described.

The larva, like that of *Trixenophorus nodulosus*, is encysted in the liver of the fish, whose intestine harbours the adult *Tænia*; in the matter of development, therefore, there is again a marked difference from that of the Tæniæ of warm-blooded animals, and a resemblance to that of many Paramecetylæ.

Development of some Tæniæ of Birds.*—Herr A. Mrázek has investigated the cysticerci found in various freshwater Crustacea, and limited his further studies to such as are found in their cestoid condition in the duck and goose. *Tænia fasciata* of *Anser cinereus* and *A. albifrons* passes its cysticercoid stage in *Cyclops agilis*; the long diameter of the intermediate form is from $\cdot 18$ to $\cdot 22$ mm., there are eight hooks from $\cdot 055$ to $\cdot 068$ mm. in length, and the caudal appendage is extremely long. The cysticercus of *Tænia tenuirostris*, which is remarkably small and has a crown of ten hooks, is found in *Cyclops viridis*, *C. agilis*, and *C. lucidulus*; the tapeworm hosts are *Anser albifrons*, *Anas boschas* and *A. acuta*, *Fuligula cristata* and *F. brasiliensis*. Although the cysticercus of *T. gracilis* was first described by Linstow from the intestine of the perch, it is also found in *Cypris compressa* and *C. viridis*; the adult hosts are *Anas boschas* and *A. acuta* and *Mergus merganser*. A few cysticercoids of *T. anatina* have been taken from *Cypris incongruens*, and one from *C. compressa*; the hosts of the adult are *Anas boschas* and *A. acuta*. A new Cysticercoid form, which the author calls *Cysticercus Hamanni*, was found in *Garmmarus pulex*, but the cestoid form and its host are still unknown. The body of the young parasite is from $\cdot 30$ to $\cdot 40$ mm. long; the greater part of the body is covered by fine cilia which are described as being immobile; the crown contains from 18 to 22 hooks.

* SB. K. Böhm. Ges. Wiss. Prag, 1891, pp. 97-131 (2 pls.).

Dr. Linstow has made the private suggestion that this cysticercus is that of *T. constricta*, but the author does not accept the suggestion.

Herr Mrázek has observed that the hooks are not developed till a comparatively late period, and he suggests that this is why the scolex is able in earlier stages to freely extend and invaginate itself; an analogous phenomenon is to be observed in *Archigetes Sieboldi*. The well-marked development of the caudal appendage in all the cysticerci observed by the author in freshwater Crustacea is due, he suggests, to the intermediate hosts being animals which are, phylogenetically, very old.

Tænia coronula.*—Mr. T. B. Rossiter has a note on this tapeworm, the cysticercus of which he was recently able to show inhabited *Cypris cinerea*.

Echinococcus multilocularis in the Cow.†—Prof. A. Guillebeau reports the tenth case of the presence of *Echinococcus multilocularis* in an old cow; it did not seem to give rise to any disturbances, but the tumour taken from the hepatic capsule was an oval 9 by 13 cm. and 5 cm. thick. No cestode heads were found. The vesicles were surrounded by a layer of giant-cells, but these were in some parts replaced by large spindle-cells.

Cysticercus of *Tænia saginata* in the Cow.‡—Comparatively common as *Tænia saginata* is in Man, its cysticercus is only rarely found in the Ox. Prof. A. Guillebeau takes, therefore, the opportunity of making a few observations of a case in which a large number of this cysticercus were found in the flesh of a calf three weeks old. It has the form of a yellowish-white oviform nodule, 6 mm. long by 4 mm. broad.

δ. Incertæ Sedis.

Desiccation of Rotifers.§—Dr. R. Cobelli has desiccated Rotifers for five years and five months in the powdery dust of the gutter. Thereafter they were quite dead! But after immersion in water for 3–7 days the bodies were beautifully distended, and the internal organs were distinctly seen in a state of good preservation.

Determination of Sexes of *Hydatina senta*.||—M. Maupas has made some experiments on the ova of this rotifer, with the object of seeing if he can determine the sex of its developed form. He finds that at the beginning of oogenesis the egg is neutral, and that temperature is a modifying agent. If the temperature is lowered females will be produced, if it is raised males will appear.

Distyla; New Rotifers.¶—Mr. D. Bryce has some observations in support of the view already expressed in this Journal that *Distyla* and *Cathypna* are distinct genera;** he describes two new species, *D. depressa* from the River Lea and *D. muscicola* †† from among roots of *Sphagnum* in Epping Forest, and *Monostyla arcuata*, also from the Forest.

* Intern. Journal Micr. and Nat. Sci., i. (1891) pp. 291–5 (1 pl.).

† Mittheil. Naturf. Ges. Bern, 1890 (1891) pp. 7–11 (3 figs.).

‡ Tom. cit., pp. 12–15 (1 fig.).

§ Verh. K. K. Zool.-Bot. Gesell., xli. (1891) pp. 585–6.

|| Comptes Rendus, cxiii. (1891) pp. 388–90.

¶ Sci. Gossip, 1891, pp. 204–7 (8 figs.).

** 1890, p. 726.

†† Not *muscicola* as in original (*teste auct. in litt.*).

Echinodermata.

Morphology of Echinoderms.*—M. L. Cuénot finds that in the course of development of Ophiuroids the ectoderm of the walls of the body is intermingled with the mesenchyme in such a way that distinction between them is impossible: in the adult the primitive ectoderm can only be recognized at certain points, such as the tentacles and teeth. In *Cucumaria*, likewise, the wall of the body is not bounded by ectoderm, for that layer is imbedded in the subjacent mesenchyme, where it forms groups of cells, above which are the connective fibres that form the outer covering of the body. In *Elpidia glacialis* there is no distinct ectoderm at all. In all Echinoderms the calcareous matter is formed in the same way; it is deposited on a connective plexus, in which nuclei are scattered, and which may be seen after decalcification; it is secreted by mesenchymatous cells which are very abundant in all developing calcareous tissues; the holes are due to the plexiform arrangement, and not, as Hérouard thinks, to the presence of nuclei.

The small ciliated spines which invest the fascioles of Spatangoids are identical with the vibratile spinelets which the author has described in *Astropecten*; like them, they appear to facilitate the renewal of water either around the anus (circumanal fasciole) or the branchiæ (circumpetalous fasciole). The anchors of Synaptids have no muscular fibres and play a passive part in locomotion, like the hooks of Ophiurids. Such Clypeasterids as were examined were found to be all provided with small tridactyle pedicellariæ, which recall those of Spatangoids. The Cuvierian tubes of Holothurians cannot be considered as anything else than defensive organs, and can be expelled in large numbers without injuring the digestive tube.

The author has studied the invagination of the nerve-cords in *Amphiura squamata*; at first they are superficial and exactly resemble those of Asterids, but by a process which is more like epiboly than invagination, tegumentary folds are formed above the nerve-ring, the radial cords, and the basal part of the ambulacra, and inclose a smaller portion of the external medium which forms the system of epineural cavities. It is possible that in some palæozoic Ophiuroids the nervous system was superficial. In all Echinoderms the histological constitution of the central parts of the nervous system is the same—nerve-fibrils running between the base of long filiform cells, the nucleus of which is placed near the exterior. These ectodermal cells, notwithstanding their epithelial form, appear to play the part of ganglionic nerve-cells.

There are a number of vestiges of the nervous invagination; there may be an empty space above the oral ring and the radial cords, or there may be, in youth, a direct continuation between the œsophageal epithelium and the oral ring already inclosed in the tissues; as the animal grows older the communication becomes reduced, and may altogether disappear. Thirdly, the radial cords always fuse with the ectoderm at their extremities.

The central nervous system consists of an outer and more important part, formed by the ectoderm, and an inner part, less constant, much

* Arch. Zool. Expér. et Gén., ix. (1891) pp. viii.—xvi. See also Arch. de Biol., xi. (1891) pp. 313–504 (4 pls.).

more delicate and probably of mesenchymatous origin; these two layers are separated from one another by a very delicate connective layer. In all groups the ambulacra or tentacles are provided with ganglionated nerves; ganglia are massed round the spines; in *Synapta inhærens* the peripheral plexus of the skin contains a number of small ganglia, which are in relation with groups of glandular cells, which probably produce a defensive secretion. M. Cuénot is of opinion that the spheridia are certainly sensory organs, and not altered spines; like the otocysts, they are, he thinks, organs of the sense of orientation.

The organs of reserve have, in very many cases, the form of amoebocytes of the fluid of the cœlom which are filled with fat or albuminoids; thus loaded they pass into the tissues by diapedesis, and remain there till needed. The saccules of *Antedon rosacea* are probably organs of reserve; they contain a certain number of cells which are filled with yellow spherules of a proteid nature.

The cavities of an Echinoderm body are very complex, for there are (1) the cœlom, formed by the fusion of the enterocœlic vesicles and more or less subdivided in the adult by secondary septa; (2) the axial sinus of Asteroids, Ophiuroids, and Echinoids, which contain the ovoid gland, which has an enterocœlic vesicle that has remained isolated; as dependencies of this are the sinuses connected with the genital organs; (3) the ambulacral apparatus (hydrocœl), which is derived from a portion of the enterocœl; (4) the schizocœlic cavities subjacent to the nerve-ring and radial cords, which often communicate with the axial sinus and with the cœlom; (5) the various lacunar schizocœls, which are formed independently in the different groups; and (6) the supra-neural sinuses which represent an invagination cavity. The author describes some of these in detail.

The three types of hermaphrodite Echinoderms have each a special form of hermaphroditism; *Asterina gibbosa* is male when young, and, later on, exclusively female. In *Synapta*, at each epoch of maturity, the animal first ejects eggs only, and, later on, becomes exclusively male. What is remarkable in this case is that all the individuals of one locality are in the same stage, whence we must conclude that the ova are not fertilized till some time after expulsion. In *Amphiura squamata* the testes and ovaries are separated, the former being radial and the latter interradial in position; cross-fertilization is most frequent probably, but self-fertilization is possible. In *Ophiactis virens* the gonads are not developed till very late, and after the animal has already reproduced itself several times by median division.

The author is unable to accept any of the published phylogenies of this great group. The simplest type he can imagine is a *Prosynapta*, from which the Synaptidæ of the present have been evolved; *Prosynapta* gave rise to a *Proholothuria*, whence the Holothurida and Elasipoda have been derived. *Proholothuria* became *Procystus*, which gave rise to Cystoids, Blastoids, and Crinoids; it was at this time that the calcareous plates found a continuous skeleton, and that the larval anus was obliterated to open again independently in spots varying with varying types. *Procystus* was the parent of *Proechinus*, ancestor of all the Echinids, and the ancestor of *Proaster*, whence diverged the Asteroids and Ophiuroids. The author recommends this theory as conciliating the

two most probable phylogenetic views, those of Neumayr and the Sarasins.

Ludwig's Echinodermata.*—Prof. H. Ludwig has continued the publication of his valuable treatise. The parts before us commence with a postscript, in which some recent discoveries in Holothurians are reported, which bear on the already concluded chapter on Morphology. The history of development is next dealt with in considerable detail, and the author then passes to the systematic arrangement of the Holothurioida, which he divides, primarily, into the two groups he has lately established, the Actinopoda and the Paractinopoda.† The various divisions as low as genera are defined; for the species the student is referred to Thiel's excellent 'Challenger' report. The parts to hand conclude with an account of the geographical distribution of the class, which is illustrated by a series of small maps.

Apical System of Echinoids.‡—MM. C. Janet and L. Cuénot have some observations on the terminology of the apical apparatus. They are of opinion that the plates ordinarily known as the oculars should be called terminals. They also call attention to some examples of multiple genital orifices, which they consider to be of a teratological nature, and not a return to the condition which obtains in the Palæechinoids. As it is merely a question of absorption of calcareous matter, this may happen at two or three adjacent points instead of at one only. In some cases the madreporic pores extend beyond the area of the madreporite, and they describe an example of *Arbacia punctulata* in which they have observed it.

Cœlenterata.

Histological Observations on Cœlenterata.§—Dr. K. C. Schneider has found that by the aid of the Hertwigs' osmium and acetic acid mixture it is possible to discover ganglionic cells on the tentacles and the pneumatophore of *Apolemia uvaria* and on the polyps of *Forskalea contorta*; these do not essentially differ from the ganglionic cells found in other Cœlenterata. Sensory cells of the usual kind have been found at the anterior end of the polyps and tentacles of *Apolemia*. In the stem of this form and of *Velella spirans*, very remarkable and abnormal cells have been detected; the epithelium consists of cells of very various forms, between which intermediate stages may be made out. In *Forskalea* there are at the sides of the trunk transversely elongated cells which send a process inwards; with this, which may divide, the longitudinal muscles become connected. In a young *Halistemma*, in the trunk of which the central canal is extraordinarily wide and the septal elevations of the supporting lamella very low, their relations were particularly well seen; from which it follows that we have here to do with epithelio-muscular cells. Circular muscular fibres do not appear to be present. In *Apolemia*, however, muscular substance is inclosed in these prolongations of the cell-body, as also in the central processes which lead to the longitudinal muscle; at the same

* Bronn's Klassen u. Ordnungen des Thier-reichs. II. 3, Echinodermen, 1891, pp. 241-376 (pls. xiii.-xvii.). † See this Journal, ante, p. 478.

‡ Bull. Soc. Geol. France, xix. (1891) pp. 295-304 (11 figs.).

§ Zool. Anzeig., xiv. (1891) pp. 370-1; 378-81.

time, this is not true for all the cells of the epithelium. In *Apolemia* especially the development of the cells varies in a really extraordinary way; there are some which possess, in addition to the longitudinal muscle, fibres which run transversely and vertically; others have no transverse processes and end roundly on the surface. The peripherally rounded cells are, in *Forskalea*, chiefly found on the dorsal surface. Their form is very much that of the neuromuscular cells described by Korotneff; but they are not epithelial in position, and are merely special forms of epithelial cells. There are, in addition to them, other abnormal cell-forms. Sometimes, for example, the central process is completely wanting; pretty often it happens that the processes divide, and then there are what look like typical ganglionic cells. However, whatever the extent of the resemblance may be, there is always something or other in the cell which prevents our supposing that we have to do with a nervous element.

Korotneff's views as to what should be called nervous are very wide; the presence of quite irregular protoplasmic processes leads him at once to conclude that the cell is nervous. However, the giant-cells on the trunk of *Forskalea* possess processes, which in length, form, and structure leave nothing wanting to justify their being called nervous. These cells form aggregates with their long axis set transversely to the trunk; they are connected with the rest by short, thick connecting bridges, and the nerve-fibres which radiate out from them are often of extraordinary thickness, branch like ganglionic-cell-processes, and extend below the epithelium and into the muscles. The fluid which comes from the fibres may perhaps be compared with the hyaloplasm of the ganglionic cells of higher animals. The finer the processes—some are very delicate—the more difficult is it to distinguish them from processes of epitheliomuscular cells.

After some remarks on stinging-cells, the author states that he has been able to come to definite views on the formation of the spicules by a study of *Alecyonium acaule*. Indifferent ectodermal cells here and there form groups and give rise by fusion to the matrix-elements of the spicules. They take the form of the future spicule, and secrete calcareous substance, in which at first nuclei can be recognized: later on the organic groundwork becomes completely lost.

Organization of Anthozoa.*—M. P. Cerfontaine describes a new species of *Cerianthus* from the Red Sea, which he calls *C. brachysoma*. The body has the form of a cone slightly flattened transversely; the anterior extremity is marked by a strong dorsoventral costa, the presence of which causes the animal to appear to be bilaterally symmetrical. The tentacles are few but large.

The author next discusses the arrangement of the tentacles in *C. membranaceus*, as to which a number of discordant statements have been made. He finds that the number of marginal tentacles constantly varies during the existence of an individual *Cerianthus*, for fresh tentacles are always being formed, alternately to the right and left.

A few physiological observations on *Astroides calycularis* are offered; if pieces are cut off a polype we may see that individuals

* Bull. Acad. Roy. de Belgique, lxi. (1891) pp. 128-48 (1 pl.).

arise which live without any skeleton, and not only live but grow and reproduce by budding. He describes several teratological examples and points out that monstrosities are so frequent that special care ought to be taken in establishing new genera or species.

Kophobelemnon at Banyuls.*—Prof. H. de Lacaze-Duthiers calls attention to the presence at Banyuls of this rare Alcyonarian; as only one example was found, and that was still living at the time of the communication, no details are offered as to its structure. But it is pointed out that the fauna of Roussillon is very rich in rare forms, and offers much to the student.

New Alcyonarian.†—Prof. T. Studer calls attention to a new genus of Alcyonaria found in the Atlantic by the ‘Hirondelle,’ which he proposes to call *Chelidonisis* (*C. aurantiaca*). With some resemblances to the Isidinæ it has also some characters of the Mopseinæ, and tends to draw the hitherto isolated genus *Isis* nearer to that subfamily.

A Freshwater Medusa.‡—Dr. J. v. Kennel gives a description of a freshwater Medusa from a lagoon on the east coast of Trinidad which he calls *Halmomises lacustris*; it is one of the Thaumantiidæ. It has no marginal bulbs, cirri, or marginal vesicles; the umbrella is hemispherical, and has, it seems, sixteen to eighteen tentacles, on the outer side of each of which there is an ocellus. The velum is thin, but broad; the manubrium is well developed; the cruciform mouth has no lobes, there are four radial canals, and the gonads are frill-like. The bell has a diameter of 2–2½ mm. The colour is hyaline and faintly yellowish, while the gonads are yellowish-brown. The author was unable to find any hydroid which could be thought to be related to this Medusa.

Sensory Papillæ of Halielystus auricula var.§—Herr G. Schlater finds that the nervous system of this Lucernarian is relatively simple, being localized in the tentacular knobs and especially in the marginal papillæ, and consisting of a system of distinct ganglion-cells connected with the sensory cells, with the cnidoblasts, and with one another. The marginal papillæ—which have received many names—are analogous with the sensory papillæ of other Acraspeda, but represent a low grade of differentiation. They have a musculature which is very slightly different from that of the tentacles.

Heliotropism of Hydra.||—Mr. E. B. Wilson concludes that *Hydra* has an innate (automatic?) tendency to wander, and that light and oxygen operate not so much by calling forth new movements, as by the modification of indefinite movements that tend to recur irrespectively of external stimuli. The case shows an interesting analogy to the movements of plants.

* Comptes Rendus, cxii. (1891) pp. 1294–7.

† Mittheil. Naturf. Ges. Bern, 1890 (1891) p. xvii.

‡ SB. Nat. Gesell. Univ. Dorpat, ix. (1891) pp. 282–8. See Ann. and Mag. Nat. Hist., viii. (1891) pp. 259–63.

§ Zeitschr. f. Wiss. Zool., lii. (1891) pp. 580–92 (1 pl.).

|| Amer. Natural., xxv. (1891) pp. 413–33.

Porifera.

Classification of Sponges.*—Dr. R. v. Lendenfeld gives a compilation of our knowledge of the characters of Sponges, in which the genera are defined and a phylogenetic scheme offered. An alphabetical list is appended of the names given to the various forms of sponge-spicules, and there is also a bibliography of authors quoted.

Development of *Spongilla fluviatilis*.†—M. Y. Delage finds that, in the development of the fresh-water Sponge the ectoderm is formed at the expense of cells which were primitively internal; the ciliated cells take no part in its formation, for they pass into the interior of the body, where they are seized on by the amœboid mesodermic cells, and later on take part in forming the chambers and canals. This capture of the ciliated cells is, fundamentally, only a phenomenon of phagocytosis, which is incomplete in that it is temporary; some of the cells do, indeed, appear to be truly digested; it is probable that at the moment when they lose their cilia they undergo a temporary diminution of vitality, and that the amœboid cells capture them, but are unable to digest them. The author remarks on the interest of a fact of this kind becoming a normal phenomenon of development; it recalls to him the histolytic processes seen in Insects, but with this great difference, that here the elements incorporated by the phagocytes are utilized in future histogenesis directly, and not as simple nutrient materials.

Protozoa.

Successive Regeneration of Peristome in *Stentor*.‡—Prof. E. G. Balbiani finds that in *Stentor cœruleus*, and probably also in other species of the genus, the region of the peristome near the mouth, the mouth, and the œsophagus occasionally become atrophied; but the atrophy is soon followed by the complete regeneration of these parts. The regeneration commences with the formation of a new peristome and of a mouth which appears at the sides, before occupying the normal position at the anterior pole of the body. A new peristome may be easily recognized by the changes in its system of striation; it is divided into secondary areas, each of which has its own striation, and of which the number increases with the age of the animal. When these areas are multiplied they give the peristome a mosaic appearance which is more or less regular, and the degree of complication allows of an estimate of the age of the individual.

When the newly formed peristome changes its lateral for its terminal position, movements of contraction are seen in the nucleus; the result of this is the concentration of all its joints in a common rounded mass; when the change of position is effected the nucleus regains its moniliform appearance. All the phases of the nucleus are like those which it undergoes during division, except that it returns to its primitive number of joints. These changes in the form of the nucleus correspond, either on fission or reparation, with the stages in the displacement of the new

* Abhandl. Senckenberg. Naturf. Ges., xvi. (1890) pp. 361-439 (1 pl.).

† Comptes Rendus, cxiii. (1891) pp. 267-9.

‡ Zool. Anzeig., xiv. (1891) pp. 312-6, 323-7 (6 figs.).

peristome; we may, therefore, conclude that the nucleus has a direct action on the movements of the protoplasm. The regeneration of the oral apparatus in *Stentor* has probably the object of repairing the waste caused by a prolonged exercise of its functions, while in other Ciliata the regeneration appears to be connected with the process of conjugation.

Two new Infusoria.*—M. A. Certes describes two new Infusoria from the neighbourhood of Paris, which he calls *Conchophtyrius Metchnikoffi* and *Odontochlamys Gouraudi*. The former is 90–140 μ long and 60–100 μ wide; the latter was much smaller, being only 20–40 μ long and 18–35 μ wide; it is allied to *Chilodon* and *Chlamydon*, but it is necessary to make a new genus to receive it.

Rhizopoda of the Lake of Geneva.†—In a short paper on this subject, Dr. E. Pénard describes a few new species. *Hyalosphenia punctata* differs in having the membrane not smooth, but distinctly covered with very small round scales, and in its smaller size, from any member of the genus yet described. *Quadrula globulosa* is the first of its genus in which the test is almost spherical instead of being elongated and flattened. *Campascus triquetus*, which is abundant near Geneva, is very closely allied to *C. cornutus*, but is distinguished by having no horns. *Acanthocystis Lemani* is a fine species, the ectosarc of which is almost always filled with yellowish-green granules, which were first thought to be parasitic Algæ; it was, however, recognized that they were small *Dinobrya* which had been captured by this Heliozoon. The spicules exhibit remarkable variations, some being much larger than the rest, and expanding suddenly at one end; others enlarge more gradually. All, whether typical or not, are constructed on the type of a funnel. The spicules are further remarkable for being two or three times as long as the diameter of the body.

Origin and Growth of the Shell in Freshwater Rhizopods.‡—Dr. L. Rhumbler does not agree with Verworn's conclusion that the shells of freshwater Rhizopods do not grow or change after they have been once formed, that is, after the division has been effected. There are three ways in which the cases of these Rhizopods arise:—(1) By the constriction of the parent shell, as in *Lieberkühnia*, *Diplophrys*, and *Lecythium*; (2) by the formation of a new and independent shell, as in *Microgromia*; (3) from materials which the parent Protozoon furnishes, as in *Euglypha* and *Diffugia*. But it may be frequently observed that the new shells contain fragments which, on account of their size, could not have been included in the parent animal. The question thus arises: In what sense are these large fragments secondary accretions? In answering this, Dr. Rhumbler describes the formation of the case in *Diffugia acuminata* during division; the occurrence of regeneration in *Diffugia spiralis*; the growth of shells with protoplasmic cementing substance, as in several species of *Diffugia*; the gradual growth of *Arcella*-shells; and the growth of the chitinous case of *Centropyxis aculeata*. The division of *Diffugia acuminata* shows that firm portions

* Mem. Soc. Zool. France, iv. (1891) 6 pp. (1 pl.).

† Arch. Sci. Phys. et Nat., xxvi. (1891) pp. 134–56 (1 pl.).

‡ Zeitschr. f. Wiss. Zool., lii. (1891) pp. 515–50 (1 pl. and 2 figs.).

of the shell, especially the "extrathalamous" materials for the daughter-shell, may become plastic. This plasticity makes secondary growth possible. The same conclusion is corroborated by all the investigations above mentioned. Therefore the opinion that these Rhizopod cases are permanently fixed when first established must be abandoned.

Freshwater Rhizopods.*—Dr. E. Penard gives a monographic account of the freshwater Rhizopods which he has collected for the most part around Wiesbaden. In a general introduction he discusses many interesting problems—the shell-making, the structure of the plasma, the use of vacuoles as natatory vesicles, the direct relation between the activity of the contractile vacuole and that of the organism as a whole, the pre-eminent importance of the nucleolus and its variability (ten phases being described in *Amœba verrucosa*), the movements, the nutrition, the reproduction, &c. His observations corroborate, but do not greatly add to those of previous workers. In the systematic part of the memoir, which is illustrated by about a thousand figures, one hundred and ten species are described. There are eight new species of *Amœba*, nine of *Difflugia*, four of *Arcella*, six of *Nebela*, and so on, the total of forty-seven making a notable addition to the list of freshwater Rhizopods.

Biomyxa vagans.†—Mr. W. J. Simmons reports the presence in Calcutta of this amœboid form described by Prof. Leidy from specimens collected in North America.

Trypanosoma Balbianii.‡—M. A. Certes finds that *Trypanosoma Balbianii* is generally abundant on the crystalline style of *Tapes decussata*, but it more or less completely disappears when the style is dissolved. He has observed a large specimen undergoing horizontal division into two. In February and March 1891 the species had completely disappeared from the green oysters of Marennes.

Freshwater Peridineæ.§—Herr A. J. Schilling has a monographic memoir on this group, in which, after a historical introduction, he commences by describing the organization of the creatures that compose it. One of the most puzzling parts are the so-called eye-spots or stigmata. They have the form of a polygonal or horseshoe-shaped disc, and are always placed in the longitudinal groove immediately beneath the surface of the body. As in the eye-spots of other Flagellata, the protoplasmic groundwork forms a fine network in which red-coloured granules or spherules are deposited. The speed with which these organisms move appears to depend on the size of the body. Reproduction appears to be always effected by vegetative multiplication by division into two. The statements that have been made as to processes of copulation and conjugation want further confirmation.

In the descriptive portion of his work the author recognizes the six genera, *Hemidinium*, *Gymnodinium*, *Amphidinium*, *Glenodinium*, *Peridinium*, and *Ceratium*. He defines in detail the species that belong to each, some of which are new.

* Mém. Soc. Phys. et d'Hist. Nat. Genev., xxxi. (1890-91) 230 pp. (11 pls.).

† Sci. Gossip, 1891, pp. 199-202 (4 figs.).

‡ Bull. Soc. Zool. France, xvi. (1891) pp. 94-5 (1 fig.).

§ Flora, lxxiv. (1891) pp. 220-99 (3 pls.).

Hæmatozoa of the Frog.*—M. A. Labré has made some observations on the Sporozoa and Flagellata which are found as parasites in the blood of the frog. The former are divisible into two groups, the first of which is represented by the *Drepanidium* of Ray Lankester. The author has observed two specimens, either free in the serum or in the same blood-corpuscle, approach and fuse by one of their extremities. The fusion goes on until the two form a V, the branches of which are fused along a certain length. We have here to do with a true conjugation, similar to that seen in Infusoria. Encystation—though the word is inexact—is similar to that observed in the swarm-spore-cysts of Coccidia; the parasite folds itself in such a way as to bring its two extremities into contact, fusion goes on slowly, and ends in the formation of a rounded or oval protoplasmic body, in which the vacuoles soon disappear, and which exhibits amœboid movements. The most common mode of reproduction is by spores, which resemble those of the Microsporidia. The second group of the Sporozoa is represented by Hæmatamœbæ, the smallest of which are like pseudonavicellæ; the latter form spores.

The author calls attention to the presence in the blood of a true *Polymitus*, 16 μ wide, with three or four flagella, 40–50 μ long.

Presence of bodies resembling Psorosperms in Squamous Epithelioma.†—M. Vincent has found in various forms of epithelioma, bodies which he, like other writers, regards as psorosperms. The bodies in question may be as large as the cells of the Malpighian layer, and according to the age of the parasite, are invested with a thinner or thicker highly refracting membrane. The protoplasm is rarely homogeneous, usually granular, and frequently contains large pigment-granules. The nucleus may be absent, double, or of very various shapes. It is not unusual to find several of these bodies inclosed in the same membrane, their form being roundish or altered by compression.

The cysts lie in the epithelial cells, the nucleus of which seems pushed on one side; they may be found in the centre of the cancerous masses alone or in accumulations. These bodies are stained with great difficulty, but the following was the most successful procedure. Very thin sections were treated for a moment with ammonia, washed in water, and then immersed for five minutes in a saturated watery solution of safranin. Some of the colour was then removed with 1 per cent. acetic acid, and then having been washed with water, they were decolorized in alcohol until they assumed a rose colour. Then oil of cloves and balsam. The psorosperms are stained red, the surrounding cells yellow or violet. The author does not appear to have noticed any spore formation in his psorosperms. Cultivation experiments were failures.

Polymitus malariae.‡—*Polymitus* is found, says Prof. B. Danilewsky, in the blood of birds and men affected with malaria, as a spheroidal protoplasmic parasite possessed of several very mobile flagella. On the surface are usually observable some dark melanin granules. A few

* Comptes Rendus, cxiii. (1891) pp. 479–81.

† Annales de Micrographie, ii. (1890) Nos. 10–11. See Centralbl. f. Bakteriöl. u. Parasitenk., ix. (1891) pp. 383–4.

‡ Centralbl. f. Bakteriöl. u. Parasitenk., ix. (1891) pp. 397–403 (6 figs.).

minutes after the preparation of the specimen these flagella may be observed to set themselves free, while within the body of the parasite certain changes are observable.

Doubts having been expressed as to the nature of the flagella, the author considers it desirable that these should be allayed. He is quite convinced that the flagellum is a normal organic constituent of *Polymitus*, while the most common objection is that they are moribund or post-mortem phenomena. Against the objections the author brings various arguments, the most powerful being that these flagella are remarkable for the unusual rapidity, duration, and energy of their movements (half to one hour or longer).

The appearance of the parasite and its relation to the corpuscle are depicted in six illustrations, which show the outline of the corpuscle distended by one to four spheroidal bodies, some of them flagellated, pushing the nucleus to one side.

The author's remarks and descriptions are based on observations made from the avian parasite, but the views expressed are considered to hold good for the human parasite also, since from a morphological and biological standpoint no real differences can be detected between the two varieties.

The author considers that he has surmounted the difficulties of his case by affirming that "the parasite is in a certain sense a polymorphic organism which easily adapts itself to external conditions."

Biological Cycle of *Hæmatozoon falciforme*.*—Sigg. Antolisei and Angelini confirm the observation of Canalis, Celli, and Marchiafava on the *Hæmatozoon falciforme*: this was to the effect that in the irregularly intermittent fevers prevalent in summer and autumn a special variety of the malaria parasite is to be found, and that this differs from that found in tertian and quartan ague. This variety sometimes passes through its developmental cycle very quickly, passing from the phase of the non-pigmented amœba to that of the round form with a single pigment mass and to the sporulation phase, or the last condition may supervene without the parasite showing a trace of pigment; but at times development is more slow and the parasite attains to the spiral or crescent form ere it reproduces itself. The latter forms are better found in the blood extracted from the spleen than in that of the general circulation. In the blood from the spleen more phases of development are met with than in the fingers, and as a rule the most advanced (non-pigmented) stages of development- and sporulation-forms there appear.

Malaria-Parasites in Birds.†—In a series of short notes Prof. B. Grassi and Prof. R. Feletti make some preliminary observations on malaria-parasites found in birds. They find that in birds two kinds of parasites exist—the one kind belonging to the genus *Hæmamœba* and the other to the genus *Laverania*. That these are real existences, and not alterations of the red corpuscles, is shown by the fact that the malaria-parasites of birds are possessed of a nucleus.

Of the *Hæmamœba* there are three species—*H. præcox*, cause of

* *Riforma Medica*, 1890, Nos. 54-6. See *Centralbl. f. Bakteriologie u. Parasitenkunde*, ix. (1891) pp. 410-11.

† *Centralbl. f. Bakteriologie u. Parasitenkunde*, ix. (1891) pp. 403-9, 429-33, 461-7.

quotidian; *H. vivax*, cause of tertian; and *H. malarix*, cause of quartan ague. The *Laverania* are said to be the cause of fever of irregular type.

After much discussion the malaria-parasites are finally assigned to the Amœbæ. It is to be hoped that when the final publication appears it will be illustrated so that an approximate idea may be obtained of the parasites in their different stages and varieties.

Researches on Low Organisms.*—M. J. Massart has investigated the sensibility of marine unicellular organisms to concentration. He finds that organisms which have become accustomed to live in a medium of constant concentration generally avoid solutions which are more or less strongly concentrated. These results are in accordance with those obtained by the author with the human conjunctiva, for he finds that it is sensitive to more or less strongly concentrated tears.

With regard to the effects of gravity, M. Massart finds that not only Flagellata, but also Bacteria and Ciliata are mobile organisms that are sensitive to weight. Two closely allied species of *Spirillum* gave totally different geotaxic reactions; the geotaxy of *Chromulina Woroniniana* changes its sign according to the temperature. Contrary to the opinion of Verworn, the author thinks that the accumulation of unicellular organisms in the superficial strata of liquids is due to irritability.

Zoochlorellæ.†—Dr. W. Schewiakoff remarks that Prof. A. Famin-tzin,‡ in discussing the zoochlorellæ found in Infusorians, has ignored the observations which he (Schewiakoff) made in 1887, showing that the isolated *Zoochlorella conductrix* of *Frontonia leucas* could survive and multiply, and could be introduced into colourless varieties of *Frontonia*.

* Bull. Acad. Roy. de Belgique, lxi. (1891) pp. 148-67.

† Biolog. Centralbl., xi. (1891) pp. 475-6.

‡ Mém. Acad. Imp. Sci. St. Petersb., xxxviii.



BOTANY.

A. GENERAL, including the Anatomy and Physiology
of the Phanerogamia.

a. Anatomy.

(1) Cell-structure and Protoplasm.

Structure of Living Protoplasm.*—Injections of vegetable and animal tissues with mercury have led M. V. Fayod to the conclusion that protoplasm is not an emulsion, but a reticulate tissue composed of canaliculate and spiral fibrils, with hyaline walls capable of excessive swelling. The canaliculate fibrils, which have about the dimensions of *Spirillum tenue*, he terms *spirofibrils*; they are probably themselves composed of still finer spiral fibrils, the *spirosparts*, and these are all twisted round a canaliculate axis; they together constitute the hyaloplasm of Hofmeister. The visible granular portion of the protoplasm, the only part which takes up staining under ordinary circumstances, is simply the contents of these canals; it is the chromatin of Flemming, and is capable of motion within the canals. The very delicate membrane of the spirals he terms *fibrolem*.

The primitive spirofibril probably increases in size and becomes canaliculate simply in consequence of the growth of the spirals which arise in its interior; and in this way it becomes transformed into a spiral composed of spirosparts with an axial canal. The fibrous network which constitutes the greater part of the protoplasm resists the action of staining reagents, but there are various ways in which its existence can be shown.

The nucleus, which is probably nothing but a knot of the last extracellular net, is formed by the junction of several bands of spirosparts which traverse it in different directions. The granular portion of the protoplasm disappears under the action of active oxygen, and this disappearance is accompanied by an excessive swelling of the protoplasm, of which only the hyaline substance remains. This hyaline substance appears to be an organic body very rich in oxygen, and its formation to be due to the oxidation which accompanies respiration. The cell-wall of plants possesses precisely the same structure as protoplasm; it is simply protoplasm impregnated by cellulose.

The above description applies especially to vegetable protoplasm; but that of animals possesses essentially the same structure.

Structure and Growth of the Cell.†—Dr. C. Acqua has come to the following conclusions on this subject, derived largely from observing the growth of pollen-grains. Those tubes which increase directly and without interruption present a homogeneous wall with no visible lacerations; the cellulose probably becomes rapidly stretched, as soon as it is formed, the constitution of the wall being very soft at the moment of its formation and for a short time afterwards. But when a period of activity is followed by one of rest, during which the wall is becoming gradually thickened, then, as soon as growth recommences, the old layer

* Rev. Gén. de Bot. (Bonnier) iii. (1891) pp. 193-228 (1 pl.).

† Malpighia, v. (1891) pp. 3-39 (2 pls.). Cf. this Journal, 1890, p. 734.

becomes lacerated and the protoplasm becomes covered by a new one. When the wall consists of several layers, these are stretched and lacerated in succession from without inwards. These facts support the hypothesis of apposition.

Influence of Temperature on Caryokinesis.*—M. E. de Wildeman has experimentally investigated this subject, the objects of his experiments being the hairs on the filaments of *Tradescantia virginica*, *Spirogyra*, *Cosmarium* and *Closterium*. He finds that below a certain temperature caryokinesis does not take place, at least in its entirety, while too high a temperature impedes this process and that of cell-division, and between the two there is an optimum temperature. For *Tradescantia* this optimum was found to be about 45°–46° C., for *Spirogyra* 12°, and for *Cosmarium* 24°. There are, however, also individual variations. Light has no direct influence on this phenomenon; the length of time required for nuclear and cellular division varies with the species and with the temperature. With *Spirogyra* and *Cosmarium* these processes are exceedingly slow at low temperatures; with *Tradescantia* they can, of course, only be followed out through the summer months.

(2) Other Cell-contents (including Secretions).

Chlorophyll.†—M. N. Monteverde has made a fresh series of experiments with the view of determining the number of distinct pigments present in an alcoholic extract of chlorophyll.

If an alcoholic extract of leaves is treated with baryta water, and the precipitate extracted with alcohol, the solution has a yellow colour; if this is again shaken with petroleum-ether after addition of a few drops of water, a separation takes place of the yellow pigments; the petroleum-ether containing carotin, identical with the carotin of the carrot, together with the green pigment; the alcohol containing xanthophyll. The pigments contained in the petroleum-ether are termed by the author "upper pigments," those contained in the alcohol "lower pigments." By careful treatment the whole of the upper green pigment can be removed by alcohol from the petroleum-extract, leaving behind a golden yellow solution of carotin; this green pigment does not crystallize. The alcoholic solution contains, in addition to xanthophyll, a "a lower green pigment," which crystallizes in tetrahedra, hexagons, or stars, but usually in irregular forms. The author believes that living leaves contain only the "lower green pigment," the upper one being a transformation-product resulting from the action of boiling water or of alcohol.

Green and Etiolated Leaves.‡—Herr W. Palladin has undertaken a series of observations with the view of determining the amount of albuminoids in green and etiolated leaves of wheat and of *Vicia Faba* (without leaf-stalk). He finds the results point to the general conclusion that etiolated leaves may be divided into two groups according to the amount of albuminoids contained in them. In the case of stemless plants,

* Ann. Soc. Belge Microscopie, xv. (1891) pp. 5–58 (4 pls.).

† VIII. Congress Russ. Naturf. u. Aerzte (Bot.) 1890, pp. 32–7. See Bot. Centralbl., xlvii. (1891) p. 132.

‡ Ber. Deutsch. Bot. Gesell., ix. (1891) pp. 194–8.

etiolated leaves contain a smaller proportion than those that are green; while the reverse is the case with plants having a stem. The stems of etiolated plants contain a very small quantity of albuminoids.

In a further series of experiments on the same plants* the author finds no soluble carbohydrates present in etiolated leaves of *Vicia Faba*; and concludes that chlorophyll cannot be formed without the presence of sugar. The first chlorophyll in the leaves of germinating plants is formed at the expense of the sugar which is carried from the seed by the transpiration-current. Iron is also necessary to its formation.

Quantity of Starch contained in the Radish.†—M. P. Lesage finds that although, under normal conditions, the radish contains no, or but very little, starch, yet if the seedlings are watered with water containing sodium chloride in solution, a very considerable quantity of starch is formed. The optimum proportion of salt in the water was found to be 4 gr. per 1000; a second lower maximum occurred with 10 gr. per 1000.

Tannoids.‡—M. L. Braemer gives an account of the present state of our knowledge, chemical and physiological, of the products of metastasis grouped under the name of tannins. He regards the group as a very heterogeneous one. None of the reactions relied on for the diagnosis of tannins are common to all substances included under that term, nor are they limited to them. Our present knowledge of these substances is, in fact, very imperfect.

Crystals of Calcium oxalate.§—Recurring to the question of the form in which calcium oxalate occurs in the tissues of plants, Prof. G. Arcangeli now states that in some cases single crystals belong to the monoclinic, and not to the dimetric system. The clusters of crystals are most often monoclinic, rarely dimetric. In the former case the crystals are frequently arranged radially round a central point, and present often a different structure in their internal to that in their external portion, the former having a more radiate, the latter a more crystalline appearance. An organic nucleus could not be detected.

(3) Structure of Tissues.

Anatomy and Physiology of the Conducting Tissues.||—M. A. Gravis divides his treatise on this subject into three sections:—(1) Morphology of the Wood. The development of the xylem in the stem and root is followed out in detail, taking *Urtica dioica* as an example; the variations in the composition of the xylem are then described in four different type-plants, *Polypodium ramosum*, *Pinus sylvestris*, *Quercus robur*, and *Tradescantia virginica*. (2) Physiology of the Wood. The theory of the circulation advocated by Böhm is adopted, and the bordered pits are treated as

* Ber. Deutsch. Bot. Gesell., ix. (1891) pp. 229-32.

† Comptes Rendus, cxii. (1891) pp. 373-5. Cf. this Journal, ante, p. 625.

‡ 'Les tannoïdes,' 8vo, 154 pp., Toulouse, 1890, 91. See Bot. Centralbl., xlvii. (1891) p. 274.

§ Nuov. Giorn. Bot. Ital., xxiii. (1891) pp. 489-93 (1 pl.). Cf. this Journal, ante, p. 616.

|| Mem. Soc. Belge Microsc., xii. (1889) pp. 87-118 (2 pls.). See Bot. Centralbl., xlvii. (1891) p. 241.

receptacles for water. (3) Relations between the Morphology and Physiology of the Wood. The xylem is regarded as serving for a reservoir and conducting path for water; the annular and spiral vessels contributing chiefly to the former, the pitted vessels to the latter purpose.

Internal Phloem in Dicotyledons.*—Dr. D. H. Scott and Mr. G. Brebner discuss the origin and function of the layer of phloem which occurs in the vascular bundles of the stem and root of many Dicotyledons on the medullary as well as the cortical side, characterizing the bundles termed "bicollateral." They regard the principal, though not the exclusive, function of the phloem-systems in the root and stem, to be the conduction of food-material, and not, as suggested by Frank and Blass,† the storing-up of food-material for the fresh formation of wood. They find that (in *Acantholimon*) an internal cambium is formed in the stem at a late stage, either just inside or just outside the protoxylem; it produces a large amount of medullary wood and phloem, with inverted orientation. In the majority of plants examined with bicollateral bundles in the stem, a normal structure of the root was found, the medullary phloem in the hypocotyl being continuous with the external phloem of the root-system. A certain number of roots among the plants of this class examined had interxylary strands of phloem, and these may be either primary, secondary, or tertiary. Intraxylary (medullary) phloem has so far been found only in the roots of *Strychnos* and *Chironia*.

Equivalence of the Vascular Bundles in Vascular Plants.‡—M. P. A. Dangeard proposes to establish the equivalence of the vascular bundle in all vascular plants. Among Dicotyledons the bundles are collateral, and are either closed or open. Among Monocotyledons, collateral bundles also occur, as well as concentric, in which the phloem is surrounded by the xylem. The difficulty, however, in understanding the vascular bundle is in those of Vascular Cryptogams and those of the root. The equivalent of the closed bundle of Dicotyledons is to be found in the single-veined leaves of *Selaginella*, *Lycopodium*, and *Tmesipteris*, and in the final ramifications of the veins in the leaves of *Salvinia*, *Marsilea*, ferns, &c. The bundles are here generally concentric; but, contrary to the structure in Monocotyledons, it is the phloem which surrounds the xylem. To find the equivalent of the open bundle of Dicotyledons and Conifers, we have to look in the stem of certain species of *Selaginella*, such as *S. Krausiana*, *Galeottei*, *Lyallii*, &c.

Structure and Growth of the Apex in Gymnosperms§—Herr L. Koch has carefully examined the structure and mode of growth of the apex of the branch in a number of Gymnosperms. The method of observation employed was the preparation of a large series of excessively thin sections by the microtome, after imbedding in paraffin in the mode recommended by the author.¶ The species examined were *Tsuga canadensis*, *Picea excelsa* and *orientalis*, *Abies alba*, *Larix decidua*, *Cedrus*

* Ann. of Bot., v. (1891) pp. 259-300 (3 pls.).

† Cf. this Journal, 1890, p. 622. ‡ Comptes Rendus, cxii. (1891) pp. 1228-30.

§ Jahrb. f. Wiss. Bot. (Pringsheim), xxii. (1891) pp. 491-680 (5 pls.).

¶ Cf. this Journal, 1890, p. 674.

Libani and *Deodara*, *Pinus Strobus* and *sylvestris*, *Thuja occidentalis*, *Taxus baccata*, *Cephalotaxus pedunculata*, and *Ephedra altissima*.

The author finds the apex of a growing shoot or leaf of a plant several years old to be occupied, not by a true apical cell, but by one or more, often four, cells or chambers, to which neither the outer nor the inner cells stand in any definite genetic relationship. There is no distinct outer layer or dermatogen, which has been derived direct from the embryo; for periclinal divisions arise even in the outermost cells, and the apex is occupied by several cup-like layers of embryonal tissue. The first differentiated tissue which is formed from these embryonal layers is the pith, in the form of large polygonal cells, before the initials of either the cortex or the vascular bundles are to be detected. At a later period the outermost layer becomes differentiated into the young epiderm by the suppression of periclinal divisions, and the cortex and vascular system develop from the inner layers. In the formation of the latter the embryonal tissue which lies between the pith and the cortex first exhibits itself in the form of an annular zone, which breaks up into the procambial bundles and intermediate tissue; a layer of the latter still retains its embryonal character, and becomes the interfascicular cambium. The further differentiation of tissues and the development of lateral organs are described in detail.

Increase in Thickness of the Stem and Formation of Annual Rings.*—Herr L. Jost has investigated the phenomena connected with these processes, his observations having been made chiefly on *Phaseolus multiflorus*, *Pinus Laricio*, and *Alnus cordata*. If all leaves and buds are removed from a tree, there will not, in the next year, be the least trace of the formation of wood, indicating that the leaves have a direct influence on the increase in thickness of the stem. The formation of vessels is in fact usually in direct dependence on the formation of foliar organs. Between the leaf itself and the leaf-trace the author finds not only an anatomical, but also a physiological connection.

Gunnera manicata.†—Dr. W. Berckholtz describes in detail the morphology and anatomy of this species. The flowers are hermaphrodite; the ovule is pendulous and anatropous; the fruit is a drupe; the seed contains an oily endosperm. In the course of the vascular bundles in its leaf-stalk, and in the bundles being closed, *Gunnera manicata* shows a resemblance to Monocotyledons; in the relative position of the xylem and phloem in the bundle to Ferns. The secondary roots have no cambium, and the pericambium usually consists of only a single row of cells. The author regards the nearest affinity of the Gunneraceæ to be with the Halorageæ.

(4) Structure of Organs.

Comparative Anatomy of Plants.‡—M. A. Chatin gives the following résumé of the more important results contained in the most recently published part of his work on this subject.

* Bot. Ztg., xlix. (1891) pp. 485-95, 501-10, 525-31, 541-7, 557-63, 573-9, 589-602, 605-11, 625-30 (2 pls.).

† Biblioth. Bot. (Luerßen u. Haenlein), Heft 24, 1891, 16 pp. and 9 pls.

‡ Comptes Rendus, cxiii. (1891) pp. 337-44.

Among parasites, the Rhinanthæ are distinguished, by the structure of the stem, the anther, the pollen, &c., from the allied Antirrhineæ, and from the semi-parasitic Thesiaceæ and Orobanchaceæ. The Lorantheæ differ from the Thesiaceæ in the nature of their vessels, and in the arrangement of their fibro-vascular system, as also from the Caprifoliaceæ, Santalaceæ, Olacineæ, Ceratophyllaceæ, and Chlorantheæ. From their anatomical structure the author separates the Misodendreæ from the true Lorantheæ. The Cuscutæ differ from the Cassytheæ in the habitual absence of stomates. The Cytineæ, Rafflesiaceæ, and Balanophoraceæ form a natural group from their anatomical characters. Further generic anatomical details are given.

Among aquatic plants, the author separates *Ottelia* from the Hydrocharideæ, to form, with *Stratiotes* and *Enhatus*, the type of a family characterized by its anatomy and by its anatropous ovules.

Stomates occur (among parasites) in *Clandestina*, in *Hypopitys lanuginosa*, in *Monotropa uniflora*, and in the greater number of the Lorantheæ, Thesiaceæ, and Rhinanthæ. Medullary rays are wanting in some, but not in all parasitic Dicotyledones, as well as in many terrestrial and in most aquatic species. Details are given with regard to the presence of a general and of a partial endoderm; and the occurrence of aeriferous lacunæ similar to those of aquatic plants is noted in some parasites, as in the cortical parenchyme of *Melampyrum*, *Rhinanthus*, and *Pedicularis*, and in the woody substance of *Cassyltha*.

Sudden Changes of Form.*—Herr F. Hildebrand records the following examples of sudden changes of form in plants:—(1) A seedling from an ordinary form of *Juglans regia* exhibited the form known as *laciniata*, with doubly pinnate leaves. It displayed an unusual sensitiveness to cold. (2) A plant of *Hepatica triloba* with ordinary 3-lobed leaves put up in two successive years leaves with a double lobing. (3) Two specimens of *Rhamnus Frangula* produced suddenly, but in one case not on all its branches, leaves which were deeply toothed or even lobed.

Styles of Compositæ.†—Mr. J. S. Chamberlain has made a comparative study of the structure of the style in different families of Compositæ, especially in reference to the papillæ and the collecting or brush-hairs, with a view to their usefulness for purposes of classification. He finds that, like other characters in the Compositæ, those derived from the style cannot be used in all cases singly, but only in conjunction with others, in dividing the order into tribes. These characters are more constant and uniform in some tribes than in others. Thus in the Vernoniæ, Eupatoriæ, and Asteroideæ, the structure of the style is very uniform and constant for each tribe, and can be used with great advantage. In the Helianthoideæ and Cynaroideæ the characters are still sufficiently constant to be of great aid; while in the Helenioideæ, Anthemideæ, and Senecionideæ there is less uniformity. Another difficulty is that where, as in some genera of Inuloideæ and Helianthoideæ, the flowers are diœcious, the brush-hairs are wanting on the style of the female flower.

* Ber. Deutsch. Bot. Gesell., ix. (1891) pp. 214-8.

† Bull. Torrey Bot. Club, xviii. (1891) pp. 175-86, 199-210 (4 pls.).

Embryo of *Trapa*, *Nelumbium*, and of some *Guttiferæ*.*—M. D. Clos has studied the germination of the seeds of *Trapa natans*, and puts a different interpretation on the morphology of the various parts from those which have hitherto been proposed. He regards the embryo as belonging to the group which he terms *macropodous*. What has hitherto been taken for the single large cotyledon is the greatly enlarged hypocotyl, which always remains inclosed, but emits from below the pericarp a straight slender prolongation, 5–8 cm. in length, which becomes horizontal and channelled for the insertion of the single cotyledon and of the contiguous buds. The embryo of *Trapa* is, therefore, monocotyledonous and rootless.

Some species of *Guttiferæ* and *Clusiaceæ* are also characterized by macropodous embryos.

In the ovule of *Nelumbium speciosum*, the best interpretation of the peculiar and difficult points of structure appears to be that the thin integument consists of the primine only, and that the large fleshy body below the embryo-sac, which becomes bipartite on germination, is formed by the complete concrescence of the secundine with the nucellus. The embryo makes its appearance between the two plates into which this body divides.

Fruits which expel their seeds with violence (Schleuderfrüchte).†—Herr E. Huth enumerates twenty-five families and forty-eight genera in which fruits of this description occur. He classifies them under three heads, viz. (1) Dry fruits; in these either the carpels roll up when ripe so as to expel the seeds (*Eschscholtzia*, *Corydalis*, *Cardamine*, *Viola*, *Euphorbia*, *Ricinus*, many *Leguminosæ*, &c.), or they belong to climbing plants, and are dragged for a short distance by animals by means of hooks and bristles, and then spring back suddenly and expel the seeds (*Setaria*, *Lappa*, *Martynia* (?), &c.). (2) Hygroscopic fruits; either dry (*Avena*), or furnished with elaters (*Jungermannia*, *Equisetum*). (3) Succulent fruits, in which the seeds are expelled in consequence of a sudden access of water (*Impatiens*, *Momordica*, *Elaterium*, *Dorstenia*, *Oxalis*, &c.). In the case of the last-named genus, the mechanism lies not in the pericarp, but in a fibrous layer which envelopes the seeds. The greatest distance to which the author observed that seeds could be expelled was 10 metres in the case of *Wistaria sinensis* (by night).

Fruit and Seed of *Umbelliferæ*.‡—Sig. E. Tanfani has continued his researches on the morphology and histology of the fruit and seeds of the *Apiaceæ* (*Umbelliferæ*). He adopts the view of the morphology of the flower supported by Celakovsky, viz. that the inferior ovary is composed of the concave receptacle, which incloses in its interior the base of the carpellary leaves, and bears on its margin the other floral whorls. The seed may be either orthospermous or campylospermous, and there are all intermediate conditions between the two. The embryo is small and straight, and is attached to the summit of the endosperm; occasionally there is only one cotyledon.

* Bull. Soc. Bot. France, xxxviii. (1891) pp. 271–6.

† Samml. Naturw. Vorträge, iii. (1890) 23 pp. and 5 figs. See Bot. Centralbl., 1891, Beih., p. 267.

‡ Nuov. Giorn. Bot. Ital., xxiii. (1891) pp. 451–69 (4 pls.).

Pericarp of Compositæ.*—Herr O. Heineck describes in detail the minute structure of the pericarp of Compositæ, and classifies the various forms under eight types, dependent on the arrangement of the "hard-bast-cells" which he finds always present in the pericarp,—elongated fusiform cells with a small cavity, and distinguished by these characters from the soft-bast-cells or cells of the bast-parenchyme.

Structure of Seed of *Euonymus*.†—From an examination of the structure of the seed of *Euonymus japonicus*, Sig. E. Baroni confirms the view taken by Planchon and Gasparrini, that the so-called arillode is not a true aril, inasmuch as it does not proceed from the micropyle, but, in its outer layer, is in complete continuity with the podosperm and with the raphe. The red pigment of this mantle is probably derived from the chloroplasts already existing in the unripe seed.

Structure of Cotyledons.‡—Herr F. Simek describes the structure of the cotyledons in species belonging to the Caryophyllaceæ, Geraniaceæ, and Compositæ. In the Caryophyllaceæ, where the cotyledons differ considerably in form and size from the foliage-leaves, the first two pairs of the latter always form a connecting link between the cotyledons and the normal leaves, and may be termed "primordial leaves." Generic, and in some cases specific, characters may at times be obtained from the cotyledons. In the Geraniaceæ the cotyledons always differ considerably in form from the normal leaves, but there are no primordial leaves or other connecting links. Among Compositæ, in *Tragopogon* the cotyledons have also, like the foliage-leaves, a long narrow form with entire margin.

Stem of the Cymodoceæ.§—M. C. Sauvageau, having already described the specific differences of structure observable in the leaves of *Cymodocea* and *Halodule*, now points out that the *Cymodoceæ* of the section *Phycagrostis*, and particularly *C. serrulata*, are better characterized by the structure of the stem than by that of the leaf; on the contrary, however, for the determination of the species of *Phycoschænus* and *Halodule*, it is preferable to have the leaf. The nine species of *Cymodoceæ* are taken seriatim, and the structure of the stem carefully described in each. The structure, although comparatively simple, and showing some analogies with *Zostera*, presents certain variations between one species and another. For instance, in *C. serrulata* the cortical parenchyme is the same as that met with in *C. æquorea*, while the form and structure of the central cylinder is that of the *Cymodoceæ* of the section *Phycoschænus*; finally the lignified cortical fibrous bands are not met with in any other species.

Swellings in the Bark of the Copper-beech.||—Herr F. Krick has examined the structure of the so-called tubers which frequently occur in the bark of the copper-beech, and which consist of true woody tissue,

* 'Beitr. z. Kenntniss d. feineren Baues d. Fruchtschale d. Compositen,' Giessen, 1890. See Bot. Centralbl., 1891, Beih., p. 112.

† Nuov. Giorn. Bot. Ital., xxiii. (1891) pp. 513-21.

‡ JB. Deutsch. Staats-gymn. Prag, 1889. See Bot. Centralbl., 1891, Beih., p. 203.

§ Journ. de Bot. (Morot), v. (1891) pp. 205-11, 235-43 (6 figs.). Cf. this Journal, ante, p. 65.

|| Biblioth. Bot. (Luerssen u. Haenlein), Heft 25, 1891 (28 pp. and 2 pls.).

cambium, and cortex. They are entirely or partially imbedded in the cortical parenchyme, outside the primary hard-bast-bundle of the stem, though they frequently project into the soft-bast. They may arise either in connection with a bud or not; in the latter case there are two principal types,—tubers with a central woody tissue, and those which have a corky structure in their centre.

Leaves of Xerophilous Liliifloræ.*—Herr C. Schmidt has examined the structure of the leaves in a number of species belonging to the orders Xerotidæ and Hæmodoracæ, natives of arid climates or situations. The epiderm is nearly alike on both sides of the leaf; its cells have a thin but distinct cuticle, and are adapted for the storing up of water; trichomic structures are very rare. The mechanical system is strongly developed, and is composed of typical bast-cells with greatly thickened walls. The assimilating system consists of typical palisade-cells; there is never a well-developed spongy parenchyme. The aerating system is well developed, but consists only of narrow crevices. The stomates always have their longer axis parallel to the axis of the leaf; they are alike in number and form on the two sides of the leaf; the thickening-bands in the guard-cells are remarkably strongly developed, leaving only a very narrow interval between them. The conducting elements are nearly always in close contact with the assimilating system. Dispersed through the fundamental tissue are frequently very elongated cells destitute of chlorophyll and containing bundles of raphides.

Abnormal Leaves.†—Herr J. Klein has attempted to trace the laws which govern the appearance of abnormalities in leaves, especially in relation to coalescent or double leaves. He finds that when leaves bear on one petiole two more or less separated laminae, each with its own mid-rib,—if this is the result of the union of two leaves, there are always a larger number, usually double as many, vascular bundles in the petiole as in that of an ordinary leaf; if the result of division, only the ordinary number of bundles. A double leaf results from the coalescence of two rudiments of leaves, a divided leaf from only one.

Roots without a Root-cap.‡—Herr T. Waage has made an examination of the exceptional cases in which a true root is not provided with a root-cap, especially in the Hippocastanacæ and Sapindacæ. He finds all intermediate stages between these and the normal structure of a root provided with a root-cap. The purpose of the capless roots appears to be to assist in the increased absorption and storing up of water where this is required. The various degrees of non-development of the root-cap may be summed up as follows:—The cap may be greatly reduced; and either with unlimited growth, as in *Trapa natans*, or with temporarily limited growth, as in *Sapindus Saponaria*, and partially in other Sapindacæ. The root may have at first a true cap, which may become changed into a permanent root-cap as in the Lemnacæ, or may be completely thrown off, as in *Azolla*, *Hydrocharis*, *Pistia*, and in the Bromeliacæ. The root may be from the first destitute of a cap; and then the growth may either be limited for a time, as in *Ungadia*,

* Bot. Centrallbl., xlvii. (1891) pp. 1-6, 33-42, 97-107, 164-70 (1 pl.).

† Ungar. Acad. Wiss., June 15, 1891. See Bot. Centrallbl., xlvii. (1891) p. 262.

‡ Ber. Deutsch. Bot. Gesell., ix. (1891) pp. 132-62 (2 pls.).

Stadmannia, *Diplopeltis*, *Cupania*, *Araucaria*, and *Podocarpus*; or the growth may be permanently limited, as in the Hippocastanaceæ and in the embryonal root of *Cuscuta*.

Tubercles on the roots of *Ceanothus*.*—Prof. G. F. Atkinson finds that the tubercles on the roots of *Ceanothus* are caused by a parasitic fungus allied to *Schinzia* (*Frankia*) *Alni* found upon the roots of *Alnus* and *Elæagnus*.

β. Physiology.

(1) Reproduction and Germination.

Weismann's Theory of Heredity.†—Herr W. Burck adduces arguments, from observations made in the East Indies and elsewhere, against the theory of Weismann that the cause of hereditary variability is sexual reproduction between different individuals. He finds that hereditary modifications often spring up without cross-fertilization. Thus in Java there are plants, of which *Myrmecodia tuberosa* is an example, which produce none but cleistogamic flowers; and these flowers present special adaptations for self-fertilization combined with properties which in other plants serve for the attraction of insects,—a white colour, abundant nectar, and proterogyny. The same is the case with various species of *Anona* and other Anonaceæ. The structure of the flowers of *Ophrys apifera* he regards as originally adapted for cross-fertilization, but afterwards modified for self-fertilization. In the case of many flowers, such as *Aristolochia* and *Coffea bengalensis*, which have been relied on as presenting striking illustrations of the necessity of cross-fertilization, the author asserts that the indications are quite as strong in favour of self-fertilization by insect-agency; dichogamous flowers are, he maintains, as a rule, pollinated from flowers of the same stock. Another argument in the same direction is furnished by European fruit-trees in Juan Fernandez, which are self-fertilized and abundantly fruitful.

Function of the Antipodals.‡—From an examination of the antipodals in the embryo-sac, especially in Ranunculaceæ and Gramineæ, Herr M. Westermaier attributes to them a more important function than has hitherto been assigned them; he does not regard them as merely useless survivals, but as serving an important purpose in the nutrition of the embryo. He arrives at this conclusion from the following considerations:—Their specific position in the embryo-sac, and the nature of their contents; their anatomical surroundings, and the cuticularizing of certain membranes in the ovule; the mode of distribution of the starch within the ovule; there being apparently special contrivances for the conduction of starch to the antipodals. In other cases they appear to be connected with the formation of the endosperm.

Reproductive Organs of Phanerogams.§—M. J. Hérail gives a summary of the present state of our knowledge of the formation of the

* Bot. Gazette, xvi. (1891) p. 262.

† Naturk. Tijdschr. Nederl.-Ind., xlix. pp. 501-46 (1 pl.). See Bot. Centralbl., 1891, Beih., p. 263.

‡ Nova Acta K. Leop.-Carol. Deutsch. Akad. Naturf., lvii. See Bot. Centralbl., 1891, Beih., p. 111.

§ 'Organes reprod. et formation de l'œuf chez les Phan.,' 143 pp. and 1 fig., Paris, 1889. See Bot. Centralbl., 1891, Beih., p. 272.

male and female organs in flowering plants, and of the details of the act of impregnation. The power of germination of pollen-grains was found to endure from one day in *Oxalis Acetosella* to eighty days in *Narcissus pseudo-Narcissus*. Light has a very prejudicial influence on the growth of the pollen-tube.

The origin of the embryo-sac in different plants is stated as follows:—In *Tulipa* and *Lilium* it is derived directly from the hypodermal axial apical cell. In *Cornucopix nocturnum*, this cell divides into two unequal daughter-cells, of which the subapical again divides into two, and of these the lower becomes the embryo-sac. In *Yucca gloriosa* the division of the original apical cell is somewhat more complicated; but again the lowest segment grows into the embryo-sac. In *Clematis cirrhosa* and *Cercis siliquastrum* the embryo-sac is again developed from the lowest segment. In the Gamopetalæ the hypodermal axial apical cell divides into either three or four mother-cells, of which the lowest becomes the embryo-sac.

With regard to the actual process of impregnation, the author agrees with Guignard rather than with Strasburger, and states that an actual fusion takes place of the male and female nuclei, the nucleoles present in both of them disappearing at the same time.

Cleistogamic Flowers.*—Herr W. Burck describes several species of tropical plants which produce cleistogamic flowers, in which cross-pollination is impossible, although the flowers are coloured and scented, and produce abundance of nectar. This is the case in a number of species of Anonaceæ. In *Myrmecodia*, the explanation appears to be afforded by the hypothesis that the flowers were originally adapted for cross-pollination, but that the visits of insects have been gradually suspended in consequence of the attacks of the warlike ants which always inhabit the tubers. In *Unona* sp. nov. the corolla remains always completely closed, and yet abundance of fruit is produced.

Importance of Heterogamy in the formation and maintenance of species.†—Commenting on Herr Burck's paper, Herr F. Rosen argues, from the phenomena connected with cleistogamic flowers, and others in the vegetable kingdom, that cross fertilization does not play so important a part in the maintenance of species as has been supposed by most recent writers. Even with many anemophilous plants, such as *Carex* and *Festuca*, inbreeding appears to be the rule.

Fertilization of *Lilium Martagon*.‡—Dr. E. Overton finds this plant a very favourable one for following out the development and coalescence of the sexual elements. The sculpturing of the mature pollen-grain is caused by short crowded rods; these are wanting in a narrow longitudinal band which is but slightly cuticularized, and through which the pollen-tubes penetrate. The number of threads in the nucleus of the pollen-grain is twelve in the great majority of cases, though in a few instances the number was undoubtedly less. The pollen-tubes are directed to the canal of the style by means of the bicellular stigmatic

* Ann. Jard. Bot. Buitenzorg, viii. (1890) pp. 122-64 (4 pls.).

† Bot. Ztg., xlix. (1891) pp. 201-11, 217-26.

‡ 'Beitr. z. Kenntniss d. Entwickelung u. Vereinigung d. Geschlechtsproducte b. *Lilium Martagon*,' Zürich, 1891, 11 pp. and 1 pl.

papillæ; after reaching the ovary they advance along a furrow, which is overspanned by threads of mucilage. The micropyle does not open of itself, but its cells are pressed apart by the pollen-tubes. The embryo-sac is, in this plant, developed directly from a hypodermal cell. A few cases of polyembryony were observed, in which the second embryo was undoubtedly the result of the impregnation of one of the synergidæ. The author is unable to confirm Westermaier's view* that the antipodals assist in the nutrition of the embryo; in *Lilium Martagon* they are undoubtedly without any such function.

Fertilization of *Iris sibirica*.†—Prof. A. Dodel has followed out the process of the impregnation of the oosphere in this plant. As long as the pollen-tubes are penetrating the stigma and style they are extremely slender, but increase rapidly in thickness when they have entered the ovary. A very large number of pollen-tubes enter the ovary, and it is not uncommon for more than one to enter a micropyle. In that case one or both of the synergidæ may be impregnated and develop into embryos. The following differences are presented between the oosphere and the synergidæ; the nucleus of the former contains a distinct spherical nucleole; those of the latter do not contain distinct nucleoles at the time of impregnation. The nucleus of the oosphere lies in its upper part, those of the synergidæ in their basal portion. A similar difference is exhibited in the distribution of the greater part of the cytoplasm; that of the oosphere is full of vacuoles, while that of the synergidæ contains scarcely any. These facts have led the author to the belief that the synergidæ must be regarded as partially aborted oospheres. It sometimes happens also that two of the sperm-nuclei (pollen-nuclei) enter the oosphere, and both coalesce with its nucleus.

Contrivances for Pollination.‡—Herr E. Loew has examined the structure of the flower, especially in relation to the facilities for insect-pollination, in a number of species belonging to the following natural orders:—Berberidæ, Papaveraceæ, Ribesiaceæ, Rosaceæ, Primulaceæ, Hydrophyllaceæ, Scrophulariaceæ, Solanaceæ, Boraginaceæ, Labiatae, Caprifoliaceæ, Liliaceæ, Amaryllidaceæ, Iridaceæ. With regard to the fifth barren stamen or staminode in *Pentstemon*, the author thinks that it may serve a variety of purposes;—the two rows of hairs with which it is frequently provided serving to detain the pollen which falls upon it, and also to protect the nectaries against the incursion of creeping insects. In the genus *Narcissus* there are, from this point of view, five different types of flowers, according as its structure is adapted for pollination by humble-bees or by Lepidoptera, or by both classes of insects.

Mr. G. F. Scott Elliot § describes the arrangements of structure in nearly 200 S. African and Madagascan Flowering Plants, belonging to a great variety of natural orders, which favour cross-pollination by the agency of insects, giving also a list of the visiting insects.

* *Vide supra*, p. 766.

† 'Beitr. z. Kenntniss d. Befruchtungs-Erscheinungen bei *Iris sibirica*,' Zürich, 1891, 15 pp. and 3 pls.

‡ Jahrb. f. Wiss. Bot. (Pringsheim), xxii. (1891) pp. 445-90; xxiii. (1891) pp. 207-54 (4 pls.).

§ Ann. of Bot., v. (1891) pp. 335-405 (3 pls.).

Herr O. Kirchner* gives very careful details of the structure of about 120 species of plants, natives of Württemberg, with especial reference to the adaptations of the structure of the flower for pollination by insect agency.

The last instalment of the series of papers on Flowers and Insects by Mr. C. Robertson† describes the mode of pollination of American species belonging to the Lobeliaceæ, Campanulaceæ, and Apocynaceæ.

Pollination and Hybridizing of *Albuca*.‡—Mr. J. H. Wilson describes the mode of pollination in several species of this genus from the Cape, belonging to the Liliaceæ. *A. corymbosa* is pollinated by humble-bees, and there is no spontaneous self-pollination. *A. fastigiata* is apparently sterile with its own pollen, either from the same or from a different flower; but is fertile when crossed with that of *A. corymbosa*. Attempts failed, on the other hand, to impregnate *A. corymbosa* with pollen of *A. fastigiata*. The hybrids obtained by impregnating *A. fastigiata* with pollen of *A. corymbosa* were intermediate in structure between the two parents; and their descendants, obtained by artificial pollination, retained these characters, and did not revert to the structure of either parent.

Pollination of *Orobanche*.§—Herr P. Knuth describes the mode of pollination in *Lathræa squamaria*, which is proterogynous and visited by humble-bees; and in *Phelipæa cærulea*, in which the flowers are blue and conspicuous, but are not visited by insects. In this species, as well as in *Orobanche elatior*, which has brown inconspicuous flowers, the structure is adapted for self-pollination.

Influence of Temperature on Germinating Barley.||—According to Mr. T. C. Day, the most important point brought to light by his observations on this subject is, that the sugars reach their maximum, the starch suffers the greatest amount of degradation, the permanently soluble nitrogenous compounds are present in the greatest quantity, and the diastatic ferment is the most active, in malt grown throughout at a temperature of 55° F. The evidence as to the peculiar change in the composition of the malts which were grown at a temperature above 55° F. is strongly corroborated by the determination of the carbon dioxide and dry root formed. At higher temperatures, it appears that a portion at least of the carbon dioxide was produced at the expense of the sugars and other soluble carbohydrates, formed at the earlier stages of germination, rather than that the whole was furnished by the oxidation of the starch.

Vitality of Seeds.¶—Mr. W. B. Hemsley records two illustrations of the fact that the seeds of sea-shore plants will germinate after prolonged immersion in salt water. Seeds of *Thespesia populnea* and of *Ipomæa*

* Beitr. z. Biol. d. Blüthen, Stuttgart, 1890. See Bot. Centralbl., xlvii. (1891) p. 138.

† Bot. Gazette, xvi. (1891) pp. 65-71. Cf. this Journal, 1890, p. 628.

‡ Bot. Jaarboek, iii. (1891) pp. 232-59 (1 pl.). See Bot. Centralbl., xlvii. (1891) p. 68.

§ Bot. Jaarboek, iii. (1891) pp. 20-32 (1 pl.). See Bot. Centralbl., xlvii. (1891) p. 67. || Journ. Chem. Soc., 1891, pp. 664-77 (2 pls. and 1 fig.).

¶ Ann. of Bot., v. (1891) pp. 406-7.

grandiflora, gathered in the Keeling Islands in 1888, germinated at Kew after having been kept dry for nearly two years, and then placed in seawater, where they remained floating for twelve months, before being placed in conditions favourable to germination.

Longevity of Bulbils.*—M. M. Gandoger records an instance of the retention of the power of germination by bulbils of *Allium roseum* after the bulbs had been preserved for more than fifteen years.

(2) Nutrition and Growth (including Movements of Fluids).

Absorption and Elimination of Solid Substances by Cells.†—Herr W. Pfeffer has investigated the conditions under which the absorption of solid substances can be effected by naked (primordial) cells, the observations having been made chiefly on the Myxomycetes, especially on *Chondrioderma difforme*. The protoplasm has, apparently, very little power of selection, substances which are useless, as well as those which are nutrient, being taken up, and the power of absorption, or of diffusion through the parietal utricle, appears to depend entirely on the motion of the particles of protoplasm amongst themselves, and is not in any way dependent on irritation. If not immediately dissolved, these foreign substances remain, for a shorter or longer period, either in the protoplasm or in the vacuoles. In the elimination of those which are not available for nutrition, the protoplasm appears to have much more selective power than in their absorption; some organic substances, such as *Navicula* and *Pandorina*, being thrown out by the plasmodes after remaining in them for about ten hours, as well as inorganic substances; while others are permanently retained. The protoplasm of cells inclosed in a cell-wall can only absorb or eliminate solid particles under exceptional conditions.

Assimilation and Transpiration.‡—M. H. Jumelle gives the details of various experiments on assimilation and transpiration, the following being the principal results obtained. The absence of carbonic acid in the atmosphere, in the light, accelerates transpiration. It is the arrest of assimilation which produces an augmentation of transpiration in the light. The presence of carbonic acid, in the light, does not affect transpiration of a plant, if this plant be deprived of chlorophyll. The fact, then, is amply proved that, in the light, the absence of carbonic acid accelerates the transpiration of plants, this acceleration being explained on the ground that the energy of the radiations absorbed by the chlorophyll, being no longer employed on the decomposition of the carbonic acid, is devoted to transpiration.

Assimilation in Umbelliferæ.§—M. G. de Lamarlière gives a table in which the assimilation of carbonic acid in three other species of Umbelliferæ is compared with that in *Angelica sylvestris*. Certain differences in the intensity of this assimilation can be explained, according to the author, by the comparative anatomy of the leaves. The following

* Bull. Soc. Bot. France, xxxviii. (1891) p. 244.

† Abhandl. Sächs. Gesell. Wiss., xvi. (1890) pp. 149-83 (1 pl.). See Bot. Ztg., xlix. (1891) p. 332.

‡ Rev. Gén. de Bot. (Bonnier), iii. (1891) pp. 241-8, 293-305. Cf. this Journal, 1889, p. 669.

§ Comptes Rendus, cxliii. (1891) pp. 230-2.

conclusions are arrived at:—(1) Species of Umbelliferae with greatly divided leaves assimilate more, for an equal surface, than those with entire or less divided leaves. (2) This difference in the intensity of the assimilation is explained by the disposition of the palisade tissue, which, instead of being in a single layer, may consist of several superposed layers.

Assimilation of free atmospheric Nitrogen.*—Dr. R. Otto gives a *résumé* of the results of the more important investigations on this subject from the time of de Saussure at the commencement of the century to the present time.

Absorption and Metabolism of Fatty Oils.†—Herr R. M. Schmidt has carried out a series of experiments for the purpose of determining in what way the fatty oils contained in many seeds are employed in the nutrition of the young plant. The experiments made on the absorption of almond-oil by mould-fungi and by the cells of higher plants, appear to indicate that the passage of such oils through living cellulose membranes is the result of a saponification caused by the combination of a substance present in the cell-wall with the free fatty acids. It is possible also that a direct passage of the oil from cell to cell may take place, since the parietal utricle is permeable for oils; and in the germination of oily seeds, observation has not at present shown that any large quantity of free fatty acids is produced; these are apparently formed only at a comparatively late period.

(3) Irritability.

Anatomico-physical causes of Hygroscopic Movements.‡—Herr C. Steinbrinck has undertaken an investigation of the mechanical causes of the hygroscopic movements which bring about the bursting of mature capsules and pollen-sacs. The hygroscopic tension may be produced mainly by the normal shrinking either of layers or of striæ; to the former type belong the capsules of *Linaria*, *Antirrhinum*, and *Helianthemum*, and the pollen-sacs of the Cycadeæ; to the latter class the capsules of *Luzula* and of the Caryophyllæ (*Dianthus*, *Saponaria*, *Silene*, *Gypsophila*, and *Spergula*); those of *Lychnis vespertina* show an intermediate structure between the two. The details of the structure are described in the various species examined.

Irritability of the Leaves of Dionæa.§—According to Mr. J. M. Macfarlane, all parts of the lamina of the leaf of Venus's fly-trap are sensitive to surface stimulation. For mechanical stimulus of the leaf two touches are needed to cause contraction, unless the stimulus be very powerful, and they must be separated by a greater interval than one-third of a second. If less than one-third of a second elapses there is no contraction, and a third touch is then needed. In the first case no effect is produced if 35–40 seconds elapse between the stimuli. The author claims a perfect parallelism between combined nerve and muscular action in animals and contractive action in *Dionæa*.

* Bot. Centralbl., xlv. (1891) pp. 387–91; xlvii. (1891) pp. 62–7, 123–9, 175–90.

† Flora, lxxiv. (1891) pp. 300–70. ‡ Tom. cit., pp. 193–219 (1 pl. and 1 fig.).

§ Bot. Gazette, xvi. (1891) p. 258.

Heliotropic Sundew.*—Prof. B. D. Halsted states that the giant American sundew, *Drosera filiformis*, is heliotropic; a new flower opens each day at the top of the bend of the curved inflorescence; and this flower, when it opens, invariably faces the morning sun.

(4) Chemical Changes (including Respiration and Fermentation).

Influence of Light on Respiration.†—M. K. Purjewicz has made an extended series of observations on this subject. His general results agree with those of Bonnier and Mangin ‡ that light has a prejudicial effect on respiration in plants. The mode of estimating the amount of carbon dioxide produced was by precipitation with baryta water. The object examined was exposed alternately to light and darkness for periods varying between $\frac{1}{2}$ and $1\frac{1}{2}$ hours.

With hymenomycetous fungi this result was obtained in 42 experiments out of 43, the reduction in the amount of CO_2 produced in a given time varying between the proportions of 0.58:1 and 0.90:1. The period of growth taken was either before the separation of the margin of the pileus from the stipe or at the maturity of the pileus; at which periods the intensity of respiration is very constant, while in the intermediate period of rapid growth it varies rapidly. Experiments with roots and rhizomes of Flowering Plants, with flowers, and with etiolated leaves, gave no uniform result, the intensity of the respiration being in some cases increased, in others decreased, by the action of light.

Formation and Decomposition of Oxalic Acid and its Function in the Metabolism of Fungi.§—From a very extended series of observations on certain fungi, belonging chiefly to the *Mucor*, *Aspergillus*, and *Penicillium* group, Herr C. Wehmer dissents from the views entertained by other authorities with regard to the importance of oxalates in the vital economy of the plant. Oxalic acid he regards as a secondary, but not always a final, product of metabolism, which may sometimes be excreted, or the formation of which may sometimes be altogether suspended. The conclusions were the result of the culture of the fungi in a great number of different nutrient solutions. The author believes that the same laws regulate the formation of oxalates in the higher plants as in fungi, and that their production is dependent entirely on the conditions in which their growth takes place; even the entire absence of oxalic acid, or of its salts, has no special significance as regards the vital economy of the plant.

As regards the conditions most favourable for the formation of oxalic acid,|| Herr Wehmer finds, in the case of *Aspergillus niger*, an optimum temperature (34° – 35° C.), above which an increase of temperature is decidedly unfavourable to the formation of free oxalic acid. Light has a powerful effect in bringing about the decomposition of oxalic acid;

* Bull. Torrey Bot. Club, xviii. (1891) pp. 212–3.

† Schrift. Naturf.-Gesell. Kiew, xi. (1890) pp. 211–59. See Bot. Centralbl., xlvii. (1891) p. 130.

‡ Cf. this Journal, 1886, p. 1016.

§ Bot. Ztg., xlix. (1891) pp. 233–46, 249–57, 290–8, 321–32, 338–46, 351–63, 370–4, 385–96, 401–7, 417–27, 433–42, 449–55, 465–78, 511–18, 531–9, 547–54, 563–71, 570–84, 596–602, 611–20, 630–8.

|| Ber. Deutsch. Bot. Gesell., ix. (1891) pp. 163–83, 218–28.

while in the dark no such decomposition takes place as long as living organic material is wanting; neither dead organic substances nor such compounds as are found within the cell are active in this way.

Alcoholic Fermentation and the Conversion of Alcohol into Aldehyde by the "Champignon du Muguet."*—MM. G. Linossier and G. Roux, referring to the character of the fermentation induced by the "champignon du muguet," state that three stages may be distinguished during the fermentation, viz.:—(1) rapid growth of the organism; (2) active fermentation; (3) lessened activity due to the toxic influence of the fermentation products, aldehyde having, it would seem, the greatest effect. "Muguet" can cause the fermentation of dextrose, levulose, and maltose; saccharose is neither inverted nor fermented. In the slowness with which fermentation takes place, and in the maximum concentration of alcohol produced, and in the ratio of weight of sugar destroyed to weight of organism produced, the "champignon du muguet" exhibits marked analogies with the Mucorini, and differs considerably from the Saccharomycetes. The conclusion that the organism does not belong to the latter is borne out by the results of a careful morphological study.

Fermentation of Bread.†—M. L. Boutroux asserts that the fermentation of bread consists essentially in a normal alcoholic fermentation of the sugar which already exists in the flour. The yeast plays a double part; it produces a disengagement of gas which causes the dough to swell, and it prevents the bacteria, which are parasitic on the starch-grains, from developing, and thus making the dough sour and dissolving the gluten. M. Boutroux finds in the yeast three distinct microbes, two bacilli and a bacterium, but concludes that they play no direct part in the process of fermentation; if they are of any service at all, it is simply in the production of the fermentable substance, that is, of the sugar.

Commenting on this paper, M. Chicaudard ‡ states that, at the period when the dough is placed in the oven, he finds in it immense numbers of bacilli, but no yeast-cells. He considers, therefore, the fermentation of bread to be a fermentation of the gluten caused by *Bacillus glutinis*.

Fermentations induced by the Pneumococcus of Friedlaender.§—In the experiments carried out by Dr. P. F. Frankland, Mr. A. Stanley, and Mr. W. Frew, the pneumococcus had been cultivated for nearly three years on gelatin-peptone, and was afterwards further purified by obtaining a single colony through the intermediary of a plate cultivation. The authors recount the details of their experiments at considerable length, but it will suffice to recapitulate their results, which are summarized as follows:—

(1) The pneumococcus of Friedlaender sets up a fermentative process in suitable solutions of dextrose, cane-sugar, milk-sugar, maltose, raffinose, dextrin, and mannitol.

(2) It does not ferment solutions of dulcitol or glycerol, and has

* Bull. Soc. Chim., iv. pp. 697-706. See Journ. Chem. Soc., 1891, Abstr., p. 854.

† Comptes Rendus, exiii. (1891) pp. 203-6. Cf. this Journal, 1889, p. 253.

‡ Comptes Rendus, exiii. (1891) p. 612.

§ Journ. Chem. Soc., cccxli. (1891) pp. 253-70.

thus the power, like the *Bacillus ethaceticus*, of distinguishing between the isomers mannitol and dulcitol.

(3) In the fermentation of dextrose and mannitol, the principal products are ethyl-alcohol and acetic acid, with a smaller proportion of formic acid, and traces of a fixed acid, in all probability succinic acid.

(4) The gaseous products are carbonic anhydride and hydrogen.

(5) The ethyl alcohol, volatile acids, carbonic anhydride, and hydrogen, approximate to the molecular proportions $9C_2H_6O$, $4C_2H_4O_2$, $12CO_2$, $8H_2$.

(6) The productions of which may be most readily referred to the following equations:— $6C_6H_{14}O_6 + OH_2 = 9C_2H_6O + 4C_2H_4O_2 + 10CO_2 + 8H_2$, which is followed by $4C_2H_4O_2 + 2CaCO_3 = 2CO_2 + 2OH_2 + 2Ca(C_2H_3O_2)_2$.

Diastatic Ferment in Green Leaves.*—Prof. S. H. Vines criticizes the statement of Wortmann † that green leaves contain no diastase, or not a sufficient quantity to effect the transformation of starch into sugar which takes place in them. He gives details of experiments which appear to him to establish the fact that a diastatic ferment is present in green leaves; and, though the quantity found at any moment may be comparatively small, it is probable that the total amount secreted during a night would suffice to effect the observed conversion of starch into sugar.

γ. General.

Evolution of Parasitic Plants.‡—Mr. T. Meehan believes that the distinction between parasitic and non-parasitic plants is by no means an absolute one; but that many species usually parasitic will grow in the ordinary way in the soil, and have, as now existing, acquired parasitic habits. Many species of Santalaceæ are partial parasites. *Sarcodes sanguinea* and *Orobanche* will germinate in ordinary garden soil, and go on with their development through all its stages; and *Monotropa* will grow in soil with only the slightest modicum of vegetable matter.

Exudation of Sap by Mangifera.§—M. H. Leveille records a singular effect of the wet season on *Mangifera indica*. It produced no fruit; but from the extremity of the young shoots was exuded a yellow viscous saccharine fluid, identical with that ordinarily contained in the mango-fruit. He regards this as the elaborated sap which, not being required for the development of the fruit, is thus thrown off.

B. CRYPTOGAMIA.

Cryptogamia Vascularia.

Life-history of Isoetes.||—Prof. D. H. Campbell has carefully followed out the development of the female prothallium and embryo of *Isoetes echinospora* var. *Braunii*. His researches confirm the view of the affinity of *Isoetes* with the Filicineæ rather than with the Lycopodineæ. The development of the oophyte resembles much more nearly that of

* Ann. of Bot., v. (1891) pp. 409-12.

† Cf. this Journal, ante, p. 221.

‡ Bull. Torrey Bot. Club, xviii. (1891) p. 210-2.

§ Bull. Soc. Bot. France, xxxviii. (1891) p. 286.

|| Ann. of Bot., v. (1891) pp. 231-58 (4 pls.).

Gymnosperms, or the endosperm of Angiosperms, than it does the prothallium of any pteridophyte (except possibly *Selaginella*). In the multiciliate antherozoids, and in the absence of a suspensor, *Isoetes* resembles ferns rather than lycopods; the body of the antherozoid is derived, as stated by Guignard, from the nucleus of the mother-cell.

The microspore produces, on germination, a single prothallial cell, and an antherid composed of four peripheral and four central cells; each of the latter gives rise to a single antherozoid. The process of cell-division in the ripe megaspore is entirely similar to that in the embryo-sac of most Phanerogams. The first archegone arises from one of the first-formed cells, at the centre of the apical region. The prothallium is incapable of independent growth, and dies after the supply of food in the spore is exhausted. More than one archegone may be fertilized, but the complete development of more than one embryo has not been observed. The secondary thickening of the stem is of a different type from that in Gymnosperms and Dicotyledons, approaching more nearly that found in a few Monocotyledons. The author's results differ in some respects from those obtained by Farmer* in the case of *I. lacustris*.

Sieve-tubes of Filicineæ and Equisetineæ.†—M. G. Poirault discusses the characteristic differences between the sieve-tubes in Phanerogams and those in Cryptogams. The modification which occurs in the latter consists principally in the fact that while the punctations of the membrane are open in Phanerogams, in Vascular Cryptogams they are always closed. Janczewski has also stated that in the former we have callus, which is absent in the latter; the only exception to this rule being *Pteris aquilina*, in which we find callus, as in Phanerogams. M. Poirault does not, however, agree with Janczewski in this point, having found callus in Ferns, Marattiaceæ (?), Equisetaceæ, and Hydropterideæ, the only exception being the sieve-tubes of Ophioglossaceæ. The author does not insist on the absence of a nucleus and the presence in the tubes of numerous granules; and on this point his observations agree absolutely with those of Janczewski.

Nectaries of *Pteris aquilina*.‡—Herr W. Figdor describes the nectariferous organs of the common brake, which are found at the base of the pinnae of the first or second order. When young they form triangular projections, which gradually become flatter. Their surface is distinguished from that of the rest of the axis by being quite glabrous, and is usually reddish. The cells of the nectar-gland are about the size of those of the ordinary fundamental parenchyme, and are often separated by intercellular spaces. They are furnished with stomates, some of which appear to possess the ordinary function, while others serve for the excretion of the saccharine fluid. Beneath the nectary is the end of a vascular bundle. Its cells contain a large nucleus, few chlorophyll-grains, and a number of larger or smaller strongly refringent granules; those at the margin also contain anthocyan. With increasing age the nectaries become functionless.

* Cf. this Journal, *ante*, p. 376.

† Comptes Rendus, cxiii. (1891) pp. 232-4.

‡ Oesterr. Bot. Zeitschr., xli. (1891) pp. 293-5 (2 figs.).

Peculiarity in the Root of *Ceratopteris thalictroides*.*—M. G. Poirault describes a peculiarity in this aquatic Fern. The roots produce two series of opposite rootlets; but sometimes the one and sometimes the other remains intracortical. After traversing the internal cortex, they reach one of the lacunæ in the internal cortex, and finding there conditions favourable to their development, they do not continue their growth towards the exterior, but descend vertically in the cortex for a considerable distance.

Structure of the Primary Fibro-vascular System in *Lepidodendron selaginoides*.†—M. M. Hovelacque states that in the stipe of *Lepidodendron selaginoides* two main regions can be distinguished:—(1) The fibro-vascular mass including the central primary xylem and a primary phloem-crown, between which is a zone of secondary fibro-vascular tissue. (2) The cortex, which may be divided into three zones. The foliar traces detach themselves from the primary xylem in the form of small circular ligneous masses, and traverse the secondary xylem horizontally. The primary phloem is more differentiated than that of *Lepidodendron Harcourtii*, and at the exterior consists of a pericambial zone of similar parenchymatous elements.

Muscineæ.

New Genera of Mosses, *Aulacomitrium* and *Willia*.—In his enumeration of all the species of Musci and Hepaticæ recorded from Japan, Mr. W. Mitten ‡ describes a number of new species belonging to each order of Muscineæ, and the following new genus of Musci,—*Aulacomitrium*. Theca apicalis, æqualis; folia perichætii in vaginam exsertam convoluta; calyptra mitriformis, plicata.

Among a large number of new species of Mosses from South Georgia, obtained in the German Polar Expedition, Herr C. Müller (Hal.) § describes a new genus and species *Willia grimmioides*, with the following generic characters,—Folia *Syntrichie*, sed stricta *Eubarbulæ*, apice hyalino-limbata, calyptra capsulam omnino obtegens, cylindrico-campiculata, basi in lobos rotundatos incisos subinflexos hookerioideo-divisa; peristomium nullum.

Characeæ.

Rabenhorst's Kryptogamen-Flora v. Deutschland (Characeæ).—Parts 5 and 6 of Dr. W. Migula's monograph of the Characeæ commence with the completion of the description of *Tolypellopsis stelligera*. A full account is then given of the genus *Lamprothamnus* and its single species *L. alopecuroides*, and of *Lychnothamnus* and its single species *L. barbatus*. There is a description of the general characters of *Chara*, and a schedule of its twenty-seven species, followed by a commencement of the description of the species in detail. The letterpress is exhaustive, and the illustrations are of remarkable excellence.

* Journ. de Bot. (Morot), v. (1891) p. 264.

† Comptes Rendus, cxliii. (1891) pp. 97-100.

‡ Trans. Linn. Soc. Lond. (Bot.), iii. (1891) pp. 153-206 (1 pl.).

§ 'Bryologia Austro-Georgiæ' (Separat-Abdr. Deutsch. Polar Exp.), 46 pp. See Bot. Centralbl., 1891, Beih., p. 175.

Algæ.

Influence of the Concentration of Sea-water on the Growth of Algæ.*—Dr. F. Oltmanns finds, from a series of experiments on various sea-weeds, especially species of *Fucus*, that an alteration in the proportion of salts contained in the water, say between 1·0 and 1·8 per cent., is prejudicial to their growth only when the alteration takes place suddenly; if it is effected slowly, the injurious influence is but slight. The cause of the injury is probably the inability of the cells of the plant to adapt themselves suddenly to changes of turgor. Since different species show different degrees of inability in this respect, alterations in the constitution of the sea-water caused by variations in the influx of fresh water have a material influence on the marine flora.

Endophytic Algæ.†—Herr M. Möbius gives a conspectus of all the endophytic algæ known, of which he enumerates ninety-two species, including the new *Bolbocoleon? endophytum*, which inhabits the cell-walls of *Cladophora fracta*. Of these some have been observed only on one host, others on several. They inhabit other Algæ—Rhodophycæ, Phæophycæ, and Chlorophycæ; very rarely Fungi; Musci—especially *Sphagnum*, more often Hepaticæ; *Azolla* among Vascular Cryptogams; several orders of Gymnosperms, Monocotyledones, and Dicotyledones; among animals, sponges and a great variety of marine species. With the exception of those which inhabit the shells of molluscs or of turtles, they penetrate either the cells or only the cell-walls of both plants and animals. They may or may not be injurious to the host.

"Meteor-paper."‡—M. J. Istvánfi gives the following as the composition of several specimens of this structure gathered by him in Germany and Hungary:—(1) *Cladophora fracta* var., with specimens of *Oscillaria tenuis*, *Chlamydomonas Pulvisculus*, *Herpoteiron repens*, *Edogonium longatum*, and *Hantzschia Amphioxys*; (2) *Lyngbya turfosa*, with nine species of unicellular algæ; (3) *Edogonium tenellum*; (4) a loose web of the resting-form of a species of *Conferva*; (5) *Microspora floccosa*, together with specimens of *Oscillaria tenuis*, *Ulothrix subtilis*, twenty-one species of diatoms, three of desmids, and one of Pleurococcaceæ.

Reproductive Organs of Florideæ.§—Mr. T. H. Buffham describes the antherids in the following species of Florideæ, in which they had not previously been observed or figured:—*Bangia fusco-purpurea*, *Callithamnion arbuscula*, *Griffithsia barbata*, *Ptilota elegans*, *Ceramium echionotum*, *C. transcurrens*, *C. flabelligerum*, *Phyllophora membranifolia*, *Plocamium coccineum*, *Nitophyllum laceratum*, *Lomentaria kaliformis*, *Chondriopsis dasyphylla*, *Rytiphloea pinastroides*, *Polysiphonia elongata*. Procarys and trichogynes were also observed in *Callithamnion tetragonum*, *C. roseum*, *C. byssoideum*, *C. granulatum*, *Griffithsia barbata*, and *G. corallina*; in most cases the pollinoids were detected adhering to the trichogynes. In *Griffithsia corallina* and *Ceramium flabelligerum* there are two trichogynes to each procary. *Callithamnion byssoideum* was found bearing branching

* SB. K. Preuss. Akad. Wiss., 1891, pp. 193-203 (1 pl.).

† Notarisia, vi. (1891) pp. 1221-36, 1279-86, 1291-1304 (1 fig.).

‡ Természetrázi Füzetek, vol. xiii. See Bot. Centralbl., xlvii. (1891) p. 51.

§ Journ. Quek. Micr. Club, iv. (1891) pp. 246-53 (2 pls.).

strings of spores in the place of the usual cystocarps. They bear a close resemblance to seirospores, and appear to be developed in the absence of fecundation.

Chreocolax.*—Mr. H. M. Richards discusses the structure and systematic position of *Chreocolax Polysiphoniæ*, parasitic on *Polysiphonia fastigiata* on the coast of New England. He succeeded in detecting not only the tetraspores, but also the trichogyne and accompanying organs, as well as the cystocarp. It is a true parasite, obtaining its nourishment from the tissue of the sea-weed on which it grows. The tetraspores develop from the terminal cells of the plant, and may be either tripartite or cruciate. The structure of the cystocarp appears to remove the genus from the Gelidiaceæ, in which it has hitherto been placed, and to transfer it to the Chætangiaceæ. The cystocarp resembles that of *Chætangium*, and still more closely that of *Galaxaura*. The frond is immersed in a great mass of gelatinous matter.

Sphacelariaceæ.†—Herr J. Reinke gives in further detail a monograph of this order of Phæosporeæ. Only one new species is described, *Sphacelaria indica* from Singapore, increasing the number of species of that genus from twelve to thirteen, while those of *Cladostephus* are reduced from three to two.

Cladothele and Stictyosiphon.‡—Mr. G. Murray has made a fresh examination of *Cladothele Decaisnei*, from the Falkland Islands, hitherto placed, though doubtfully, among the Siphonæ. He found sporanges of the type familiar among the Phæophyceæ; and states that the alga is indistinguishable from *Stictyosiphon*, corresponding to that genus in the structure of the central axis and in the peripheral cells. The genus *Cladothele* must therefore be abolished, and its only species be united to *Stictyosiphon*, a genus of Punctariaceæ.

Cladophora.§—M. E. de Wildeman confirms Gay's observations on the production of rhizoids by *Cladophora*. When, under cultivation, a cell loses its cell-contents, it is common for an adjoining cell to put out rhizoids, which penetrate into the cavity of the dead cell, which they may traverse, and continue to grow in the surrounding fluid. Both *C. glomerata* and *C. fracta* undergo a great variety of modifications in cultivation, and it is probable that a large number of the very numerous species described are but modifications of one. The formation of bulbous or pear-shaped swellings is frequent, and the author has observed the production of rings in the cell-wall resembling those of *Edogonium*.

Hormidium, Schizogonium, and Hormiscia.||—Prof. A. Hansgirg recapitulates the arguments in favour of his view that the aerophytic species of these genera are all connected genetically with one another, and with *Prasiola*, and replies to the observations of Gay, who is opposed to the theory of the polymorphism of the lower Algæ.

* Proc. Amer. Acad. Arts and Sci., xxvi. (1891) pp. 46-63 (1 pl.).

† Biblioth. Bot. (Luerssen u. Haenlein) Heft 23, 1891 (40 pp. and 13 pls.). Cf. this Journal, ante, p. 225.

‡ Journ. of Bot., xxix. (1891) pp. 193-6 (1 pl.).

§ Bull. Soc. Belge Micr., 1891, pp. 154-9 (4 figs.). Cf. this Journal, ante, p. 503.

|| Bot. Centralbl., xlvii. (1891) pp. 6-9. Cf. this Journal 1888, p. 1002.

Pachytheca.*—Mr. C. A. Barber has carefully studied numerous specimens of this fossil from the Old Red Sandstone and Silurian formations, and concludes that it is a spherical alga consisting of a mass of cellular filaments. The cells of these filaments appear to resemble in general shape those of a living *Cladophora*.

Dr. W. T. Thiselton-Dyer † confirms Mr. Barber's statement of an organic connection between the cortical cells and those of the peripheral tissue.

Fungi.

Mycorhiza.‡—M. P. Vuillemin adopts Frank's view with regard to the nature of mycorhiza. He proposes the classification of the various kinds into Ascorhizæ and Basidiorhizæ, and the latter again into Hymenorrhizæ and Gasterorrhizæ. For the corresponding structure in *Corallorhiza* and *Epipogium* he suggests the term *mycorrhizome*.

Endotrophic Mycorhiza.§—Summing up the present state of our knowledge with regard to the various instances of endotrophic mycorhiza, Herr B. Frank regards them as fungus-consuming plants, comparable to other carnivorous plants, which have the power of attracting the fungus into their protoplasm, and finally digesting it. The organs in which this digestion takes place are not true roots, but new formations of a peculiar morphological character, for which he proposes the term *mycodomatia* or fungus-chambers. The known examples of endotrophic mycorhiza may be classed under the following four heads:—

(1) Endotrophic Mycorhiza of the Orchidææ. The fungus is here, from the first moment of its development until the close of its life, completely inclosed in the active protoplasm of the root-cell. The fungus-hyphæ gradually lose their albuminous contents, and give them up entirely to the host, losing, at the same time, their power of independent growth.

(2) Endotrophic Mycorhiza of the Ericaceææ. The phenomena are here very similar to those which occur in the Orchidæææ.

(3) Symbiosis of the Leguminosææ. The Schizomycete is here taken up from the soil into the cells of the root, and there digested in the root-tubers formed for the purpose. But when the bacteroid tissue has been absorbed, some germs still remain which return to the soil on the decay of the tuber.

(4) Symbiosis of the Alder. The process shows a complete analogy with those of the Leguminosææ. The formation of sporanges by *Frankia subtilis*, described by Brunchorst, appears to rest on erroneous observation.

The ectotrophic mycorhiza of the Cupuliferææ and Coniferææ does not come under either of the above headings.

Disarticulation of Conids in the Peronosporææ.||—According to M. L. Mangin, the septum which separates the conid from the basid or

* Ann. of Bot., iii. (1890) pp. 141-8 (1 pl.); v. (1891) pp. 145-62 (1 pl.).

† Op. cit., v. (1891) pp. 223-5.

‡ Rev. Gén. Sci. pures et appliquées, i. (1890) pp. 326-35. See Bot. Centralbl., 1891, Beih., p. 192.

§ Ber. Deutsch. Bot. Gesell., ix. (1891) pp. 244-53. Cf. this Journal, ante, p. 504.

|| Bull. Soc. Bot. France, xxxviii. (1891) pp. 176-84, 232-6 (1 pl.). Cf. this Journal, ante, p. 381.

sterigma in the Peronosporæ, always consists originally of callose, to the entire exclusion of cellulose, which is only developed at a later period when the conid is fully formed. This callose, at first exceedingly resistant to the action both of water and of chemical reagents, is capable of undergoing modifications, the nature of which is at present unknown, by which it becomes soluble in water. On the access of water to the septum, this process of dissolution of the callose takes place at once, and the conids thus become disarticulated.

The species most carefully examined was *Cystopus candidus*. The basid is a club-shaped cell, the wall of which is very thick below, much thinner in the upper portion. When a conid is about to be produced, a ring of callose is formed in this upper part which is at first very thin and scarcely visible, but gradually becomes thinner and forms a funnel-like structure with the opening pointing downwards; this opening gradually closes, and the upper portion of the basid is now cut off as a conid, a sudden narrowing taking place at the line of the septum by the absorption of the outer cellulose-wall at that spot. The callose septum now assumes successively the form of a cup and of a cylinder; and by the repetition of this process, a string of conids may be formed attached to one another by cylinders of callose, and at length set free by the dissolution of these cylinders. This same process appears to take place uniformly throughout the Peronosporæ; but is much more difficult to follow in the species of *Plasmopara* and *Peronospora*, and in *Bremia Lactuceæ*.

Penetration of the Host by *Peronospora gangliformis*.*—Mr. W. H. Rush describes the mode in which the germ-tubes of this fungus penetrate the epiderm of *Lactuca sativa*—through the stomates, and not through the cell-walls as stated by De Bary. The germ-tubes will sometimes curve, apparently for the purpose of reaching a stomate.

Biology of *Phycomyces nitens*.†—M. A. De Wèvre has made a series of experiments on the growth of this fungus on bread soaked with various nutritive substances and under varying conditions of light and moisture. The following are the general conclusions at which he has arrived:—Solid substrata give better results than soft, and especially than liquid media. *Phycomyces* is subject to modification according to the nutritive medium on which it develops, in relation to its size, colour, branching, rapidity of growth, and the production of septa and swellings. Light has a tendency to diminish its size, and moisture is very prejudicial to its growth.

Doassansia.‡—Dr. W. A. Setchell gives a monograph of this genus of Ustilaginæ, comprising twelve species, three of them new, which he arranges in three subgenera, *Eudoassansia*, *Pseudodoassansia*, and *Doassansiosis*. He appends descriptions of two new nearly allied genera:—*Burrillia*, Sorus compact, not separating into its elements on being crushed; central portion composed of an irregular mass of parenchymatous tissue; spores closely resembling those of *Entyloma*, both in structure and in germination, compacted into several dense rows; cortex

* Bot. Gazette, xvi. (1891) pp. 208-9 (1 fig.).

† CR. Soc. R. Bot. Belgique, 1891, pp. 107-25.

‡ Proc. Amer. Acad. Arts and Sci., xxvi. (1891) pp. 13-9.

none, or composed only of a thin irregular layer of hardened hyphæ. *Cornuella*, Sorus hollow at maturity, the interior containing only loose hardened hyphæ; spores compacted into a firm layer on the outside, resembling those of *Entyloma*, both in structure and in germination; cortex none.

Fungus-parasites of the Sugar-cane.*—Herr W. Krüger describes the following diseases of the sugar-cane caused by the attacks of vegetable parasites which are destructive of the crop in Java.

The "dust-brand," by *Ustilago Sacchari*. The mycele penetrates almost the entire plant; the fructification makes its appearance at the apex of the stem or branches.

The "red-spots" on the leaves are caused by *Cercospora Kōpkei* sp. n.; they appear first on the under, subsequently on the upper side of the leaves, and are at first yellow, afterwards red; the mycele on the under side of the leaf puts out tufts of branches bearing white multicellular spores. A similar disease is caused by *C. vaginæ* sp. n.

The "rust" caused by *Uromyces Kühni* sp. n. Only the uredospores are at present known.

The "sclerote-disease" appears in the form of a silver-white mycele on the under side of the leaves, which develops later into yellowish-white sclerotes. Its further history is unknown.

Other diseases are probably produced by a *Pythium* and by a *Bacterium* resembling *B. Termo*.

Fungus parasitic on Balanus.†—M. C. Bommer describes a new pyrenomycetous fungus, *Pharcidia marina*, growing on the shell of *Balanus balanoides*, in Holland. It produces small peritheces, 117-207 μ , half imbedded in the calcareous substance of the shell, in a superficial layer of a unicellular alga belonging to the Chroococcaceæ, which is permeated by a network of mycelial filaments. The asci are club-shaped and shortly pedicellate; the spores oblong and uniseptate, 12-18 μ by 4-7 μ .

New Genus of Fungi (Sphæropsidæ).‡—Among a number of new species of fungi belonging to the Mucorini and Sphæropsidæ, M. E. Marchal describes the new genus *Trichocrea*, with the following diagnosis:—Perithecia superficialia, ovoidea, contextu parenchymatico, ceraceo-molliuscula, læticoloria, initio clausa, demum late aperta, fere discoidea; sporulæ numerosissimæ, cylindraceæ, 1-septatæ, hyalinæ; basidiis elongatis, filiformibus, dense fasciculatis, sursum 1-3-ramosis, suffultes. The author considers the genus to have affinities both with the Sphæropsidæ and with the Hyphomycetes; but its very regularly developed perithece of parenchymatous texture identifies it most closely with the Nectrioideæ.

New Pestalozzia.§—Under the name *Pestalozzia insidens*, Mr. J. L. Zabriskie describes a new species found in New York State on the bark of living elm-trunks, in which the conid is divided into four inner very

* Ber. Versuchsstat. Zucker-rohr in West-Java, Heft 1, 1890, pp. 50-179 (5 pls.). See Bot. Centralbl., xvii. (1891) p. 46.

† Bull. Soc. Belge Micr., 1891, pp. 151-2.

‡ CR. Soc. R. Bot. Belgique, 1891, pp. 134-46.

§ Journ. N. York Micr. Soc., vii. (1891) pp. 101-2 (1 pl.).

dark brown and two terminal hyaline cells, and each of the latter is prolonged into a stout curved acuminate hyaline bristle.

Diseases caused by Fungi.*—Prof. J. E. Humphrey gives a detailed account of the following diseases and the fungi which cause them:—

The black knot of the plum, a disease very destructive to all kinds of plums and cherries, both cultivated and wild, in the United States, but not yet known in this country. It is caused by the attacks of *Plowrightia morbosa*, belonging to the Sphæriaceæ.

The cucumber-mildew, which has recently appeared in various parts of America and in Japan, on several species of Cucurbitaceæ. It is due to *Plasmopara cubensis*, originally found in Cuba.

The brown rot of stone-fruits, very widely spread both in Europe and America, due to *Monilia fructigena*.

The actual cause of the disease known as "potato scab" the author regards as at present uncertain.

Fungus-parasites on Pines.†—MM. E. Prillieux and Delacroix describe two fungi which are parasitic on and injurious to pine-trees, —*Dothiorella Pitya*, on the spruce-fir, and especially on seedlings; and *Physalospora abietina* sp. n., belonging to the Sphæriaceæ, on *Abies excelsa*.

Fructification of *Physcia pulverulenta*.‡—Herr C. Mäule has closely observed the development of the fructification of this lichen, in order to determine the correctness of Lindau's hypothesis that the apothecæ has its origin in certain cells, found chiefly in the gonidial layer, to which he gives the term "primordia." Herr Mäule finds the earliest appearance of the apothecæ in a cluster of cells with reddish contents confined to the boundary-line of the gonidial and medullary layers. The "primordia," on the other hand, are distributed through the entire gonidial layer; and he regards them as cells differing from the remaining cells of the thallus in their chemical nature, but having nothing to do with the formation of the fructification. He proposes for them the term "Lindau's cells."

Germination of Spores in *Saccharomyces*.§—Herr E. C. Hansen, in narrating his experiments with three kinds of *Saccharomyces*, *S. cerevisiæ*, *S. Ludwigii*, and *S. anomalus*, states that the germination stages of all three were followed from one and the same spore. The germination of *S. cerevisiæ* has already been noticed in this Journal (1885, p. 849). That of *S. Ludwigii* is chiefly remarkable from the fact that the yeast-cells are not developed directly from spores, but from a promycete, and also from the fact that the new formations become fused together, giving rise to characteristic fusion-forms from which yeast-cells develop. When old spores germinate fusion-forms are not observed, but a transversely septate mycelium arises. The spores of *S.*

* Eighth Ann. Rep. Massachusetts Exper. Stat., 1890, pp. 200-26 (2 pls.).

† Bull. Soc. Mycol. France, vi. (1890) pp. 98 and 113 (2 pls.). See Bot. Centralbl., xlvii. (1891) pp. 173 and 174.

‡ Ber. Deutsch. Bot. Gesell., ix. (1891) pp. 209-13.

§ CR. Travaux du Laborat. de Carlsberg, iii. (1891) part 1. See Centralbl. f. Bakteriöl. u. Parasitenk., ix. (1891) pp. 663-4.

anomalus resemble those of *Endomyces decipiens*, but are distinguished therefrom by being smaller and by budding like *S. cerevisiæ* i.

The author's article ends by criticizing the attempts which have been made during the past thirty years to show that the Saccharomycetes are not independent species, but developmental forms of higher fungi, and he points out that the confusion has chiefly arisen from not properly distinguishing the true Saccharomycetes (yeasts with endogenous spore-formation) from the various Blastomycetes devoid of such spore-formation.

Researches on Uredinæ.*—Herr P. Dietel epitomizes the most important additions to our knowledge of this order of Fungi acquired during the last ten years.

Uromyces Cunninghamianus sp. n.†—The late Dr. A. Barclay describes, under this name, a remarkable fungus parasitic on *Jasminum grandiflorum* at Simla. Its peculiarities are mainly three, viz. the production of teleutospores within the peridia; the assumption of a distributive function by the æcidiospores; and the very peculiar germination of the æcidiospores. The second of these peculiarities renders the production of uredospores unnecessary, and accordingly there are none. When the æcidiospore germinates, the germ-tube, which is quickly emitted, soon acquires the appearance of a promycete, as in the case of *Endophyllum*, suggesting an affinity with that genus; but it does not actually assume the character of one, as it never produces sporidia. It produces, on the contrary, sterigmatous branches which directly enter the tissue of the host, and there form another mycele, commencing the life-cycle over again.

Diorchidium.‡—Herr P. Magnus points out that the position of the germ-pores and of the septum in the teleutospores of *Diorchidium* presents no constant distinction from those in *Puccinia*, and that *Diorchidium leve* must, therefore be sunk in the latter genus. To the true genus *Diorchidium* he assigns all those species with two-celled teleutospores, in which the pedicel is inserted parallel to the septum, and the two cells are of similar form, with rounded poles, and with the germ-pores near to the poles. The type-species of the genus is *D. Woodii*, and to it must also be referred *Puccinia lateripes* and *P. insueta*.

Parasite of the Cockchafer.§—MM. E. Prillieux and Delacroix, recurring to this subject, point out that the two species of *Botrytis*, *B. tenella* and *bassiana*, differ in their spores, those of *B. tenella* being oval-oblong, while those of *B. bassiana* are globular, as also in certain special physiological properties. The authors conclude by giving details of the manner in which *B. tenella* can be multiplied, and also the mode in which insects can be infected with the parasite. Besides the cockchafer larva, the following insects have been infected by the authors with the spores of *B. tenella*,—*Rhizotrogus solstitialis*, *Cetonia aurata*, and the larvæ of *Liparis chrysorrhæa*.

* Bot. Centralbl., xlvii. (1891) pp. 15-9.

† Trans. Linn. Soc. Lond. (Bot.) iii. (1891) pp. 141-51 (2 pls.).

‡ Ber. Deutsch. Bot. Gesell., ix. (1891) pp. 187-93 (1 pl.).

§ Comptes Rendus, cxiii. (1891) pp. 158-60. Cf. this Journal, ante, p. 636.

New Genera of Hyphomycetes.*—Mr. R. Thaxter describes the following new genera of Hyphomycetes from North America:—

Helicocephalum. Sterile hyphæ of small diameter, aseptate or rarely septate, creeping over the substratum, and giving rise to highly differentiated erect simple aseptate sporiferous hyphæ, furnished with rhizoid-like attachments at the base, and spirally coiled at the apex; the apical portion becoming septate and constricted at intervals, its segments separating at maturity in the form of large dark-coloured, thick-walled spores. *H. sarcophilum* on carrion.

Gonatorrhodiella. Sterile hyphæ hyaline, creeping, septate and branched; fertile hyphæ erect, sparingly septate, swelling into a spherical terminal sporiferous head, which, after maturity, may become once or twice proliferous; spores formed directly from short processes covering the fertile head, in chains of a definite number, by successive apical budding. *G. parasitica* on *Hypocrea* and *Hypomyces*.

Desmidiospora. Spores of two kinds on the same mycelium of hyaline septate hyphæ; microconidia small, hyaline, subfusiform, produced at the apex of subulate lateral basids; megaconidia very large, terminal, brown, flat, multilocular, several times successively more or less irregularly dichotomously lobed. *D. myrmecophila* on a large ant.

Mucilaginous Slime on Trees.†—Dr. F. Ludwig observed during last spring an extraordinarily copious flow of white or red mucilage from wounds caused by the lopping of branches from birches and horn-beams. The white slime swarmed with bacteria, but was caused chiefly by a new species of *Endomyces*, which he calls *E. vernalis*. The mycelium is much slenderer and less branched than that of *E. Magnusii*. The cause of the red colour, which was comparatively rare, was the presence of filaments of a *Rhodomycetes*, probably a new species, to which he gives the name *R. dendrorhous*.

New Achorion, A. Arloini.‡—Dr. G. P. Busquet describes a fungus, parasitic on a human subject, bearing a resemblance both to *Achorion Schænleini* and to *Trichophyton tonsurans*. Experiments in growing it on various media are described in detail. On liquid nutritive substances it has two mycelial forms, a filamentous and a globular, presenting in this respect analogies both to *Aspergillus* and to *Mucor*. The exogenous non-sexual organs of reproduction are of three kinds,—mycelial spores, conidial structures, and aerial spores, the first two formed only in liquid, the last either in liquid or on solid media.

Protophyta.

a. Schizophyceæ.

Glœochæte.§—Herr L. Reinhard describes the history of development of *Glœochæte Wittrockiana*, which he transfers from the Chroococcales to the Palmellales, placing it near to *Tetraspora*. Each cell is provided with two long bristles, one of which is formed after each

* Bot. Gazette, xvi. (1891) pp. 201-5 (2 pls.).

† Biol. Centralbl., x. (1891) pp. 10-3. Cf. this Journal (1890) p. 368.

‡ Ann. de Micrographie, iii. (1890) pp. 9-21, 62-75, 136-49 (3 pls.).

§ VIII Congress Russ. Naturf. u. Aerzte; Bot., p. 13, 1890. See Bot. Centralbl., xlvii. (1891) p. 107.

process of cell-division. The cells contain small oval chloroplasts; multiplication takes place by means of zoospores, only one of which is formed in each mother-cell.

The Idea of Species in Diatoms.*—M. J. Deby replies to the paper by Dr. J. D. Cox, in which that authority proposes a great reduction in the number of genera and species of diatoms, and points out that the transitory forms of Cox are the same things as the species of those who accept the hypothesis of evolution.

Diatoms of France.†—Messrs. J. Tempère and H. Peragallo have issued thirty-one parts of a series of preparations of the diatoms of France, named by M. Peragallo. Each part contains twelve species.

New Genera of Diatoms.‡—M. J. Brun describes a number of new species of marine, pelagic, and fossil diatoms, from various parts of the world, together with the two following new genera:—*Cotyledon*, distinguished by the valve being more or less circular, and bearing an elevated irregularly folded crest; the position of the genus is at present uncertain. *Hydrosilicon*, characterized by a lamellar, sometimes panduriform, valve, having a pseudo-raphe with simple or double bifurcations towards the extremity of the valve; the margin is thickened and covered by a row of large pearls; the striations have for their centres of radiation axes crossing the raphe.

Under the name *Streptotheca Tamesis*, Mr. W. H. Shrubsole § describes what he regards as a new form of diatom from the estuary of the Thames, where it has appeared every autumn and winter for several years. It has the form of a flattish band, slightly twisted in the direction of its length, so as to form an open spiral. It is extremely delicate and transparent, but is rendered visible by splashes of bright colour. It is almost entirely destitute of silica.

Monograph of Pleurosigma.¶—M. H. Peragallo has published a monograph of the genus *Pleurosigma* and its allies. These latter he classes under three genera, viz. *Rhoicosigma*, *Donkinia*, and *Toxonidea*. The genus *Pleurosigma* properly so-called is divided into eleven groups, viz. *Formosi*, *Speciosi*, *Affines*, *Angulati*, *Rigidi*, *Attenuati*, *Acuminati*, *Strigiles*, *Colletonema*, *Fasciolati*, and *Staurosigma*.

Auliscus.¶—M. J. Deby gives a catalogue of all the known species of *Auliscus*, including *Pseudauliscus*, about 120 in number.

B. Schizomycetes.

Phagocytosis.**—At the International Congress of Hygiene a valuable discussion was held on this subject. Dr. Roux, of the Institut Pasteur, in an introductory address, indicated the scope of the discussion. He began by saying that, in inviting a pupil of M. Pasteur to open the

* Journ. de Microgr., xv. (1891) pp. 112-4. Cf. this Journal, ante, p. 385.

† 'Les Diatomés de France,' Sér. I.-XXXI. Paris, 1890. See Bot. Centralbl., xlvii. (1891) p. 12.

‡ Mém. Soc. Phys. Genève, xxxi. pt. 2 (1891) (48 pp. and 12 pls.).

§ Journ. Quek. Micr. Club, iv. (1891) pp. 259-62 (1 pl.).

¶ Monographie du genre *Pleurosigma* et d. genres alliés, Paris, 1891, 35 pp. and 10 pls.

¶ Journ. de Microgr., xv. (1891) pp. 183-9.

** Nature, xlv. (1891) pp. 419-23.

discussion on this subject, the Organizing Committee had reminded the Section that the great amount of interesting work which had recently been done on the subject had one point in common—namely, the attenuation of virus, and preventive inoculation, the two subjects with which M. Pasteur's name would for all time be honourably associated. With the single notable exception of vaccination, the only way of conferring immunity against any disease was the inoculation of the virus of the disease. To the old dangerous method of producing immunity by inoculation Pasteur had added the less dangerous one of preventive inoculation by means of an attenuated virus, to which he had applied the term vaccination. The designation "attenuated" virus ought to be reserved for virus weakened without being attenuated—for example, by artificially lowering the vitality of the organisms for producing it.

Methods of Attenuation.—Two methods of attenuation had been described by M. Pasteur—namely, the prolonged exposure of a culture to air at a suitable temperature, and the passage of the micro-organisms through the bodies of different species of animals. Other methods had also been employed—for example, the action of heat, the use of antiseptics, of compressed oxygen and light.

In all cases, whatever the method employed, it was found to be necessary that the attenuation should be effected slowly and gradually; rapid attenuation rendered a virus altogether inactive without impressing on it any hereditary weakness. In whatever way the virus was prepared, it must, in order to confer immunity, be brought into direct contact with the tissues of the animal. In the early experiments the virus employed was always living; the living microbe, itself attenuated as to its virulence, was used. Another possible method of conferring immunity was the inoculation of the chemical substances produced by the micro-organisms.

Phagocytosis.—Dr. Roux next dealt with the doctrine of phagocytosis associated with the name of Dr. Metschnikoff. This observer had proved, by the study of the amoeboid movement of certain cells, that they possessed the power of including other cells and bodies in their substance. The phagocyte cells originated in the mesoderm. They possessed, further, the property of being able to digest the bodies which they had ingested. They were, in fact, the only cells which manifested in the human body any intracellular digestion. If the history of a bacterium in the interior of a phagocyte were followed, it would be seen that it underwent a peculiar series of alterations, very different from what took place when a microbe died in cultivating fluids. Whether a virulent virus was introduced into the bodies of animals which resisted inoculation, or whether attenuated microbes were injected into sensitive animals, the greater the degree of refractoriness shown by the animal, the more rapidly the microbes were consumed by the leucocytes. In a non-resistant animal the microbes remained free; no such phenomenon as phagocytosis could be observed. It seemed, therefore, that the phagocytes were charged with the defence of the human organism, and entered into conflict with the parasites which infected the human frame. It might be said that there were diseases in which the microbes were to be met with in the cells specially, and that these microbes nevertheless proved fatal to the animal. In tuberculosis and in leprosy the bacilli were to

be found in the cells, and the results were of the most serious kind, in spite of the intense phagocytosis induced by the microbes of these diseases. This fact proved that the phagocytes and all the other means of defence were, under certain conditions, and at certain times, powerless to effect any good results; they had done their best to take up the microbe, but these had adapted themselves to the interior of the cells, and had conquered. It was not sufficient that the microbes should be eaten up, it was essential that they should also be digested by the phagocytes. Even in those cases where the struggle was going against the human organism, these cells still were the aggressors. It had been frequently observed in tuberculosis and leprosy that the bacilli had been killed in the interior of certain of these cells. The theory asserted that a struggle occurred between the microbes and the cells, but it did not imply that the bacilli always won the day. Phagocytosis only occurred in immune animals; in animals susceptible to the disease it was either not to be observed, or it was incomplete.

He then proceeded to discuss the question whether immunity was the consequence of this power of the cells to digest the virulent microbes. As had been said, the cells of a refractory animal took up the microbes, which, it would appear, under favourable circumstances remained inert in the interior of the cells.

Numerous facts had been alleged to show that the microbes at the time they were taken up by the phagocytes were not degenerated, but were, on the contrary, in a condition of full activity. Thus, to take only one example, it had been found that in frogs the bacilli which had been taken up by the leucocytes remained alive within the protoplasm of the cell; this was apparent from their movements. In lymph taken from the body of a pigeon numerous bacilli were to be seen imprisoned in the leucocytes, and these bacilli could be watched growing, actually under the eye of the observer, within the interior of dead phagocytes; they could be seen to elongate, to push out the protoplasm, distort the form of the cell, and finally to make their escape. Another demonstration of the importance of the action of phagocytes was afforded by the fact that even in immune animals the microbes were found to increase when kept out of the reach of the leucocytes; thus, if a rabbit were inoculated in the anterior chamber of the eye, where there were no cells, the bacteria grew freely, and their development was only checked when the leucocytes had after a time migrated in large numbers, and began to take the microbes into their interior. It thus appeared that phagocytosis was a very general phenomenon, and one which was very efficacious in checking the advance of the organisms; when it failed, the individual succumbed to the virulence of the bacteria. The question remained, What was the mysterious force which attracted the cells towards the microbes? Why were the leucocytes, which in immune animals destroyed the microbes, incapable of seizing upon them in non-immune animals?

In 1883, Metschnikoff propounded his theory of phagocytosis. This theory rested on two assumptions; first, that the cells were attracted to the microbes in virtue of a special sensibility manifested towards all foreign bodies introduced into the tissues; the second was that this power of seizing upon the virulent microbes in immune animals

originated in the habit formed during the earlier struggle with the attenuated virus with which the animal had been previously inoculated. The behaviour of the leucocytes might be more readily explained by assuming that leucocytes had the property, analogous to that possessed by the zoospores of the myxomycetes—namely, that of being attracted by certain bodies and repelled by others. MM. Massart and Bordet had proved that the products of the microbes exerted a very marked chemical action on the phagocytes. When a virus was introduced into the body, it proliferated, and secreted a substance which attracted the leucocytes; the more active the virus, the more energetic were the poisons elaborated by it, and the cells which penetrated to the point of inoculation were paralysed in their action, and rendered incapable of taking up the microbes, which therefore proliferated without hindrance. Further, in certain diseases the virus produced a substance which was still more poisonous. In chicken cholera, for instance, the poison secreted by the microbes repelled the leucocytes from the point of inoculation; it thus came about that phagocytes were never found in this particular affection. This, however, was not the case with animals which had been rendered immune either by inoculation of the attenuated virus, or by the injection of a suitable dose of bacterial products. If the animal were given a strong virus, phagocytes were attracted to the point of inoculation, and these possessed the power of taking up the microbes before they had time to elaborate effective doses of their toxic material. It was, therefore, at the commencement of the disease that the critical struggle took place. If the leucocytes could not accomplish this at the beginning of the malady, their action at a later period would be useless, since the microbes would have produced enough poison to paralyse their activity. Every cause, therefore, that prevented the access of leucocytes to the point of inoculation facilitated infection. The theory of immunity propounded by M. Metschnikoff did not exclude the possibility of there being other means of protecting the organism, but it simply proved that phagocytosis had a wider sphere of action, and was more efficacious, than any other means of protecting the organism. It seemed to explain all the facts, and was, moreover, eminently suggestive. It was in this way that the knowledge of microbic poisons and chemical inoculation had thrown light on what would otherwise have been obscure. Far from being shaken by the theories which were opposed to it, this theory of Metschnikoff's had gained by the opposition which it had met, and that was a guarantee of its soundness.

Dr. Buchner, of Munich, criticized freely Metschnikoff's views. The main objections he brought forward were as follows:—

(1) Many observers failed to notice any destruction of bacilli by phagocytes, when naturally immune animals, such as white rats or pigeons, were inoculated with anthrax.

(2) In diseases ending fatally, such as tuberculosis, mouse-septicæmia, &c., the micro-organisms were frequently found in the interior of phagocytes.

(3) The experiments of Petrushky, Baumgarten, Pekelharing, and others seemed to show that the bacilli of anthrax perished in the living fluids of immune animals even when the bacilli were protected against the attacks of white corpuscles.

Metschnikoff, however, denied this, and proved that the living fluids of immune white rats form a most excellent cultivating medium for the bacilli of anthrax. These observations of Metschnikoff, according to Buchner, might be explained by the fact that Metschnikoff in his experiments introduced more bacilli than could be destroyed by the living fluids of white rats, as a certain quantity of serum was able to destroy only a very small quantity of micro-organisms. Speaking of the experiments made by his pupils Ibener and Roeder, he stated that, when a certain kind of micro-organisms were placed into a given quantity of serum, the micro-organisms might either be destroyed *in toto*, or reproduce themselves in large numbers according to the number of micro-organisms introduced in the first place into the serum. When, instead of placing the micro-organisms directly in contact with the serum, the micro-organisms were wrapped up in sterilized cotton-wool, it was found that the bacilli, so protected against the temporary harmful influence of serum, began to grow luxuriantly at the end of twenty-four hours. The bactericidal power of serum disappeared, therefore, shortly after death.

Massart, Bordet, and Gabritchewsky had previously proved that the emigration of leucocytes to the spot where the virus was introduced was due to the attracting influence (positive chemotaxis) of the chemical poisons secreted by micro-organisms, but he (Buchner) was of opinion that the substances dissolved in the cultures have hardly any action on leucocytes, but that this attracting influence on leucocytes was due to the protein present in bacterial cells themselves. Whereas the products of the metabolism of micro-organisms had little or no attracting influence on the leucocytes, the proteins themselves attracted the cells most powerfully.

As long as the bacterial cells were active and capable of reproducing themselves actively, the proteins were contained in the cells, and these poisons only left the cells when the latter became diseased or old. Hence these proteins were chiefly found in old cultures, the filtered and sterilized extracts of which always possessed a strong attracting influence on leucocytes. Hence it followed that, "The more a given micro-organism is harmfully influenced by the living fluids of a given species of animal, the more proteins will be excreted. This, as a natural consequence, is followed by a corresponding increase in the number of cells which emigrate to the point of inoculation." In every case the living fluids of the body exert a harmful influence on micro-organisms, and then, when in consequence of this the excretion of proteins takes place, the amoeboid cells emigrate to the spot.

Turning now to the characteristics of this germicidal substance present in serum, he thought that its germicidal power gradually disappeared, so that after a few days the serum had no bactericidal power. This germicidal action was destroyed by the micro-organisms themselves, for, unless the latter were completely destroyed, they soon began to grow freely in serum. Serum maintained at 55° C. during half an hour, or at 52° C. during six hours, loses its bactericidal power completely. A moderate degree of warmth (37° C.) intensified the germicidal action of the blood or serum.

Turning now to the question as to whether this bactericidal action of the blood had any share in the production of immunity, he gave

the following facts as proving that there was some connection between the immunity of a given animal against a given infectious disease, and the bactericidal action of its blood on the micro-organism producing the disease:—

(a) The blood and serum of animals, such as mice and guinea-pigs, which readily succumbed to anthrax, had no bactericidal power on anthrax-bacilli.

(b) The serum of animals which took anthrax readily never possessed such a strong bactericidal action as the serum of white rats, which were immune against anthrax.

(c) The blood and serum of animals rendered artificially immune possessed stronger bactericidal powers than the blood and serum of normal animals.

(d) The blood and serum of animals rendered artificially immune against a given micro-organism lessened the virulence of the specific micro-organism causing the disease.

(e) Whenever blood and serum possessed no bactericidal action on micro-organisms, this absence of bactericidal action might be due to the fact that, owing to the necessary manipulations, this bactericidal substance had been altered or even destroyed.

As further proving that the immunity of animals depended on some substance present in the serum, he mentioned the facts described by Behring, Kitasato, Ogata, and Emmerich, in which the injection of blood or serum of an animal immune against a given bacillus, cured another animal afflicted with the same disease. The curative power he attributed to the presence in the blood of immune animals of a protective substance, probably proteid in its nature, to which he gave the name of "alexine" (from ἀλεξεῖν, to protect). These alexines were not ordinary oxidation products of the tissues, as they were quite specific in their action. They were not simply enzymes, as they had no hydrolytic properties, but they were most probably proteid substances. These alexines were probably formed in the cells; but, when formed, their action was quite independent from that of cells, and they were probably always present in immune animals.

Mr. E. H. Hankin said that theoretical considerations led him to suspect that a particular ferment-like proteid, known as cell-globulin B, was a substance possessing bactericidal power. He tested its action on anthrax bacilli, and found that it had the power of destroying these microbes. He further found that similar substances were present, not only in animals that were naturally immune against anthrax, but also in those that were susceptible to this disease. To these substances he had given the name of *defensive proteids*. In his published papers on this subject he had noted various similarities in the bactericidal action of these substances, and that possessed by blood-serum, and these resemblances were such as to leave little room for doubt that the bactericidal action of blood-serum was due to the presence of these defensive proteids.

The serum of white rats contained a proteid body possessing a well-marked alkaline reaction, and a power of destroying anthrax bacilli. Further, when injected into mice along with fully virulent anthrax spores, it would prevent the development of the disease. On the other hand, defensive proteids of animals susceptible to anthrax did not exert such

protective power, and consequently these experiments indicated a difference in the mode of action of defensive proteids of immune and non-immune animals respectively. Further, the amount of defensive proteid present in a rat could be diminished by the causes which were known to be capable of lowering the animal's power of resisting anthrax. For instance, Feser stated that rats become susceptible to anthrax when fed on a vegetarian diet. Mr. Hankin obtained similar results with wild rats. The ordinary white rat he found to be generally refractory to anthrax on any diet, and the defensive proteid could always be obtained from its spleen and blood-serum. This was not the case with wild rats. In one experiment eight wild rats were used; of these, four were fed on bread and meat, the others on plain bread, for about six weeks. Then one rat of each lot was inoculated with anthrax; of these, the one that had been subjected to a bread diet succumbed. The remaining rats were killed, and it was found that while the spleens of the flesh-fed rats contained abundance of the defensive proteid, only traces of this substance could be obtained from the spleens of the rats that had been fed on bread alone. A similar result was obtained in other experiments.

Very young rats were known to be susceptible to anthrax, and so far as could be judged from the litmus test (after dialysis and addition of NaCl), their serum appeared to contain less of the defensive proteid than did that of the adult rat. Further, Mr. Hankin found that a young rat could be preserved from anthrax by an injection of its parent's blood-serum.

These facts appeared to prove that the defensive proteid of the rat deserved its name, in that it preserves the animal from the attack of the anthrax microbe; in other words, that this substance was at any rate a part cause of a rat's immunity against anthrax.

Defensive proteids appeared to be ferment-like, albuminous bodies, and it was extremely unlikely that we should for a considerable time be able to classify them by any other than physiological tests. From this point of view it was possible to divide them into two classes; first, those occurring naturally in normal animals, and secondly, those occurring in animals that have artificially been made immune. For these two classes Mr. Hankin proposed the names of sozins and phylaxins. A "sozin" was a defensive proteid that occurred naturally in a normal animal. They had been found in all animals yet examined, and appear to act on numerous kinds of microbes, or on their products. A "phylaxin" was a defensive proteid which was only found in an animal that had been artificially made immune against a disease, and which (so far as is yet known) only acted on one kind of microbe or on its products.

Each of these classes of defensive proteids could obviously be further subdivided into those that acted on the microbe itself, and those that acted on the poisons it generated. These sub-classes he proposed to denote by adding the prefixes myco- and toxo- to the class name. Thus myco-sozins were defensive proteids occurring in the normal animal, which had the power of acting on various species of microbe. Toxo-sozins were defensive proteids, also occurring in the normal animal, having the power of destroying poisons produced by various microbes. Myco-phylaxins and toxo-phylaxins similarly would denote the two sub-classes of the phylaxin group.

The classification might be represented by the following scheme:—

Defensive proteids (Hankin). Alexins (Buchner).	}	Sozins:—	}	Myco-sozins:—
		Defensive proteids present in the normal animal.		Alkaline globulins from rat (Hankin), destroying anthrax bacillus.
				Toxo-sozins:—
				Of rabbit, destroying the <i>V. Metchnikovi</i> poison (Gamaleia).
		Phylaxins:—		Myco-phylaxins:—
		Defensive proteids present in the animal after it has been made artificially immune.		Of rabbit, destroying pig typhoid bacillus (Emmerich).
				Toxo-phylaxins:—
				Of rabbit, &c., destroying diphtheria and tetanus poisons (Behring and Kitasato, antitoxin of Tizzoni and Cattani).

Prof. Emmerich read a paper on "The Artificial Production of Immunity against Croupous Pneumonia and the Cure of this Disease." He stated that his previous experiments on swine fever had proved that in immune animals the bacilli of swine fever were destroyed, not by the cells of the animal, but by a bactericidal substance present in the blood. It had been clearly proved by his experiments that the bacilli of swine fever were destroyed almost immediately after their introduction under an immune animal's skin. Applying these researches to the disease produced in rabbits by the inoculation of the *Diplococcus pneumoniae* of Fraenkel, he showed that non-immune rabbits died within twenty-four to forty-eight hours after the introduction of the virus. But if such animals had been previously treated with the blood or serum of animals rendered artificially immune against the diplococcus of Fraenkel, such animals did not die, but recovered after the introduction of extremely virulent diplococci. Moreover, when the *Diplococcus pneumoniae* was inoculated into an animal, it was possible to cure it by injecting shortly afterwards some of the serum of an animal rendered artificially immune. In the blood of animals rendered artificially immune against pneumonia we possessed an excellent cure for the disease. Not only would it be possible to cure men afflicted with pneumonia by these injections, but we could, by preventive inoculations applied in time, put a stop to the spread of an epidemic in a school or a prison for instance. His experiments, together with Dr. Doenissen's, had a great practical as well as a theoretical value.

Dr. Ehrlich stated that he had lately made a number of experiments with ricin which threw great light on the question of immunity. According to Kobert and Stillmark, ricin was an extremely poisonous body, for it acted fatally when such small doses as 0.03 mg. were injected into an animal's veins. When absorbed through the alimentary canal, a dose one hundred times larger could be easily tolerated. Nevertheless, even then, it was so toxic that, according to Kobert's reckoning, a dose of 0.18 gr. would prove fatal to a full-grown man. It had a harmful influence on the blood, producing coagulation of the red blood-corpuscles, and thromboses, more especially of the vessels of the alimentary canal.

In his opinion the toxicity of ricin greatly depended on the species of animals used for experiments, the animals most susceptible to its

action being guinea-pigs. Thus, a guinea-pig weighing 385 grammes died eleven days after the inoculation of 0.7 ccm. of a 1 in 150,000 solution of ricin, the *post-mortem* examination showing characteristic hæmorrhages in the alimentary tract. One gramme of this substance might therefore prove fatal to 1,500,000 guinea-pigs. White mice, on the other hand, did not die after much larger doses, and this immunity of mice against this poison might be increased by subcutaneous injections of ricin. The same result might be obtained, however, far more easily and without any chances of failure, by feeding mice with ricin. It was best to begin with small harmless doses, gradually increasing the amount until the organism was accustomed to the poisonous substance. In ten days a mouse might then be inoculated with a deadly or even larger dose without suffering any evil effects. Thus, whilst doses of 1/200,000 gramme were absolutely fatal in normal animals, mice fed daily and in increasing quantities with ricin suffered no harm after the injection of 1/1000 gr. or 1/500 gr., or, occasionally, of 1/250 gr.

Whilst a 0.5 or 1 per cent. solution of ricin applied to the eye of a normal animal produced severe inflammation and panophthalmitis, the application of a 10 per cent. solution of ricin produced no effect on the eye of an animal previously fed with ricin. In other words, this was distinct proof of the existence of a local as well as of a general immunity against the poison. Strangely enough it was almost impossible to render the subcutaneous tissue immune against ricin, and even in exceedingly immune animals the subcutaneous injection of ricin produced distinct necrosis of the subcutaneous tissue.

It was a remarkable fact that this immunity appeared quite suddenly on the sixth day, and then increased slowly, so that on the twenty-first day the animal could stand a dose which was 400 times higher than that fatal to a normal animal.

This immunity against ricin appeared to be permanent, for it was still present in immune mice which had not taken ricin for a period of six months previously.

He had been able to extract from the blood of animals rendered immune against ricin a body which had the power of counteracting the toxic action of ricin, so that a powerful solution of ricin was rendered harmless by admixture with the blood of immune mice. It was also possible to render animals immune against ricin by injecting the blood of immune animals.

Dr. Kitasato, of Tokio, shortly summarized the results which he and Dr. Behring had obtained with the virus of tetanus. According to these observers, the blood of a normal rabbit has no influence on the toxins secreted by the bacillus of tetanus. But when a rabbit had been rendered artificially immune against that disease, its blood had the power of destroying the toxins secreted by the specific bacillus. Nay, more, the blood of rabbits made artificially immune against tetanus with trichloride of iodine, rendered mice not only refractory to tetanus but also cured the disease when already in progress. The blood, however, did not appear to act on the tetanus bacillus itself, but on the toxins secreted by the bacillus.

Dr. Adami thought that it was impossible to doubt that in a large number of infectious diseases the process of phagocytosis was extremely

marked. He was of opinion that it was quite possible to accept both views of the question. The controversy had taken place chiefly as to the phenomena observed in the rat; in that animal phagocytosis was only to be observed with difficulty, and the serum of rat's blood undoubtedly possessed bacteria-killing properties to a high degree.

Dr. Klein stated that frogs and rats were insusceptible to anthrax, but that these animals could be made susceptible to the disease by a variety of means, indicating that their normal power of resistance was due to certain chemical conditions of the blood. If the bacillus of anthrax was introduced into the lymph-sac of a chloroformed frog, this animal always died of anthrax. Rats inoculated with anthrax and kept under the influence of an anæsthetic also died of anthrax. He had been unable to find any evidence to show that in these cases the leucocytes had lost their power of swallowing up bacteria, and therefore the susceptibility of chloroformed animals to anthrax could only be explained by some chemical changes taking place in the serum of the chloroformed rat or frog.

Dr. Metschnikoff said that, of all the objections which have been raised against the theory of phagocytes, doubtless by far the most important was that formulated by Behring and Nissen: namely, the fact that the serum of guinea-pigs vaccinated against the vibrio of Metschnikoff had bactericidal powers on the same vibrio. Whilst the serum of normal guinea-pigs allowed the free development of a large number of these microbes, the serum of vaccinated animals killed the micro-organisms at the end of a few hours. MM. Behring and Nissen were convinced that this fact formed a complete explanation of the acquired immunity of guinea-pigs against the *Vibrio Metchnikoffi*, and that it might serve as a model for a theory of immunity. His own researches, however, proved the contrary. If one studied the phenomena as they occurred in the living animal, one noticed at once that the bacilli inoculated into immune guinea-pigs remained alive for a very long time. Some vibrios were taken into the interior of leucocytes at the point of inoculation, whilst others developed perfectly in the liquid exudation. To show this, one had only to take a drop of the latter, and place it in the warm chamber; the leucocytes perished when taken out of the organism, and allowed the bacilli contained in their interior to develop freely. The vibrios thus multiplied and filled the leucocytes, which swelled and eventually burst, allowing the microbes to pass freely into the liquid part of the exudation. Here the development continued, and one obtained very abundant cultures from the liquid exudation of the immune guinea-pig. If one extracted a small quantity of such a culture, and introduced it into the dead serum of an immune guinea-pig, this serum not only did not kill the bacilli, but also gave a more abundant development than the serum of a non-immune animal could do. The study of the phenomena in living animals made artificially immune against the vibrio of Metschnikoff, instead of overthrowing the theory of phagocytosis, furnished on the contrary an evident proof in its favour. The theories of the attenuation of virus in the bodies of immune animals, and of the neutralization of the toxins, could not be applied to his case, as the vibrios remained very virulent, and because the immune guinea-pigs are as sensitive to the toxin of the bacillus as the non-immune animal.

This example showed yet once more that one must not be content with studying the phenomena of immunity outside the organism. This criticism also applied to M. Buchner's experiments, which he had communicated to this meeting; he insisted on the fact that, in order to assure oneself thoroughly of the bactericidal property of the serum, it was necessary to take a small quantity of the culture, and spread it in a tube filled with serum. If, according to Dr. Buchner, one introduced a little of the culture wrapped in cotton-wool, the serum could no longer exercise its bactericidal power, and the microbe developed freely. Now, when one inoculated the bacillus under the skin of an animal, one introduced at the same time a small mass which did not spread freely in the blood or exudation, but remained localized at one spot. The experiments of M. Buchner, instead of furnishing an objection to the phagocyte theory, rather supported it.

Referring to the curative properties of the serum of white rats against anthrax, he had come to the conclusion that, whereas the living serum of white rats had no bactericidal action on anthrax, the dead serum of the same animals had marked bactericidal powers on the same micro-organism. When a mouse was inoculated with a mixture of the dead serum of a rat and anthrax bacilli, it nearly always died, although the disease lasted somewhat longer than usual. On examination of the point of inoculation it was found that the bacilli of anthrax did not grow quite so readily, and that an enormous number of leucocytes emigrated to the point of inoculation and took the bacilli into their interior and digested them. In tetanus, again, the leucocytes ate up considerable quantities of tetanus-spores and bacilli. Summing up his researches, he stated that whenever an animal recovered from an infectious disease this recovery was accompanied by a process of phagocytosis; whenever an animal died of an infectious disease the process of phagocytosis was absent or insufficient. The theory of phagocytes was strictly based on the principles of evolution as laid down by Darwin and Wallace.

Immunity to Anthrax.*—Dr. J. Sawtschenko's experiments with anthrax were made on pigeons and rats, and entirely with the view of supporting the doctrine of phagocytosis and upsetting the results of Czaplewski, who found that the immunity of pigeons to anthrax was in no way due to phagocytosis. The author's experiments and results are simply confirmatory repetitions of the experiments made by Prof. Metschnikoff and others, who place a very high value on the phagocyte for its power in producing immunity by eating up the parasites. The author, however, admits that complete immunity to anthrax scarcely exists, and that by gradually habituating the bacteria to a new medium, a virus is obtainable capable of killing animals previously immune to anthrax; and also that anthrax bacteria disappear quite independently of phagocytes. The deciding factor in the recovery of an animal is the action of the phagocyte, for that the phagocytes do possess this predominating influence is proved, says the author, from finding them inside the cells in enormous quantities, and very few, if any at all, lying free outside. Within the cells they are demonstrable by ordinary staining methods in varying conditions of degeneration. Yet other

* *Centralbl. f. Bakteriol. u. Parasitenk.*, ix. (1891) pp. 473-7, 493-6, 528-32.

competent observers have failed to find these remains, and the explanation offered is that the tissue has been improperly hardened and imperfectly stained.

Natural Immunity to Anthrax.*—In discussing the vexed question of natural immunity to anthrax, Dr. G. Sanarelli alludes first to the historical aspect of the subject, and then shows how he obtained lymph free from germs and leucocytes. A carefully sterilized glass rod from 5–6 mm. thick was dipped 4–5 times in a 5 per cent. solution of collodion, and then the collodion having dried, the little bag thus formed was closed by putting some more collodion on the opening. With a little dexterity, a large number of these capsules, 3–4 cm. long and holding 1–2 ccm., can be made in a short time. They are transparent, impermeable, and perfectly aseptic. They are filled by introducing them into the dorsal lymph-sac of a healthy frog, and there leaving them for 3–4 days, by which time the collodion capsule becomes filled by transudation. The lymph is then pipetted into suitable glass vessels. With this fluid numerous experiments were made touching the bactericidal qualities of lymph, and the influence of temperature on the germicidal property. These experiments were conducted in the usual manner, and from the results obtained the author concludes that frog's lymph perfectly free from germs and leucocytes does attenuate anthrax, but that such attenuated virus does not acquire vaccinal properties. The germicidal action of lymph is lost if the fluid be heated, but cold appears to possess little or no detrimental influence. On anthrax bacilli frog's lymph exerts a degenerating influence, and this quite independently of any assistance from leucocytes. With regard to phagocytosis the action of the cell-element is not regarded with disfavour, but the author inclines, and rightly, to make immunity depend upon the combined influence of the plasma and cell elements of the blood, rather than on the unaided action of any separate constituent.

Immunization against the Virus of Tetanus.†—Prof. G. Tizzoni and Dr. G. Cattani divided their experiments with the tetanus bacillus into two series. In one they examined into the effect of various chemical substances on the tetanus virus. The only agents which possessed any active influence were carbolic acid, chlorine water, and trichloride of iodine. The first of these was used in 5 per cent. solution, and the iodine trichloride in 2 per cent. solution. All three agents, allowed to act on equal volumes of filtered tetanus cultivations for twenty-four hours, destroyed the toxicity of the virus altogether. But none of these substances, when injected subcutaneously either before or after the inoculation of the virus, was able to prevent the tetanus phenomena.

In the second series the authors made use of animals which they had found to be more or less refractory to the tetanus poison (pigeons and dogs). In fact, the pigeons used by the authors showed only local transitory phenomena, recovering after injection of a moderate quantity of a virulent tetanus cultivation completely in a shorter or longer time. And every succeeding injection produced less and less reaction, until the animals ceased to react altogether. In a similar way dogs may be

* *Centralbl. f. Bakteriol. u. Parasitenk.*, ix. (1891) pp. 467–72, 497–504, 532–9.

† *Tom. cit.*, pp. 189–92.

rendered insensitive to the virus provided the initial dose be very small. By this method they succeeded in rendering two pigeons and one dog refractory, and evolved the following facts:—The blood-serum of the dog when mixed with filtered tetanus cultivation destroyed its toxicity completely, even when the quantity of serum was very small, and the duration of contact very short. Subcutaneous injection of this serum rendered another dog immune to the tetanus virus, and similar results were obtained when white mice were injected. If, however, the dose was very large (1 ccm.), these animals died. Rabbits and guinea-pigs also succumbed under like conditions. The pigeon's blood-serum gave similar results. It is noted that injection of blood-serum after inoculation of the virus failed to prevent the appearance of tetanic symptoms.

Anthrax Vaccination.*—M^lme. O. Metschnikoff, when examining the effect of anthrax vaccines i. and ii. on sheep, found that the bacilli were almost always only at the injection spot, were surrounded by leucocytes, and in a degenerate condition; only a few bacilli being free and of normal appearance. Moreover, the aqueous humour of sheep which had undergone vaccine-fever, did not inhibit the growth of the spores of i. and ii. vaccines, or of virulent anthrax. Consequently it contains no bactericidal matter. Experiments on rabbits gave quite analogous results.

The vaccine-protection is therefore brought about by the products of the bacilli being diffused through the body, and the destruction of the bacteria is effected by phagocytosis.

Protective inoculation doubtless consists in the cellular elements becoming habituated to the toxic products of the bacteria.

Germicidal Substance of the Blood.†—Prof. M. Ogata has isolated from the blood of dogs and fowls a substance which renders immune to anthrax and mouse-septicæmia animals susceptible of those diseases, and the author regards this substance as a ferment contained in the blood of the immune animals. The ferment has the following properties. It is readily soluble in water and glycerin, but insoluble in alcohol and ether. Its efficiency is not impaired by the action of weak alkalies, but is entirely suppressed by carbolic and hydrochloric acids. In the presence of the digestive juices, and if heated up to 45° C., its action is destroyed. The ferment possesses not only immunizing but also disinfecting properties, and mixed with glycerin retains its efficiency for a long time without any notable change. It does not appear to possess the power of converting fibrin into pepton, or starch into sugar.

In addition to the foregoing characters, this substance also possesses the power of inhibiting the growth and development of the cholera and typhoid bacilli, a fact which induces the author to think that the disinfecting action of the blood may be due to this ferment.

The ferment is prepared in the following manner. To one part of blood or blood-serum are added 10–15 parts of a mixture of absolute alcohol and ether (equal parts). After filtration the precipitate is dried (on the

* Ann. de l'Institut Pasteur, 1891, p. 145. See Centralbl. f. Bakteriologie u. Parasitenkunde, ix. (1891) pp. 738–9.

† Centralbl. f. Bakteriologie u. Parasitenkunde, ix. (1891) pp. 597–602. Cf. this Journal, *ante*, p. 237.

filter paper) in the air. The dried mass is then powdered in a mortar, and to it is added lukewarm water, or a mixture of glycerin and water (equal parts) in half the quantity of blood. After standing 3-4 minutes, it is filtered quickly either through linen or cotton-wool. To this last filtrate are added ten times its bulk of a mixture of equal parts of alcohol and ether, and after standing for a day it is filtered, and the precipitate dried. The dried mass is then dissolved in 1/4 part (reckoning from the original bleeding) of water, filtered, then 1/4 part of glycerin added, or a 1/2 part of a mixture of glycerin and water. The latter glycerin extract is just as effective as the first one made from dog's serum and fowl's blood.

Effect of Human Blood and other Body-juices on Pathogenic Microbes.*—Herr R. Stern obtained fresh untainted blood by means of sterilized cupping instruments. The blood was then poured into stoppered glass vessels and therein defibrinated by shaking it up with gravel or glass beads. Portions of 6-8 drops were then distributed into test-tubes by means of a pipette. The blood was inoculated from agar or gelatin cultivations except in the case of anthrax, when the spleen of a mouse dead of anthrax or a microscopically spore-free bouillon cultivation was used. In each experiment a part of the specimen tests was heated before inoculation for half an hour up to 55° or for a short time to 60°. After inoculation the test-tubes were incubated at 37°, and at various intervals of time were poured on agar or gelatin plates.

Experiments were also made with the following fluids,—pleural and peritoneal exudates, and those from hydroceles and blisters.

From his experiments the author draws the following conclusions:—

(1) Human defibrinated blood has the power of killing certain pathogenic bacteria. It acts most strongly on *B. cholerae asiaticæ*, less on *B. typhi abdominalis*, and still less on Friedlaender's *Pneumobacillus*.

(2) The exudates and transudates possess the same property and to the same degree.

(3) The action of the blood and other body-juices appears, in different individuals and even in the same individual at different times, to be liable to not inconsiderable variations in intensity.

(4) The blood in acute infectious diseases (enteric, pneumonia) does not evince, as far as can be judged from experiments, any considerable deviation in germicidal action.

(5) Other pathogenic microbes (*B. anthracis*, *B. diphth.*, *St. pyog. alb.* and *aur.*, and *St. pyog.*), develop freely in the blood either immediately after their entrance or after a preliminary delay.

The germicidal action of human blood and other body-fluids was effectually removed by heating it for half an hour up to 60°.

Antiseptic Value of Anilin Pigments.†—M. Valude finds that violet and yellow pyocyanin are inhibitive of the growth of *Staphylococcus pyogenes aureus* and *Streptococcus pyogenes* in the proportion of 0.35 gm. pyocyanin to the litre.

* Zeitschr. f. Klin. Medicin, xviii., Nos. 1 and 2. See Centralbl. f. Bakteriologie u. Parasitenk., ix. (1891) pp. 132-3.

† Centralbl. f. Bakteriologie u. Parasitenk., ix. (1891) p. 711.

In less quantity a sediment consisting of well-stained cocci is deposited at the bottom of the cultivation medium (bouillon).

Dried on silk threads the micro-organisms were killed by a 1 per cent. solution of violet pyocyanin in from 75-90 minutes.

Yellow pyocyanin took much longer. From these and other experiments the author concludes that anilin pigments included under the designation of pyocyanin possess feeble antiseptic properties, but that they are under certain circumstances more effective, from their penetrative power, than sublimate.

Disinfecting property of Peroxide of Hydrogen.*—Herr Altehoëfer recommends peroxide of hydrogen as a very suitable and effective means for disinfecting potable water from pathogenic germs. For completely destroying the non-pathogenic and pathogenic organisms found in water, the experiments of the author show that the relative concentration should be 1 to 1000, and the influence of the germicide should be allowed to be exerted for 24 hours.

The concentration proposed by the author is not only effective and quite harmless, but is extremely economical.

Attenuation of Bacillus of Tetanus.†—Dr. G. Tizzoni and Dr. G. Cattani describe the alterations in pathogenic power and biological characters which the bacillus of tetanus undergoes after being dried on silk threads, and when cultivated on different nutrient media, and when subjected to diverse environments.

The main characteristics of cultivations of virulent tetanus are that they always liquefy gelatin, always show a decidedly alkaline reaction, emit a very ill odour, and when inoculated in animals, even in small quantity, kill them in 24-36 hours with the well-known symptoms of experimental tetanus. But when much attenuated, these cultivations no longer liquefy gelatin even when left in the thermostat for quite a long time; they do not emit any odour and present a markedly acid reaction.

Such are the main differences between virulent and attenuated cultivations. Numerous other slight differences are described but they are less important than those mentioned. It may be added that the authors believe that the acidity of the attenuated cultivation is a consequence of this condition rather than the cause of the attenuation.

Action of the Constant Current on Pathogenic Micro-organisms.‡—M. R. Verhoogen divides his remarks on the action of the constant current on pathogenic microbes into two categories according as the object is electrolysable or not. If the former, then the action of the current is chemical; if the latter, this action is simply physical.

The treatment of tumours is considered under the section dealing with the chemical action of the current, and herein the statement is made that the positive pole should be chosen when electrolytic dispersion of a tumour is desired.

In the section discussing the physical action of the electric current,

* *Centralbl. f. Bakteriöl. u. Parasitenk.*, viii. (1890) pp. 129-37. See *Bot. Centralbl.*, xlv. (1891) p. 251.

† *Atti R. Accad. dei Lincei*, vii. (1891) pp. 249-57.

‡ *Bull. Soc. Belge Micr.*, xvii. (1891) pp. 168-91.

the sterilization of cultivation media, which is impracticable by means of heat, is the main topic.

Pseudomicrobes of Normal and Pathological Blood.*—Herr Kollman, in alluding to the appearances observable under normal and pathological conditions in human and animal blood, remarks that they are easily mistaken for micro-organisms, and points out that the works of numerous writers, especially those on anæmia and malaria, teem with examples of this confusion.

According to the author, the following are the chief forms the pseudomicrobes may assume:—(1) simple spherical forms measuring 0.5μ or less; (2) large spherical and oval; (3) small and large rodlets; (4) various combinations of the foregoing elements; (5) a peculiar form resembling a dumb-bell.

As a rule, all are mobile, often extremely so, and their movements have very often the appearance of being voluntary.

According to the author these forms are for the most part nothing else than degeneration derivatives of the red discs, while some of them originate from leucocytes, the blood-plates not being concerned in their formation.

Cultivations in fluid media give deceptive appearances, while on solid no development occurs.

Photogenic and Plastic Nutriment of Luminous Bacteria.†—That "photogenic aliment" is intended to apply to the light-giving quality of the nutrient medium is easy to understand, but without a special definition the comprehension of the term "plastic nutriment" would be difficult. When the nutriment is suitable for vegetation and reproduction, its action is not confined to producing merely luminous phenomena, but it gives rise to "auxanogrammes," or fields of increase, characterized by the numberless colonies which lie within the diffusion area of the nutrient substance and developed much more strongly than outside. When this condition exists the aliment is said by Prof. M. W. Beyerinck to be plastic.

Although the author's remarks are scattered over a large area, some of them are interesting, and the practical part may be summarized very shortly. The increase and emission of light by photogenic bacteria was found to be dependent on the association of pepton with certain nitrogenous and non-nitrogenous bodies by which the requisite nitrogen and carbon were obtained; for example, with pepton, asparagin, or glycerin alone there was darkness or no increase, but in combination both light and increase.

This group is called pepton-carbon bacteria. Another group is characterized by the faculty of peptonizing proteids by means of their proteolytic enzyme. This is the pepton group, of which *Photobacteria luminosum et indicum* are examples, while the first group includes *Photobacteria phosphorescens et Pflügeri*.

After discussing the theory of the luminous function at great length, and then its biological significance, the author passes in review the relations of photogenic bacteria and certain enzymes, not the least

* Centralbl. f. Bakteriol. u. Parasitenk., ix. (1891) p. 839.

† Archiv. Néerlandaises Sci. Exact, et Nat., xxiv. (1891) pp. 369-442.

interesting of which is trypsin—the pancreatic ferment. A great number of bacteria secrete this ferment, and of this number are the photogenic pepton-bacteria.

Bacteria found in Beer.*—Herr A. Zeidler isolated from beer which had become cloudy a bacterium having the appearance of *Bacterium termo* and the following characteristics:—In wort-gelatin and also in meat-juice-gelatin, along the inoculation-track dirty yellow granular colonies. After some days the gelatin was liquefied. On beer-wort-agar the track was more yellow; on potato there formed a dirty yellowish-brown overlay. After having been inoculated in beer-wort, on beer, in fermenting wort, and on yeast alone, it was found that it would develop provided that the amount of alcohol did not exceed 3 per cent.; but that in general it was easily overmastered by the yeast and quickly died after alcoholic fermentation was fairly set up.

Experiments were also made with two other bacteria, one of which is apparently identical with *Bacterium aceti*, while the other corresponds with no hitherto described micro-organism. The behaviour of both in cultivation was very similar although there were certain constant specific differences. Their common characteristics were that they acidified beer and set up a viscid, mucoid condition therein.

Pathogenic Bacteria obtained from the mud of the Lake of Geneva.†—M. Lortet isolated from the mud of the Lake of Geneva numerous micro-organisms amongst which were *Staphylococcus pyogenes aureus*, *Streptococcus pyogenes*, *Bacterium coli commune*, and the bacilli of tetanus and typhoid, and it is interesting in this connection to note that the water of that part of the lake from which these microbes were obtained is chemically a very pure water. Like other bodies these minute existences are subject to the law of gravity, sinking through the water to the surface-mud of the lake-bottom, and there preserving their vitality for probably lengthy periods, at a constant temperature of 4·5°.

Bacillus pyogenes fœtidus.‡—Dr. E. Burci isolated from a suppurating hydatid cyst of the liver a micro-organism which, by a series of experimental investigations, he identified as being the *Bacillus pyogenes* of Passet, and he further claims that he has shown this bacillus to be truly pyogenic. After discussing its more important morphological and biological characteristics, the pathogenic properties of this microbe are referred to in detail. In the first place it is shown that it possesses the power of causing the production, locally, of pus, and that the general effects are peritonitis, enteritis, infarction of liver, and slight swelling of the spleen.

The author then proceeds to show the effect of temperature on its virulence, the results from inoculation of the cultivation products, the acidification of the medium, and of variation of the medium.

Bacillus lactis viscosus.§—This bacillus, first discovered by the author, Prof. L. Adametz, in water, is now found to be the exciting cause

* Wochenschr. f. Brauerei, vii. (1890) No. 7. See Bot. Centralbl., xlvi. (1891) pp. 95-7.

† Centralbl. f. Bakteriol. u. Parasitenk., ix. (1891) pp. 709-10.

‡ Ann. de Micrographie, iii. (1891) pp. 401-15.

§ Berliner Landwirthsch. Jahrb., 1891. See Centralbl. f. Bakteriol. u. Parasitenk., ix. (1891) pp. 698-700.

of a morbid condition of milk—a condition characterized by the fluid becoming viscid, stringy and ropy. It forms coccoid rodlets, with thick, refracting, non-staining capsule, and undergoes yeast-like involution forms, with small daughter-cells. When cultivated in milk it measures on the average 1.5μ long and 1.25μ broad, but is somewhat smaller when bred on pepton-gelatin or agar. Spore-formation was not observed. On plate cultivations of glycerin-pepton-gelatin and of agar, the colonies were whitish and round, growing at temperatures from 8° to 20° . No liquefaction of the medium took place.

Besides being able to convert milk into the ropy condition, this microbe seems also capable of preparing the way for the action of the bacillus of lactic acid, and of removing the casein, since this substance cannot be precipitated from old milk cultivations by acidulation and boiling.

The ropy substance is stated to be neither the product of a mucous fermentation nor a decomposition product of the bacillus itself, but to proceed from the sheath of the bacilli, and to be apparently, just as in *B. mesentericus vulgatus*, metamorphosed cellulose.

The author afterwards proceeds to review the list of organisms which are known to have the power of causing milk to become viscid or ropy.

Bacteria-protein and its relation to Inflammation and Suppuration.*

—Herr H. Buchner finds that the decomposition products exert little or no influence on the behaviour of leucocytes.¹

Leucocytes are, however, extremely sensitive to bacteria-protein (Nencki), the subcutaneous injection of a few milligrams of the protein of *Bacillus pyocyaneus* setting up an inflammation which is free from microbes and so to say chemical, and marked by all the chemical phenomena of erysipelatous inflammation.

The pyogenic effect of the proteins of seven kinds of bacteria was examined by the author, who found that those of bacillus of typhoid, of the *Pneumococcus*, and of *Bacillus pyocyaneus* were very potent.

The proteins were obtained by cultivating the bacteria on solid media, digesting the pure cultivation in weak caustic potash (0.1 to 0.5 per cent.) and then precipitating the protein from the filtrate with acetic or hydrochloric acid.

Action of Light on Bacillus of Typhoid Fever.†—Herr Th. Janowski found from experiments made on the bacillus of typhoid that its development was inhibited or prevented by the action of light, and this effect is due to the chemically active rays of the solar spectrum.

The action of diffuse light was first examined by exposing test-tube cultivations to its action, and by controlling the results with similar cultivations kept covered up. Any doubts about increased growth being due to more favourable thermic conditions were experimentally excluded.

In a similar way the action of direct sunlight was tested and it was

* Centralbl. f. Chirurgie, 1890, No. 50. See Centralbl. f. Bakteriologie u. Parasitenkunde, ix. (1891) pp. 666-7.

† Centralbl. f. Bakteriologie u. Parasitenkunde, viii. (1890) pp. 167-72, 193-9, 230-4, 262-6.

found that the development of the micro-organisms was stopped in from 4-10 hours.

In another set of experiments screens were interposed between the cultivations and the light. These screens were composed of bichromate of potash, alum, fuchsin, gentian-violet, &c., in solution.

- ARTHUS, M.—*Sur le ferment glycolytique.* (On the Glycolytic Ferment.)
Mem. Soc. Biol., 1891, pp. 65-71.
- ALMQUIST, ERNST.—*Pemphigus neonatorum*, bacteriologisch und epidemiologisch beleuchtet. (*Pemphigus neonatorum*, considered from the bacteriological and epidemiological points of view.)
Zeitschr. f. Hygiene, X. p. 253.
- FRAENKEL, C., U. R. PFEIFFER.—*Mikrophotographischer Atlas der Bakterienkunde.* (Microphotographic Atlas of Bacteriology.)
Berlin, 1891, Part 11, large 8vo (5 pls.).
- FREUDENREICH, E. DE.—*De l'action bactériode du lait.* (On the Bactericidal Action of Milk.)
Ann. Microgr., 1891, pp. 416-33.
- FÜLLES, P.—*Bakteriologische Untersuchung des Bodens in der Umgebung von Freiburg i. B.* (Bacteriological Examination of the Soil in the Neighbourhood of Freiburg i. B.)
Zeitschr. f. Hygiene, X. (1891) pp. 225-52.
- GASPERINI, G.—*Sopra una nuova specie appartenente al genere Streptothrix* Cohn. (On a new species of *Streptothrix*.)
Pisa.
- HENNINGS, P.—*Der Hausschwamm und die durch ihn und andere Pilze verursachte Zerstörung des Holzes.* (Dry-rot and the Destruction of Wood caused by it and other Fungi.)
Berlin, 1891, 8vo, 41 pp.
- HULL, G. S.—*Ice-cream Poisoning.*
Med. News, 1891, No. 26, pp. 713-6.
- KAYSER, E.—*Contribution à l'étude physiologique des levûres alcooliques du lactose.* (Contribution to the Physiology of the Alcoholic Ferments of Lactose.)
Ann. Inst. Pasteur, 1891, pp. 395-405.
- LINGELSHEIM, — v.—*Experimentelle Untersuchungen über morphologische, culturelle and pathogene Eigenschaften verschiedener Streptococcen.* (Experimental investigation upon the peculiarities in the Morphology, Cultivation, and Pathogenic Effects of various *Streptococci*.)
Zeitschr. f. Hygiene, X. p. 331.
- LORTET, —.—*Microbes pathogènes de la Mer morte.* (Pathogenic Microbes of the Dead Sea.)
Lyon Med., 1891, pp. 431-2.
- MACÉ, E.—*Traité pratique de Bactériologie.* (Practical Treatise on Bacteriology.)
Paris, 1891, 8vo, 200 figs.
- MANNABERG, J.—*Beiträge zur Morphologie und Biologie des Plasmodium malarie tertianæ.* (Contributions to the Morphology and Biology of the *Plasmodium malarie tertianæ*.)
Centrabl. f. Klin. Med., 1891, No. 27.
- MIQUEL, —.—*Manuel pratique d'analyse bactériologique des eaux.* (Practical Manual for the Bacteriological Analysis of Waters.)
Paris, 1891, 18mo.
- MORI, A.—*Di alcuni micromiceti nuovi.* (On some new Micromycetes.)
Atti Soc. Natural. Modena, 1891, p. 78.
- PAPULI, F.—*Sul potere antisettico del salolo.* (On the Antiseptic Power of Salol.)
Revista Clin. e Terap., 1890, p. 449.
- PASQUALE, A.—*Di un nuovo microorganismo piogeno (Diplococcus pyogenes).* (On a new Pyogenic Micro-organism.)
Giorn. Med. d. R. Esercito, Rome, 1890, pp. 1288-1302.
- PERDÉIX, L.—*Sur les fermentations produites par un microbe anaérobie de l'eau.* (On Fermentations produced by an Anaerobic Microbe of Water.)
Ann. Inst. Pasteur, 1891, pp. 287-311.
- PROTOPOPOFF, —.—*Sur la question de la structure des Bactéries.* (On the Structure of Bacteria.)
Ann. Inst. Pasteur, 1891, pp. 332-6.
- PRUDDEN, T. M.—*Studies on the Action of dead Bacteria in the living body.*
New York Med. Journ., 1891, pp. 637-41.
- SALOMONSEN, C. J.—*Technique élémentaire de Bactériologie.* (Elementary Technique of Bacteriology.)
Paris, 1891, 16mo.

- SCHMORL, G.—**Ueber ein pathogenes Fadenbacterium (*Streptothrix cuniculi*).** (On a Pathogenic *Streptothrix*.)
Deutsche Zeitschr. f. Thiermed. u. vergl. Pathologie, XVII. p. 375.
- SCHWEINITZ, E. A. v.—**Some Chemical Products of Bacterial Growth and their Physiological Effects.**
Journ. Amer. Chem. Soc., 1891, p. 61.
- STRAUS, J.—**Sur la morphologie de la cellule bactérienne.** (On the Morphology of the Bacterial Cell.)
Progrès Méd., 1891, Nos. 22, 23, pp. 441-4, 457-60.
- TRAPEZNIKOFF, —.—**Du sort des spores de microbes dans l'organisme animal.** (On the Fate of Spores of Microbes in the Animal Organism.)
Ann. Inst. Pasteur, 1891, pp. 362-94.
- TISSIER, P.—**Le lait considéré comme agent de transport de certaines maladies infectieuses.** (Milk considered as an Agent for the Transport of certain Infectious Diseases.)
Ann. Méd. Scientif. et Prat., 1891, pp. 153-5, 177-9.
- VAUGHAN, VICTOR G.—**Some new Bacterial Poisons; their causal relation to disease, and the changes in our theories suggested by their action.**
Philadelphia Med. News, No. 918, 1890, p. 158.
- " " **The Examination of Drinking-water with special reference to its relation to Typhoid Fever.**
Philadelphia Med. News, No. 909, 1891, p. 641.
- WHEELER, A.—**Our Unseen Foes and how to meet them: plain words on Germs in relation to Disease.**
London, 1891, 12mo, 84 pp.
- WLADIMIROFF, A.—**Osmotische Versuche an lebenden Bakterien.** (Osmotic Experiments on living Bacteria.)
Zeitschr. f. Phys. Chem., VII. (1891) pp. 529-43.



MICROSCOPY.

a. Instruments, Accessories, &c.*

(1) Stands.

A Universal Stand.†—Dr. A. G. Field describes this stand thus:—
 “ Fig. 81 below represents a stand adapted to the wants of the professional or amateur who uses the Microscope and camera. It consists of base A, $14 \times 14 \times 15$ in., to which are secured by dovetail, glue, and screws, two uprights, B B, 5×1 in., one 3 and the other 7 ft. in height. These are precisely perpendicular to base, to bring instruments and objects in line when centered. They are grooved on edges to receive tongues or arms, C C C C, of the secondary base D, and also on the camera-carrier H. The uprights are made firmer by additional pieces extending up 30 in. from the base. The secondary base, 14×14 in., is corner-braced as shown, and is adjustable as to height, being secured in desired position by set-

FIG. 81.

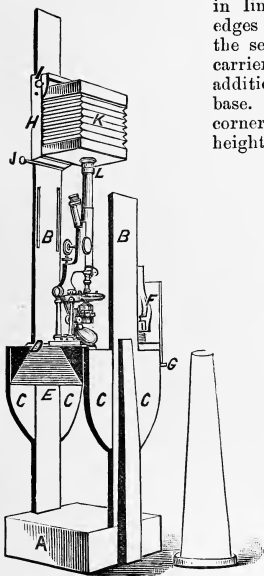
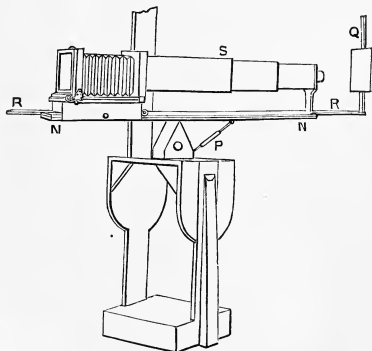

FIG. 82.



screw E. In the centre is a hole, $1\frac{1}{2}$ in. in diameter, which receives the tube of the Microscope when it is placed on the base for high amplification in photomicrography, and also the gudgeon of the support of the base-board O, when used in copying or photography. G is a

* This subdivision contains (1) Stands, (2) Eye-pieces and Objectives; (3) Illuminating and other Apparatus; (4) Photomicrography; (5) Microscopical Optics and Manipulation; (6) Miscellaneous.

† Amer. Mon. Micr. Journ., xii. (1891) pp. 151-2.

lamp-rest which slides on cleats attached to the corner braces, and has an upright for concave reflector when desired. H, sliding carrier for camera, with tongued arms of sufficient width to bring the photographic lens collar precisely over the microscopic tube when centered on either base. I, set-screw to retain it in position, and J, milled head of pinion by which it is racked down to attach camera K to eye-piece of Microscope. This light-tight connection is made with one-half of a child's rubber ball, perforated in centre to fit neck of eye-piece, and of sufficient size to fill the collar of the photographic lens. Fig. 82 illustrates use of the stand in copying enlarging, and reducing, and requires but little explanation. N, N, base-board, 5×1 in., 4 ft. long, grooved on edges to receive tongues on arms of camera-carrier. It is hinged to apex of wedge-shaped block O, the gudgeon of which fits snugly into the hole in centre of supplement base; S, telescopic boxes; R R, slot passing beneath the camera-carrier, with upright for carrying the picture to be copied, the distance respectively between the lens and the picture, and the lens and ground-glass, being regulated by the operator without leaving his position at the focusing screen, so that all copies may be brought to a uniform size, as for lantern slides, without regard to the size of the original. Removing the telescopic boxes and slot, we have a convenient camera stand for inside use, the lateral movements being secured by the gudgeon attachment, and the vertical by the screw brace P. If used ordinarily as a Microscope stand the instruments are always in line and position for photomicrography."

Beck's Bacteriological "Star" Microscope. — This Microscope, which was exhibited at the October meeting, is made in two forms, one with a sliding and the other with a rackwork coarse-adjustment. The fine-adjustment to both forms is that known as the micrometer screw. It is also provided with an inclining joint, a draw-tube, and a swinging double mirror. The special feature of the instrument is the movement of the substage; this is done by a milled head at the right-hand side of the instrument, by the revolution of which the substage is raised or lowered. When it has been moved to its lowest position a further turn of the milled head turns the substage out of position to the right-hand side of the instrument. The substage is fitted with an Abbe condenser and iris diaphragm.

Giant Projection Microscope.*—In the Optical Institute of Franz Poellner, in Munich, an enormous projection Microscope is now being constructed for the "World's Fair" at Chicago. Electricity plays a great rôle in this instrument. In the first place it supplies and regulates the source of light which is mounted in the focus of a parabolic aluminium reflector, and has an intensity of 11,000 candles. By means of an ingenious piece of mechanism, it also maintains the centering of the quadruple condenser and the illuminating system. It also serves to control exactly the distance of the carbon points. For this purpose the arc forms part of a shunt whose intensity is measured by a galvanometer, by the movement of the needle of which the distance of the carbon points can be read to the tenth of a millimetre. The most important innovation, however, is the arrangement for cooling the instru-

* Central-Ztg. f. Optik u. Mechanik, xii. (1891) p. 178.

FIG. 83.

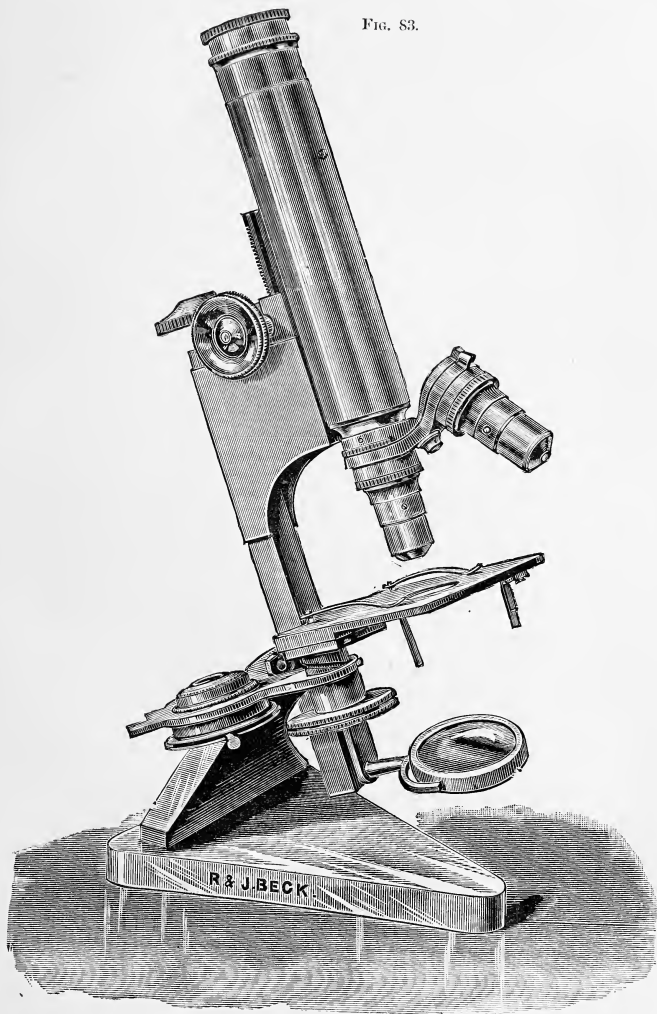

BACTERIOLOGICAL "STAR" MICROSCOPE.

ment. This is absolutely indispensable owing to the intense heat of the source of light (1.43 calories per second). It consists in pouring over the whole Microscope and polariscope a fine spray of liquid carbonic acid. So great is the cooling effect produced that an expenditure of only 0.00078 grm. per second is required. The linear magnification of the instrument is, with ordinary objectives, 11,000, and with oil-immersion lenses, as high as 16,000.

Eustachio Divini's Compound Microscope.*—Sig. P. A. Saccardo describes an ancient Microscope, bearing the inscription "Eustachio Divini in Roma, 1672," which is preserved in the Museo di Fisica, Padua, where, however, nothing further is known as to its history. A Microscope of Divini is fully described in the 'Giornale dei Letterati' i. (1668).† The present instrument is in many respects similar to the one there described. It consists of four tubes of cardboard covered with parchment coloured green and gilded. These slide with friction one within the other, and each has marked upon it in gold the points of different extension (I., II., III., IV.). The largest tube has a diameter of 8 cm. When all the tubes are closed up as much as possible, the total length from eye-piece to objective is 36.5 cm. When all are drawn out as far as the marks I., II., III., and IV., the total length is 41, 49, 54, and 56.5 cm. respectively. The lowest tube carries on its lower half a broad projecting spiral band of cardboard covered with parchment, which gears into a corresponding spiral cut into the cardboard cylinder round which is the brass band bearing the inscription. This band is supported by three divergent feet of brass 15 cm. long. The objective, consisting of a biconvex lens 8 mm. in diameter and 2 mm. thick at the centre, is fitted by means of a screw cap into a brass tube 5.5 cm. long and 2.5 cm. in external diameter. On a screw-thread round this tube moves another tube, in the lower part of which, through two side slits, passes the object-holder, which is kept firm by a spring. The object is focused by raising or lowering this tube on the screw-thread.

The eye-piece is formed of a large somewhat yellow biconvex lens 6 cm. in diameter and 5 mm. thick. It is inclosed in two wooden rings into which the first tube of the Microscope enters. Thus the special eye-piece system of Divini, which consisted of two plano-convex lenses, is wanting. In all probability these have been lost, in which case the lens just described should be regarded as the field lens.

Invention of the Compound Microscope.‡—Sig. P. A. Saccardo publishes several of the documents bearing on the claims of Janssen, Galileo, and Drebbel. Criticizing these he comes to the following conclusions:—The testimony of P. Borel in favour of Janssen has no documentary value. The documents published by Govi show that the first inventor of the compound Microscope (with concave ocular and direct vision) was Galileo in 1610. The documents published by Rezzi, which are in harmony with the testimony of Gassendi and Huygens, show that Cornelius Drebbel was the reformer of the Galilean Microscope, or was in 1620 or 1621 the inventor of the Keplerian compound

* Atti R. Istit. Veneto Sci., II. vii. (1891) pp. 817-27.

† See Dallinger's Carpenter, p. 131. ‡ Malpighia, v. (1891) pp. 40-61.

FIG. 84.



FIG. 85.

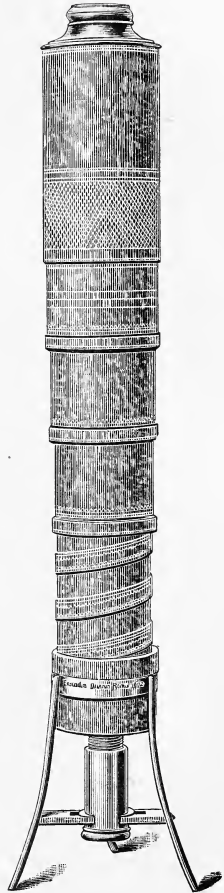

DIVINI'S COMPOUND MICROSCOPE.

Microscope with all the lenses convex and with reversed vision. The name *microscopio* was invented in Rome in 1625 by Giovanni Faber, a physician of S. Santita.

(3) Illuminating and other Apparatus.

New Polarizer.*—Prof. S. P. Thompson read, at the British Association, a paper on “A new Form of Polarizer.” He explained that owing to the great dearth of Iceland spar large Nicol prisms could not be obtained, and he therefore thought it expedient to devise some means of producing polarized light without its aid. The method proposed consists in reflecting the light from a black glass mirror, whose surface is covered with a plate of clear glass. In this way less light is lost than if black glass alone were used. The light from the lantern is reflected on the mirror by means of a total reflecting prism. After being polarized it is again turned back into its original axis by a second reflecting prism. This latter prism, however, must be very carefully annealed in order that the light may remain plane polarized.

Microscope Mirror for Illumination by Reflected Light.†—Herr Gustav Selle has devised an ingenious method of illuminating the object. Immediately above the objective system is a concave mirror,

FIG. 86.

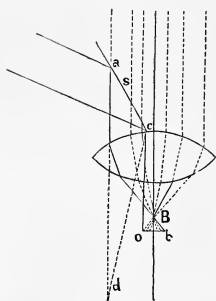

which reflects the rays incident upon it through an aperture in the side of the case of the objective in such a way that the external rays of the reflected cone *acd* (fig. 86), by passage through the objective, are refracted through the focus *B* to the further edge of the object *b*, while the inner rays are refracted parallel to the axis of the Microscope to the near side *o*.

Electro-Microscope Slide for Testing the Antiseptic Power of Electricity.‡—Dr. R. L. Watkins writes:—“Fig. 87 represents an instrument that I have devised for the purpose of ascertaining whether or not electricity will destroy the life of germs. It is the result of a number of experiments to confirm a belief I have long held, that electricity is an antiseptic and disinfectant. I also

learned, while experimenting, that Apostrali had made the same claim.

The instrument consists of a glass slide, in the centre of which is a sunk cell. Two grooves, each $\frac{3}{4}$ in. long, run from this cell outward. Two brass pieces are fitted over the extremities of the slide in such a manner that the rounded points, the under surfaces of which are lined with platinum, will cover a portion of the grooves. These rounded points do not touch the glass, but are raised above the grooves about

* English Mechanic, liv. (1891) p. 36.

† Central-Ztg. f. Optik u. Mechanik, xii. (1891) p. 239.

‡ Amer. Mon. Micr. Journ., xii. (1891) p. 204.

1/8 in. Binding posts are riveted to the brass for connection with a battery.

In order to apply this instrument, a sufficient quantity of the fluid containing the bacteria should be used to fill the cell and grooves. A cover-glass is placed over the cell and its contents. Two small clean sponges, saturated with either the fluid or distilled water, are then placed

FIG. 87.

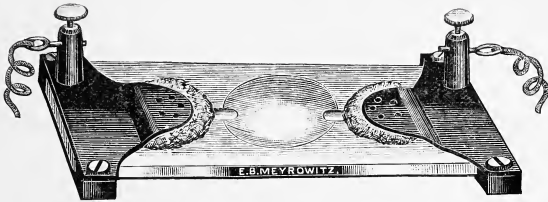

underneath the platinum points and in contact with the fluid in the grooves. The bacteria are now ready for observation, the electricity is turned on, and the quantity noted by the milli-ampere meter to stop all sign of germ life. They can now be cultivated on gelatin in the ordinary way should it be desired to determine whether or not their vitality has been entirely destroyed.

Other uses for the slide will readily occur to one working in this field: for example, the effect of electricity on the blood and different tissues.

I have found this instrument very satisfactory, not only as an easy, but as a quick way of finding out the amount of electricity required to destroy micro-organisms."

New Apparatus for drawing Low Magnifications.* — Dr. L. Edinger has devised a simple form of apparatus for drawing low magnifications (fig. 88), in which the image is projected directly upon the paper and a perfectly free movement is given to the object which lies horizontally on a stage.

The apparatus has the following construction. On a polished wooden base, which serves as drawing board, rises a wooden upright which supports a horizontal tube, closed in front by a condensing lens and behind by a mirror set at 45°. The rays of a lamp are concentrated by the lens upon the mirror. Through an opening beneath the mirror the light falls downwards upon an object-stage which is adjustable in height. Beneath the object-stage is a lens, supported in an adjustable holder, which produces on the base-plate an objective image of preparations which are placed on the object-stage. According to the adjustment of lens and drawing-board it is possible to take magnifications from 2 to 20. The apparatus, however, is supplied with three lenses,

* Zeitschr. f. Wiss. Mikr., viii. (1891) pp. 179-81.

since it is not advisable to produce all gradations of magnification by displacement alone.

FIG. 88.

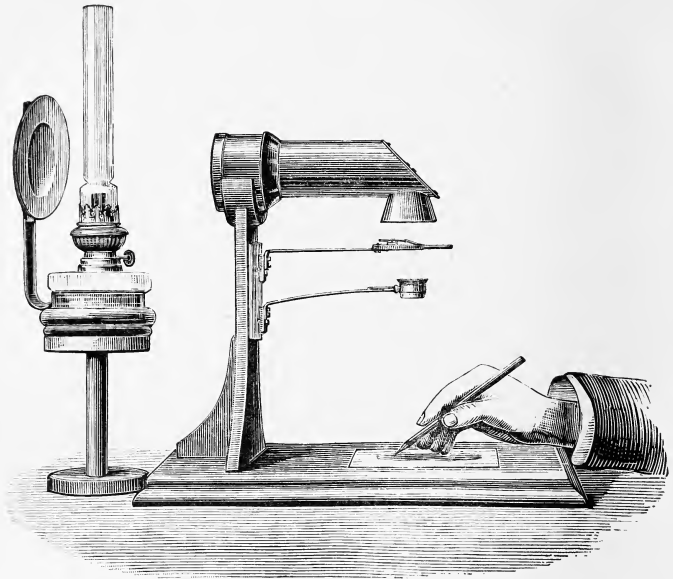

Glasses for keeping Immersion Oil.*—Dr. W. Behrens describes a convenient bottle for keeping immersion oil, which has been made by the firm of Zeiss. It is of cylindrical form, 60 mm. in height and 30 mm. in diameter. It has a wide neck with a clear diameter of 15 mm., and holds 20 ccm. of liquid. Above the ground neck fits a cap, to the centre of which is attached a cylindrical solid glass rod reaching nearly to the bottom of the bottle. This rod has at its upper end a glass hemisphere which is cemented by shellac into a corresponding hole in the glass cap. It is 60 mm. long and 1.5 mm. in diameter. At its lower end it is not simply swollen, but is terminated by a small glass ball of 2 mm. diameter, which prevents the oil from dropping off.

(4) Photomicrography.

Magnesium Flash-Light in Photomicrography.†—Dr. R. Neuhaus gives an account of different flash-lights which have been made use of for photomicrographical purposes. By mixing different powders it is

* Zeitschr. f. Wiss. Mikr., viii. (1891) pp. 184-5. † Tom. cit., pp. 181-4.

possible to insure the presence of rays near the red end of the spectrum which are serviceable in taking coloured preparations. Newcomb was amongst the first to undertake experiments of this kind. He mixed 1 part of magnesium powder with 5-7 parts of pure nitrate of soda, and obtained thus an intensely yellow light. Röhmann and Galewsky made many experiments with a number of different mixtures and obtained good results with the following receipt:—Mixture A. Magnesium, finely powdered, 9·6 grm.; potassium perchlorate, free from water, 13·8 grm. Mixture B. Barium tartrate, free from water, 5·7 grm.; potassium perchlorate, free from water, 2·7 grm. 10 parts of A mixed with 1 part of B and 0·5 grm. of salt, free from water, added. From 1 to 3 grm. of this powder are used. Röhmann and Galewsky also recommended other mixtures, in one of which acetate of copper was employed.

As the result of a number of spectrographic investigations, the author comes to the conclusion that all complicated mixtures of salts of barium, copper, &c., such as these, must give place to the so-called smokeless flash-powder of Gaedicke. This powder consists of a mixture of magnesium and permanganate of potash which burns quickly, giving an intense light with little smoke. If the flash-light is taken with the spectrograph on an ordinary plate, not the slightest effect is shown in the red, yellow, and green, but some bright lines are produced on the border between the green and blue, joining on to the bright zone in the blue and violet. The effect is quite different on the erythrosin plate. In this case the bright zone begins already in the yellow by the Fraunhofer line D. In the centre between the lines D and E the silver deposit on the negative is very thick, and gives the impression that here there was more light effective than in the whole of the blue and violet together. Between the lines E and F the light effect gradually diminishes. In the blue and violet the effect is the same as on the ordinary plate. By using the erythrosin plate and interposing the yellow-green Zettnow filter, the blue and violet light is completely absorbed, and there remains only the strong maximum in the yellow-green between the lines D and E. These are exactly the relations which are wanted in photomicrography, and as they are found in sunlight. The maxima and minima of the light effect of this flash-light are distributed on the erythrosin plate exactly as with sunlight, only the maximum in the yellow-green is much more intense.

Coloured Photomicrograms * — MM. Lumière, of Lyon, are the authors of a process for mechanically colouring photomicrograms. The best results have been obtained by the following methods. A carbon paper poor in colouring matter is chosen and sensitized in a solution of bichromate of potassium containing—water, 650 grm.; bichromate of potassium, 25 grm.; alcohol, 350 grm. After five minutes' immersion the paper is dried and then exposed in the press. The duration of impression is determined by means of a photometer. The image is then developed on a thin ground glass by the usual methods. The positive is washed in cold water, immersed in alcohol for ten minutes, and finally dried. If properly done the proof is faint, sometimes scarcely visible. In order to colour it, solutions of the colours used in micrography, such

* Bull. Soc. Belg. Micr., xvii. (1891) pp. 121-6.

as methyl-violet and blue, &c., are prepared. The concentration which appears to be most suitable varies between 1/100 and 1/500 according to the solubility and the colouring power of the substance. When insoluble in water the colour is dissolved in as small a quantity of alcohol as possible, and the solution is then diluted with water.

The colouring solution is poured over the positive. After a few seconds the liquid penetrates the gelatin, which retains the colour. If the coloration is too intense, the proof is washed with water. The decoloration is in this way generally effected slowly and regularly, and the washing is continued until the right tint is obtained.

When the decoloration by water is not sufficient, alcohol is used. It is then much more rapid, so that the operation must be conducted with more care. The final washing is in all cases with ordinary water.

To obtain a double coloration, as for example in the case of a microbe coloured red on a blue ground, the positive is first treated with a very intense colour. In the case of the microbe a 1 per cent. solution of magenta-red would be used. The proof is thus coloured in all its parts, the microbe deep red and the ground light red. A partial decoloration, first with water and afterwards if necessary with alcohol, is then effected. When the ground begins to lose its tint the proof is treated with the colour required for the ground. A weak solution, such as the aqueous 0.2 per cent. solution of cotton-blue, is used. For projection, it is necessary to varnish in order to get rid of the grained appearance of the surface. The projected images are then much more brilliant.

(5) Microscopical Optics and Manipulation.

Probable Limits to the Capacity of the Microscope.*—Dr. S. Czapski discusses the question of the limits to the resolving power of the Microscope. So long ago as the beginning of the century it was recognized that increased magnification was not the only thing necessary to render the details of a microscopic object clearly visible. With the same magnifying power, the same perfection in the correction for aberration, &c., and with the same method of illumination, systems having the larger angular aperture always showed superiority in definition and resolving power. The explanation of this "specific function of the angular aperture" came almost simultaneously from Abbe and Helmholtz. The theory of Helmholtz supposes the object to be self-luminous, so that it has not so direct a bearing as that of Abbe upon the ordinary Microscopic practice, in which the preparation is illuminated by reflected or transmitted light. However, the two theories, although thus divergent in their points of departure and in most of their consequences, lead in one point almost to the same result. With central illumination—i. e., according to Helmholtz, when the pencils of rays from the luminous points of the object occupy the whole aperture of the Microscope; or, according to Abbe, when the object is met directly only by one small axial pencil—the resolving power according to both theories is determined by the same formula. This formula shows upon what factors and

* Zeitschr. f. Wiss. Mikr., viii. (1891) pp. 145-55.

in what way upon these, the resolving power of the Microscope depends. The deduction, thus made, that the resolving power does depend upon certain factors, leads at once to the consideration of a limiting value for it. Naturally, inquiries of this kind, as to how far we can hope to advance, have only a relative value, and can necessarily be only considered from the point of view of our present resources.

The fundamental formula for the capacity of the Microscope given by both the theory of Abbe and that of Helmholtz for central illumination is

$$\delta = \frac{\lambda}{a}$$

where δ denotes the smallest distance of the elements of a regular structure which can be distinguished by an optically perfect objective, λ the wave-length of the effective light (in vacuo), and a the aperture of the system. This equation shows that δ , the smallness of which is a measure of the capacity of the Microscope, can be diminished in two, and in only two, ways. We can either (1) increase a , or (2) diminish λ .

Since the work of Abbe and Helmholtz, increase in the magnitude of a , i. e. of the aperture, has been the great aim of all opticians who have attempted the improvement of the Microscope. Now $a = n \sin u$ where n denotes the refractive index of the medium in front of the first lens of the system, and u the angle made with the axis by the extreme ray from a central point of the object which can traverse the system. On purely geometrical grounds this angle u cannot exceed 65° , in order that a certain, even though very small, space may intervene between object and system (for the cover-glass and room for adjustment). Thus the value of $\sin u$ can scarcely exceed 0.95. When, as is generally the case, this geometrical limit has been reached, the aperture can only be increased by raising the value of n the refractive index of the medium in front of the objective. We are thus led to the principle of immersion systems. With respect to these it must be borne in mind that it is not sufficient simply to interpose between object and objective an "immersion liquid" of high refractive index: it is also essential that no medium shall be present between object and immersion liquid, even in the microscopically thinnest layer, whose refractive index is less than that of the immersion liquid. Otherwise, however high may be the refractive index of the latter, the aperture of the system will be reduced by total reflection to the magnitude $a' = n'$, if n' is the lowest refractive index of any layer occurring between object and immersion liquid.* Now for most preparations we are compelled to use cover-glasses. Those usually employed, which can be easily made and are consequently moderate in price, have refractive indices of 1.52 to 1.53. The limit of aperture to be attained by the use of such glasses is therefore only about 1.44 to 1.45. To obtain higher apertures, cover-glasses of high refractive indices must be used, and here many difficulties are met with.

The firm of Schott and Genossen have prepared glasses having refractive indices as high as 2.0. But cover-glasses made of such glass are very costly owing to the loss of material involved in their construction, since they have to be ground down to the required thickness of

* See this Journal, 1890, p. 11.

0.15 to 0.2 mm. from thicker blocks. The use of these cover-glasses also raises another difficulty, for, as above stated, no medium must intervene between object and objective with a lower refractive index than the number of the aperture, so that the object must be mounted in a medium whose refractive index has the required height. We do possess mounting media with refractive indices above 2.0; but the use of such media and the preparation of objects with them have their inconvenient side.

They consist chiefly of arsenic and phosphorus compounds which are liable to give off poisonous vapours or to explode during the preparation of the object. Experiments with the system of aperture 1.60 made with such mounting media have also shown that they are apt to attack the cover-glass so that the surface becomes rough and loses its transparency. Better results, no doubt, would have been obtained by the use of a different kind of glass, but in any case it is certain that the cover-glass of high refractive index will be more sensitive than the ordinary cover-glass, so that the choice of suitable mounting media will be considerably more limited than formerly. Altogether, then, the preparation of objects for these high apertures will be a much more difficult and costly process than with the apertures at present in use.

Another difficulty arises when the object is of organic nature and is attacked by these highly refractive mounting media. A large class also of organic bodies requires to be placed in special media as like their natural surroundings as possible. Such media have refractive indices from 1.33 to 1.6 at the highest. This circumstance therefore sets a limit for such substances to any extension of the aperture, and in this case recourse must be had to the second method for increasing the capacity of the Microscope, which consists in diminishing λ , the wave-length of the effective light.

Now the absolute energy of the sun's rays is different in different parts of the spectrum, and the sensitiveness of the eye varies for the different colours. The strength of impression of white daylight on the eye is therefore represented by a curve. The maximum point of this curve lies at $\lambda = 0.55 \mu$, so that from waves of this wave-length and those near to it the eye will receive by far the strongest impression, so much so that the partial images corresponding to the smaller and larger wave-lengths will be to a great extent rendered ineffective. But if these more energetic rays of wave-length 0.55μ and those of greater wave-length be in any way excluded, and only rays of shorter wave-length admitted to the eye, then, under favourable circumstances—i. e. with a sufficiently intense source of light—the light of these short waves can be made to a certain extent effective. Thus it is well known what an astonishing increase there is in the resolving power of an objective when, either by the use of monochromatic light, or by the interposition of absorption glasses, a preparation is observed under pure blue illumination. Often a preparation which with ordinary illumination is beyond the limits of resolution, with monochromatic blue light, with the same objective, and under otherwise exactly the same conditions, is clearly resolved. In fact, the eye is sufficiently sensitive for the wave-length 0.44μ to receive quite an intense impression when other light is excluded. A diminution of the effective wave-length from 0.55 to 0.44μ , however,

is equivalent to an increase of the aperture, e. g. from 1.40 to 1.75, so that here we have a very considerable advance by very simple means.

Photography, as was first shown by Helmholtz, affords a means by which the capacity of the Microscope may be increased. The result, however, has not always corresponded to the theory. An important point indispensable for practical success has been often overlooked. It is in all theoretical deductions tacitly or even expressly assumed that the objective used for the photograph will give with the rays of shorter wave-length equally good images as with ordinary white light. This is, however, by no means the case. In fact, with the objectives of the ordinary type, such as alone existed a few years ago, such a result could not be attained. If the objective gave good images, i. e. was corrected for light of the wave-length 0.55μ , the images from light of wave-length 0.44μ were so bad as to annul the theoretical advantage of the increased resolving power. The method employed to obviate this difficulty was not very successful. It consisted in spherically correcting for rays of that wave-length, e. g. $\lambda = 0.44$, which was most effective in the photographic process, and in effecting the chromatic correction so that the image corresponding to the wave-length 0.55 should coincide with the photographically effective image. Thus the latter could be correctly adjusted by the naked eye, but the defects remained that (1) the optically effective image was in itself bad (spherically under- and chromatically over-corrected, and (2) in the photo-chemically effective parts of the spectrum the concentration of the light was very incomplete, so that owing to the under-correction of this part of the spectrum there was danger of one part obscuring the image produced by the other.

The apochromatics have rendered the greatest service in this direction. In fact the advantage of their use in photomicrography is even more pronounced than their recognized superiority in ordinary microscopic work. This is due to the fact that with these objectives the images corresponding to the different wave-lengths right up to the violet are practically coincident in position and magnitude. Since their introduction cases have continually multiplied in which structures have been made visible by photography which could not be resolved by other means. But even with the apochromatic the conditions have not always been kept upon which an advance in the capacity of the objective depends. The author considers that such an advance by means of photography depends upon the following conditions:—

The system employed should be suitably corrected, so that the images resulting from the short wave-lengths may be sharply defined and coincident in position with that which affects the eye. The second condition is that the light of the required short wave-length should be photographically effective. This requires that (1) the source of light must emit waves of the required shortness, and these with sufficient intensity; (2) the rays corresponding to the larger wave-lengths must be excluded in such a way that the intensity of the short-wave rays shall not be too much reduced; (3) the photographic plate must be sufficiently sensitive for the light of the required wave-length; (4) all media between source of light and photographic plate must transmit the rays of the required short wave-length. This last requirement draws the limits to the

possible advance narrowest. The ordinary glasses, it is well known, only transmit a very small pencil of light of wave-length 0.3μ . It appears, therefore, that the use of light of wave-length 0.35μ is almost the extreme point which we can hope to reach without increasing the difficulties of the work beyond measure. The use of the wave-length 0.35μ instead of the mean wave-length of ordinary daylight, $\lambda = 0.55$, would be equivalent to a raising of the aperture from e. g. 1.40 to 2.20 , while the use of the wave-length 0.30μ would raise it to 2.57 . Under these circumstances, by central illumination, structures would be resolved which contained in the length of a millimetre, in the first case 4000 elements and in the second 4667 (distance apart of elements 0.25μ and 0.21μ respectively), while the corresponding numbers now with aperture 1.40 and white illumination are 2545 and 0.39μ .

Measurement of Lenses.*—Prof. S. P. Thompson, F.R.S., read, at the British Association, a paper on “Some points connected with the Measurement of Lenses.” He said that although lenses were used in so many departments of practical optical work—as, for example, in the making of telescopes, Microscopes, spectacles, and cameras—yet there is no uniform system of describing the properties of a lens. Moreover, all the text-books of the subject refer only to the particular case of thin lenses. He showed how all the properties of a lens could be indicated by specifying the position of four points, the two focal points and the two so-called “Gauss points,” where the principal planes of the lens intersect the axis of it. No method has previously been given for the accurate determination of the Gauss points, and Prof. Thompson described an apparatus by means of which he can do this in the case of any lens or combination of lenses. The theory of the apparatus was also explained in detail. The testing of lenses having become a matter of importance in photography, the Kew Observatory has recently instituted a special department for the purpose; but it was not proposed to guarantee any great accuracy (say, within a quarter of an inch or so) in the measured focal lengths. Prof. Thompson hopes that the committee of the British Association, which he has been instrumental in establishing, will communicate with the authorities of the Kew Observatory, and induce them to carry their measurements to a greater degree of accuracy than they have previously contemplated.

Photographic Optics.†—Mr. A. Caplatzi writes, “There has just appeared under this title a work by Dr. Hugo Schroeder, which will be welcomed by practical opticians and amateurs alike. The latter will find in it an ample reply to the many requests for information addressed to these columns, and the former a practical treatise forming a reliable guide in their lucrative business of photo lens-making. In this royal octavo of some 200 pages a hard blow has been dealt to rule-of-thumb work. Those who will carefully peruse it need no longer work in darkness and uncertainty, but can do it in broad daylight and full conviction that every step forward will bring them one degree nearer to a successful result. And those students who have hitherto derived their optical knowledge from the meagre contents of text-books only, will be surprised at the number of further considerations requiring attention before a

* English Mechanic, liv. (1891) p. 36.

† Tom. cit., p. 18.

practical plan for the construction of photo lenses can be laid down, and they cannot fail to admire the skill and patience that has given us the good lenses we possess, without clearly understanding the numerous conditions they must satisfy. Though the work deals mainly with the construction of photo lenses, it will prove itself as useful for the combination of any other kind of lenses, as the formation of images and the correction of chromatic and spherical aberrations, astigmatism, and diaphragms have been masterly treated. Actinism, of course, need not be taken into account in telescopic and microscopic lenses.

The work is preceded by a valuable list of the principal optical works that have appeared since Newton in English, French, German, and Italian, including fragmentary dissertations contributed to the learned societies, with annotations by the author. Whilst it numbers some 200 works on general optics, only six or seven refer specially to photography. First among these are Petzval's, published in 1843, 1857, and 1858. Dr. H. Zinken, Voightlaender's son-in-law; Dr. Lorenzo Billotti, Schiaparelli's assistant at Milan; and Prof. Seidel, Steinheil's friend, at Munich, also contributed considerably to the perfection of photographic optics. Still, nothing complete and easily understood appeared until the work under notice was called forth by Prof. W. Vogel in Berlin to form a supplement to his new 'Handbook of Photography.'

It is unfortunate that most of this valuable information is in German. The present complete treatise, however, will no doubt soon also appear in an English dress. Meanwhile I shall be pleased to help those who may desire to know something more of the practical rules and formulæ developed by the author, if the editor will afford me space. Dr. Hugo Schroeder possesses the rare advantage of being a linguist and practical optician, as well as a mathematician, and this advantage enabled him to simplify much that was hitherto obscure, and to bring together information that was scattered about in many inaccessible writings. He dissects all the lenses in actual use, and shows on what principles they have been constructed, and how they can be still further improved."

(6) Miscellaneous.

New Edition of Carpenter on the Microscope.*—We are glad to be able to call attention to the new (seventh) edition of the late Dr. Carpenter's well-known work on the Microscope. Dr. Dallinger has been engaged on this work for a considerable time, and has devoted much attention to it. When the last edition of this work was published the new era in microscopical optics had just opened; now, ten years later, it is necessary to give a full account of the work of Prof. Abbe. The consequence is that Dr. Dallinger has had to completely rewrite the first seven chapters. These, he tells us, "represent the experience of a lifetime, confirmed and aided by the advice and practical help of some of the most experienced men in the world, and they may be read by any one familiar with the use of algebraic symbols and the

* 'The Microscope and its Revelations,' by the late W. B. Carpenter. 7th ed., in which the first seven chapters have been entirely rewritten and the text throughout reconstructed, enlarged and revised by the Rev. W. H. Dallinger, LL.D., F.R.S., &c. xviii. and 1099 pp., 21 pls., and 800 wood engravings. London, 1891.

practice of the rule of three. They are not in any sense abstruse, and they are everywhere practical."

The second chapter deals with the Principles and Theory of Vision with the Compound Microscope, and of it Prof. Abbe, who saw the proofs, says, "I find the whole . . . much more adequate to the purposes of the book than I should have been able to write it. . . . I feel the greatest satisfaction in seeing my views represented in this book so intensively and extensively."

Dr. Dallinger has not shrunk from calling to his aid a number of specialists, among whom we may mention Mr. Crisp, the late Mr. Mayall, Mr. E. M. Nelson, Mr. W. T. Suffolk, and Dr. Sorby. Many sections of the book have been rewritten, nineteen new plates have been prepared, as well as 300 additional woodcuts, for many of which the editor returns his thanks to the officers of the Society.

Death of Mr. Walter H. Bulloch.—We regret to hear of the death, on Friday, November 6th, of Mr. Walter Hutchison Bulloch, the well-known optician of Chicago. The deceased was a prominent member of the Chicago Academy of Sciences and the local Microscopical Society. He joined the Royal Microscopical Society in 1882.

Universal Microscopic Exhibition at Antwerp.*—The following particulars are obtained from the 'Chemiker Zeitung':—

The "Exposition de Microscopie Générale, de Produits Végétaux et d'Horticulture" has just come to an end. It was projected by Dr. Henri van Heurck, Director of the Antwerp Botanical Garden, a microscopist of reputation. The plan of the promoters allowed of a strange mixture of products. Thus, along with brewed drinks, "schnaps" of all kinds (i. e. inferior liquors), were to be found pianos, mineral oils, guano, and other manures.

J. D. Möller, of Wedel, in Holstein, exhibited a collection of diatoms, including not fewer than 4026 distinct forms. Not only photographs of these species were on view, but the original specimens could be examined under a number of Microscopes.

The firm of Lumière & Collar, of Lyon, exhibited coloured transparent figures of microbes, just as they appear to the eye under the Microscope.

Along with Microscopes there were exhibited ovens for the cultivation of bacteria, apparatus for sterilizing, &c.

Among the exhibitors of instruments, a prominent place belongs to the establishment of Carl Zeiss of Jena. Their display included a selection of Microscopes, from the simplest to the most complex, combined with appliances for photographic projection, a set showing all the single parts of which a perfect Microscope is composed, and a collection illustrating the production of lenses from the crude glass through every stage of grinding.

Watson & Sons, of Holborn, exhibited a large selection of Microscopes for various purposes, especially an instrument made according to the indications of Dr. van Heurck, adapted for delicate researches and for photomicrography.

M. Nachet, of Paris, displayed instruments for research, general, scientific, and technical.

* Chemical News. Ixv. (1891) p. 169.

Powell & Lealand, of London, exhibited a large Microscope, said to be the most perfect as regards its stand. Hartnack, of Potsdam, had Microscopes and object-glasses, with photomicrographic fittings. J. Deby, London, displayed a collection of instruments by various modern makers with manifold appliances for illumination, arrangement for obtaining monochromatic light, as also a rich and interesting collection of preparations.

Adnet, and also Wainsegg, of Paris, and Seibert, of Vienna, exhibited a variety of bacteriological apparatus.

It strikes us as remarkable that no spectroscopic apparatus seems to have been exhibited.

The 'Chemiker Zeitung' remarks, with perfect justice, that it is impossible for an expert to pronounce on the value of any instrument, so long as it can only be seen in a glass case.

Meeting of American Microscopists.*—Dr. J. S. Billings, of the Army Medical Staff, in welcoming the visitors to Washington, said:—

"The President, Ladies and Gentlemen: It is my pleasant duty this morning to bid you welcome to Washington and to say to you that you are to make yourselves very much at home here.

Washington, as the capital of the country, is, in fact, the natural and proper home of all national associations, and they are beginning to discover this, for the number of such gatherings here increases every year. Within the last twenty years this city has become not only one of the most beautiful cities in the world, but has become one of the great scientific and literary centres of this country. The needs of different departments of the Government for accurate and precise information upon many subjects connected with their work have brought together here in the different bureaus many men specially trained in modern methods of investigation and research, each working some particular line, and more or less of an expert upon some one particular subject, yet also interested in the general progress of knowledge and the results obtained by his fellow-workers. Hence it is that our local scientific societies are numerous, well attended, and have an abundant supply of material to interest their members; more so, probably, than the majority of local societies in other larger cities. Among these associations, we number an active and flourishing Microscopical Society, for although the Government has no department or bureau exclusively devoted to this subject, yet in almost every department and in many of the bureaus there are, and must be men who are familiar with the use of the Microscope, or they could not answer the questions which are liable to come before them at any moment. You may be sure, therefore, that the American Microscopical Society will always find an appreciative and interested audience for its papers and discussions here.

Of the numerous bureaus of the Government which make use of and are interested in the Microscope and microscopic technique, there is none which makes more constant use of this method of investigation, and none which in times past has done more to stimulate improvements in microscopy, than the medical department of the army, including the Army Medical Museum. The improvements in microscopic objectives

* Amer. Mon. Micr. Journ., xii. (1891) pp. 193-5.

which have been made during the last thirty years, have been, to a considerable extent, stimulated, suggested, and given definite direction by the application of photomicrography to the testing of such objectives as to resolving power and flatness of field under different conditions of illumination. Photomicrography with high powers became a practical and useful process when the use of direct sunlight as a means of illumination was introduced. This was first done in this country by Prof. O. N. Rood, of Columbia College, New York, in 1860-1. It was first suggested and applied in this country to histological preparations in the spring of 1864 in a military hospital here, in Washington, by two assistant-surgeons in the army, James William Thomas and William R. Norris, both now well-known ophthalmologists in Philadelphia. These gentlemen brought the results obtained by them to the attention of Dr. J. J. Woodward, of the army, who was engaged in the collection of materials for the preparations of the medical history of the war and the formation of an army medical museum, and by his direction the process was taken up, extended, and improved by Dr. Edward Curtis, now of New York, who was then engaged in making microscopic preparations to illustrate the pathological histology of certain camp diseases. Subsequently Dr. Woodward himself took the matter up, studying especially the optical combinations and technique of illumination adapted to secure the best results, and applying these methods as a means of minutely and accurately comparing the powers and performances of different objectives, and of making of such performances records whose accuracy could not be questioned, and which could readily be compared with each other.

When Dr. Woodward was doing the greater part of his testing work homogeneous immersion objectives were unknown, and with high powers the proper adjustment of the cover correction was a matter of the greatest importance to secure the best results, and was also often a matter of considerable difficulty. Dr. Woodward's skill and patience in making these adjustments and in regulation of the illumination were unrivalled. He often spent half an hour and more in securing a single cover correction, and the makers of microscopic objectives, both in this country and abroad, came to recognize the fact that he was not only absolutely impartial to his tests, but would get from each lens the very best work of which it was capable. The result was that they were glad to send him lenses for trial and to obtain his suggestions as to the possible means of improvement, which in this way was strongly stimulated. Since his death, microscopic and photomicrographic work have been carried on steadily in the museum, but on somewhat different lines, consisting mainly in the practical application of these methods to pathological research and to bacteriology. We shall be very glad to have you spend as much time at the Museum as you can spare, and to show you what we are doing there. In connection with this I wish to invite your attention to two cases at the south end of the main Museum hall which contain a number of Microscopes illustrating the development of and changes in this instrument and its accessories, from the time of the first known compound Microscope of Janssen, in 1685, down to the present time. In bringing together this collection during the last ten years, I have been greatly aided by [the late] Mr. John Mayall [Jun.] of London, who

has had so much to do with the formation of the magnificent collection of Mr. Crisp. Permit me to remind you, that as citizens and sovereigns of the Republic, the Medical Museum belongs to you, and that as American microscopists its collection of Microscopes and of microscopic slides and material should be a matter for your special interest and care. The collection is very far from being complete, it is only the beginning of what I hope will one day be gathered and carefully preserved in it, namely a specimen of every different form of Microscope, and especially of the earlier forms of American makers, of which we have none, and also specimens of the best work of American microscopists which can be shown by permanent preparations, and to secure this I ask your assistance.

The library of the Surgeon-General's office, connected with the Museum, is rich in books and journals relating to the Microscope and its uses, especially in its applications to biology and the medical sciences, and it is available to all who wish to use it. If you are not familiar with its resources and its index, I hope you will become so while you are here."

Recreative Microscopy.*—Mr. Henry Ebbage communicates the following note:—"A pretty object for entertaining friends is the arborescent growth of silver crystals. To show this, dissolve a small crystal of silver nitrate (or a piece of lunar caustic) in a few drops of rain-water. Place a drop of this solution in the centre of a slip of glass, and arrange it under a low power of the Microscope, concentrating the light from above by means of a stand condensing lens. Now take a piece of copper bell-wire $1\frac{1}{2}$ in. long, and bend it like a capital L, then bend the longer limb to form a hook, which will rest anchor-fashion when laid down. Place this at the side of the drop of solution, allowing the hook to dip into it at the edge. Chemical exchange results, copper going into solution, and silver crystallizing out.

N.B.—Do not spill the solution as it stains black."

B. Technique.†

(1) Collecting Objects, including Culture Processes.

Methods of Bacteriological Research.‡—In an article of twelve pages Dr. Kirchner gives a compressed but clear account of all the methods of bacteriological research, and this is prefaced by a review of the general morphological and biological characteristics of bacteria.

The most important of the microscopical and cultivation methods are described with an accuracy of detail so that they are available for practical work.

At the end of the article are considered the examination of water, air, and soil, and also that of infectious diseases.

* English Mechanic, liv. (1891) p. 19.

† This subdivision contains (1) Collecting Objects, including Culture Processes; (2) Preparing Objects; (3) Cutting, including Imbedding and Microtomes; (4) Staining and Injecting; (5) Mounting, including slides, preservative fluids, &c.; (6) Miscellaneous.

‡ 'Handwörterbuch der Gesundheitspflege,' pp. 69–80. See Centrabl. f. Bakteriol. u. Parasitenk., x. (1891) p. 234.

Silicate-jelly as a Nutrient Substratum.*—Herr P. Sleskin, who has used the substratum of silicic acid, relates his experience in following out the preparation of the silicic acid as directed by Kühne, and its further modification according to Winogradsky, for cultivating nitrifying organisms. Three volumes of silicate of soda diluted to a specific gravity of 1.08 are mixed with 1 volume of hydrochloric acid (equal volumes of HCl sp. gr. 1.17 and H₂O). The two ingredients having been thoroughly mixed by stirring, the solution is dialysed in running water for about eleven days. The dialyser used was 19 cm. in diameter, and the layer of silicic acid 4–5 cm. thick. The fluid thus obtained has a specific gravity of 100.1 (about), is slightly opalescent, but transparent and liquid. In this condition it may be kept, for some time at least, in sterilized flasks. The next step is to evaporate the silicic acid down to 3/5 to 1/2 its volume in flasks plugged with cotton-wool.

The nutrient salts to be added are—Ammonium sulphate, 0.4; magnesium sulphate, 0.5; potassium phosphate, 0.1; calcium chlorate, a trace; sodium carbonate, 0.6–0.9. All the sulphates are mixed together and dissolved in as little water as possible; so too are the soda and potash salts, the extremely dilute calcium chlorate forming a third solution. All three are sterilized apart and thus preserved.

The two first saline solutions are mixed with the thickened silicic acid and the calcium chlorate afterwards added. A few flakes from precipitated salts are usually visible, but these do not interfere with the transparency of the medium, which is a fluid with the consistence of oil, and which, after having been poured into capsules, slowly and of its own accord thickens in a few hours to a jelly.

Substitutes for Agar and Gelatin.†—Herr Marpmann says that a perfectly bright and clear nutrient medium having all the properties of agar may be prepared in the following manner, by using an alga, *Sphaerococcus confervoides*, found in the Mediterranean:—30 parts of alga are macerated in 2 parts hydrochloric acid and 1 litre water for two hours. The mixture is then washed thoroughly with water until blue litmus-paper no longer turns red. After decanting, there are added 700 parts water, 40 parts glycerin, 20 parts Koch's liquid pepton, 2 parts beaten-up albumen. The mixture is next boiled in a steamer for 20 minutes, then neutralized and filtered through a syrup-filter.

As a substitute for gelatin the author uses chondrin, which he extracts from rib and ear cartilage by boiling in a Papin's digester under a pressure of two atmospheres. The chondrin is filtered while hot through an ordinary paper filter, and when cold it is found to have set more firmly than gelatin. Besides this greater firmness, chondrin possesses the additional advantage of being more slowly liquefied by peptonizing microbes and of not losing its consistence after prolonged boiling, at least not till 140° C. are reached.

Miniature Tank for Microscopical Purposes.‡—Dr. Thomas S. Stevens remarks:—“Any collector from ponds and ditches, who has reached over the contents of a round bottle with a lens, knows how difficult it is to see and capture the interesting objects it may contain,

* Centrabl. f. Bakteriöl. u. Parasitenk., x. (1891) pp. 209–13.

† Tom. cit., pp. 122–4.

‡ Microscope, xi. (1891) p. 156.

on account of the distortion produced by the convex sides of the bottle. At a trifling cost a small flat aquarium, or large zoophyte trough, may be made that will obviate this difficulty.

Take two pieces of plate glass about 6 in. square, and from a dealer in rubber goods obtain a strip of pure rubber packing about $\frac{3}{4}$ in. square, and so long that when bent into a horse-shoe or U shape the ends will just come to the top edge of the glass sides, while the curve shall not quite reach the bottom. If the rubber is flush with the lower edge, or a trifle below, the tank will not stand firm when finished. This rubber strip, bent into proper form, is to be cemented between the two glass sides. This may be easiest done by marking on a soft pine board a square exactly the size of the glass, and on this square bending the rubber strip into a U shape; keep it in position by placing pins or tacks, not through, but at the sides of the packing, at various points, so as to hold it in shape. Smear the upper side of the packing thoroughly with cement, lay on one of the glass sides, being careful to have it in position, press it firmly on the cement and place a weight above it to hold it down, and leave it overnight for the cement to harden. Smear the other side of the rubber strip with cement and place the other glass upon it, being careful to have the edges of both sides parallel. Weight it down, leave to harden as before, and the tank is done. The cement that I have used is Van Stain's Strateria. No doubt there are others that would answer the purpose as well. Marine glue would probably be better. The rubber packing comes in different sizes, from $\frac{1}{4}$ to $1\frac{1}{4}$ in. in thickness. The aquarium may therefore be varied, both in size and transverse depth, to suit the needs and taste of the maker."

Apparatus for Gathering and Examining Microscopic Objects.*—

Mr. G. M. Hopkins writes:—"One of the difficulties experienced by the beginner in microscopy is the finding and gathering of objects for examination. As a rule, cumbersome apparatus has been used. The conventional apparatus consists of a staff, to which are fitted a knife, a spoon, a hook, and a net; but a great deal can be accomplished with far less apparatus than this.

The engraving (fig. 89) illustrates a simple device by means of which the amateur microscopist can supply himself with as much material as may be required. It consists of an ordinary tea or dessert-spoon, and a wire loop of suitable size to extend around the bowl of the spoon, having the ends of the wires bent at right angles and hooked in opposite directions. To the loop is fitted a conical cheese-cloth bag, and to the bottom of the bag, upon the outside, is attached a strong string, which extends over the top and down to the bottom of the bag, where it is again fastened. The spoon is inserted between the bent ends of the loop and turned, and the point of the bowl is slipped through the loop.

The instrument is used in the manner shown in fig. 89, that is to say, it is scraped along the surface of objects submerged in the water, the water passing through the cloth, and the objects being retained by the conical bag. When a quantity of material has accumulated, the bag is turned inside out by pulling the string, and the pointed end of the bag

* English Mechanic, liii. (1891) p. 426.

is dipped a number of times in water contained in a wide-mouthed bottle. The operation is then repeated. The objects thus washed from the bag are retained in the bottle for examination.

FIG. 89.



Gathering microscopic objects.

The common method of examining small objects of this kind is to place a drop of water containing some of the objects upon a glass slide by means of a drop-tube, then to apply a cover-glass, and remove the surplus water by the application of a piece of blotting-paper. This answers very well for the smaller objects, but the larger ones must be examined in a tank like that shown in fig. 90. This tank consists

FIG. 90.

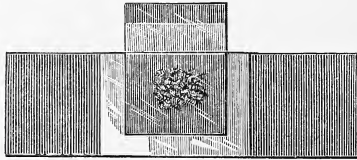

Tank for microscopic objects.

of a glass slide, to which are attached three glass slips, by means of cement (bicycle-tire cement answers well for this purpose), the strips forming the bottom and ends of the tank. The front of the tank is formed of a piece of a glass slip attached to the strips by means of cement. To vary the thickness of the body of water contained in the tank when necessary, one or more glass slips are inserted behind the object."

(2) Preparing Objects.

Preserving Fluid.*—Prof. Strobel strongly recommends “il liquido Caggiati” as a preserving medium for entire animals and for anatomical preparations. Though it cannot be used in extremes of heat or cold, it is otherwise most advantageous; it is economical and simple, is not inflammable, and does not remove the colour of the objects preserved. Its composition in cubic centimetres is distilled water 1000, creosote 20, alcohol (at 75°) 100 parts.

Investigation of Fowl's Ovum.†—Prof. M. Holl removed the ovary from a just killed hen, and fixed it either with chrom-osmium-acetic acid or 1/3 platinum chloride or Kleinenberg's fluid. After gradual hardening in alcohol, staining was effected with borax-carmin or hæmatoxylin, and after treatment with toluol, imbedding in paraffin followed.

Preparation of Embryos of Amphibia.‡—Mr. H. H. Field, in his investigations into the development of the pronephros and segmental duct of Amphibians, made use of the ordinary histological methods; many, however, of the hardening reagents and stains gave thoroughly unsatisfactory results. Embryos of *Rana* and *Bufo* can be satisfactorily killed in Kleinenberg's picrosulphuric mixture, and can be then successfully stained in Orth's lithium-carmin. The object should be exposed to the action of the stain as long as possible, but care must be taken to guard against maceration; with this object it was often found advantageous to stain the object twice, removing it after the first staining to strong alcohol. In passing the stained objects through grades of alcohol it is important to keep a little picric acid dissolved in the several fluids, in order to prevent the alcohol from extracting the yellow stain from the specimen. Embryos thus treated showed a very effective double stain; the nuclei are bright carmin, and contrast with the yellow colour imparted by the picric acid to the yolk-spherules among which they are found. Merkel's fluid is a good killing reagent, and should be followed by hæmatoxylin, and the decolorizing watched with care.

For *Amblystoma* the best treatment was Fol's chromic-osmic-acetic mixture, followed by Czokor's cochineal.

Investigation of Brain and Olfactory Organ of Triton and Ichthyophis.§—Dr. R. Burchhardt recommends for young Amphibian larvæ which still contain a considerable quantity of yolk, preservation in Rabl's fluid, and coloration with borax-carmin or alum-cochineal. For older larvæ Rabl's fluid, Altmann's process for chrom-acetic acid (1 per cent. chromic acid 10 hours, 5 per cent. acetic acid 24 hours, alcohol in slowly increasing quantities, and then 1/2 per cent. osmic acid for 5 hours). The preparations should be washed in water and stained with borax-carmin or Delafield's hæmatoxylin. Specially exact results were obtained by fixing with osmic acid and staining with hæmatoxylin. Excellent results are also to be obtained by the combination of borax-carmin with nigrosin or Lyon's blue in a weak

* Neptunia, i. (1891) pp. 301-2.

† SB. K. Akad. Wiss. Wien, xcix. (1890) p. 339.

‡ Bull. Mus. Comp. Zool., xxi. (1891) p. 203.

§ Zeitschr. f. Wiss. Zool., lii. (1891) p. 370.

alcoholic solution; fixing by picric acid will improve the results. Adult Amphibia should be decalcified and fixed with chromic and nitric acids; they should be stained with borax-carminine.

Preparing Epithelium of Mid-gut of Arthropods.*—Sig. O. Visart opens the living animal, keeping it immersed in running water, and injects by the anus a concentrated solution of methyl-blue in alcohol at 80. The gut is then ligatured, and left for a quarter of an hour. On opening the gut, the epithelium is found completely separate from the tunica propria, and furnishes most satisfactory preparations.

Mode of Preparing Crustacean Eyes.†—Mr. G. H. Parker states that most of his specimens were stained in Czokor's alum-cochineal and mounted in benzol-balsam. The agent used in depigmenting sections was an aqueous solution (1/4 per cent.) of potassic hydrate.

Preparing Segmental Organs of Hirudinea.‡—Prof. H. Bolsius found the following combination useful; after staining with hæmatoxylin the leech was washed for half an hour in a nearly concentrated solution of pure picric acid. By this double coloration the nucleus was stained by the hæmatoxylin, while the protoplasm of the segmental cells was yellow. This method introduces much variety into the coloration of the other tissues of the body. The muciparous cells are blue, the spermatozoa have cherry-red nuclei, the ova are rosy, the epithelial cells of the intestine violet-red with very deep nuclei, the ganglia are deep lilac, the nerve-chain almost black, the lymphatic and blood-cavities yellow to brown, the muscles are straw-coloured with red nuclei, and the connective tissue is of a clear yellow colour.

Eismond's Method of Studying living Infusoria.§—M. A. Certes reports that this method || gives excellent results. He has attempted to improve on it by the addition of colouring matters, and he has fully succeeded with methyl-blue and violet dahlia No. 170; with the latter the species studied did not live long; with the other, survival is very much longer, unless the solution is too concentrated.

Demonstration of Presence of Iron in Chromatin by Microchemical Methods.¶—Dr. A. B. Macallum states that he has discovered a method of employing ammonium sulphide as a reagent for iron, by which he is able to show the presence of the latter in the chromatin of the nuclei of a very large number of species of cells hardened in alcohol. The iron does not here occur combined as an albuminate, but rather in a condition comparable to the combination seen in potassium ferrocyanide or hæmatin. Experiments with vegetable cells and such animal cells as those of the corneal epithelium of Amphibia show that the iron found is not due to the presence of hæmatin. Moreover, when chromatin is very abundant the iron reaction is very marked, while it is feeble in cells poor in chromatin. In the chromatin loops and filaments of karyokinetic figures the iron reaction is intense and sharply confined

* Atti Soc. Tosc. Sci. Nat., vii. (1891) pp. 277-85.

† Bull. Mus. Comp. Zool., xxi. (1891) p. 141.

‡ La Cellule, vii. (1891) pp. 5-6.

§ Bull. Soc. Zool. France, xvi. (1891) pp. 93-4.

|| See this Journal, ante, p. 141.

¶ Proc. Roy. Soc. Lond., xlix. (1891) pp. 488-9.

to these structures. So far as the author's studies have gone he has not met with an instance of the chromatin of a cell not containing iron.

Culture of Terrestrial Algæ.*—Prof. A. Borzì gives the results of his long experience in the cultivation of terrestrial Chlorophyceæ, whether mixed or pure. It is essential in either case to have a contrivance for the constant and regular supply of fresh water. A porous substratum furnishes the best results, and he finds the most convenient to be a white calcareous tufa known in Sicily as "Syracuse stone" (pietra di Siracusa). The light must be allowed to reach the glass vessel in which the algæ are grown from one side only; the side where the fresh water is received and the surplus water drawn off must be the least illuminated; the zoospores will then collect on the wall of the vessel and form a green layer visible to the naked eye. It is impracticable to obtain as absolute purity in the culture of unicellular algæ as in that of bacteria. The plan recommended by the author to obtain comparative purity is a purely mechanical one,—removing the organism to be examined by means of a capillary glass tube, placing it in a drop of pure water, and repeating this process many times. He strongly approves Beyerinck's gelatin method † for the culture of algæ.

Re-softening dried Algæ.‡—Herr J. Reinke recommends eau de Javelle as an excellent medium for restoring dried algæ to an almost fresh condition. Even if they are quite black, the blackening will disappear with prolonged maceration.

Demonstrating Fungi in Cells.§—For demonstrating fungi within cells filled with plasma, Herr H. Möller advises that the fresh material should be treated with chloral hydrate either after the method of A. Meyer (5:2), or still better, in cold saturated solution. In this strength not only the starch but the cytoplasm are soon dissolved, and the process may be hastened by heating in a water-bath. It is necessary to constantly change the chloral hydrate, and at each interval wash the sections in water. By this procedure almost all the contents of the cell are dispersed, while the plasma of the fungi is unaffected, so that when stained a good picture is obtained.

Modes of Investigating Chemical Bacteriology of Sewage.||—Sir H. E. Roscoe and Mr. J. Lunt have carefully recorded by means of photographs the microscopic and macroscopic appearances of the organisms found in sewage; they consider this to be of much importance, as bacteriological descriptions of organisms are frequently of little value from the want of accurate representations of the microscopic preparations and pure cultures.

For the isolation of micro-organisms the methods of gelatin plate-culture and of dilution were used, as well as two in which spore-forming organisms were isolated, or anaerobic organisms were isolated and cultivated. The anaerobic organisms were isolated by carrying crude sewage through three cultivations in pure hydrogen; spore-forming organisms were isolated by heating sterile broth in which a sowing had been made

* Neptunia, i. (1891) pp. 198-208.

† Cf. this Journal, *ante*, p. 130.

‡ Ber. Deutsch. Bot. Gesell., vii. (1890) p. 211.

§ Tom. cit., p. 215.

|| Proc. Roy. Soc. Lond., xlix. (1891) pp. 455-7.

from crude sewage to 80° for ten minutes; the still living spores were then further isolated by plate cultivation, either with or without previous incubation of the broth tube.

When the micro-organisms were to be photographed, they were stained with methyl-violet, and as this stain transmits chemically active rays, actinic contrast was obtained by using a coloured screen and isochromatic plates; the apparatus employed was of the simplest kind, and the source of illumination was a common duplex paraffin lamp.

Simple Method for obtaining Leprosy Bacilli from living Lepers.*

—Dr. A. Favrat and Dr. F. Christmann state that by the following method, which also possesses the merit of improving the patient's appearance, leprosy bacilli can be easily obtained in quantity. The skin is first purified with soap, 1 per cent. sublimate solution, alcohol, and ether. One or more nodules are then burnt with a Paquelin's cautery. The cauterized place is then coated over with collodion, and lastly is protected by aseptic bandages. After 3–4 days (not later), the bandage having been removed and the sore washed with spirit, the scab is raised with a red-hot spoon and the subjacent layer of matter scraped off or inoculated directly on the cultivation medium. The sore rapidly heals, and no trace of the leprosy nodule remains.

Microscopical examination reveals an enormous quantity of bacilli, together with pus corpuscles and broken-down matter. The bacilli lie scattered about without any definite arrangement, occasionally being observed in little heaps, but never inside cells.

Cultivations made from the bacilli were unsuccessful, while the inoculation experiments are as yet uncompleted.

(4) Staining and Injecting.

Method for fixing Preparations treated by Sublimate or Silver (Golgi's Method).†—Sig. A. Obregia gives a method for rendering preparations treated by Golgi's sublimate or silver procedure so permanent that they may be afterwards stained and protected with a cover-glass.

The sublimate or silver preparations are sectioned without any imbedding or after having been imbedded in paraffin or celloidin. In the latter case care must be taken not to use alcohol weaker than 94 or 95 per cent., at any rate for the silver preparation. The sections are then transferred from absolute alcohol to the following mixture:—1 per cent. gold chloride solution, 8–10 drops, and absolute alcohol, 10 ccm., which should have been made half an hour previously, and exposed to diffuse light. After sections are deposited therein, the vessel containing them is placed in the dark. The silver is gradually replaced by gold, and the mercury changed into gold amalgam. Finally, black delicate designs appear on a white field. According to the thickness of the section, the fluid is allowed to act from fifteen to thirty minutes, but even longer is not harmful. Thereupon the sections are quickly washed first in 50 per cent. alcohol, then in distilled water, and finally in a 10 per cent. solution of hyposulphite of soda, in which, according to

* *Centralbl. f. Bakteriol. u. Parasitenk.*, x. (1891) pp. 119–22.

† *Amer. Mon. Micr. Journ.*, xii. (1891) p. 210. See *Virchow's Archiv*, cxxii. (1890).

their thickness, they remain from five to ten minutes. A longer immersion bleaches too much, so that the finer fibres disappear. Last of all they are thoroughly washed in distilled water twice renewed.

Sections thus fixed can afterwards be stained by any method, e. g. Weigert's, Pal's, &c., after which they are cleared up with creosote, imbedded in dammar, and protected with a cover-glass.

Throughout the procedure the sections must be manipulated with glass instruments, and not allowed to touch any metallic substance.

Rapid Staining of Elastic Fibres.*—Sig. E. Burci fixes the objects in alcohol, Müller's fluid, or corrosive sublimate; stains the sections with carmine or hæmatoxylin; washes them in water; dips them for a minute or two in saturated alcoholic solution of aurantia (dinitrophenylamine). The sections are then passed rapidly through absolute alcohol, cleared, and mounted as usual.

New Method of Spore-staining.†—Dr. H. Moeller describes the following method for staining spores. The cover-glass preparation, having been dried in the air, is passed thrice through the flame or immersed for two minutes in absolute alcohol. It is then placed in chloroform for two minutes, and afterwards washed with water; then for 1/2–2 minutes in 5 per cent. chromic acid, and again thoroughly washed with water. The preparation is then stained with carbol fuchsin, being boiled in the flame for 60 seconds; the carbol fuchsin having been poured off, the stain is decolorized in 5 per cent. sulphuric acid, after which the cover-glass is thoroughly washed with water. It is then contrast-stained by immersion for 30 seconds in aqueous solution of methylen-blue or malachite-green. The spores should be dark red and the rest of the bacterium green or blue.

Hæmalum and Hæmocalcium, Staining Solution made from Hæmatoxylin Crystals.‡—Dr. Paul Mayer highly recommends the use of two staining solutions made from hæmatein, the essential staining constituent of logwood. When pure, hæmatein is a brown-red powder and crystallizes with one or three equivalents of water. It is most frequently found in commerce as hæmateinum crystallizatum, a compound of hæmatein and about 9 per cent. of ammonia, and is more properly designated ammonia-hæmatein. When pure, hæmatein and its ammonia compounds should not only be perfectly soluble in distilled water and alcohol, but should remain so on addition of acetic acid. From hæmatein is prepared a solution called, for short, hæmalum.

1 grm. of the pigment is dissolved by the aid of heat in 50 ccm. of 90 per cent. alcohol, and then added to a solution of 50 grm. of alum in 1 litre of distilled water. When cold it may be necessary to filter, but if the constituents have been pure this is quite superfluous. The solution is ready for use at once. It may be necessary to add a thymol crystal in order to prevent the formation of fungi.

For staining sections, hæmatein is used like Boehmer's hæmatoxylin, and if required the preparations may afterwards be washed with ordinary water, distilled water, or 1 per cent. alum solution.

* Atti Soc. Tosc. Sci. Nat., vii. (1891) pp. 251–3.

† Centralbl. f. Bakteriöl. u. Parasitenk., x. (1891) pp. 273–7.

‡ Mittheil. Zool. Stat. zu Neapel, x. (1891) pp. 170–86.

Hæmacalcium, which is proposed as a substitute for Kleinenberg's hæmatoxylin, is made with the following ingredients:—hæmatein or ammonia-hæmatein, 1 grm.; aluminium chloride, 1 grm.; calcium chloride, 50 grm.; acetic acid, 10 ccm.; 70 per cent. alcohol, 600 ccm. The first two substances are to be pounded together very intimately; the acetic acid and the alcohol are then to be added, with or without the aid of heat. Last of all, the calcium chloride is added. The fluid is of a red-violet hue. After having been washed in neutral 70 per cent. alcohol the preparations are violet or blue, and rarely require to be treated with acidulated alcohol. If too red they may be treated with 2 per cent. aluminium chloride dissolved in alcohol.

Fraenkel on Gabbet's Stain for Tubercle Bacilli.*—Dr. B. Fraenkel seems to think that the method known as Gabbet's, the original communication of which was in the 'Lancet,' 1887, p. 757, is really the same in principle as one published by him in 1884. Gabbet's method consists in decolorizing with a mixture of H_2SO_4 and methylen-blue. Fraenkel's decolorizer, as given in No. 13 of Berlin. Klin. Wochenschr. for 1884, is nitric acid, besides which the formula includes alcohol. What should be the criterion for determining what is or what is not a new principle in bacteriology must remain open. At any rate, the formula given by Dr. Glorieux, published in Bull. Soc. Belge de Microscopie, 1886, pp. 44–8, is much nearer in principle than Fraenkel's, and differs from Gabbet's merely in that the latter contains no alcohol.

Syringes and their Sterilization.†—Dr. Tavel describes a syringe which is easily sterilized. Though chiefly intended for surgical purposes, it is useful in the bacteriological laboratory. The principle of the apparatus consists in avoiding the trouble of having to sterilize the piston part, which is quite disconnected from the syringe-needle portion. The piston, half the rod of which is notched, is furnished at the end with a screw and tap. To this screw is screwed on a metal cap, and into this latter fits the graduated glass holder or syringe, terminating at its other end in a steel needle. For laboratory work the author discards the piston portion, using the syringe-needle and adapting this for injection purposes by means of a Y-shaped glass tube. To the arms of the Y are fitted the syringe-needle and the bellows by means of rubber tubes.

The apparatus used for sterilizing these syringe-needles is then described. It is an ordinary rectangular vessel heated by gas, the jet of which is regulated by Reichert's thermo-regulator, but instead of water the reservoir contains paraffin. In this the syringe-needles, inclosed in test-tubes plugged with cotton-wool, are suspended, and thus are sterilized with hot air. The regulator is adjusted for 155° , so that the inside of the syringes may be kept at 150° , a temperature which is maintained for two hours. Higher temperatures are injurious to the steel of the needles. The sterilizing over, the test-tubes are taken out and wiped. The needles, kept inside till required, remain perfectly aseptic.

* Deutsch. Med. Wochenschr., No. 15, 1891. See Centrabl. f. Bakteriol. u. Parasitenk., x. (1891) pp. 234.

† Annales de Micrographie, iii. (1891) pp. 564–73 (3 figs.).

(6) Miscellaneous.

Microchemical Reactions of Tannin.*—Mr. S. Le M. Moore distinguishes three kinds of tannin in plants, known by their different reactions with Nessler's fluid, viz.:—(1) tannin giving an immediate brown precipitate, occasionally with brown-pink tendency; (2) tannin giving a yellow colour, quickly becoming red-brown, and, finally, a cold-brown precipitate; (3) tannin giving a yellow colour, the yellow substance readily diffusing through the cell-walls into the surrounding fluid, thus leaving the cells colourless after a varying lapse of time. In addition to the functions hitherto ascribed to tannin, the author believes that it may have a more general relation to the turgescence of the cell; and that tannin is also most likely used up in the lignification of the cell-wall.

Cleansing Used Slides and Cover-glasses.†—Dr. F. Knauer says that the slides and cover-glasses of old preparations may be made as good as new by the following method, which he has adopted for some time past. 60–80 (say) slides are placed in a vessel holding about half a litre of 10 per cent. lysol solution and boiled for twenty to thirty minutes. The still seething vessel is then placed straight away under a strong current of running water until it streams back quite clear, after which the glasses are taken out and dried on a clean cloth. If the preparations be of comparatively recent date a 5 per cent. solution is quite sufficient.

Dr. J. B. Nias ‡ says:—"Bacteriologists and others who find themselves with accumulations of Microscope slides may be glad of the following hint for cleaning them. It is not given in any text-book that I can discover. Instead of warming the slides one by one over a flame, pushing off the cover, and then scraping away the balsam and cleaning with alcohol, I put all my slides together into a saucepan with a lump of washing soda, and boil them. The heat of boiling is enough to soften most cements and all ordinary resins used for mounting, and I then fish out the slides one by one, push off the cover-glasses, and put them back. The action of the soda is to convert the balsam or other resin into a grumous mass, which is easily wiped off with a little rinsing. Cover-glasses can also be recovered for future use in the same way, if desired. I think this method may be of service to laboratory attendants. Neither do I find anything on the surface of new covers and slides which will resist the action of hot water and soda; and so I prefer this way to the use of strong sulphuric acid and alcohol, or the other methods given in the text-books. The exact quantity of soda to be used is immaterial; a piece about the size of a mandarin orange to half a pint of water will do."

Method for the Estimation of the actual number of Tubercle Bacilli in Phthisical Sputum.§—Dr. G. H. F. Nuttall describes with great lucidity a method which he has devised for estimating the actual number of tubercle bacilli in sputum. Naturally enough the procedure

* Journ. Linn. Soc., xxvii. (1891) pp. 527–38.

† Centralbl. f. Bakteriol. u. Parasitenk., x. (1891) pp. 8–9.

‡ Lancet, 1891, p. 1414.

§ Johns Hopkins Hospital Bulletin, No. 13, 1891 (5 figs.).

is complicated, but as the separate stages or details are quite simple, and as the method is applicable not only to sputum but to any fluid containing micro-organisms, it seems probable that it may succeed where several other methods having a similar object have failed. Owing to its length we can only give the coarser details of the process, and for the finer ones must refer to the original, wherein the minutest particulars will be found.

The sputum is mixed with 5 per cent. caustic potash solution until it becomes perfectly fluid. The mixture is then shaken in a "milk-punch shake," in order that the bacilli may be evenly distributed throughout the fluid. The sputum is then transferred to a burette and dropped out on cover-glasses. The flow of sputum from the burette is regulated by means of a groove filed on one side of the aperture of the stop-cock. By this device the equable flow of a series of equal-sized drops was insured. The equal size of drops containing an equal number of organisms is, of course, the great desideratum. The best size for the drops was found to be 100-150 to the cubic centimetre of sputum.

The next step is to spread the sputum on the cover-glass so as to form a thin film. This is done on a turntable, the sputum being spread by means of a fine platinum needle, the point of which is bent at an angle of about 45° . The cover-glasses, kept in a perfectly horizontal position, are to be dried at $35-40^\circ$, and then surrounded by a ring of paint composed of lampblack and serum. The layer of sputum is next to be covered with a thin film of sterilized serum, which is coagulated at a temperature of $80^\circ-90^\circ$ C., and then the caustic potash must be extracted from the sputum by means of alcohol, the solvent action of the latter being aided by heating in the thermostat. The main object of the serum film is to prevent any of the bacilli being removed during manipulation. The sputum is then stained with phenol-fuchsin and decolorized by alternate immersion in alcohol and weak sulphuric acid. After having been washed with water, the preparations are merely dried on blotting-paper and then mounted in balsam.

The next part of the method deals with the actual counting and the apparatus necessary thereto. In a No. 12 eye-piece is inserted a diaphragm made of black paper in which a small hole has been cut. The aperture of the diaphragm is traversed by a hair-line. In order to be quite accurate about the fields, the latter are indicated by fixing a cork to one of the screws of the mechanical stage. The cork is armed with a thin wooden indicator terminating in a needle. The needle is made to point to the radial divisions on a cardboard scale placed by the side of the Microscope. The scale is affixed to a wooden circle, the centre of which is cut out in order to allow the stage-screw to be easily manipulated through the aperture. By this simple apparatus the size of the drop in fields is measured. The number of fields varies from 180-220, and the method of calculation is from a given case as follows:— A drop 200 field-widths in diameter is found to contain (average of 500 fields) 5 bacilli to the field; then $200^2 \times 0.7854 = 31,416$ (area of drop in fields) $\times 5 = 157,080$ bacilli to the drop.

The bacilli are counted as they pass under the hair-line of the diaphragm, and their number is registered by a machine known as the

"adding and counting register," which is fixed to the tightening-bar of the Microscope.

After giving illustrative cases, the author makes some remarks on the multiplication of tubercle bacilli in sputum outside the body, and then gives a short demonstration of the accuracy of the method.

Colloidal Clay for Filtering Fluids containing Bacteria.*—Dr. H. Aronson uses argillaceous earth, from which he prepares the hydroxide of aluminium for filtering purposes in the bacteriological laboratory. The aluminium hydroxide is precipitated as a gelatin-like snowy mass from a 12 per cent. solution of sulphate of alumina or alum by means of excess of ammonia. After settling, the supernatant fluid is partly decanted and partly siphoned off, and the residue washed with distilled water until its reaction is completely neutral. The colloidal mass is then spread on the plate of Hirsch's porcelain filter and distributed so as to form an even layer, and the whole then sterilized in an incubator at 140° ; previously to this any excess of fluid may be removed by a suction-pump in the usual way.

In this way is obtained a filter-mass which is at once uniform and homogeneous. Occasionally, after removal from the incubator, cracks and fissures may develop in the mass; these may be avoided by adding a little boiling sterile water before the mass have had time to cool.

The filtrates obtained by means of this medium seem to have been successful in most cases. The apparatus, however, will tolerate only very low suction-pressures, as anything like a high pressure produces cracks and clefts in the filter-mass.

Some Suggestions in Microscopy.†—Mr. G. M. Hopkins, writing in the 'Scientific American,' says:—"An object which always interests the microscopist, and excites the wonder and admiration of those who regard things microscopic from the point of popular interest, is the circulating

FIG. 91.

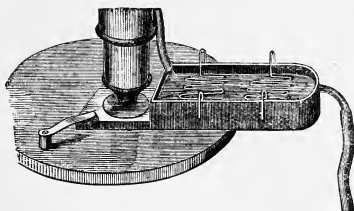

blood in living creatures. Nothing in this line has proved more satisfactory than the microscopic view of the circulation of blood in the tail of a goldfish. Thanks to Mr. Kent's invention of the fish-trough, the arrangement of the fish for this purpose has been rendered comparatively simple and easy.

* *Archiv f. Kinderheilkunde*, xiv. (1891) pp. 54-8.

† *English Mechanic*, liii. (1891) p. 494.

The trough consists of a metallic vessel provided with a thin extension at one end near the bottom furnished with glass-covered apertures, above and below. The body of the fish between the gills and tail is wrapped with a strip of soft cloth, and the trough being filled with water, the fish is placed therein, with its tail projecting into the extension between the glass covers. The tank is arranged on the microscopic stage with the tail of the fish in position for examination. So long as the fish remains quiescent all goes well, and the beautiful phenomenon may be witnessed with great satisfaction; but the subject soon becomes impatient, and at the most inopportune moment either withdraws its tail from the field or jumps out of the tank, thus causing a delay which is sometimes embarrassing.

The uneasiness of the fish is caused partly by its unnatural position, and partly by the vitiation of the water. The latter trouble has been remedied by the writer by inserting a discharge-spout in one end of the trough, and providing a tube for continually supplying fresh water. The other difficulty has been surmounted by providing two wire grids, each having spring clips at their ends for clamping the wall of the tank. These grids are pushed downward near the body and head of the fish, so as to closely confine the little prisoner without doing it the least injury. With these two improvements the examination may be carried on comfortably for an hour or more.

In fig. 92 is shown a simple device for dark-ground illumination. Although it does not take the place of the parabolic illuminator or the spot-lens for objectives of low angle, it answers an excellent purpose.

FIG. 92.



To a metallic slide A, having a central aperture surrounded by a collar, is fitted a funnel B, of bright tin or nickel-plated metal, which is provided with a downwardly projecting axially arranged wire, upon which is placed a wooden button capable of sliding up or down the wire, the button being of sufficient size to pre-

vent the passage of direct light to the objective. The light by which the illumination is effected passes the button, and, striking the walls of the conical reflector, is thrown on the object."

Artificial Sea-water.*—Dr. D. Levi-Morenos has some notes on the composition of artificially prepared salt water as used with success in aquaria, and in keeping oysters, for instance, in good health. Gosse's recipe suggested the following proportions:—Sodium chloride 100, magnesium sulphate 8·8, magnesium chloride 14·3, potassium chloride 3. These salts, dissolved and filtered, were added to fresh water till the average density of natural salt water was reached. In Perrier's aquarium the water contained the following salts in the proportions stated:—Sodium chloride 78, magnesium sulphate 5, magnesium chloride 11, potassium chloride 3, calcium sulphate 3.

* Neptunia, i. (1891) pp. 162-4.

PROCEEDINGS OF THE SOCIETY.

MEETING OF 21ST OCTOBER, 1891, AT 20, HANOVER SQUARE, W.,
THE PRESIDENT (DR. R. BRAITHWAITE, F.L.S.) IN THE CHAIR.

The Minutes of the meeting of 17th June last were read and confirmed, and were signed by the President.

The List of Donations (exclusive of exchanges and reprints) received since the last meeting was submitted, and the thanks of the Society given to the donors.

	From
Bennett, A. W., An Introduction to the Study of Flowerless Plants. pp. ii. and 86, text illust. (8vo, London, 1891)	<i>The Author.</i>
De Toni, J. B., Sylloge Algarum, vol. ii. p. cxxxii. (8vo, Patavii, 1891)	<i>The Author.</i>
A slide showing transverse sections of Cotton	<i>Mr. W. Hutchinson.</i>
Mills, F. W., Photography applied to the Microscope. pp. 61, text illust., 1 pl. (8vo, London, 1891)	<i>The Author.</i>
Vierteljahrsschrift d. Nat. Gesell. Zürich, Bd. i.-ii., v.-ix., xi.-xvi., xviii.-xxiii., xxxiv.-xxxvi.)	<i>The Society.</i>

The Secretary said that the Fellows of the Society would probably remember that during the course of their last session a question arose as to the desirability of taking steps to register the Society as a Friendly Society, and that though several special meetings were held to consider the matter, no definite action was taken, and on December 17th, on the motion of Mr. J. M. Allen, seconded by the Rev. Canon Carr, it was resolved "that this special meeting be adjourned *sine die*." The Council had again had the matter under their consideration, and had decided to make the next meeting of the Society special for the purpose of dealing with it.

The President then gave formal notice that the meeting of the Society to be held on November 18th would be made special for the further consideration of the question of the desirability of registering the Society in accordance with the terms of the Friendly Societies Act.

The President said that the pleasure with which he met the Fellows of the Society after their vacation was very sadly marred by the circumstance that since they last assembled there they had lost one of their Secretaries by death. Little, indeed, did they think when they saw him at their last meeting, so active and so lively, that they should never see him again. The loss they had sustained was one which the Society could hardly hope to replace, because perhaps there was no living person who knew more about the Microscope and its applications than did their deceased friend Mr. Mayall. The difficulty in which they were placed had, however, for the present been met by the kindness of Dr. Dallinger, who had himself undertaken to fill up the vacant place—at any rate until the end of the current session. He hoped that there were some amongst

the younger Fellows of the Society, who were training for mathematical and scientific work, who were qualifying themselves for filling a position such as that, seeing how few there were who could be found to occupy it with distinction.

Prof. F. Jeffrey Bell did not know that he could add much to what the Fellows of the Society had already read and heard as to the severe loss which they had suffered. Those who attended their meetings were able to form some idea of the knowledge which Mr. Mayall possessed, and the remarkable critical power which he brought to bear upon subjects which came before them. But whilst there were some present who could speak as to Mr. Mayall's knowledge far better than he could, no one knew him better in the character of a colleague or could speak more highly of him as such, more especially when he remembered what the Society had passed through during the period of his association with it as one of its Secretaries. They had been uprooted from the place where they had for so long a time flourished, and they had also lost one who was their right-hand man for many years; but in the important business of their removal, and pending the appointment of an Assistant Secretary, Mr. Mayall showed a degree of activity which enabled those two important matters to be carried though successfully and with very little trouble to any one else concerned. To supply the place of such a colleague would be no easy task, for he did not think they would be able to find another who, whilst possessed of equal knowledge of those subjects which came before them, would be able to give the amount of ungrudging service to the Society which Mr. Mayall had constantly done. Although not unprepared for the announcement, the telegram which he received during his holiday conveying the intimation of his death came to him as a blow, and produced a sense of sadness which long remained.

Mr. F. Crisp said that Prof. Bell had anticipated much of what he was going to say, although he could not only speak of Mr. Mayall as a colleague in the Society but also as an intimate personal friend. As regarded his knowledge, no one not closely acquainted with him could estimate the loss to Microscopy which had occurred by his death, for there was no one in the world who knew so much of the history of the Microscope as he did, whilst his name would have to be included in any list of the half-dozen best manipulators to be found in this or any other country. Having known him so well personally he could say that he had always found him certainly to be of a most amiable character. Some persons there were who thought him to be cantankerous, but those who knew him better, knew him to be far otherwise; and although there was one point upon which they used to differ, this was but the exception which proved the rule. Both personally, and as regarded the Society, he felt they had sustained a very great loss which it would take many years to get over.

Dr. W. H. Dallinger having, amidst considerable applause, taken his seat on the platform as one of the Secretaries, said he was very much obliged to those present for the kindly expression of their feelings towards him under the circumstances; it would help him in his work.

His other work was at the present time great, and the claims upon his time were not a few, but he could only say that whatever he could do for the Society he would do with the utmost pleasure.

Mr. A. D. Michael thought they ought not to allow Dr. Dallinger to take his seat without some hearty expression of their sense of the great service he was rendering to the Society. A gentleman of his eminence in the scientific world, and who had been President of the Society, could not be called upon by any one to take the Secretaryship, and it was only his great love of science and his desire to serve the interests of the Society which induced him to accept the position. His kindness in this matter would be a great boon and would add much to the great services he had already rendered to the Society. To show how thoroughly they felt and appreciated the great sacrifices he made for the benefit of the Society he moved that a special vote of thanks be given to Dr. Dallinger for his great kindness in accepting—at least for the present—the office of Secretary of the Society.

Mr. T. H. Powell seconded the motion.

The vote of thanks having been carried by acclamation,

Dr. Dallinger thanked the Fellows for this renewed expression of their kindly feeling, and again assured them of his desire to do all that he could to serve the Society.

The Secretary read a letter from Mr. W. Hutchinson, descriptive of a mounted preparation of cotton exhibited under the Microscope in the room.

Dr. H. Schroeder exhibited a series of photomicrographs of J. D. Möller's type-slides of diatoms. He (Dr. Schroeder) said that Herr Möller had in the years 1886–90 mounted the most complete collection of diatoms ever found. The largest slide contained over 4000 diatoms, arranged in such an order that the name of each one can be found by means of the catalogue, whilst the total number mounted in Herr Möller's collection is over 25,000. Herr Möller originally intended to exhibit his collection, but owing to the difficulties that would be incurred he had abandoned this plan, and contented himself by producing the photographs.

The Society voted a cordial vote of thanks to Dr. Schroeder for the opportunity thus afforded of inspecting the photographs.

The Secretary read the following note from Surgeon V. Gunson Thorpe, R.N., On the Colouring Power of Noctiluæ:—"In the Journ. R. Micr. Soc., 1889, p. 236, there is a notice of a paper by Herr K. Möbius, in which he doubts the statement that the red colour of the sea can be produced by *Noctiluca miliaris*. It may be interesting to know, that towards the end of April 1889, when in the Mediterranean Sea, and approaching Gibraltar, at noon, the ship in which I was, passed for several miles through water coloured a bright red colour. On examination under the Microscope this appearance was found to be produced by myriads of Noctiluæ. Not a trace of *Trichodesmium erythrum* was in company with the infusorian. It was noticed that the large central protoplasmic mass of *Noctiluca* had a distinct reddish tinge, but

whether this appearance was due to ingested food or to some other cause it was impossible to say."

A circular letter was read from Dr. A. M. Edwards, of Newark, New Jersey, U.S.A. asking for samples of diatomaceous earth from this country in exchange (or otherwise) for similar material from California.

Mr. F. Chapman read his paper "On the Foraminifera of the Gault of Folkestone." (See *ante*, p. 561.)

The Secretary, in thanking Mr. Chapman for his paper, said it had been very strongly recommended to the Publication Committee by Prof. Judd and also by Prof. Rupert Jones.

Sir Walter Sendall, K.C.M.G., exhibited and described a new apparatus which he had devised for making more accurate measurements of microscopic objects than were possible with the camera lucida, the inherent faults of which were explained by drawings on the blackboard.

Mr. E. M. Nelson said he had listened with much interest to this paper, and was very pleased to find that original thought was being brought to bear upon this subject by one who said he was a beginner. There could be no doubt that camera lucida measurements, when made in the ordinary way as described, were grossly incorrect, and that the apparatus which had been devised to enable corrections to be made was most ingenious and thoroughly scientific in principle. He thought, however, that there was a much simpler method of obtaining true measurements, by projecting the image for a much longer distance than the usual 10 in.; if, for instance, it was projected to a distance of 5 ft. the curve would with so large a radius be practically reduced to a straight line and measurements could then be made with very great accuracy. The camera lucida and neutral tint reflector were rough and ready means and useful only for ready reference; where expense was not an object and correctness was of importance the eye-piece micrometer would best meet the requirements. It occurred to him that in using the ordinary camera lucida another element of error was introduced in consequence of the refraction which took place when rays passed through at an angle. As regarded the remarks made about the ruled lines in micrometers, it was quite true that the first methods adopted were open to some objection, but the ruling was now done so perfectly that it was possible to arrive at measurements even as small as $1/500,000$ in. with a far greater accuracy than could be attained with any machine. Fasoldt and others had ruled lines up to $1/200,000$ in. apart, though they had only been seen up to $1/100,000$. He had been very much interested in the description of this contrivance, which he thought would be very handy for rough measurements.

Mr. Michael said he had contended for many years that this question of curvature invalidated not only all camera lucida measurements, but all camera drawings as well, and for this reason he had long since abandoned the process and had used the eye-piece micrometer instead.

Mr. C. Beck said it might comfort some microscopists present who, after what had been said, felt inclined to throw away their camera

lucidas, to know that their results could always be corrected by tangent measurement.

Sir Walter Sendall said that was so, but then the tangent method could not be used unless they could first determine accurately the centre of the field.

Dr. Dallinger thought there could be no doubt as to the value of this ingenious contrivance for obtaining measurements within certain limits, but he thought it would require a very great deal of care to be able to use it successfully with high powers, and this partly on account of its weight, if made in brass as the specimen before them. If an apparatus like that had to be hung upon the tube of a Microscope used for high powers it would be necessary to have it made of aluminium or some other light material.

Sir Walter Sendall said that he recognized the value of this suggestion, which could easily be carried out as the principle involved was susceptible of modification in any way which would tend to increase its efficiency.

The Secretary read part of Messrs. W. J. Chadwick and W. Leach's paper on the "Leach Lantern Microscope," at the conclusion of which the authors gave a demonstration, showing upon the screen a number of polariscope and other objects.

The Secretary announced that arrangements had been made for holding their next *Conversazione* on the evening of Monday, November 30th; they were unable to secure the use of the room for a Wednesday evening.

The following Instruments, Objects, &c., were exhibited:—

Messrs. W. J. Chadwick and W. Leach:—Leach Lantern Microscope.

Mr. F. Chapman:—Foraminifera illustrating his paper.

Mr. W. Hutchinson:—Sections of Cotton.

Mr. E. M. Nelson:—*Navicula firma* under an oil-immersion 1/12.

Mr. C. Rousselet:—A new Rotifer, *Conochilus unicornis*.

Dr. H. Schroeder:—Photomicrographs of Herr J. D. Möller's Type-Slides of Diatoms.

Sir Walter J. Sendall:—Measuring Apparatus for Camera Lucida drawings.

New Fellows.—The following were elected *Ordinary* Fellows:—
Mr. Henry Crowther, Dr. Algernon W. Lyons, Dr. Frank Alvin Rogers.
Honorary Fellow:—Dr. Édouard Bornet, of Paris.

MEETING OF 18TH NOVEMBER, 1891, AT 20, HANOVER SQUARE, W.,
THE PRESIDENT (DR. R. BRAITHWAITE, F.L.S.) IN THE CHAIR.

The President having declared the meeting to be special, in pursuance of notice given at the preceding meeting, for the purpose of considering a proposed alteration in the Bye-laws,

Prof. Bell read the Minutes of the last special meeting convened for the same purpose on 17th December, 1890, and adjourned *sine die*. He reminded the Fellows that special meetings were also held for the consideration of the matter on October 22nd and November 19th, 1890, at which it was stated that in order to obtain for the Royal Medical and Chirurgical Society an exemption from the payment of rates to the parish in which the building was situated, it was necessary that the Societies occupying the various portions of the premises should be registered as Friendly Societies, under the Friendly Societies Act. To enable the Royal Microscopical Society to be so registered, it was necessary to make an addition to their present Bye-laws, to provide that the Society should not make any gift from its funds for the private use of any person, in the terms stated in the resolution which was drawn up at the special meeting in October in the form of a new Bye-law, to be inserted immediately after Bye-law No. 53, and to be designated No. 54, which new Bye-law it was proposed to submit to the present meeting for acceptance. The difficulty in the way of the Council when this question arose, lay in the fact that on the part of both landlord and tenant mistakes had been made at the time the lease was granted, and when its terms came up for review it was thought desirable to get these matters adjusted if it was possible to do so. With this end in view, he, in connection with the late Mr. Mayall, had an interview with the Secretaries of the Royal Medical and Chirurgical Society just before the recess, at which certain propositions and requirements were submitted on behalf of the Council as conditions on which the request to register the Society might be undertaken. The result of that interview was that, with a few exceptions, their requirements were complied with, those which were excepted being such as it was quite expected by the Council that the Royal Medical and Chirurgical Society would be unable to grant. Seeing, therefore, that they had been met in that way, and also that most other Scientific Societies were now for the same reason registered under the Friendly Societies Acts, he thought their concurrence in the matter should be given.

The President having formally moved the adoption of the proposed new Bye-law, was about to put it to the meeting, when

Mr. J. M. Allen said he thought before the Fellows of the Society committed themselves to such a proceeding they ought to understand the exact position in which the matter stood. There had been a great deal of correspondence between the late Mr. Mayall and the Royal Medical and Chirurgical Society on the questions involved, and Mr. Mayall, at length, in a letter dated November 13th, had formulated their requirements under distinct heads which were as follows:—1. That their access to the rooms was too limited, and that they wanted to be able, as at King's College, to meet in their Library on Wednesday evenings from 6 to 11 o'clock. 2. That on their two Conversational Evenings they

wanted the use of the North Room as well as the large Meeting Room. 3. That tables should be provided for them on these occasions. 4. That in case of alteration as to present terms of heating, a coal-cellar should be provided. 5. That they should have the use of the kitchen for their caterer on the evenings of meetings. 6. That two electric table-lamps should be provided for the use of Fellows who might want to use Microscopes in the Library. 7. That they should be allowed to fix a plate at the door with the name of the Society on it. He believed that the Royal Medical and Chirurgical Society had only agreed to some of the less important of these requests. With regard to the use of their own rooms on Wednesdays from 6 to 11, they were in future to be entitled to do so. If they wanted the use of the North Room they were told they must pay for it. Tables made up of trestles would be provided. The agreement as to coals, whatever that might be, was to be endorsed upon the lease. The use of the kitchen was declared to be impossible, in fact there seemed to be some objection even to their boiling water in a kettle. Leave was given to attach to wall-plugs lamps provided by the Royal Microscopical Society, but as there were no wall-plugs, who was to fix them? And in the matter of the door-plate, it was absolutely refused. He would suggest that the meaning of this was that whilst the Royal Medical and Chirurgical Society asked them to give what was equivalent to about 30*l.* a year, they said, we will give you in return what costs us nothing, but if you want anything more you must pay for it; and he thought before they passed the resolution before them they should obtain the use of the North Room, and as regarded the door-plate they should at least obtain an undertaking that in the event of any other Society being allowed to fix a plate outside, the same permission should be accorded to the Royal Microscopical Society. Another thing he should also like to mention, and that was the lavatory in the passage on the ground-floor was persistently kept closed against the Fellows of the Society, any one requiring to use it having to go up to one on the second floor instead.

The President said if plates were put up outside for each Society there would be six wanted.

Prof. Bell said that the terms proposed by Mr. Allen as to the name-plate were really the same as already understood, because the only reason for refusal was the fact that they had already refused others.

The President thought it was really such a trivial thing that it was hardly worth while to make a difficulty of it.

Dr. Dallinger said that the whole of the points raised by Mr. Allen had been before the Council, and had been very fully discussed, many of them during the lifetime of Mr. Mayall. He remembered that with regard to the name-plate it was specially stated that no plate except that of the parent Society would be permitted. All their requests beyond this, which it was possible to grant, were acceded to except as to the use of the North Room, and it should be remembered that these were all made beyond the actually signed agreement already entered into. They were asking what they did simply because an unfortunate omission from the deed enabled them in some measure to reopen the question as to its terms, but he thought they ought not to strain the matter to the extent of taking what might be an unfair advantage of

what was after all a mistake. Everything had been fully discussed by the Council, and they had come to the conclusion that the Society would be right to close the matter as it now stood. He had been present during the discussion of these questions, and though he did not perhaps take quite the same interest in them then as he should in the position he at present occupied, he thought Prof. Bell had put the matter very fairly before them.

Mr. Allen only wished them to act as men of business, quite irrespectively of other considerations, and he did not see why they could not be men of business as well as members of a scientific Society. His point was that when the Royal Medical and Chirurgical Society said to them "Give us 30*l.* a year," they should say in reply, "Give us a *quid pro quo*."

Mr. T. H. Gill said it was certainly a very great inconvenience to have the lavatory closed against them; he hoped that might be remedied.

Prof. Bell said, with regard to the question of giving 30*l.* a year, there was no doubt that the Royal Medical and Chirurgical Society made a great mistake in agreeing to pay their rates and taxes without inquiring first whether they were registered as a Friendly Society, and for that mistake they had to pay somewhat heavily, but if it was possible to save them this expense without it costing their own Society anything he thought they might fairly do so, and that it was putting the matter a little strongly to say the Royal Medical and Chirurgical Society wanted in exchange for this sum to give what cost it nothing. As the question of the terms of the lease was raised, they had raised some questions which had on their part also been overlooked, but with regard to the North Room the reply they got was quite a natural one. It was said, "When we gave you your lease that room was not built, and we did not decide to build it until afterwards; it is an exceedingly useful room to us, we get three guineas a night for it, and if you want it in addition to the others you must pay for it." The use of the kitchen was found to be impossible—it was a part of their library, and he believed, for that reason they could not use it themselves. With regard to the door-plate they took it to be impossible for the reason already stated, and if some of the Fellows of the Society would walk upstairs they would probably see why it was that some of the occupants should not have plates put up.

The President having put the motion to the Meeting declared it to be carried.

The following were the terms of the resolution:—That the Bye-laws of the Society be altered as follows, viz.:—By inserting immediately after Bye-law 53, the following Bye-law to be numbered 54:—

The Society shall not make any dividend, gift, division, or bonus in money unto or between any of its members,

and to renumber all subsequent Bye-laws.

This concluded the business of the special meeting.

The ordinary meeting having been constituted,

The Minutes of the meeting of 21st October last were read and confirmed, and were signed by the President.

The List of Donations (exclusive of exchanges and reprints) received since the last meeting was submitted, and the thanks of the Society given to the donors.

	From
Carpenter, W. B., <i>The Microscope and its Revelations</i> . Seventh edition, pp. xviii. and 1099, 21 pls., text illust. (8vo, London, 1891)	<i>Dr. W. H. Dallinger.</i>
Gage, S. H., <i>The Microscope and Histology</i> . Part i., third edition. (8vo, Ithaca, N.Y., U.S.A., 1891)	<i>The Author.</i>

Prof. Bell called special attention to a book which he felt sure all would be glad to see, but which at first sight they would probably fail to recognize even if they looked inside it. This was a copy of the seventh edition of 'The Microscope and its Revelations.' They would find on examination that, although Dr. Carpenter's text had been preserved so far as his own special work was concerned, there was much at the beginning of the book which was new, which in fact Dr. Carpenter did not know, for the reason that many of the matters treated of had not been brought to a conclusion at the time the previous editions of the work were published; so that in the present edition it would be found that the first seven chapters were practically new, containing as they did the results of Dr. Dallinger's researches, and also a succinct and perfect account of the work of Prof. Abbe in connection with his theory of microscopical vision. Dr. Dallinger was rather inclined to undervalue his own powers, and had therefore asked Dr. Abbe to write that portion of the book, but—he was going to say fortunately for them—the state of Dr. Abbe's health prevented him from undertaking this task, so that Dr. Dallinger had himself taken it in hand, with a success which had called forth the approval of Dr. Abbe in terms which Dr. Dallinger spoke of as being more than generous. Of course it would be of great value to have Dr. Abbe's views put before them in a lucid manner which all would be able to understand, and on this ground alone Dr. Dallinger had done them a great service; but the book was also improved in many ways besides, and it would be found to contain an enormous number of new pictures in illustration. What, however, struck him more than anything else was the last part of the preface, which read as follows:—

“There certainly never was a time when the Microscope was so generally used as it now is. With many, as already stated, it is simply an instrument employed for elegant and instructive relaxation and amusement. For this there can be nothing but commendation, but it is desirable that even this end should be sought intelligently. The social influence of the Microscope as an instrument employed for recreation and pleasure will be greater in proportion as a knowledge of the general principles on which the instrument is constructed are known, and as the principles of visual interpretation are understood. The interests of these have been especially considered in the following pages, but such an employment of the Microscope, if intelligently pursued, often leads to more or less steady endeavour on the part of amateurs to understand the instrument and use it to a purpose in some special work, however modest. This is the reason of the great increase of Clubs and Societies

of various kinds, not only in London and in the provinces, but throughout America; and these are doing most valuable work. Their value consists not merely in the constant accumulation of new details concerning minute vegetable and animal life, and the minute details of larger forms, but in the constant improvement of the quality of the entire Microscope on its optical and mechanical sides. It is largely to amateur microscopy that the desire and *motive* for the great improvements in object-glasses and eye-pieces, for the last twenty years are due. The men who have compared the quality of respective lenses and specific ideas as to how these could become possessed of still higher qualities, have been comparatively rarely those who have employed the Microscope for professional and educational purposes. They have the rather simply *used*—employed in the execution of their professional work—the best with which the practical optician could supply them. It has been by amateur microscopists that the opticians have been incited to the production of new and improved objectives. But it is the men who work in our biological and medical schools that ultimately reap the immense advantage—not only of greatly improved, but in the end greatly cheapened, object-glasses. It is on this account to the advantage of all that the amateur microscopist should have within his reach a handbook dealing with the principles of his instrument and his subject.”

The President thought this was a very valuable book, which the “amateurs” would find to be a means of great help in the course of their studies.

Prof. Bell also called attention to another work, entitled ‘The Microscope in Histology,’ by Prof. S. H. Gage, which had reached its third edition, and was perhaps more satisfactory than most books of its kind.

Mr. C. Lees Curties exhibited and described a small heliostat made on the lines laid down by Mr. Comber. It would be found both simple and effective, and was adapted for use in any latitude between 15° and 70°.

Mr. J. W. Gifford read a short paper “On the Mounting of *Amphipleura pellucida*.”

The President expressed the thanks of the Society to the author for his communication.

Mr. E. M. Nelson said it would be remembered that some discussion took place at their last meeting as to the value of drawings made with Dr. Beale’s neutral tint reflector, and to test the matter more closely, he had made a drawing of the ten lines on a micrometer scale of 1/100 mm. under an apochromatic objective giving a magnifying power of $\times 850$. It was not possible to draw more than five or six of these lines at one time, but he had indicated the relative position of these by dots upon paper, and found that as measured with an ordinary rule they showed a very slight displacement. He therefore came to the conclusion that the Beale’s neutral tint reflector was a very good thing for the purpose of

drawing objects, although for accurate measurements it was perhaps not to be recommended.

Mr. Nelson exhibited and made some remarks on a new Microscope by Mr. C. L. Curties. He began by remarking that for many years he had been strongly of opinion that the favourite Continental model, viz. that known as the Hartnack, was a design that was radically bad in many ways. The goal he aimed at was that our laboratories and schools should be furnished with Microscopes built on thoroughly sound scientific design, and of good English workmanship, instead of those built, as we may say, on haphazard design, with which, as every good microscopist knows, critical work is simply impossible.

To this end he had had, at various times, no less than three Microscopes built, each embodying various improvements. The frequent exhibition of the first of these Microscopes, both at this Society and at the Quekett Microscopical Club, bore fruit, and English Hartnacks with rack-work coarse-adjustment became common. Later still this improvement was adopted on the Continent.

The instrument exhibited had quite a novel origin. Some time ago Mr. Curties received an anonymous letter containing suggestions for the improvement of the model. These were adopted and embodied in this instrument. First, it is in all its parts of large size. The base is more extended and its height has been raised. (With regard to the size of a Microscope, Mr. Nelson suggested that it should be estimated by its height when in a horizontal position, a full-sized Microscope being one whose axis, when horizontal, is 10 in. from the table). It has a mechanical stage 5 in. in diameter, with $8/10$ in. rectangular movement, and with complete rotation. The substage has rectangular and coarse and fine adjustments. The body extends from $5\frac{1}{2}$ –12 in. Spiral rackwork is fitted to the coarse-adjustments of both the body and substage and the draw-tube. Both the fine-adjustments have the Campbell differential screw. The body fine-adjustment is placed in front of the coarse-adjustment, so that it only carries the body. One of the new features is the solid Jackson limb which carries both the body and substage. The lower stage-plate is of great thickness and is firmly secured to brackets on the limb. The instrument is very massive and weighs 17 lbs.

Rigid economy has been studied in the production of this instrument, so that all movements which are not considered essential in a full-sized instrument have been left out, such as rackwork and centering gear to the rotating stage, rotation to the substage, &c. If this were put forward as an ideally perfect instrument there are several points one would criticize, but taking the instrument for the purposes intended, he thought it eminently serviceable, and one with which excellent photomicrographic work could be done.

Dr. Dallinger said he had examined this instrument, and was so much in accord with what Mr. Nelson had stated that any remarks of his own would only be a repetition of what had been already said. The best means had been here adopted to make a thoroughly good instrument at a comparatively low price.

Mr. Nelson also explained, by means of blackboard drawings, some

improvements made in his apparatus for the production of pure monochromatic light for use with the Microscope.

The thanks of the meeting were voted to Mr. Nelson for his communications.

The Secretary read a letter of acknowledgment from M. Édouard Bornet, of Paris, on the receipt of the announcement that he had been elected at the last meeting an Honorary Fellow of the Society.

Mr. A. W. Bennett gave a *résumé* of his paper "On the Freshwater Algæ of South-west Surrey," describing, amongst others, some six or eight new species found during his recent vacation in the neighbourhood of Haslemere and Hindhead, drawings of which were made upon the blackboard in illustration of the subject.

The President expressed the indebtedness of the Society to Mr. Bennett for his very interesting communication, which was just the kind they wanted. The advantage of working steadily on at the same subject was abundantly shown here by the fact that he had succeeded in adding several new species to those already known. His observations on the life-history of these things were also very interesting, especially the little notes on the way in which they carried out their life in its reproductive and sporing processes. They were specially glad to get papers of this kind from Mr. Bennett upon what was in this country a rather neglected subject, and he ventured to express the hope that as further opportunities occurred he would continue his observations.

Prof. Bell said they had also received a paper from Dr. Alfred C. Stokes, descriptive of a number of new species of American Infusoria, which would be taken as read, and would appear in the Journal in due course.

The President reminded the Fellows that the Society's Conversation would take place on November 30th as already intimated.

The following Instruments, Objects, &c., were exhibited:—

Mr. C. Lees Curties:—Heliostat for Microscopic work. An improved form of Microscope.

Mr. J. W. Gifford: *Amphipectura pellucida* under Monochromatic Light.

New Fellows:—The following were elected Ordinary Fellows:—Dr. J. Adolphi Gottlieb, Dr. Edward Gray, Dr. J. Leffingwell Hatch, Messrs. William C. Krauss, John A. Miller, Frederick William Mills, Dr. Walter N. Sherman, and Mr. Ernest Edward Wells.

INDEX OF NEW BIOLOGICAL TERMS, OR OLD TERMS WITH
NEW MEANINGS, RECORDED IN THIS VOLUME.

a. ZOOLOGY.

- Achelata, Sars, G. O., 186.
 Acoelomata, Schimkewitsch, W., 452.
 Actinogonidiate, Bell, F. J., 603.
 Actinopoda, Ludwig, H., 478.
 Agamobium, Parker, T. J., 173.
 Anactinogonidial, Bell, F. J., 603.
 Anæmaria, Schimkewitsch, W., 452.
 Apelmatozoic, Bell, F. J., 603.
 Archentomon, Fernald, H. T., 30.
 Astrocentre, Fol, H., 447.
 Azygopodous, Bell, F. J., 604.
 Benthos, Haeckel, E., 326.
 Bilateria, Schimkewitsch, W., 452.
 Caliculata, Bell, F. J., 604.
 Calymmocytes, Salensky, W., 178.
 Chordal-entoblast, Kollmann, J., 22.
 Chromatophores (sens. nov.), Schneider, C. C., 580.
 Clasmatocytes, Ranvier, L., 323.
 Cryptochelata, Sars, G. O., 186.
 Cyanophil, Auerbach, L., 324.
 Cycloneura, Schimkewitsch, 48.
 Cytogenic, Auerbach, L., 324.
 Eleutherozoa, Bell, F. J., 603.
 Erythrophil, Auerbach, L., 324.
 Euannelids, Roule, L., 328.
 Euchelata, Sars, G. O., 186.
 Eucoelomata, Schimkewitsch, W., 452.
 Eulamellibranchiata, Pelseener, P., 583.
 Eumollusca, Roule, L., 328.
 Filibranchiata, Pelseener, P., 583.
 Gamobium, Parker, T. J., 173.
 Gastroneura, Schimkewitsch, 48.
 Gastrula-ridge, Hubrecht, A. A. W., 317.
 Hæmataria, Schimkewitsch, W., 452.
 Hæmatopoetic plexus, Van der Stricht, O., 579.
 Hæmosteatic tissue, Graber, V., 587.
 Haliplankton, Haeckel, E., 326.
 Hypotropic, Brauer, A., 610.
 Incaliculata, Bell, F. J., 604.
 Karyogenic, Auerbach, L., 324.
 Leucoblasts, Van der Stricht, O., 579.
 Limnoplankton, Haeckel, E., 326.
 Mitosoma, Henking, H., 461.
 Monomeria, Roule, L., 328.
 Monozoa, Schimkewitsch, W., 452.
 Nekton, Haeckel, E., 326.
 Neoblasts, Randolph, H., 470.
 Notoneura, Schimkewitsch, 48.
 Nucleogenous bodies, Packard, A. S., 466.
 Oenocytes, Wielowiejski, 587.
 Ovocentre, Fol, H., 447.
 Paractinopoda, Ludwig, H., 478.
 Parapedal commissure, Bouvier, E. L., 329.
 Placenta bidiscoidalis typica, Placenta bidiscoidalis circumvallata, Placenta monodiscoidalis, Selenka, E., 316.
 — plexiformis, cavernosa, per appositionem, Klebs, E., 448.
 Placental heart, Klebs, F., 448.
 Plankton, Hensen, V., 326.
 Plasmosomata, McCallum, A. P., 450.
 Plastid blood, Minot, C. S., 25.
 Polymeria, Roule, L., 328.
 Polyzoa (sens. nov.), Schimkewitsch, 452.
 Pregastric mesoderm, v. Davidoff, M., 334.
 Premollusca, Roule, L., 328.
 Protegulum, Beecher, C. E., 336.
 Pro-teloblast, Wilson, E. B., 190.
 Protobranchiata, Pelseener, P., 583.
 Protochordal plate, Hubrecht, A. A. W., 317.
 Pseudannelids, Roule, L., 328.
 Pseudemboly, v. Davidoff, M., 334.
 Pseudocoelomata, Schimkewitsch, W., 452.
 Pseudocones, Patten, W., 32.
 Pseudolamellibranchiata, Pelseener, P., 583.
 Pseudonematophores, Wagner, J., 52.
 Radiata (sens. nov.), Schimkewitsch, W., 452.
 Rhyncota (sens. nov.), Roule, L., 328.
 Sarcomere, Schäfer, E. A., 587.
 Sarcostyles, Schäfer, E. A., 587.
 Septibranchiata, Pelseener, P., 583.
 Sero-amniotic connection, Mitsukuri, K., 22.
 Spermocentre, Fol, H., 447.
 Statozoa, Bell, F. J., 603.

- Teloblast, Wilson, E. B., 190.
 Tetraneura, Schimkewitsch, 48.
 Trichelminthes, Schimkewitsch, W., 452.
 Trochozoa, Roule, L., 327.
 Trophoblast, Hubrecht, A. A. W., 317.
 Velata (sens. nov.), Roule, L., 328.
 Zoonite, Malaquin, A., 195.
 Zygotodous, Bell, F. J., 603.
- β. BOTANY.**
- Acinetæ, Kjellman, 225.
 Alexin, Buchner, 790.
 Amphitricha, Messea, 638.
 Ascorhizæ, Vuillemin, 779.
 Aspergillin, Linossier, 486.
 Astelic, Van Tieghem, 224, 363.
 Attractive Sphere, 614.
 Autogenetic Fertilization, Körnicke, 494.
 Auto-nyctitropic, Koch, 373.
 Auxanogramme, Beyerinck, 800.
 Basidiorrhizæ, Vuillemin, 779.
 Bast-collenchyme, Müller, C., 60.
 Coniocarpæ, Wainio, 230.
 Ctenocladieæ, Borzi, 631.
 Cyclocarpæ, Wainio, 230.
 Cyclosporeæ, Kjellman, 225.
 Cyclosporinæ, De Toni, 629.
 Defensive Proteids, Hankin, 790.
 Dialydesmic, Van Tieghem, 224, 376.
 Digestive Pocket, 62.
 Directing Leucite, Van Tieghem, 615.
 Directing Sphere, Guignard, 614.
 Discolichenes, Wainio, 230.
 Dust-brand, 781.
 Epiphytoid, Johow, 70.
 Euphytoid, Johow, 70.
 Exoneurosis, Clos, 364.
 Fibrolem, Fayod, 757.
 Folded Tissue, 617.
 Fungoid (sens. nov.), Johow, 70.
 Gamodesmic, Van Tieghem, 224, 376.
 Gasterorrhizæ, Vuillemin, 779.
 Geo-nyctitropic, Koch, 373.
 Gymnobacteria, Messea, 638.
 Gynocratæ, Kjellman, 225.
 Hard-bast-cell, Heineck, 794.
 Hemiasci, Brefeld, 633.
 Heterogenetic Fertilization, Körnicke, 494.
 Hymenorrhizæ, Vuillemin, 779.
 Isogoniæ, Kjellman, 225.
 Lactase, Beyerinck, 374.
 Lianoid, Johow, 70.
 Lindau's Cells, Mäule, 782.
 Lophotricha, Messea, 638.
 Lower pigment (chlorophyll), Monteverde, 758.
 Macrogametes, Goroschankin, 632.
 Macropodous (embryo), Clos, 763.
 Medullary Phloem, Héraul, 489.
 Megagametes, Bennett, 632.
 Metacollenchyme, Müller, C., 61.
 Meteor-paper, 777.
 Mettenian Gland, 62.
 Microgametes, Goroschankin, 632.
 Monostelic, Van Tieghem, 224.
 Monotricha, Messea, 638.
 Mycodomatia, Frank, B., 779.
 Myco-phyloxin, Hankin, 791.
 Mycoplasma, Frank, B., 639.
 Mycorrhizome, Vuillemin, 779.
 Myco-sozin, Hankin, 791.
 Parorthotropism, Arcangeli, 497.
 Peridesm, Van Tieghem, 363.
 Peritricha, Messea, 638.
 Phæozosporinæ, De Toni, 629.
 Phloem-island, 620.
 Phylaxin, Hankin, 791.
 Plasome, Wiesner, 207.
 Plastic Aliment, Beyerinck, 800.
 Plastic Nutriment, Beyerinck, 800.
 Pneumatophore, Karsten, 621.
 Politropism, Arcangeli, 497.
 Primordia (sens. nov.), Lindau, 782.
 Primordial Leaf, 65.
 Proteids, Defensive, Hankin, 790.
 Proto-sclerenchyme, Müller, C., 61.
 Pseudo-cleistogamic, Hansgirg, 372.
 Pyrenolichenes, Wainio, 230.
 Rhizocarpous, Huth, 491.
 Sanio's Bands, Müller, C., 488.
 Semi-lichen, Zukal, 382.
 Sozin, Hankin, 791.
 Spheroid-cell, Zukal, 383.
 Spirofibril, Fayod, 757.
 Spirospart, Fayod, 757.
 Stegmata, 223.
 Tetrasporinæ, De Toni, 629.
 Tinoleucite, Van Tieghem, 615.
 Tissu plissé, Van Tieghem, 617.
 Toxo-phyloxin, Hankin, 791.
 Toxo-sozin, Hankin, 791.
 Trichobacteria, Messea, 638.
 Uterior Pith, Fremont, Mlle. A., 619.
 Upper pigment (chlorophyll), Monteverde, 758.
 Vaginaricæ, Gomont, 234.
 Wicker-hair, Correns, 216.
 Xanthophyllidrine, 60.
 Zoogoniæ, Kjellman, 225.

INDEX.

A.

- Abdominal Appendages of Insect Embryos, 730.
 Abnormal Structure of Annual Rings, 487.
 Absorption of Fatty Oils, 771.
 — of Solid Substances by Cells, 770.
 — — — by Protoplasm, 58.
 Abundo, G. d', Demonstrating Cerebral Vessels of Mammalia, 547.
 Aby. F. S., Method of Imbedding Delicate Objects in Celloidin, 424.
 Acanthocephala, 741.
Acanthodrilus, Anal Nephridia in, 347.
 Acari, New Genus of Leaping, 185.
 Acarida, Post-embryonic Development of, 732
 Acarina, Mounting, 421.
Acer platanoides, Abnormal Germination of, 69.
 Acetic Fermentation, Action of Light on, 513.
 Achard, —, Colour and Pathogenic Differences of *Staphylococcus pyogenes aureus* and *S. albus*, 82.
 — Osteomyelitis and Streptococci, 243.
Achorion Arloini, 784.
 Acid-formation by Bacteria, 82.
 Acids, Method for Demonstrating the Formation of, by Micro-organisms, 685
Acineta æqualis, 703.
 — *pyriformis*, 704.
 Acœlous Turbellaria, Organization, 599.
 Acorn, Variations in Structure of, 64.
 Aqua, C., Structure and Growth of Cell, 757.
Acridium peregrinum, Parasite of, 636.
 Actiniæ, Methods of Narcotizing, 685.
 Actinian, *Protanthea*—a new, 479.
 Actinomyces, Cultivating, 416.
Actinosphaerium, Gigantic Specimens, 55.
 Actinozoa, Phylogeny of, 606.
 Adametz, L., *Bacillus lactis viscosus*, 801.
 — Ripening of Cheese, 389.
 Adami, —, Phagocytosis, 793.
 Adelaide River, Estuarine Foraminifera of Port, 356.
Æcidium esculentum, 232.
Æcidium Schweinfurthii, 78.
 Africa, Earthworm collected in Equatorial, 161, 558.
 African Coast, Work of Earthworms on, 40.
 — Myrmecophilous Plants, 626.
 Agar and Gelatin, Substitutes for, 824.
 —, Apparatus for filtering Clear, 131.
 —, Meat-Pepton, Simplified Method for preparing, 416.
 —, Preparing Nutrient, 416.
 —, Preparing Pepton-, for Studying Pyocyanin, 534.
 Agardh, J. G., New Siphonæ, 227.
 —, *Sargassum*, 75.
 Agassiz, A., *Calamocrinus Diomedæ*, 202.
 —, Rate of Growth of Corals, 51.
Agelena labyrinthica, Oviposition and Cocoon-weaving, 731.
 Agriculturists, Bacteriology for, 86.
 Aitken, J., Spot Mirror Method of Illumination, 430.
Albua, Pollination and Hybridizing, 769.
 Albumen-Glycerin Fixative, Deterioration of Mayer's, 428.
 Albuminoids, Formation of, 72.
 Alciopid, New, 39.
 Alcoholic Fermentation and Conversion of Alcohol into Aldehyde by "Champignon du Muguet," 773.
 Alcyonacea, Mode of Examining Calcareous Bodies of, 422.
 — of Bay of Naples, 353.
 Alcyonaria, Fissiparity in, 354.
 — from Port Phillip, 51.
 Alcyonarian, New, 750.
 Aldehyde, Conversion of Alcohol into, by "Champignon du Muguet," 773.
 Aleurone Grains in Papilionaceæ, 615.
 —, Preparation of, 278.
 Algæ, See Contents, xxvii.
 —, Culture of Terrestrial, 829.
 —, Green Unicellular, Pure Cultivations of, 130.
 —, Re-softening dried, 829.
 —, Symbiosis of, and Animals, 385.
 Alkali-formation by Bacteria, 82.
 Alkaloid-receptacles of Fumariaceæ, 618
 Alkaloids, Tests for, 148.

- Allantonema*, 43.
 Allen, J. M., 842.
Allopora, Gonophores of, 608.
 —, Male Gonangia of, 481.
 Almqvist, E., *Pemphigus neonatorum*, considered from the Bacteriological and Epidemiological points of view, 803.
 Alveolæ, Leaves of, 66.
 Althoefer, —, Disinfecting Property of Peroxide of Hydrogen, 799.
 Altmann's, P., Thermoregulator, 651.
 Amann, —, Use of Polarized Light in Observing Vegetable Tissues, 429.
 —, J., Effect of the Koch Treatment on Tubercle Bacilli in Sputum, 511.
 Amber, Fauna of, 174.
 Ambrosin, H., Optical Characters of Medullated and Non-medullated Nerve-Fibres, 325.
 American Lobster, Development of, 468.
 — Rotifer, New, 49.
 — Society of Microscopists, Meeting, 821.
 — — — —, Report on Uniformity of Tube-length, 87.
 — Spiders, 464.
 — Terrestrial Leech, 42.
 Amœboid Cells in Crab's Blood, 37.
 — Protoplasm, Structure of, 450.
 Amphibia, Impregnating Brain of, by Golgi's Method, 426.
 —, Myoparasites of, 358.
 —, Preparation of Embryos, 827.
 —, Preparing Nervous Tissue of, 420.
 —, Pronephros and Segmental Duct in, 711.
 Amphibians, Red Blood-corpuscles, 324.
 Amphicarpous Fruits, 491.
Amphileptus flagellatus, 55.
Amphioxus, Larval Development of, 319.
Amphipleura pellucida, 555.
 Amphipoda, Dimorphism of Male, 187.
 Amphipods, New British, 594.
 Amplifying Power of Objectives and Oculars in Compound Microscope, 114.
 Ampullæ of *Millepora Murrayi*, 480.
 Anabiosis, 173.
 Anæmia, Pernicious Parasitic Origin, 47.
 Anaerobic Microbes, Apparatus for Cultivating, 274.
 Anæsthetics, Influence on Assimilation and Transpiration, 373.
 —, — on Respiration, 221.
 Ancient Lenses, 251.
 André, G., Sulphur in Plants, 616.
 Andrews, E. A., Anatomy of *Sipunculus Gouldi*, 42.
 —, Distribution of *Magelona*, 740.
 —, Eyes of Polychæta, 738.
 —, Reproductive Organs of *Diopatra*, 595.
Anemone nemorosa, Pigment of the Synchronium of, 60.
 Angelini, —, Biological Cycle of *Hamatozoon falciforme*, 755.
 Angling and Microscopy, 129.
 Anilin Dyes, Characteristics of some, 551.
 — — —, Impregnation of Bone Sections with, 147.
 — — — Pigments, Antiseptic Value of, 798.
 — — —, Hints on Preparation of Tumours injected during life with, 548.
 Animal Chlorophyll, 717.
 — Kingdom, Classification of, 452.
 Animals, Symbiosis of Lægæ and, 224.
 —, Tumours in, 242.
 Annelida. See Contents, xv.
 Annual Rings, Abnormal Structure, 487.
 — — —, Formation of, 761.
Anodon, 455.
 Antennæ in *Myrmedonia*, Function, 181.
 Antennary Gland of *Lucifer Reynaudii*, 735.
 Antherids of *Catenella Opuntia*, 502.
 — *Lomentaria*, 628.
 Anthozoa, Organization and Development of, 353, 749.
 Anthracnose of Pepper, New, 506.
 Anthrax Bacilli, Destruction of, in the Body of White Rats, 83.
 —, Growth of Bacillus of Symptomatic, 239.
 —, Immunity to, 795, 796.
 — Vaccination, 797.
Anticoma, 472.
 Antipatharia, 480.
 Antipodals, Function of, 766.
 Antiseptic Value of Anilin Pigments, 798.
 Antitoxic Power of Animal Organism, 645.
 Antolisei, —, Biological Cycle of *Hamatozoon falciforme*, 755.
 Ants, Can they hear? 182.
 —, Parthenogenesis of, 182.
 Antwerp, International Exhibition at, 271, 296, 300, 820.
Anuræa pro-curea, 305.
 — *scutata*, 306.
 Aortic Valves of Lamellibranchs, 584.
 Apáthy, S., Demonstrating Tactile Papillæ of *Hirudo medicinalis*, 540.
 Apes, Development of, 316.
 Apex in Gymnosperms, Structure and Growth, 760.
 Apical Growth of Hepaticæ, 627.
 — — *Osmunda* and *Botrychium*, 500.
 — — Prothallium of Ferns, 627.
 — System of Echinoids, 748.
Apolema, 742.
 Apochromatic Objective, The new, 248.
 Apocynaceæ, Structure of, 63, 489.
 Apodidæ, Hermaphroditism of, 188.
 Appellér, A., Notes on Cephalopods, 25.
 Appendicular Organs, Independence of Fibro-vascular bundles in, 364.
 Apstein, C., A new Aleciopid, 39.
 Aquatic Earthworms, 348.

- Aquatic Plants, Rudimentary Stomates, 367.
 Arabian Nematodes, 349.
 Araceæ, Fertilization of, 68.
Arachnactis, Development of, 354.
 Arachnida. See Contents, xiii.
 Arachnids, Extremities of Embryo, 458.
Araneina, Development of, 463.
 Arbaumont, J. d', Integuments of Seed of Cruciferae, 492.
Arca, Circulation in, 726.
 Arcangeli, G., Compass Plants, 496.
 —, Crypto-crystalline Calcium oxalate, 616, 759.
 —, Fertilization of Araceæ, 68.
 —, Leaves of Nymphaeaceæ, 64.
 Archegone of Ferns, 499.
 'Argo,' Biological Results of Cruise, 454.
 Aristolochia, Pollination of, 216.
 Arloing, S., Elementary Course of Anatomy and Histological Technique, 415.
 —, Extinction of Epidemics, 391.
 Aronson, H., Colloidal Clay for Filtering Fluids containing Bacteria, 835.
 Arsouval's, A. d', Apparatus for maintaining fixed Temperature, 682.
 —, Filtration and Sterilization of Organic Fluids by liquid carbonic acid, 682.
 Artari, A., Development of *Hydrodictyon*, 380.
Artemia fertilis, 557.
 Arterial System of Crustacea, 466.
 — of Isopods, 736.
Arthonia, 505.
 Arthropoda. See Contents, xii.
 Arthropods, Preparing Epithelium of Mid-gut, 828.
 Arthus, M., On Glycolytic Ferment, 803.
 Ascherson, P., Dissemination of Seeds of *Harpagophyton*, 69.
 Ascidian, Compound, new type of, 727.
 — Ova, Improved Method of preparing, 140.
 Ascidians, Compound, Pœcilogony in, 332.
 —, Origin of Test-cells of, 29.
 Ascidicolous Copepoda, Development, 188.
Ascomycetes, 228, 633.
 —, *Bargellinia*, New Genus of, 382.
 Ascothoracida, New form of, 189.
Asellus aquaticus, Oviposition and Fertilization in, 187.
 Ash, Reserve receptacles in Buds of, 212.
 Asparagin, Influence of Carbohydrates on Formation of, 497.
 Aspergillin, A Vegetable Hæmatin, 486.
Asplanchna amphora, Vibratile Tags, 201.
 Assimilation and Transpiration, 770.
 — by Red Leaves, 71.
 — in Plants, 71.
 — in Lichens, 634.
 — in Umbelliferae, 770.
 — of free Atmospheric Nitrogen, 771.
 — of Leaves, 496.
 Assimilation of Plants, Influence of high altitudes on, 71.
Astellium spongiforme, Blastogenesis, 332.
 — —, Budding of Larva of, 332.
Asterias, British Species of, 479.
 — *vulgaris*, Embryology of, 476.
Asteroides calcularis, Invagination of Tentacles in, 51.
Asterophyllites, 73.
 Atavism of Plants, 626.
Atichia, 505.
 Atkinson, G. F., Black-rust of Cotton, 506.
 —, New *Ramularia* on Cotton, 78.
 —, Tubercles on Roots of *Ceanothus*, 766.
 Atlantic Halocyprides, 344.
Atlantonema rigidum, 196.
 Atmosphere of Plants, Composition of internal, 497.
 Atmospheric Nitrogen, Assimilation of, 771.
Atopos, 724.
 Attenuation of Bacillus of Tetanus, 799.
 Attraction-Spheres and Central Bodies in Tissue and Migratory Cells, 322.
 —, Central Corpuscles and, 715.
 — in Cœlomic Cells, 715.
 —, in Vegetable Cells (Tinoleucites), 614.
 Atwater, W. O., Absorption of Atmospheric Nitrogen by Plants, 496.
 Aubert, A. B., Reference Tables for Microscopical Work, 142, 279, 692.
 —, E., Distribution of Organic Acids in Succulent Plants, 208.
 Auerbach, L., Demonstrating Membrane of Red Corpusele of Batrachia, 419.
 —, Difference between Nuclei of Male and Female Reproductive Organs, 714.
 —, Red Blood-corpuseles of Amphibians, 324.
 —, Two kinds of Chromatin, 324.
Aulacomitrium—new Genus of Mosses, 776.
Auliscus, 785.
Aurelia, Scyphostoma of, 203.
 Autolytæ, Reproduction of, 195.
 Axial Angle Apparatus, 395.
 Axis-cylinder of Nerves, New Methods for Staining with Hæmatoxylin, 425.
 Axis-cylinders, Upson's Gold-staining Method for, 425.

B.

- Baccarini, P., Secretory System of Pappilionaceæ, 617.
 Bachmann, E., Calcareous Lichens, 383.
 Bacilli, Anthrax, Destruction of, in the body of White Rats, 83.
 —, Cholera, Red Nitro-indol Reaction as Test for, 242.

- Bacilli, Leprosy, from living Lepers, 830.
 —, Staining, 146.
 —, Tubercle, Colourability of, 690.
 —, —, Effect of Koch Treatment on, in Sputum, 511.
 —, —, Estimation of number in Phthisical Sputum, 833.
 —, —, Gabbet's Stain for, 832.
 —, —, in Sputum, demonstrating, 141.
 —, —, New Method for Staining and Mounting, 146.
 — Typhoid (Eberth), Differential Diagnosis of, 141.
Bacillus anthracis, Chemical Products of Growth of, 241.
 Bacillus, Blue Milk, Non-formation of pigment by, 81.
 —, Brown-staining, 146.
Bacillus Cholerae Asiatica and Finkler-Prior Bacillus, Distinguishing between, 142.
 Bacillus developing a Green Pigment, 238.
 —, Glands, Penetration of, through the intact Skin, 84.
 —, —, Staining, 550.
Bacillus hydrophilus fuscus, 509.
 — *lactis viscosus*, 801.
 — *Malaria*, 641.
 Bacillus, New, in Bees, 512.
 —, —, from Small Intestine, 512.
 —, Pathogenic, obtained from Floor-dust, 513.
 —, producing an Indigo-blue Pigment, 238.
Bacillus pyocyaneus, Races of, 643.
 — *pyogenes fetidus*, 801.
 — *radicola*, Infection of *Vicia Faba* by, 387.
 Bacillus, Red, from River Water, 81.
 —, —, of Kiel Water, Variability of, 510.
 —, Symptomatic Anthrax, Growth of, 239.
 —, Tetanus, Attenuation, 799.
 —, Tubercle, Conditions that modify Virulence of, 237.
 —, Typhoid Fever, Action of Light on, 802.
 Bacteria, Acid and Alkali formation by, 82.
 —, Action of Pyocetanin on, 388.
 — and Disease, 387.
 — and their Products, 514.
 —, Can they be introduced by being rubbed in through uninjured Skin? 84.
 —, Classification of, 638.
 —, Colloidal Clay for Filtering Fluids containing, 835.
 —, Drawings of, 79.
 —, Experiments on Cultivation Media for, 129.
 — in Colonies of *Puccinia Hieracii*, 611.
 — in Sputum, 513.
 Bacteria in Swine Diseases, 642.
 — in Water, 241.
 — in Wort and Beer, 944, 801.
 —, Influence of Digestive Secretions on, 509.
 — of Ozone on Growth of, 388.
 —, Isomeric Lactic Acids as criteria diagnostic of certain species of, 645.
 —, Luminous, Photogenic and Plastic Nutriment of, 809.
 —, New Cultivation Medium for, 679.
 — of Chemnitz Potable Water, 241.
 — of Influenza, 641.
 — of Urine, Antiseptic Action of Fluoride of Methylene on Pyogenic, 391.
 —, Pathogenic, from mud of Lake of Geneva, 801.
 —, Phosphorescent, 640.
 —, Plasmolysis in, 638.
 —, Presence of, in normal Vegetable Tissue, 509.
 —-protein, and its relation to Inflammation and Suppuration, 802.
 —, Reichel's Apparatus for Filtering Fluids containing, 680.
 —, Septic and Pathogenic, 80.
 —, Water, and their Examination, 85.
 Bacteriaceae, *Eubacillus*, New Genus of, 641.
 —, Morphology and Development of, 80.
 Bacterial, Anti-, Properties of Gastric Juice, 512.
 Bacteriological Diagnosis, Eisenberg's, 646.
 — Research, 235, 823.
 — "Star" Microscope, Beck's, 806.
 Bacteriology, Chemical, of Sewage, 829.
 — for Agriculturists, 86.
 — for Farmers, 245.
 —, Fraenkel's, 85.
 —, Fraenkel and Pfeiffer's Microphotographic Atlas of, 512.
 —, Günther's, 244.
 Baker's, C., Student's Microscope, 298, 516.
 — Photomicrographic Apparatus, 525.
Balanus, Fungus parasitic on, 781.
 —, Polar Bodies of, 38.
 Balbiani, E. G., Successive Regeneration of Peristome in *Stentor*, 751.
 Ballowitz, E., Examining Spermatozoa of Insecta, 421.
 —, Minute Structure of Spermatozoa of Mammalia, 580.
 —, Spermatozoa of Coleoptera, 181.
 Bancroft, T. L., Filariae of Birds, 195.
 Banyuls, *Kophobelemn* at, 750.
 Barber, C. A., *Pachylthea*, 779.
 Barbier, H., Blood as defence of organism against infection, 647.
 Barelay, A., *Aecidium esculentum*, 232.
 —, Himalayan Uredineae, 231, 635.
 —, Indian Rusts and Mildews, 78.
 —, Life-history of *Puccinia Geranii sylvatici*, 381.

- Barclay, A., *Uromyces Cunninghamianus* sp. n., 783.
- Bargellinia*, 382.
- Bark of Copper-beech, Swelling in, 764.
- of Trees, Calcium oxalate in, 616.
- cells and Tuberin, 488.
- Barley, Influence of Temperature on Germinating, 769.
- Baroui, E., Structure of Seed of *Euonymus*, 764.
- Bartels, P., Anatomy of Synaptidæ, 352.
- Barton, E. S., *Chantronsia*, *Lemanea*, and *Batrachospermum*, 629.
- , Galls on Seaweed, 502.
- Basidiomycete parasitic on Grapes, 637.
- Basidiomycetes, New Genera of, 79.
- Bassett-Smith, P. W., Corals of Tizard and Macclesfield Banks, 51.
- Bastit, E., Heliotropism and Geotropism in Mosses, 373.
- , Influence of hygrometric state of air on leaves of Mosses, 601.
- Bataillon, E., Role of Nucleus in Formation of Muscular Reticulum in Larva of *Phrygane*, 461.
- Batelli, A., Anatomical and Physiological Notes on Ixodidæ, 731.
- Bathylaster vexillifer*, 606.
- Bathynectes*, 342.
- Batrachia, Membrane of Red Corpuscle, 419.
- Batrachian Larvæ, Examining Histolytic phenomena occurring in tail of, 277.
- Batrachospermum*, 629.
- Batters, E. A. L., British Marine Algæ, 377.
- Baum, Joh., Contributions to Morphology and Biology of Fermentation-fungi, 647.
- Baumgarten's (P.) Annual Report on Pathogenic Micro-organisms, 86, 513.
- Bausch, E., The full Utilization of the Capacity of the Microscope, 108.
- Screw Micrometer, 293.
- Bausch and Lomb's Condenser Mounting with Iris Diaphragm, 405.
- — Microtome, 145.
- Beauvisage, G., Sieve-fascicles in Secondary Xylem of Belladonna, 618.
- Beck, J. D., Can mounting media be improved for high powers by increasing the index of refraction? 289.
- , R. & J., Bacteriological "Star" Microscope, 806.
- Beck von Mannaghetta, G. R., Parasitism of *Orobanche*, 69.
- Beddard, F. E., Aquatic Earthworms, 348.
- , Classification and Distribution of Earthworms, 346.
- , *Heliodrilus*, 41.
- , Homology between Genital Ducts and Nephridia in Oligochaeta, 194.
- , *Libyodrilus*, 471.
- , New Earthworm, 471.
- Beddard, F. E., New Form of Excretory Organ in an Oligochaetous Annelid, 596.
- , Structure of *Deodrilus* and Anal Nephridia in *Acanthodrilus*, 317.
- , Structure of New Earthworms, 346.
- , Structure of Oligochaeta, 194.
- Beech, Copper-, Swellings in Bark, 764.
- Beecher, C. E., Development of Brachiopoda, 336.
- Beer, Bacteria in, 244, 801.
- Bees, New Bacillus in, 512.
- , Solitary, Natural History of, 462.
- Beetroot, Disease of, 229.
- Behr, H. H., Live Oak Caterpillar, 33.
- , P., Non-formation of pigment by Bacillus of Blue Milk, 81.
- Behrens, J., Oogone and Oosphere of *Vaucheria*, 379.
- , W., Botanical Microscopy, 415.
- , Glasses for keeping Immersion Oil, 812.
- Behring's Sea, Algæ of, 74.
- Bein, —, Micro-organisms of Influenza, 388.
- Beketow, A., Proterandry in Umbelliferae, 495.
- Bell, F. J., Antipatharia, 480.
- , *Bathylaster vexillifer*, 606.
- , British Species of *Asterias*, 479.
- , Classification of Echinodermata, 602.
- , *Tristomum histiophori*, 475.
- Belladonna, Sieve-fascicles in Secondary Xylem of, 618.
- Belzung, E., Aleurone-grains in Papilionaceæ, 615.
- , Microscopic Diagnosis of Citric Acid in Plants, 553.
- , Origin and Development of Starch-grains, 362.
- Beneden, E. van, Development of *Arachnactis* and Morphology of Ceriantlhidæ, 354.
- , P. J. v., Two new Lernæopoda, 738.
- Benham, W. B., Abnormalities in Crayfish and Earthworm, 328.
- , Nephridium of *Lumbricus* and its Blood-supply, 470.
- , *Trigaster* and *Benhamia*, 40.
- , Report on an Earthworm collected in Equatorial Africa, 161, 295, 558.
- Benhamia*, 40.
- Bennett, A. W., Freshwater Algæ of South-west Surrey, 848.
- Berekholtz, W., *Gunnera manicata*, 761.
- Berger, F., Anatomy of Conifers, 619.
- Bergh, R. S., Development of Earthworm, 191.
- , — of Leeches, 41.
- Berlin Museum, Earthworms of, 596.
- , Tenth International Medical Congress, 271.

- Bernard, H., Hermaphroditism of Apodidae, 188.
 —, P., Note on an Eighteenth Century Microscope, 405.
 Berthelot, —, Sulphur in Plants, 616.
 Bertkau, P., Hermaphrodite Spider, 732.
 Bessey, C. E., Sections of Staminate Cone of Scotch Pine, 546.
 Beyer, O. W., Stinging Apparatus in *Formica*, 339.
 Beverinck, M. W., Capillary-siphon-dropping bottle, 652.
 —, Infection of *Vicia Faba* by *Bacillus radicola*, 387.
 —, Lactase, A new Enzyme, 374.
 —, Method for Demonstrating the Formation of Acids by Micro-organisms, 685.
 —, Photogenic and Plastic Nutriment of Luminous Bacteria, 800.
 —, Pure Cultivations of Green Unicellular Algae, 130.
 —, Zoochlorellae and Lichen-gonids, 232.
 Bianco, Lo, *Spongicola* and *Nausithoë*, 204.
 Biedermann, W., Origin and Mode of Termination of Nerves in Ganglia of Invertebrata, 718.
 Bigelow, R. P., Physiology of "Portuguese Man of War," 482.
 Bigula, A., Mid-gut of Galeodidae, 463.
 Billet, A., Contribution to Morphology and Development of Bacteriaceae, 80.
 Billings, J. S., Address at Meeting of American Microscopists, 821.
 Billoth, T., Reciprocal Action of Living Animal and Vegetable Cells, 514.
Biloculina undulata, 573.
 Biological Results of Cruise of the 'Argo,' 454.
 — Terminology, 173.
 Biology of Parasites, 495.
 —, Parker's Elementary, 451.
Biomysa vagans, 753.
 Bioplasts, 717.
 Birds, Filariae of, 195.
 —, Malaria Parasites in, 755.
 —, Phagocytosis in, 56.
 —, Tæniæ of, 47, 744.
 Bitter, H., Preservation and Sterilization of Milk, 83.
 Black-rot of Grapes, 229.
 —-rust of Cotton, 506.
 Blackham, G. E., Amplifying Power of Objectives and Oculars in the Compound Microscope, 114.
 Blanchard, R., Anomaly of Genital Organs of *Tania saginata*, 351.
 —, Evacuation of Cell-nuclei, 324.
 —, *Hymenolepis*, 600.
 —, Mistake of a Butterfly, 339.
 —, Mode of Feeding in Flukes, 44.
 —, New Type of Dermatomycosis, 78.
 Blass, J., Function of Sieve-portion of Vascular Bundles, 211.
 Blastogenesis of *Astellium spongiforme*, 332.
 Blastopore in Meroblastic Ova, 577.
Blastotrochus, Relation of Septa of Parent to those of Bud in, 480.
Blatta germanica, Development of Central Nervous System of, 341.
 Blochmann, F., Free-swimming Larva of *Dreissena*, 726.
 Blood, Cell-elements of, Fixing, Staining, and Preserving, 287.
 —, Crab's, Amceboid Cells in, 37.
 —, Demonstration of Suppuration-Cocci in, as aid to Diagnosis, 686.
 —, Development in Embryonic Liver, 578.
 —, Examining for Hæmatozoon of Malaria, 277.
 —, Germicidal Action of, 82, 237.
 —, — Substance of, 797.
 —, Human, Effect on Pathogenic Microbes, 798.
 — of Lamellibranchs, 331.
 — of *Meloe*, 34, 340.
 —, Origin from the Endoderm, 171.
 —, —, in Insects, 587.
 —, Pseudomicrobes of Normal and Pathological, 800.
 —-corpuscles, History of, 451.
 — - —, Morphology of, 25.
 — - —, Red, of Amphibians, 324.
 — - serum, Germicidal Action of, 236.
 Blumrich, J., Integument of *Chiton*, 725.
 Boehm, J., Ascending and descending Current in Plants, 371.
 Bohemia, *Thysanura* of, 341.
 — Rotifera, 351.
 Bohlin, K., *Myzochæte*, new Alga, 75.
 Böhmig, L., Rhabdocæle Turbellaria, 196.
 Bokorny, T., Conduction of Water, 219.
 —, Transpiration-Current, 625.
Bolocera, 479.
 Bolsius, H., Preparing Segmental Organs of Hirudinea, 828.
 —, Segmental Organs of Hirudinea, 740.
 Bommer, C., Fungus Parasitic on *Balanus*, 781.
 Bonardi, E., Influence of Physical Conditions on Life of Micro-organisms, 242.
 Bone, Decalcification of, 537.
 — Marrow, Examining for, developing Red Corpuscles, 275.
 — Sections, Impregnation of, with Anilin Dyes, 147.
 Bonnet, R., Introduction to microscopic examination of Animal Tissue, 415.
 Bonnier, G., Influence of high altitudes on Assimilation and Respiration, 71.

- Bonnier, J., Dimorphism of male Amphipoda, 187.
- Borden, W. C., Value of using different makes of Dry-plates in Photomicrography, 653.
- Bordet, —, Anatomical Researches on *Carex*, 489.
- Boret, V., New Bacillus from Small Intestine, 512.
- Borgert, A., Dictyochida, 611.
- Bornemann, F., Lemnaceæ, 377.
- Bornet, E., New Genus of Phæosporeæ, 75.
- Bornetella*, 75.
- Borodin, J., Dulcite in Plants, 60.
- Borzi, A., *Bargellinia*, new Genus of Ascomycetes, 382.
- , *Ctenocladus*, 630.
- , Culture of Terrestrial Algæ, 829.
- , *Dictyosphaerium*, *Botryococcus*, and *Porphyridium*, 637.
- , *Haviotina*, 632.
- , *Leptosira* and *Microthamnion*, 631.
- Bosse, A. W. V., Symbiosis of Algæ and Animals, 224.
- Botanical Preparations, Mounting, in Venetian Turpentine, 551.
- Botany, Collodion-method in, 423.
- Botrychium*, Apical Growth of, 500.
- Botryococcus*, 637.
- Bottini, A., Reproduction of *Hydromystris*, 495.
- Bottle, Capillary-siphon-dropping, 652.
- Bouchard, C., Action of Products secreted by Pathogenic Microbes, 85.
- Bouquet of Fermented Liquors, 77.
- Bourne, A. G., *Megascolex cæruleus*, 192.
- , Naidiform Oligochaeta, 596.
- , *Pelomyxa viridis*, 612.
- , G. C., Hydroids of Plymouth, 53.
- Bourquelot, E., Carbohydrates in Fungi, 77, 504.
- , Trehalose in Fungi, 228.
- Boutan, L., Larval Form of *Parmophorus*, 582.
- , Nervous System of *Parmophorus australis*, 26.
- Boutroux, L., Fermentation of Bread, 773.
- Bouvier, E. L., Anatomy of 'Hirondelle' Gastropods, 329.
- , Arterial System of Crustacea, 466.
- , Nervous System of *Cypræa*, 27.
- Bower, F. O., Lycopodiaceæ, 223.
- , Phylogeny of Ferns, 627.
- Bowers, H., Germination of *Hydrastis Canadensis*, 495.
- Boyer, G., Basidiomycete parasitic on Grapes, 637.
- Brachionus furculatus*, 302.
- Brachiopoda. See Contents, xi.
- Brady, H. Bowman, Death of, 127, 155.
- Braem, F., Freshwater Polyzoa, 727.
- Braemer, L., Tannoids, 759.
- Brain of Amphibia, Impregnating, by Golgi's method, 426.
- *Leptodora*, Movements in, 188.
- *Limulus Polyphemus*, 466.
- *Triton* and *Lethithophis*, Investigation, 827.
- , Vertebrate, Primitive Segmentation of, 449.
- Brains, Manipulating and Staining old and over-hardened, 550.
- Brandes, G., The Holostomidæ, 350.
- Brandza, M., Anatomical Characters of Hybrids, 215.
- , Development of Integument of Seed, 491.
- Brantz, C., Apparatus for cultivating Anaerobic Microbes, 274.
- Brauer, A., Development of *Hydra*, 609, 684.
- , F., Host of *Hypoderma lineata*, 35.
- Braun, M., *Echinorhynchus polymorphus* and *filicollis*, 349.
- , Free-swimming Sporocysts, 743.
- , Helminthological Studies, 199.
- Brazzola, H., Preparing and Staining Testicle, 427.
- Bread, Fermentation of, 221, 773.
- , Peculiar Disease of, 239.
- Brebner, G., Internal Phloem in Dicotyledons, 760.
- Bredow, H., Structure and Formation of Chromatophores, 360.
- Breeding of Frogs, 712.
- Brefeld, O., Hemiasci and Ascomycetes, 633.
- Bressadola, I., New Tuberculariæ, 506.
- Brieger, —, Bacteria and Disease, 387.
- British Amphipods, New, 594.
- Butterflies and Moths, Larvæ, 339.
- Echinoidea, Revised List of, 352.
- Hymenoptera Anthophila, Tongues, 34.
- Marine Algæ, 377.
- Mosses, 627.
- Species of *Asterias*, 479.
- — of *Crisia*, 335.
- Waters, *Hali-stemma* in, 481.
- Bronziart, C., Parasite of *Aceria pergrinum*, 637.
- Bronze, Action of Fungi on, 381.
- Brooks, W. K., Early Stages of Echinoderm, 477.
- Structure and Development of Gonophores, 481.
- Bruce, D., New Method of injecting into peritoneal cavity of animals, 547.
- Brun, J., New Genera of Diatoms, 785.
- Brunnée, R., Arrangement for rapid change from parallel to convergent light, 519.
- Brunia*, new fossil Diatom, 386.
- Bryce, D., *Distyla*; New Rotifers, 745.
- Bryozoa. See Contents, xi.

- Buchenau, F., Bulbs and Tubers in Junceae, 493.
- Buchner, H., Bacteria-protin and its relation to Inflammation and Suppuration, 802.
- , Presence of Bacteria in Normal Vegetable Tissue, 509.
- Budding in Bryozoa, 456.
- Buds, Dormant, in Woody Dicotyledons, 64.
- of Ash, Reserve-receptacles in, 212
- of *Sempervivum* and *Sedum*, 64.
- Buffham, T. H., Reproductive Organs of Florideae, 777.
- Bugnon, E., Structure and Life-history of *Encyrtus fuscicollis*, 339.
- Bujwid, O., Simple Apparatus for filtering Sterilized Fluids, 273.
- , Preparing Tuberculin, 534.
- Bulbils in *Lilium auratum*, Production of, 368.
- , Longevity of, 770.
- of *Malaxis*, 66.
- Bulbs in Junceae, 493.
- , Rooting of, and Geotropism, 70.
- Bulbus arteriosus and Aortic Valves of Lamellibranchs, 584.
- Bulloch, W. H., Death of, 820.
- , Improved Filar Micrometer, 106.
- Bull's-eyes for Microscope, 299, 309, 431.
- Burchardt, R., Investigation of Brain and Olfactory Organ of *Triton* and *Ichthyophis*, 827.
- Burei, E., *Bacillus pyogenes fetidus*, 801.
- , Biological and Pathogenic Characters of *Bacillus pyog. fetidus*, 514.
- , Rapid Staining of Elastic Fibres, 881.
- Burek, W., Cleistogamic Flowers, 767.
- , Weismann's Theory of Heredity, 766.
- Bürger, O., Attraction-spheres in Cœlomic Cells, 715.
- , Embryology of *Nepheles*, 471
- , *Nectonema agile*, 472.
- Burgess, E. W., Foraminifera of Hammerfest, 613.
- Buscalioni, L., Germination of Seeds of Papilionaceae, 218.
- , Structure of Starch-grains in Maize, 486.
- Busquet, G. P., New *Achorion*, *A. Arloini*, 784.
- Bütschli, O., Striated Muscles of Arthropoda, 336.
- Butterflies, Development of Nervures of Wings of, 238.
- Butterfly, Mistake of a, 339.
- Butyric Ferment, Transformation of Starch into Dextrin by, 498.
- C.
- Caboni, G., Bacteria in colonies of *Puccinia Hieracii*, 641.
- Caetaceae, Germination within Pericarp in, 369.
- Cajal, S. R., Staining Terminations of Tracheae and Nerves in Insect Wing Muscles by Golgi's Method, 288.
- Calamocrocinus Diomedea*, 202.
- Calcareous Bodies of Aleyonacea, 422.
- Lichens, 383.
- Sponges, System of, 611.
- Calceolaria*, Pollination of, 216.
- Calcium Oxalate, Formation of, 220.
- in Bark of Trees, 616.
- in Plants, 59.
- , Crypto-crystalline, 616, 759.
- Callophyllis*, Cystocarp of, 629.
- Caloglossa Leprieurii*, 628.
- Calvin, S., Gigantic Specimens of *Actinosphaerium*, 55.
- Calyx, Stomates in, 621.
- Camera, "Handy" Photomicrographic, 257.
- Lucida, A new, 254.
- , Microscopical Measurements with, 705, 840, 846.
- Camerano, L., Development of *Gordius*, 196.
- , Examining Ova of *Gordius*, 540.
- Campanulaceae, 63.
- Campbell, D. H., Apical Growth of *Osmunda* and *Botrychium*, 590.
- , — of Prothallium of Ferns, 627.
- , Archegone of Ferns, 500.
- , Life-history of *Isoetes*, 774.
- Cancer, Parasitic Protozoid Organism in, 357.
- cells, Micro-organisms in, 358.
- Candolle, C. de, Epiphyllous Inflorescences, 490.
- Canestrini, G., Classification of Mites, 590.
- , New Bacillus in Bees, 512.
- Caneva, G., Bacteria in Swine-diseases, 642.
- Cantharidine, Use of, 34, 340.
- Cann, E., Development of Ascicolous Copepoda, 188.
- , Sexual Dimorphism of Copepoda Ascidiicola, 38.
- , G., Female Reproductive Organs of Decapoda, 467.
- , Post-embryonic Development of Gonoplacidae, 735.
- Caplatzi, A., Schroeder's Photographic Optics, 818.
- Capranica, S., Photomicrography, 261.
- Caprellidae, Preserving, 422.
- Carbohydrates, Formation and Transport of, 370.

- Carbohydrates in Fungi, 77, 504.
 —, Influence of, on Formation of Asparagin, 497.
 Carbonic Acid, Filtration and Sterilization of Organic Fluids by Liquid, 682.
Carchesium, 303.
Carex, Anatomical Researches on, 489.
 Carlgren, O., *Bolocera*, 479.
 —, *Protanthea*, a new Actinian, 479.
 Carmine, Staining Medullated Nerve-Fibres with, 286.
 Carpenter, G. H., Lepidoptera of Torres Straits, 581.
 —, P. H., Crinoids of Port Phillip, 51.
 —, W. B., 'The Microscope,' new edition, 819, 845.
 Carpotropic Curvatures of Nutation, 372.
 Caryokinesis. See Karyokinesis.
 Caryophyllaceæ, Fertilization of, 68.
 Castor-oil plant, Germination of Seed of, 217.
 Cat, Placenta of, 448.
Catasetum, Sexual Forms of, 369.
Catenella Opuntia, Cystocarps and Antherids of, 502.
 Caterpillar, Live Oak, 33.
 Catgut, Method for Sterilizing, 535.
 Cattaneo, G., Amoeboid Cells in Crab's Blood, 37.
 —, Genus *Conchophthirus*, 55.
 Cattani, G., Attenuation of Bacillus of Tetanus, 799.
 —, Immunization against Virus of Tetanus, 796.
Ceanothus, Tubercles on Roots of, 766.
Cecidomyia pseudococcus, 35.
 Celakovsky, L., Morphology and Phylogeny of Gymnosperms, 365.
 Cell, Morphology and Physiology of, 450.
 — division, "Intermediate Body" in, 715.
 — elements of Blood, Fixing, Staining, and Preserving, 287.
 — nuclei, Evacuation of, 324.
 — sap of *Valonia*, 631.
 — structure and division, 171, 579, 714.
 — — — See Contents, xx.
 — wall, Growth of, in *Chara fetida*, 501.
 Celloidin, Method of Imbedding Delicate Objects in, 424.
 Cells, Absorption of Solid Substances by, 770.
 —, Demonstrating Fungi in, 829.
 —, Nervous, Structure of, 24.
 —, Pigment, 580.
 Cement Supports, Vosseler's, 429.
 Cements, 692.
 Central Bodies and Attraction Spheres in Tissue and Migratory Cells, 322.
 — Nervous System of Pulmonata, 722.
 Cephalic Appendages in Annelids, Homology of, 595.
Cephalodiscus dodecalophus, Organization of, 201.
 Cephalopoda. See Contents, x.
Ceratopteris thalictroides, Root of, 776.
Cercomonas intestinalis, 56.
 Cerebral Vessels of Mammalia, Demonstrating, 547.
 Cerfontaine, P., Cutaneous and Muscular Systems of Earthworm, 191.
 —, Organization and Development of Anthozoa, 353, 749.
 Cerianthidæ, Morphology of, 354.
Cerianthus americanus, Structure of, 52.
 — *membranaceus*, 480.
 Certes, A., Eismond's Method of Studying Living Infusoria, 828.
 —, *Trypanosoma Balbianii*, 753.
 —, Two new Infusoria, 752.
 Cestoda, Morphology of, 199.
 Ceylon, Echinoderms of, 351.
 Chabrié, O., Antiseptic Action of Fluoride of Methylene on Pyogenic Bacteria of Urine, 391.
 Chadwick, H. C., Fission of *Cucumaria planici*, 353.
Chaetopterus, 629.
Chaetostylum, 504.
 Chamberlain, J. S., Styles of Compositæ, 762.
 "Champignon du Muguet," Conversion of Alcohol into Aldehyde by, 773.
Chantransia, 629.
 Chapman, F., Foraminifera of Gault of Folkestone, 565, 840.
 Characeæ. See Contents, xxvii.
 Charrin, A., Chemical Nature of Secretions of Microbes, 649.
 —, Germicidal Action of Blood-serum, 236.
 —, Toxicity of Serum, 514.
 Chafin, A., Biology of Parasites, 495.
 — Comparative Anatomy of Plants, 761.
 — J., Hepatic Epithelium of *Testacella*, 330.
 —, Nucleus of Sponges, 54.
 —, Stylet of *Heterodera Schachtii*, 598.
 Cheese, Ripening of, 389.
 —, Spongy, 511.
 Chelonia, Fœtal Membranes in, 22, 449.
 —, Urinogenital Apparatus of, 23.
 Chemical Bacteriology of Sewage, 829.
 Chemistry of Insect Colours, 458.
 Chemnitz Potable Water, Bacteria of, 241.
 Chicaudard, —, Fermentation of Bread, 773.
 Chick, Imbedding Embryo of, 541.
 Chicken Embryos, Nomenclature of, 318.
Chilodon labiatus, 700.
Chironomus, Development of, 183.
 —, Preparing and Staining Ova of, 539.
Chiton, Integument of, 725.

- Chlamydomonas*, Structure and Reproduction of, 631.
Chlorodictyon foliosum, 505.
 Chlorophyll, 616, 758.
 — in Animal Kingdom, 174, 717.
 —, Influence of Saltness on Starch in Vegetable Organs containing, 498.
 —, Spectrum of, 486.
 —, Staining of, 689.
 Chmielevsky, V., Chlorophyll-bands in Zygote of *Spirogyra*, 378.
 Chobaut, A., Life of *Emenadia*, 181.
 Cholera Bacilli, Red Nitro-indol Reaction as Test for, 242.
 Cholodkovsky, N., Blastopore in Meroblastic Ova, 577.
 —, Development of Central Nervous System of *Blatta germanica*, 341.
 Chrapowicki, W., Formation of Albuminoids, 72.
Chreocolar, 778.
 Christmann, F., Obtaining Leprosy Bacilli from Living Lepers, 830.
 Chromatin, Demonstration of Iron in, 828.
 —, Two Kinds of, 324.
 Chromatophores of Oetopoda, 175.
 —, Structure and Formation of, 360.
 Chromic Acid for rapid Preparation of Tissues, 417.
Chrysaora, Scyphostoma of, 203.
 Chylocladiæ, Structure and Development of, 502.
 Ciaccio, G. V., Demonstrating Nerve-end Plates in Tendons of Vertebrata, 427.
 Ciagliński, A., Preparing and Staining Sections of Spinal Cord, 549.
 Cider, Fermentation of, 222.
 Cilia of Zoospores, Demonstration of, 541.
 Ciliated Infusorians, Notes on, 355.
 Circulation in *Arca*, 726.
 Circulation, Passive, of Nitrogen in Plants, 626.
 Circulatory Organs of Arthropods, 586.
 Cirolanidæ, 186.
 Citric Acid in Plants, Microscopic Diagnosis of, 553.
Cladophora, 778.
 —, Mode of Attachment of, 503.
 Cladosporiæ, Entomophytic, 636.
Cladothete, 778.
Cladotrix, Pseudotuberculosis produced by a pathogenic, 511.
 Claessen, H., Bacillus producing an Indigo-blue Pigment, 238.
 Clamp-organs of Conjugatæ, 502.
 Clasmatocytes, 323.
 —, Transformation of Lymphatic Cells into, 323.
 Classification of Animal Kingdom, 452.
 — Bacteria, 638.
 — Diatoms, 234.
 — Echinodermata, 602.
 — Fucoidæ, 629.
 Classification of Holothurians, 477.
 — Lichens, 230.
 — Mites, 590.
 — Sponges, 751.
 — Tunicata, 585.
 Claus, C., *Goniopelte gracilis*, 594.
 —, Mediterranean and Atlantic Halocyprides, 344.
 —, Scyphostoma of *Cotylorhiza*, *Aurelia*, and *Chrysaora*, 203.
 Clavelinidæ, 456.
 Clay, Colloidal, for Filtering Fluids containing Bacteria, 835.
 Cleaning used Slides and Cover-glasses, 833.
 Cleistogamic Flowers, 767.
Clepsine plana, 740.
 Cleve, P. T., New Diatoms, 386.
Clione limacina, 454.
 Clos, D., Embryo of *Trapa*, *Nelumbium*, and some Guttiferæ, 763.
 —, Germination within Pericarp in Cactaceæ, 569.
 —, Independence of Fibro-vascular bundles in appendicular organs, 364.
Closterium, Germination of, 378.
 Cobb, N. A., *Anticomæ*, 472.
 —, Arabian Nematodes, 349.
 —, Insect-larva eating Rust on Wheat and Flax, 461.
 —, Study of Nematodes, 422, 540.
 Cobelli, R., Desiccation of Rotifers, 745.
 Coccidia and Echinococcus, Symbiosis of, 475.
 Coccidium-like Micro-organisms in Cancer-cells, 358.
Cocconema lunceolatum, 441
 Cockchafer, Parasite of, 636, 783.
 Cockerell, T. D. A., Geographical Distribution of Slugs, 582.
 Coco-nut-water as Culture Fluid, 693.
 Cocoon-weaving of *Agelena labyrinthica*, 731.
 Cœlenterata. See Contents, xviii.
 Cœlomic Cells, Attraction-spheres in, 715.
 Coffee and its Relation to Microbes, 80.
 Coggi, A., Structure of Nervous Cells, 24.
 Cohn, F., Sclerote-forming Fungi, 507.
Colacium, 303.
 Coleoptera, Adhesive Organs on the Tarsal Joints of, 34.
 —, Spermatozoa of, 181.
 —, Vesicating Blood of *Meloe* and Cantharidine in Biology of, 34, 340.
 Collecting. See Contents, xxxvi.
 College Microscope, 649.
 Collenchymæ, 60.
 Collodion-method in Botany, 423.
 Colony-counter, 681.
 Colourability of Tubercle Bacilli, 690.
 Coloured Photomicrograms, 813.
 Colouring-matter of Schizomycetes, 640.

- Colouring-matter, Yellow and Red, of Leaves, 59.
 — Power of Noctiluca, 839.
 Comatulids of Indian Archipelago, 479.
 Comber, T., Photomicrography, 407.
 Comparator, Quartz-wedge, 394.
 Compass-plants, 496.
 Compositae, 63
 —, Pericarp of, 764.
 —, Styles of, 762.
 —, Tannin in, 209.
Conchophthirus, 55.
 Condenser, Bull's-eye, 431.
 — Mounting with Iris Diaphragm, Bausch and Lomb's, 405.
 —, New Apochromatic, by Powell and Lealand, 155.
 —, Substage, 256.
 —, —, History of, 90.
 Cone, staminate, of Scotch Pine, Sections of, 546.
 Congress, International, on Hygiene, 300.
 Conids, Disarticulation of, in Peronosporae, 779.
 Coniferae, Increase in Thickness of, 369.
 —, Morphology of, 212.
 —, "Sanio's Bands" in, 488.
 Conifers, Anatomy of, 619.
 —, Leaves of, 65.
 —, Wood of, 487.
 Conjugate, Clamp-organs of, 502.
 Conjugation in Gregarines, 357.
 — in *Noctiluca*, 484.
 — of Zygnemaceae, 502.
 Conklin, E. G., Structure and Development of Gonophores, 481.
 Conkton, E. G., Embryology of *Crepidula* and *Urosalpinx*, 454.
 Conn, H. W., New Micrococcus of Bitter Milk, 644.
 Contraction of Living Muscular Fibres, 275.
 Cooke, M. C., Dispersion and Germination of Spores of Fungi, 504.
 Copepod, a New, *Goniopelte gracilis*, 594.
 Copepoda as Food, 738.
 — Ascidiicola, Sexual Dimorphism of, 38.
 —, Development of Ascidicolous, 188.
 —, Freshwater, Test-gland of, 38.
 —, New, 594, 737.
 Copepods, Distribution of, 737.
 —, Sexual Characters in, 737.
 Copper, Action of Fungi on, 381.
 Copper-Beech, Swellings in Bark of, 764.
Coprimus, Sclerotoid, 507.
 Copulation of Water-mites, 731.
 —, Signs of, in Insects, 588.
 Corals. See Cœlenterata, Contents, xviii.
Corambe testudinaria, Anatomy of, 330.
 Cori, C. J., Anatomy and Histology of *Phoronis*, 201.
 Cornea, Metallic Impregnation of, 286.
 Cornil, —, Penetration of Glanders Bacillus through the intact Skin, 84.
 Corning, H. K., Origin of Blood from the Endoderm, 171.
Cornuspira cretacea, 574.
 — *foliacea*, 575.
 — *involeans*, 575.
Corokia budleooides, Trichomes of, 66.
 Corpuscle, Red, of *Batrachia*, Demonstrating Membrane of, 419.
 Corpuscles, Central and Attraction-spheres, 715.
 —, Red, Examining Bone Marrow for developing, 275.
 Correns, C., Pollination of *Aristolochia*, *Salvia*, and *Calceolaria*, 216.
 Corrosive sublimate, Effect of, on Fungi, 381.
 Cortical Bundles in *Genista*, 365.
 Coscinodisceae, 385.
Cosmarium, Germination of, 378.
 Coste, F. H. P., Chemistry of Insect Colours, 458.
 Cotton, Black-rust of, 506.
 —, New *Ramularia* on, 78.
 Cotyledons, Structure of, 764.
Cotylorhiza, Scyphostoma of, 203.
 Council, Report of, 156.
 Courmont, —, Microbes of Acute Infectious Osteomyelitis, 243.
 Cover-glasses, Cleansing, 833.
 Cow, Cysticercus of *Taenia saginata* in, 745.
 —, *Echinococcus multilocularis* in, 745.
 Cox, C. F., Protoplasm and Life, 326.
 —, J. D., Coscinodisceae, 585.
 —, Deformed Diatoms, 387.
 —, Diatom Structure, Interpretation of Microscopical Images, 657.
 —, New Apochromatic Objective, 248.
 —, Nutrition and Movements of Diatoms, 235.
 —, W. H., Impregnation of Central Nervous System with Mercurial Salts, 420.
 Coxal Glands of Arachnida, 591.
 Crab's Blood, Amœboid Cells in, 37.
Crambe maritima, Pollination of, 217.
 Cramer, C., *Caloglossa Leprieurii*, 628.
 —, *Chlorodictyon foliosum* and *Ramalina reticulata*, 505.
 —, *Neomeris* and *Bornetella*, 75.
Crangon, Excretory Apparatus of, 37.
 Craspedota of Plankton Expedition, 609.
 Crayfish, Abnormalities in, 328.
 Crayfishes, Eyes in Blind, 186.
Crepidula, Embryology of, 454.
 Crinoids of Port Phillip, 51.
 —, Perisomatic Plates of, 352.
Crisia, British Species of, 335.
Cristatella, 179.
 Crocodile, Eggs and Embryos of, 577.

- Crocodyles, Urinogenital Apparatus of, 23.
 Crookshank's, E. M., Bacteriology, 391.
 Crosa, F., Preserving Larvæ of Lepidoptera with their colour, 539.
 Cruciferae, Integuments of Seed of, 491.
 —, Localization of Active Principles of, 362.
 Crustacea. See Contents, xiii.
 —, Freshwater, Cysticercoids of, 45.
 Crustacean Eyes, Preparing, 828.
 Crypto-crystalline Calcium oxalate, 616.
 Cryptogamia. See Contents, xxvii.
 Crystalline Style, 177.
 Crystallographic Microscopes, Fuess's, 393.
 — — —, Improvements in, 396, 399.
 — — —, Zeiss's, 516.
 Crystals, Goniometer for Microscopic, 396.
 —, Hæmatoxylin, Staining Solution made from, 831.
 —, Liquid, 265.
 — of Calcium oxalate, 759.
Ctenocladus, 630.
Cucumaria planci, Fission of, 353.
 Cucurbitaceæ, Increase in Thickness of Stem of, 210.
 —, Porosity of Fruit of, 491.
 Cuénot, L., Apical System of Echinoids, 748.
 —, Blood of *Meloe*, and Function of Cantharidine in Biology of Vesicating Coleoptera, 34, 340.
 —, Enterocælic Nervous System of Echinoderms, 49.
 —, Morphology of Echinoderms, 746.
 Culture fluid, Coco-nut-water as, 693.
 — of Terrestrial Algæ, 829.
 — Processes. See Contents, xxxvi.
 Cunningham, J. T., Disputed Points in Teleostean Embryology, 318.
 Curtel, G., Physiological Researches on Floral Envelopes, 220.
 Curtice, C., Drawing Microscopic Objects by Use of Co-ordinates, 527.
 Cutaneous System of Earthworm, 191.
 Cutting. See Contents, xxxix.
Cyanea arctica, Development of, 481.
Cyclotella annelidicola, 29.
Cyclops, Maturation of Ova of, 188.
 Cyclospereæ, Integument of Seed of, 367.
 Cyclostomatous Polyzoa, Origin of Embryos in Ovicells of, 457.
 Cymbasomatidae, 189.
 Cymodoceæ, Stem of, 764.
Cypræa, Nervous System of, 27.
Cypris, Cysticercus of *Tænia coronula* found in specimens of, 296.
 Cysticercoids of Freshwater Crustacea, 45.
 Cysticercus of *Tænia saginata* in Cow, 745.
 Cystocarp of *Callophyllis*, 629.
 Cystocarps of *Calceola Opuntia*, 502.
Cystocelia immaculata, Stridulating Organ of, 184.
 Cystoliths, 62.
 — of *Ficus*, 619.
Cytophagus Tritonis, 206.
 Czaplewski, E., Demonstrating Tubercle Bacilli in Sputum, 141.
 Czapski, S., Probable Limits to Capacity of Microscope, 814.
 —, Zeiss's Crystallographic and Petrographical Microscopes, 516.
- D.
- Daday-de-Deés, E. v., Heterogenesis in Rotifers, 200.
 —, Hungarian Myriopoda, 184.
 Daguillon, A., Leaves of Conifers, 65.
 Dallinger, W. H., Address to Quekett Club, 666.
 — Edition of Carpenter's 'Microscope,' 819, 845.
 —, elected Secretary, 838.
 Dangeard, P. A., Clamp-Organs of Conjugatae, 502.
 —, Endotrophic Mycorrhiza, 504.
 —, Equivalence of Vascular Bundles in Vascular Plants, 760.
 —, *Eubacillus*, new Genus of Bacteriaceæ, 641.
 —, Histology of Fungi, 380.
 —, Nucleus of Oomycetes during Fecundation, 632.
 —, Oospores formed by Union of Multinucleated Sexual Elements, 217.
 —, *Tmesipteris*, 499.
 Daniel, L., Tannin in Compositæ, 209.
 Danilewski, B., Microbes of Malarial Infection in Birds and Man, 391.
 —, Myoparasites of Amphibia and Reptilia, 358.
 —, Phagocytosis in Frogs and Birds, 56.
 —, *Polymitus malarie*, 754.
 Dantec, — Le, Intracellular Digestion in Protozoa, 483.
 Danziger, —, Tuberculosis in a Cock, 86.
Daphnia, Development of, from Summer-egg, 469.
 Dark-ground Illuminator, 836.
Dasydytes bisetosum, 602.
Daudebardia, Anatomy of, 582.
 Davenport, C. B., Budding in Bryozoa, 456.
 —, *Cristatella*, 179.
 David, T., Microbes of Mouth, 245.
 Davidoff, M. v., Development of *Distaplia magnilarva*, 333.
 Davis, B. M., Continuity of Protoplasm in Algæ, 628.
 Day, T. C., Influence of Temperature on Germinating Barley, 769.
 Debray, F., Structure and Development of Chylocladiae, 502.

- Deby, J., *Auliscus*, 785.
 —, Idea of Species in Diatoms, 785.
 Decalcification of Bone, 537
 Decapod Crustacea, Renal Organs of, 467.
 Decapoda, Female Reproductive Organs of, 467.
 Decidua reflexa, Fate of the Human, 169.
 Deés. See Daday-de-Deés.
 Degagny, C., Antagonistic Molecular Forces in Cell-nucleus, 360.
 —, Cell-division in *Spirogyra*, 58.
 —, Nuclear Origin of Protoplasm, 208.
 Dehiscent Fruits, Influence of Moisture on, 491.
 Dehmel, M., Latex-receptacles, 618.
 Dehydrating Apparatus, 535.
 Delacroix, G., Fungus-parasites on Pines, 782.
 —, Parasite of Cockchafer, 636, 783.
 Delage, Y., Development of *Spongilla fluvialtilis*, 751.
 Delpino, F., Nectary-covers, 63.
 —, Theory of Pseudanthly, 213.
 Demoor, J., Experimental Researches on Locomotion of Arthropods, 31.
 —, Motor Manifestations of Crustacea, 735.
Dendrogaster, a new Ascophoracida, 189.
 Dendy, A., Comparative Anatomy of Sponges, 204.
 —, New *Peripatus* from Victoria, 36.
 —, *Synute pulchella*, 611.
 —, Victorian Land Planarians, 474.
 —, — Sponges, 610.
 Dental Tissues, Infiltrating, 307.
Dentalium, Heart of, 330.
Deodrilus, Structure of, 347.
 Dermal Sense-organs of Crustacea, 734.
 Dermatomycolysis, New Type of, 78.
 Desiccation of Rotifers, 745.
 Desk for Microscopical Drawing, 291.
 Despeignes, V., Experimental Study on Microbes of Water, 245.
 Detmer, W., Respiration of Plants, 374.
 De-Toni, J. B., Classification of Fucoideæ, 629.
 —, Sylloge Algarum, 503.
 Devaux, H., Growth of Root-hairs, 493.
 —, Hypertrophy of Lenticels, 488.
 —, Internal Atmosphere of Tubers and Tuberous Roots, 371.
 —, Passive Circulation of Nitrogen in Plants, 626.
 —, Porosity of Fruit of Cucurbitaceæ, 491.
 —, Respiration in Interior of Massive Tissues, 497.
 —, Rooting of Bulbs and Geotropism, 70.
 —, Temperature of Tubercles during Germination, 218.
Devca, 228.
 Dextrin, Transformation of Starch into, by Butyric Ferment, 498.
 Diago, J., Position of Bacteriology in Category of Sciences, 647.
 Diaphragm, Bausch and Lomb's Condenser Mounting with Iris, 405.
 —, New Ocular, 255.
Diaptomus, Nervous System of, 341.
 Diastatic Ferment in Green Leaves, 774.
 Diatom-Structure, Interpretation of Microscopical Images, 657.
 Diatom-valves, Structure of, as shown by sections of charged specimens, 431, 441.
 Diatomaceen-Kunde, Schmidt's Atlas, 508.
 Diatoms, Classification of, 234.
 —, Defensive Structure of, 79.
 —, Deformed, 387.
 —, from Java, 386.
 —, Idea of Species in, 785.
 —, Movement and Reproduction of, 508.
 —, Movements of, 638.
 —, New Genera of, 386, 785.
 —, Nutrition and Movements of, 235.
 —, of France, 785.
 —, Pelagic, 79.
 Dick's Petrological Microscope, 155.
 Dicotyledons, Internal Ploem in, 760.
 —, Woody, Dormant Buds in, 64.
Dicranochaete, 385.
 Dictyoehida, 611.
Dictyosphaerium, 637, 638.
 Dictyotaceæ, 630.
 Diétel, P., Himalayan Uredineæ, 231.
 —, *Puccinia* parasitic on Saxifragaceæ, 635.
 —, Researches on Uredineæ, 634, 783.
Difflugia, Life of, 205.
 Diffraction Gratings and Aplanatic Objectives, Relation between, 665.
 Digestion, Intracellular, in Protozoa, 683.
 Digestive Properties of *Nepenthes*, 375.
 — Secretions, Influence on Bacteria, 509.
 Dimorphism of male Amphipoda, 187.
Dinops longipes, 201.
Dionæa, Irritability of Leaves, 771.
Diopatra, Reproductive Organs of, 595.
Diorchidium, 783.
Diplococcus resembling *Gonococcus*, 643.
Diplocolon, 233.
Diplogaster, 43.
Diplozoon nipponicum, 472.
 Diptera, Halteres of, 35.
 Diseases and Injuries of Plants, Kirehner's, 375.
 — caused by Fungi, 782.
 Disinfecting property of Peroxide of Hydrogen, 799.
Distaplia maguilareæ, Development of, 333.
Distichopora, Gonophores of, 608.
 —, Male Gonangia of, 481.
Distomum fabaceum, Anatomy of, 45.
 Distribution of Copepods, 737.
 — of *Mayelona*, 740.

- Distyla*, 745.
- Dittrich, P., Significance of Micro-organisms of Buccal cavity to Human Organism, 391.
- Divini's, E., Compound Microscope, 808.
- Dixon, G. Y. & A. F., Marine Invertebrate Fauna near Dublin, 718.
- , S. G., Apparatus for Collection of Dust and Fungi for Microscopical and Biological Tests, 419.
- Doassansia*, 780.
- Dodel, A., Fertilization of *Iris sibirica*, 768.
- Dogiel, A. S., Fixation of Stain in Methylene-blue Preparations, 548.
- Douliot, H., Apical Tissue in Stem of Phanerogams, 210.
- Dowdeswell, G. F., Eye-piece Thread-Micrometer, 150.
- , Simple form of Warm Stage, 150.
- Drawing Microscopical Objects by Use of Co-ordinates, 527.
- , Microscopical, Desk for, 291.
- , New Apparatus for Low Magnifications, 811.
- Dreissena*, Larva of, 726.
- Dreyer, F., Structure of Rotten-stone, 423.
- Dreyfus, L., Moulting in *Rhynchota*, 340.
- Dry Plates, Value of using different makes of, in Photomicrography, 653.
- Drying-stoves, Thermoregulator for, 652.
- Dubern, G., Histology of Spermatozoa, 325.
- Dubler, A., Action of Bacteria on the Human Body, 86.
- Dublin, Marine Invertebrate Fauna near, 718.
- Dubois, R., Action of Fungi on Copper and Bronze, 381.
- , Digestive Properties of *Nepenthes*, 375.
- Duchartre, P., Inferior Ovaries, 491.
- , Production of Bulbils in *Lilium auratum*, 368.
- Duchesne, L., Pearls of *Pleurosigma angulatum*, 386.
- Duck, Development of *Tenia lanceolata* in the, 438.
- Dudley, P. H., Elliptically wound Tracheids, 365.
- Dulcite in Plants, 60.
- Duncan, Death of Prof. P. Martin, 555.
- Duramen, Formation of, 211.
- Dyes, Characteristics of some Anilin, 551.
- Dytiscida, Sound-organs of, 589.
- E.
- Earthworm, Abnormalities in, 328.
- , Cutaneous and Muscular Systems of, 191.
- , Development of, 191.
- , New, 471.
- Earthworms, Aquatic, 348.
- , Classification and Distribution, 346.
- , collected in Equatorial Africa, 161, 295, 558.
- , New Genus of, 193.
- , of Berlin Museum, 596.
- , Structure of New, 347.
- , Work of, on African Coast, 40.
- Earwigs, Odoriferous Glands of, 184.
- Ebbage, H., Recreative Microscopy, 823.
- Eberdt, O., Origin and Development of Starch-grains, 361.
- Ebstein, W., Artificial Preparation of Spheruloliths of Uric Acid Salts, 553.
- Echinococcus* and Coccidia, Symbiosis of, 475.
- *multilocularis* in Cow, 745.
- Echinodermata. See Contents, xvii.
- Echinorhynchus*, Histology of, 196.
- *polymorphus* and *filicollis*, 349.
- , Structure and Development of, 742.
- Eckstein, K., Life-history of *Lyda*, 34.
- Ectemascidia*, 456.
- Ectoproctous Bryozoa, Free Development in, 728.
- Edinger, L., New Apparatus for drawing Low Magnifications, 811.
- Edwards, C. L., New Copepoda, 737.
- Egg, Hen's, Double Embryo in, 21.
- of Fowl, Pressure within, 21.
- of Teleosteans, 713.
- , Summer-, *Daphnia* from, 469.
- cell of Fowl, Maturation, 710.
- Eggs, Formation of, in Testis of *Gebia major*, 344.
- of Crocodile, 577.
- of Insects, Early Stages of, 461.
- of Pycnogonids, Preparing, 421.
- Ehrlich, —, Phagocytosis, 792.
- Eiselsberg, A. v., Demonstration of Suppuration-Cocci in Blood as an aid to Diagnosis, 686.
- Eisenberg, J., Bacteriological Diagnosis, 391, 646.
- Eismond, J., Mechanism of Sucking in Suctoria, 55.
- , Simple Method of examining Living Infusoria, 141, 828.
- Elasmobranchs, Early Stages in Development of, 170.
- , Maturation of the Ova of, 170.
- Elastic Fibres, Rapid Staining, 831.
- Electric Regulator for controlling Gas-supply of Heating-Lamp, 406.
- Electro-Microscope Slide for Testing Antiseptic Power of Electricity, 810.
- Elfvig, F., Influence of Light on Growth of Fungi, 504.
- Elimination of Solid Substances by Cells, 770.
- Elliott, G. F. S., Contrivances for Pollination, 768.
- Ellis, J. B., Sclerotoid *Coprinus*, 507.

- Embryo Chick, Preparation of, 541.
 —, Fowl, Effect of Micro-organism on, 84.
 — of Arachnids and Insects, Extremities of, 458.
 — of *Trapa*, *Nelumbium*, and some Guttiferae, 763.
 —-sac of Gymnosperms, Formation of Endosperm in, 623.
 Embryology of *Asterias vulgaris*, 476.
 — of *Crepidula* and *Urosalpinx*, 454.
 — of Insects, 729.
 — of Isopoda, 343.
 — of Mites, 466.
 — of *Nephtelis*, 471.
 — of Pycnogonids, 341.
 —. See Contents, vii.
 Embryonic Development of *Pyrosoma*, 178.
 — Liver, Examination of, 683.
 Embryos, Human, Structure of Spinal Cord in, 325.
 —, Insect, Abdominal Appendages of, 730.
 — of Amphibia, Preparation of, 827.
 — of *Tennocephala chilensis*, 44.
 —, Origin of, in Ovicells of Cyclostomatous Polyzoa, 457.
Emenadia, Life-History of, 181.
 Emin Pasha, Earthworm collected by, 161, 295, 558.
Eminia (Eminodrilus) equatorialis, 163, 295, 558.
 Emmerich, —, Phagocytosis, 792.
Enantia spinifera, 43.
Encyrtus fuscicollis, Structure and Life-history of, 339.
 Endbulbs of Frog, Examining, 276.
 Endoderm, Differentiation of, 617.
 —, Origin of Blood from, 171.
 Endophytic Algae, 777.
 Endosperm, Formation of, in the Embryo-sac of Gymnosperms, 623.
 Endotrophic Mycorrhiza, 504, 779.
Engystoma, 712.
Enteromorpha, 226.
 Enteropneusta, Morphological Significance of Organic Systems of, 47.
 Entomophytic Cladosporiaceæ, 636.
Entovalva mirabilis, 332.
 Entozoa, Notices of, 175.
 Enzyme in Plants, Diastatic, 221.
 —, Lactase, A new, 374.
Eozoon, Tudor Specimen of, 613.
 Epiphyllous Inflorescences, 490.
 Epithelial Fibrillar Tissue of Annelids, 39.
 Epithelioma, Bodies resembling Psorosperms in Squamous, 754.
 Epithelium, Preparing and Examining Glandular, of Insects, 538.
 —, Preparing, of Mid-gut of Arthropods, 828.
- Epithemia*, 442.
 Eppinger, H., Pseudotuberculosis produced by a pathogenic *Cladotrix*, 511.
 Equisetaceæ, Sieve-tubes of, 775.
 —, Stem of, 376.
 Ericaceæ, Biology of, 72.
 Erlanger, R. v., Development of *Paludina vivipara*, 229, 724.
 — Generative Apparatus of *Tania Echinococcus*, 46.
 Esmarch's Rolls, Apparatus for making, 419.
 Etiolated Leaves, 758.
 — Plants, Effect of Transpiration on, 370.
 Etiolation, Changes in Plants produced by, 620.
 Ettingshausen, C. v., Atavism of Plants, 626.
Eubacillus, Genus of Bacteriaceæ, 641.
Eudorina, 226.
Euonymus, Structure of Seed, 764.
Euphrasia, Parasitism of, 369.
 Evans, J. F., Staining Pathogenic Fungus of Malaria, 551.
 Everhart, B., Sclerotoid *Coprinus*, 507.
 Evolution of Parasitic Plants, 774.
 Excretory Organ in an Oligochætous Annelid, New Form of, 596.
 Exhibition, International, at Antwerp, 271, 296, 300, 820.
 Eye, Compound, of *Macrura*, 468.
 Eye-pieces. See Contents, xxxiv.
 Eyes in Blind Crayfishes, 186.
 — of Crustacea, 591, 733.
 — of Polychæta, 738.
 — of Pulmonata Basommatophora, 455.
 —, Preparing Crustacean, 828.

F.

- Fabre-Domergue, —, Notes on Ciliated Infusorians, 355.
Fabrea salina, 355.
 Fairchild, D. G., Influence of Moisture on Dehiscent Fruits, 491.
 Fajarnes, E., Hæmatozoa of Malaria, 647.
 Fajerstajn, J., Examining the Endbulbs of Frog, 276.
 Famintzin, A., Symbiosis of Algae and Animals, 385.
 —, Zoochlorellæ, 756.
 Faris, C. C., To rectify Turpentine for Microscopical Use, 147.
 Farmer, J. B., Structure of *Isoëtes*, 376.
 Fatty-tissue, Origin of, in Insects, 587.
 Fauna of Amber, 174.
 Faurot, L., *Cerianthus membranaceus*, 480.
 Favrat, A., Obtaining Leprosy Bacilli from Living Lepers, 830.
 Fayel, —, Photomicrography in Space, 265, 294.

- Fayod, V., Structure of Living Protoplasm, 757.
- Fecundation, 447.
- of *Hydatina senta*, 48.
- Feet, Morphology of Isopod, 593.
- Feletti, R., Malaria Parasites in Birds, 755.
- Fermentation, Action of Light on Acetic, 513.
- , Micro-organisms found on ripe Grapes and their Development during, 613.
- , See Contents, xxvi.
- Fermented Liquors, Bouquet of, 77.
- Fernald, Relationships of Arthropods, 29.
- Ferns. See Cryptogamia Vasculares, Contents, xxvii.
- Fertilization, Autogenetic and Heterogenetic, 494.
- , Cross and Self, 494.
- in *Asellus aquaticus*, 187.
- of Araceæ, 68.
- of Caryophyllaceæ, 68.
- of *Iris sibirica*, 768.
- of *Lilium Martagon*, 767.
- of Newts, 576.
- of Papilionaceæ, 625.
- Phenomena, 713.
- Fibres, Rapid Staining of Elastic, 831.
- Fibrillæ, Origin of, in Connective Tissue, 451.
- Fibro-vascular Bundles, Independence of, in appendicular organs, 364.
- — — System in *Lepidodendron selaginoides*, 776.
- Ficus*, Cystoliths of, 319.
- Field, A. G., Universal Stand, 805.
- , G. W., Embryology of *Asterias vulgaris*, 476.
- , H. H., Preparation of Embryos of Amphibia, 827.
- , Pronephros and Segmental Duct in Amphibia, 711.
- Figdor, W., Nectaries of *Pteris aquilina*, 775.
- Filaments in Scales of Rhizome of *Lathræa squamaria*, 66.
- Filariæ of Birds, 195.
- Fillicineæ, Sieve-tubes of, 775.
- Filter, Steam-, 652.
- Filtering, Apparatus for, Sterilized Fluids, 273.
- , Colloidal Clay for, Fluids containing Bacteria, 835.
- , Reichel's Apparatus for, Fluids containing Bacteria, 680.
- Filtration of Organic Fluids by means of liquid carbonic acid, 682.
- Finkler-Prior Bacillus, New Criterion for distinguishing between *Bacillus Cholerae Asiaticæ* and, 142.
- Fischel, F., Bacteria of Influenza, 641.
- Fischer, A., Physiology of Woody Plants, 219.
- Fischer, A., Plasmolysis in Bacteria, 638.
- , E., Phalloideæ, 78.
- , Sclerote-forming Fungi, 507.
- , H., Anatomy of *Corambe testudinaria*, 330.
- , Development of Liver of Nudi-branchis, 725.
- , Pollen-grains, 213.
- Fish-trough, 835.
- Fissiparity in Alcyonaria, 354.
- Fixative, Deterioration of Mayer's Albumen-Glycerin, 428.
- Fixing Preparations treated by Sublimite or Silver (Golgi's Method), 830.
- Series of Sections to Slide, 428.
- Flash-light, New, for Photography, 263.
- Flask, Flat, for cultivating Micro-organisms, 131.
- Flat-worm, Parasitic in Golden Frog, 475.
- Flax, Insect-larva eating Rust on, 461.
- Flemming, W., Attraction-Spheres and Central Bodies in Tissue and Migratory Cells, 322.
- , Division of Leucocytes, 716.
- , Structure and Division of Cell, 714.
- Fletcher, J. J., *Peripatus Leuckarti*, 341.
- Fliche, L., Biology of the Ericaceæ, 72.
- Floor-dust, Pathogenic Bacillus obtained from, 512.
- Flora of Germany (Mosses), Rabenhorst's Cryptogamic, 377.
- Floral Envelopes, action of Solar Heat on, 72.
- — —, Physiological Researches on, 220.
- Organs, Vascular System of, 363.
- Florideæ, New Freshwater, 629.
- , Reproductive Organs, 777.
- Floscularia torquibata*, 302.
- Flower of Horse-chestnut, Change in Colour of, 217.
- of Snowdrop, Variations in, 63.
- , Order of Succession of Parts, 366.
- , Variations in, 490.
- -Buds, Formation, of Spring-blossoming Plants, 490.
- Flowering Plants, Protein-crystalloids in Cell-nucleus of, 362.
- Flowers and Insects, 215, 624.
- , Cleistogamic, 767.
- , Influence of External Factors on Odour of, 498.
- , Lepidopterophilous, 625.
- , Order of Appearance of Vessels in, of *Tragopogon* and *Scorzonera*, 364.
- , Self-fertilized, 216.
- Fluid, Preserving, 827.
- Fluids containing Bacteria, Reichel's Apparatus for Filtering, 680.
- Flukes, Mode of Feeding in, 44.
- Fluoride of Methylene, Antiseptic Action of, on Pyogenic Bacteria of Urine, 391.

- Focal Length, new Method of Measurement, 665.
- Focke, W. O., Change in Colour of Flower of Horse-chestnut, 217.
- , Hybridization and Crossing, 67.
- Fodor, J. v., Germicidal Action of Blood, 237.
- Foerste, A. F., Formation of Flower-buds of Spring-blossoming Plants, 499.
- Fœtal Membranes of Chelonia, 22, 449.
- Fokker, A. P., Bactericidal Properties of Milk, 514.
- , Germicidal Properties of Milk, 644.
- Fol, H., Fecundation, 447.
- Folded Tissue, 617.
- Foliage, Protection of, against Transpiration, 214.
- Foliar Fibrovascular System, 61.
- Folkestone, Foraminifera of Gault, 565.
- Follicle in Mammalian Ovary, Degeneration of, 322.
- Food, Copepoda as, 738.
- of Larvæ of Insects, 337.
- Foraminifera collected off South-west coast of Ireland, 206.
- , Estuarine, of Port Adelaide River, 356.
- of Gault of Folkestone, 565.
- of Hammerfest, 613.
- Forbes, S. A., American Terrestrial Leech, 42.
- Formica*, Stinging Apparatus in, 339.
- Fossil Algæ, 76.
- Bryozoa, Characters of, 586.
- Foster, M., the late H. Bowman Brady, 127.
- Fowl, Development of Ganglia in, 713.
- , Investigation of Ovum, 827.
- , Maturation of Egg-cell, 710.
- , — Ovum, 20.
- , Pressure within Egg of, 21.
- embryo, Effect of Micro-organisms on, 84.
- Fowler, G. R., Simple Method for Sterilizing Catgut, 535.
- Fraenkel, B., Gabbet's Stain for Tubercle Bacilli, 832.
- , C., Bacteriology, 85.
- , Microphotographic Atlas of Bacteriology, 391, 512, 803.
- Fragmentation, Indirect, 451.
- France, Diatoms of, 785.
- , Turbellaria of Coasts of, 198.
- François, P., Anatomy of *Lingula*, 728.
- , Circulation in *Arca*, 726.
- , Habits of *Murex*, 723.
- Frank, B., Assimilation of Nitrogen by Plants, 370.
- , — — by *Robinia*, 218.
- , Endotrophic Mycorrhiza, 779.
- , Symbiosis of *Rhizobium* and Leguminosæ, 639.
- Frank, G., Destruction of Anthrax Bacilli in the Body of White Rats, 83.
- Frankia subtilis*, 384.
- Fraukland, P. F., Fermentations induced by *Pneumococcus* of Friedlaender, 773.
- , P. F., & G. C., Nitrifying Process and its Specific Ferment, 374.
- Fraser, —, On Photography as an aid in Anatomical, Histological, and Embryological Work, 411.
- , T. R., Strophanthem, 60.
- Fremont, A., Extra-phloem Sieve-tubes in Root of *Eurotherææ*, 619.
- French Crustacea, New and Rare, 594.
- Frenzel, J., A Multicellular, Infusorium-like Animal, 602.
- Freshwater Floridae, New, 629.
- Infusoria from United States, 697.
- Medusa, 750.
- Mollusca, Census of Scottish, 328.
- Ostracoda, Males of, 346.
- Peridineæ, 753.
- Polyzoa, 457, 727.
- Rhizopods, 753.
- , Shell in, 752.
- Fressanges, —, Germination of Sugar-cane, 218.
- Freudenreich, E. de, Bactericidal Action of Milk, 803.
- , Germicidal Properties of Milk, 644.
- , Spongy Cheese, 511.
- Frew, W., Fermentations induced by *Pneumococcus* of Friedlaender, 773.
- Friese, H., Natural History of Solitary Bees, 462.
- Frog, Examining Endbulbs of, 276.
- , Golden, Remarkable Flat-worm Parasitic in, 475.
- , Hæmatozoa of, 754.
- , Retrolingual Membrane of, 276.
- Frogs, Breeding and Embryology, 712.
- , Phagocytosis in, 56.
- Frommann, C., Streaming Movements of Protoplasm, 171.
- Froriep, A., Development of Optic Nerves, 578.
- Fructification of *Physcia pulverulenta*, 782.
- Früh, J., Constitution and Formation of Peat, 499.
- Fruit of Cucurbitaceæ, Porosity of, 491.
- Juelandæ, 621.
- Umbelliferae, 763.
- Fruits, Geocarpous, Amphicarpous, and Heterocarpous, 491.
- , Influence of Moisture on Dehiscent, 491.
- which expel their seeds with violence, 763.
- Fucoidæ, Classification of, 629.
- of Scandinavia, 225.
- Fuess, R., Improvements in the Crystallization Microscope, 399.

- Fuess, R., Petrological and Crystallographic Microscopes, 393.
- Fülles, P., Bacteriological examination of soil of Freiburg i. B., 803.
- Fumariaceae, Alkaloid-receptacles of, 618.
- , Laticiferous System of, 212.
- Fungi, Demonstrating, in Cells, 829.
- , Metabolism of, Function of Oxalic Acid in, 772.
- , See Contents, xxix.
- Fungus of Malaria, Staining Pathogenic, 551.
- G.
- Gabbet's Stain for Tubercle Bacilli, 832.
- Gage, S. H., Picric and Chromic Acid for rapid Preparation of Tissues, 417.
- , Preparation and Imbedding of Embryo Chick, 541.
- Galeodidae, Mid-gut of, 463.
- Galician Rotifers, 351.
- Galloway, B. T., Black-rot of Grapes, 229.
- Galls on Sea-weed, 502.
- Gamaleia, —, Antitoxic Power of Animal Organism, 645.
- Gammaridae, Three Subterranean, 37.
- Gandoger, M., Longevity of Bulbils, 770.
- Ganglia in Fowl, Development of, 713.
- of Invertebrata, Terminations of Nerves in, 718.
- Garbini, A., Sarcosporidia, 356.
- Garcin, A. G., Development of Fleishy Pericarps, 366.
- , Structure of Apocynaceae, 63.
- Garstang, W., List of Opisthobranchiate Mollusca of Plymouth, 26.
- , New and Primitive Type of Compound Ascidian, 727.
- , Tunicata of Plymouth, 456.
- Gasparini, G., New species of *Streptothrix*, 803.
- Gasser, J., Method for Differential Diagnosis of Bacilli of Typhoid (Eberth), 141.
- Gastric Juice, Anti-Bacterial Properties of, 512.
- , Action of Artificial, on Pathogenic Micro-organisms, 389.
- Gastropoda. See Contents, x.
- Gastrulation in *Lacerta agilis*, 449.
- Gault, of Folkstone, Foraminifera, 565.
- Gay, F., Mode of Attachment of *Cladophora*, 503.
- , *Rhizoctonium*, 379.
- Gebia*, Excretory Apparatus of, 37.
- *major*, Formation of Eggs in Testis of, 344.
- Gehuchten, A. v., Histology of Gut in Larva of *Ptychoptera contaminata*, 183.
- , Mechanism of Secretion in Larva of *Ptychoptera contaminata*, 183.
- Gelatin, Substitute for, 824.
- Gelatin, Use of, in fixing Museum Specimens, 280.
- Generative Apparatus of *Tenia echinococcus*, 46.
- Geneva, Lake of, Pathogenic Bacteria from mud, 801.
- , —, Rhizopoda of, 752.
- Genista*, Cortical Bundles in, 365.
- Genital Ducts in Oligochaeta, 194.
- Organs of *Tenia saginata*, Anomaly of, 351.
- of Tristomidae, 474.
- System, Development of, 713.
- Geocarpous Fruits, 491.
- Geographical Distribution of Slugs, 582.
- Geotropism, 70.
- in Mosses, 373.
- Gerassinoff, J., Function of the Nucleus, 614.
- Germany, Hypogæi of, 637.
- , Rabenhorst's Cryptogamic Flora of, 377, 776.
- Germeicidal Action of Blood, 237.
- — — in different conditions of the organism, 82.
- — — -serum, 236.
- Properties of Milk, 644.
- Substance of Blood, 797.
- Germinal Layers in Isopoda, 736.
- — in *Sorex*, 317.
- Germinating Barley, Influence of Temperature on, 769.
- Germination of Planerogamia. See Contents, xxiv.
- of Spores in Saccharomyces, 782.
- of Fungi, 504.
- Gerosa, G. G., Influence of Physical Conditions on Life of Micro-organisms, 242.
- Gessard, C., Preparing Pepton-agar for Studying Pyocyanin, 534.
- , Races of *Bacillus pyocyanus*, 643.
- Giant Projection Microscope, Poeller's, 806.
- Giard, A., Budding of Larva of *Astellium spongiforme* and Pœcilogony in Compound Ascidians, 332.
- Entomophytic Cladasporiaceae, 636.
- , Parasite of Cockchafer, 636.
- Gibson, —, Suberin and Bark-cells, 488.
- Giesbrecht, W., Distribution of Copepods, 737.
- , New Pelagic Copepoda, 594.
- , Secondary Sexual Characters in Copepods, 737.
- Giesenhagen, —, Desk for Microscopical Drawing, 291.
- , C., Hymenophyllaceae, 223.
- Gill, C. H., Structure of Diatom-valves shown by sections of charged specimens, 431, 441.
- Giunti, M., Action of Light on Acetic Fermentation, 513.

- Glanders, Bacillus, Penetration of, through the intact Skin, 84.
 —, Staining Bacillus of, 550.
 Glands, Odoriferous, of Earwigs, 184.
 —, Pearl-like, of Vine, 622.
 —, Septal, of *Kniphofia*, 366.
 Glandular Epithelium of Insects, Preparing and Examining, 538.
 Glasses for Keeping Immersion Oil, 812.
Glavochete, 784.
 Glucosides, Tests for, 148.
Glycera, Innervation of Proboscis of, 469.
 Goebel, K., Javanese Hepaticæ, 73.
 —, Morphology of *Utricularia*, 67.
 Goldberg, M., Development of Ganglia in Fowl, 713.
 Gold-staining Method, Upson's, for Axis-cylinders and Nerve-cells, 425.
 Golden, K. E., Fermentation of Bread, 221.
 Golgi, G., Demonstration of Development of Parasites of Malaria by Photographs, 647.
 —, Method for fixing Preparations, 536, 830.
 —, Impregnating Brain of Amphibia by, 426.
 —, of Staining, 288.
 —, Staining Osmicous Tissue by, 426.
 Gomont, M., Oscillariaceæ, 233.
 Gonangia, Male, of *Distichopora* and *Allopora*, 481.
 Goniometer for Microscopic Crystals, 396.
Gontopelte gracilis—a new Copepod, 594.
Gonium pectorale, 76.
Gonococcus, *Diplococcus* resembling, 643.
 —, Pure Cultivations of, 132.
 Gonophores of *Allopora* and *Distichopora*, 608.
 —, Structure and Development of, 481.
 Gonoplacideæ, Post-embryonic Development of, 735.
 Göppert, E., Indirect Fragmentation, 451.
Gordius, Development of, 196.
 —, Examining Ova of, 540.
 — *tolosanus*, 349.
 Goroschankin, —, Structure and Reproduction of *Chlamydomonas*, 631.
 Gosio, B., Study of Bacterial Fermentation, 86.
 Goto, S., Connecting Canal between Oviduct and Intestine in Monogenetic Trematodes, 350.
 —, *Diplozoon nipponicum*, 472.
 Govi, Death of Prof. Gilberto, 272.
 —, G., New Camera Lucida, 254.
 —, Constructing and Calculating the Images formed by Lenses or Compound Optical Systems, 122.
 Graber, —, v., Abdominal Appendages of Insect Embryos, 730.
 —, Embryology of Insects, 729.
 Graber, —, v., Origin of Blood and Fatty-tissue in Insects, 587.
 Gradenigs, G., Bacteriological Observations on contents of Tympanic Cavity, 391.
 Graff, L. v., *Enantia spinifera*, 43.
 —, Organization of Acelous Turbellaria, 599.
 Grandis, V., Preparing and Examining Glandular Epithelium of Insects, 538.
 Granis, A., Anatomy of Plants, 485.
 Grapes, Basidiomycetes parasitic on, 637.
 —, Black-rot of, 229.
 —, Micro-organisms found on Ripe, 643.
 Graphological Microscope, 402.
 Grasses, Mestome-sheath of, 62.
 —, Perforation of Potatoes by Rhizome of, 496.
 Grassi, B., Malaria-parasites in Birds, 755.
 Gravis, A., Anatomy and Physiology of Conducting Tissues, 759.
 Green, J. R., Germination of Seed of Castor-oil Plant, 217.
 Green Leaves, 758.
 —, Diastatic Ferment in, 774.
 Greenwood, M., Action of Nicotin on Invertebrates, 327.
 Gregarines, Conjugation and Spore-forming in, 357.
 Gregory, E. L., Growth of Cell-wall, 59.
 —, J. W., Tudor Specimen of *Eozoon*, 613.
 Grehant, —, Respiration and Fermentation of Yeast, 374.
 Grenfell, J. G., 437.
 Griesbach, H., Blood of Lamellibranchs, 331.
 —, Fixing, Staining, and Preserving Cell-elements of Blood, 287.
 Griffiths, A. B., Researches on Micro-organisms, 80.
 Grobben, C., Antennary Gland of *Lucifer Reymondii*, 735.
 —, Bulbus Arteriosus and Aortic Valves of Lamellibranchs, 584.
 —, Pericardial Gland of Gastropoda, 176.
 Grosse, W., Polarizing Prisms, 253.
 Growth of Phanerogamia. See Contents, xxv.
 Guignard, L., Attractive Spheres in Vegetable Cells (Tinoleucites), 614.
 —, Localization of Active Principles of Crucifereæ, 362.
 —, New Marine Schizomycete, *Streblothericia Bornetii*, 81.
 —, Sexual Nuclei in Plants, 623.
 Guillebeau, A., Cysticercus of *Tænia saginata* in Cow, 745.
 —, *Echinococcus multilocularis* in Cow, 745.
 Gulick, J. T., Preservation and Accumulation of Cross-Infertility, 19.

- Gulland, G. L., Nature and Varieties of Leucocytes, 324.
Gunnera manicata, 761.
 Günther, C., Bacteriology, 86, 244.
 Gut in the Larva of *Ptychoptera contaminata*, 183.
 Guttifera, Embryo of some, 763.
 Gymnoasceæ, 228.
 Gymnosperms, Formation of Endosperm in Embryo-sac of, 623.
 —, Morphology and Phylogeny of, 355.
 —, Structure and Growth of Apex in, 760.
Gymnosporangium, 506.
Gyrocotyle, Distribution of, 44.
- H.
- Haase, E., Development of Nervures of Wings of Butterflies, 338.
 —, Oloriferous Organs of Lepidoptera, 337.
 Haberlandt, G., Conjugation of *Spirogyra*, 226.
 Haddon's, A. C., Collections in Torres Straits, 581.
 Haeckel, E., Plankton Studies, 326.
 Haecker, V., Maturation of Ova of *Cyclops*, 188.
 Hæmæcalcium, Staining Solution, 831.
 Hæmalum, Staining Solution, 831.
 Hæmatin, Aspergillin—a Vegetable, 486.
 Hæmatoxylin Crystals, Staining Solution made from, 831.
 — New Methods for Staining Medullary Sheath and Axis-cylinder of Nerves with, 425.
 —, Phospho-molybdc Acid, 690.
 —, Staining Medullated Nerve-fibres with, 286.
 Hæmatozoa of Frog, 754.
Hæmatozoon faleiforme, Biological Cycle of, 755.
 Hæmatozoon of Malaria, its Evolution, 56.
 —, Examining Blood for, 277.
 Hafkine, W., Experiments on Cultivation Media for Infusoria and Bacteria, 129.
Halielystus auricula var., Sensory Papillæ of, 750.
Halistemna in British waters, 481.
 Hallauer, G., Lichens of Mulberry, 634.
 Halocyprides, Mediterranean and Atlantic, 344.
 Halsted, B. D., Artificial Germination of Milk-weed Pollen, 68.
 —, Heliotropic Sundew, 772.
 —, Influence of Moisture on Dehiscent Fruit, 491.
 —, New Anthracnose of Pepper, 506.
 Halteres of Diptera, 35.
 Hamann, O., Monograph on Acanthocephalæ, 741.
 Hamann, G., Structure of Nematelminthes, 741.
 Hammer, H., Cultivating Actinomyces, 416.
 Hammerfest, Foraminifera of, 613.
 Hankin, E. H., Conflict between Organism and Microbe, 647.
 —, Cure for Tetanus and Hydrophobia, 237.
 —, Phagocytosis, 790.
 Hanks, H. G., Ancient Lenses, 251.
 Hansen, A., Vegetable Physiology, 623.
 —, E. C., Distribution of *Saccharomyces apiculatus*, 383.
 —, Germination of Spores in *Saccharomyces*, 782.
 —, H. T., Cirolanidæ and other Isopods, 186.
 Hansgirt, A., Carpotropic Curvatures of Nutation, 372.
 — *Hormidium*, *Schizogonium*, and *Hormiscia*, 778.
 —, Nyctitropic Movements of Leaves, 372.
 —, *Phragmidolithix* and *Leptolhriz*, 641.
 —, Sensitive Stamens and Stigmas, 371.
 Hariot, P., Pleiocarpous Species of *Trentepohlia*, 503.
 —, *Polycoccus*, 508.
Hariotina, 632.
 Harmer, S. F., British Species of *Crisia*, 335.
 —, Origin of Embryos in Ovicells of Cyclostomatous Polyzoa, 457.
 —, Regeneration of Lost Parts in Bryozoa, 457.
 —, *Rhynchodesmus terrestris*, 473.
Harpagophyton, Dissemination of Seeds of, 69.
 Hart, S., Materials of Microbe-raiser, 148.
 Hartlaub, C., Comatulids of Indian Archipelago, 479.
 Hartley, W. N., Spectrum of Chlorophyll, 486.
 Harvey-Gibson, R. J., Cystocarps and Antherids of *Catenella Opuntia*, 502.
 —, Histology of *Polysiphonia fastigiata*, 628.
 —, Sporangium of *Rhodocorton*, 628.
 Haswell, W. A., Remarkable Flat-worm parasitic in Golden Frog, 475.
 Haug, R., Decalcification of Bone, 587.
 —, Preparation of Tumours injected during life with anilin pigments, 548.
 —, Three Useful Staining Solutions, 547.
 Haycraft, J. B., Structure of Striped Muscle, 716.
 Heape, W., Transplantation and Growth of Mammalian Ova within a Uterine Foster-mother, 169.
 Heart of *Dentalium*, 330.

- Heat, Solar, Action of, on the Floral Envelopes, 72.
- Heating-lamp with Electric Regulator for controlling Gas-supply, 406.
- Heidenhain, M., Central Corpuseles and Attraction-spheres, 715.
- , Fixing and Staining Glands of *Triton helveticus*, 287.
- Heider, A. R. v., Coral Studies, 608.
- Heineck, O., Pericarp of Compositæ, 764.
- Heliodrilus*, 41.
- Heliotropic Sundew, 772.
- Heliotropism in Mosses, 373.
- of *Hydra*, 750.
- Helix aspersa*, Growth of Shell of, 723.
- Helminthological Studies, 199.
- Hemiasci, 633.
- Hemidiptera Hæckelii*, 340.
- Hemiptera, Male, Terminal Segment of, 35.
- Hemsley, W. H., Vitality of Seeds, 769.
- Hen's Egg, Formation of Double Embryo in, 21.
- Henschman, A. P., Method of Investigating Development of *Limax maximus*, 274.
- , Origin and Development of Central Nervous System in *Limax maximus*, 176.
- Henking, H., Early Stages of Development in Eggs of Insects, 461.
- Henneguy, L., *Fabrea salina*, 355.
- Hennings, P., Dry-rot and destruction of Wood caused by it and other Fungi, 803.
- , *Æcidium Schwainfurthii*, 78.
- Hericus, G., Placenta of Cat, 448.
- Henslow, G., Vascular System of Floral Organs, 363.
- Hepatic Epithelium of *Testacella*, 330.
- Hepaticæ, Apical Growth of, 627.
- , Javanese, 73.
- Hérail, J., Medullary Phloem in Root, 489.
- , Reproductive Organs of Phanerogams, 765.
- Herbst, C., Anatomy of *Scutigera*, 463.
- Herdman, W. A., Biological Results of Cruise of the 'Argo,' 454.
- , Classification of Tunicata, 585.
- , Copepoda as Food, 738.
- , *Ecteinascidia* and other Clavelinidæ, 456.
- , Tunicata, 726.
- Heredity, Theory of, 766.
- Herrmann, F., Origin of Karyokinetic Spindle, 715.
- Hermaphrodite Lamellibranchs, 178.
- Spider, 732.
- Hermaphroditism of Apodidæ, 188.
- Herrick, F. H., Development of American Lobster, 468.
- Hertwig, O., Experimental Studies on Ova, 19.
- , R., Study of Karyokinesis in *Paramecium*, 684.
- Hesse, —, New and Rare French Crustacea, 594.
- , R., Development of Hypogææ, 230.
- , Hypogææ of Germany, 637.
- Heterocarpous Fruits, 491.
- Heterodera Schachtii*, Stylet of, 598.
- Heterogamy, Importance on Species, 767.
- Heterogenesis in Rotifers, 200.
- Heurck. See Van Heurck.
- Hickson, S. J., Aleyonaria and Zoantharia from Port Phillip, 51.
- , Ampullæ of *Millepora Murrayi*, 480.
- , Male Gonangia of *Distichopora* and *Allopora*, 481.
- , Medusæ of *Millepora Murrayi* and Gonophores of *Allopora* and *Distichopora*, 608.
- Hieronymus, G., *Dicranochæte*, 385.
- Hildebrand, F., Sudden Changes in Form, 762.
- Hill, E. G., Cross- and Self-fertilization, 494.
- Himalayan Uredineæ, 231, 635.
- Hineks, T., Marine Polyzoa, 336, 586.
- 'Hirondelle' Gastropods, Anatomy of, 329.
- , Starfishes collected by, 477.
- Hirudinea, Histology of Nervous System of, 597.
- , Preparation of Nervous System of, 684.
- , Preparing Segmental Organs, 828.
- , Segmental Organs of, 740.
- Hirudo medicinalis*, Demonstrating Tactile Papillæ of, 540.
- Histogenesis of Neuroglia, 578.
- Histological Observation on Cœlenterata, 748.
- Histology of Fungi, 380.
- , See Contents, viii.
- History of Invention of Spectacles, Microscope, and Telescope, 269.
- Histrio sphagni*, 702.
- *vorax*, 703.
- Hofer, B., Hydroxylamin as Paralyzing Agent for small animals, 278.
- Hoffa, A., Further Contributions to Knowledge of Putrefaction Bacteria, 647.
- Hollert, J., Nutrient Layer in Testa, 61.
- Holl, M., Investigation of Fowl's Ovum, 827.
- , Maturation of Egg-cell of Fowl, 710.
- , Maturation of Ovum of Fowl, 20.
- Holmes, E. M., British Marine Algæ, 377.
- Holostomidæ, 350.
- Holothurians, Classification of, 477.
- , Development of, 604.
- Holst, A., Sketch of Bacteriology, 647.
- Holt, E. W. L., Egg and Larvæ of Teleosteans, 713.
- Honegger, J., Manipulating and Staining old and over-hardened Brains, 550.

- Hopkins, G. M., Apparatus for Gathering and Examining Microscopic Objects, 825.
 —, Some Suggestions in Microscopy, 835.
 —, G. S., Preparation and Imbedding of Embryo Chick, 541.
Hormidium, 778.
Hormiscia, 778.
 Horse-chestnut, Change in Colour of Flower of, 217.
 Horst, R., New Genus of Earthworms, *Glyphidrilus*, 193.
 Hoskins, R. W., Movements of Diatoms, 638.
 Host and Parasite, Relations between, 69.
 Hot Stage, New, and Accessories, 521.
 Hovelacque, M., Structure of Primary Fibro-vascular System in *Lepidodendron selaginoides*, 776.
 Hovorka, O. v., Criterion for distinguishing between *Bacillus Cholerae Asiaticæ* and Fiuikler-Prior Bacillus, 142.
 Howchin, W., Estuarine Foraminifera of Port Adelaide River, 356.
 Hoyer, H., Demonstrating Mucin in Tissues, 538.
 — Suitable Object for Study of "Direct," Nuclear Division, 173.
 Hoyle, W. E., Revised List of British Echinoidea, 352.
 Hubrecht, A. A. W., Development of Germinal Layers in *Soxex*, 317.
 Hudson, C. T., Address on Doubtful Points in Natural History of Rotifera, 6.
 Hueppe, T., Controversy on Phagocytosis, 244.
 Hull, G. S., Ice-cream Poisoning, 803.
 Hulle, L. V. D., Researches on Beers of Brussels with so-called spontaneous fermentation, 647.
 Hulth, J. M., Reserve Receptacles in Lichens, 383.
 Humphrey, J. E., Demonstration of Cilia of Zoospores, 541.
 Humphrey, J. E., Diseases caused by Fungi, 782.
 Hungarian Myriopoda, 184.
 Hunt, E. M., Micro-organisms and Leucocytes, 86.
 —, J. S., Evolution of Malaria, 647.
 Hurd, E. P., Diseases whose causal microbes are known, 391.
 Huth, E., Fruits which expel their Seeds with violence (Schleuderfrüchte), 763.
 —, Geocarpous, Amphicarpous, and Heterocarpous Fruits, 491.
 Hyatt, —, Substage Condenser, 256.
 Hybridization and Crossing, 67.
 Hybrids, Anatomical Characters of, 215.
 Hybridizing of *Abuca*, 769.
Hydatina senta, Determination of Sexes, 745.
Hydatina senta, Fecundation of, 48.
Hydra, Development of, 609, 684.
 —, Heliotropism of, 750.
 —, Trembley's Experiments with, 483.
 — turned inside out, 203.
Hydrastis Canadensis, Germination of, 495.
Hydrodictyon, Development of, 380.
 —, Reproduction of, 227.
 Hydrogen Peroxide, Disinfecting Property of, 799.
 Hydroids, New Family of, 482.
 Hydroids, Methods of Narcotizing, 685.
 — of Plymouth, 53.
Hydromystris, Reproduction of, 495.
 Hydrophobia, Cure for, 237.
 Hydroxylamin as Paralyzing Agent for small animals, 278.
 Hygiene, International Congress on, 300.
 Hygrometric state of air, Influence of, on leaves of Mosses, 501.
 Hygroscopic Movements, Anatomico-physical Causes of, 771.
 — Swelling and Shrinking of Vegetable Membranes, 485.
Hymenolepis, 600.
 Hymenomyces, *Mycodendron*, New Genus of, 507.
 Hymenophyllaceæ, 223.
 Hymenoptera Anthophila, British, Tongues of, 34.
 Hypertrophy of Lenticles, 488.
 Hyphomyces, New Genera, 784.
Hypoderma lineata, Host of, 35.
 Hypodermic Impregnation, Spermatophores as means of, 719.
 Hypogæi, Development of the, 230.
 — of Germany, 637.
 Hyphomyces, *Stigmoideomyces*, New Genus of, 506.
- I.
- Ichthyophis*, Investigation of Brain and Olfactory Organ, 827.
 Illuminating Apparatus, New, 443.
 Illumination, Spot Mirror, Method of, 430.
 Illuminator, Dark-ground, 836.
 Imbedding. See Contents, xxxix.
 Imber, N. H., Bacilli in the Talmud, 647.
 Imhof, O. E., Distribution of *Pedalion mirum*, 49.
 —, Exploration of Lakes, 717.
 —, Pelagic Diatoms, 79.
 Immunity, Present Position of Theory of, 390.
 —, Studies on, 240.
 — to Anthrax, 795, 796.
 Immunization against Virus of Tetanus, 796.
 Impregnation in *Riella*, 501.
 — of Central Nervous System with Mercurial Salts, 420.

- Impregnation, Spermatophores as means of Hypodermic, 719.
- Incubators, Thermoregulator for, 652.
- Indian Archipelago, Comatulids of, 479.
- Rusts and Mildews, 78.
- Infertility, Cross-, Preservation and Accumulation of, 19.
- Infiltrating Oseous and Dental Tissues, A new Method, 307.
- Inflorescences, Epiphyllous, 490.
- Influenza, Bacteria of, 641.
- , Micro-organisms of, 388.
- Infusoria, Experiments on Cultivation Media for, 129.
- from Fresh Waters of United States, 697.
- , Method of Examining Living, 141, 828.
- , Two new, 752.
- Infusorians, Notes on Ciliated, 355.
- Infusorium-like Animal, 602.
- Injecting. See Contents, xxxix.
- Inoculation from Koch's Plates, Apparatus for facilitating, 417.
- Insecta. See Contents, xii.
- , Examining Spermatozoa of, 421.
- Insect Wing Muscles, Staining Terminations of Tracheæ and Nerves in, by Golgi's Method, 288.
- Insects and Flowers, 215, 624.
- , Extremities of Embryo of, 458.
- , Preparing Glandular Epithelium of, 538.
- , Preparation of Wing-muscles of, 683.
- Integument of Seed of Cyclosporeæ, 367.
- "Intermediate Body" in Cell-division, 715.
- Intestine, Small, New Bacillus from, 512.
- Intoxicating Rye, 633.
- Intracellular Digestion in Protozoa, 483.
- Invention of Compound Microscope, 808.
- of Spectacles, Microscope, and Telescope, 269.
- Ipomæa versicolor*, Anatomy of, 620.
- Ireland, Echinodermata from S.W., 604.
- , Foraminifera off S.W. coast of, 206.
- Iris Diaphragm, Bausch and Lomb's Condenser Mounting with, 405.
- Iris sibirica*, Fertilization, 768.
- Iron, Demonstration of, in Chromatin, 828.
- Irritability of Leaves of *Dionæa*, 771.
- Ischikawa, C., Conjugation in *Noctiluca*, 484.
- , Formation of Eggs in Testis of *Gebia major*, 344.
- Isoëtes*, Life-history of, 774.
- , Structure of, 376.
- , Vascular Bundles of, 222.
- Isopod Feet, Morphology of, 593.
- Isopoda, Care of Young in, 187.
- , Embryology of, 343.
- , Germinal Layers of, 736.
- , Reproduction of, 737.
- Isopods, 186.
- Isopods., Arterial System of, 736.
- Istvánfi, J., "Meteor-paper," 777.
- Ives, J. E., Echinodermata of Yucatan and Vera Cruz, 50.
- Ixodide, Notes on, 731.

J.

- Jaboulay, —, Microbes of Acute Infectious Osteomyelitis, 243.
- Jackson, W. H., Morphology of Lepidoptera, 588.
- Jacquemin, G., Bouquet of Fermented Liquors, 77.
- Jaenicke, —, Action of Pyocyanin on Bacteria, 388.
- Jameson, H. G., British Mosses, 627.
- Janet, C., Apical System of Echinoids, 748.
- Janošik, J., Development of the Genital System, 713.
- , Development of the Reproductive System, 24.
- Janowski, T., Action of Light on Bacillus of Typhoid Fever, 802.
- Japan, *Brunia*, a new fossil Diatom from, 386.
- Java, Diatoms from, 386.
- Javanese Hepaticæ, 73.
- Jaworowski, A., Extremities of Embryo of Arachnids and Insects, 458.
- Jena, Carl Zeiss-Stiftung in, 528.
- Johnson, C., American Objective compared with the German, 405.
- , T., Dictyotaceæ, 630.
- , Phæosporeæ, 630.
- , W., and Sons, Advanced Student's Microscope, 556, 648.
- Johnston, R. M., Tasmanian Mollusca, 722.
- Johow, F., Phanerogamic Parasites, 70.
- Jost, L., Increase in Thickness of Stem and Formation of Annual Rings, 761.
- Joubin, L., Development of Chromatophores of Octopod Cephalopoda, 175.
- , Turbellaria of Coasts of France, 198.
- Jourdan, E., Epithelial Fibrillar Tissue of Annelids, 39.
- , Innervation of Proboscis of *Glycera*, 469.
- Joyeux-Laffuie, J., *Chætopterus*, 39.
- Juglandæ, Fruit and Seed of, 621.
- Julien, A., Position of Nerve-centres, 326.
- Jumelle, H., Assimilation and Transpiration, 770.
- , Assimilation by Red Leaves, 71.
- , — in Lichens, 634.
- , Influence of Anæsthetics on Assimilation and Transpiration, 373.
- Juncaceæ, Bulbs and Tubers in, 493.

K.

- Kabrhel, G., Action of Artificial Gastric Juice on Pathogenic Micro-organisms, 389.
- Kaiser, J., Histology, Structure, and Development of *Echinorhynchus*, 196, 742.
- Kamen, L., New Cultivation Vessel, 419.
- Karagüé, Earthworm collected at, 161, 295, 558.
- Karlinski, J., Apparatus for Filtering perfectly clear Agar, 131.
- Karop, G. C., Swift & Son's Improved Student's Microscope, 87.
- Karpelles, L., External Characters of Mites, 465.
- Karsten, G., Mangrove-vegetation, 620.
- , New Freshwater Floridea, 629.
- , Structure of Rhizophoræ, 365.
- , P. A., New Genera of Basidiomycetes, 79.
- Karyokinesis, Influence of Temperature on, 758.
- Study of, in *Paramecium*, 684.
- Karyokinetic Spindle, Origin of, 715.
- Kasischeuko, N., Maturation of the Ova of Elasmobranchs, 170.
- Katz, O., Phosphorescent Bacteria, 640.
- Kaufmann, P., New Application of Safranin, 690.
- , New Cultivation Medium for Bacteria, 679.
- Kayser, E., Fermentation of Cider, 222.
- , Physiology of Alcoholic Ferments of Lactose, 803.
- Keck, E., Bacteria in Ground-water of Dorpat, 245.
- Keller, C., Sponge-Fauna of Red Sea, 611.
- Kellgren, A. G., Lepidopterophilous Flowers, 625.
- Kellicott, D. S., New American Rotifer, 49.
- Keuel, J. v., A Freshwater Medusa, 750.
- Kerner v. Marilaun, A., Buds of *Semprevivum* and *Sedum*, 64.
- Kianowsky, R., Anti-bacterial Properties of Gastric Juice, 512.
- Kidney of Lamellibranchs, Primitive Structure of, 28.
- Kiel Water, Variability of Red Bacillus of, 510.
- Kienitz-Gerloff, F., Protoplasm Connection between adjacent Cells, 359.
- Kirchner, M., Bacteriological Researches on Influenza, 647.
- , Importance of Bacteriology in Public Hygiene, 514.
- , Methods of Bacteriological Research, 823.
- , O., Contrivances for Pollination, 769.
- , Diseases and Injuries of Plants, 375.
- Kirkpatrick, R., Polyzoa and Hydrozoa of Torres Straits, 581.
- Kishinouye, K., Development of Araneina, 463.
- , Development of *Limulus longispinis*, 732.
- Kitasato, S., Growth of Bacillus of Symptomatic Anthrax on solid nutrient media, 239.
- , Phagocytosis, 793.
- Kjellman, F. R., Algæ of Behring's Sea, 74.
- , Fucoidæ of Scandinavia, 225.
- Klapálek, F., Metamorphoses of *Oxyethira*, 340.
- Klebahn, H., Germination of *Closterium* and *Cosmarium*, 378.
- , Roots springing from Lenticels, 622.
- Klebs, E., Comparative Anatomy of Placenta, 448.
- , G., Formation of Vacuoles, 359.
- , Reproduction of *Hydrodictyon*, 227.
- , R., Fauna of Amber, 174.
- Klein, —, Phagocytosis, 794.
- , J., Abnormal Leaves, 765.
- , L., *Volvox* and *Eudorina*, 226.
- Klönne and Müller's New Objective Changer, 519.
- Knatz, L., Absence of Wings in Females of many Lepidoptera, 462.
- Knauer, F., Cleaning Used Slides and Cover-glasses, 833.
- Kniphofia*, Septal-glands of, 366.
- Knipowitsch, N., *Dendrogaster*, new form of Ascothoracida, 189.
- , Development of *Clione limacina*, 454.
- Knives, Sharpening Ribbon-Microtome, 689.
- , To preserve Edges of Microtome, 689.
- Knuth, P., Pollination of *Crambe maritima*, 217.
- , Pollination of Orobanchææ, 769.
- Kny, L., Abnormal Structure of Annual Rings, 487.
- , Medullary Rays, 211.
- Koch, A., Filaments in Root-tubercles of Leguminosæ, 368.
- , Influence of Gravitation on Sleep-movements of Leaves, 373.
- , Effect of Treatment on Tubercle Bacilli in Sputum, 511.
- , G. v., Alcyonacea of Bay of Naples, 353.
- , Invagination of Tentacles in *Rhizoxenia rosea* and *Asteroides calycularis*, 51.
- , Mode of examining Calcareous Bodies of Alcyonacea, 422.
- , Relation of Septa of Parent to those of Bud in *Blastotrochus*, 480.

- Koch, G. v., Terminal Polyp and Zooid in *Pennatula* and *Pterocides*, 52.
 —, L., Parasitism of *Euphrasia*, 369.
 —, Structure and Growth of Apex in *Gymnosperms*, 760.
 —, R., Bacteriological Research, 235.
 Koch's Plates, Apparatus for facilitating Inoculation from, 417.
 — -Wolz Improved Microscope Lamp, 520.
 Koenicke, F., Copulation of Water-Mites, 731.
 Kohl, F. G., Continuity of Protoplasm in Algae, 628.
 —, Formation of Calcium Oxalate, 220.
 Kölliker, A. v., Structure of Spinal Cord in Human Embryos, 325.
 Kollmann, J., Formation of Notochord in Human Embryo, 22.
 —, —, Pseudomicrobes of Normal and Pathological Blood, 800.
Kophobolemnon at Banyuls, 750.
 Korella, W., Stomates in Calyx, 621.
 Körnicke, —, Autogenetic and Heterogenetic Fertilization, 494.
 Korotneff, A., Zoological Paradoxes, 453.
 Kramer, C., Bacteriology for Agriculturists, 86.
 —, E., Mucous Fermentation, 240.
 —, P., Post-embryonic Development of Acarida, 732.
 Krasan, —, Atavism of Plants, 626.
 Kratschmer, —, Peculiar Disease of Bread, 239.
 Kraus, G., Calcium oxalate in Bark of Trees, 616.
 Kreusler, —, Assimilation and Respiration, 71.
 Krick, F., Swellings in Bark of Copper-beech, 704.
 Kruch, O., Sexual Organs and Impregnation in *Riella*, 501.
 —, Vascular Bundles of *Isoetes*, 222.
 Krueger, R., Presence of *Micrococcus pyogenes* in milk, 86.
 —, W., Fungus-parasites of Sugar-cane, 781.
 Kruse, W., Parasites of the Blood, 86.
 Kruticki, —, Permeability of Wood to Air, 71.
 Kuborn, B., Development of Vessels and Blood in the Embryonic Liver, 23.
 Kühne, H., New Method for Staining and Mounting Tubercle Bacilli, 146.
 —, W., Silicic Acid as a Basis for Nutrient Media, 130.
 Kultschitsky's, N., Nerve-stain, 287.
 —, Staining Medullated Nerve-fibres with Hæmatoxylin and Carmine, 286.
 Kuntze, G., Anatomy of Malvaceæ, 494.
- L.
- Labré, A., Hæmatozoa of Frog, 754.
 Lacaze-Duthiers, H. de, *Kophobolemnon* at Banyuls, 750.
Lacerta agilis, Gastrulation in, 449.
 Laehti, P., Histogenesis of Neuroglia, 578.
 Lactase, a new Enzyme, 374.
 Lactic Acids, Isomeric, as Criteria Diagnostic of certain species of Bacteria, 645.
 Laer, H. v., Researches on Beers of Brussels with so-called spontaneous fermentation, 647.
 Lagerheim, G. v., Musk-Fungus, 505.
 —, *Uredo Vialæ*, 231.
 Lake of Geneva, Pathogenic Bacteria from mud, 801.
 —, Rhizopoda of, 752.
 Lakes, Exploration of, 717.
 Lamarlière, G. de, Assimilation in Umbellifereæ, 770.
 —, Structure of swollen Roots in certain Umbellifereæ, 623.
 Lambotte, E., Mycelæ and Protospores of *Spherotheca Catagnei* v. *humilis* and of *Pleospora herbarum* v. *Galii aparinis*, 505.
 Lameere, A., Metamerism of Insect's Body, 33.
 —, Origin of Vertebrata, 576.
 Lamellibranchiata. See Contents, xi.
 Lamourette, —, Morphological Origin of Internal Liber, 210.
 Lamp, Heating-, with Electric Regulator for controlling Gas-supply, 406.
 —, Kochs-Wolz Improved Microscope, 520.
 Land Mollusca, Census of Scottish, 328.
 — Planarian, 742.
 Landsberg, C., History of Invention of Spectacles, Microscope, and Telescope, 269.
 Lang, A., Organization of *Cephalodiscus dodecalophus*, 201.
 Lankester, E. R., Animal Chlorophyll, 717.
 Launelougue, —, Colour and Pathogenic Difference of *Staphylococcus pyogenes aureus* and *S. albus*, 82.
 —, Osteomyelitis and Streptococci, 243.
 Lanza, D., Leaves of Aloineæ, 66.
 Lauzi, M., Classification of Diatoms, 234.
 Larva, Insect, eating Rust on Wheat and Flax, 461.
 — of *Astellium spongiforme*, Budding of, 332.
 — of *Dreissena*, 726.
 — of *Phrygane*, Role of Nucleus in Formation of Muscular Reticulum in, 461.
 — of *Ptychoptera contaminata*, Gut in, 183.

- Larva of *Ptychoptera contaminata*, Secretion in, 183.
- Larvæ, Batrachian, Examining Histologic phenomena occurring in tail of, 277.
- , Echine derm, Morphology of Bilateral Ciliated Bands of, 202.
- of British Butterflies and Moths, 339.
- of Insects, Food of, 337.
- of Lepidoptera, Preserving, with their Colour, 539.
- of Teleosts, 713.
- , Phylogeny of Lepidopterous, 589.
- Larval Development of *Amphioxus*, 319.
- Form of *Parnophorus*, 582.
- Lesage, P., Quantity of Starch in Radish, 759.
- Latex-receptacles, 618.
- Lathræa squamaria*, Filaments in Scales of Rhizome, 66.
- Laticiferous System of Fumariaceæ, 212.
- Latter, O. H., *Anodon* and *Unio*, 455.
- Laurent, E., Experiments on reduction of Nitrates by Plants, 220, 514.
- , Microbe of Tubercles of Leguminosæ, 640.
- , Nodosities on Roots of Leguminosæ, 368.
- , Variability of Red Bacillus of Kiel Water, 86, 510.
- Lautenschläger, F. & M., Heating-Lamp with Electric Regulator for controlling gas-supply, 406.
- Laveran, A., Alterations of Red Blood-corpuscles which can be confused with Hæmatozoa of Marsh Fevers, 514.
- , Examining Blood for Hæmatozoon of Malaria, 277.
- , Hæmatozoon of Malaria and its Evolution, 56.
- Leaf, Supporting-elements in, 619.
- spirals in Coniferæ, 493.
- Leaves, Abnormal, 765.
- , —, of *Vicia sepium*, 214.
- , Assimilation of, 496.
- , Green and Etiolated, 758.
- , —, Diastatic Ferment in, 774.
- , Influence of Gravitation on Sleep-movements of, 373.
- , Nyctitropic Movements of, 372.
- of Aloinæ, 66.
- of Conifers, 65.
- of Dionæa, Irritability, 771.
- of *Lotus*, 368.
- of Marine Phanerogams, 65.
- of Nymphæaceæ, 64.
- of *Portiera hygrometrica*, Movements of, 71.
- of *Viburnum*, 622.
- of Xerophilous Liliifloræ, 765.
- , Red, Assimilation by, 71.
- , Yellow and Red Colouring Matters of, 59.
- Lebedinsky, J., Development of *Daphnia* from Summer-egg, 469.
- Leconte, M. H., Function of Sieve-portion of Vascular Bundles, 211.
- Lederer, M., Effect of Micro-organisms on the Fowl-Embryo, 84.
- Lee, A. B., Sense-organ of *Salpa*, 179.
- Leech, American Terrestrial, 42.
- Leeches, Cultivating *Spirillum Obermeieri* in, 679.
- , Development of, 41.
- , preserving Malaria-plasmodia alive in, 679.
- Léger, L. J., Abnormal Germination of *Acer platanoides*, 69.
- , Laticiferous System of Fumariaceæ, 212.
- Leguminosæ and *Rhizobium*, Symbiosis of, 639.
- , Filaments in Root-tubercles of, 368.
- , Microbe of Tubercles of, 640.
- , Nodosities on the Roots of, 368.
- Lehmann, O., Liquid Crystals, 265.
- , Some Improvements in the Crystallization Microscope, 396.
- Leichmann, G., Care of Young in Isopoda, 187.
- , Oviposition and Fertilization in *Asellus aquaticus*, 187.
- , Reproduction of Isopoda, 737.
- Leidy, Death of Prof. Joseph, 532.
- , J., Notices of Entozoa, 175.
- , Parasites of *Mola rotunda*, 25.
- Lemanea, 629.
- Lemnaceæ, 377.
- Lendenfeld, R. v., Classification of Sponges, 751.
- , System of Calcareous Sponges, 611.
- Lenses, Ancient, 251.
- , Images formed by, New Method for constructing and calculating the place, position, and size of, 122.
- , Measurement of, 818.
- , New Method for Measurement of Focal Length of, 665.
- Lens-holder with Stand, 405.
- Lenticels, Hypertrophy of, 488.
- , Roots springing from, 622.
- Léon, N., *Hemidiptera Hæckelii*, 340.
- Leonhard, M., Structure of Apocynaceæ, 489.
- Lepidodendron selaginoides*, Fibro-vascular System in, 776.
- Lepidoptera, Absence of Wings in Females of many, 462.
- , Effects of different Temperatures on Pupæ of, 338.
- , Morphology of, 588.
- , Odoriferous Organs of, 337.
- , Preserving Larvæ of, with their colour, 539.
- Lepidopterophilous Flowers, 625.

- Lepidopterous Larvæ, Phylogeny of, 589.
 — Pupa, Morphology of, 588.
 Leprosy Bacilli, obtained from Living Lepers, 830.
Leptodora, Movements in Brain of, 188.
Lepton squamosum, 331.
Leptosira, 631.
Leptothrix, 641.
 Lernæopoda, new, 738.
 Leroy, C. J. A., Proof of Relation between Resolving Power of an Aplanatic Objective, and Diffraction of the finest Grating which it can resolve, 665.
 Lesage, P., Development of Root, 489.
 —, Differentiation of Endoderm, 617.
 —, — of Phloem in Root, 489.
 —, Influence of Saltiness on Formation of Starch in Vegetable Organs containing Chlorophyll, 498.
 —, — of Salt on quantity of Starch contained in Vegetable Organs, 625.
 Letellier, A., Renal Function of Acephalous Mollusca, 178.
 Leubuscher, G., Influence of Digestive Sections on Bacteria, 509.
 Leucocytes, Division of, 716.
 —, Nature and Varieties of, 324.
 Lévêillé, H., Action of Water on Sensitive Movements, 71.
 —, Exudation of Sap by *Mangifera*, 774.
 Levi-Morenos, C., Artificial Sea-water, 836.
 — D., Defensive Structure of Diatoms, 79.
 —, Food of Larva of Insects, 337.
 Lewandowski, A., On Formation of Indol and Phenol by Bacteria, 245.
 Lewis, R. T., Stridulating Organ of *Cystocælia immaculata*, 184.
 Leydig, T., Signs of Copulation in Insects, 588.
 Liber, Morphological Origin of Internal, 210.
Libyodrilus, 471.
 Lichen-Gonids, 232.
 Lichens, Assimilation in, 634.
 —, Calcareous, 383.
 —, Classification of, 230.
 —, Dependence of, on their Substratum, 634.
 —, Dissociation of, 77.
 — of Mulberry, 634.
 —, Reserve-Receptacles in, 383.
 —, Semi-, 382.
 Life-history of *Isoëtes*, 774.
 Life of certain Seeds, Duration of, 495.
 Light, Action on Acetic Fermentation, 513.
 —, — on Bacillus of Typhoid Fever, 802.
 —, Influence on Growth of Fungi, 504.
 —, — on Production of Spines, 493.
 —, — on Respiration, 772.
 Light, Magnesium Flash-, in Photomicrography, 812.
 —, New arrangement in Microscopes for the rapid change from parallel to convergent, 519.
 —, Reflected, Mirror for Illumination by, 810.
 Lighton, W., New Ocular Diaphragm, 255.
 Lignier, O., Foliar Fibrovascular System, 61.
 Lignin, Reactions of, 488.
 Liliifloræ, Leaves of Xerophilous, 765.
Lilium auratum, Production of Bulbils in, 368.
 — *Martagon*, Fertilization, 767.
Limax maximus, Investigating, 274.
 —, Origin and Development of Central Nervous System in, 176.
 Limpriecht, K. G., Rabenhorst's Cryptogamic Flora of Germany (Mosses), 377.
Limulus, Structure of Nerve-centres, 36.
 — *longispinus*, 732.
 — *Polyphemus*, Brain of, 466.
 Lindau, G., New Measuring Apparatus for Microscopical Purposes, 252.
 Lindman, C. A. M., Pollination of Mistletoe, 216.
 Line, J. E., A Colony-counter, 681.
 Lingselsheim, — v., Experimental Investigation of various Streptococci, 803.
Lingula, Anatomy of, 728.
 Linossier, G., Alcoholic Fermentation and Conversion of Alcohol into Aldehyde by "Champignon du Muguet," 773.
 —, Aspergillin—a Vegetable Hæmatin, 486.
 Linstow, — v., *Allantonema* and *Diplogaster*, 43.
 —, Structure and Development of *Tænia longicollis*, 743.
 —, *Gordius tolosanus* and *Mermis*, 349.
 —, Tæniæ of Birds and others, 47.
 Liquid Crystals, 265.
Lithobius, Ocelli of, 590.
 Liver, Embryonic Development of Vessels and Blood in, 23, 578.
 —, Examination of Embryonic, 683.
 — of Nudibranchs, 725.
 —, Origin of, 174.
 Lobster, Development of American, 468.
 Lockwood, S., *Devæa*, new Marine Genus of Saprolegniaceæ, 228.
 Locustidæ, Spermatogenesis in, 36.
 Loew, E., Contrivances for Pollination, 768.
 —, Fertilization of Papilionaceæ, 625.
 —, Metamorphosis of Vegetative Shoots in Mistletoe, 367.
 —, O., Behaviour of lower Fungi towards inorganic Nitrogen-compounds, 227.
 —, Nitrification by a Schizomyceete, 626.

Loew, O., Physiological Function of Phosphoric Acid, 625.
 Lomb, —. See Bansch and Lomb.
Lomentaria, Antherids of, 628.
 Lominsky, Symbiosis of Echinococcus and Coccidia, 475.
 Looss, A., Examining histolytic phenomena occurring in tail of Batrachian Larvæ, 277.
 Lortet, —., Pathogenic Bacteria from mud of Lake of Geneva, 801.
 —., Pathogenic Microbes of Dead Sea, 803.
 Lotherier, A., Influence of Light on Production of Spines, 493.
 —., — of Moisture of Air on Production of Spines, 214.
Lotus, Leaves of, 368.
 Lovett, E., Preparation of Delicate Organisms for the Microscope, 140.
Loxosoma anelidicola, 585.
 Lubarsch, O., Causes of Immunity, 86.
 Lubbock, J., Form and Function of Stipules, 622.
 —., Fruit and Seed of Juglandæ, 621.
 —., Leaves of *Viburnum*, 622.
Lucifer Reynaudii, Antennary Gland of, 735.
 Ludwig, F., Mucilaginous Slime on Trees, 784.
 —., Pigment of Synchytrium-galls of *Anemone nemorosa*, 60.
 —., Relationship between Plants and Snails, 499.
 —., *Uredo notabilis*, 78.
 —., H., Anatomy of Synaptidæ, 352.
 —., Classification of Holothurians, 477.
 —., Development of Holothurians, 604.
 —., H., *Echinodermata*, 748.
 —., Echinoderms of Ceylon, 351.
Lumbricus, Nephridium of, and its Blood-supply, 470.
 —., Regeneration of Tail in, 470.
 Lumière, —., Coloured Photomicrograms, 813.
 Lundström, A. N., Absorption of Rain by Plants, 375.
 Lungs, Mammalian, Nematodes of, and Lung Disease, 43.
 Lunt, J., Investigating Chemical Bacteriology of Sewage, 829.
 Lustig, A., Diagnosis of Bacteria of Water, 392.
 —., Red Bacillus from River Water, 81.
 —., Water Bacteria and their Examination, 85.
 Lwoff, B., Origin of Fibrillæ in Connective Tissue, 451.
Lycopodiaceæ, 223.
Lyda, Life-history of, 34.
 Lymphatic Cells, Transformation of, into Clasmatoocytes, 323.

M.

Maas, O., Craspedota of Plankton Expedition, 609.
 Macallum, A. B., Demonstration of Iron in Chromatin by Micro-Chemical Methods, 828.
 —., Morphology and Physiology of Cell, 450.
 Macchiati, L., Movement and Reproduction of Diatoms, 508.
 —., Yellow and Red Colouring Matters of Leaves, 59.
 Macclesfield Banks, Corals of, 51.
 McCook, H. C., American Spiders, 464.
 Macé, E., Practical Treatise on Bacteriology, 803.
 Macfarlane, J. M., Irritability of Leaves of *Dionæa*, 771.
 Machnoff, S. D., Can Bacteria be introduced into the body by being rubbed in through uninjured skin? 84.
 McKinley Tariff, Microscope and, 129.
 McMurrich, J. P., Development of *Cyanea arctica*, 481.
 —., Preservation of Marine Organisms at Naples Zoological Station, 133.
 —., Phylogeny of Actinozoa, 606.
 —., Structure of *Cerianthus americanus*, 52.
Macrura, Compound Eye of, 468.
 Maddox, R. L., Observations on various forms of Human Spermatozoa, 1.
Magelona, Distribution of, 740.
 Magini, G., New Characteristics of Nerve-cells, 420.
 —., Staining Motor Nerve-cells of *Torpedo*, 287.
 —., Structure of Nerve-cells, 716.
 Magnesium Flash-Light in Photomicrography, 812.
 — Oxalate in Plants, 59.
 Magnifying Instrument, 404.
 Magnus, P., *Diorchidium*, 783.
 —., New Uredineæ, 635.
 Maillard, G., Fossil Algæ, 76.
 Maize, Structure of Starch-grains in, 486.
 Malaquin, A., Development and Morphology of Parapodia in Syllidinae, 595.
 —., Homology of Pedal and Cephalic Appendages in Annelids, 595.
 —., Reproduction of Autolytæ, 195.
 Malaria, Hæmatozoon of, Examining Blood for 277.
 —., —, its Evolution, 56.
 —., —-parasites in Birds, 755.
 —., Staining Pathogenic Fungus of, 551.
 —., —-plasmodia, Preserving, alive in Leeches, 692.
 Malassez, L., New Lens-holder with Stand, 405.
 —., New System of Erecting, and Long Focus Objectives, 246.

- Malaxis*, Bulbils of, 66.
 Males of Freshwater Ostracoda, 346.
 Mallory, F. B., Phospho-Molybdic Acid
 Hæmatoxylin, 690.
 —, M. I., Septic and Pathogenic
 Bacteria, 80.
 Malvaceæ, Anatomy of, 494.
 Mammalia, Minute Structure of Sperma-
 tozoa of, 580.
 Mammalian Lungs, Nematodes of, and
 Lung Disease, 43
 — Ovary, Degeneration of Follicle in,
 322.
 Mammals, Sympathetic Nervous System
 in, 321.
 Man, First Stages of Placental Union in,
 315.
Mangifera, Exudation of Sap by, 774.
 Mangin, L., Disarticulation of Conids in
 Peronosporæ, 779.
 —, Structure of Peronosporæ, 381.
 Mangrove-vegetation, 620.
 Mann, G., Chlorophyll, 616.
 —, Differential Nucleolar Staining, 690.
 —, Preparing Tissens for Paraffin Im-
 bedding, with Remarks on Mounting,
 686.
 —, *Spirogyra*, 630.
 —, Staining of Chlorophyll, 689.
 Mannaberg, J., Morphology and Biology
 of *Plasmodium malarie tertianæ*, 803.
 Mannaghetta. See Beck von Mannaghetta.
 Marchal, P., Excretory Apparatus of *Pali-
 nurus*, *Gebia*, and *Crangon*, 37.
 —, —, New Genus of Fungi (Sphærop-
 sideæ), 781.
 —, Renal Secretion in Crustacea, 593.
 Marilaun. See Kerner v. Marilaun.
 Marine Invertebrate Fauna near Dublin,
 718.
 — Myriopoda, 184.
 — Organisms, Preservation of, 133.
 — Phanerogams, Leaves of, 65.
 — Polyzoa, 336, 586.
 Marktauner-Turneretscher's, G., 'Die
 Mikrophotographie,' 657.
 Marmorek, —, Bacteriology of Influenza,
 86.
 Marpmann, —, Substitutes for Agar and
 Gelatin, 824.
 Marrow, Bone-, Examining, for developing
 Red Corpuscles, 275.
 Martelli, U., Dissociation of a Lichen,
 77.
 Martin, S., Chemical Products of Growth
 of *Bacillus anthracis*, 241.
 Martinand, V., Micro-organisms found on
 Ripe Grapes, and their Development
 during Fermentation, 643.
 Masius, J., Contribution to Study of Roti-
 fers, 600.
 Mason's, R. G., Improvements in Oxy-
 hydrogen Microscopes, 89.
 Massart, J., Researches on Low Organisms,
 756.
 Masece, G., *Dictyosphaerium*, 638.
 —, *Mycodendron*, new Genus of Hy-
 menomycetes, 507.
 Masters, M. T., Morphology of Coniferæ,
 212.
 Matschinsky, N., Impregnation of Bone
 Sections with Anilin Dyes, 147.
 Mattiolo, O., Germination of Seeds of
 Papilionaceæ, 218.
 Mäule, C., Fructification of *Physcia pul-
 verulenta*, 782.
 Maupas, —, Determination of Sexes of
Hydatina senta, 745.
 —, Fecundation of *Hydatina senta*,
 48.
 Mayall, J., jun., Death, 529, 673, 837.
 —, Mechanical Stage, Zeiss's form, 433.
 —, Photomicrographs and Enlarged
 Photographs, 137, 151.
 —, Van Heurck's Microscope, 434, 558.
 Mayer, P., Hæmalum and Hæmacalcium,
 Staining Solution made from Hæma-
 toxylin Crystals, 831.
 —, Preserving Caprellidæ, 422.
 —, *Spongicola* and *Nausithoë*, 204.
 —, Albumen-Glycerin Fixative, De-
 terioration of, 428.
 Mazzoni, V., Demonstrating Structure and
 Termination of Muscular Nerves in
Gilipoda fasciata, 421.
 Measuring Apparatus for Microscopical
 Purposes, New, 252.
 Measurement of Lenses, 818.
 Measurements, Microscopical, with Camera
 Lucida, 705, 840.
 Meat-Pepton-Agar, Simplified Method for
 Preparing, 416.
 Mechanical Stage, Zeiss's form of Mayall's,
 433.
 Media, Experiments on Cultivation, for
 Infusoria and Bacteria, 129.
 — Mounting, 289.
 —, Nutrient, Preparation of, 678.
 —, —, Silicic Acid as a basis for, 130.
 —, Solid Nutrient, Growth of *Bacillus*
 on, 239.
 Medical Congress, Microscopes, Micro-
 tomes, &c., exhibited at the, 271.
 Mediterranean Halocyprides, 344.
 Medium for Bacteria Cultivation, 679.
 Medulla, Staining, 427.
 Medullary Ploem in Root, 489.
 — Rays, 211.
 — Sheath, Staining with Hæmatoxylin,
 425.
 —, —, — of Nerves of Spinal Cord,
 427.
 Medusa, Freshwater, 750.
 Medusæ of *Millepora Murrayi*, 608.
 Meehan, T., Evolution of Parasitic Plants,
 774.

- Meehan, Insects and Flowers, 624.
 —, Proterandry and Proterogyny, 215.
 —, Self-fertilized Flowers, 216.
 Megaloscope, 295.
Megascolex carulicus, 192.
Meloc, Blood of, and Use of Cantharidine, 340.
Melicertites, Characters of, 586.
 Membrane, Retrolingual, of the Frog, 276.
 Menstruum for Mounting, 290.
 Mer, E., Distribution of Starch in Woody Plants, 485.
 Mercier, A., Staining Medullary Sheath of Nerves of Spinal Cord and of Medulla, 427.
 —, Upson's Gold-staining Method for Axis-cylinders and Nerve-cells, 425.
 Mercurial Salts, Impregnation of the Central Nervous System with, 420.
Mermis, 349.
 Microblastic Ova, Blastopore in, 577.
 Merrifield, F., Effects of different Temperatures on Pupæ of Lepidoptera, 338.
 Mesoblast-bands in Annelids, 190.
 Mesoderm of Crustacea, Development of, 592.
 Mesonephros, Relation of, to Pronephros and Supra-renal Bodies, 23.
 Messea, A., Classification of Bacteria, 638.
 Mestome-sheath of Grasses, 62.
 Metabolism of Fatty Oils, 771.
 — of Fungi, Function of Oxalic Acid in, 772.
 Metallic Impregnation of the Cornea, 286.
 Metamerism of Insect's Body, 33.
 "Meteor-paper," 777.
 Methylen, Fluoride of, Antiseptic Action on Pyogenic Bacteria of Urine, 391.
 — -blue, Fixation of Stain in Preparations, 548.
 Metschnikoff, E., Phagocytosis and Immunity, 240, 392, 794.
 —, O., Anthrax Vaccination, 797.
 Meunier, L., Integument of Seed of Cyclosperrmæ, 367.
 Meyer, A., Cell-sap of *Valonia*, 631.
 Michaelsen, W., Earthworms of Berlin Museum, 596.
 Microbe of Tubercles of Leguminosæ, 640.
 — -raiser, Materials of, 148.
 Microbes, Apparatus for cultivating Anaerobic, 274.
 — of Acute Infectious Osteomyelitis, 243.
 —, Pathogenic, Action of Products secreted by, 85.
 —, —, Effect of Human Blood on, 798.
 —, their relation to Milk and Coffee, 80.
 Microchemical Methods, Demonstration of Iron in Chromatin by, 828.
 — Reactions of Tannin, 833.
 Micrococcus of Bitter Milk, New, 644.
 Micromegascope, 294.
 Micrometer, Bausch's Screw, 293.
 —, Bulloch's improved Filar, 106.
 —, Eye-piece Thread, 150.
 Micro-organisms, Action of Artificial Gastric Juice on Pathogenic, 389.
 — - —, Constant Current on Pathogenic, 799.
 — - —, Effect of, on Fowl-embryo, 84.
 — - —, Flat Flask for cultivating, 131.
 — - —, Formation of Acids by, 685.
 — - — found on Ripe Grapes, 643.
 — - — in Cancer-cells, 358.
 — - —, Influence of Physical Conditions on Life of, 242.
 — - — of Influenza, 388.
 — - —, Pathogenic, Baumgarten's Annual Report on, 86, 513.
 — - —, Researches on, 80.
 Microphotographic Atlas of Bacteriology, Fraenkel and Pfeiffer's, 512.
 Microscope and the McKinley Tariff, 129.
 —, Apparatus for rapid change from parallel to convergent polarized light in, 105, 519.
 —, Baker's Student's, 298, 516.
 —, Beck's Bacteriological "Star," 806.
 —, Bull's-eyes for, 299, 309.
 —, Carpenter's, new edition, 818, 845.
 —, College, 649.
 —, Compound, Amplifying Power of Objectives and Oculars in, 114.
 —, Dick's Petrological, 155.
 —, Divini's Compound, 808.
 —, Fuess's Petrological and Crystallographic, 393.
 —, Graphological, 402.
 —, Improvements in the Crystallization, 396, 399.
 —, Invention of Compound, 808.
 —, Johnson and Son's Advanced Student's, 556, 648.
 —, Lamp, Kochs-Wolz Improved, 520.
 —, Limits to Capacity, 814.
 —, Magnification, 412.
 —, Mirror for Illumination by Reflected Light, 810.
 —, New Projection, 439.
 —, Patents for Improving, issued in United States from 1853 to 1890, 676.
 —, Poeller's Giant Projection, 806.
 —, Premier Patent, 126.
 —, Preparation of Delicate Organisms for, 140.
 —, Slide, Electro-, for Testing Antiseptic Power of Electricity, 810.
 —, Swift's Improved Student's, 87.
 —, Utilization of Capacity of, 108.
 —, Van Heurck's, 399, 434, 558.
 Microscopes, exhibited at Medical Congress, Berlin, 271.

- Microscopes, History of Invention of, 269.
 —, Mason's Improvements in Oxy-
 hydrogen, 89.
 —, Zeiss's Crystallographic and Petro-
 graphical, 516.
 Microscopic Crystals, Goniometer for, 396.
 —, Diagnosis of Citric Acid in Plants,
 553.
 —, Exhibition at Antwerp, 271, 296,
 300, 820.
 —, Objects, Apparatus for Gathering
 and Examining, 825.
 —, Method of Drawing by Use of
 Co-ordinates, 527.
 Microscopical Drawing, Desk for, 291.
 —, Images, Diatom-Structure, Inter-
 pretation of, 637.
 —, Measurements with Camera Lucida,
 705, 840.
 —, Purposes, New Measuring Apparatus
 for, 252.
 —, —, Tank for, 824.
 —, Work, Reference Tables for, 142,
 279, 692.
 Microscopists, Meeting of American, 821.
 Microscopy and Angling, 129.
 —, Recreative, 823.
 —, Some Suggestions in, 835.
 —, Use of Monochromatic Light in,
 439.
 Microspores of Sphagnaceæ, 73.
Microstoma, Asexual Reproduction of, 198.
 —, Method of observing Asexual Repro-
 duction of, 275.
 —, Papillæ of, 742.
Microthamnion, 631.
 Microtome, Bausch and Lomb's, 145.
 —, Knives, Sharpening, 689.
 —, —, To preserve edges of, 689.
 —, Miehé's Improved Lever, 283.
 —, Strasser's Ribbon, for Serial Sections,
 281.
 Microtomes, exhibited at Medical Congress,
 Berlin, 271.
 Miehé's, G., Improved Lever Microtome,
 283.
 Migula, W., Bacteria in Water, 241.
 —, Bacteriology for Farmers, 245.
 —, Drawings of Bacteria, 79.
 —, *Gonium pectorale*, 76.
 —, Rabenhorst's Krypogamen-Flora v.
 Deutschland (Characæ), 776.
 Mikrophotographie, Marktanner-Turner-
 etscher's, 657.
 Mildews, Indian, 78.
Miliolina agglutinans, 574.
 —, *Ferussacii*, 574.
 —, *tricarinata*, 574.
 —, *venusta*, 573.
 Milk, Bitter, New Micrococcus of, 644.
 —, Blue, Non-formation of Pigment by
 Bacillus of, 81.
 —, Germicidal Properties of, 644.
- Milk, Preservation and Sterilization of,
 83.
 —, relation to Microbes, 80.
 —, -weed Pollen, Artificial Germination
 of, 68.
Millepora Murrayi, Ampullæ of, 480.
 —, —, Medusæ of, 609.
 Millson, A., Work of Earthworms on
 African Coast, 40.
 Mimicry, Protective, in Insects, 730.
 Mingazzini, P., New Monocystidea, 613.
 Miuks, A., *Atichia*, 505.
 —, *Myriangium*, 383.
 Minot, C. S., Fate of the Human Decidua
 reflexa, 169.
 —, Morphology of Blood-corpuscles, 25.
 —, Theory of Structure of Placenta,
 315.
 Miquel, —, Milk and Coffee and their
 Relation to Microbes, 80.
 —, Practical Manual for the Bacterio-
 logical Analysis of Waters, 803.
 —, P., Metallic Thermoregulators, 651.
 Mirror, Microscope, for Illumination by
 Reflected Light, 810.
 —, Spot-, Method of Illumination, 430.
 Mischke, K., Increase in thickness of
 Coniferae, 369.
 Mistletoe, Metamorphosis of Vegetative
 Shoots in, 367.
 —, Pollination of, 216.
 Mites, Classification of, 590.
 —, Embryology of, 466.
 —, External Characters of, 465.
 —, Water-, Copulation of, 731.
 Mitsukuri, K., Fœtal Membranes of
 Chelonia, 22, 449.
 Mitten, W., *Aulacomitrium*, New Genus of
 Mosses, 776.
 Möbius, M., Endophytic Algæ, 777.
 —, Results of continual Non-sexual
 Propagation, 494.
 Moeller, H., Demonstrating Fungi in
 Cells, 829.
 —, *Frankia subtilis*, 384.
 —, New Method of Spore-staining, 831.
 Moisture, Changes in Form of Plants pro-
 duced by, 620.
 —, Influence of, on Dehiscent Fruits,
 491.
Mola rotunda, Parasites of, 25.
 Molecular Forces, Antagonistic, in Cell-
 nucleus, 360.
 Moll, J. W., Sharpening Ribbon-Micro-
 tome Knives, 689.
 Mollusca. See Contents, x.
 Molluscoïda. See Contents, xi.
 Moniez, R., *Atlantonema rigidum*, 196.
 —, External Differences in Species of
Nematobothrium, 45.
 —, Males of Freshwater Ostracoda, 346.
Monobrachium parasiticum, Organization
 of, 52.

- Monochromatic light, Nelson's apparatus for obtaining, 439, 443, 556.
 Monocotylidæ, Nervous System of, 600.
 Monoecistidæ, New, 613.
Monosiga filicaulis, 638.
 — *lacustris*, 697.
Monostoma leporis, Nature of, 44.
Monstrilla and the Cymbasomatidæ, 189.
 Monteverde, N. A., Calcium and Magnesium Oxalate in Plants, 59.
 —, Chlorophyll, 758.
 —, Influence of Carbohydrates on formation of Asparagin, 497.
 Monti, A., Cellular and Parasitic Pathology, 647.
 Monticelli, F. S., *Apoblemma*, 742.
 —, Distribution of *Gyrocotyle*, 44.
 —, Ova and Embryos of *Tennocephala chilensis*, 44.
 Moore, S. Le M., Microchemical Reactions of Tannin, 833.
 —, Nature of Cells, 615.
 Morenos, D. L., Variations in the Flower, 490.
 Morgan, C. L., Nature and Origin of Variations, 717.
 —, J. H., Breeding and Embryology of Frogs, 712.
 —, T. H., Anatomy and Transformation of *Tornaria*, 475.
 —, Embryology and Phylogeny of Pycnogonids, 341.
 —, Method of preparing Ascidian Ova, 40.
 —, Origin of Test-cells of Ascidiæ, 29.
 —, Preparing Eggs of Pycnogonids, 421.
 Mori, A., Influence of Anæsthetics on Respiration, 221.
 —, New Micromycetes, 803.
 Morris, D., Germination of Sugar-cane, 485.
 Mosses. See Muscinæ, Contents, xxvii.
 —, Heliotropism and Geotropism in, 373.
 Motor Manifestations of Crustacea, 735.
 Mottier, D. M., Apical Growth of Hepaticæ, 627.
 Moults, — Le, Parasite of Cockchafer, 636.
 Moulting in *Rhynchota*, 340.
 Mounting. See Contents, xl.
 Moynier de Villepoix, —, Growth of Shell of *Helix aspersa*, 723.
 Mrazek, A., Cysticercoids of Freshwater Crustacea, 45.
 —, Development of Tæniæ of Birds, 744.
 Mucilage and other glands of the Plum-baginæ, 62.
 Mucilaginous Slime on Trees, 784.
 Mucin, Demonstrating, in Tissues, 538.
 Mucous Fermentation, 240.
 Mueller, A., Nematodes of Mammalian Lungs and Lung Disease, 43.
 Mueller, C., Collenchyme, 60.
 —, "Sanio's Bands" in Coniferæ, 488.
 —, *Willia*—New Genus of Mosses, 776.
 —, E., *Cercomonas intestinalis*, 56.
 —, H. F., History of Blood-corpuscles, 451.
 —, O., Diatoms from Java, 386.
 —, Thurgau, H., Origin of Wine-ferment, 514.
 —, Pearl-like Glands of Vine, 622.
 Mulberry, Lichens of, 634.
 Multicellular Infusorium-like Animal, 602.
Murex, Habits of, 723.
 Murray, G., *Chantransia*, *Lemanea*, and *Batrachospermum*, 629.
 —, *Cladotoele* and *Stictyosiphon*, 778.
 Muscinæ. See Contents, xxvii.
 Muscle, Striped, 716.
 —-columns, Minute Structure of, in Wing-muscles of Insects, 587.
 Muscles, Striated, of Arthropoda, 336.
 Muscular Fibres, Contraction of Living, 275.
 —, Development of, 320.
 —, Nerves, Demonstrating Structure and Termination of, in *Edipoda fasciata*, 421.
 —, Reticulum, Role of Nucleus in Formation of, in Larva of *Phrygane*, 461.
 —, System of Earthworm, 191.
 Museum Specimens, Use of Gelatin in fixing, 280.
 Musk-Fungus, 505.
 Mycelæ of *Sphærotheca Castagnei v. humilis* and *Pleospora herbarum v. Galii aparinis*, 505.
 Mycetozoa. See Contents, xxxi.
Myocodulron, new Genus of Hymenomyces, 507.
 Mycorhiza, Endotrophic, 504, 779.
 Myoparasites of Amphibia and Reptilia, 358.
Myriangium, 383.
 Myriopoda. See Contents, xiii.
 Myrmecophilous Plants, African, 626.
 —, Indian, 73.
Myrmedonia, Function of Antennæ in, 181.
Myzoehæte, a new Genus of Algæ, 75.
 Myxomycetes, Development of, 232.
 —, *Oreodella*, a new Genus of, 334.
 Myxosporidia, Structure and Development of Spores of, 55.

 N.
 Naegeli, Death of Carl Wilhelm von, 675.
 Naidiform Oligochaeta, 596.
 Naples, Aleyonacea of Bay of, 353.
 —, Zoological Station, Preservation of Marine Organisms at, 133.
 Narcotizing Hydroids, Actiniæ, &c., 685.
Nausithoe, 204.

- Nawaschin, S., Microspores of Sphagnacæ, 73.
- Nectaries of *Pteris aquilina*, 775.
- Nectary-covers, 63.
- Neetonema agile*, 472.
- Nelson, E. M., Apparatus for obtaining monochromatic light, 439, 443, 556.
- Bull's-eyes for Microscope, 299, 309, 431.
- , New Centering Substage, 257.
- , Substage Condenser: its History, Construction, and Management; and its effects theoretically considered, 90.
- Nelumbium*, Embryo of, 763.
- Nemathelminthes. See Contents, xvi.
- Nematobothrium*, External Differences in Species of, 45.
- Nematodes, Arabian, 349.
- , free, Mode of Studying, 422.
- of Mammalian Lungs and Lung Disease, 43.
- , Study of, 540.
- Nencki, —, Isomeric Lactic Acids as criteria diagnostic of certain species of Bacteria, 645.
- Nemeris*, 75.
- Nepenthes*, Digestive Properties of, 375.
- Nephelis*, Embryology of, 471.
- Nephridia, Anal, in *Acanthodrilus*, 347.
- in Oligochaeta, 194.
- Nephridium of *Lumbricus* and its Blood-supply, 470.
- Nerve-cells, New Characteristics of, 420.
- - —, Staining Motor, of *Torpedo*, 287.
- - —, Structure of, 716
- - —, Upson's Gold-staining Method for, 425.
- -centres of *Limulus*, Structure of, 36.
- - —, Position of, 326.
- -end Plates in Tendons of Vertebrata, 427.
- -Fibres, Optical Characters of Medullated and Non-medullated, 325.
- - —, Staining Medullated, with Hæmatoxylin and Carmine, 286.
- -stain, Kult-chitzky's, 287.
- Nerves, Demonstrating Structure and termination of Muscular, in *Edipoda fasciata*, 421.
- , Staining Axis-cylinder of, with Hæmatoxylin, 425.
- , — Medullary Sheath of, of Spinal Cord, 427.
- , — Terminations of, in Insect Wing Muscles by Golgi's Method, 288.
- , Terminations of, in Ganglia of Invertebrata, 718.
- Nervous Cells, Structure of, 24.
- System, Central, Development in *Blatia germanica*, 341.
- Nervous System, Central, Impregnation with Mercurial Salts, 420.
- —, —, in *Linax maximus*, 176.
- —, —, of Pulmonata, 722.
- —, —, Enterocœlic, of Echinoderms, 49.
- —, —, Histology of, of Hirudinea, 597.
- — of *Cyprina*, 27.
- — of *Diaptomus*, 344.
- — of Monocotylidea, 600.
- — of *Parnophorus australis*, 26.
- —, Preparation of, of Hirudinea, 684.
- —, Sympathetic, in Mammals, 321.
- Tissue, Preparing, of Amphibia, 420.
- Nervures of Wings of Butterflies, Development of, 338.
- Netchaëff, P., Phagocytes in relation to Infectious Pathogenic Micro-organisms, 392.
- Neuhauss, R., Magnesium Flash-Light in Photomicrography, 812.
- Neumann, E., Examining Bone Marrow for developing Red Corpuscles, 275.
- Neuroglia, Histogenesis of, 578.
- Newberry, J. S. *Sphenophyllum*, 500.
- Newspaper Science, 677.
- Newts, Fertilization of, 576.
- Nias, J. B., Cleaning Used Slides and Cover-glasses, 833.
- Nickel, E., Tannins and Trioxybenzols, 498.
- Nicolaier, A., Artificial Preparation of Sphæroliths of Uric Acid Salts, 353.
- Nicotin, Action of, on Invertebrates, 327.
- Niemilowicz, —, Peculiar Disease of Bread, 239.
- Nitrates, Reduction of, to Nitrites, by Plants, 220.
- Nitrification, 83.
- by a Schizomycete, 626.
- Organisms, and their Cultivation, 680.
- Nitrifying process and its Specific Ferment, 374.
- Nitrogen, Absorption of, 218.
- , — Atmospheric, by Plants, 496.
- , — Assimilation by *Robinia*, 218.
- , — by Plants, 370.
- , — of free Atmospheric, 771.
- , Inorganic Compounds, Behaviour of lower Fungi towards, 227.
- in Plants, Passive Circulation of, 626.
- Nitro-indol, Red, Reaction as Test for Cholera Bacilli, 242.
- Noctiluca*, Conjugation in, 484.
- Noctiluca, Colouring Power of, 839.
- Noll, F. C., Demonstrating Structure of Siliceous Sponges, 422.
- , F., Influence of External Factors on Formation and Form of Organs, 490.
- Nomenclature of Chicken Embryos, 318.

- Noniewicz, E., Staining Bacillus of Glanders, 550.
- Norman, A. M., *Bathynectes*, a British Genus, 342.
- , *Lepton squamosum*, 331.
- Norwegian North Sea Expedition, Pycnogonidea of, 185.
- Nostoc*, 233.
- Notochord in Human Embryo, Formation of, 22.
- Notommata cuneata*, 305.
- Nubecularia depressa*, 572.
- , *nodulosa*, 573.
- Nuclear Division, Suitable Object for Study of, 173.
- , Origin of Protoplasm, 208.
- Nuclei, Difference between, of Male and Female Reproductive Organs, 714.
- , Sexual, in Plants, 623.
- Nucleolar Staining, Differential, 690.
- Nucleus, Function of, 614.
- of Oomycetes during Fecundation, 632.
- of Sponges, 54.
- , Role of, in Formation of Muscular Reticulum in Larva of *Phrygane*, 461.
- Nucleolids, Oocysts of, 178.
- Nudibranchs, Liver of, 725.
- Nusbaum, J., Embryology of Isopoda, 343.
- , Morphology of Isopod Feet, 593.
- Nussbaum, M., Trembley's Experiments with *Hydra*, 483.
- Nutation, Carpotropic Curvatures of, 372.
- Nutrient Layer in Testa, 61.
- , Substratum, Silicate Jelly as, 824.
- Nutrition of Phanerogamia. See Contents, xxv.
- Nuttall, G. H. F., Contributions to our knowledge of Immunity, 245.
- , Estimation of number of Tubercle Bacilli in phthisical sputum, 833.
- Nyctitropic Movements of Leaves, 372.
- Nymphaeaceæ, Leaves of, 64.
- O.
- Objective, relation between Aplanatic, and Diffraction Gratings, 665.
- , Changer, New, 519.
- Objectives, Amplifying Power of, in the Compound Microscope, 114.
- , New System of Erecting and Long Focus, 246.
- Obregia, A., Method for fixing Preparations treated by Golgi's Method, 536, 830.
- Ocelli of *Lithobius*, 590.
- Ochler, A., Hooked Joints of Insects, 33.
- Octopod Cephalopoda, Development of Chromatophores of, 175.
- Ocular Diaphragm, New, 255.
- Oculars, Amplifying Power of, in the Compound Microscopes, 114.
- Odoriferous Organs of Lepidoptera, 337.
- Odour of Flowers, Influence of External Factors on, 498.
- Edipoda fasciata*, Demonstrating Structure and Termination of Muscular Nerves in, 421.
- Oenotherææ, Extra-phloem Sieve-tubes in Root of, 619.
- Ogata, M., Germicidal Substance of Blood, 797.
- , Substance in Blood destructive of Bacteria, 647.
- Oil-decomposing Ferment in Plants, 221.
- , Essential, in Tissue of Onion, 209.
- Oil, Immersion, Glasses for keeping, 812.
- Oka, A., Freshwater Polyzoa, 457.
- , Method of Observing *Pectinatella gelatinosa*, 539.
- Okada, —, Pathogenic Bacillus obtained from Floor-dust, 513.
- Olfactory Organ of *Triton* and *Ichthyophis*, Investigation, 827.
- Oligochaeta, Homology between Genital Ducts and Nephridia in, 194.
- , Nailiform, 596.
- , Structure of, 194.
- Oligochaetous Annelid, New Form of Excretory Organ in, 596.
- Olliff, A. S., Insect-larva eating Rust on Wheat and Flax, 461.
- Oltmanns, F., Influence of Concentration of Sea-water on Growth of Algae, 777.
- Ommatidium, Is it a Hair-bearing Sense-bud? 32.
- Onderdonk, C., Movements of Diatoms, 638.
- Onion, Essential oil in tissue of, 209.
- Ontogeny of Insects, 180.
- Oogone of *Vaucheria*, 379.
- Oomycetes, Nucleus of, during Fecundation, 632.
- Oosphere of *Vaucheria*, 379.
- Oospores formed by Union of Multi-nucleated Sexual Elements, 217.
- Ophioglossaceæ, Stem of, 224.
- , Structure of, 500.
- Ophiurids, Ovary of, 352.
- Ophthalmidium tumidulum*, 574.
- Optic Nerves, Development of, 578.
- Optical Characters of Medullated and Non-medullated Nerve-Fibres, 325.
- Optics, Schroeder's Photographic, 818.
- Orcadella*, New Genus of Myxomycetes, 384.
- Orchidææ, Aerial Roots of, 215.
- Organic Acids in Succulent Plants, 208.
- Organisms, Preparation of Delicate, for the Microscope, 140.
- , Researches on Low, 756.
- Organs, Vegetable. See Contents, xxii.
- Orobanche*, Parasitism of, 69.
- Orobanchææ, Pollination of, 769.
- Oscillariaceæ, 233.

- Osmunda*. Apical Growth of, 500.
 Osseous Tissues, Infiltrating, 307.
 ———, Staining, by Golgi's Method, 426.
 Osteomyelitis and Streptococci, 243.
 ———, Microbes of Acute Infectious, 243.
 Ostracoda, Freshwater, Males of, 346.
 Otocysts of Nuculidæ, 178.
 Otto, R., Assimilation of free Atmospheric Nitrogen, 771.
 ———, Assimilation of Nitrogen by Plants, 370.
 Ova. Amphibian, Maturation of, 21.
 ———, Ascidian, Improved Method of Preparing, 140.
 ———, Blastopore in Meroblastic, 577.
 ———, Experimental Studies on, 19.
 ———, Mammalian, within a Uterine Foster-mother, Transplantation and Growth of, 169.
 ———, of *Chironomus*, Preparing and Staining, 539.
 ——— of *Cyclops*, Maturation of, 188.
 ——— of Elasmobranchs, Maturation of, 170.
 ——— of *Gordius*, Examining, 540.
 ——— of *Temnocephala chilensis*, 44.
 Ovaries, Inferior, 491.
 Ovary, Mammalian, Degeneration of Follicle in, 322.
 ——— of Ophiurids, 352.
 Overbeek de Meyer, — van, Preparing Nutrient Agar, 416.
 Overton, E., Fertilization of *Lilium martagon*, 767.
 ———, W., Histology of Characeæ, 74.
 Ovicells of Cyclostomatous Polyzoa, Origin of Embryos in, 457.
 Oviposition in *Asellus aquaticus*, 187.
 ——— of *Agelena labyrinthica*, 731.
 Ovum of Fowl, Investigation of, 827.
 ———, Maturation of, 20.
 Oxalic Acid, Formation, Decomposition, and Function in Metabolism of Fungi, 772.
Oxyethira, Metamorphosis of, 340.
 Oxy-hydrogen Microscopes, Mason's Improvements in, 89.
Oxytricha ludibunda, 702.
 ——— *setigera*, 701.
 Oyarzun, A., Impregnating Brain of Amphibia by Golgi's Method, 426.
 Ozone, Influence of, on Growth of Bacteria, 388.
- P.
- Pachythea*, 779.
 Packard, A. S., Brain of *Limulus polyphemus*, 466.
 ———, Insects injurious to Forest and Shade Trees, 461.
 ———, Phylogeny of Lepidopterous Larvæ, 589.
 Pagnoul, —, Absorption of Nitrogen, 218.
 Palaïno, G., The Formation of the Zona Pellucida, 22.
Palaemonetes varians, 37.
Palinurus, Excretory Apparatus of, 37.
 Palla, E., Aerial Roots of Orchidæ, 215.
 ———, Formation of Cell-wall in Proto-plasts not containing a Nucleus, 360.
 ———, Pollen of *Strelitzia*, 621.
 Palladin, W., Effect of Transpiration on Etiolated Plants, 370.
 ———, Green and Etiolated Leaves, 758.
Paludina vivipara, Development of, 329, 724.
 Panzini, S., Bacteria in Sputum, 513.
 Paoletti, G., Movements of the Leaves of *Portiera hygrometrica*, 71.
 Papilionaceæ, Aleurone grains in, 615.
 ———, Fertilization of, 625.
 ———, Germination of Seeds of, 218.
 ———, Secretory System of, 617.
 Papillæ, Sensory, of *Halicystus auricula* var., 750.
 Papuli, F., Antiseptic power of Salol, 803.
 Paraffin Imbedding, Method of Preparing Vegetable and Animal Tissues for, 686.
 ———-imbedded Sections, Treatment and Manipulation of, 285.
 ——— Method, Imbedding Seeds by, 143.
Paramæcium, Karyokinesis in, 684.
 Parapodia, in Syllidinae, Development and Morphology of, 595.
 Parasite and Host, Relations between, 69.
 ——— of *Acridium peregrinum*, 636.
 ——— of Cockchafer, 636, 783.
 Parasites, Biology of, 495.
 ———, Fungus-, of Sugar-cane, 781.
 ———, ———, on Pines, 782.
 ———, Malaria, in Birds, 755.
 ———, Notes on, 742.
 ——— of *Mola rotunda*, 25.
 ———, Phanerogamic, 70.
 Parasitic Plants, Evolution of, 774.
 Parasitism of *Euphrasia*, 369.
 Parker, G. H., Compound Eyes of Crustacea, 733.
 ———, Eyes in Blind Crayfishes, 186.
 ———, Preparing Crustacean Eyes, 828.
 ———, T. J., Biological Terminology, 173.
 ———, Lessons in Elementary Biology, 451.
 Parkes, L., Relations of Saprophytic to Parasitic Micro-organisms, 647.
Parmophorus, Larval Form of, 582.
 ——— *australis*, Nervous System of, 26.
Parnassia, Staminalodes of, 213.
 Parona, C., The Genus *Vallisia*, 199.
 Parthenogenesis of Ants induced by heightened temperature, 182.
 Pasquale, A., New Pyogenic Micro-organism, 803.
 Passifloraceæ, Tendrils of, 213.

- Pasternacki, T., Cultivating *Spirillum Obermeieri* in Leeches, 679.
- Patents for improving Microscope issued in United States from 1853-1890, 676.
- Patonson, A. M., Sympathetic Nervous System in Mamma's, 321.
- Pathogenic Bacteria from mud of Lake of Geneva, 801.
- Microbes, Effect of Human Blood on, 798.
- Micro-organisms, Action of Constant Current on, 799.
- Protozoa, 484.
- Species of *Taphrina*, 383.
- Patouillard, N., *Poduzon*, 384.
- , Spores on surface of Pileus of *Polyporeæ*, 384.
- Patten, W., Is the Ommatidium a Hair-bearing Sense-bud? 32.
- Paul, F. T., Relative Permanency of Microscopical Influence of Staining and Mounting Agents, 415.
- Pea, Root Nodules of, 623.
- Pearl-like Glands of Vine, 622.
- Pearls of *Pleurosigma angulatum*, 386.
- Peat, Constitution and Formation of, 499.
- Pectinatella gelatinosa*, Method of Observing, 539.
- Pedal Appendages in Annelids, Homology of, 595.
- Pedalion mirum*, Distribution of, 49.
- Péc-Laby, E., Supporting-elements in Leaf, 619.
- Pelagic Copepoda, New, 594.
- *Zoothamnium*, New, 356.
- Pelletan, J., Pearls of *Pleurosigma angulatum*, 386.
- Pelomyza viridis*, 612.
- Pelseneer, P., Hermaphrodite Lamelli-branches, 178.
- , Lamellibranchiata, 582.
- , Otcysts of Nuculidæ, 178.
- , Primitive Structure of Kidney of Lamellibranchs, 28.
- Penard, E., Chlorophyll in the Animal Kingdom, 174.
- , Freshwater Rhizopods, 753.
- , Rhizopoda of Lake of Geneva, 752.
- Pennatula*, Terminal Polyp and Zooid in, 52.
- Penzo, B., Bacteriological observations on contents of Tympanic Cavity, 391.
- Pepper, New Anthracnose of, 506.
- Pepton-Agar, Meat, Simplified Method for Preparing, 416.
- , Preparing, for studying Pyocyanin, 534.
- Peragallo, H., Diatoms of France, 785.
- , Monograph of *Pleurosigma*, 785.
- Perdrix, L., Fermentations produced by Anaerobic Microbe of Water, 803.
- Pericardial Gland of Gastropoda, 176.
- Pericarp, in Cactaceæ, Germination within, 369.
- of Compositæ, 764.
- Pericarps, Development of Fleahy, 366.
- Perichæta indica*, 318.
- Pericycle and Periderm, 363.
- Peridinea, Freshwater, 753.
- Peripatus Leuckarti*, 341.
- , New Species of, from Victoria, 36.
- Perisomatic Plates of Crinoids, 352.
- Peristome, 73.
- , Regeneration of, in *Stentor*, 751.
- Peritoneal Cavity of Animals, New Method of Injecting Fluids into, 547.
- Pero, P., Adhesive Organs on the Tarsal Joints of Coleoptera, 34.
- Peronospora gangliiformis*, Penetration of the Host by, 780.
- Peronosporæ, Disarticulation of Conids in, 779.
- , Structure of, 381.
- Peroxide of Hydrogen, Disinfecting Property of, 799.
- Perrier, E., Starfishes collected by the 'Hirondelle,' 477.
- Perry, S. H., Study of Rhizopods, 541.
- Perugia, A., The Genus *Vallisia*, 199.
- Pestalozzia*, New, 781.
- Petr, F., Bohemian Rotifera, 351.
- Petri, R. J., Red Nitro-indol Reaction as Test for Cholera Bacilli, 242.
- Petrographical Microscopes, Zeiss's, 516.
- Petrological Microscope, Dick's, 155.
- , Fuess's, 393.
- Petruschky, —, Controversy on Phagocytosis, 244.
- , J., Flat Flask for cultivating Micro-organisms, 131.
- Peyron, J., Composition of internal Atmosphere of Plants, 497.
- Pfeffer, W., Absorption and Elimination of Solid Substances by Cells, 770.
- of Solid Substances by Proto-plasm, and Formation of Vacuoles, 58.
- , New Hot Stage and Accessories, 521.
- , Water Thermostat, 524.
- Pfeiffer, —, Pseudo-tuberculosis of Rodents, 390.
- , F., Mounting Botanical Preparations in Venetian Turpentine, 551.
- , L., Pathogenic Protozoa, 484.
- , R., Microphotographic Atlas of Bacteriology, 391, 512, 803.
- Phæosporæ, 630.
- , New Genus of, 75.
- Phagocata*, Mode of Studying, 541.
- *gracilis*, Structure of, 473.
- Phagocytosis, Controversy on, 244, 785.
- in Frogs and Birds, 56.
- Phalloidea, 78.
- Phanerozamia, Anatomy and Physiology of. See Contents, xx.

- Philibert, —, Peristome, 73.
 Phisalix, G., 514.
 Phloem, Differentiation in Root, 489.
 —, Extra, Sieve-tubes, 618.
 —, —, — in Root of *Cenothera*, 619.
 —, Internal, in Dicotyledons, 760.
 —, Medullary, in the Root, 489.
 Phloroglucin, 209.
 Phospho-Molybdic Acid Hæmatoxylin, 690.
 Phosphorescent Bacteria, 640.
 Phosphoric Acid, Physiological Function of, 625.
Phoronis, Anatomy and Histology of, 201.
 Photogenic and Plastic Nutriment of Luminous Bacteria, 800.
 Photographic Optics, 818.
 Photography. See Photomicrography, Contents, xxxv.
 —, Van Heurck's Microscope for, 399, 434, 538.
 Photomicrography, 151, 294.
 —. See Contents, xxxv.
Phragmidiothrix, 641.
Phyrgane, Role of Nucleus in Formation of Muscular Reticulum in Larva, 461.
 Phthical Sputum, Estimation of number of Tubercle Bacilli in, 833.
Phycomyces nitens, 780.
 Phyllotaxis, Spiral, 493.
 Phylogenetic Affinities of Mollusca, 721.
 Phylogeny of Actinozoa, 606.
 — of Ferns, 627.
 — of Lepidopterous Larvæ, 589.
 — of Pycnogonids, 341.
Phymosoma, 348.
Physcia pulverulenta, Fructification, 782.
 Physiology of Woody Plants, 219.
Phytophysa, 76.
 Picric Acid for rapid Preparation of Tissues, 417.
 Pigment Cells, 580.
 —, Changes in Retinal, of Cephalopods, 581.
 — of Synchronium-galls of *Anemone nemorosa*, 60.
 Pigments, Anilin, Antiseptic Value of, 798.
 Pileus of Polyporæ, Spores on Surface of, 384.
 Pillsbury, J. H., Inexpensive Reagent Block, 552.
 Pine, Scotch, Sections of Staminate Cone of, 546.
 Pines, Fungus-parasites, 782.
 Pintner, T., Morphology of Cestoda, 199.
 Pitzorno, M., Stigmatic Disc of *Vinca*, 621.
 Pizon, A., Blastogenesis of *Astellium spongiforme*, 332.
 Placenta, Comparative Anatomy of, 448.
 — of the Cat, 448.
 —, Theory of Structure of, 315.
 Placental Union in Man, 315.
Plagiopyla Itachi, 698.
 Planarian, Land, 742.
 Planarians, Victorian Land, 474.
 Plankton Expedition, *Craspedota* of, 609.
 — Studies, 326.
 Plants, Absorption of Atmospheric Nitrogen by, 496.
 —, Absorption of Rain by, 375.
 —, Anatomy of, 485.
 — and Snails, Relationship between, 499.
 —, Aquatic, Rudimentary Stomates in, 367.
 —, Ascending and Descending Current in, 371.
 —, Assimilation of Nitrogen by, 370.
 —, Changes in Form of, produced by Moisture and Etiolation, 620.
 —, Comparative Anatomy, 761.
 —, Distribution of Organic Acids in Succulent, 208.
 —, Evolution of Parasitic, 774.
 —, Oil-decomposing Ferment in, 221.
 —, Physiology of Woody, 219.
 —, Presence of a Diastatic Enzyme in, 221.
 —, Reduction of Nitrates to Nitrites by, 220.
 —, Respiration of, 374, 497.
 —, Sensitiveness of, to certain Salts, 219.
 —, Woody, Distribution of Starch at different periods of the year, 485.
 Plasmodia, Preserving Malaria, alive in Leeches, 679.
 Plasmolysis in Bacteria, 638.
 Plastic Nutriment of Luminous Bacteria, 800.
 Plastidules, 717.
 Plate, L., Anatomy of *Daudebardia* and *Testacella*, 582.
 —, Heart of *Dentalium*, 330.
 Plateau, F., Marine Myriopoda and Resistance of Air-breathing Arthropods to Immersion, 184.
 Platyhelminthes. See Contents, xvi.
 Pleiocarpous Species of *Trentepohlia*, 503.
Pleospora herbarum v. *Galli aparinis*, Mycele and Protospores of, 505.
 Plessis, G. du, New Pelagic *Zoothamnium*, 356.
Pleurosigma, Monograph of, 785.
 — *angulatum*, Pearls of, 386.
 — *Balticum*, 442.
 Plieque, A. F., Tumours in Animals, 242.
 Plumbaginæ, Mucilage and other Glands of, 62.
 Plymouth, Hydroids of, 53.
 —, List of Opisthobranchiate Mollusca of, 26.
 —, Tunicata of, 456.

- Pneumococcus* of Friedlaender, Fermentations induced by, 773.
- Podaxon*, 384.
- Podbielskij, A., Examination of Microbes of the Healthy Buccal Cavity, 647.
- Pœcilogony in Compound Ascidians, 332.
- Pœller, F., Giant Projection Microscope, 805.
- Poirault, G., Peculiarity in Root of *Ceratopteris thalictroides*, 776.
- , Sieve-tubes of Filicinæ and Equisetinæ, 775.
- , Structure of Ophioglossaceæ, 500.
- , Uredinæ and their Hosts, 231.
- Pokrofsky, D. J., Influence of some reagents on Development and Growth of *Aspergillus fumigatus*, 647.
- Polar Bodies of *Balanus*, 38.
- Polarization without a Polarizer, 406.
- Polarized Light, use of, in Observing Vegetable Tissues, 429.
- Polarizer, New, 810.
- Polarizing Prisms, 253.
- Pollen, Milk-weed, Artificial Germination of, 68.
- of *Strelitzia*, 621.
- -grains, 213.
- Pollination Contrivances, 768.
- of *Albuca*, 769.
- of *Aristolochia*, *Salvia*, and *Calceolaria*, 216.
- of *Crambe maritima*, 217.
- of Mistletoe, 216.
- of Orobanchæ, 769.
- Polychaeta, Eyes of, 738.
- Polycoecus*, 508.
- Polymitus malarizæ*, 754.
- Polyporeæ, Spores on Surface of Pileus of, 384.
- Polysiphonia fastigiata*, Histology of, 628.
- Polyzoa. See Bryozoa, Contents, xi.
- Porifera. See Contents, ix.
- Portieria hygrometrica*, Movements of Leaves of, 71.
- Porosity of Fruit of Cucurbitaceæ, 491.
- Porphyridium*, 637.
- Port Phillip, Alcyonaria and Zootharia from, 51.
- —, Crinoids of, 51.
- Portuguese Man of War, Physiology of, 482.
- Potatoes, Perforation of, by Rhizome of Grasses, 496.
- Potter, M. C., Increase in Thickness of Stem of Cucurbitaceæ, 210.
- Potter, T., Problems of Bacteriology, 245.
- Poulsen, V. A., Bulbils of *Malaxis*, 66.
- , Preparation of Aleurone-grains, 278.
- Poulton, E. B., Morphology of Lepidopterous Pupa, 588.
- , Protective Mimicry in Insects, 730.
- Powell and Lealand's New Apochromatic Condenser, 155.
- Praiola*, 75.
- Prausnitz, N., Apparatus for making Esmarch's Rolls, 419.
- , W., Apparatus for facilitating Inoculation from Koch's Plates, 417.
- , Method for making Permanent Cultivations, 415.
- Prazmowski, A., Root-nodules of Pea, 623.
- Preparation of Tumours injected during life with anilin pigments, 548.
- Preparing Objects. See Contents, xxxvii.
- Preserving Caprellidæ, 422.
- Fluid, 827.
- President's Address on Doubtful Points in Natural History of Rotifera, 6.
- Preyer, W., Anabiosis, 173.
- Prillieux, E., Disease of Beetroot, 229.
- , Fungus-parasites on Pines, 782.
- , Intoxicating Rye, 633.
- , Parasite of Cockchafer, 636; 783.
- Pringle, A., Notes on Photomicrographs exhibited at R.M.S., 263, 294, 438.
- , Practical Photomicrography, 411.
- Prisms, Polarizing, 253.
- Proboscis of *Glycera*, Innervation of, 469.
- Proceedings of the Society, 150, 293, 430, 554, 694, 837.
- Projection Microscope, New, 439.
- —, Poeller's Giant, 806.
- Pronephros in Amphibia, 711.
- , Relation to Mesonephros, 23.
- Propagation, Results of Non-Sexual, 494.
- Protanthea*, a New Actinian, 479.
- Protective Device of an Annelid, 739.
- Mimicry in Insects, 730.
- Protein, Bacteria-, relation to Inflammation and Suppuration, 802.
- -crystalloids in Cell-nucleus of Flowering Plants, 362.
- Proterandry and Proterogyny, 215.
- in Umbellifereæ, 495.
- Prothallium of Ferns, Apical Growth, 627.
- Protists, Psycho-physiological Studies, 54.
- Protophyta. See Contents, xxxi.
- Protoplasm and Life, 326.
- , Contractility in Filaments, 172.
- of Algae, Continuity of, 628.
- , See Cell-structure, Contents, xx.
- , Streaming Movements of, 171.
- , Structure of Amoeboid, 450.
- Protopopoff, N., Cultivating Actinomycetes, 416.
- , Structure of Bacteria, 803.
- Protospores of *Spherotheca Castagnei* v. *humilis* and of *Pleospora herbarum* v. *Galii aparinis*, 505.
- Prototracheata. See Contents, xiii.
- Protozoa. See Contents, xix.
- Prouho, H., *Cyclotella annelidicola*, 29.
- , Free Development in Ectoproctous Bryozoa, 728.
- , *Toxosoma annelidicola*, 585.

- Prudden, T. M., Action of dead Bacteria in living body, 803.
 —, *Bacillus versicolor*, 245.
 Prunet, A., Dormant Buds in Woody Dicotyledons, 64.
 —, Perforation of Potatoes by Rhizome of Grasses, 496.
 Pruvot, G., Development of a *Solenogaster*, 27.
 Pseudanthry, Theory of, 213.
 Pseudomicrobes of Normal and Pathological Blood, 800.
 Pseudo-tuberculosis of Rodents, 390.
 — produced by a pathogenic *Cladotrix*, 511.
 Psorosperms, Bodies resembling, in Squamous Epithelioma, 754.
 Psycho-physiological studies on Protists, 54.
Pteris aquilina, Nectaries of, 775.
Pteroisides, Terminal Polyp and Zooid in, 52.
 Pteropoda. See Contents, x.
Ptychoptera contaminata, Gut in Larva, 183.
 —, Secretion in Larva, 183.
Puccinia parasitic on Saxifragaceæ, 635.
 — *digraphidis*, 78.
 — *Gerani sylvatici*, Life-history, 384.
 — *Hieracii*, Bacteria in Colonies of, 641.
 Pulmonata Basommatophora, Eyes of, 455.
 —, Central Nervous System, 722.
 Pupa, Morphology of Lepidopterous, 588.
 Pupæ of Lepidoptera, Effects of Different Temperatures on, 338.
 Purjewicz, K., Influence of Light on Respiration, 772.
 Purvis, G. C., On Immunity from Infectious Disease, 392.
 Pycnogonidea of Norwegian North Sea Expedition, 185.
 Pycnogonids, Embryology and Phylogeny of, 341.
 —, Preparing Eggs of, 421.
 Pyocetanin, Action of, on Bacteria, 388.
 Pyocyanin, Preparing Pepton-agar for studying, 534.
Pyrosoma, Embryonic Development, 178.
- Q.
- Quartz-wedge Comparator, 394.
 Queensland Rotifera, 200.
 Quekett Club, President's Address, 666.
 Query, 149.
 Quinquad, —, Respiration and Fermentation of Yeast, 374.
- R.
- Rabenhorst's Cryptogamic Flora of Germany (Characeæ), 776.
 — (Mosses), 377.
 Radish, Starch in, 759.
 Radlkofer, I., Cystoliths, 62.
 —, Structure of Sapindaceæ, 67.
 Rae, C., Premier Patent Microscope, 126.
 Rafter, G. W., Biological Examination of Potable Water, 148.
 —, Septic and Pathogenic Bacteria, 80.
 Railliet, A., Feeding in Flukes, 44.
 —, Nature of *Monostoma leporis*, 41.
 —, Parasitic Origin of Pernicious Anæmia, 47.
 Rain, Absorption of, by Plants, 375.
Ramalina reticulata, 505.
 Randolph, H., Regeneration of Tail in *Lumbricus*, 470.
 Rausome, A., Conditions that modify Virulence of Tubercle-Bacillus, 237.
Ramularia on Cotton, New, 78.
 Ranvier, L., Clasmatoocytes, 323.
 —, Preparing Retrolingual Membrane of Frog, 276.
 —, Study of Contraction of Living Muscular Fibres, 275.
 —, Transformation of Lymphatic Cells into Clasmatoocytes, 323.
 Rath, O. v., Dermal Sense-organs of Crustacea, 734.
 Rats, White, Destruction of Anthrax Bacteria in the Body of, 83.
 Ravaz, L., Cuttings of the Vine, 62.
 Rawitz, B., Changes in Retinal Pigment of Cephalopods, 581.
 Reactions, Microchemical, of Tannin, 833.
 — of Lignin, 488.
 Reagent Block, Inexpensive, 552.
 Recker, P., Sound-organs of Dytiscidæ, 589.
 Red Pigment-forming Organism, 640.
 — Sea, Sponge-fauna of, 611.
 Reference Tables for Microscopical Work, 142, 279, 692.
 Regel, R., Influence of External Factors on Odour of Flowers, 498.
 Regeneration of Lost Parts in Bryozoa, 457.
 — of Peristome in *Stentor*, 751.
 Regulator, Electric, for controlling Gas-supply of Heating-lamp, 406.
 Reichel's Apparatus for Filtering Fluids containing Bacteria, 680.
 Reinhard, L., *Glæochæte*, 784.
 Reinke, J., Re-softening dried Algæ, 829.
 —, Sphaecelariaceæ, 225, 778.
 Reinsch, P. F., New Genera of Algæ, 226.
 Renal Function of Acephalous Mollusca, 178.
 — Organs of Decapod Crustacea, 467.
 — Secretion in Crustacea, 593.
 Reproduction of *Chlamydomonas*, 631.
 — of Isopoda, 737.
 — of Phanerogamia. See Contents, xxiv.
 Reproductive Organs, Difference between Nuclei of Male and Female, 714.

- Reproductive Organs of *Diopatra*, 595.
 ——— of Floridæ, 777.
 Reptilia, Myoparasites of, 358.
 Reserve Receptacles in Lichens, 383.
 Respiration in Plants, 71.
 ———, Influence of Light on, 772.
 ——— of Phanerogamia. See Contents, xxvi.
 ——— of Plants, Influence of high altitudes on, 71.
 Respiratory Organs of Arthropods, 586.
 Retinal Pigment of Cephalopods, Changes in, 581.
 Retzius, G., The Formation of the Zona pellucida, 22.
 Rex, G. A., Development of Myxomycetes and new Species, 232.
 Rhabdocœle Turbellaria, 196.
Rhinops orbiculodiscus, 304.
Rhizobium and Leguminosæ, Symbiosis of, 639.
Rhizoclonium, 379.
 Rhizome of Ferns, 500.
 ——— of Grasses, Perforation of Potatoes by, 496.
 Rhizophoræ, Structure of, 365.
 Rhizopoda of Lake of Geneva, 752.
 Rhizopods, Freshwater, 753.
 ———, Shell in Freshwater, 752.
 ———, Study of, 541.
Rhizoxenia rosea, Invagination of Tentacles in, 51.
Rhodocorton, Sporangia of, 628.
 Rhumbler, L., Origin and Growth of Shell in Freshwater Rhizopods, 752.
Rhynchodermus terrestris, 473.
Rhynchota, Moulting in, 340.
 Ribbert, —, Present Position of Theory of Immunity, 390.
 Richard, J., Nervous System of *Diaptomus*, 345.
 ———, Test-gland of Freshwater Copepoda, 38.
 Richards, H. M., *Chreocolax*, 778.
 ———, Structure of *Zonaria*, 378.
Riella, Sexual Organs and Impregnation in, 501.
 Rietsch, M., Micro-organisms found on Ripe Grapes, 643.
 Ritter, R., Development of *Chironomus*, 183.
 ———, Preparing and Staining Ova of *Chironomus*, 539.
 Robertson, C., Contrivances for Pollination, 769.
 ———, Flowers and Insects, 215.
 ———, D., New British Amphipods, 594.
Robinia, Assimilation of Nitrogen by, 218.
 Rodents, Pseudo-tuberculosis of, 390.
 Rodham, O., Sieve-septum of Vessels, 364.
 Roebuck, W. D., Census of Scottish Land and Freshwater Mollusca, 328.
 Roger, G. H., Germicidal Action of Blood-serum, 236.
 Rohde, E., Histology of Nervous System of Hirudinea, 597.
 ———, Preparation of Nervous System of Hirudinea, 684.
 Rolfe, R. A., Sexual Forms of *Catasetum*, 369.
 Rollett, A., Structure of Striped-Muscle, 716.
 Romanowski, D. S., Structure of Parasites of Malaria, 647.
 Rommier, A., Preparing Wine Ferments, 230.
 Root, Development of, 489.
 ———, Differentiation of Phloem in, 489.
 ———-hairs, Growth of, 493.
 ———, Medullary Phloem in, 489.
 ———-nodules of Pea, 623.
 ——— of *Ceratopteris thalictroides*, 776.
 ——— of (E)nothereæ, Extra-phloem Sievetubes in, 619.
 ———-tubercles of Leguminosæ, Filaments in, 368.
 Roots, Aerial, of Orchidæ, 215.
 ——— of *Ceanothus*, Tubercles on, 766.
 ——— of Leguminosæ, Nodosities on, 368.
 ——— springing from Lenticels, 622.
 ———, Structure of swollen, in certain Umbellifera, 623.
 ———, Tuberosus, Internal Atmosphere, 371.
 ——— without a Root-cap, 765.
 Roscoe, Sir H. E., Investigating Chemical Bacteriology of Sewage, 829.
 Rosen, F., Importance of Heterogamy in formation and maintenance of species, 767.
 Rosenplenter, B., Spiral Phyllotaxis, 493.
 Rosoll, A., Tests for Glucosides and Alkaloids, 148.
 Rosseter, T. B., Cysticercus of *Tania coronula* found in *Cypris*, 296.
 ———, Development of *Tania lanceolata* from Duck, 438.
 ———, *Tania coronula*, 745.
 Rossi, O., Maturation of Amphibian Ova, 21.
 Rostrup, E., Fungi parasitic on Forest-trees, 229.
 ———, New Ustilaginæ, 77.
 Rothert, W., Development of Sporangia in Saprolegniacæ, 382.
 Rotifer, New American, 49.
 Rotifera, Bohemian, 351.
 ———, Doubtful points in the Natural History of, 6.
 ———, New and Foreign, 301, 431.
 ———, Queensland, 200.
 Rotifers, Anatomy of, 601.
 ———, Contribution to Study of, 600.
 ———, Desiccation of, 745.
 ———, Galician, 351.
 ———, Heterogensis in, 200.

- Rotifers, new, 745.
 —, Notes on, 201.
 Rotten-stone, Structure of, 423.
 Roule, L., Development of Germinal Layers of Isopoda, 736.
 —, — of Mesoderm of Crustacea, 592.
 —, — of Muscular Fibres, 320.
 —, Trochozoa, 327.
 Rousselet, C., *Amphileptus flagellatus*, 55.
 —, *Dinops longipes*, 201.
 —, Vibratile Tags of *Asplanchna amphora*, 201.
 Roux, —, Thermo-regulator for large Drying-stoves and Incubators, 652.
 —, G., Alcoholic Fermentation and Conversion of Alcohol into Aldehyde by "Champignon du Muguet," 773.
 —, Colourability of Tubercle Bacilli, 690.
 —, Phagocytosis, 785.
 Rovighi, A., Germicidal Action of Blood in Organism, 82.
 Rowler, W. W., Imbedding and Sectioning Seeds by Paraffin Method, 143, 423.
 Roze, E., Action of Solar Heat on Floral Envelopes, 72.
 —, *Urocystis Viola* and *Ustilago antherarum*, 506.
 Rubner, —, Water-Bacteria, 245.
 Rübsaamen, E. H., A new *Cecidomyia*, 35.
 Ruffer, A., Destruction of Micro-organisms by Amœboid Cells, 86.
 Rush, W., Penetration of the Host by *Peronospora gangliformis*, 780.
 Russell, H. W., Effect of Corrosive Sublimate on Fungi, 381.
 —, W., Abnormal Leaves of *Vicia sepium*, 214.
 —, Cortical Bundles in *Genista*, 365.
 —, Tendrils of Passifloraceæ, 213.
 Russo, A., Ovary of Ophiurids, 352.
 Rust on Wheat and Flax, Insect-larva eating, 461.
 Rus's, Indian, 780.
 Ryder, J. A., Development of *Engystoma*, 712.
 —, Methods of Contractility in Filaments of Protoplasm, 172.
 —, Yolk-sac of Young Toad-fish, 170.
 Rye, Intoxicating, 633.
- S.
- Sabatier, A., Spermatogenesis in Locustidæ, 36.
 Saccardo, P. A., Divini's Compound Microscope, 808.
 —, Invention of Compound Microscope, 808.
Saccharomyces, Germination of Spores, 782
Saccharomyces apiculatus, Distribution, 383.
 Sacharow, N., Preserving Malaria-plasmodia alive in Leeches, 679.
 Sadebeck, R., Pathogenic Species of *Taphrina*, 383.
 Safranin, New Application of, 690.
 Saint-Remy, G., Genital Organs of Tristomidæ, 474.
 —, Nervous System of Monocotylidæ, 600.
Salamandra atra, Development of, 318.
 Salensky, W., Embryonic Development of *Pyrosoma*, 178.
 Salomonsen, C. J., Elementary Technique of Bacteriology, 803.
Salpa, Sense-organ of, 179.
Salpina cortina, 305.
Salpingoeca brunnea, 698.
 Salt, Influence of, on Starch contained in Vegetable Organs, 498, 625.
 Salts, Sensitiveness of Plants to, 219.
Salvia, Pollination of, 216.
 Sanarelli, G., *Bacillus hydr. fuscus*, 509.
 —, Natural Immunity to Anthrax, 796.
 "Sanio's Bands" in Coniferæ, 488.
 Sap, Exudation of, by *Mangifera*, 774.
 Sapindaceæ, Structure of, 67.
 Saposchnikoff, W., Formation and Transport of Carbohydrates, 370.
 Saprolegniaceæ, Development of Sporangia in, 382.
 —, *Devea*, A new marine Genus of, 228.
 —, parasitic on Algæ, 228.
 Sarcosporidia, 356.
Sargassum, 75.
 Sars, G. O., Pycnogonidia of Norwegian North Sea Expedition, 185.
 Saunders, E., Tongues of British Hymenoptera Anthophila, 34.
 —, E. R., Septal Glands of *Kniphofia*, 366.
 Sauvageau, C., Leaves of Phanerogams, 65.
 —, Rudimentary Stomates in Aquatic Plants, 367.
 —, Stem of Cymodoceæ, 764.
 —, — of *Zostera*, 492.
 Sawtschenko, J., Immunity to Anthrax, 795.
 Saxifragaceæ, Anatomy of, 365.
 —, *Puccinia* parasitic on, 635.
 Scandinavia, Fucoidæ of, 225.
 Schaar, F., Reserve-receptacles in Buds of *Ash*, 212.
 Schäfer, E. A., Minute Structure in Wing-muscles of Insects, 587.
 —, Preparation of Wing-muscles of Insects, 683.
 —, Structure of Amœboid Protoplasm, 450.
 Schaffer, J., Kultschitzky's Nerve-stain, 287.
 Scheibenzuber, D., Brown-staining Bacillus, 146.

- Scherffel, A., Filaments in the Scales of the Rhizome of *Lathræa squamaria*, 66.
- Schewiakoff, W., Striated Muscles of Arthropoda, 336.
- , Zooclorella, 756.
- Schiavuzzi, B., *Bacillus malaris*, 641.
- Schleiff-rdecker, P., Kochs-Wolz Improved Microscope Lamp, 520.
- Schilling, A. J., Freshwater Peridinea, 753.
- Schminkewitsch, W., Classification of Animal Kingdom, 452.
- , Morphological Significance of Organic Systems of Enteropneusta, 47.
- Schimper, A. F. W., Protection of Foliage against Transpiration, 214.
- Schizogonium*, 75, 778.
- Schizomyete, Nitrification by a, 626.
- Schizomyetes. See Contents, xxxi.
- Schizophycæ. See Contents, xxxi.
- Schlater, G., Sensory Papillæ of *Halicystus auricula* var., 750.
- Schleuderfrüchte, 763.
- Schmidt, A., Atlas der Diatomaceen-Kunde, 508.
- , C., Leaves of Xerophilous Liliifloræ, 765.
- , E., Use of Gelatin in Fixing Museum Specimens, 280.
- , F., Development of Central Nervous System of Pulmonata, 722.
- , R. M., Absorption and Metabolism of Fatty Oils, 771.
- Schmorl, G., Pathogenic *Streptothrix*, 804.
- Schneider, A., Arterial System of Isopods, 736.
- , Circulating and Respiratory Organs of some Arthropods, 586.
- , Early Stages in Development of Elasmobranchs, 170.
- , K. C., Cell-structure, 171, 579.
- , Histological Observations on Coelenterata, 748.
- Schottlaender, T., Degeneration of Follicle in Mammalian Ovary, 322.
- Schroeder, H., Photographic Optics, 818.
- Schrön, —, v., Development of Microorganisms, 86.
- Schrötter, H. v., Bacillus developing a green Pigment, 238.
- , Pure Cultivations of *Gonococcus*, 132.
- , J., Sclerote-forming Fungi, 507.
- Schuberg, A., *Stentor caruleus*, 205.
- Schulz, N. K., Preparation of Nutrient Media, 678.
- Schulze, A. P., Death of, 273.
- , F. E., Crystalline Style, 177.
- Schumann, K., African Myrmecophilous Plants, 626.
- , Myrmecophilous Plants, 73.
- , Order of Succession of parts of Flower, 366.
- Schumann, P., Variations in Anatomical Structure of same Species, 487.
- Schuppan, P., Wood of Conifers, 487.
- Schütz, —, Protozoon and Coccidium-like Micro-organisms in Cancer-cells, 358.
- Schwartz, E., Presence of Bacteria in Waters containing Carbonic Acid, 392.
- Schweinitz, E. A. v., Chemical Products of Bacterial Growth, and their Physiological Effects, 804.
- Schwendener, S., Mestome-sheath of Grasses, 62.
- Sclavo, A., Study of Bacterial Fermentation, 86.
- Sclerote-forming Fungi, 507.
- Sclerotoid *Coprinus*, 507.
- Scorzonera*, Order of Appearance of Vessels in Flowers of, 364.
- Scotch Pine, Sections of Staminate Cone of, 546.
- Scott, D. H., Anatomy of *Ipomæa versicolor*, 620.
- , Internal Phloem in Dicotyledons, 760.
- Scottish Land and Freshwater Mollusca, 324.
- Scutigera*, Anatomy of, 463.
- Scyphostoma of *Cotylorhiza*, *Aurelia*, and *Chrysaora*, 203.
- Seaman, W. H., College Microscope, 649.
- Sea-water, Artificial, 836.
- , —, Influence on Growth of Algae, 777.
- weed, Galls on, 502.
- Sectioning. See Cutting, Contents, xxxix.
- Sections, Hints for fixing, to the Slide, 428.
- Secretion in Larva of *Ptychoptera cunctinata*, 183.
- Secretions, Influence of Digestive, on Bacteria, 509.
- Secretory System of Papilionacæ, 617.
- Sedum*, Buds of, 64.
- Seed, Development of Integument of, 491.
- of Castor-oil Plant, Germination of, 217.
- of Cruciferæ, Integuments of, 492.
- of Cyclospemæ, Integument of, 367.
- of *Euonymus*, Structure of, 764.
- of Juglandæ, 621.
- of Umbelliferæ, 763.
- Seeds, Duration of Life of certain, 495.
- expelled by their fruits with violence, 763.
- , Imbedding and Sectioning Mature, 423.
- , Imbedding by Paraffin Method, 143.
- of *Harpagophyton*, Dissemination of, 69.
- of Papilionacæ, Germination of, 218.
- , Vitality of, 769.
- Segmental Duct in Amphibia, 711.
- Organs of *Hirudinea*, Preparing, 828.

- Segmentation, Primitive, of Vertebrate Brain, 449.
- Selaginella lepidophylla*, 222.
- Selenka, E., Development of Apes, 316.
- , First Stages of Placental Union in Man, 315.
- Seligmann, J., Campanulacæ and Compositæ, 63.
- Selivanow, J., Reactions of Lignin, 488.
- Selle, G., Microscope Mirror for Illumination by Reflected Light, 810.
- Semon, R., Morphology of Bilateral Ciliated Bands of Echinoderm Larvæ, 202.
- , Relation of Mesonephros to the Pro-nephros and Supra-renal Bodies, 23.
- Sempervivum*, Buds of, 64.
- Sendall, Sir W., Improved Method of making Microscopical Measurements with Camera Lucida, 705, 840.
- Sense-organ of *Salpa*, 179.
- Sense-organs, Dermal, of Crustacea, 734.
- Sensory Papillæ of *Haliolystus auricula* var., 750.
- Septal-glands of *Kniphofia*, 366.
- Serafini, A., & J. Serata, Action of Woods on Micro-organisms transported by Winds, 647.
- Serpula dianthus*, Anatomy and Histology of, 739.
- Service, R., *Perichæta indica*, 348.
- Setchell, W. A., *Doassansia*, 780.
- , *Tuomeya fluvialis*, 378.
- Sewage, Chemical Bacteriology of, 829.
- Seward, A. C., *Sphenophyllum* and *Asterophyllites*, 73.
- Sexual Characters in Copepods, 737.
- Dimorphism of *Copepoda ascidiicola*, 38.
- Nuclei in Plants, 623.
- Organs in *Riella*, 501.
- Sharp, B., Land Planarian, 742.
- , D., Terminal Segment of Male Hemiptera, 35.
- Shell, Growth of, *Helix aspersa*, 723.
- in Freshwater Rhizopods, 752.
- Shiple, A. E., *Phymosoma*, 348.
- Shore, T. W., Origin of the Liver, 174.
- Shrubsole, W. H., New Diatoms, *Streptotheca Tamesis*, 785.
- Sicher, E., Embryology of Mites, 466.
- Sieve-fascicles in Secondary Xylem of Belladonna, 618.
- septum of Vessels, 364.
- tubes, Extra-phloem, 618.
- , —, —, in Root of Ctenothæra, 619.
- - — of Filicinæ and Equisetinæ, 775.
- Sigmoideomyces*, new Genus of Hyphomycetes, 506.
- Signund, W., Oil-decomposing Ferment in Plants, 221.
- Silicate-jelly as a Nutrient Substratum, 824.
- Siliceous Sponges, Demonstrating Structure of, 422.
- Silicic Acid, Basis for Nutrient Media, 130.
- Silver, Fixing Preparations treated by, 536, 830.
- Simck, F., Structure of Cotyledons, 764.
- Simmons, W. J., *Biomyra vagans*, 753.
- Simon, T., Magnifying Instrument, 404.
- Simroth, H., The Genus *Atopus*, 724.
- Siphon-dropping-bottle, Capillary, 652.
- Siphonææ, New Genus of, 227.
- Sipunculus Gouldi*, Anatomy of, 42.
- *nudus*, Anatomy and Histology, 598.
- —, Mode of Investigating, 684.
- Sirena, S., Micro-organisms of Influenza, 388.
- Sjöbring, N., Parasitic Protozoid Organism in Cancer, 357.
- Sladen, W. P., Echinodermata from South-west Ireland, 604.
- Slater, C., Red-pigment-forming Organism, 640.
- Sleep-movements of Leaves, Influence of Gravitation on, 373.
- Sle-kin, P., Silicate-jelly as a Nutrient Substratum, 824.
- Slides, Cleansing used, 833.
- Slime, Mucilaginous, on Trees, 784.
- Sloan, A. D., *Halistemma* in British Waters, 481.
- Slugs, Geographical Distribution of, 582.
- Smirnow, A., Preparing Nervous Tissue of Amphibia, 420.
- Smith, A. L., Cystocarp of *Callophyllis*, 629.
- , E. A., Mollusca of Torres Straits, 581.
- , T., Acid- and Alkali-formation by Bacteria, 82.
- , Observations on Variability of Disease Germs, 245.
- , Remarks on Production of Acids and Alkalies in Bacteria, 515.
- Snails and Plants, Relationship, 499.
- Snowdrop, Variations in the Flower of, 63.
- Sokolowa, C., Formation of Endosperm in the Embryo-sac of Gymnosperms, 623.
- Solenogaster*, Development of a, 27.
- Solger, B., "Intermediate Body" in Cell-division, 715.
- , Pigment-cells, 580.
- , Polar Bodies of *Balanus*, 38.
- Soppitt, H. T., *Puccinia digraphidis*, 78.
- Sorex, Germinal Layers in, 317.
- Sound-organs of Dytiscidæ, 589.
- Special Meeting, 837, 842.
- Species, Variations in Anatomical Structure of same, 487.
- Spectacles, History of Invention of, 269.
- Spectrum of Chlorophyll, 486.
- Spencer, W. B., Formation of Double Embryo in Hen's-egg, 21.
- , New Family of Hydroida, 482.
- , Nomenclature of Chicken Embryos, 318.

- Spermatogenesis in Locustidae, 36.
 Spermatophores as means of Hypodermic Impregnation, 719.
 Spermatozoa. Histology of, 325.
 —, Human. Various Forms of, 1.
 — of Coleoptera, 181.
 — of Insecta, Examining, 421.
 — of Mammalia. Minute Structure, 580.
 Sphaecelariaceæ, 225, 778.
 Spheruliths of Uric Acid Salts, Artificial Preparation of, 553.
 Sphaeropsidææ, New Genus of, 781.
Sphaerotheca Castagnei v. *humilis*, Mycelæ and Protospores of, 505.
 Sphagnaceæ, Microspores of, 73.
Sphenophyllum, 73, 500.
 Spiders. See Arachnida, Contents, xiii.
 Spinal Cord, Preparing and Staining Sections of, 549.
 —, Staining Medullary Sheath of Nerves of, 427.
 —, Structure of, in Human Embryos, 325.
 Spines, Influence of Light on Production of, 493.
 —, — of Moisture of Air on Production of, 214.
 Spiral Phyllotaxis, 493.
 Spirilla and Bacilli, Staining of Flagella of, 146.
Spirillum Obermeieri, Cultivating, in Leeches, 679.
Spirogyra, 630.
 —, Cell-division in, 58.
 —, Chlorophyll-bands in Zygote of, 378.
 —, Conjugation of, 226.
Spiroloculina asperula, 573.
Splachnum, Sporophyte of, 377.
 Sponges, Demonstrating Structure of Siliceous, 422.
 —. See Porifera, Contents, xix.
Spongicola, 204.
Spongilla fluviatilis, Development, 751.
 Spongy Cheese, 511.
 Sporangium of *Rhodocorton*, 628.
 Sporangia, Development of, in Saprolegniaceæ, 382.
 Spore-forming and Conjugation in Gregrines, 357.
 —-staining, New Method, 831.
 Spores in *Saccharomyces*, Germination of, 782.
 — of Fungi, Dispersion and Germination of, 504.
 — on Surface of Pileus of Polyporeæ, 384.
 Sporocysts, Free-swimming, 743.
 Sporophyte of *Splachnum*, 377.
 Sporozoa, New, 356.
 Spot Mirror Method of Illumination, 430.
 Springer, F., Perisomatic Plates of Crinoids, 352.
 Springs, Hot, Vegetation of, 232.
 Sputum, Bacteria in, 513.
 —, demonstrating Tubercle Bacilli in, 141.
 —, Effect of Koch Treatment on Tubercle Bacilli in, 511.
 —, Phthisical, Estimation of number of Tubercle Bacilli in, 833.
 Stage, new Hot, 521.
 —, Zeiss's form of Mayall's Mechanical, 433.
 Staining Ova of *Chironomus*, 539.
 —. See Contents, xxxix.
 Stainton, H. T., Larvæ of British Butterflies and Moths, 339.
 Stamens, Sensitive, 371.
 Staminate Cone of Scotch Pine, Sections of, 546.
 Staminodes of *Parnassia*, 213.
 Stand, Universal, 805.
 Stanley, A., Fermentations induced by *Pneumococcus* of Friedlaender, 773.
Staphylococcus pyog. aureus and *S. albus*, Colour and Pathogenic Differences of, 82.
 "Star" Microscope, Beck's Bacteriological, 806.
 Starch, Distribution, in Woody Plants, 485.
 — in Radish, 759.
 —, Influence of Salt on, in Vegetable Organs, 498, 625.
 —, Transformation of, into Dextrin by Butyric Ferment, 498.
 —-grains in Maize, Structure of, 486.
 —, —, Origin and Development of, 361, 362.
 Starfishes collected by 'Hirondelle,' 477.
Stauroneis phænicenteron, 441.
 Steam-Filter, 652.
 Stebbing, T. R. R., New British Amphipods, 594.
 —, *Urothoe* and *Urothoides*, 594.
 Stedman, J. M., Anatomy of *Distomum fabaceum*, 45.
 Steinbrinck, C., Anatomico-physical causes of Hygroscopic Movements, 771.
 —, Hygroscopic Swelling and Shrinking of Vegetable Membranes, 485.
 Steinhilber, J., *Cytophagus Tritonis*, 206.
 Stem, Increase in Thickness, 761.
 — of Cucurbitaceæ, Increase in Thickness of, 210.
 — of Cymodoceæ, 764.
 — of Equisetaceæ, 376.
 — of Ophioglossaceæ, 224.
 — of *Zostera*, 492.
 Stems of Phanerogams, Apical Tissue in, 210.
 Stentor, Regeneration of Peristome of, 751.
 — *caruleus*, 205.
 Stenzel, G., Variations in Flower of Snow-drop, 63.
 —, — in Structure of Acorn, 64.

- Sterilization of Organic Fluids by means of liquid carbonic acid, 682.
 — of Syringes, 832.
 Sterilized Fluids, Simple Apparatus for filtering, 273.
 Sterilizing Catgut, Simple Method for, 535.
 Stern, R., Action and Effect of Human Blood and other body-fluids on Pathogenic Micro-organisms, 86, 798.
 Starbuck, G. M., Coco-nut-water as Culture Fluid, 693.
 Stevens, T. S., Miniature Tank for Microscopical Purposes, 824.
 —, W. Le C., Microscope Magnification, 412.
 Stevenson, A. F., Method of injecting Fluids into peritoneal cavity of animals, 547.
 Stich, C., Respiration of Plants, 497.
Stictyosiphon, 778.
 Stigmas, Sensitive, 371.
 Stigmatic Disc of *Vinca*, 621.
 Stiles, C. W., Notes on Parasites, 742.
 Stinging Apparatus in *Formica*, 339.
 Stipules, Form and Function of, 622.
 Stockmayer, S., *Rhizoclonium*, 379.
 Stokes, A. C., Mounting Menstruum, 290.
 —, New Infusoria from Fresh Waters of United States, 697, 848.
 Stomates, 367.
 — in Calyx, 621.
 —, Rudimentary, in Aquatic Plants, 367.
 Strasser's (H.) Ribbon Microtome for Serial Sections, 281.
 Strasser, H., Treatment and Manipulation of Paraffin-embedded Sections, 285.
 Straus, J., Morphology of Bacterial Cell, 804.
 —, —, New Syringe for Hypodermic Injection, 690.
Streblotrichia Bornetii, New Marine Schizomycete, 81.
Strelitzia, Pollen of, 621.
 Streptococci, Osteomyelitis and, 243.
Streptotheca Tamesis, 785.
 Stridulating Organ of *Cystocelia immaculata*, 184.
 Striped Muscle, 716.
 Strobel, —, Preserving Fluid, 827.
Strombidinopsis similis, 699.
Strophanthine, 60.
 Student's Microscope, Baker's, 298, 516.
 —, Johnson's, 556, 648.
 —, Swift's Improved, 87.
 Studer, T., Fission in Alcyonaria, 354.
 —, New Alcyonarian, 750.
 Sturany, E., Coxal Glands of Arachnida, 591.
 Styles of Composite, 762.
 Stylet of *Heterodera Schachtii*, 598.
 Suberin and Bark-cells, 488.
 Sublimate, Method for fixing Preparations treated by, 536, 830.
 Substage Condenser, 256.
 —, New Cheap Centering, 257.
 Suchanek, H., Hints for fixing Series of Sections to the Slide, 428.
 —, Preparation of Venetian Turpentine, 429.
 Suchsland, E., Fermentation of Tobacco, 626.
 Suctoria, Mechanism of Sucking in, 55.
 Sugar-cane, Fungus Parasites of, 781.
 —, —, Germination of, 218, 495.
 Sulphur in Plants, 616.
 Sundew, Heliotropic, 772.
 Suppuration-Cocci, Demonstrating, in Blood as aid to Diagnosis, 686.
 Swift, J., Dick's Petrological Microscope, 155.
 — Student's Microscope, 87.
 Swine Diseases, Bacteria in, 641.
 Syllidinae, Development and Morphology of Parapodia in, 595.
 Symbiosis of Algæ and Animals, 224, 385.
 — of *Echinococcus* and *Coccidia*, 475.
 — of *Rhizobium* and Leguminosæ, 639.
 Synaptidæ, Anatomy of, 352.
 Synchytrium-galls of *Anemone nemorosa*, Pigment of, 60.
Synute pulchella, 611.
 Syringe for Hypodermic Injection, 690.
 Syringes and their Sterilization, 832.
 Szczawinska, W., Eyes of Crustacea, 591.
- T.
- Tactile Papillæ of *Hirudo medicinalis*, Demonstrating, 540.
Tania coronula, 745.
 —, Cysticercus of, 296.
 — *Echinococcus*, Generative Apparatus of, 46.
 — *lancoolata*, Development of, from Duck, 438.
 — *longicollis*, Structure and Development of, 743.
 — *saginata*, Anomaly of Genital Organs of, 351.
 —, Cysticercus of, in Cow, 745.
 Tænias of Birds and others, 47, 744.
 Tail, Regeneration of, in *Lumbricus*, 470.
 Talmage, J. E., 557.
 Talfani, E., Fruit and Seed of Umbelliferae, 763.
 Tank for Microscopical Purposes, 824.
 Tannin in Composite, 209.
 —, Microchemical Reactions, 833.
 Tannins, 498.
 Tannoids, 759.
Taphrina, Pathogenic Species of, 383.
 Tartuferi, F., Metallic Impregnation of the Cornea, 286.

- Tarulli, L., Pressure within Egg of Fowl, 21.
- Tasmanian Mollusca, 722.
- "Tannucl-getreide," 505.
- Tavel, —, Syringes and their Sterilization, 832.
- Taylor, T., New Flash-light for Photography, 263.
- Teleostean Embryology, 318.
- Telescopes. History of Invention of, 269.
- Temnocephala chilensis*, Ova and Embryos of, 44.
- Temperature, D'Arsonval's apparatus for maintaining fixed, 682.
- , Influence on Germinating Barley, 769.
- on Karyokinesis, 758
- Tempère, J., *Brunia*, fossil Diatom, 386.
- , Diatoms of France, 785.
- Tendons of Vertebrata, Nerve-end Plates in, 427.
- Tendrils of Passifloraceæ, 213.
- Terrestrial Alge, Culture of, 829.
- Test-gland of Freshwater Copepoda, 38.
- Testa, Nutrient Layer in, 61.
- Testacella*, Anatomy of, 582.
- , Hepatic Epithelium of, 330.
- Testicle, Preparing and Staining, 427.
- Testis of *Gebia major*, Formation of Eggs in, 344.
- Tests for Glucosides and Alkaloids, 148.
- Tetanus, Attenuation of Bacillus of, 799.
- , Cure for, 237.
- , Immunization against the Virus of, 796.
- Thamnidium mucoroides*, 382.
- Thaxter, R., New Genera of Hyphomycetes, 784.
- *Sigmoideomyces*, new Genus of Hyphomycetes, 506.
- Thélohan, P., New Sporozoa, 356.
- , Structure and Development of Spores of Myxosporidia, 55.
- Theory of Immunity, Present Position, 390
- Thermoregulator, Altmann's, 651.
- for large Drying-stoves and Incubators, 652.
- Thermoregulators, Metallic, 651.
- Thermostat, Pfeiffer's Water, 524.
- Thiele, J., Phylogenetic Affinities of Mollusca, 721.
- Thiselton-Dyer, W. T., *Pachytheca*, 779.
- Thomas, F., A new *Cecidomyia*, 35.
- , M. B., Collodion Method in Botany, 423.
- , Dehydrating Apparatus, 535.
- Thompson, J. C., *Monstrilla* and the Cymbasomatidae, 189.
- , P. G., *Dasydytes bisetosum*, 602.
- , S. P., Measurement of Lenses, 818.
- , New Polarizer, 810.
- Thorpe, V. G., Colouring Power of Noctiluca, 839.
- Thorpe, V. G., Queensland Rotifera, 200.
- , New and Foreign Rotifera, 301-431.
- Thouvenin, M., Anatomy of Saxifragaceæ, 365.
- , Latex-receptacles, 618.
- Thysanura of Bohemia, 341.
- Tieghem, P. v., Extra-phloem Sieve-tubes and Extra-xylem Vessels, 618.
- , Folded Tissues, 617.
- , Pericycle and Periderm, 363.
- , Stem of Equisetaceæ, 376.
- , — of Ophioglossaceæ, 224.
- Tils, J., Bacteriological Examination of the Water of Freiburg, 245.
- Tinoleucites, "Attractive Spheres" in Vegetable Cells, 614.
- Tirelli, V., Staining Osseous Tissue by Golgi's Method, 426.
- Tischutkin, N., Simplified method for preparing Meat Pepton-Agar, 416.
- Tissier, P., Milk an Agent for Transport of certain Infectious Diseases, 804.
- , Resistance of Organism against Infection - Phagocytosis, 515.
- Tizard Banks, Corals of, 51.
- Tizzoni, G., Attenuation of Bacillus of Tetanus, 799.
- , Immunization against Virus of Tetanus, 796.
- Tmesipteris*, 499.
- Toad-fish, Yolk-sac of Young, 170.
- Tobacco, Fermentation of, 626.
- Tongues of British Hymenoptera Anthophila, 34.
- Topsent, —, New Leaping Acari, 185.
- Tornaria*, Anatomy and Transformation of, 475.
- Torpedo*, Staining Motor Nerve-cells of, 287.
- Torres Straits, Haddon's Collections in, 581.
- Trabut, L., Parasite of *Acridium peregrinum*, 636.
- Tracheæ, Staining Terminations of, in Insect Wing Muscles by Golgi's Method, 288.
- Tracheids, Elliptically wound, 365.
- Tragopogon*, Order of Appearance of Vessels in Flowers of, 364.
- Transpiration and Assimilation, 770.
- current, 625.
- Trapa*, Embryo of, 763.
- Trapeznikoff, —, Fate of Spores of Microbes in Animal Organism, 804.
- Treadwell, A. L., Anatomy and Histology of *Serpula dianthus*, 733.
- Treasurer's Account, 1890, 158.
- Trécul, A., Order of Appearance of Vessels in flowers of *Tragopogon* and *Scorzonera*, 364.
- Trees, Calcium Oxalate in Bark of, 616.
- , Forest, Fungi parasitic on, 229.

- Trees, Insects injurious to Forest and Shade, 461.
 —, Mucilaginous Slime on, 784.
 Trehalose in Fungi, 228.
 Trematodes, Monog-netic, Connecting Canal between Oviduct and Intestine in, 350.
 Trembley's Experiments with *Hydra*, 483.
 Trenkman, —, Staining and Coloration of Flagella of Spirilla and Bacilli, 146, 515.
Trentepohlia, 226.
 —, Pleiocarpous Species of, 503.
 Trichomes of *Corokia budleoides*, 66.
Trichotaxis stagnatilis g. & sp. n., 701.
Trigaster, 40.
 Trioxybenzols, 498.
 Tristomida, Genital Organs of, 474.
Tristomum histiophori, 475.
Triton helveticus, Fixing and Staining Glands of, 287.
 —, Investigation of Brain and Olfactory Organ, 827.
Trochosphaera aequatorialis, 301.
 Trochozoa, 327.
 Trouessart, E. L., Mounting Acarina, 421.
 —, New Genus of Leaping Acari, 185.
 Trough, Fish-, 835.
Trypanosoma Balbianii, 753.
 Tschireh's, A., Text-book of Vegetable Anatomy, 207.
 Tube-length, Uniformity of, 87.
 Tuberculariæ, New Genus of, 506.
 Tubercle Bacilli, Colourability of, 690.
 — — —, Demonstrating, in Sputum, 141.
 — — —, Effect of Koch Treatment on, in Sputum, 511.
 — — —, Estimation of Number in Phthisical Sputum, 833.
 — — —, Gabbet's Stain for, 832.
 — — —, New Method for Staining and Mounting, 146.
 — — —-Bacillus, Conditions that modify Virulence of, 237.
 Tubercles during Germination, Temperature of, 218.
 — of Leguminosæ, Microbe of, 640.
 — on Roots of *Ceanothus*, 766.
 Tuberculin, Preparing, 534.
 Tuberculosis, Pseudo-, of Rodents, 390.
 Tubers and Tuberos Roots, Internal Atmosphere of, 371.
 — in Juncaceæ, 493.
 Tubeuf, K. v., Formation of Duramen, 211.
 —, *Gymnosporangium*, 506.
 Tudor Specimen of *Eozoon*, 613.
 Tumours in Animals, 242.
 — injected during life with Anilin Pigments, Preparation of, 548.
 Tunicata. See Contents, xi.
Tuomeya fluviatilis, 378.
 Turbellaria of Coasts of France, 198.
 —, Organization of Acoelous, 599.
 —, Rhabdocæle, 196.
 Turina, V. A., Researches on Germs of Air and Dust of Inhabited Regions, 245.
 Turpentine for Microscopical Use, 147.
 —, Venetian, Mounting Botanical Preparations in, 551.
 —, —, Preparation of, 429.
 Typhoid Fever, Action of Light on Bacillus, 802.
- U.
- Umbelliferæ, Assimilation in, 770.
 —, Fruit and Seed of, 763.
 —, Proterandry in, 495.
 —, Structure of Swollen Roots in, 623.
Urio, 455.
 United States, Fresh-water Infusorians, 697, 848.
 Universal Stand, 805.
 Unna, P. G., Steam Filter, 652.
 Upson's Gold-staining Method for Axis-cylinders and Nerve-cells, 425.
 Urech, E., Ontogeny of Insects, 180.
 Uredineæ and their Hosts, 231.
 — Himalayan, 231, 635.
 —, New, 635.
 —, Researches on, 783.
 —, Structure of, 634.
Uredo notabilis, 78.
 — *Violæ*, 231.
 Uric Acid Salts, Artificial Preparation of Spheruliths of, 553.
 Urine, Antiseptic Action of Fluoride of Methylen on Pyogenic Bacteria of, 391.
 Urinogenital Apparatus of Crocodiles and Amphibia, 23.
Urocystis Violæ, 506.
Uromyces Cunninghamianus, sp. n., 783.
Urosalpinz, Embryology of, 454.
Urostyla elongata, 700.
 — *fulva*, 700.
Urothoe, 594.
Urothoides, 594.
 Ustilagineæ, New, 77.
Ustilago antherarum, 506.
Utricularia, Morphology of, 67.
 Uzel, J., Thysanura of Bohemia, 341.
- V.
- Vaccination, Anthrax, 797.
 Vacuoles, Formation of, 58, 359.
 Vaizey, J. R., Sporophyte of *Splachnum*, 377.
 Valente, G., Demonstrating Cerebral Vessels of Mammalia, 547.
 Vallentin, R., Anatomy of Rotifers, 601.
Vallisia, 199.
Valonia, Cell-sap of, 631.

- Valude, —, Antiseptic Value of Anilin Pigments, 798.
- Van der Stricht, O., Development of Blood in Embryonic Liver, 578.
- — —, Examination of Embryonic Liver, 683.
- — —, Heurck's Microscope, 399, 434, 558.
- Vanni, G., Measurement of Focal Length of Lenses or Convergent Systems, 665.
- Variations in Flower, 490.
- — —, Nature and Origin of, 717.
- Varnishes, 692.
- Vasale's, G., Modification of Weigert's Method, 424.
- Vascular Bundles, Equivalence of, in Vascular Plants, 760.
- — —, Function of Sieve-portion, 211.
- — — of *Isotiles*, 222.
- — — System in Annelids, 348.
- — — of Floral Organs, 363.
- Vaucheria, Oogone and Oosphere of, 379.
- Vaughan, V. G., Examination of Drinking Water with reference to Typhoid Fever, 804.
- — —, New Bacterial Poisons, 804.
- — —, New Poison in Cheese, 515.
- Vegetable Cells (*Tinoleucites*), "Attractive Spheres" in, 614.
- — — *Hæmatin*, *Aspergillin*, 486.
- — — Membranes, Hygroscopic Swelling and Shrinking of, 485.
- — — Physiology, Hansen's, 623.
- — — Tissues, Use of Polarized Light in Observing, 429.
- Vegetation, Aquatic, in the dark, 385.
- — — of Hot Springs, 232.
- Vejdovsky, F., Development of Vascular System in Annelids, 348.
- — —, Phenomena of Fertilization, 713.
- Velenovsky, J., Rhizome of Ferns, 500.
- Venetian Turpentine, Mounting Botanical Preparations in, 551.
- — —, Preparation of, 429.
- Vera Cruz, Echinodermata of, 50.
- Verhoogen, R., Action of Constant Current on Pathogenic Micro-organisms, 799.
- Vermes. See Contents, xv.
- Vertebrata, Nerve-end Plates in Tendons of, 427.
- — —, Origin of, 576.
- Verworn, M., Life of *Diflugia*, 205.
- — — Psycho-physiological Studies on Protoists, 54.
- Vessels, Order of Appearance of, in flowers of *Tragopogon* and *Scorzonera*, 364.
- — —, Sieve-septum of, 364.
- Viala, P., Basidiomycete parasitic on Grapes, 637.
- — —, New Vine-disease, 505.
- Viallanes, H., Compound Eye of *Maerura*, 468.
- — —, Structure of Nerve-centres of *Limulus*, 36.
- Viburnum*, Leaves of, 622.
- Vicia Faba*, Infection of, by *Bacillus radi-cicola*, 387.
- — — *sepium*, Abnormal Leaves of, 214.
- Victoria, New *Peripatus* from, 36.
- Victorian Land Planarian, 474.
- — — Sponges, 610.
- Ville, G., Sensitiveness of Plants to certain Salts, 219.
- Villiers, A., Transformation of Starch into Dextrin by Butyric Ferment, 498.
- Vinassa, C., Characteristics of some Anilin Dyes, 551.
- Vinea*, Stigmatic Disc of, 621.
- Vincent, H., Bacillus of Typhus in Water of Seine, in July 1890, 392.
- — —, Bodies resembling Psorosperms in Squamous Epithelioma, 754.
- Vincentini, F., *Diplococcus* resembling *Gonococcus*, 643.
- Vine, Cuttings of, 62.
- — — -disease, New, 565.
- — —, Pearl-like Glands of, 622.
- Vines, S. H., Diastatic Ferment in Green Leaves, 774.
- Visart, O., Preparing Epithelium of Mid-gut of Arthropods, 828.
- Vision of Pulmonate Gastropods, 177.
- Vöchting, H., Assimilation of Leaves, 496.
- Voeltzkow, A., Eggs and Embryos of Crocodile, 577.
- — —, *Entovalva mirabilis*, 332.
- Voigt, A., Localization of Essential Oil in Tissue of Onion, 209.
- Volvox*, 226.
- — — *globator*, 301.
- Vorce, C. M., Graphological Microscope, 402.
- Vossler, J., Cement and Wax Supports, 429.
- — —, Deterioration of Mayer's Albumen-Glycerin Fixative, 428.
- — —, Odoriferous Glands of Earwigs, 184.
- Vries, H. de, Abnormal Formation of Secondary Tissues, 364.
- — —, Aquatic Vegetation in the Dark, 385.
- — —, Duration of Life of Seeds, 495.
- Vuillemin, P., Leaves of *Lotus*, 368.
- — —, Mycorrhiza, 779.
- — —, Secretory System of Papilionaceæ, 617.

W.

- Waage, T., Occurrence and Function of Phloroglucin, 209.
- — —, Roots without a Root-cap, 765.
- Wachsmuth, C., Perisomatic Plates of Crinoids, 352.
- Wagner, F. v., Asexual Reproduction of *Microstoma*, 198, 275.

- Wagner, Papillæ of *Microstoma*, 742.
 —, J., Organization of *Monobrachium parasiticum*, 52.
 Wainio, E., Clas-sification of Lichens, 230.
 Walmsley, W. H., "Handy" Photomicrographic Camera, 257.
 Warburton, C., Oviposition and Cocoon-weaving of *Agelena labyrinthica*, 731.
 Ward, H. B., Anatomy and Histology of *Sipunculus nudus*, 598.
 —, Investigating *Sipunculus nudus*, 684.
 —, Narcotizing Hydroids, &c., 685.
 —, H. M., Relations between Host and Parasite, 69.
 Warming, E., Fertilization of Caryophyllaceæ, 68.
 Wasmann, E., Can Ants hear? 182.
 —, Function of Antennæ in *Myrmedonia*, 181.
 —, Parthenogenesis of Ants induced by heightened temperature, 182.
 Water, Action on Sensitive Movements, 71.
 —, Bacteria and their examination, 85.
 —, —, in, 241.
 —, —, of Chemnitz Potable, 241.
 —, Conduction of, 219.
 —, -mites, Copulation of, 731.
 —, of Kiel, Variability of Red Bacillus of, 510.
 —, Potable, Biological Examination, 148.
 —, River, Red Bacillus from, 81.
 —, Thermostat, Pfeiffer's, 524.
 Waters, A. W., Characters of Melicertitidæ and other Fossil Bryozoa, 586.
 —, B. H., Primitive Segmentation of Vertebrate Brain, 449.
 Watkins, R. L., Electro-Microscope Slide for Testing the Antiseptic Power of Electricity, 810.
 Watson, A. T., Protective Device of an Annelid, 739.
 Watson, T. P., 434, 561.
 Wax Supports, Vosseler's, 429.
 Webber, H. J., Antherids of *Lomentaria*, 628.
 Weber, —, *Phytophysa*, 76.
 —, Symbiosis of Algæ and Animals, 224.
 Webster, J. C., Improved Method of preparing large Sections of Tissues, 514.
 Weel, W. H., Vegetation of Hot Springs, 232.
 Wehmer, C., Formation and Decomposition of Oxalic Acid: its Function in Metabolism of Fungi, 772.
 Weigert's Method for Staining, Vasale's Modification of, 424.
 Weinland, E., Halteres of Diptera, 35.
 Weismann, A., *Hydra* turned inside out, 203.
 —, Theory of Heredity, 766.
 Weiss, A., Stomates, 367.
 —, Trichomes of *Corokia budleoides*, 66.
 Weisse, A., Leaf-spirals in Conifera, 493.
 Weldon, W. F. R., *Palæmonetes varians*, 37.
 —, Renal Organs of Decapod Crustacea, 467.
 Wenckebach, K. F., Gastrulation in *Lacerta agilis*, 449.
 West, the late Tuffen, 529.
 —, W., Conjugation of Zygnemaceæ, 502.
 Westermaier, M., Function of Antipodals, 766.
 Western, G., Notes on Rotifers, 201.
 Wettstein, R., Staminodes of *Parnassia*, 213.
 Wevre, A. de, Biology of *Phycomyces nitens*, 780.
 —, *Chaetostylum*, 504.
 Wheat, Insect-larva eating Rust on, 461.
 Wheeler, A., Our Unseen Foes: plain words on Germs in relation to Disease, 804.
 White, T. C., New Method of Infiltrating Osseous and Dental Tissnes, 307.
 Whitman, C. O., *Clepsine plana*, 740.
 —, Spermaphores as Means of Hypodermic Impregnation, 719.
 Wiedersheim, R., Development of *Salamandra atra*, 318.
 —, Development of Urino-genital Apparatus of Crocodiles and Chelonians, 23.
 —, Movements in Brain of *Leptodora*, 188.
 Wierzejski, A., Galician Rotifers, 351.
 Wiesner, J., Anatomy and Organography, 485.
 —, Changes in form of Plants produced by Moisture and Etiolation, 620.
 —, Elementary Structures and Growth of the Vegetable Cell, 207.
 Wildeman, E. de, "Attractive-spheres" in Vegetable Cells, 614.
 —, *Cladophora*, 778.
 —, Clamp-organs of the Conjugatæ, 502.
 —, *Enteromorpha*, 226.
 —, Influence of Temperature on Caryokinesis, 758.
 —, *Prasiola* and *Schizogonium*, 75.
 —, Saprolegniaceæ parasitic on Algæ, 228.
 —, *Trentepohlia*, 226.
 Wilder, H. M., Polarization without a Polarizer, 405.
 Willem, V., Eyes of Pulmonata Basomatophora, 455.
 —, Ocelli of *Lithobius*, 590.
 —, Vision of Pulmonate Gastropods, 177.
 Willey, A., Later Larval Development of *Amphioxus*, 319.
 —, H., *Arthonia*, 505.
 Willia—New Genus of Mosses, 776.
 Wilson, E. B., Heliotropism of *Hydra*, 750.

- Wilson, Origin of Mesoblast-bands in Annelids, 190.
 —, J., Mucilage and other Glands of Plumbaginæ, 62.
 —, J. H., Pollination and Hybridizing of *Alluca*, 769.
 Wine-Ferments, Preparing, 230.
 Wing-muscles of Insects, Minute Structure of Muscle-columns, 587.
 —, —, Preparation of, 683.
 —, —, Staining by Golgi's method, Tracheæ and Nerves in, 208.
 Wingate, H., *Oreadella*, a new Genus of Myxomycetes, 384.
 Wings, Absence of, in Females of many Lepidoptera, 462.
 — of Butterflies, Development of Nervures of, 338.
 Winkler, F., Bacillus developing a Green Pigment, 238.
 —, New Criterion for distinguishing between *Bacillus Cholerae Asiaticæ* and the Finkler-Prior Bacillus, 142.
 —, Pure Cultivations of *Gonococcus*, 132.
 Winogradsky, S., Organisms of Nitrification and their Cultivation, 83, 392, 680.
 Wladimiroff, A., Biological Studies on Bacteria, 647.
 —, Osmotic Experiments on living Bacteria, 804.
 Wojnowic, W. P., *Selaginella lepidophylla*, 222.
 Wolters, M., Conjugation and Spore-forming in Gregarines, 257.
 —, Methods for Staining Medullary Sheath and Axis-cylinder of Nerves with Hamatoxylin, 425.
 Wood of Conifers, 487.
 —, Permeability of, to Air, 71.
 Woodhead, G. S., Bacteria and their Products, 514.
 Woods, C. D., Absorption of Atmospheric Nitrogen by Plants, 496.
 Woodworth, W. M., Mode of Studying *Phagocata*, 541.
 —, Structure of *Phagocata gracilis*, 473.
 Workman, C., Bacteriology: a general review, 647.
 Worm, Flat, Parasitic in Golden Frog, 475.
 Woronin, M., "Täumel-getreide," 505.
 Wort, Bacteria in, 244.
 Wortmann, J., Presence of a Diastatic Enzyme in Plants, 221.
 Wright, J., Foraminifera collected off South-west of Ireland, 206.
 Wülfling, E. A., Apparatus for rapid change from parallel to convergent polarized light in Microscope, 105.
 Wysokowicz. —, Influence of Ozone on Growth of Bacteria, 388.
 Wzescniowski, A., Three Subterranean Gammaridæ, 37.
 X.
 Xerophilous Liliifloræ, Leaves of, 765.
 Xylem, Extra-, Vessels, 618.
 —, of *Belladonna*, Sieve-fascicles in Secondary, 618.
 Y.
 Yeast, Respiration and Fermentation of, 374.
 Yolk-sac of Young Toad-fish, 170.
 Yucatan, Echinodermata of, 50.
 Z.
 Zabriskie, J. L., New *Pestalozzia*, 781.
 Zacharias, E., Growth of Cell-wall in *Chara foetida*, 501.
 Zahlbruckner, A., Dependence of Lichens on their Substratum, 634.
 Zeidler, A., Bacteria found in Wort and Beer, 244, 515, 801.
 Zeiss-, Carl, Stiftung in Jena, 528.
 Zeiss's Crystallographic and Petrographical Microscopes, 516.
 —, Form of Mayall's Mechanical Stage, 433.
 — Objective, 1/10 of 1·6 N.A., 555.
 Zeller, E., Fertilization of Newts, 576.
 Zimmermann, A., Cystoliths of *Ficus*, 619.
 —, Protein-crystalloids in Cell-nucleus of Flowering Plants, 362.
 —, O. E. R., Bacteria of Chemnitz Potable Water, 241.
 Zoantharia from Port Phillip, 51.
 Zoja, L. & R., Bioplasts or Plastidules, 717.
 Zona pellucida, Formation of, 22.
 Zouaria, Structure of, 378.
 Zoochlorellæ, 232, 756.
 Zoological Paradoxes, 453.
 Zoospores, Demonstration of Cilia of, 541.
 Zooluminum, New Pelagic, 356.
 Zopf, W., Alkaloid-receptacles of Fumariacæ, 618.
 —, Colouring-matter of certain Schizomycetes, 640.
Zostera, Stem of, 492.
 Zukal, H., *Diplocolon* and *Nostoc*, 233.
 —, Gymnoascacæ and *Ascomycetes*, 228.
 —, Semi-Lichens, 382.
 —, *Thamnidium mucroides*, 382.
 Zülzer, W., Alkaloid of Tubercle-bacilli, 515.
 Zygnemacæ, Conjugation of, 502.
 Zygote of *Spirogyra*, Chlorophyll-bands in the, 378.

No. 1.



No. 2.

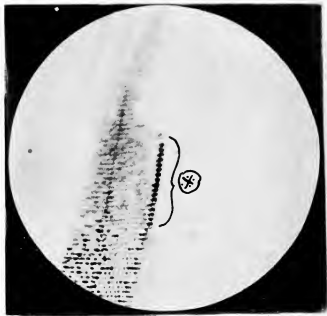

No. 3.

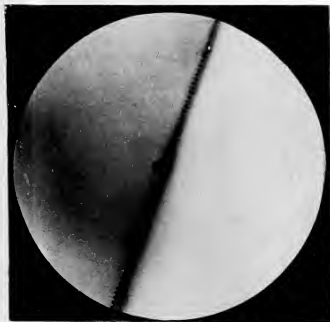

No. 4.

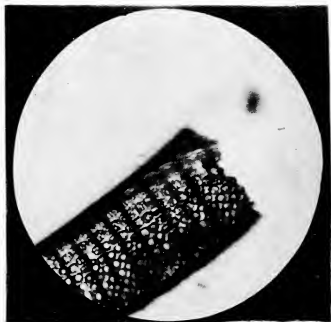

C. H. GILL Photo.

J. MAES Phototyp.

Broken Edges of charged Diatoms, showing pores extending from face to face of shell.

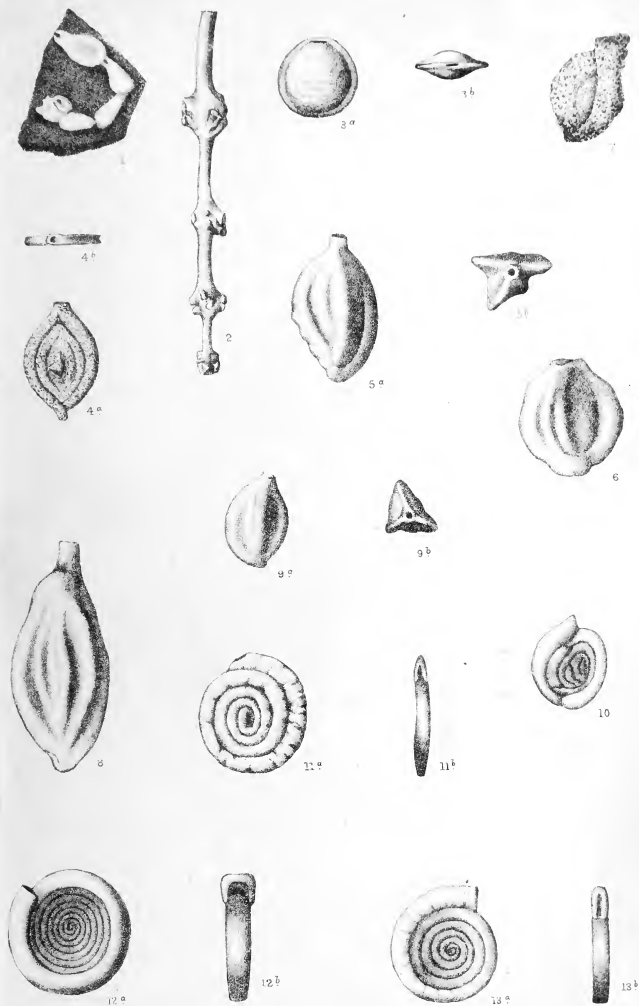

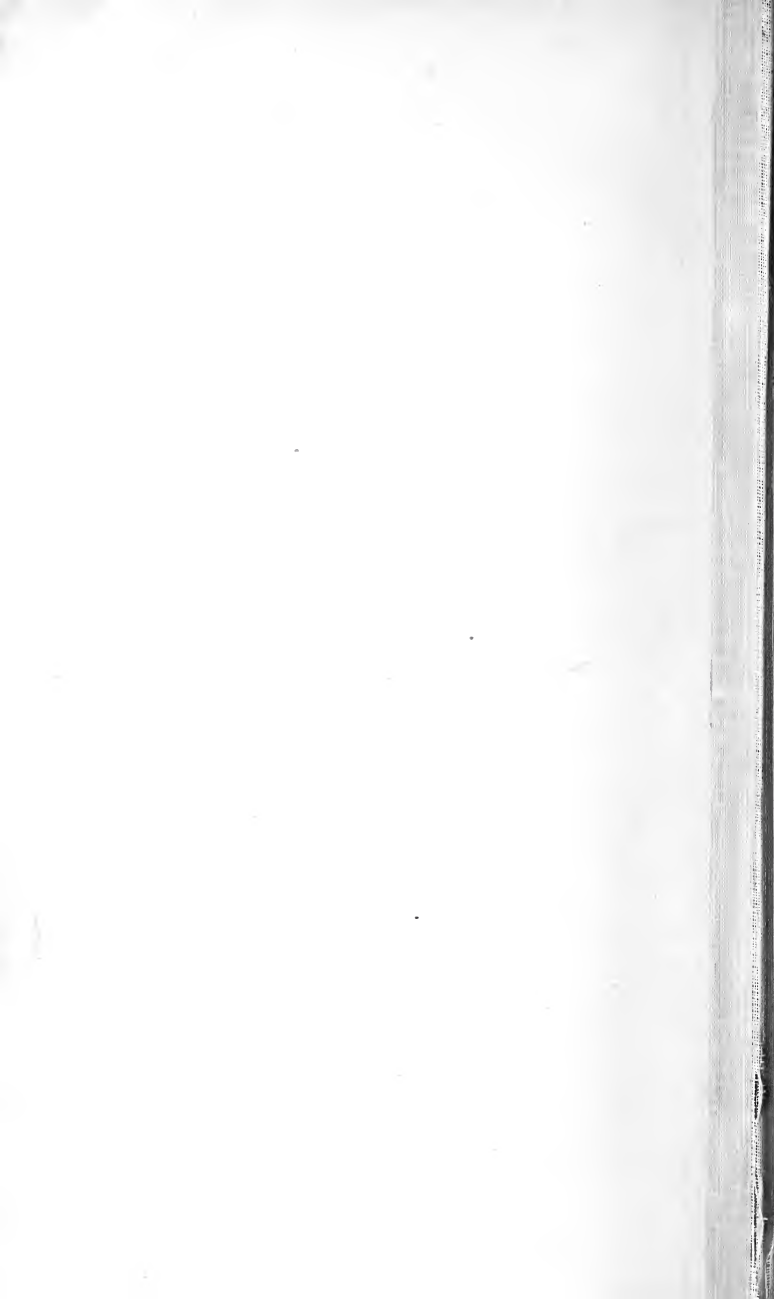

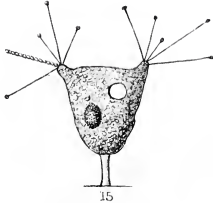
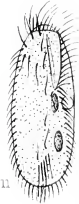
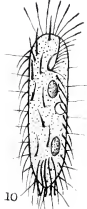
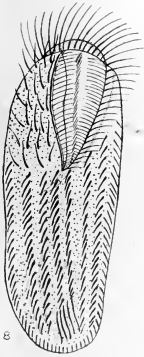
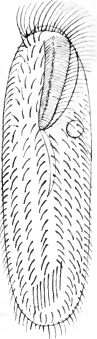
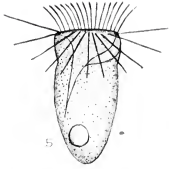
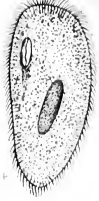
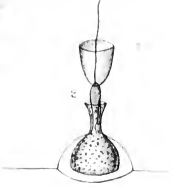

Auct. del.

West, New York, 1891.



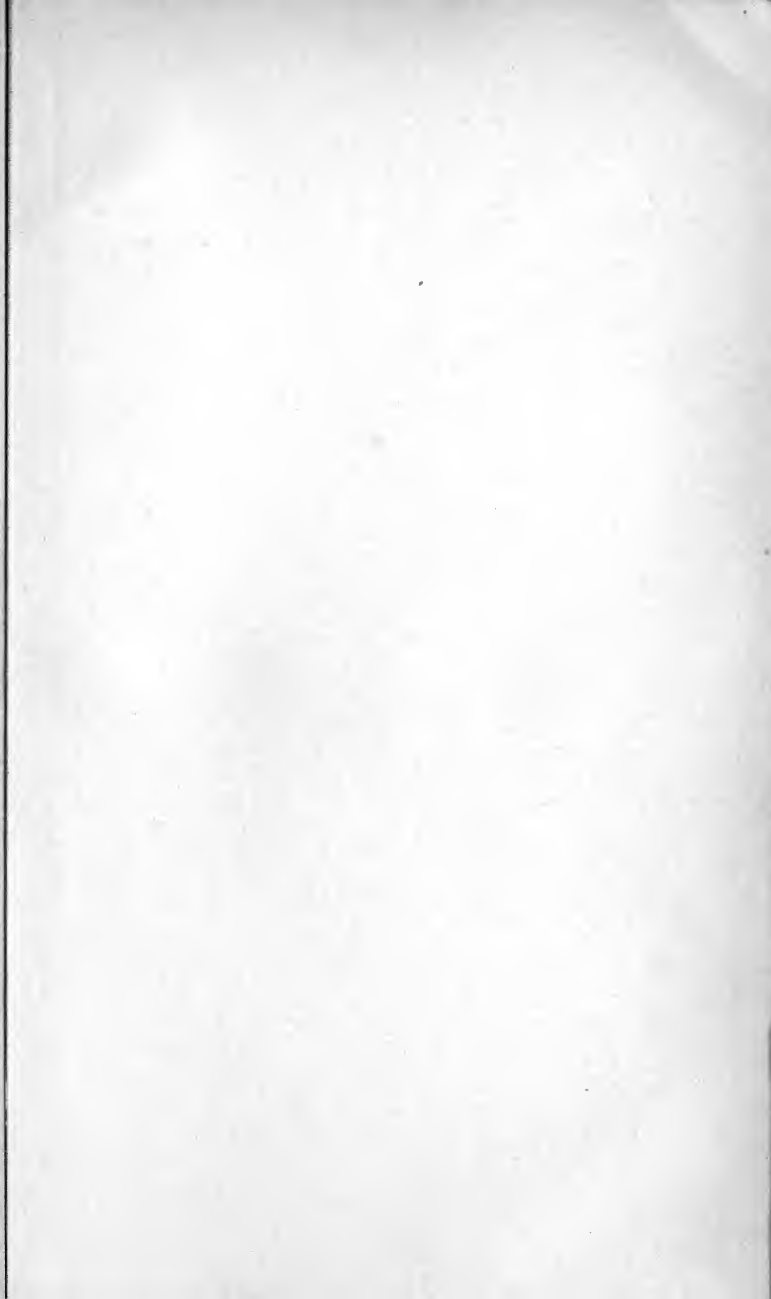



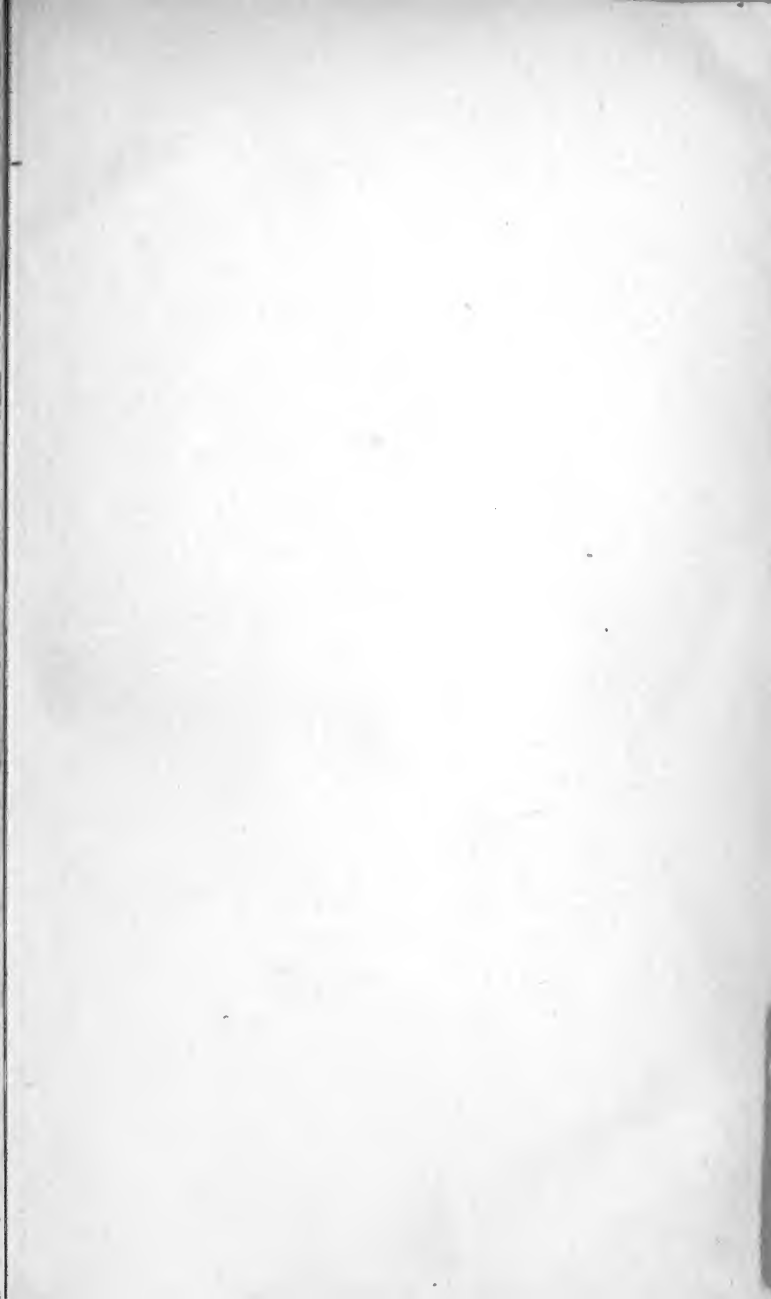

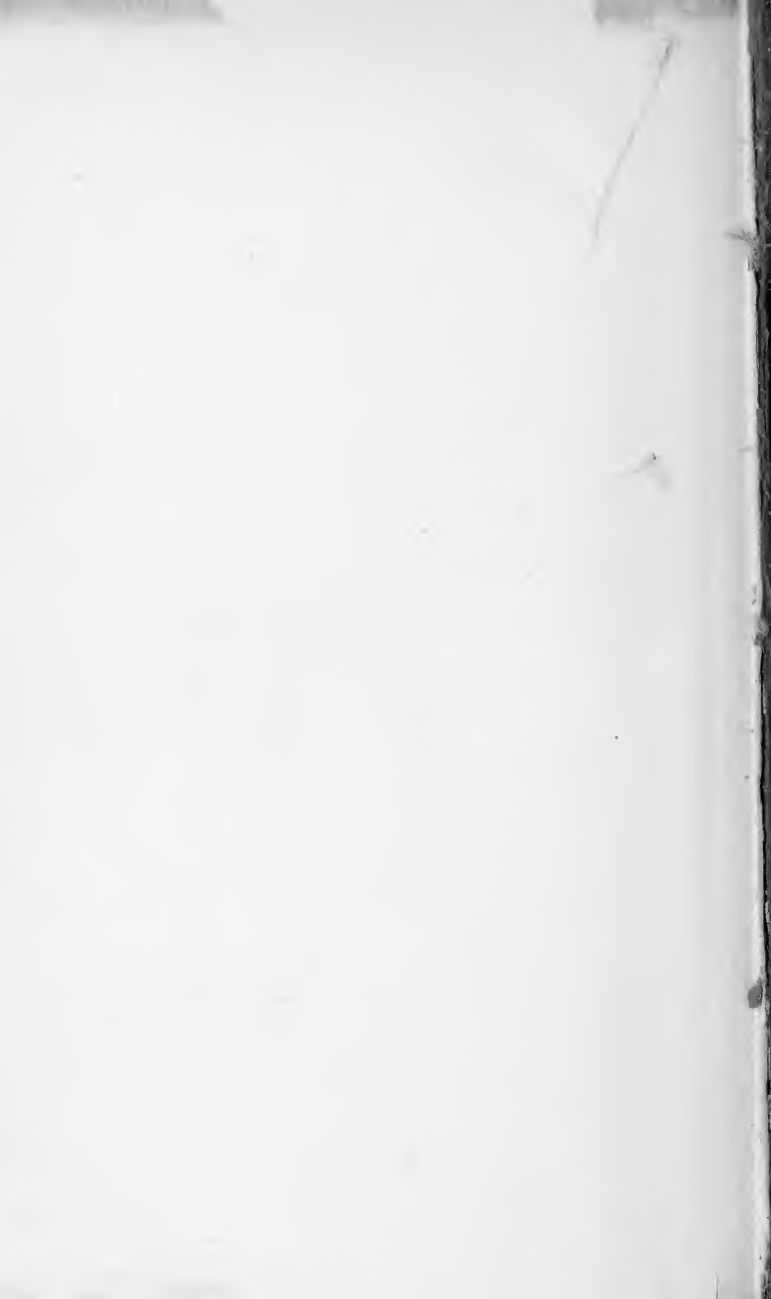



3 2044 106 278 914

